

N**Monteringsanvisning****EN****Assembly Instructions****S****Monteringsanvisning**

Produkt nr. / Product no. / Produkt nr.

11-290-000

Ordr. nr. _____

Dato. _____

Sign. _____

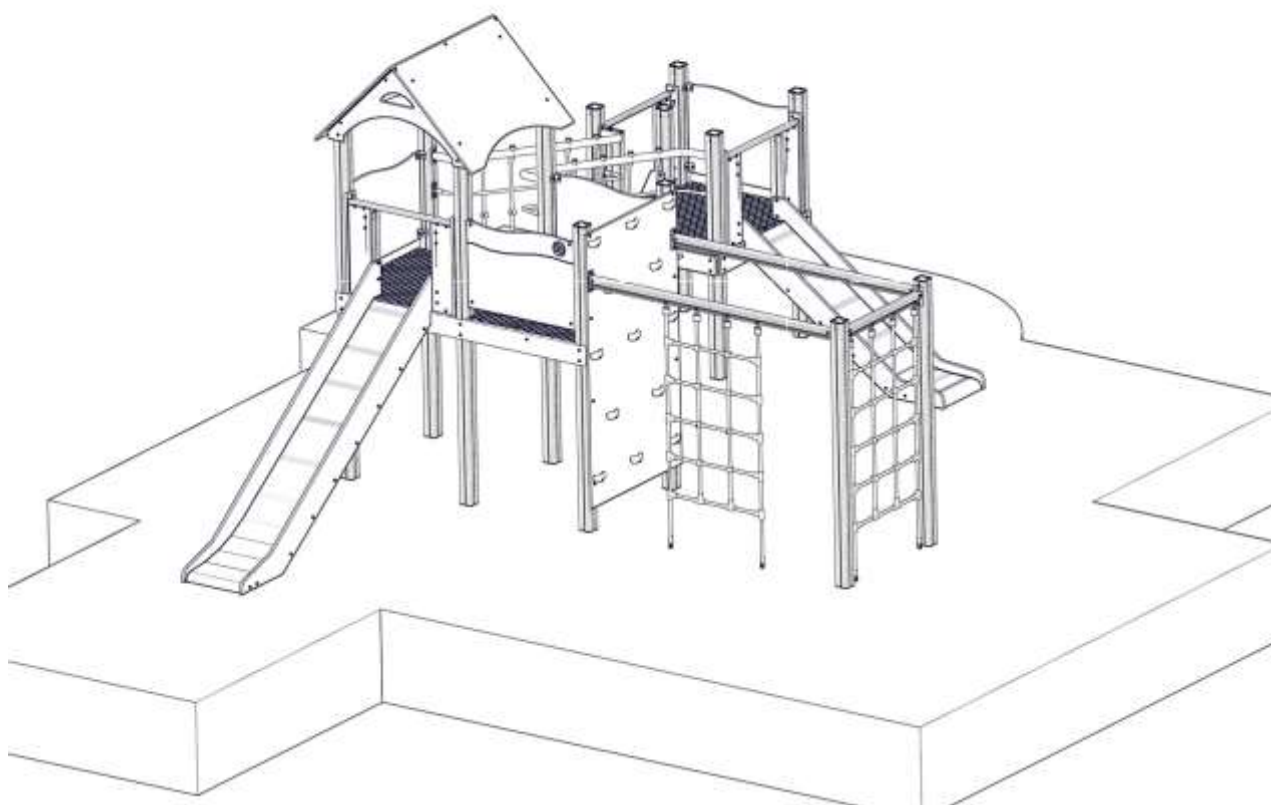

Søve AS
Grønnvoldveien 290
3830 Ulefoss - Norway
Tlf: +47 35 94 65 65
www.sove.no



Søve AB
EA Rosengrensgatan 32
421 31 Västra Frölunda
Phone: +46 (0)31 773 97 00
www.sove.se

Monteringstips / Assembly Advice / Monteringsstips**N**

- Les monteringsanvisningen nøye før montering.
- Monter elementene i rekkefølgen som vist.
- Boltene bør ikke skrues for hardt til før alt er montert, vatret og loddet. Skru så boltene til.
- NB! Ved bruk av drill, kan boltene ryke.
- På grunn av at solen kan gjøre rutsjeplaten veldig varm, bør rutsjebanens utløp vende mot nord-øst eller nord-vest.
- Er lekeutstyret plassert i naturlige ferdselstraséer må området sikres mot gjennomgang.
- Innspringningshinder bør vurderes rundt lekeapparater hvor det er stor bevegelse, f.eks. ved huskestativ.
- Det bør være fritt innsyn til lekeutstyr som er beregnet for barn under 3 år.

NB! Under monteringsarbeidet må utstyr, som ikke er forankret forsvarlig i bakken, sikres slik at det ikke velte.

Området må avstenges under montering av apparatene med sperrebånd eller lignende.

EN

- Read the instruction carefully before assembling the play unit.
- Assemble the components in the sequence shown in these instructions. Fixings must not be fully tightened during assembly. Before casting the foundations, the structure must be level and plumb, at which point all fixings are tightened. PSI If use of drill, the bolts may be wrecked.
- Avoid positioning the slide facing due south because of overheating – ideal positions are facing north-east or north-west. Secure the construction-area to prevent people from walking through it.
- Consider installing barriers around play-equipment which gives rise to a lot of activity – i.e. swings.
- Ensure that clear vision is possible across the play area so that supervision is possible from any position, particularly where children under 3 years of age will be playing.

NB! During assembly of the equipment, ensure that all structures are securely propped, especially when left overnight. Also ensure that equipment is supported

Monteringstips / Assembly Advice / Monteringsstips

S

- Läs monteringsanvisningen noga före montering.

- Montera delarna i den ordningen som anvisas
- Skruvarna bör inte skruvas för hårt tills allt är monterat, i våg och lodat.











OBS! Används elektrisk skruvdragare, kan bulten gå sönder. Hårdra därför manuellt!

- Solen kan göra att rutchbanan blir väldigt varm. Banans nedfart rekommenderas att vändas i norrlig riktning
- Om lekplatsen placeras vid en gångväg mm bör området säkras mot genomfart av gående och cyklister.
- Insprängningshinder bör placeras runt lekutrustning med stor rörelse, t ex, gungställning.
- Det bör vara fri insyn till lekutrustning beräknat till barn under 3 år.

OBS! Under monteringsarbete bör utrustningen som inte ska förankras i marken, ställs så att den inte kan välta.

Området måste spärras när lekutrustningen byggs upp, med avspärrningsband eller liknande.

Nødvendig verktøy / Tools required / Nödvändiga verktyg

<p>(N)</p> <p>(EN)</p> <p>(S)</p>	<p>(A)</p> 	<p>(B)</p>  <p>Torx Nr 45 High quality</p>	<p>(C)</p> <p>5 mm 6 mm</p> 	<p>(D)</p> 	<p>(E)</p> 
		<p>Metermål Metric measure Tumstoc</p> 	<p>16 V</p> 	<p>Merkebånd Mark ribbon Märkeband</p> 	<p>13 + 17mm</p> 

Nødvendig antall personer / Number of persons required / Lämpligt antal personer





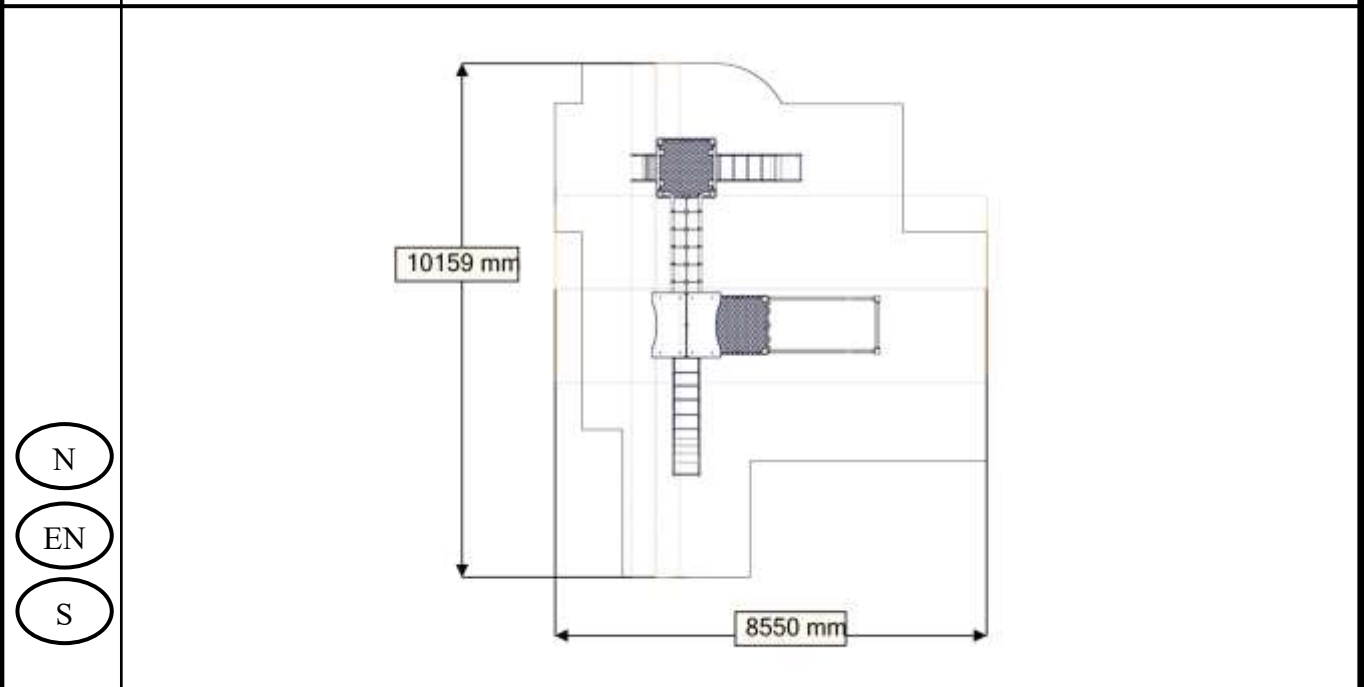











Anbefalt arealbehov ved montering / Recommended working space / Rekommenderad arealbehov vid montering





















Boltepakker for / Boltpackage for / Bultpaket för

Sign. _____

Stolpe 95x95	Ant= 1	Artikkel	Artikkelnr.	Ant	Lev
		VK95 L=2445 600-1845 (2) VK95 L=2600 600-2000(2) VK95 L=2900 600-2300(2) VK95 L=3235 600-2635(4)	00-400-001 00-400-018 00-400-010 På klatrevegg 00-400-009	4 2 0 4	
		Endelokk (1)	00-400-998	12	
Portal 01-400-220	Ant= 3	Artikkel	Artikkelnr.	Ant	Lev
		Frontplate (2)	01-126-003	6	
		Side plate H (1) Side plate V (1)	01-126-001 01-126-002	3 3	
		Sperrrerør (1)	01-126-004	3	
		Stolpe VK95 (2) L=640	01-126-005	6	
		Stolpende (2)	00-400-998	6	
		Torx M8x12(2) Torx M8x16 (6) Torx M8x35 (16) Torx M8x45 (2)	04-000-012 04-000-016 04-000-035 04-000-045	6 18 48 6	
		Brikke 120 3T (8)	04-060-120	24	
		Vinkel (2) 35x35x3 11mm hull	04-070-036	6	
		Møbelknapp (6) M8-13-17	04-030-011	18	
		Hylesmutter (2) M8 12-38	04-018-060	6	
		Skive M8 (4)	04-050-008	12	











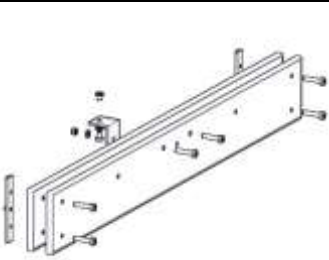



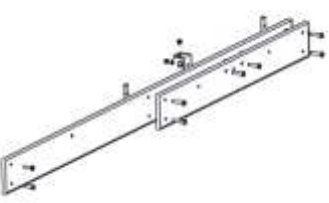

Boltepakker for / Boltpackage for / Bultpaket för

Sign. _____

Gulv 1160x1160x15	Ant= 1	Artikkel	Artikkelnr.	Ant	Lev
		Gulv (1)	00-400-300	1	
		Vinkel 50x50x4(2)	04-070-050	2	
		Torx M8x30 (2) Torx M8x12(2)	04-000-030 04-000-012	2 2	
		Møbelknapp (2)	04-030-011	2	
		Plast plug 9-11 mm (16)	04-090-002	16	
		Plug spor (8)	00-400-980	8	
		Skive M8 (4)	04-050-008	4	
		Låsemutter M8	04-040-008	2	
Gulv 2195x1160x15 For klattrevegg	Ant= 1	Artikkel	Artikkelnr.	Ant	Lev
		Gulv (1)	00-400-351_CUT	1	
		Vinkel 50x50x4(4)	04-070-050	4	
		Torx M8x30 (4) Torx M8x12(4)	04-000-030 04-000-012	4 4	
		Møbelknapp (4)	04-030-011	4	
		Plast plug 9-11 mm (24)	04-090-002	24	
		Plug spor (14)	00-400-980	14	
		Skive M8 (4)	04-050-008	8	
		Låsemutter M8	04-040-008	4	















Boltepakker for / Boltpackage for / Bultpaket för

Sign. _____

Sprosse 01-400-112 med hull polyfixnett	Ant= 1	Artikkel	Artikkelnr.	Ant	Lev
		Sprosse (2) 1160x145x15 Med hull	01-400-112	2	
		Torx M8x50 (4) Torx M8x45(2) Torx M8x12 (1)	04-000-050 04-000-045 04-000-012	4 2 1	
		Brikke 150 _3T (2) På stolpe	04-060-150	0	
		Möbelknapp (1) M8- 13-17	04-030-011	1	
		Vinkel 50x50x4(1) 11mm hull	04-070-050	1	
		Mutter M8 (1)	04-040-008	1	
		Skive M8 (2)	04-050-008	2	
Sprosse 01-400-205 med hull polyfixnett	Ant= 1	Artikkel	Artikkelnr.	Ant	Lev
	 	Sprosse (1) 1160x145x15 Med hull Sprosse (1) 2165x145x15 Med hull	01-400-112 01-400-205	1 1	
		Torx M8x50 (4) Torx M8x45(2) Torx M8x35 (2) Torx M8x12 (1)	04-000-050 04-000-045 04-000-035 04-000-012	4 2 2 1	
		Brikke 150 _3T (3) På stolpe	04-060-150	0	
		Möbelknapp (1) M8- 13-17	04-030-011	1	
		Vinkel 50x50x4(1) 11mm hull	04-070-050	1	
		Mutter M8 (1)	04-040-008	1	
		Skive M8 (2)	04-050-008	2	











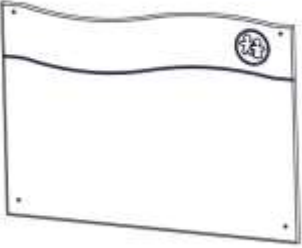

Boltepakker for / Boltpackage for / Bultpaket för

Sign. _____

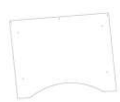
Sprosse 01-400-108	Ant= 6	Artikkel	Artikkelnr.	Ant	Lev
		Sprosse (1) 1160x145x15	01-400-108	6	
		Torx M8x35 (4)	04-000-035	24	
		Brikke 150 _3T (2) På stolpe	04-060-150	0	
Sprosse 01-400-203	Ant= 1	Artikkel	Artikkelnr.	Ant	Lev
		Sprosse (1) 2165x145x15	01-400-203	1	
		Torx M8x35 (6)	04-000-035	6	
		Brikke 150 _3T (3) På stolpe	04-060-150	0	
MT-nett 05-079-015	Ant= 2	Artikkel	Artikkelnr.	Ant	Lev
		MT- nett (1) Inkl Kjetting	05-079-015	2	
		Torx M8x35(2)	04-000-035	4	
		Torx M8x25(4)	04-000-025	8	
		Fundamentskive(2) 2H 80	00-003-106	4	
		Skive M8(4)	04-055-008	8	
Skive M8(4)		04-050-008	8		
	Mutter M8(6)	04-040-008	12		













Boltepakker for / Boltpackage for / Bultpaket för

Sign. _____

Vegg 940x686x12 01-125-002	Ant= 4	Artikkel	Artikkelnr.	Ant	Lev
		Vegg 940x686x12 (1)	01-125-002	4	
		Brikke 50_1T(4)	04-060-050	16	
		Torx M8x25(8)	04-000-025	32	
		Vinkel 50x50x50x4 (4)	04-075-050	16	
		Mutter M8(4)	04-040-008	16	
Tak 01-128-000	Ant= 1	Artikkel	Artikkelnr.	Ant	Lev
		Tak 1280x960x12 (2)	01-128-001	2	
		Gavel 1216x668x12 (2)	01-128-002	2	
		Brikke 50_1T (4)	04-060-050	4	
		Torx M8x12(22) Torx M8x35(4)	04-000-012 04-000-035	22 4	
		Vinkel 35x35x35x3 (11)	04-070-036	11	
		Møbelknapp M8_13_17(22)	04-030-011	22	
		Skive M8 822)	04-050-008	22	













Boltepakker for / Boltpackage for / Bultpaket för

Sign. _____

Ligger M-nett	Ant= 1	Artikkel	Artikkelnr.	Ant	Lev
		Ligger M-nett 4 hull (1)	00-400-814	1	
		Torx M8x25 (4)	04-000-025	4	
		Brikke 160-2T (1+1) 1 på klatreveggstolpe	04-060-160	1	
Ligger 00-400-816	Ant= 1	Artikkel	Artikkelnr.	Ant	Lev
		Ligger (1)	00-400-816	1	
		Torx M8x25 (4)	04-000-025	4	
		Brikke 160-2T (2)	04-060-160	2	
Ligger kort M-nett	Ant= 1	Artikkel	Artikkelnr.	Ant	Lev
		Ligger M-nett 4 hull (1)	00-400-815	1	
		Torx M8x25 (4)	04-000-025	4	
		Brikke 160-2T (2)	04-060-160	2	



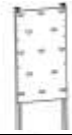





Boltepakker for / Boltpackage for / Bultpaket för

Sign. _____

Rutsjebane 1400 40-142-101	Ant= 1	Artikkel	Artikkelnr.	Ant	Lev
		Systembane 1400	40-142-101	1	
		Brikke160 3T(2)	04-060-160	2	
		Torx M8x35(8)	04-000-035	8	
		Torx M8x45(2)	04-000-045	2	
		Fundamentalskive(2) 2H 80	00-003-106	2	
		Skive M8(2)	04-050-008	4	
		Mutter M8(2)	04-040-008	6	
		Stålforankering(2)	00-100-310	2	
	Plast plug 9-11 mm (4)	04-090-002	4		
Klatrevegg_Spesial	Ant= 1	Artikkel	Artikkelnr.	Ant	Lev
		Klatrevegg Inkl stolper Lengde stolpe L=2900	00-400-722	1	
		Torx M8x35 (8)	04-000-035	8	
		Brikke 50_1T (8)	04-000-050	8	











Boltepakker for / Boltpackage for / Bultpaket för

Sign. _____.

Rutsjebane 950 40-142-020	Ant= 1	Artikkel	Artikkelnr.	Ant	Lev
		Systembane 950	40-142-020	1	
		Brikke160 3T(2)	04-060-160	2	
		Torx M8x35(8) Torx M8x45(2)	04-000-035 04-000-045	8 2	
		Fundamentskive(2) 2H 80	00-003-106	2	
		Skive M8(2)	04-050-008	4	
		Mutter M8(2)	04-040-008	6	
		Stålforankering(2)	00-100-310	2	
		Plast plug 9-11 mm (4)	04-090-002	4	









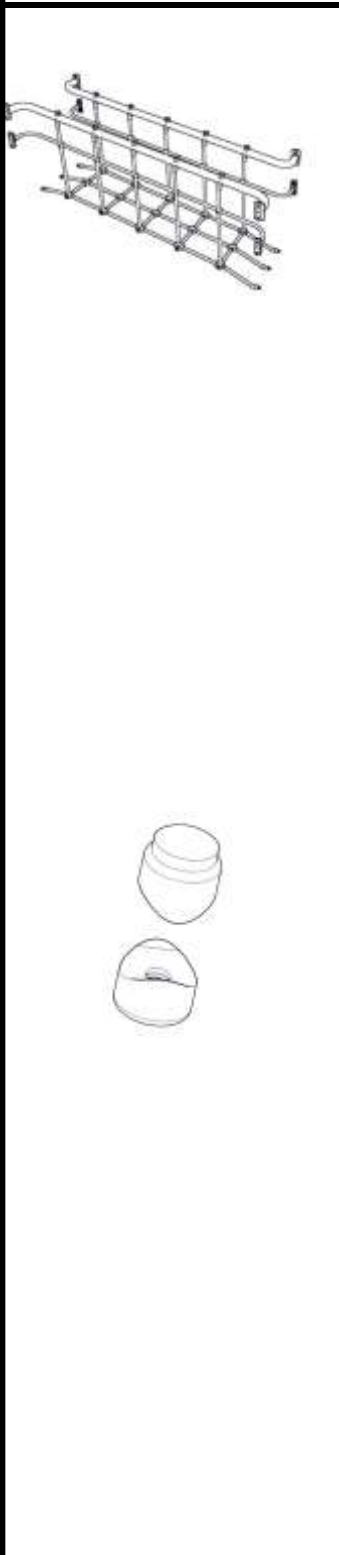

Boltepakker for / Boltpackage for / Bultpaket för

Sign. _____.

Stigge 950 00-400-615	Ant= 1	Artikkel	Artikkelnr.	Ant	Lev
		Stigge 950	00-400-615	1	
		Brikke 50_1T(2)	04-060-050	2	
		Torx M8x35(6)	04-000-035	6	
		Torx M8x16(2)	04-000-016	2	
		Fundamentskive(2) 2H 80	00-003-106	2	
		Skive M8(2)	04-050-008	4	
		Mutter M8(2)	04-040-008	4	
		Møbelknapp(2) M7_13-17	04-030-011	2	
	Stålforankering(2)	00-100-310	2		





Boltepakker for / Boltpackage for / Bultpaket för

Sign. _____

Poly-skrå brua	Ant= 1	Artikkel	Artikkelnr.	Ant	Lev
		Rør skrå høyre	07-200-026	1	
		Rør skrå venste	07-200-025	1	
		Nett brua skrå	07-500-042	1	
		Torx M8x25 (8) Torx M8x30 (8)	04-000-025 04-000-030	8 8	
		Brikke 120_3T (8)	04-060-120	8	
		Plast Rondel (10)	05-300-036	10	
		Plast rondell (20)	05-300-036	20	
		Skive M10 stor polyfix (20)	04-055-036	20	
		Mutter M10 (10) Mutter M8 (6)	04-040-0010 04-040-008	10 6	
		Skive M8	04-055-008	6	

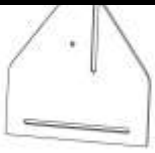
Boltepakker for / Boltpackage for / Bultpaket för

Sign. _____

Fundament	Ant= 12	Artikkel	Artikkelnr.	Ant	Lev
		Fundament plate(1)	00-003-010	12	
		Fundamentdel1 (1) 4x med VK70 hull 1x med VK95 hull	00-003-010	12	
		Fundament del2 (1) 4x med VK70 hull 1x med VK95 hull	00-003-010	12	
		Torx M8x35(3)	04-000-035	36	
		Brikke 120 3T (1) Brikke 501T(1)	04-060-120 04-060-120	12 12	
		Skive M8 Stor(3)	04-055-008	36	

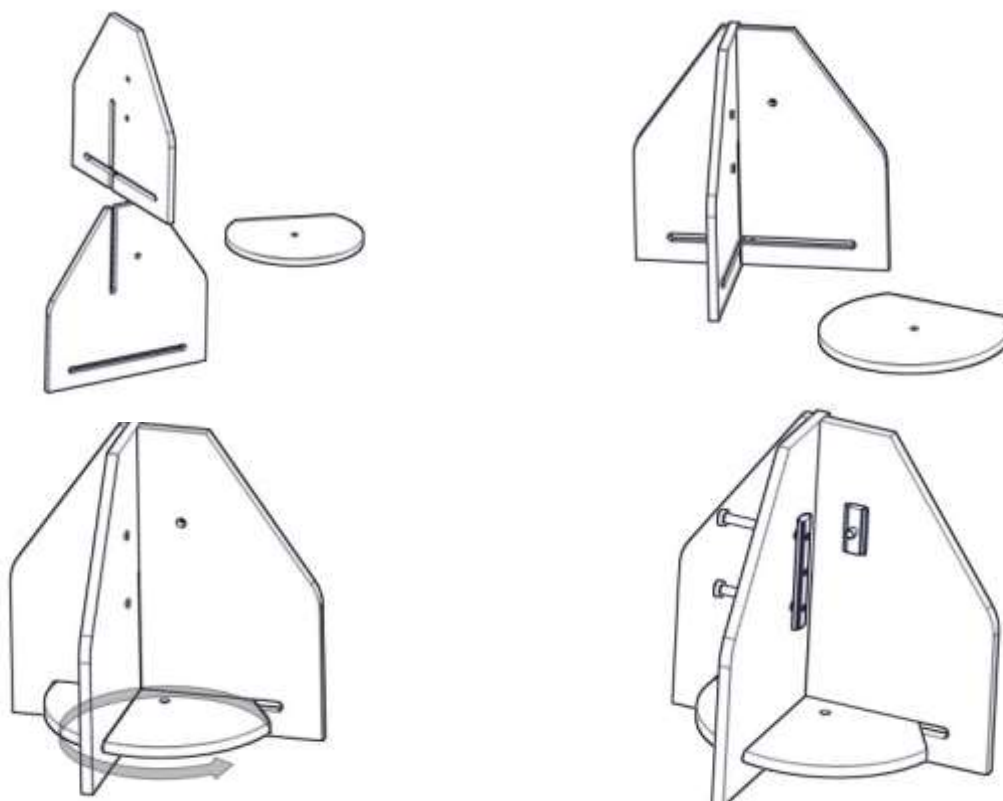

Fundamentering med betong / Foundation concrete / Förankring med betong

(N)	Støtsand		(N)	(UK)	(S)
(UK)	Safer surface		Bakkenivå	Ground level	Marknivå
(S)	Stridsan		↓	Ref NS-EN 177	
(N)	Komprimert masse.	betong			
(UK)	Compressed mass.	concrete			
(S)	Komprimerad massa.	betong			

Fundamentering uten betong / Foundation without concrete / Förankring utan betong

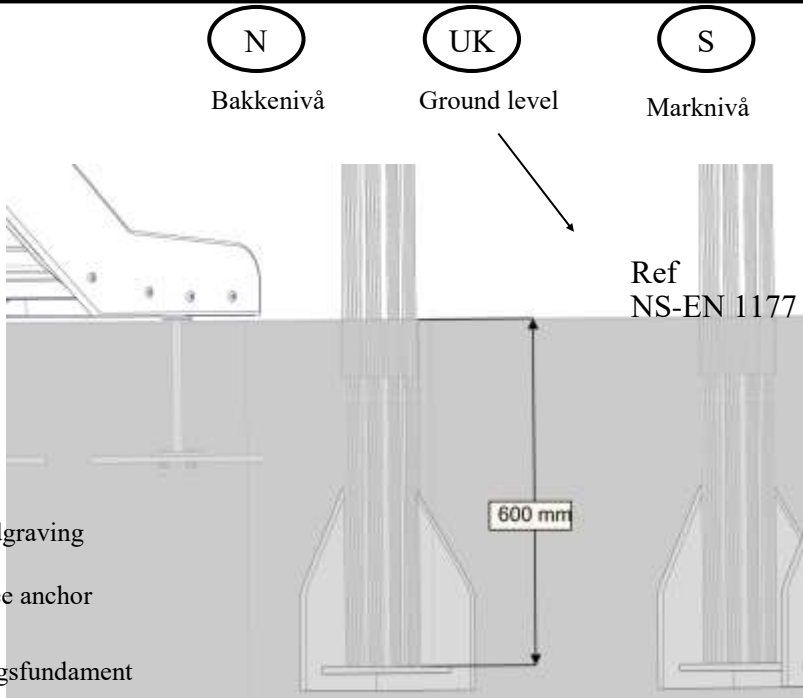
(N)	Støtsand		(N)	(UK)	(S)
(UK)	Safer surface		Bakkenivå	Ground level	Marknivå
(S)	Stridsan		↓	Ref NS-EN 1177	
(N)	Komprimert masse	Støpefri nedgraving			
(UK)	Compressed mass	Concrete-free anchor			
(S)	Komprimerad massa	Nedgrävningfundament			

(N)	Alle mål er oppgitt i millimeter
(UK)	Scale measured in mm
(S)	Alla mått är i millimeter.

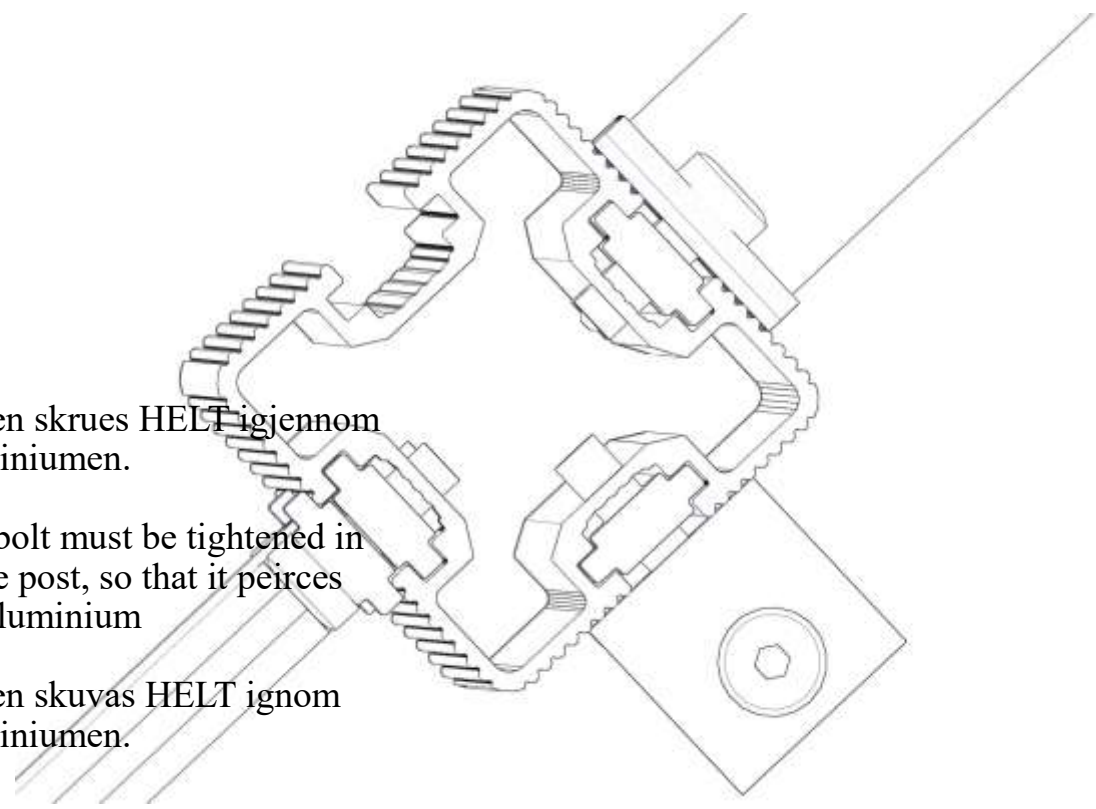
<p data-bbox="119 1556 215 1624">N</p> <p data-bbox="119 1691 215 1758">UK</p> <p data-bbox="119 1848 215 1915">S</p>	 <p data-bbox="231 1579 702 1668">Bolten skrues HELT igjennom aluminiumen.</p> <p data-bbox="231 1691 686 1825">The bolt must be tightened in to the post, so that it peirces the aluminium</p> <p data-bbox="231 1848 662 1937">Bulten skivas HELT ignom aluminiumen.</p>

Fallhøyder / Free height of fall / Fallhöjder

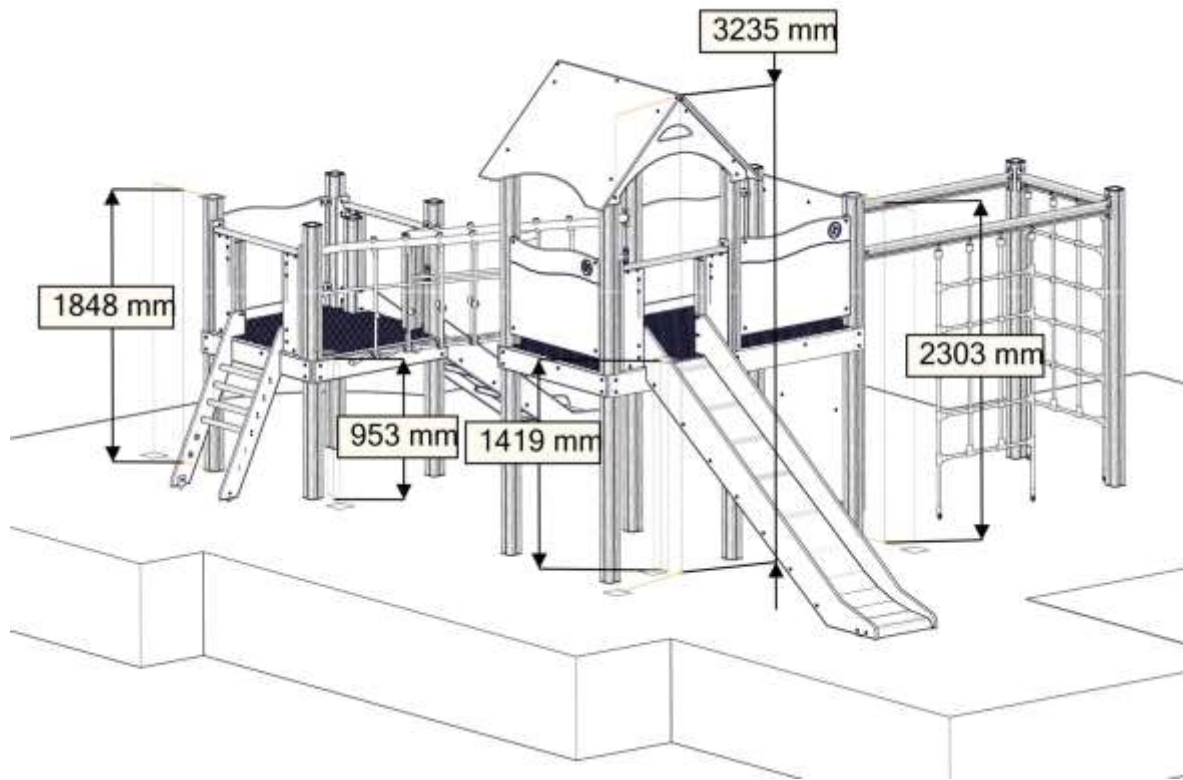

Sikkerhetszone / Safety zone / Säkerhetszon

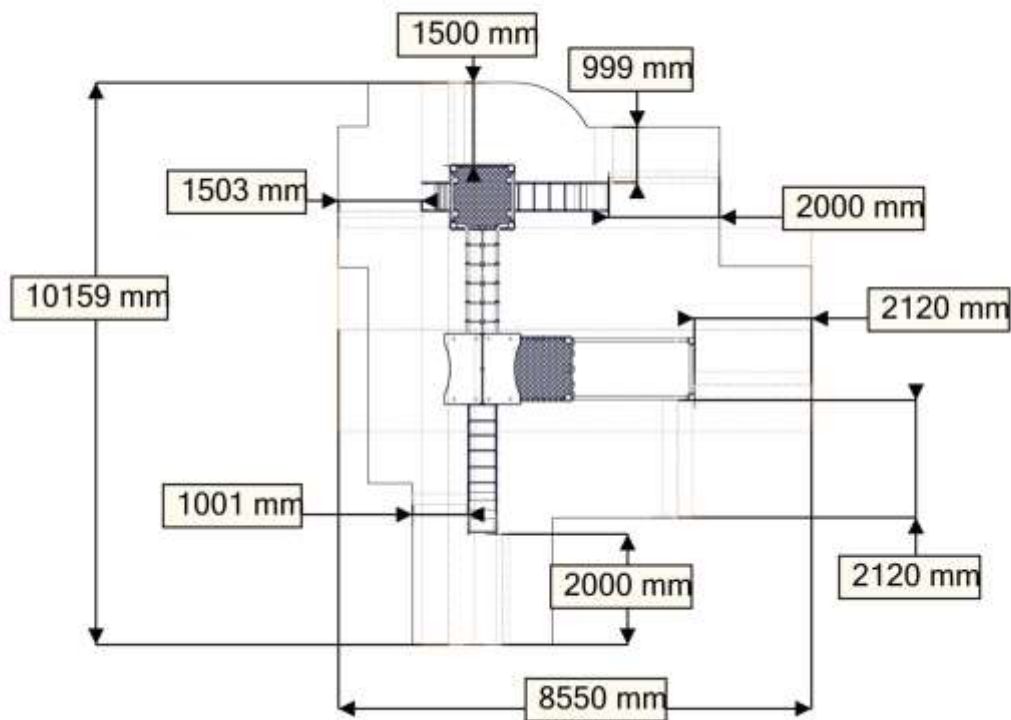

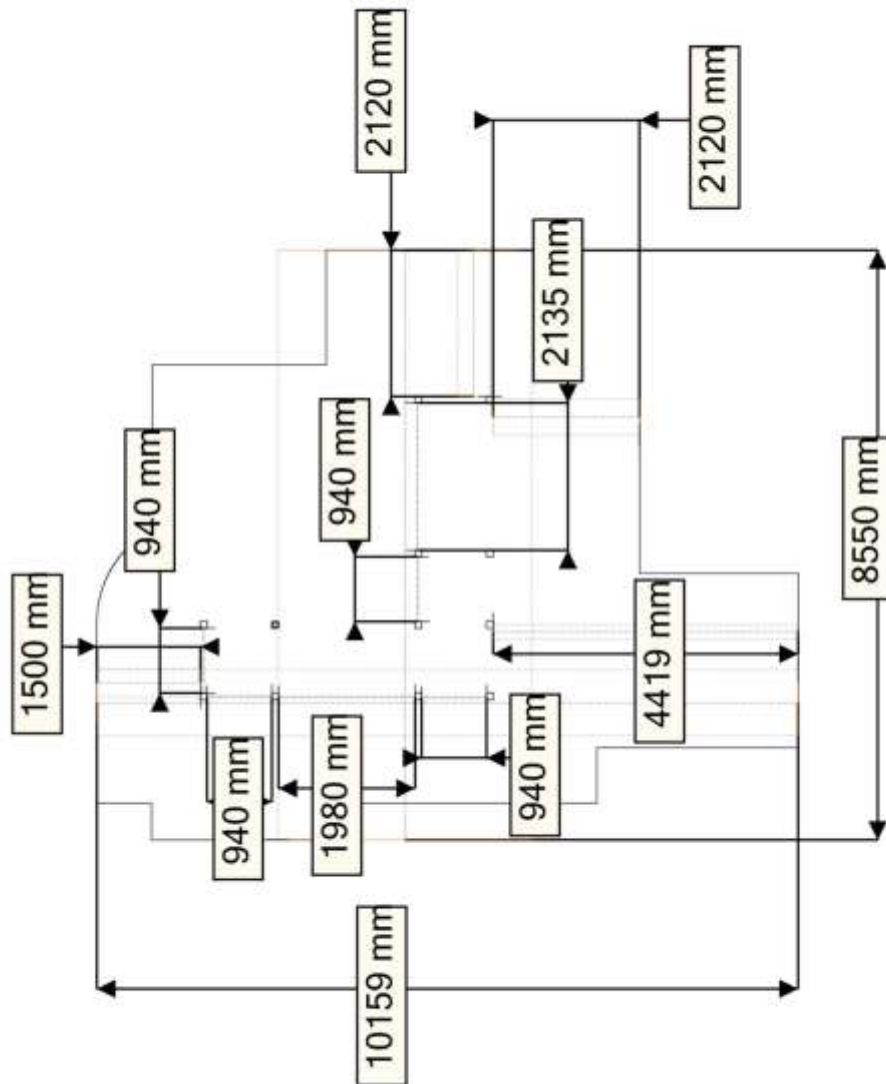
Plassering av forankringer / Ground plan / Placering av förankringar

N

Alle mål er oppgitt i millimeter

UK

Scale measured in mm

S

Alla mått är i millimeter.

Montering av lekeapparatet / Assembly instructions / Montering av lekredskapet

12x

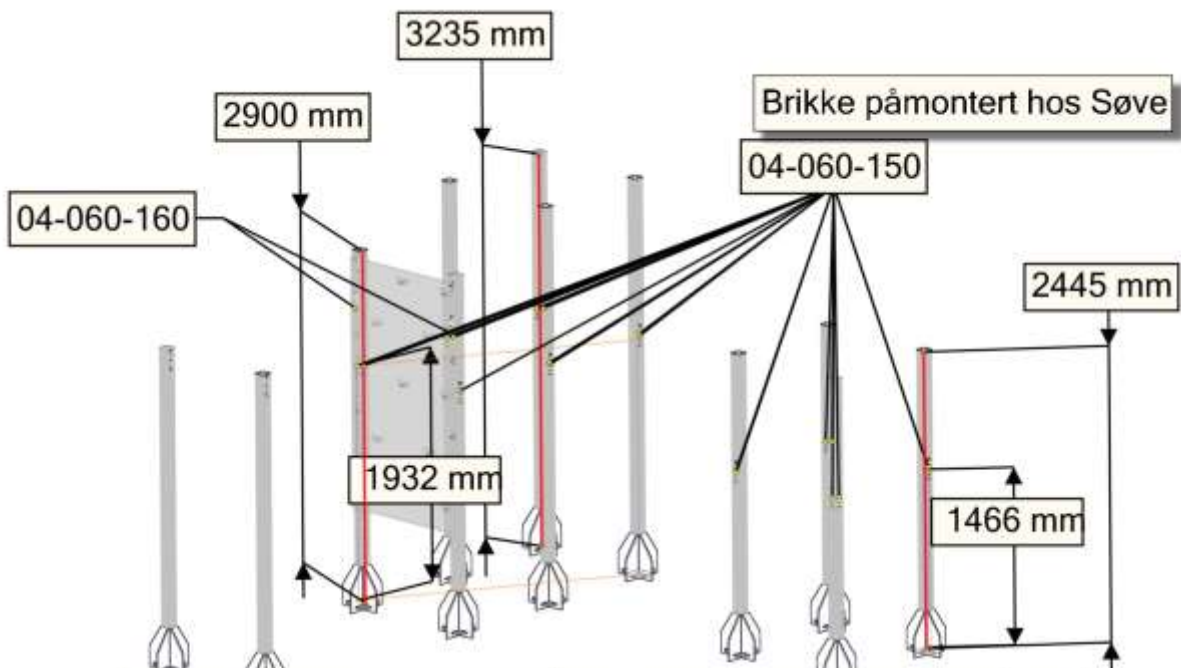
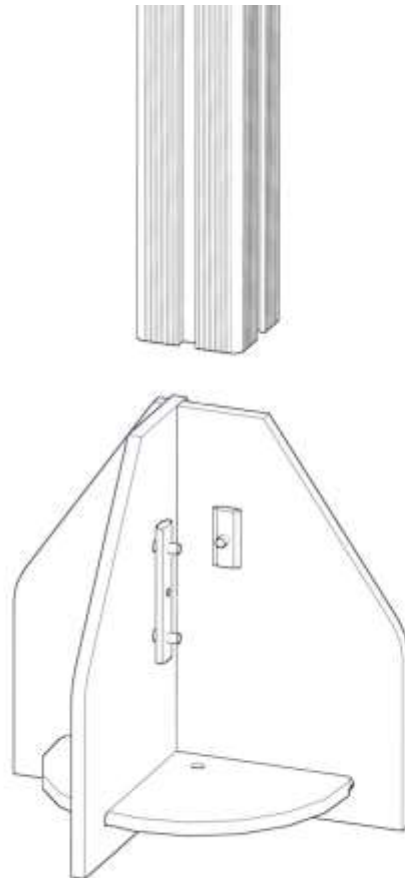

BOM ID	Name	SW Configuration	Artnr (config)	Qty
1	VK95_SFA5117_A-1	600-1845	00-400-001	4
2	VK95_SFA5117_A-1	600-2635	00-400-009	4
3	VK95_SFA5117_A-1	600-2000	00-400-018	2
4	VK95_SFA5117_A-1	600-2300	00-400-010	2

Montering av lekeapparatet / Assembly instructions / Montering av lekredskapet

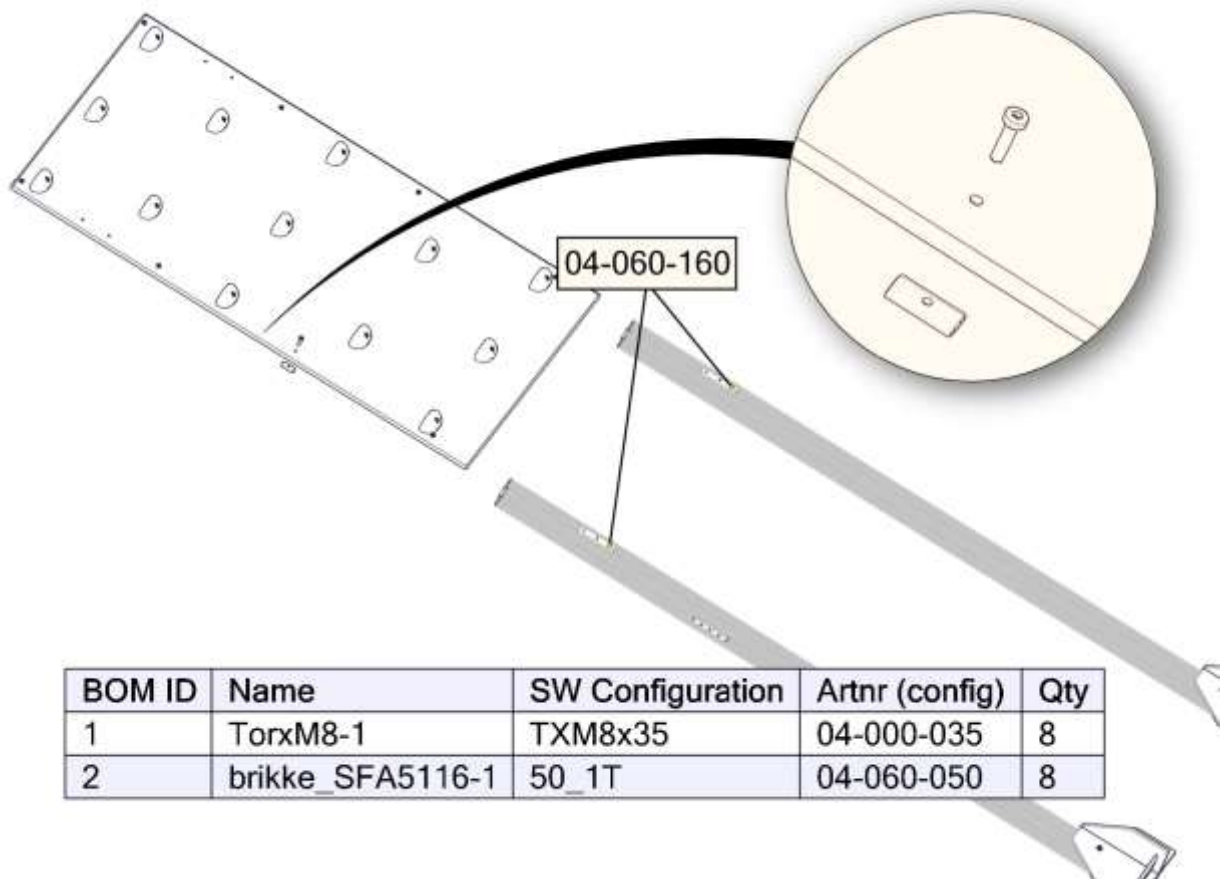
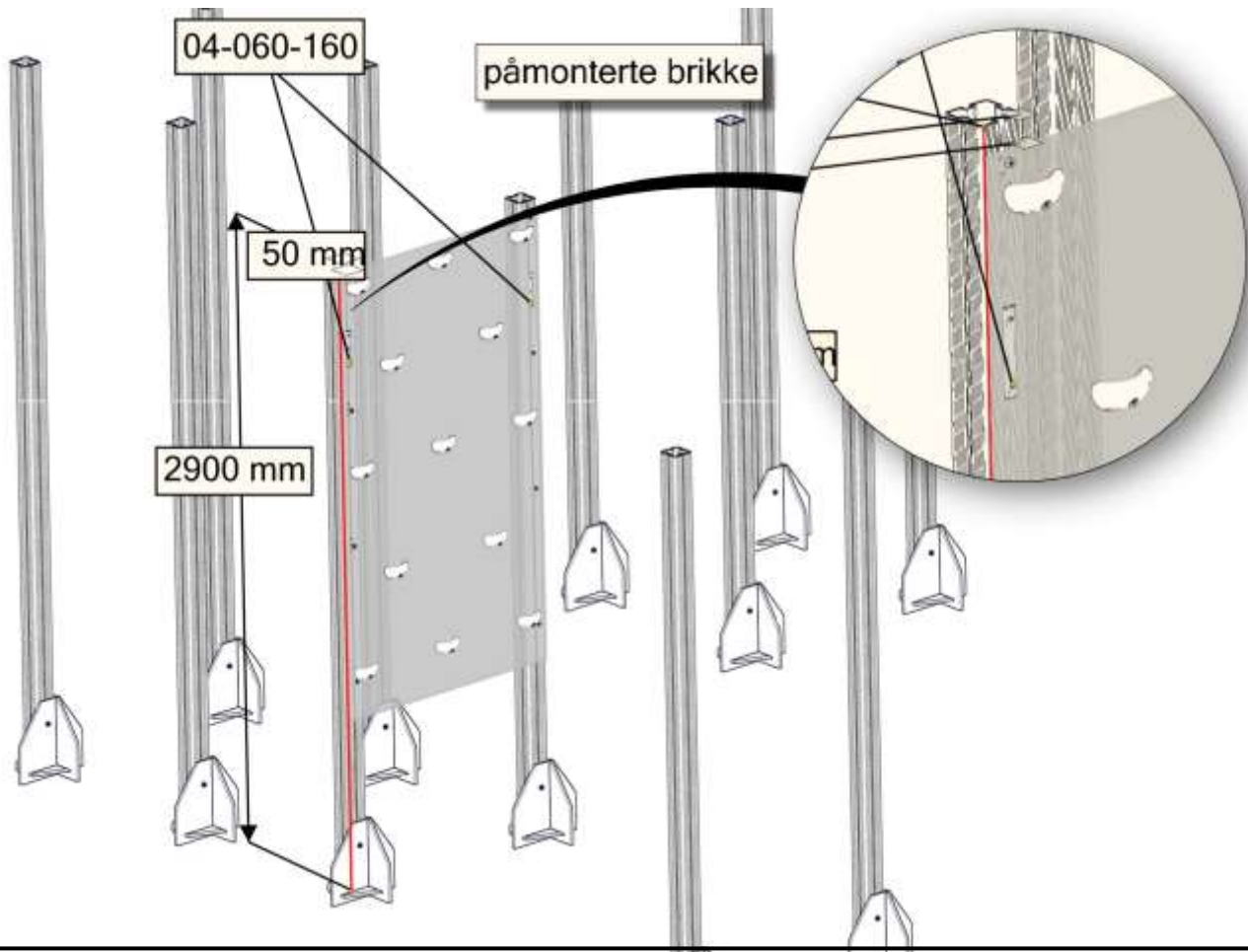

BOM ID	Name	SW Configuration	Artnr (config)	Qty
1	TorxM8-1	TXM8x35	04-000-035	8
2	brikke_SFA5116-1	50_1T	04-060-050	8

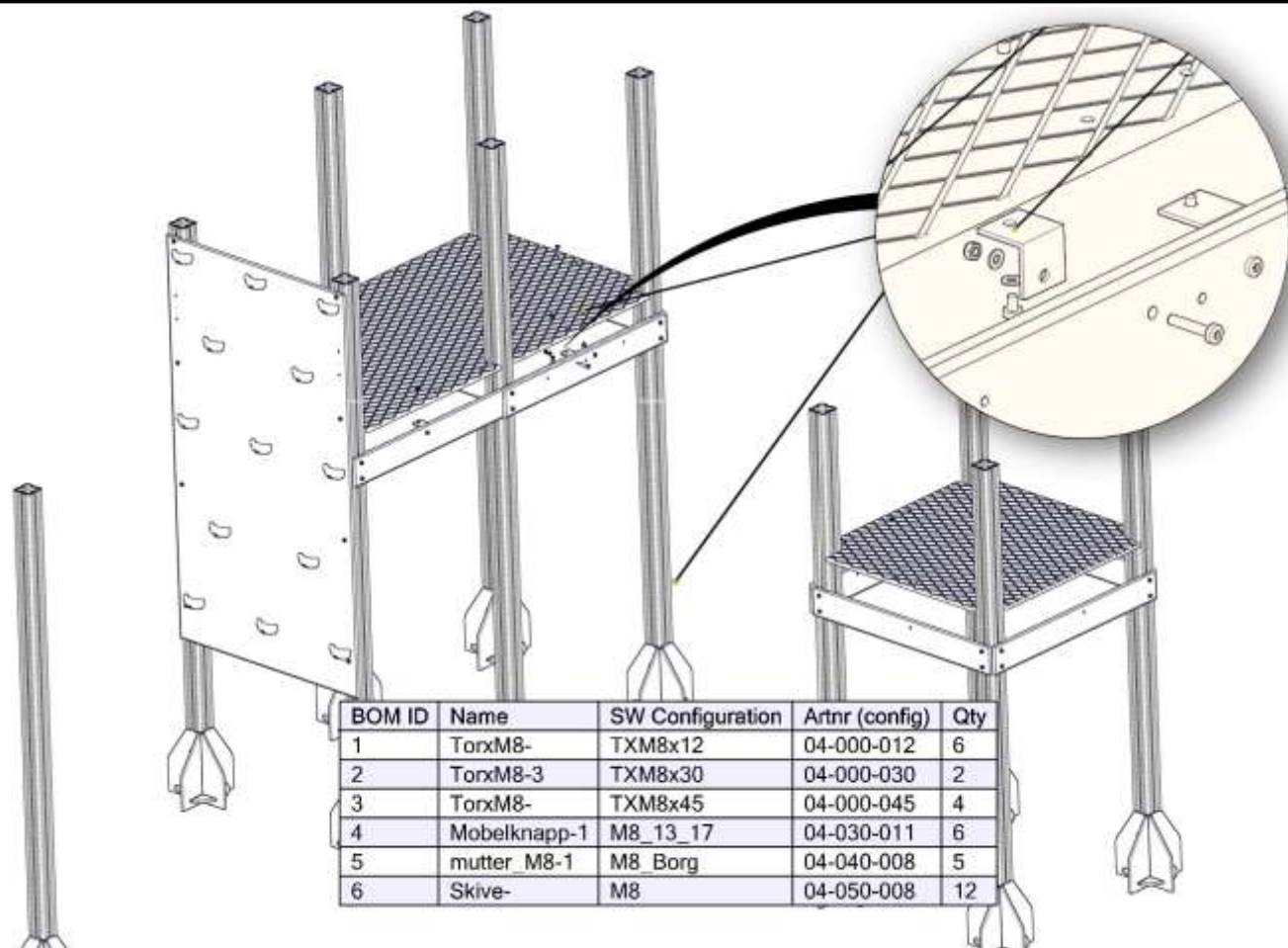
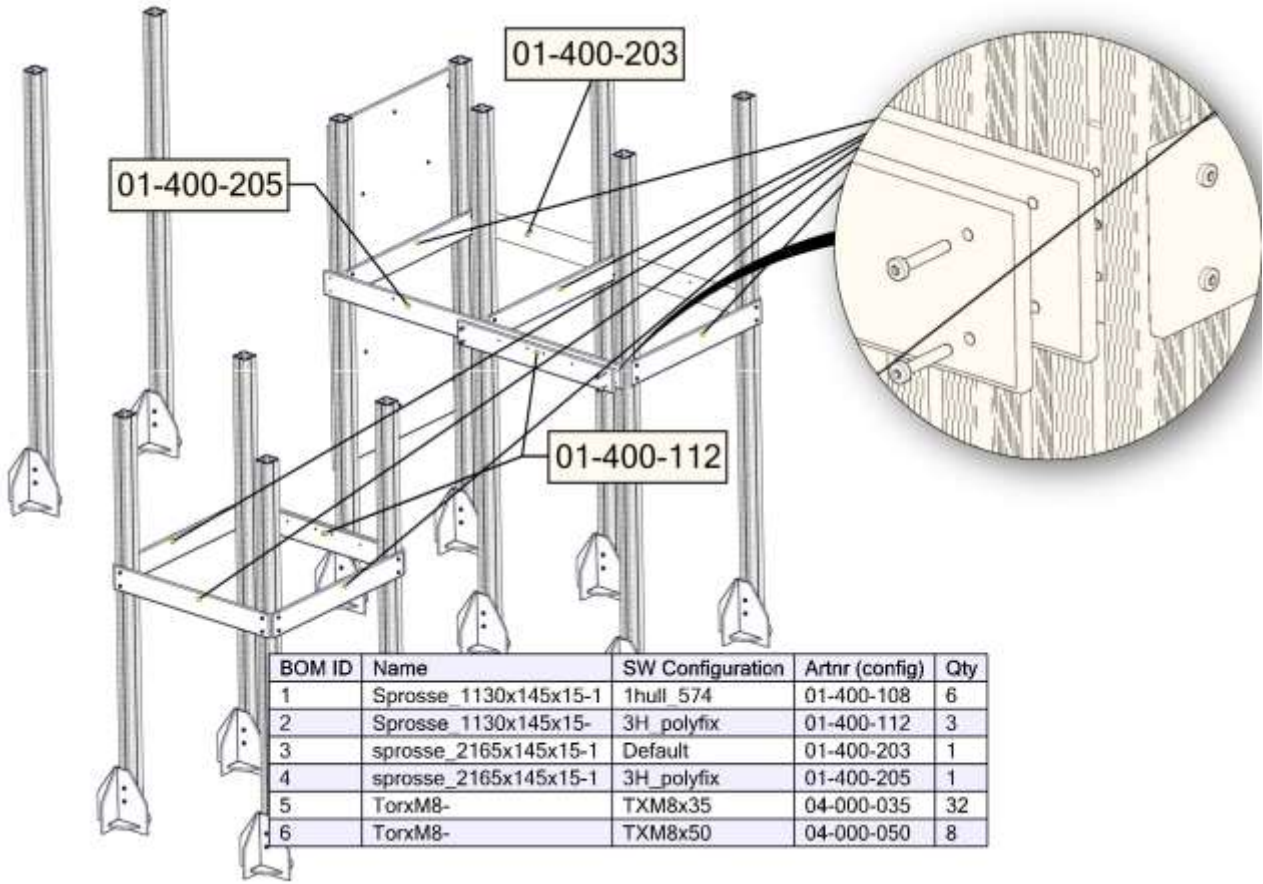

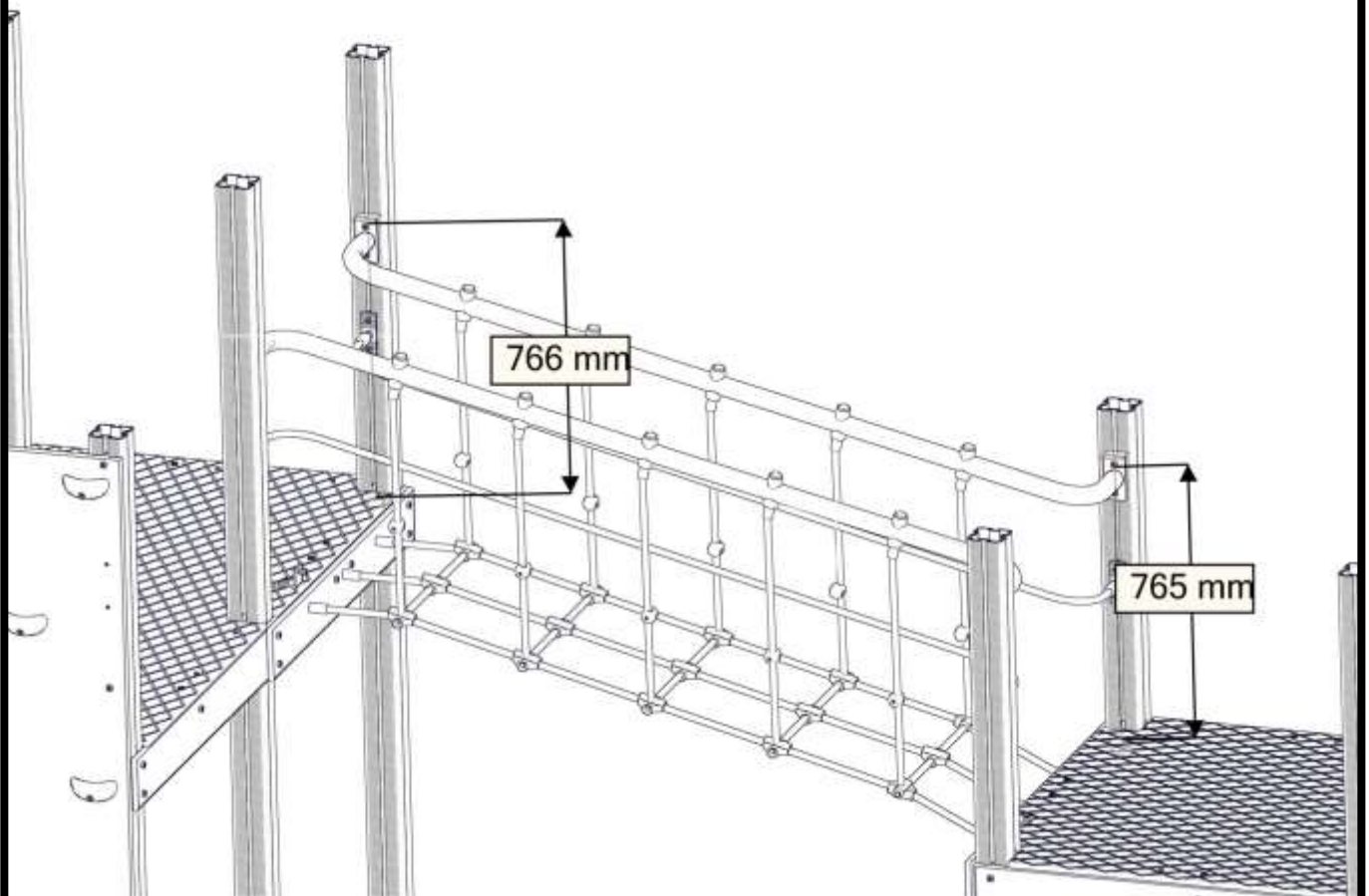
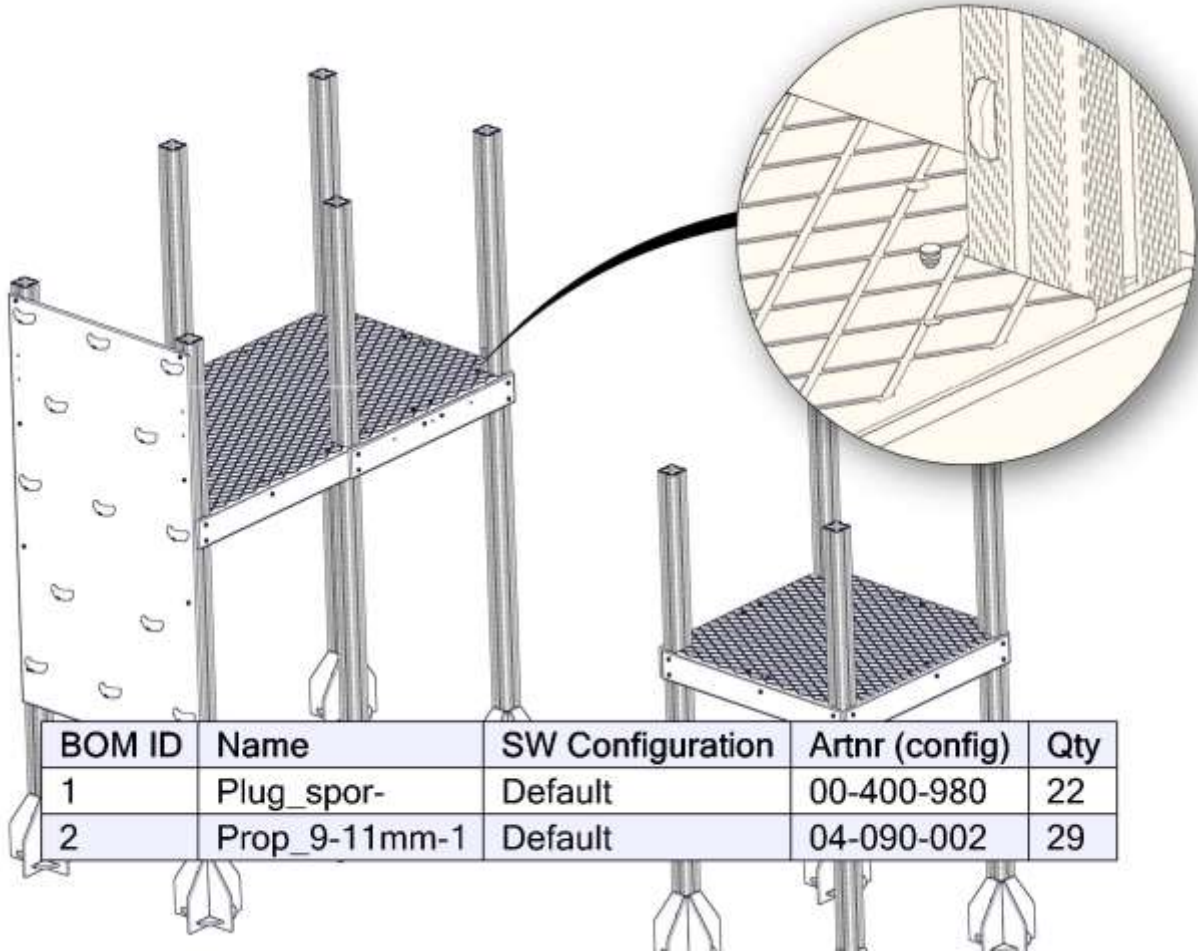

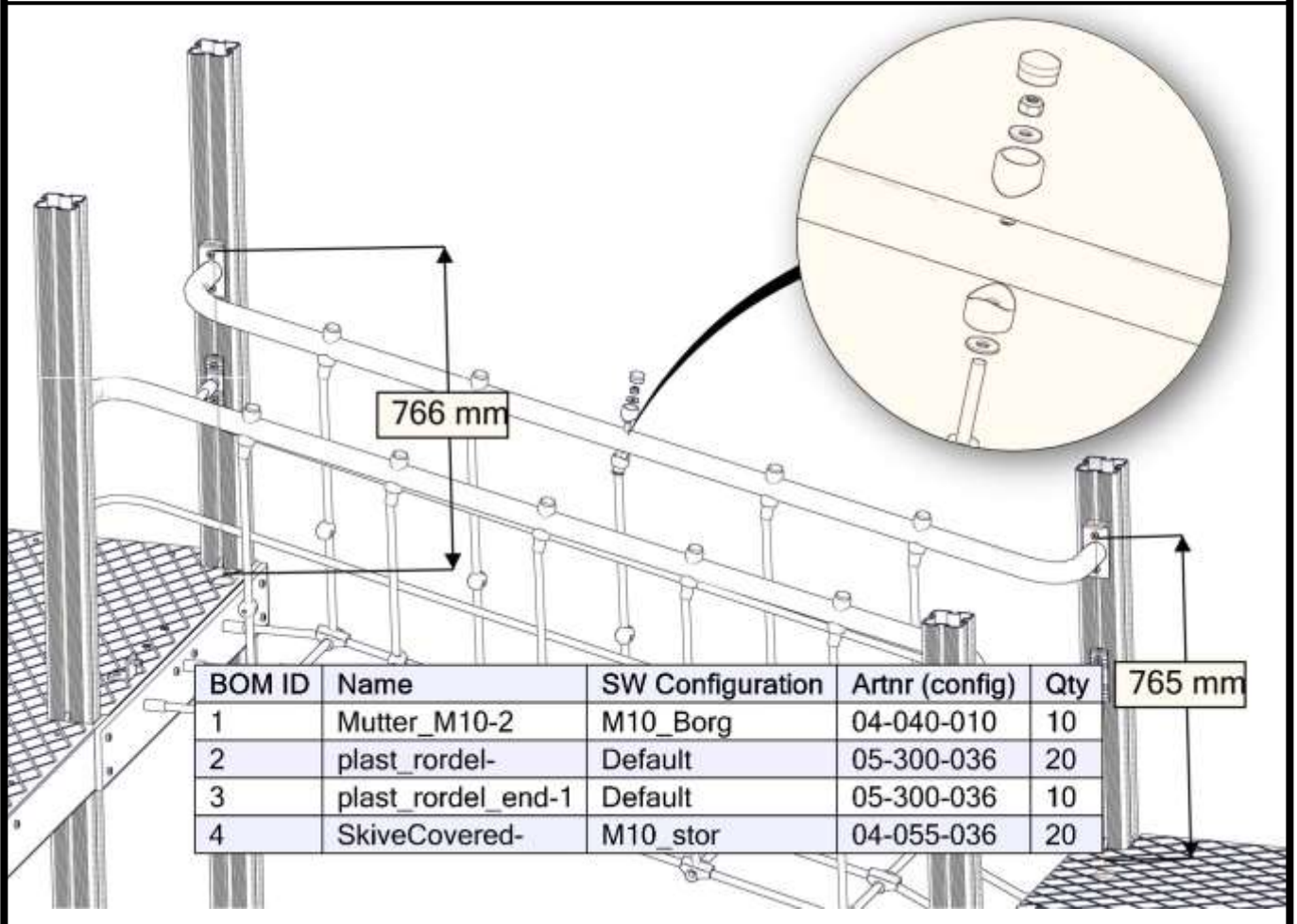
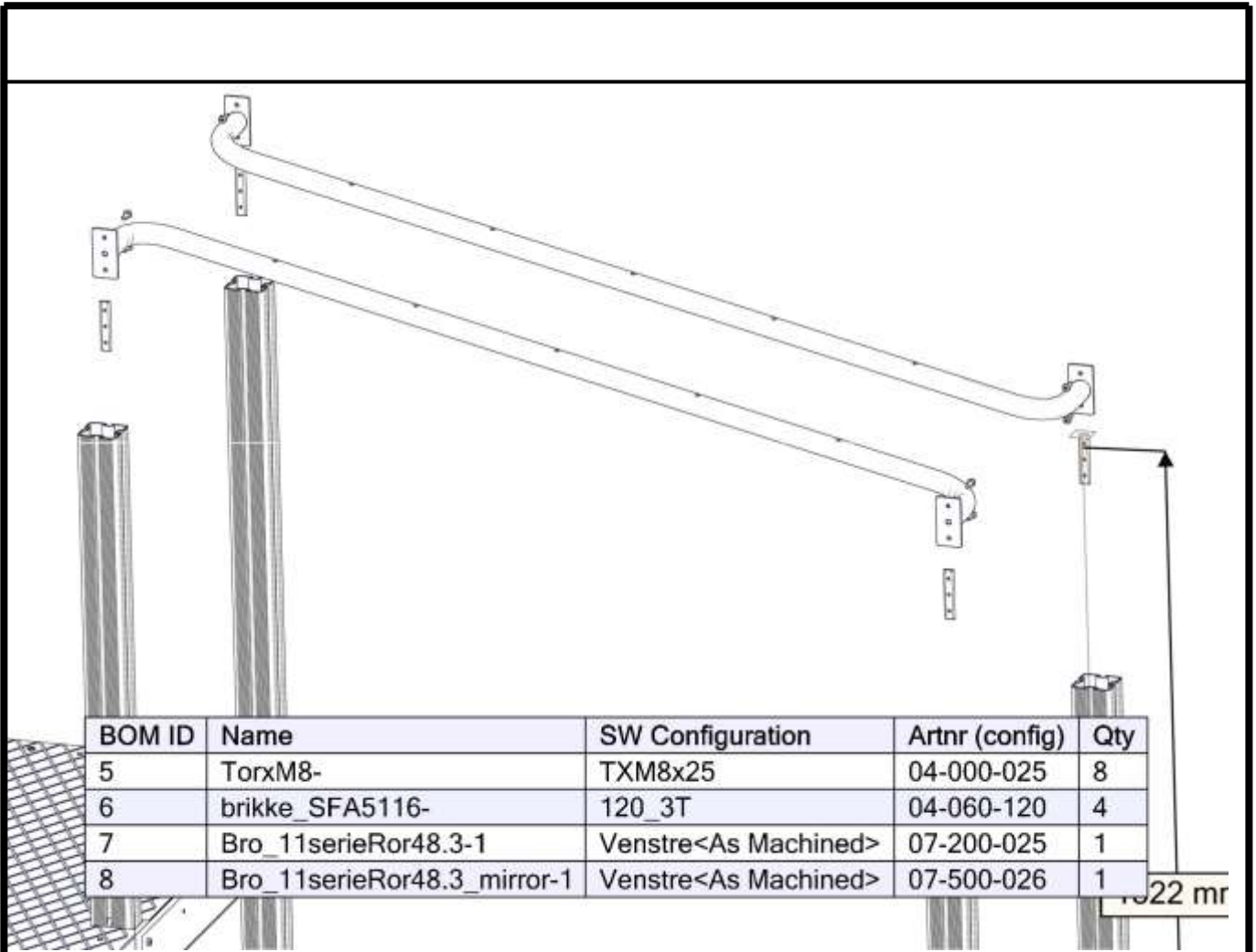

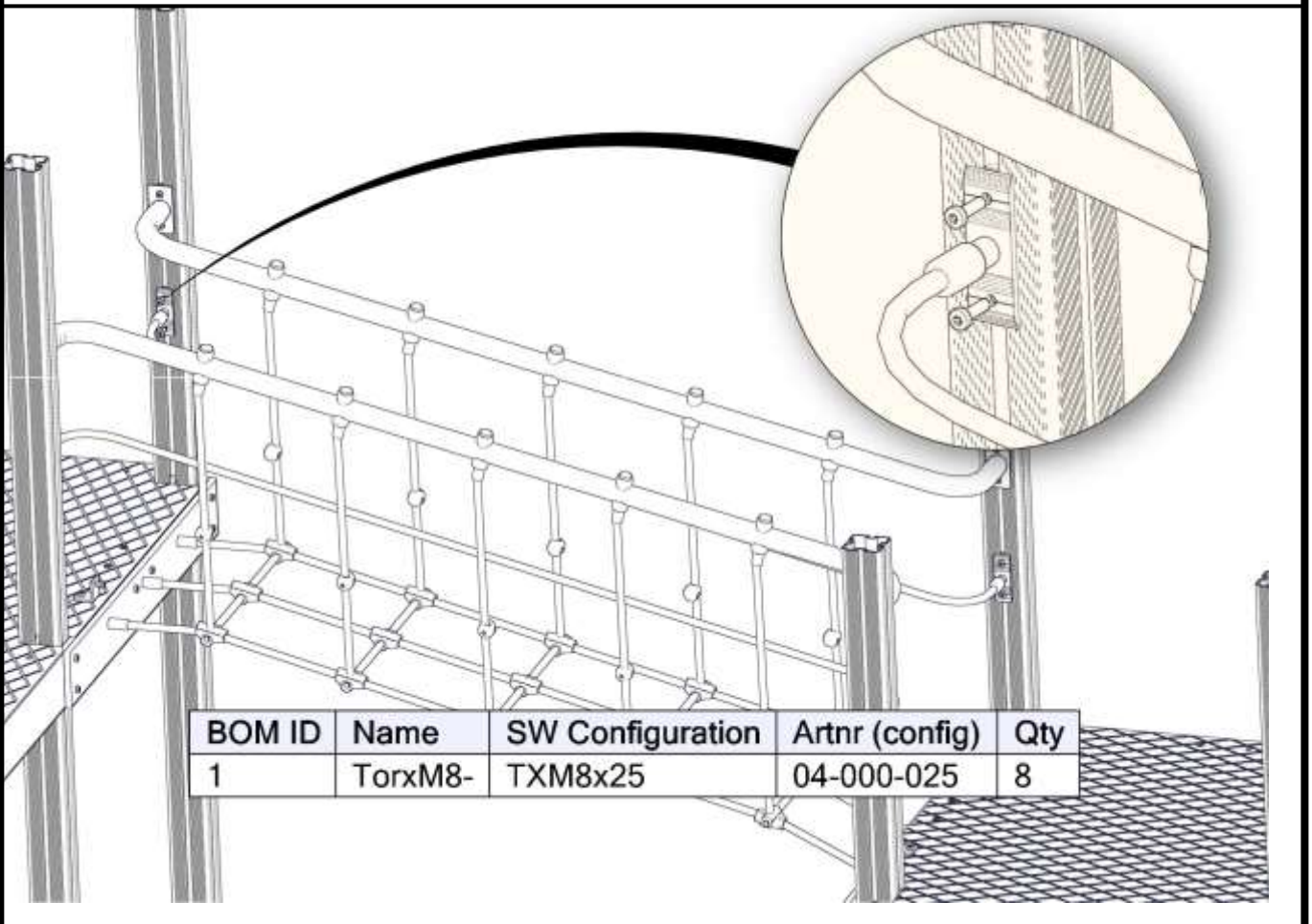
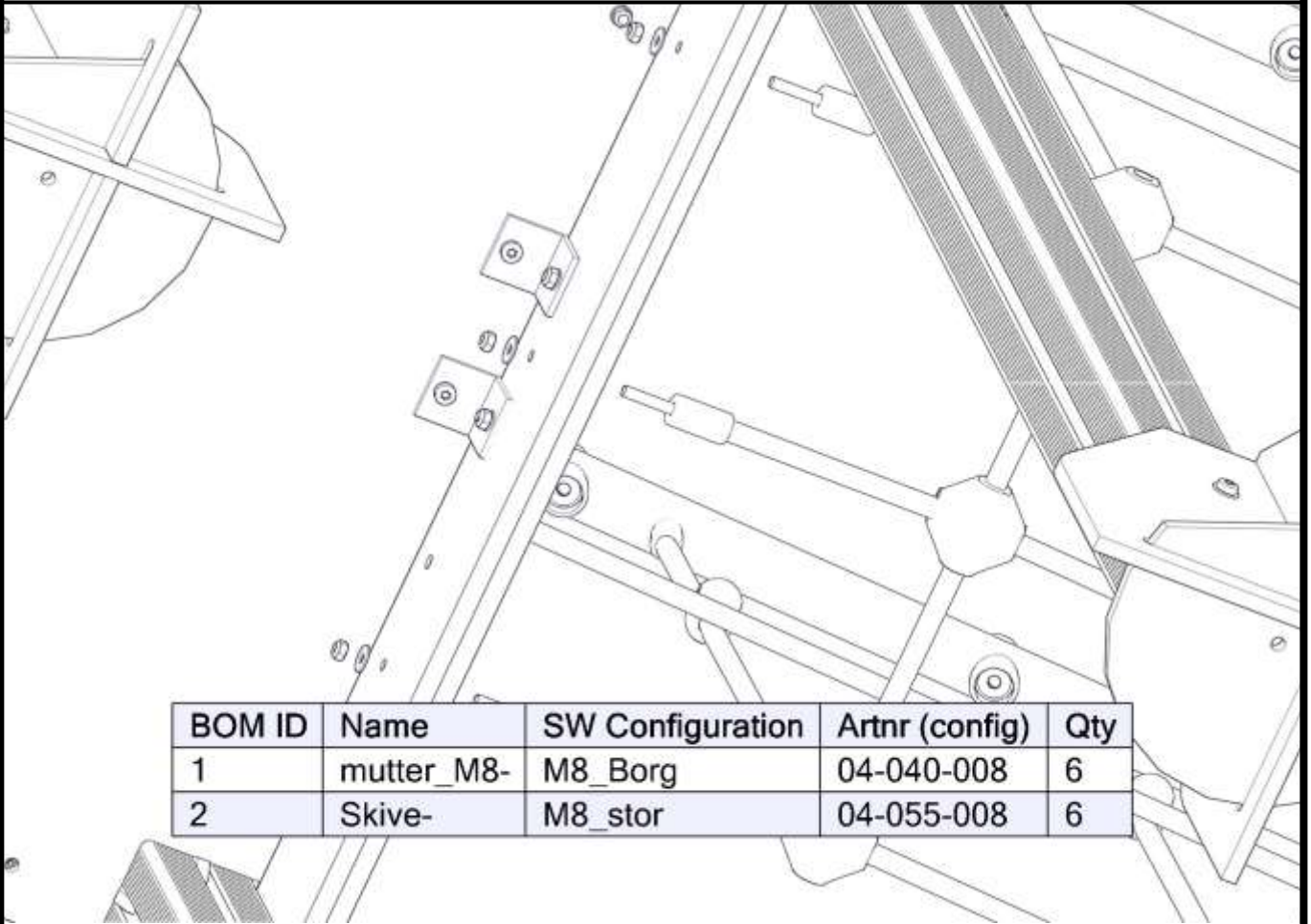

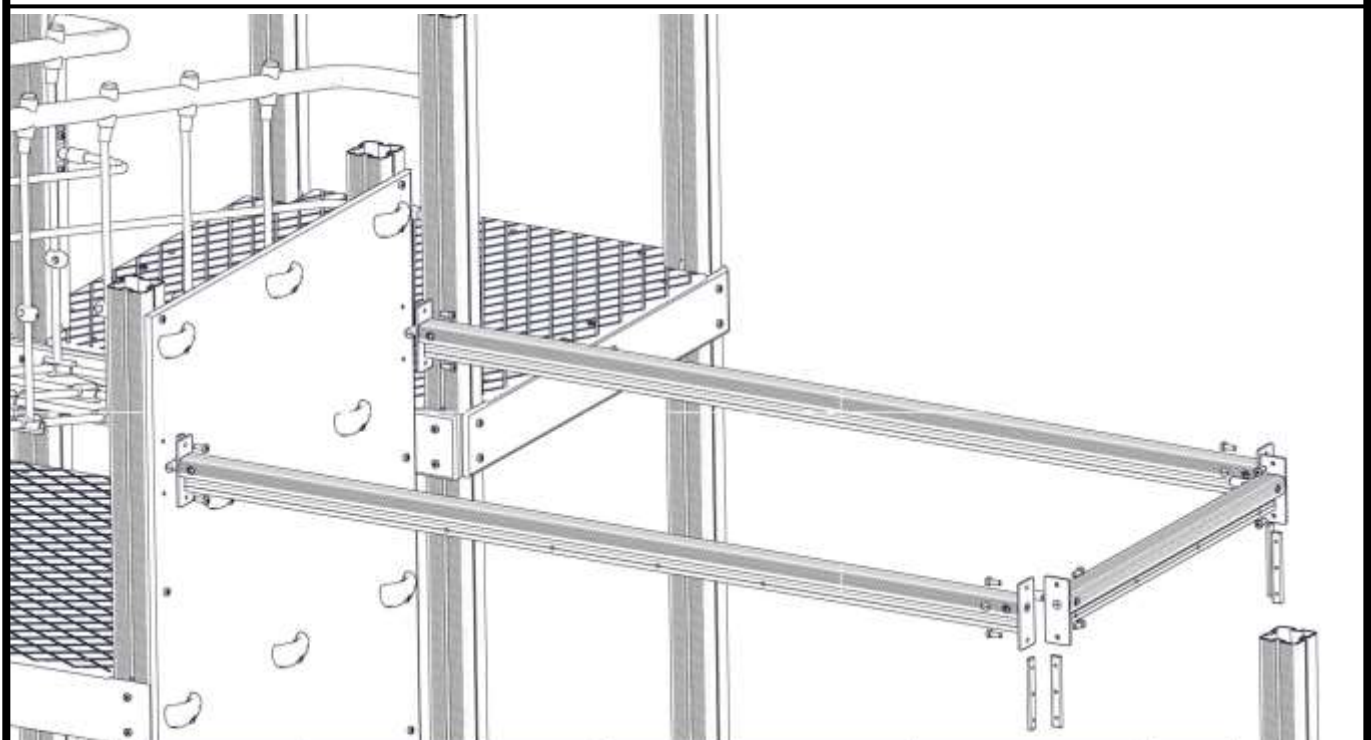
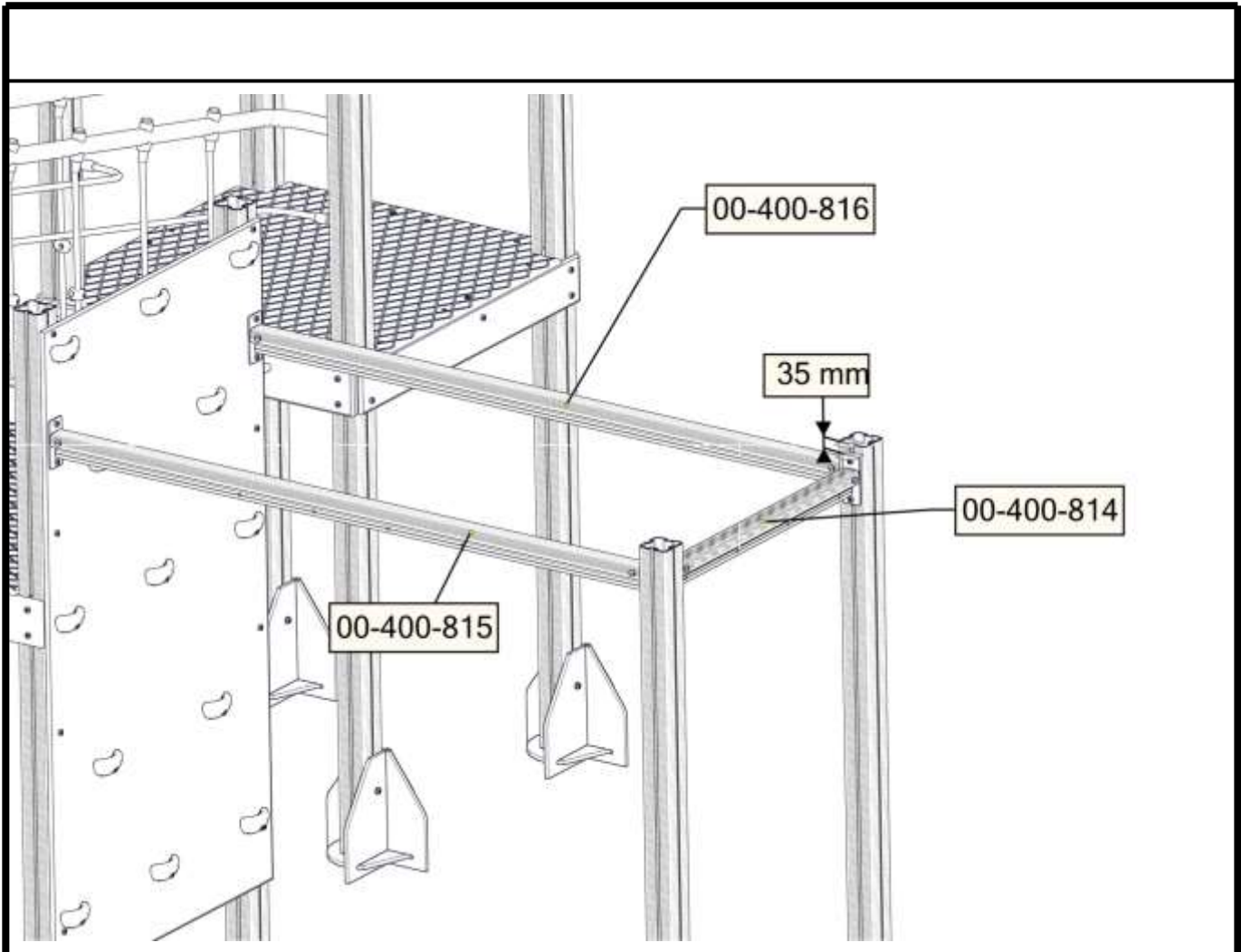

BOM ID	Name	SW Configuration	Artnr (config)	Qty
1	TorxM8-	TXM8x25	04-000-025	12
2	brikke_SFA5116-	160_3T	04-060-160	4

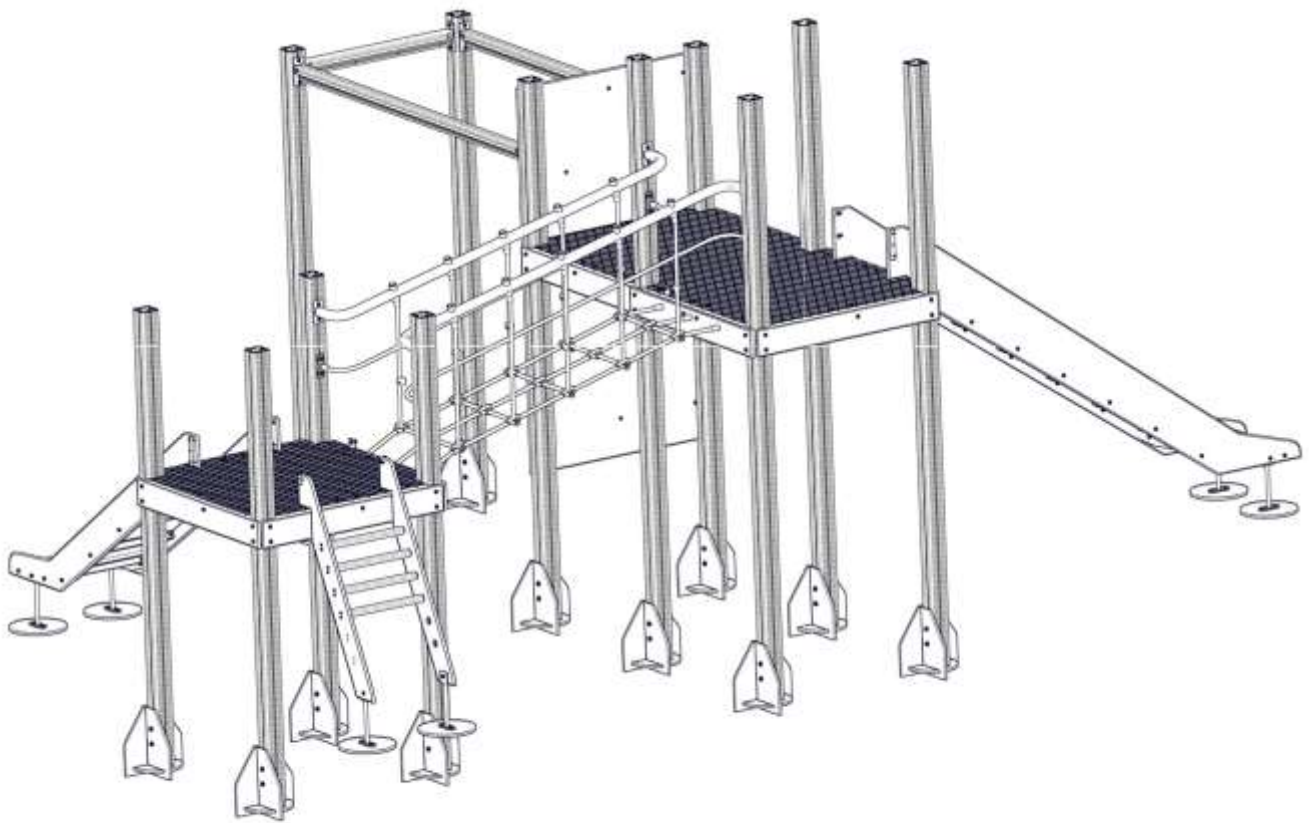

2x

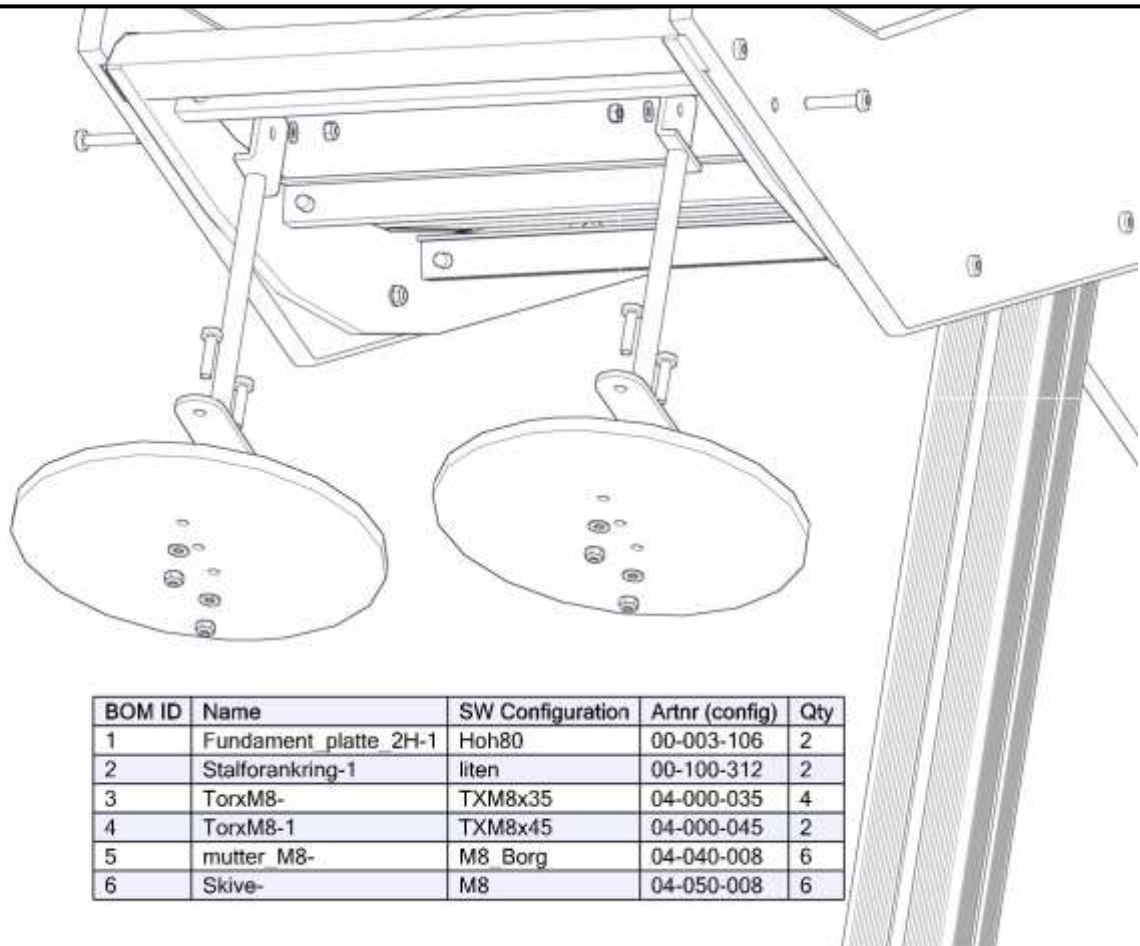

BOM ID	Name	SW Configuration	Artnr (config)	Qty
1	Fundament platte 2H-1	Hoh80	00-003-106	2
2	Stalforankring-1	liten	00-100-312	2
3	TorxM8-	TXM8x35	04-000-035	4
4	TorxM8-1	TXM8x45	04-000-045	2
5	mutter M8-	M8 Borg	04-040-008	6
6	Skive-	M8	04-050-008	6

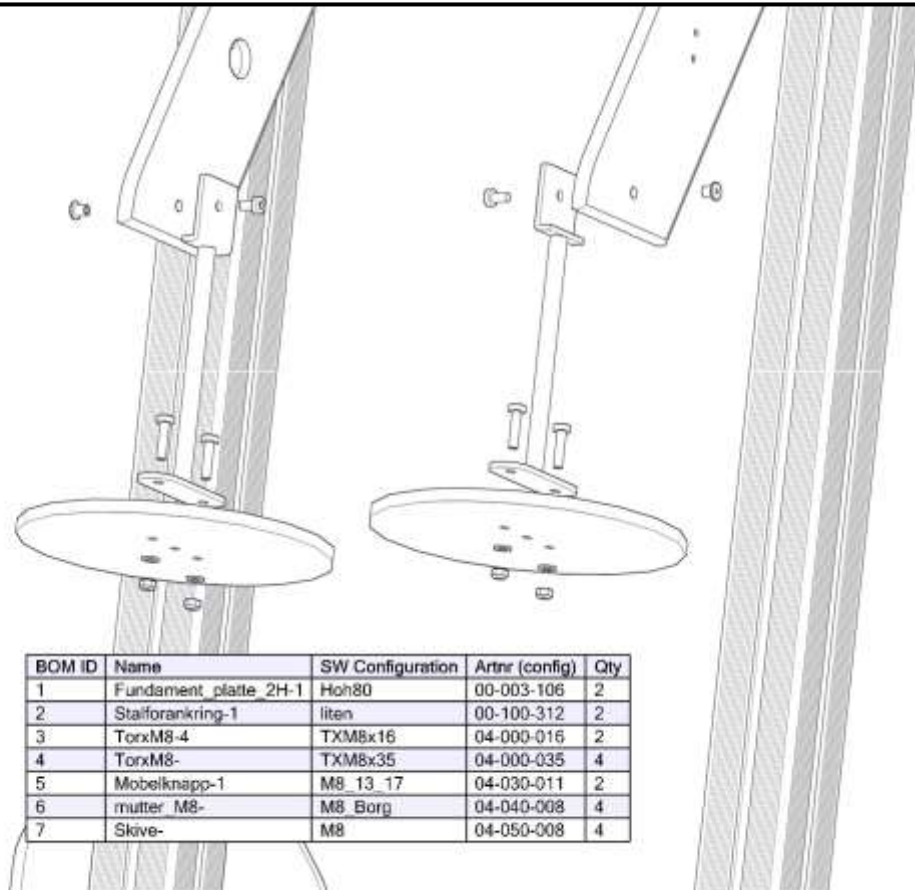

BOM ID	Name	SW Configuration	Artnr (config)	Qty
1	Fundament_platte 2H-1	Hoh80	00-003-106	2
2	Stålforankring-1	liten	00-100-312	2
3	Torxm8-4	TXM8x16	04-000-016	2
4	Torxm8-	TXM8x35	04-000-035	4
5	Mobelknapp-1	M8_13_17	04-030-011	2
6	mutter M8-	M8 Borg	04-040-008	4
7	Skive-	M8	04-050-008	4

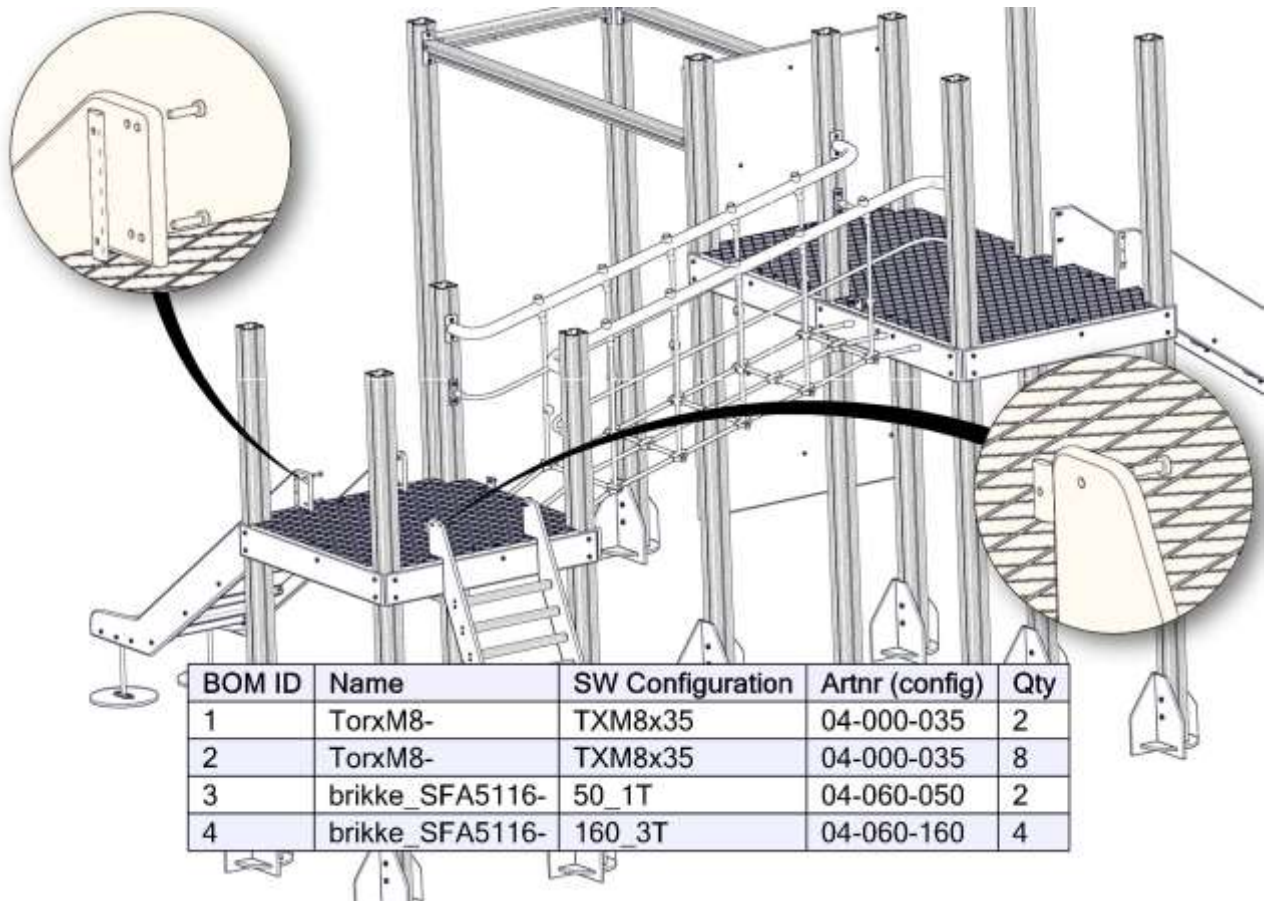

BOM ID	Name	SW Configuration	Artnr (config)	Qty
1	Torxm8-	TXM8x35	04-000-035	2
2	Torxm8-	TXM8x35	04-000-035	8
3	brikke_SFA5116-	50_1T	04-060-050	2
4	brikke_SFA5116-	160_3T	04-060-160	4

3x

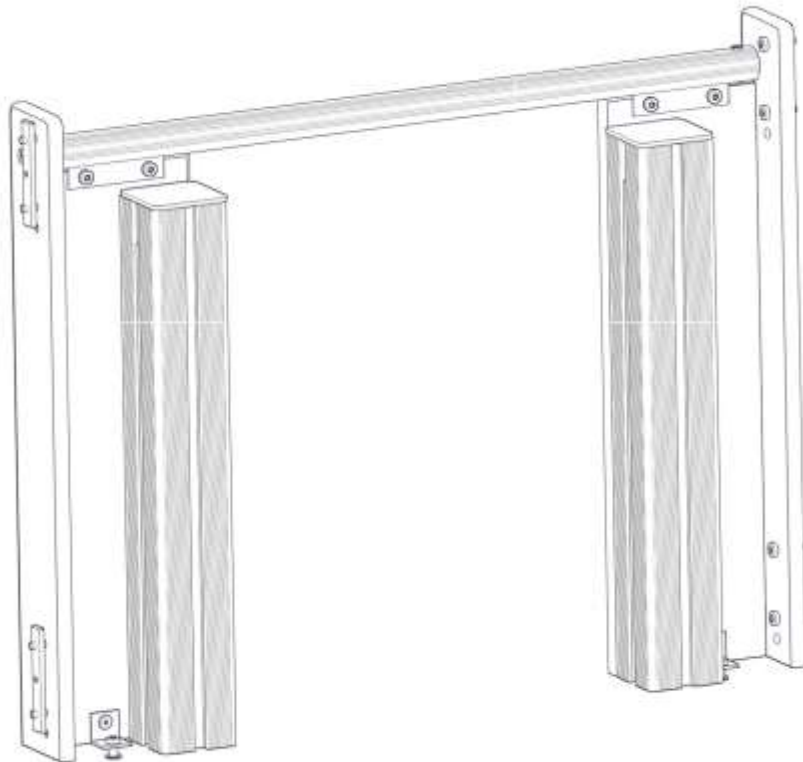

3x

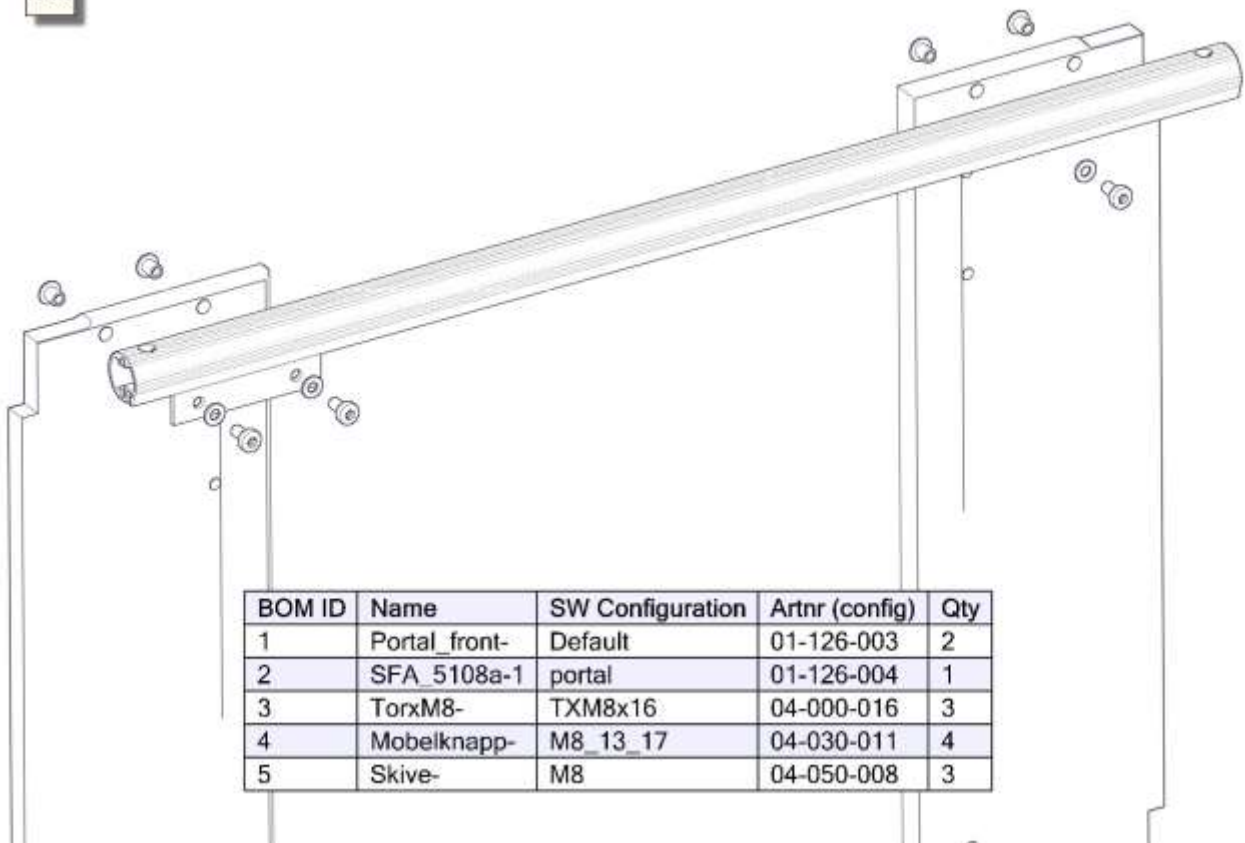

BOM ID	Name	SW Configuration	Artnr (config)	Qty
1	Portal_front-	Default	01-126-003	2
2	SFA_5108a-1	portal	01-126-004	1
3	TorxM8-	TXM8x16	04-000-016	3
4	Mobelknapp-	M8_13_17	04-030-011	4
5	Skive-	M8	04-050-008	3

3x

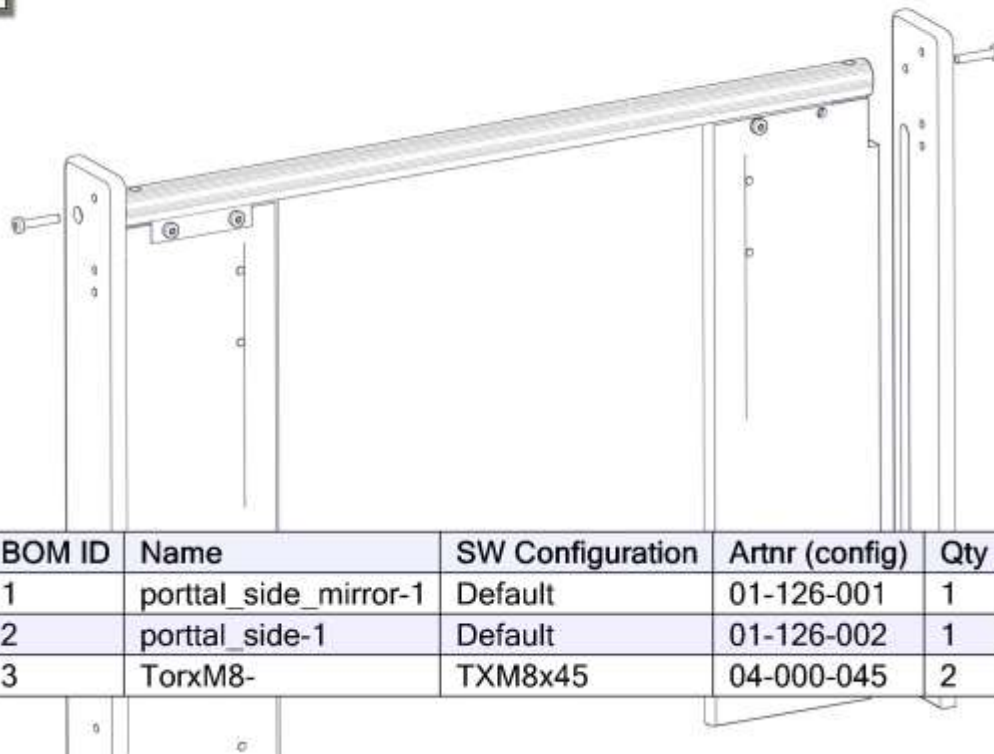

3x

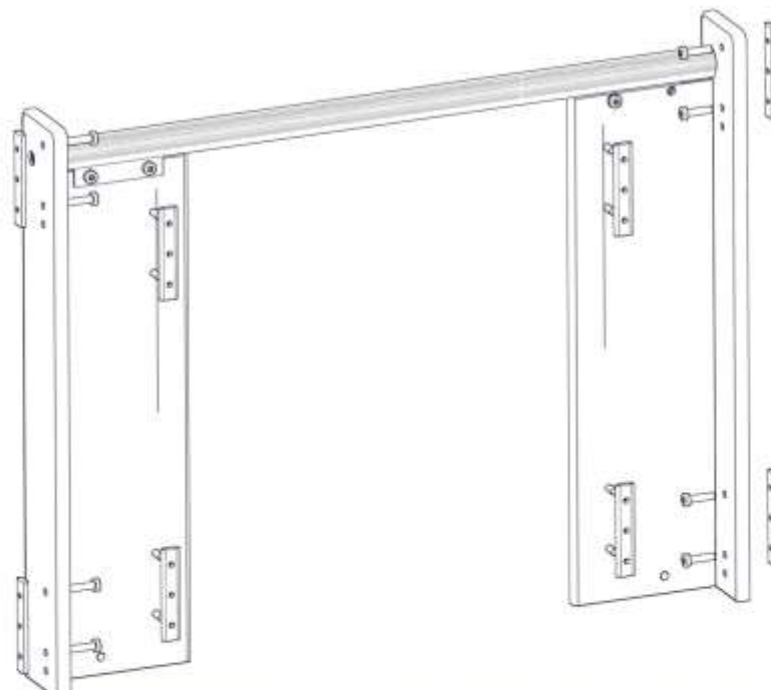

BOM ID	Name	SW Configuration	Artnr (config)	Qty
1	Torxm8-	TXM8x35	04-000-035	16
2	brikke_SFA5116-1	120_3T	04-060-120	8

3x

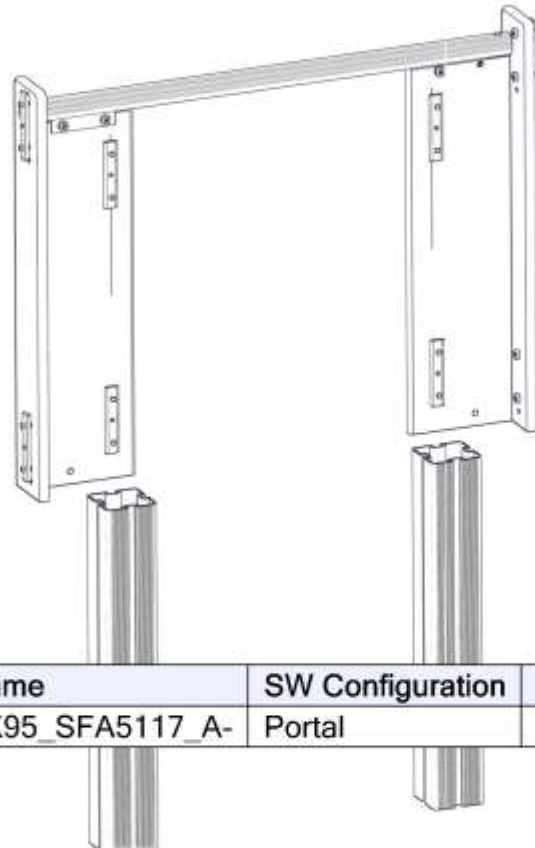

BOM ID	Name	SW Configuration	Artnr (config)	Qty
1	VK95_SFA5117_A-	Portal	00-400-009	2

3x

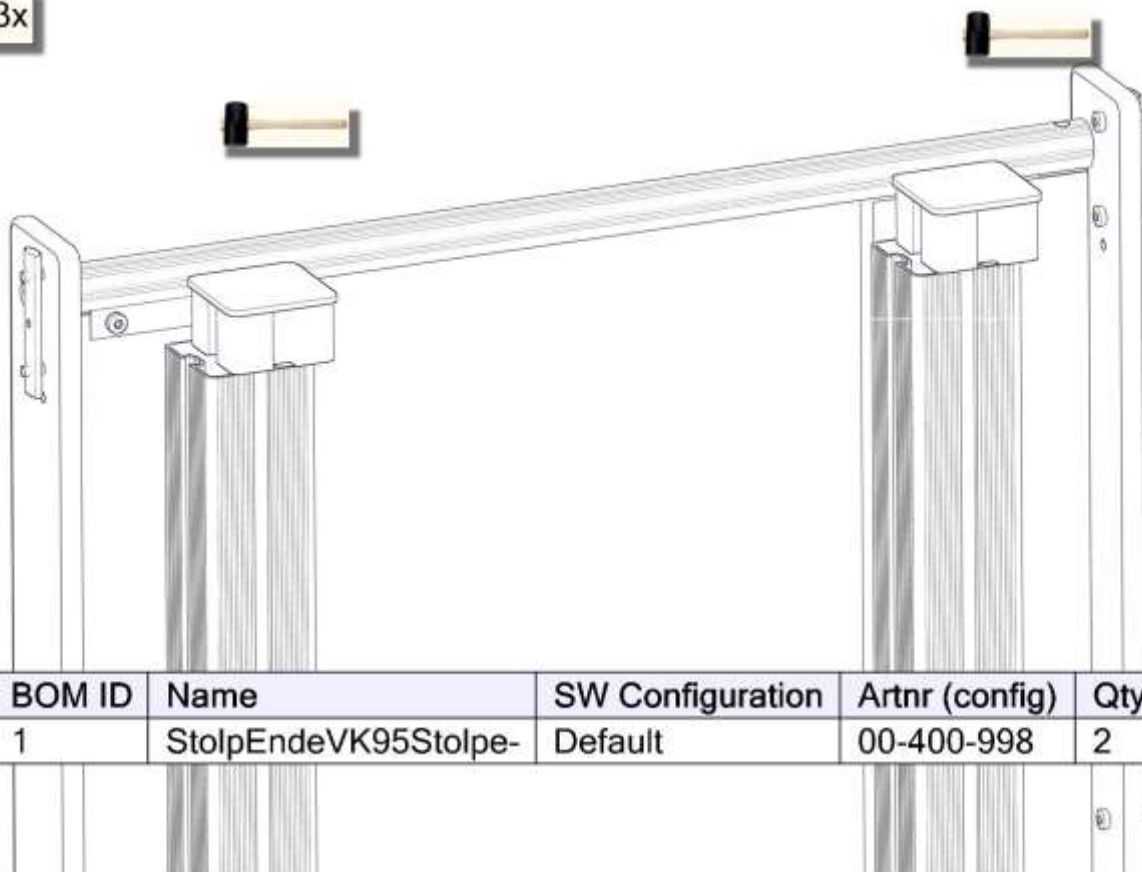

BOM ID	Name	SW Configuration	Artnr (config)	Qty
1	StolpEndeVK95Stolpe-	Default	00-400-998	2

3x

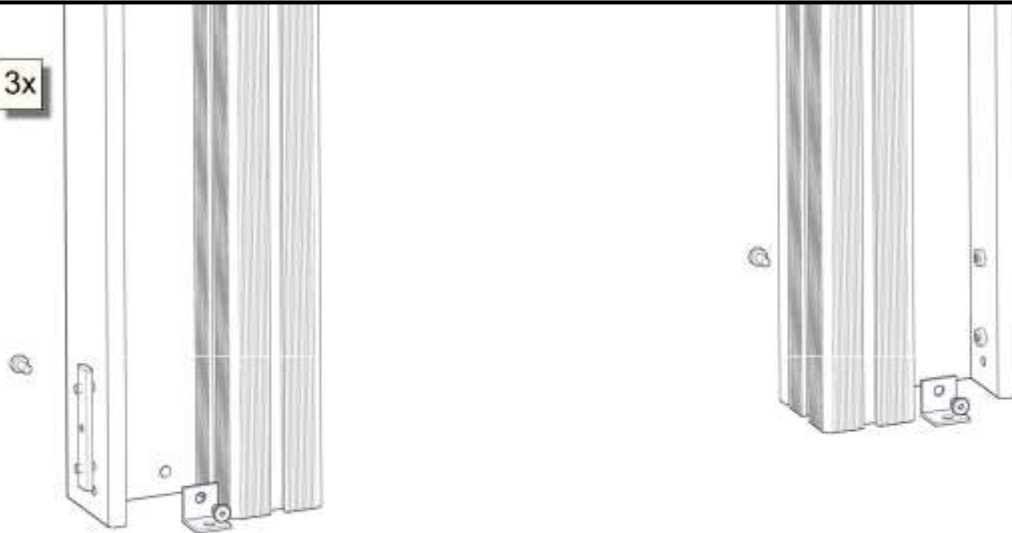

BOM ID	Name	SW Configuration	Artnr (config)	Qty
1	TorxM8-	TXM8x16	04-000-016	2
2	Mobelknapp-	M8_13_17	04-030-011	2
3	35x35x3-	11mm	04-070-036	2

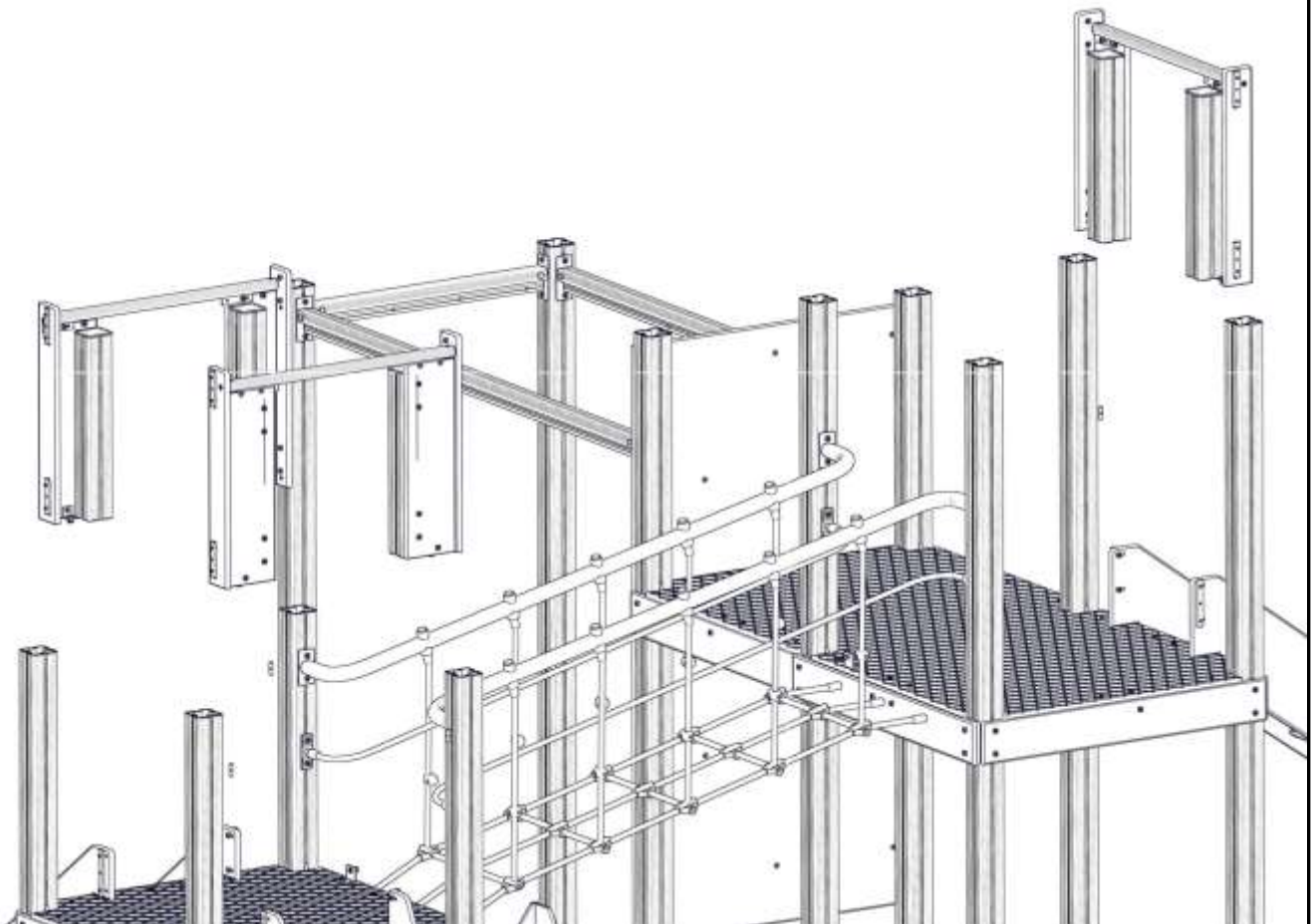

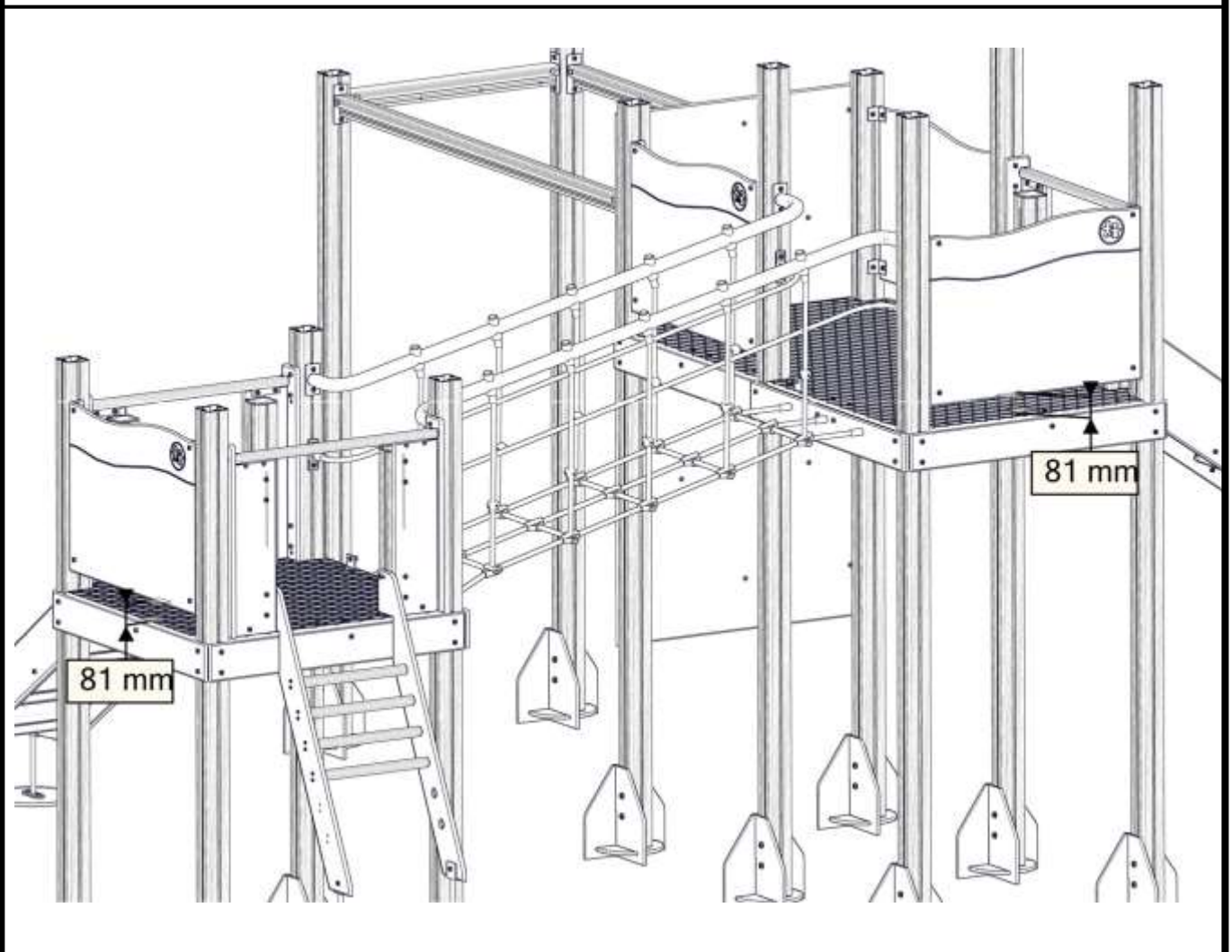
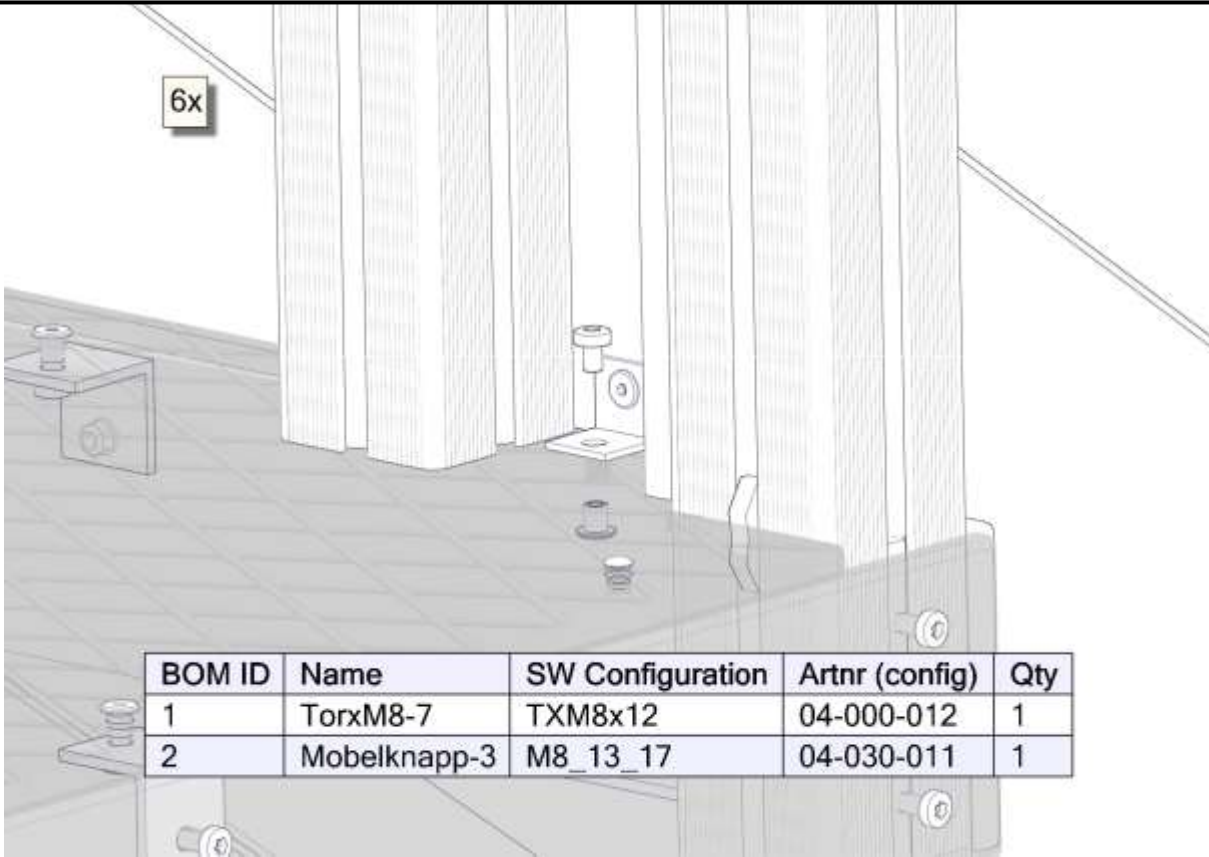

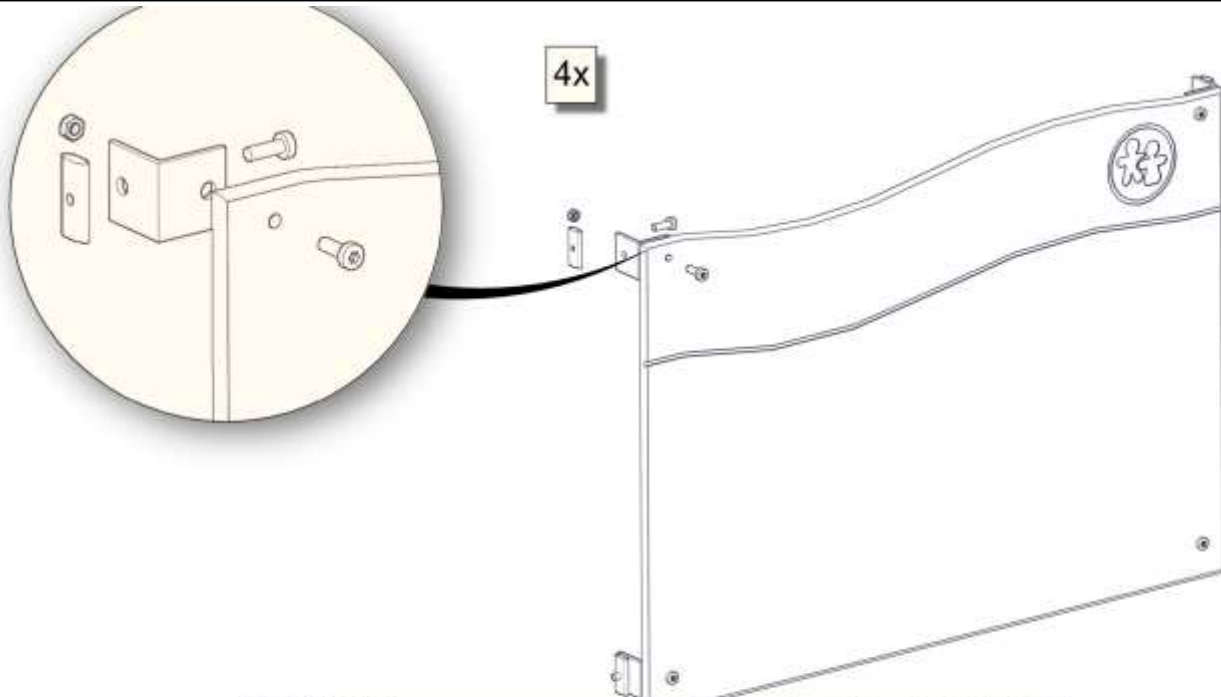

BOM ID	Name	SW Configuration	Artnr (config)	Qty
1	Vegge940x686x12-1	Default	01-125-002	1
2	TorxM8-	TXM8x25	04-000-025	8
3	mutter_M8-1	M8_Borg	04-040-008	4
4	brikke_SFA5116-1	50_1T	04-060-050	4
5	50x50x5-1	9mm_V	04-075-050	4

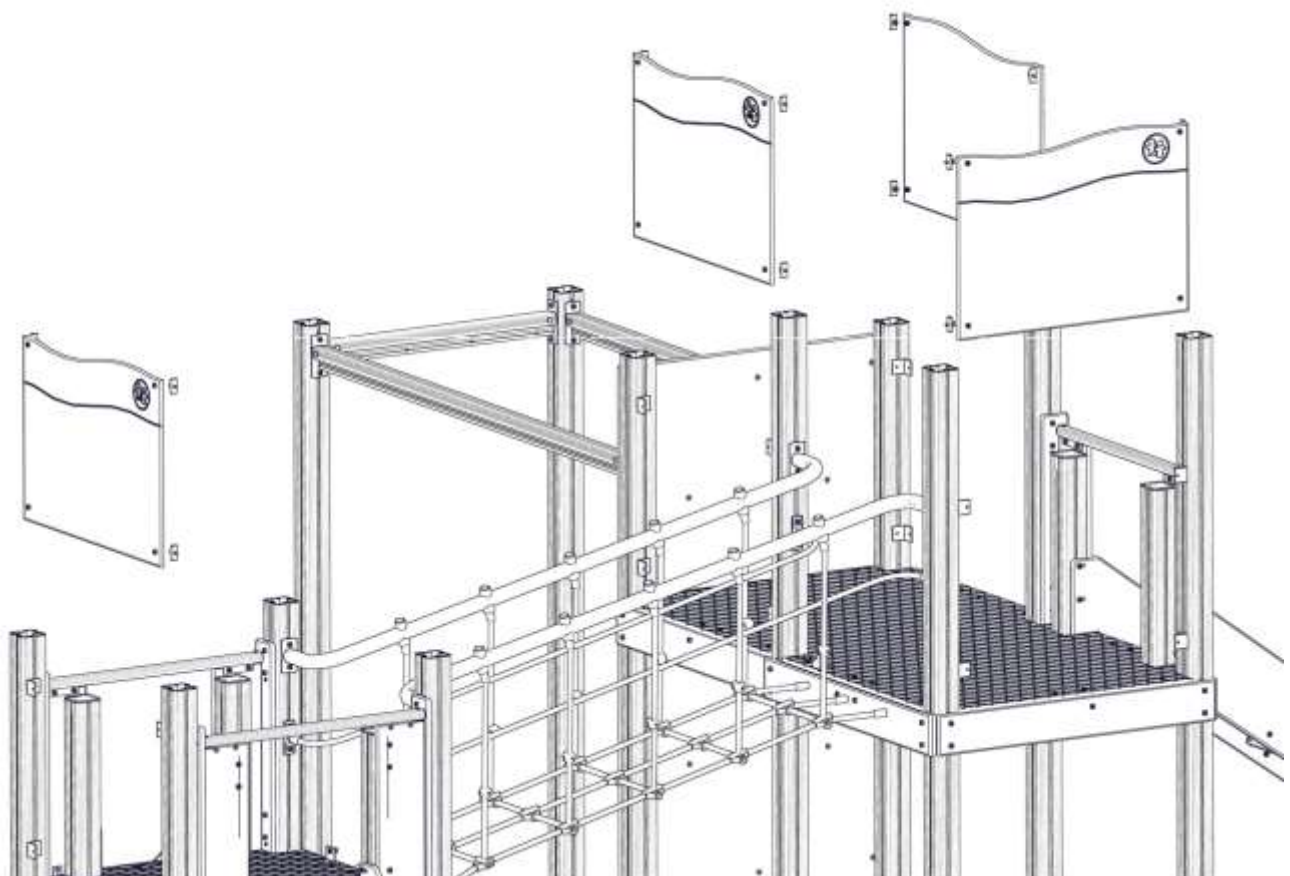

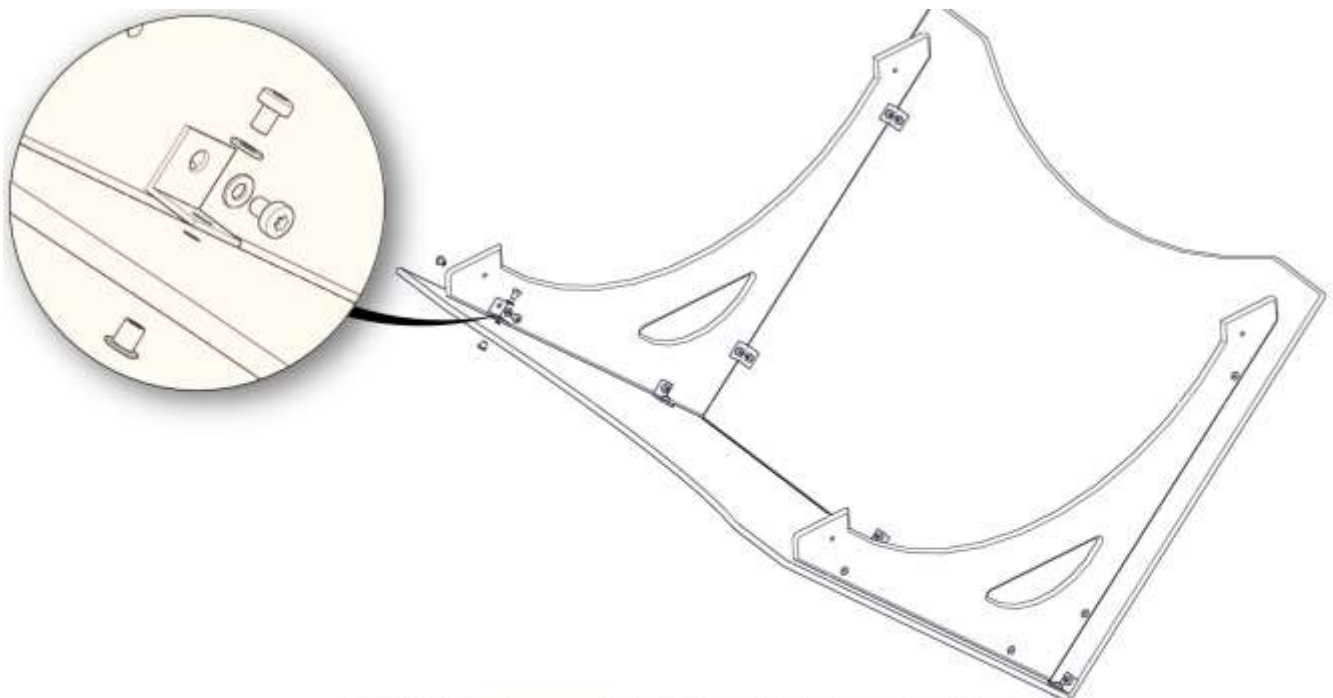
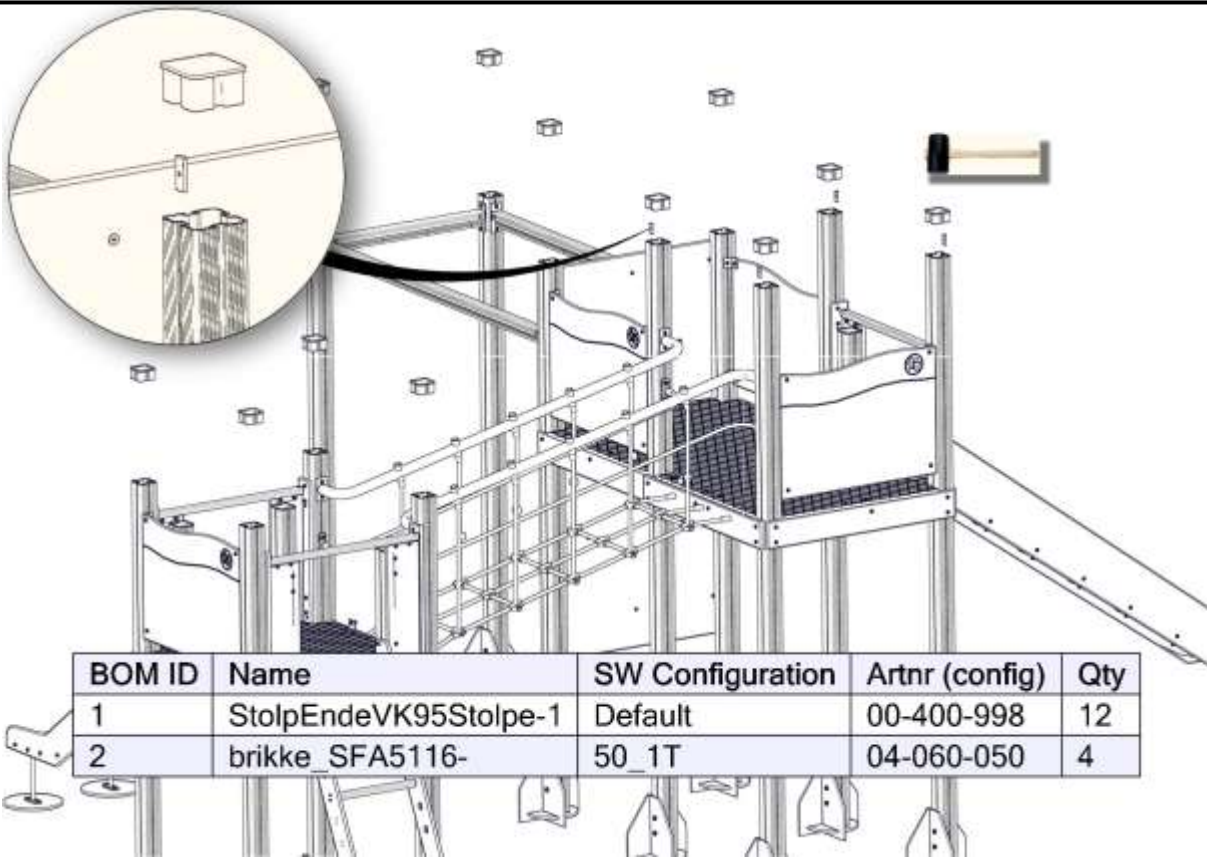

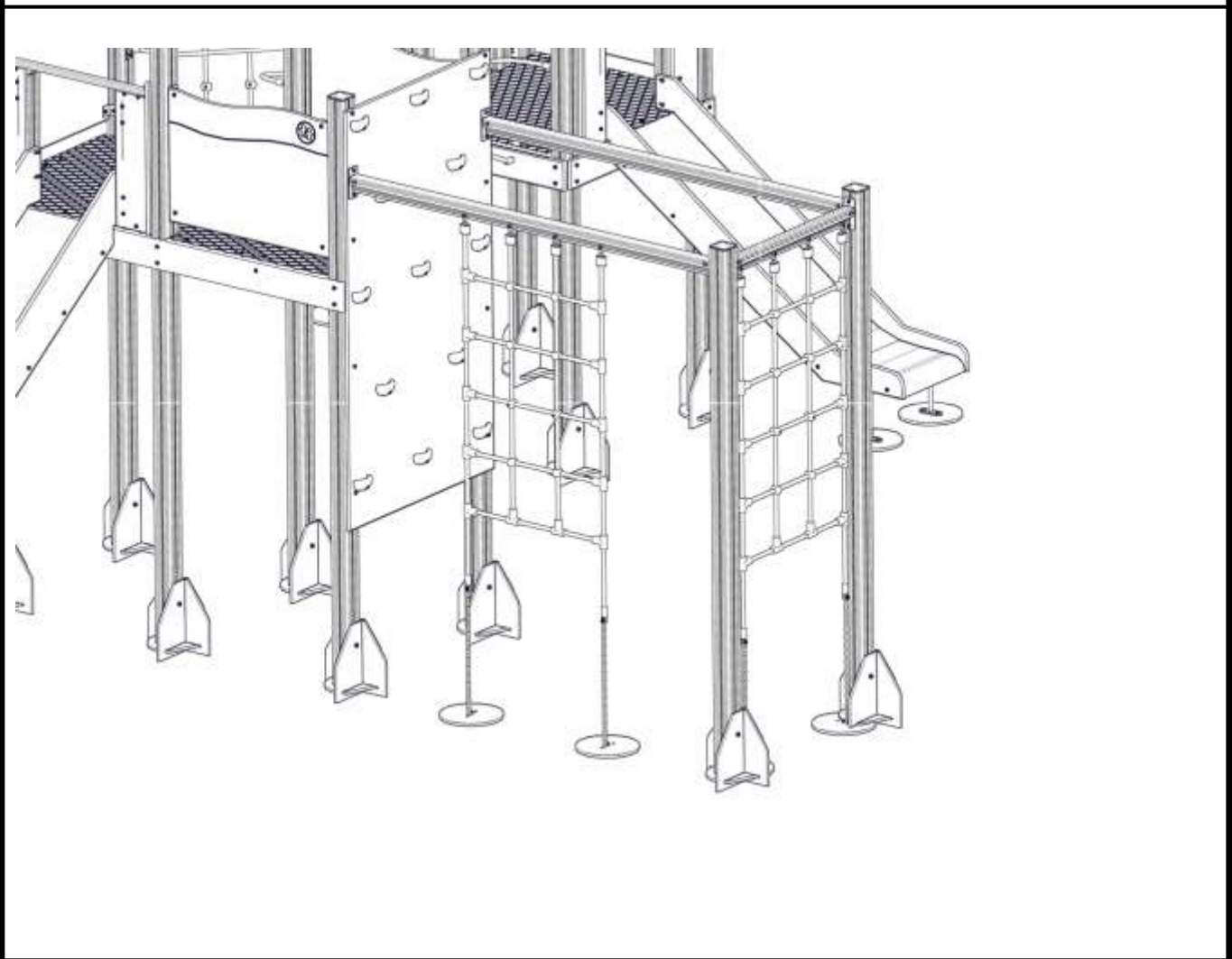
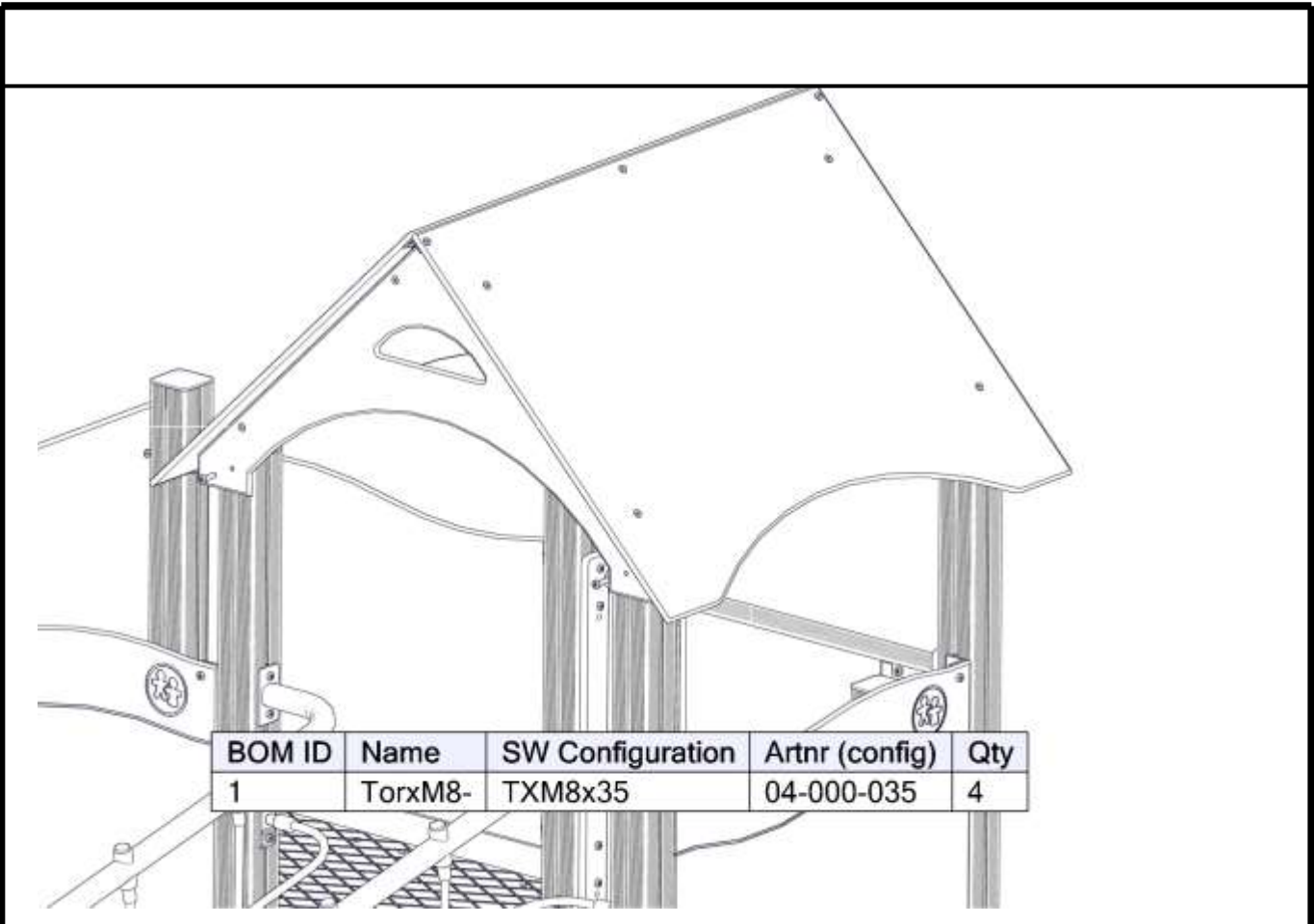

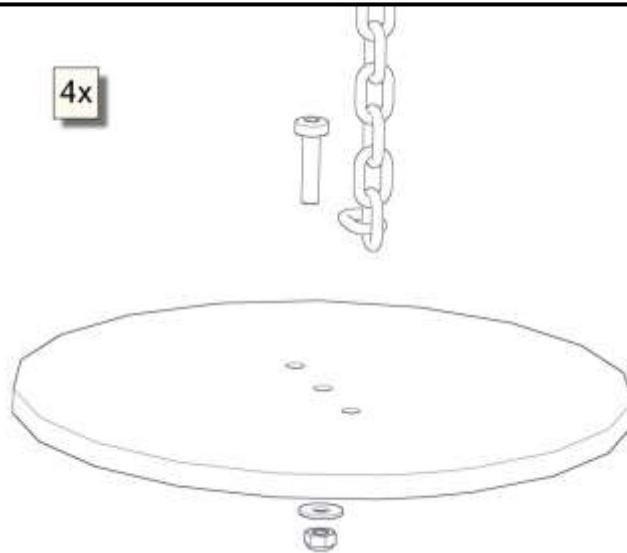



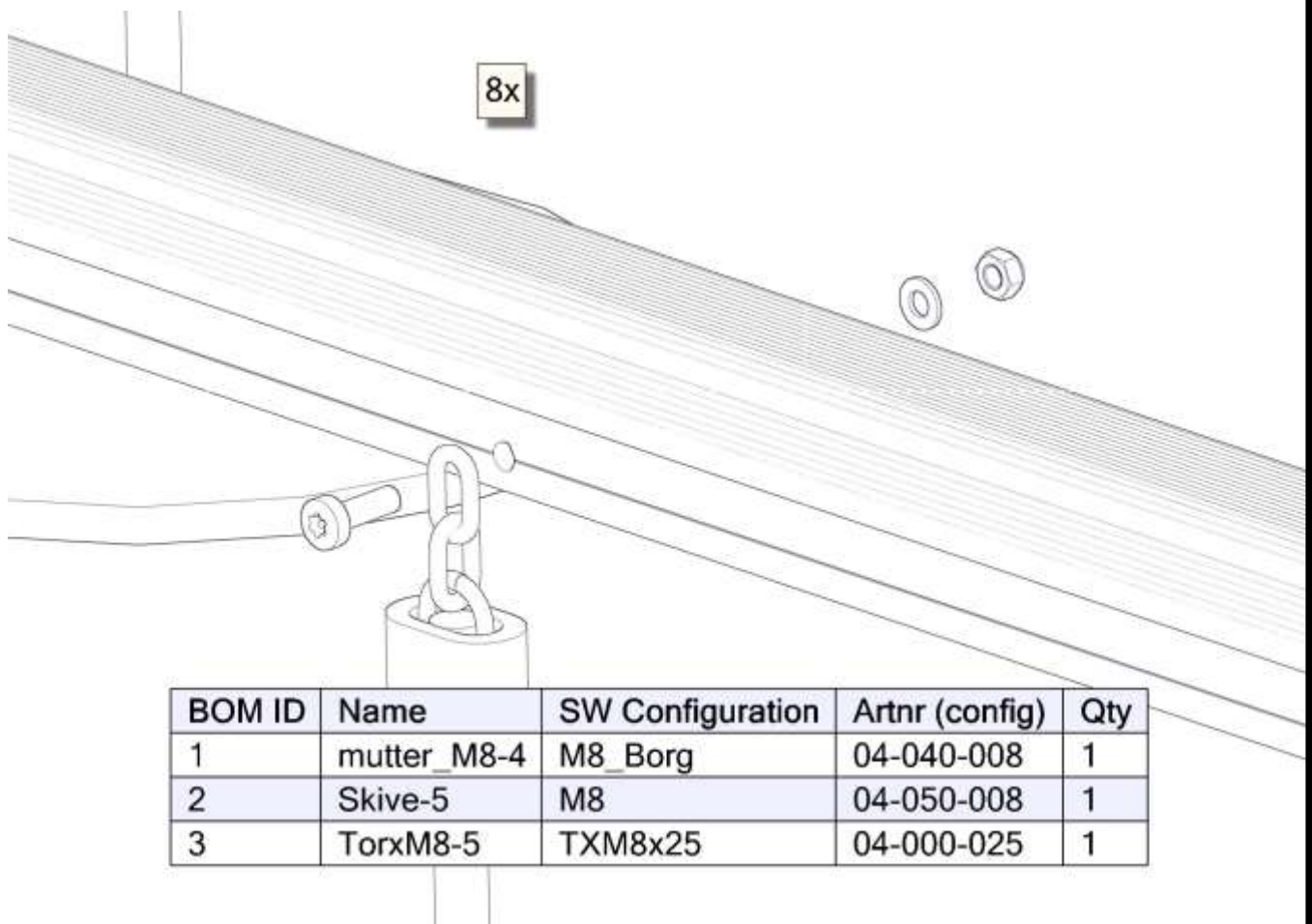







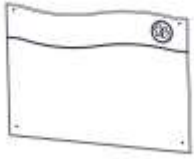



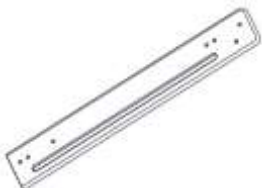



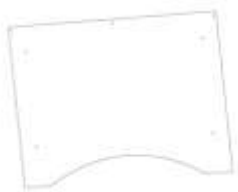



BOM ID	Name	SW Configuration	Artnr (config)	Qty
1	mutter_M8-5	M8_Borg	04-040-008	1
2	Skive-7	M8_stor	04-055-008	1
3	TorxM8-7	TXM8x35	04-000-035	1













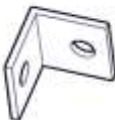

BOM ID	Name	SW Configuration	Artnr (config)	Qty
1	mutter_M8-4	M8_Borg	04-040-008	1
2	Skive-5	M8	04-050-008	1
3	TorxM8-5	TXM8x25	04-000-025	1

Før utstyret tas i bruk / Before play begins / Innan lekredskapet tas i bruk	
N	<ul style="list-style-type: none"> ● Påse at fallunderlag er utlagt i henhold til gjeldende regler eller vår anbefaling ● Fjern alle monteringshjelpemidler (rester av betong, planker, paller, plast, og lignende) ● Før utstyret tas i bruk, burde man sjekke at det ikke er fare for at anorakksnorer og lignende som kan hekte seg fast noen steder på lekeapparatet. (Vedlagte snor med dobbe (kneledd) kan brukes til å sjekke at dette er i orden. Se vedlagte veiledning for bruk av denne. Dette gjøres for å oppdage eventuelle feilmonteringer.?) ● NB! Bør stå i 2-3 dager før bruk
UK	<ul style="list-style-type: none"> ● Make sure the area and depth of safer surfacing are according to the current standard, or to the manufacturer's recommendation ● Make sure all tools and surplus materials are removed before play begins ● PS! When complete, allow 2-3 days for the concrete to set before use
S	<ul style="list-style-type: none"> ● Kontrollera att fallunderlag är utlagt enligt gällande regler eller vårt rekommendation ● Ta bort alla monteringshjälpmedel (rester av betong, plankor, pallar, plast och liknande) ● Innan lekredskapet används, kontrollera att anoracksnoddar eller kläder/delar av kläder eller liknande inte kan fastna i några delar på redskapet. (Den bipackade "knävringen" kan man med fördel användas för denna kontroll. ● Detta görs för att upptäcka eventuella felmonteringar.)

Boltepakker for / Boltpackage for / Bultpaket för		Sign. _____
	VK95 L=2445 4 600-1845 00-400-001	Gulv 1 1160x1160x15 00-400-300
	VK95 L=2600 2 600-2000 00-400-018	
	VK95 L=3225 4 600-2635 00-400-009	
	VK95 L=640 6 01-126-005	
	Vegg 4 940x686x12 01-125-002	Gulv dobbel 1 Klatrevegg 2180x1160x15 00-400- 351_CUT
	Sprosse 3 1130x145x15 Med hull poly- fix nett 01-400-112	Sprosse 1 2165x145x15 Med hull polyfix nett 01-400-205
	Sprosse 6 1130x145x15 01-400-108	Sprosse 1 2165x145x15 01-400-203
	MT-nett 2 05-079-015 Inkl Kjetting	Frontplate portal 6 01-126-003
	Sideplate portal 3 Høyre 01-126-001	Side plate portal 3 Venstre 01-126-002
	Sperrerør portal 3 01-126-004	

Boltepakker for / Boltpackage for / Bultpaket för			Sign. _____.		
	Tak 01-128-001	2		Gavel 01-128-002	2
	Ligger M-nett 00-400-814	1		Ligger 00-400-816	1
	Ligger Kort M-nett 00-400-815	1		Stig 950 00-400-615	1
	Systembane 1400 40-142-101	1		Systembane 950 40-142-020	1
	Klatrevegg Inkl stolpe 00-400-772 Lengde stolpe L=2900	1		Nett brua Skrå 07-500-042	1
	Rør skrå høyre 07-200-026	1		Rør skrå venstre 07-200-025	1
	Fundament-plate 3H 80 00-003-106	10		Eventuelt Fundamenter	12

Boltepakker for / Boltpackage for / Bultpaket för			Sign. _____		
	Torx M8x12 04-000-012	18		Brikke 50-1T 04-060-050	22
	Torx M8x16 04-000-016	20		Brikke 120-3T 04-060-120	32
	Torx M8x25 04-000-025	60		Brikke 160-3T 04-060-160	9
	Torx M8x30 04-000-030	14		Vinkel 35x35x35 04-070-036	17
	Torx M8x35 04-000-035	110		Vinkel 50x50x50 04-075-050	24
	Torx M8x45 04-000-045	14		Stålforankring 00-100-310	6
	Torx M8x50 04-000-050	8			
	Møbelknapp M8x13x17 04-030-011	50		Hylsemutter M8 12-38 04-018-060	6
	Plast rondell 05-300-036	10		Plast rondell 05-300-036	20
	Plast plug 9-11mm 04-090-002	48		Plug spor 00-400-980	22
	Skive M8 04-050-008	70		Låsemutter M8 04-040-008	60
	Skive M8 04-055-008	14		Låsemutter M10 04-040-010	10
	Skive M10 Poly 04-055-036	20			