

N

Monteringsanvisning

EN

Assembly Instructions

S

Monteringsanvisning

Produkt nr. / Product no. / Produkt nr.

11-500-020**Blå/ Pistasj**

Ord. nr. _____

Dato. _____

Sign. _____

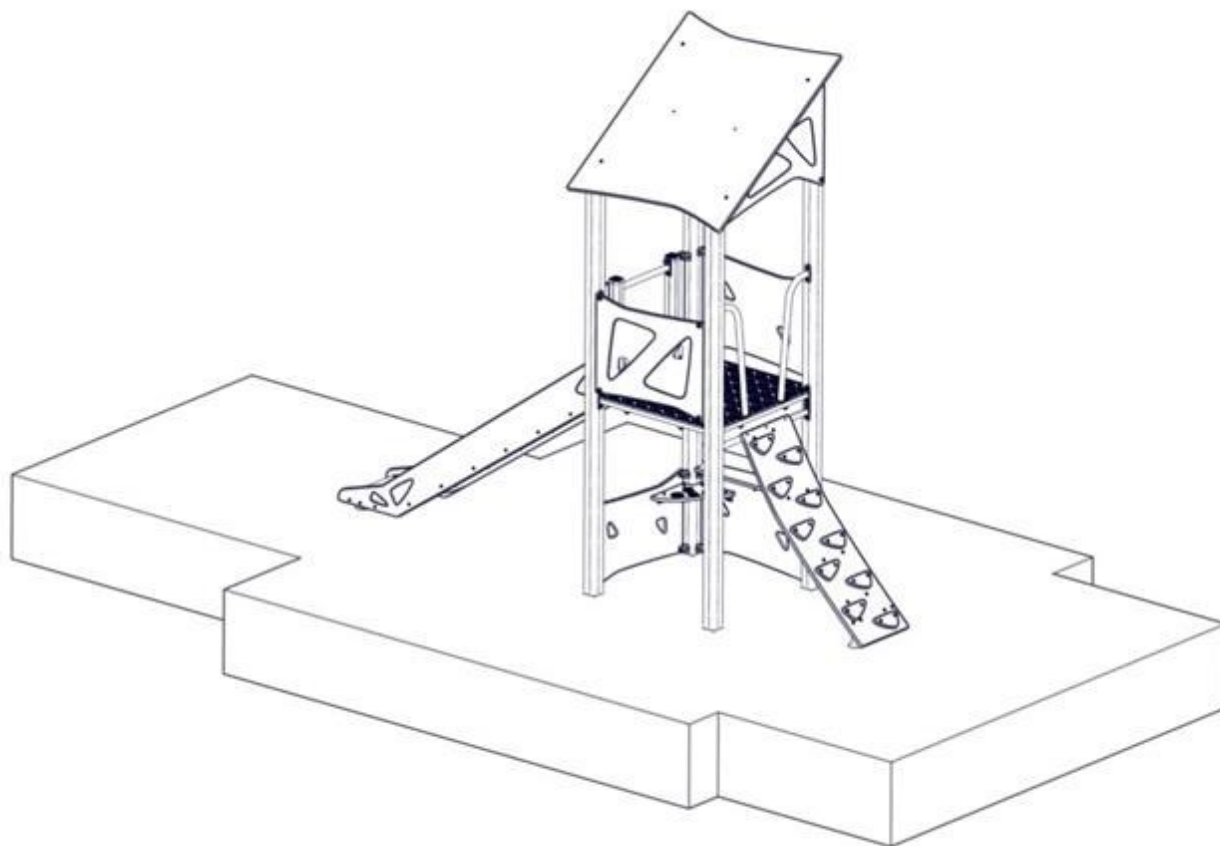
**søve**

Søve AS
Grønnvoldveien 290
3830 Ulefoss - Norway
Tlf: +47 35 94 65 65
www.sove.no

**søve**

Søve AB
EA Rosengrensgatan 32
421 31 Västra Frölunda
Phone: +46 (0)31 773 97 00
www.sove.se

Monteringstips / Assembly Advice / Monteringsstips

N

- Les monteringsanvisningen nøye før montering.
- Monter elementene i rekkefølgen som vist.
- Boltene bør ikke skrues for hardt til før alt er montert, vatret og loddet. Skru så boltene til.
- NB! Ved bruk av drill, kan boltene ryke.
- På grunn av at solen kan gjøre rutsjeflaten veldig varm, bør rutsjebanens utløp vende mot nord-øst eller nord-vest.
- Er lekeutstyret plassert i naturlige ferdselstraséer må området sikres mot gjennomgang.
- Innspringningshinder bør vurderes rundt lekeapparater hvor det er stor bevegelse, f.eks. ved huskestativ.
- Det bør være fritt innsyn til lekeutstyr som er beregnet for barn under 3 år.

NB! Under monteringsarbeidet må utstyr, som ikke er forankret forsvarlig i bakken, sikres slik at det ikke velte.

Området må avstenges under montering av apparatene med sperrebånd eller lignende.

EN

- Read the instruction carefully before assembling the play unit.
- Assemble the components in the sequence shown in these instructions.
Fixings must not be fully tightened during assembly. Before casting the foundations, the structure must be level and plumb, at which point all fixings are tightened.
PS! If use of drill, the bolts may be wrecked.
- Avoid positioning the slide facing due south because of overheating – ideal positions are facing north-east or north-west.
Secure the construction-area to prevent people from walking through it.
- Consider installing barriers around play-equipment which gives rise to a lot of activity – i.e. swings.
- Ensure that clear vision is possible across the play area so that supervision is possible from any position, particularly where children under 3 years of age will be playing.

NB! During assembly of the equipment, ensure that all structures are securely propped, especially when left overnight. Also ensure that equipment is supported

Monteringstips / Assembly Advice / Monteringsstips**S**

- Läs monteringsanvisningen noga före montering.

- Montera delarna i den ordningen som anvisas
- Skruvarna bör inte skruvas för hårt tills allt är monterat, i våg och lodat.











OBS! Används elektrisk skruvdragare, kan bulten gå sönder. Hårdra därför manuellt!

- Solen kan göra att rutchbanan blir väldigt varm. Banans nedfart rekommenderas att vändas i norrlig riktning
- Om lekplatsen placeras vid en gångväg mm bör området säkras mot genomfart av gående och cyklister.
- Insprängningshinder bör placeras runt lekutrustning med stor rörelse, t ex, gungställning.
- Det bör vara fri insyn till lekutrustning beräknat till barn under 3 år.

OBS! Under monteringsarbete bör utrustningen som inte ska förankras i marken, ställs så att den inte kan välta.

Området måste spärras när lekutrustningen byggs upp, med avspärrningsband eller liknande.

Nødvendig verktøy / Tools required / Nödvändiga verktyg

<p>(N)</p> <p>(EN)</p> <p>(S)</p>	<p>(A)</p> 	<p>(B)</p>  <p>Torx Nr 45</p> 	<p>(C)</p> <p>5 mm 6 mm</p> 	<p>(D)</p> 	<p>(E)</p> 
		<p>Metermål Metric measure Tumstock</p> 	<p>Ø11mm Bor Ø11mm Drill Ø11mm Borr</p> 	<p>Merkebånd Mark ribbon Märkeband</p> 	<p>13 + 17mm</p> 

Nødvendig antall personer / Number of persons required / Rekommenderad antal personer





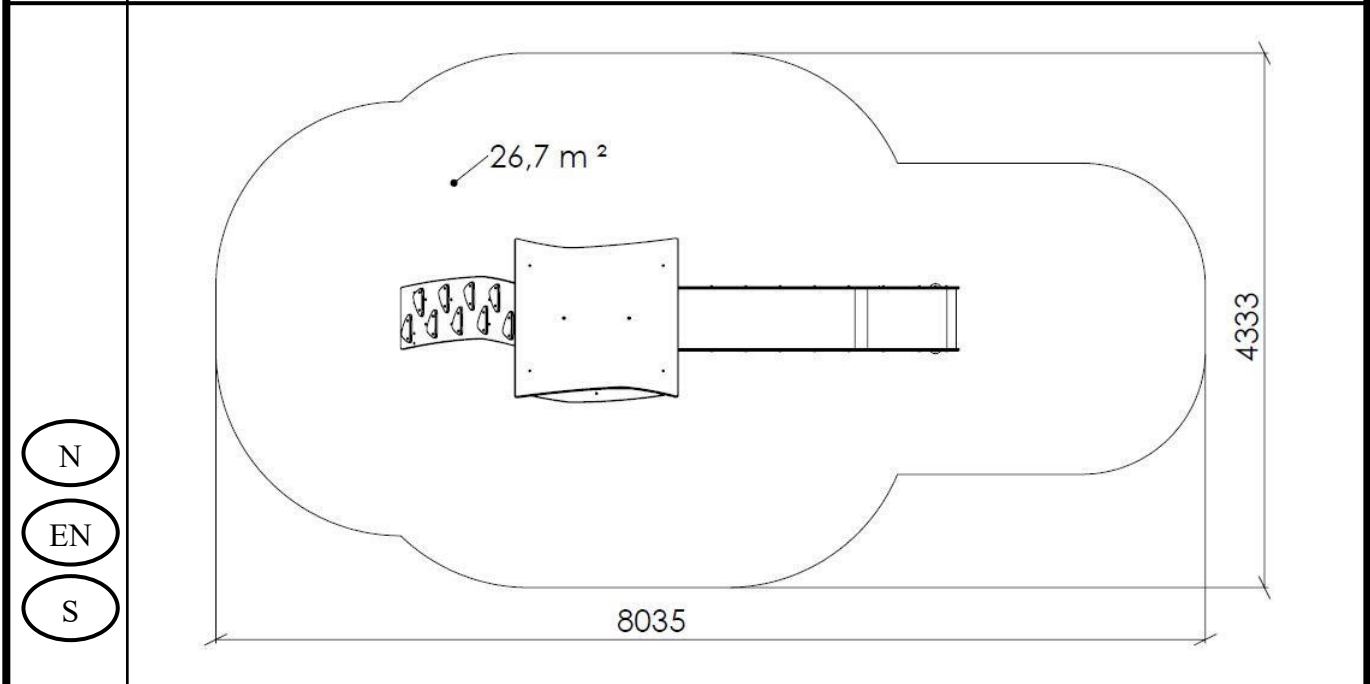

Anbefalt arealbehov ved montering / Recommended working space / Rekommenderad arealbehov ved montering



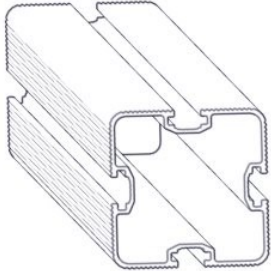
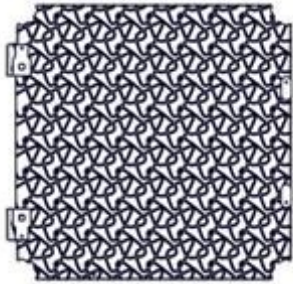



Boltepakker for / Boltpackage for / Bultpaket för

Sign. _____

Saturn Greip 11-500-020	Navn	Artnr/dimensjon	Ant	Lev
	Stolpe 95x95 skrå 55 Lengde = 3600 Sort	SFA5117/1	2	
	Stolpe 95x95 skrå 55 Lengde = 4325 Sort	SFA5117/1	2	
	Gulv 1075x1115x15 Portal-0-1-0	07-300-201	1	
	Produktmerke	00-100-400 (Montert hos Søve)	0	
	Sperrerør for gulv Lengde = 940 2 hull cc470 Sort	07-300-230	3	
	Sperrerør for gulv Lengde = 940 2 hull cc735 for portal Sort	07-300-232	1	
	Torx M8x25	04-000-025	16	

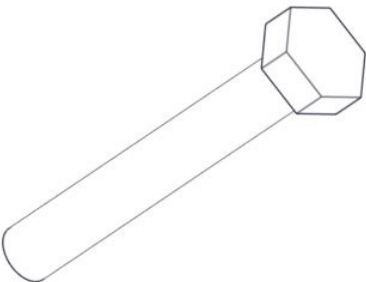
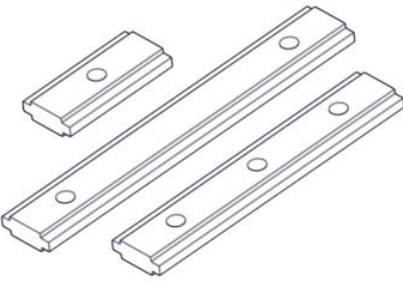

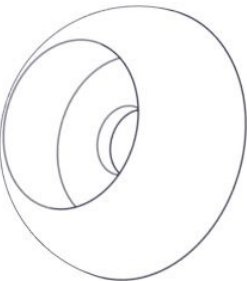
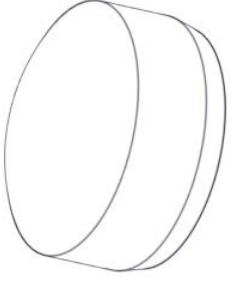
Boltepakker for / Boltpackage for / Bultpaket för

Sign. _____

Saturn Greip 11-500-020	Navn	Artnr/dimensjon	Ant	Lev
	Sekskant M8x55	04-008-055	8	
	Brikker 120 3xM8	04-060-120 (montert hos Søve)	0	
	Møbelknapp M8x11	04-030-011	8	
	Sikkerhets hette kropp	05-301-045	8	
	Sikkerhets hette topp	05-301-044	8	
	Avstandsskive for Ø38	04-210-010	8	



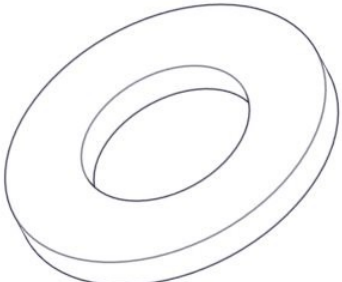
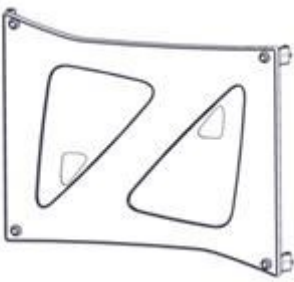
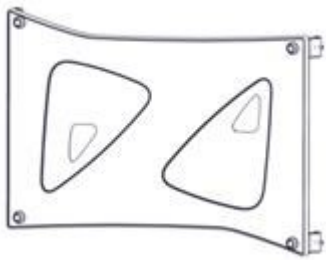
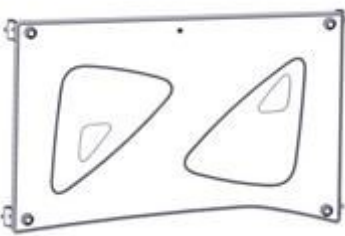

Boltepakker for / Boltpackage for / Bultpaket för

Sign. _____

Saturn Greip 11-500-020	Navn	Artnr/dimensjon	Ant	Lev
	Skive M8	04-050-008	8	
	Rekkverk 715x940x19 Blå/ pistasj	07-300-241K (se egen del- montering)	2	
	Rekkverk 600x940x19 Blå/ pistasj	07-300-243K (se egen del- montering)	1	
	Rekkverk butikkdisk 600x940x19 Blå/ pistasj	07-300-244K (se egen del- montering)	1	
	Butikkdisk 1122x200x19 Blå/ pistasj	07-300-290K (se egen del- montering)	1	
	Kokeplate Blå/ pistasj	07-300-292K (se egen del- montering)	1	

Boltepakker for / Boltpackage for / Bultpaket för

Sign. _____.

Saturn Greip 11-500-020	Navn	Artnr/dimensjon	Ant	Lev
	Tak Blå/ pistasj	07-300-250K (se egen del- montering)	1	
	Sluse 900x305x38 Pistasj	07-300-333K (se egen del- montering)	1	
	Rutsjebane inkl.portal H=1.4m Blå/ pistasj	07-300-416K (se egen del- montering)	1	
	Opptrekkplate Blå/ pistasj	07-300-320K (se egen del- montering)	1	

Boltepakker for / Boltpackage for / Bultpaket för

Sign. _____

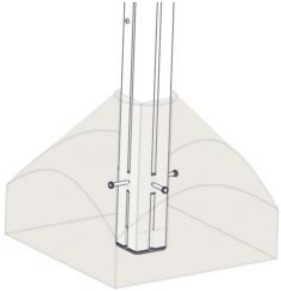
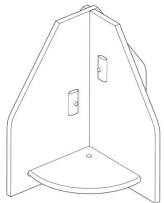
Saturn Greip 11-500-020	Navn	Artnr/ dimensjon	Ant	Lev
	Fundament Støp			
	Støpefundament 95 x 95 stolpe	00-003-110K (se egen del- montering)	4	
	Fundament Nedgravning			
	Nedgravings fundament 95 x 95 Stolpe	00-003-004K (Se egen del- montering)	4	

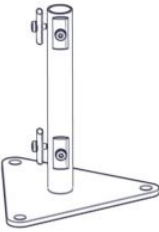
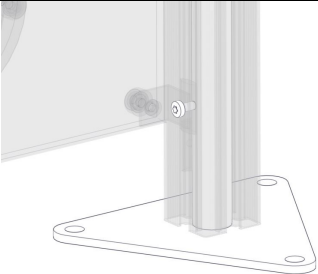
Boltepakker for / Boltpackage for / Bultpaket för		Sign. _____.		
Saturn Greip 11-500-020	Navn	Artnr/ dimensjon	Ant	Lev
	For overflate montering			
	Fundament stolpe for betong- dekke 95x95	00-003-125K (se egen del- montering)	4	
	Fundament kortere boltfeste	00-003-132K (Se egen del- montering)	4	
	Changed part foundations 07-300-416K 07-300-320K Stolpe må kappes		2 2 4	

Fundamentering med betong // Foundation concrete // Förankring med betong

- (N) Komprimert masse Ref NS-EN 1176-1
- (EN) Compressed mass §4.2.8.5
- (S) Komprimerad massa



- (N) Bakkenivå
- (EN) Ground level
- (S) marknivå

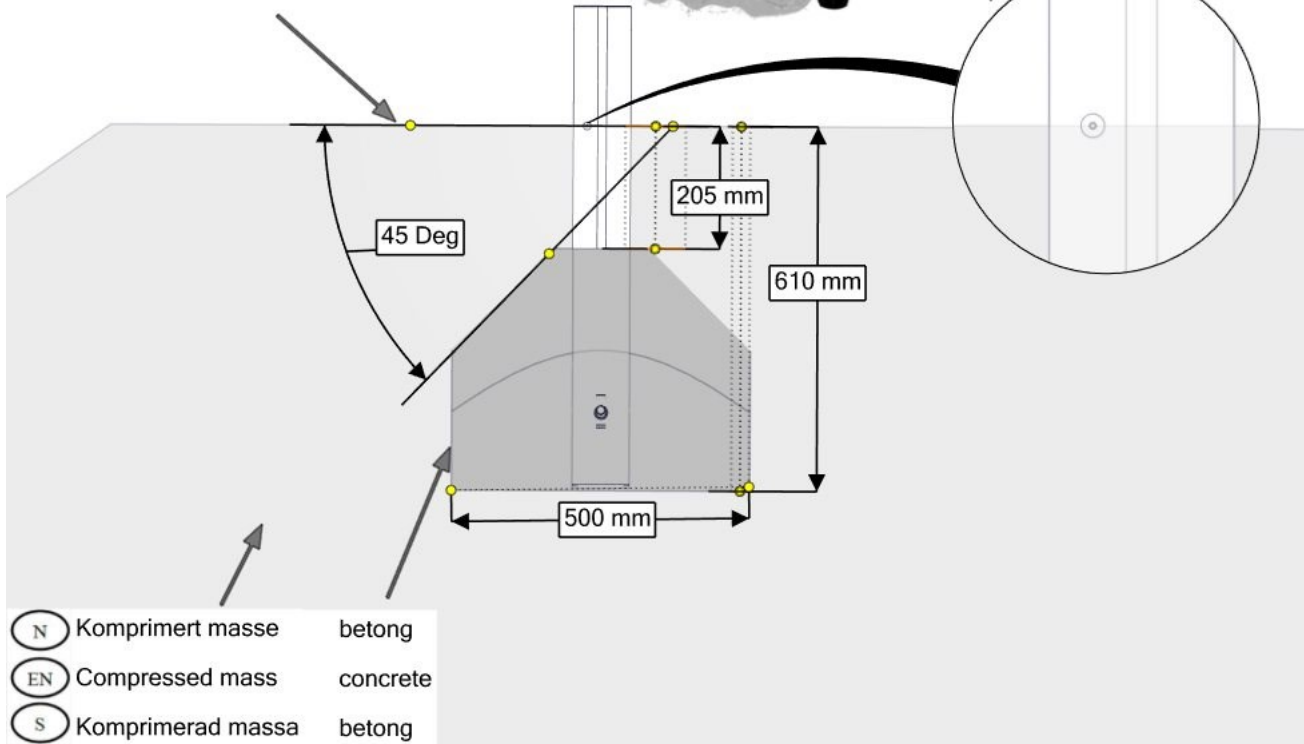

- (N) Komprimert masse betong
- (EN) Compressed mass concrete
- (S) Komprimerad massa betong

Fundamentering uten betong // Foundation without concrete // Förankring utan betong

- (N) Støtdempende materialer Ref NS-EN 1176-1
- (EN) Impact attenuating materials §4.2.8.5
- (S) Støtdämpande material

- (N) Bakkenivå
- (EN) Ground level
- (S) Marknivå

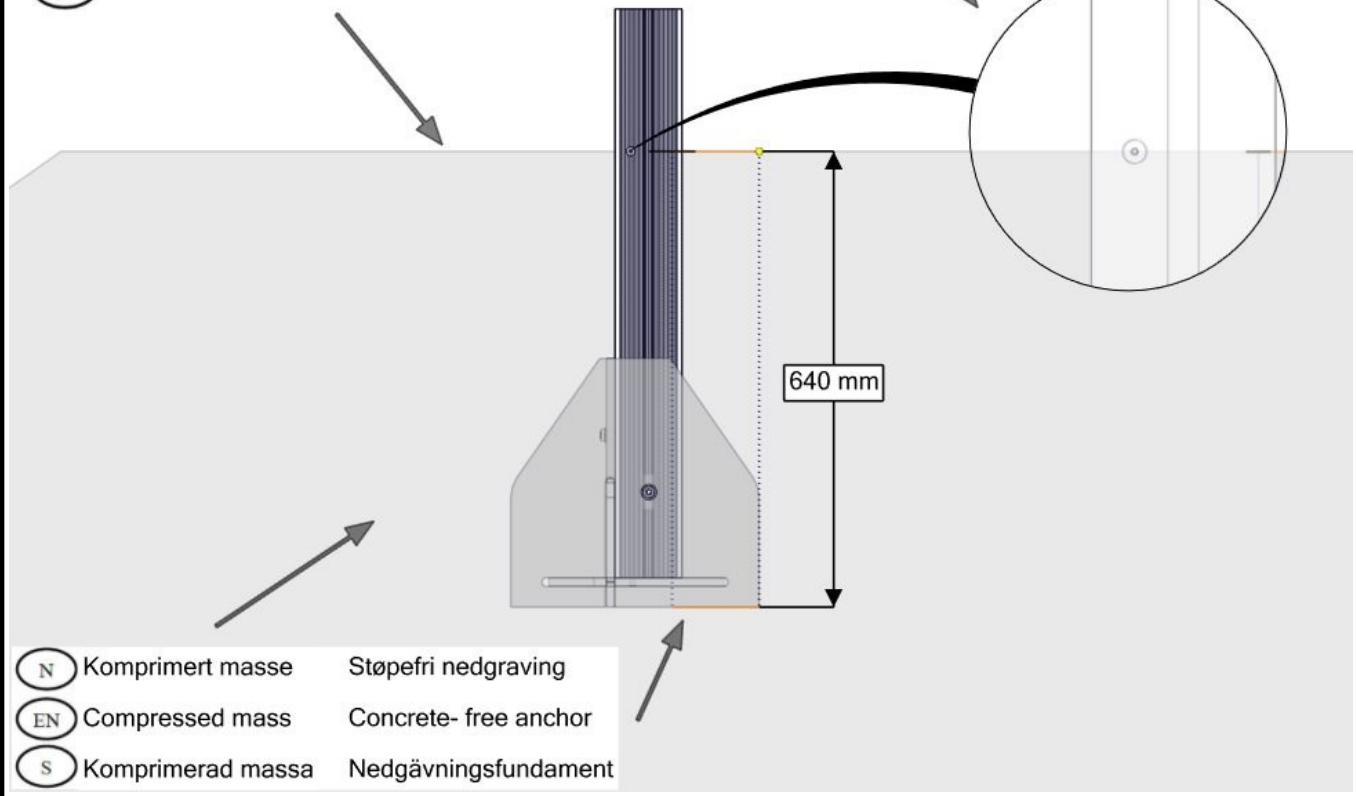

- (N) Komprimert masse Støpefri nedgraving
- (EN) Compressed mass Concrete-free anchor
- (S) Komprimerad massa Nedgävningsfundament

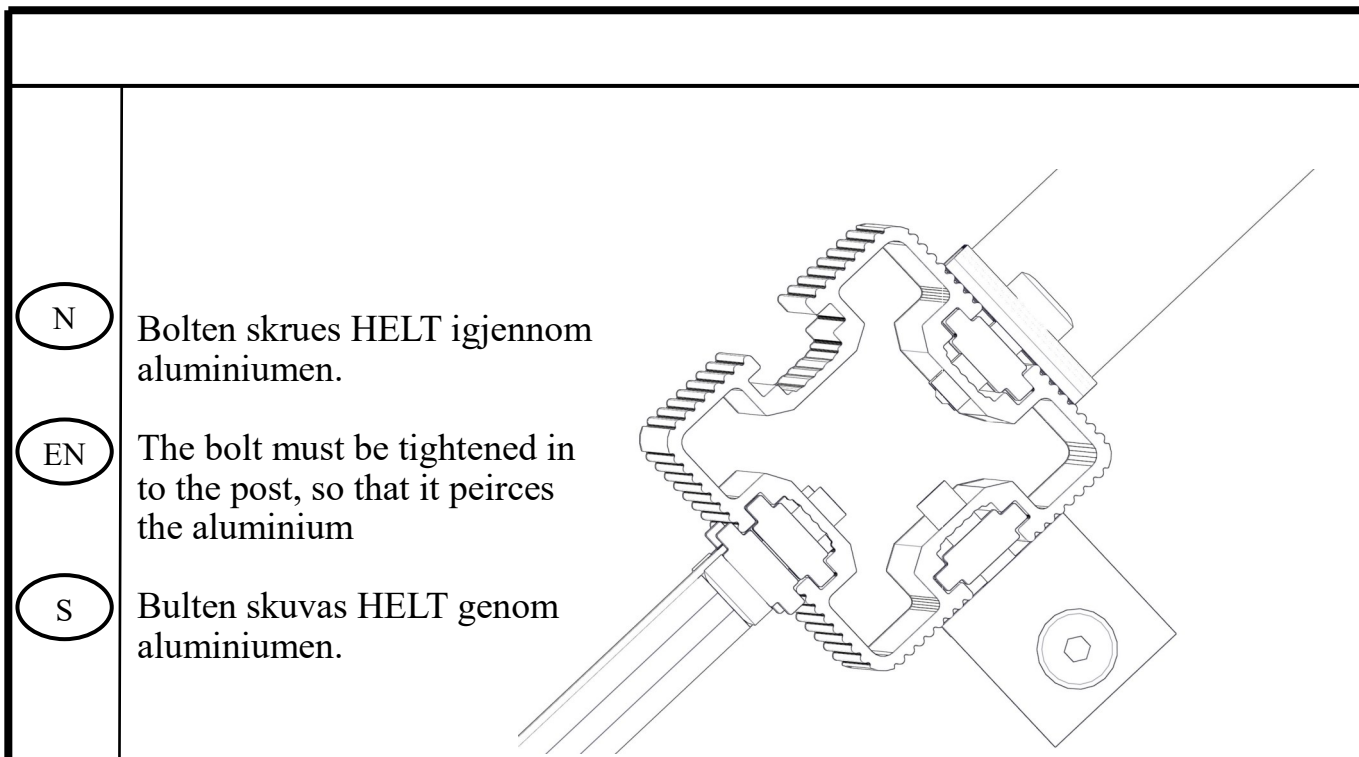

NO	Betongkvalitet	C25/30		
SE	Betongkvalitet			
EN	Concrete quality			
NO	Mengde betong		0,4	m ³
SE	Mängd betong			
EN	Amount of concrete			
NO	Fundament størrelse		0,5 x 0,5 x 0,4	m
SE	Stiftelsestorlek			
EN	Foundation size			
NO	For sikkerhet må fundamentene med sand eller myk jord være minst 50% større i areal			
SE	För säkerheten måste grunden med sand eller mjuk jord vara minst 50% större i området			
EN	For safety, the foundations with sand or soft soil must be at least 50% larger in area			
NO	Tyngste element	07-300-410	49,2	Kg
SE	Tyngsta element			
EN	Heaviest element			
NO	Største element	07-300-410	2,97x0,53x0,45	m
SE	Största element			
EN	Biggest element			

Fallhøyder / Free height of fall / Fallhöjder

Fallhøyde = 1,5m

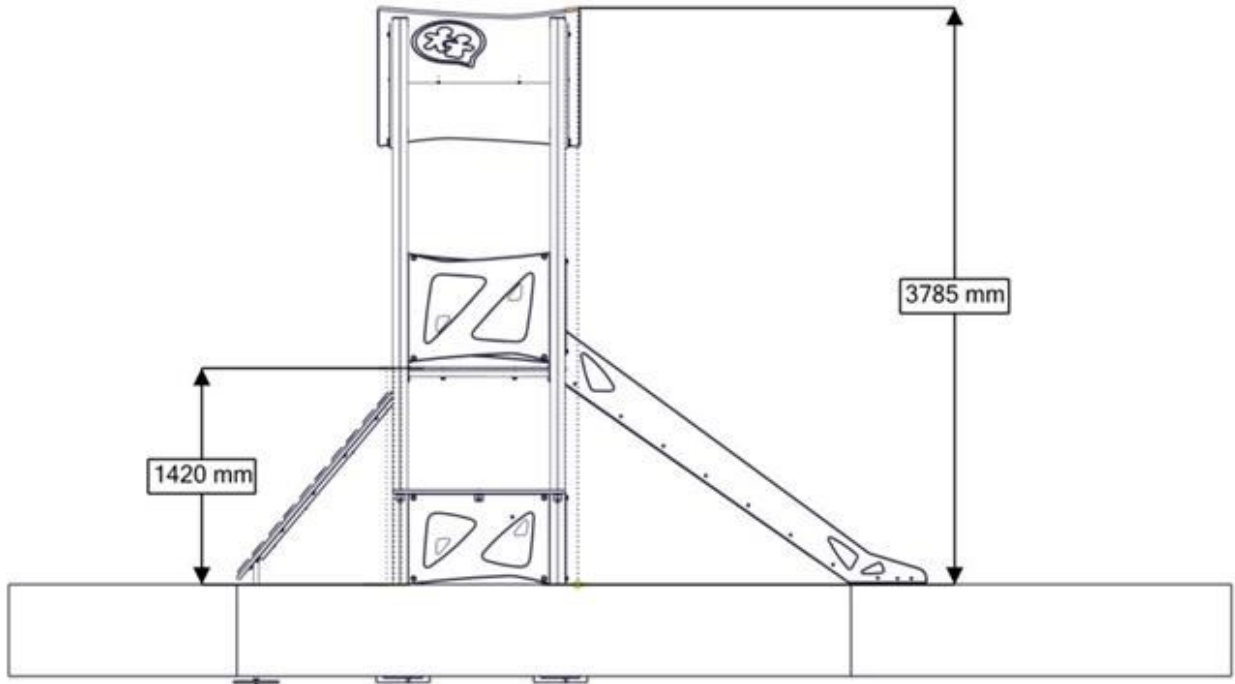

Minimum Sikkerhetszone // Safety zone // Säkerhetszon

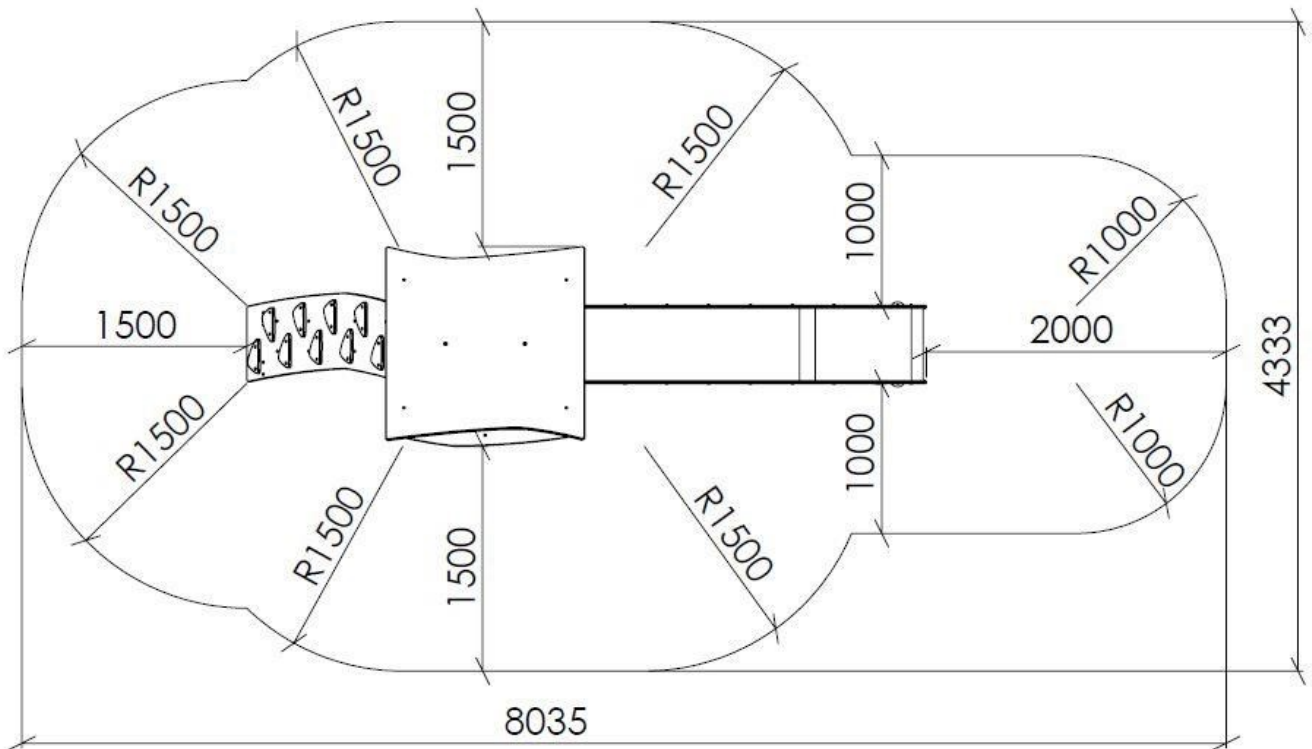

Plassering av forankringer / Ground plan / Placering av förankringar

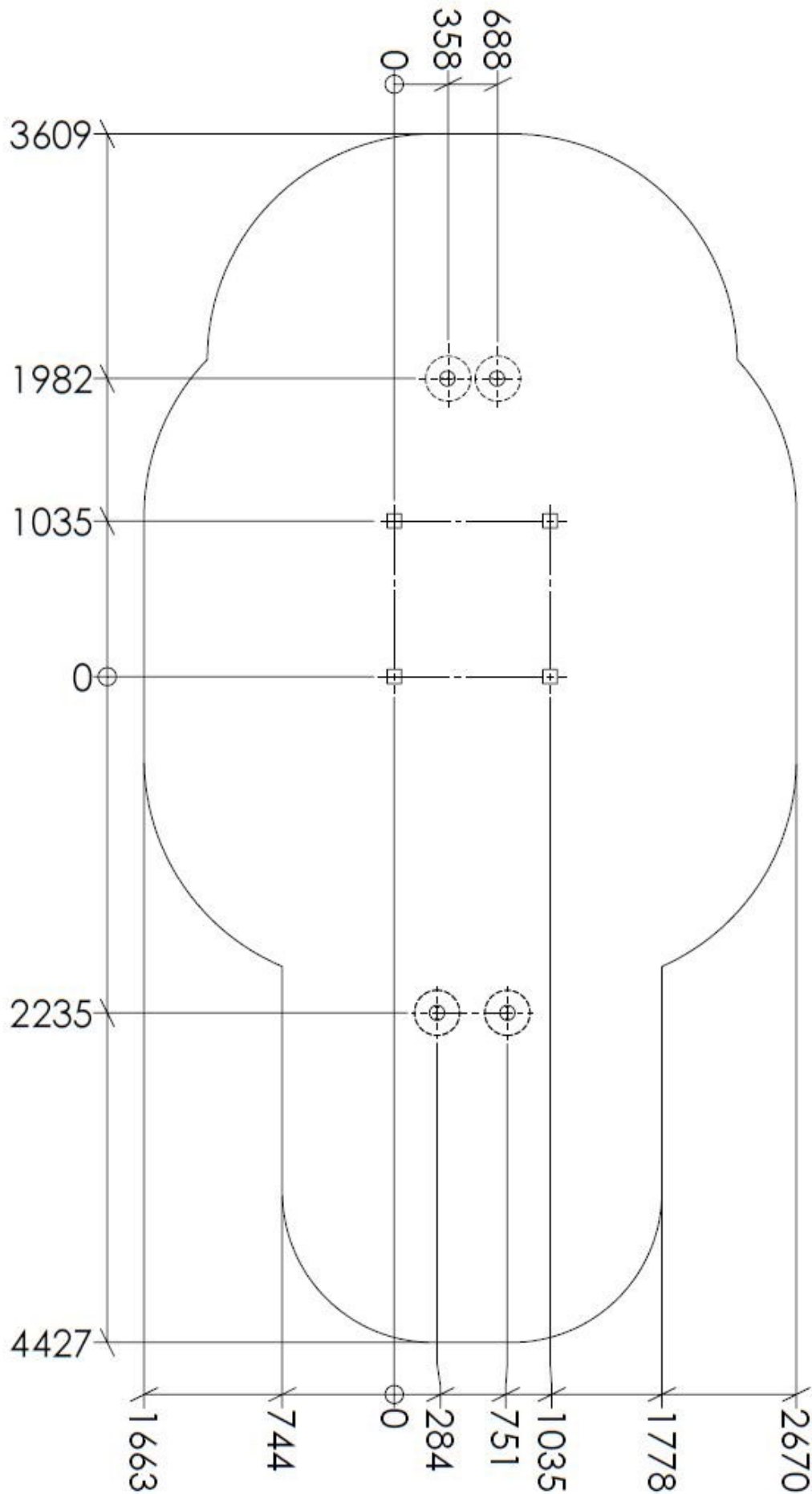

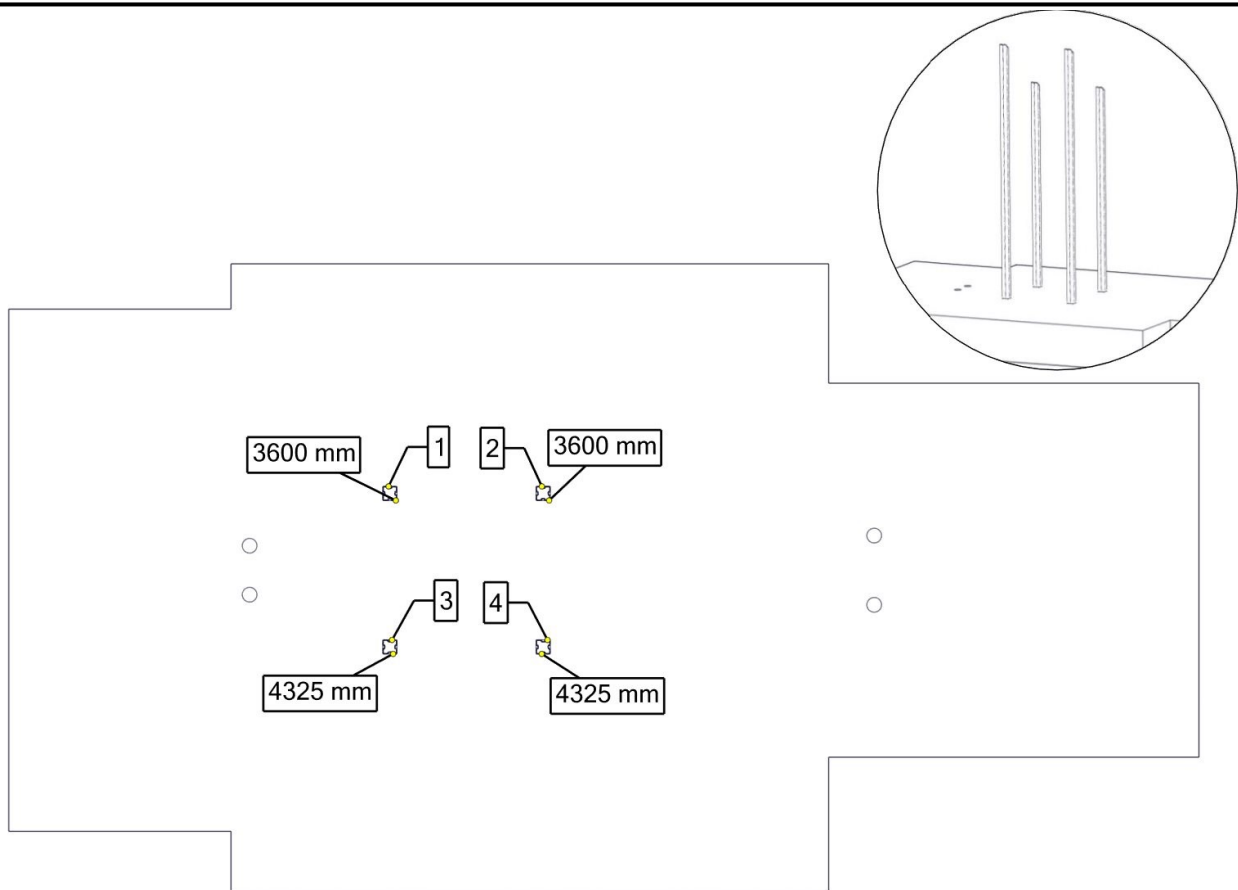

Se separat delmontering for detaljer
 See separate assembly for details
 Se separata delmontering för detaljer

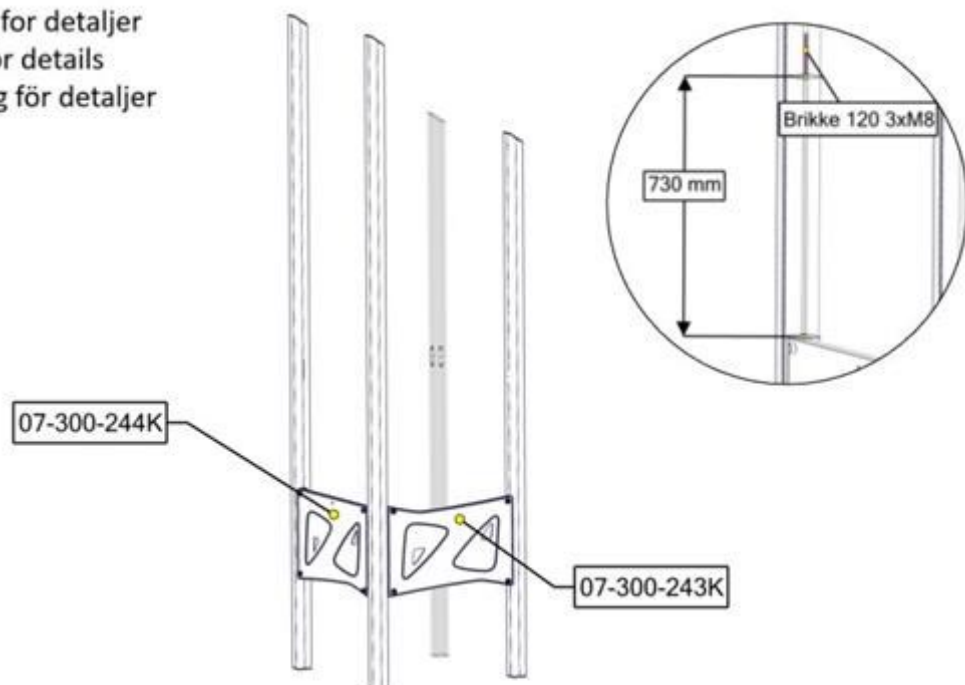

Part Name	Article nr.	Qty
Rekkverk 600x940x19	07-300-243K	1
Rekkverk 600x940x19 butikkdisk	07-300-244K	1

Se separat delmontering for detaljer
 See separate assembly for details
 Se separata delmontering för detaljer

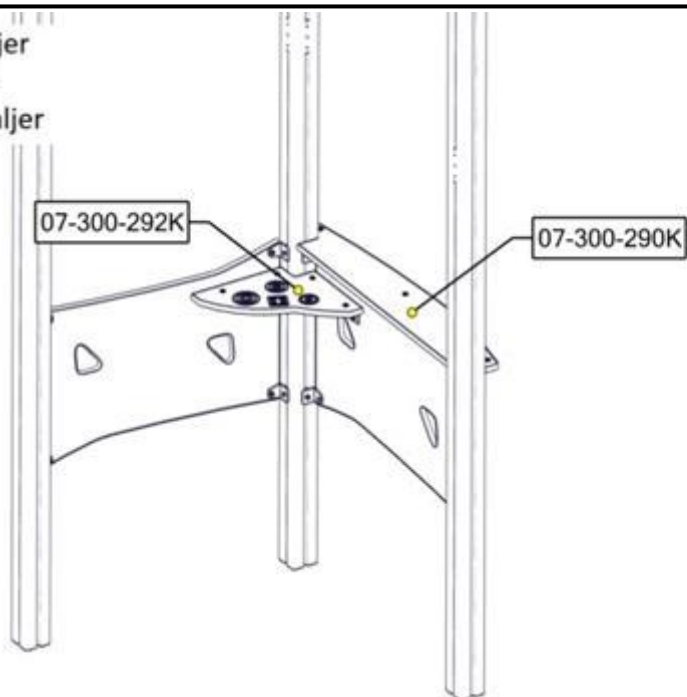

Part Name	Article nr.	Qty
Butikkdisk 1122x200x19 Komplet	07-300-290K	1
Kokeplate	07-300-292K	1

Se separat delmontering for detaljer
 See separate assembly for details
 Se separata delmontering för detaljer

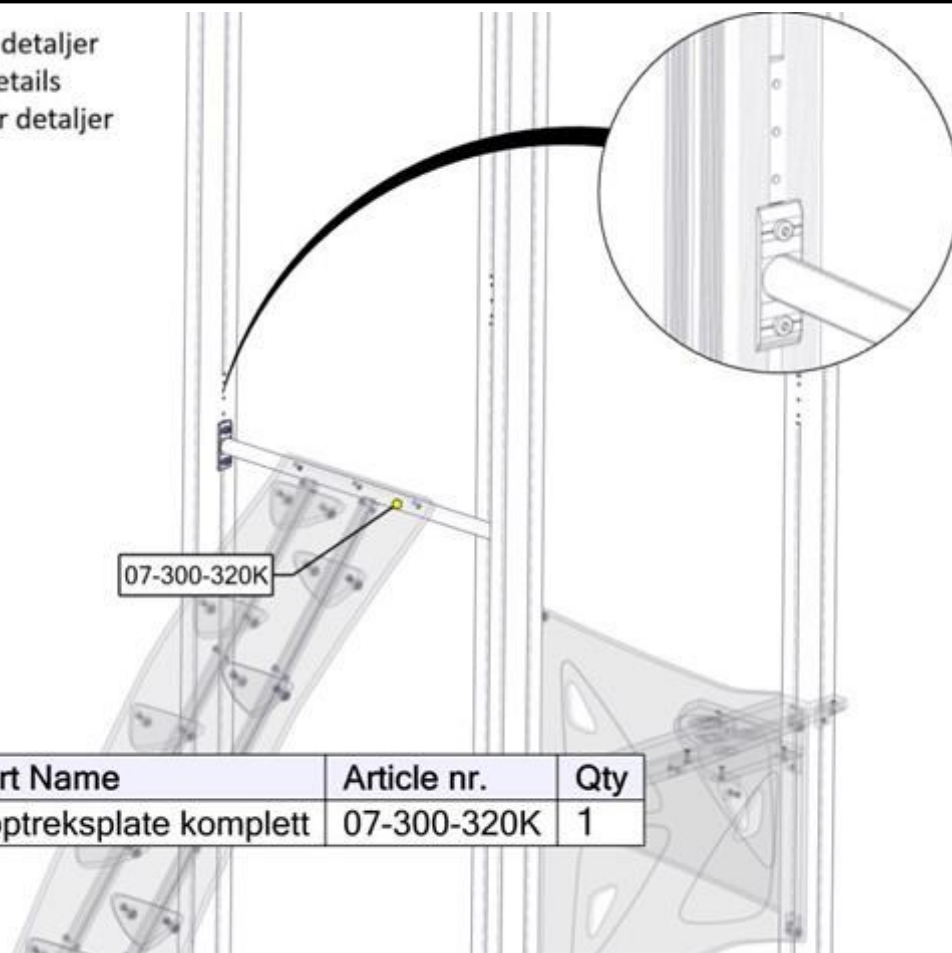

Part Name	Article nr.	Qty
Opptreksplate komplett	07-300-320K	1

Se separat delmontering for detaljer
 See separate assembly for details
 Se separata delmontering för detaljer

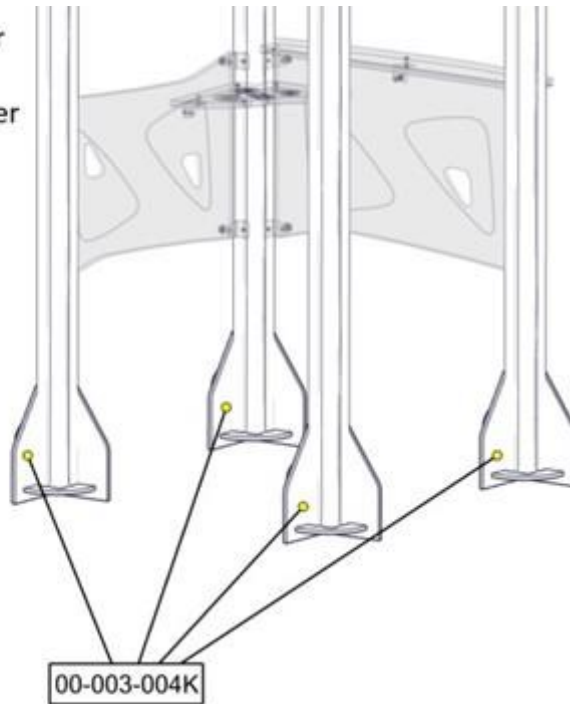

Part Name	Article nr.	Qty
Nedgravingsfundament 95x95	00-003-004K	4

Se separat delmontering for detaljer
 See separate assembly for details
 Se separata delmontering för detaljer

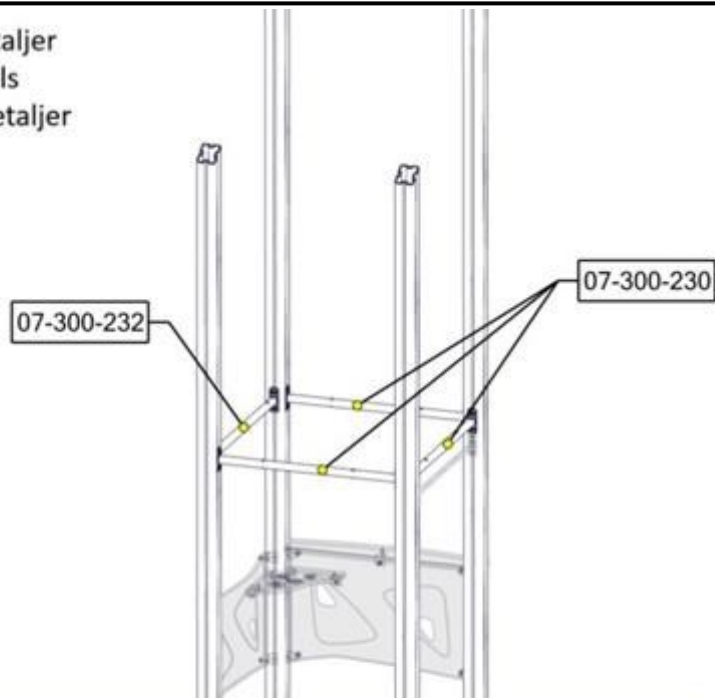

Part Name	Article nr.	Qty
Torx M8x25	04-000-025	16
Sperrerør gulv 2 hullcc 470	07-300-230	3
Sperrerør gulv 2 hull cc735 for portal	07-300-232	1

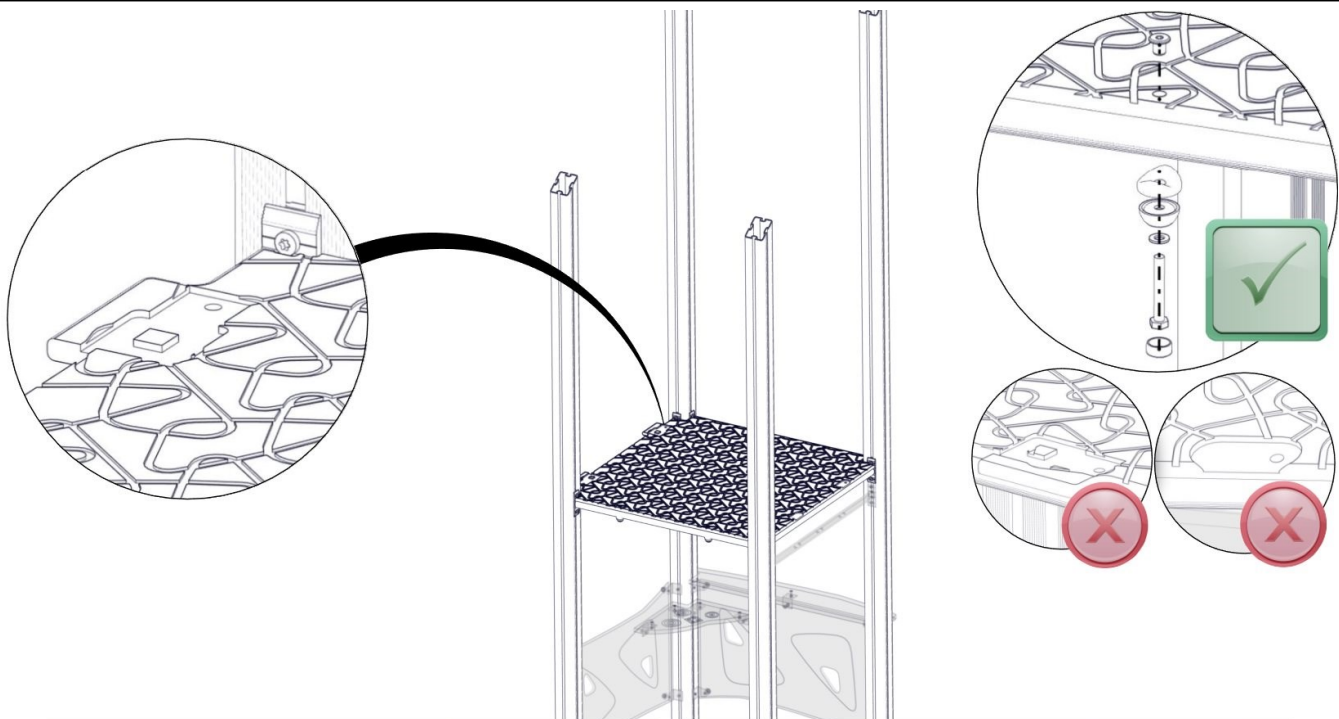

Part Name	Article nr.	Qty
Sekskant M8x55	04-008-055	4
Møbelknapp M8x11	04-030-011	4
Skive M8	04-050-008	4
Avstandskive Radie 38	04-210-010	4

Part Name	Article nr.	Qty
Sikkerhetshette 20mm svart for M8	05-301-044	4
Sikkerhetshette kropp 32 svart for M8	05-301-045	4
Gulv 1075x1115 P-0-1-0	07-300-201	1

Se separat delmontering for detaljer
 See separate assembly for details
 Se separata delmontering för detaljer

07-300-320K

Part Name	Article nr.	Qty
Opptreksplate komplett	07-300-320K	1

Se separat delmontering for detaljer
 See separate assembly for details
 Se separata delmontering för detaljer

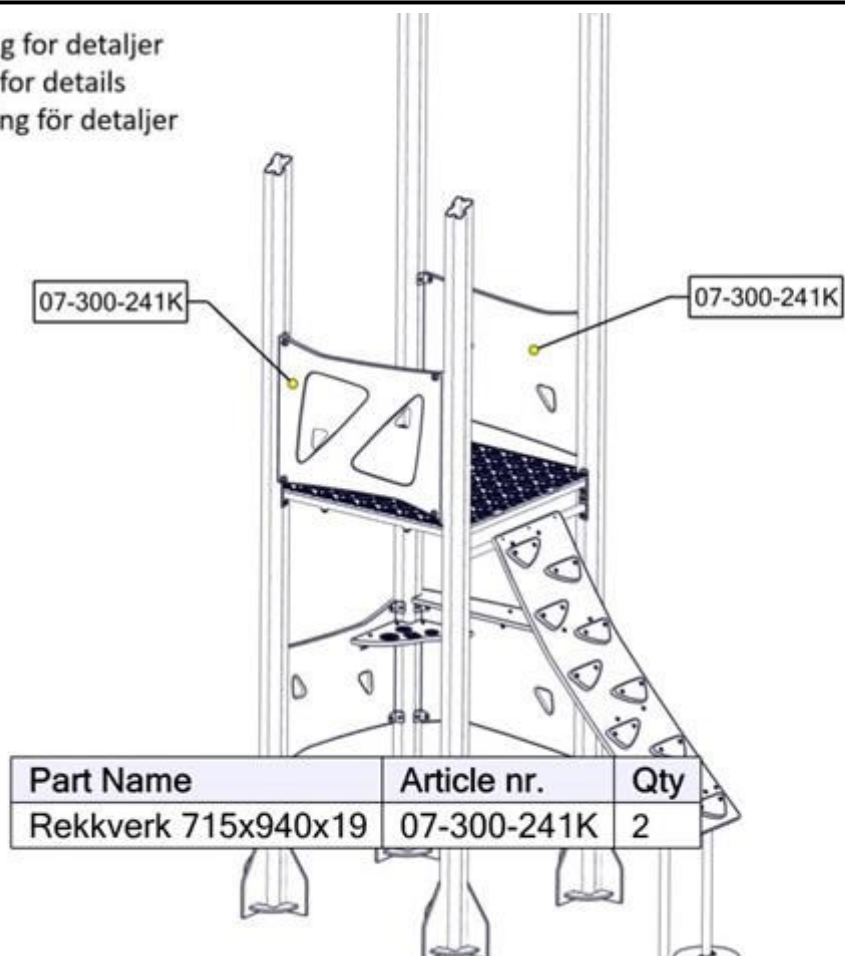

Se separat delmontering for detaljer
 See separate assembly for details
 Se separata delmontering för detaljer

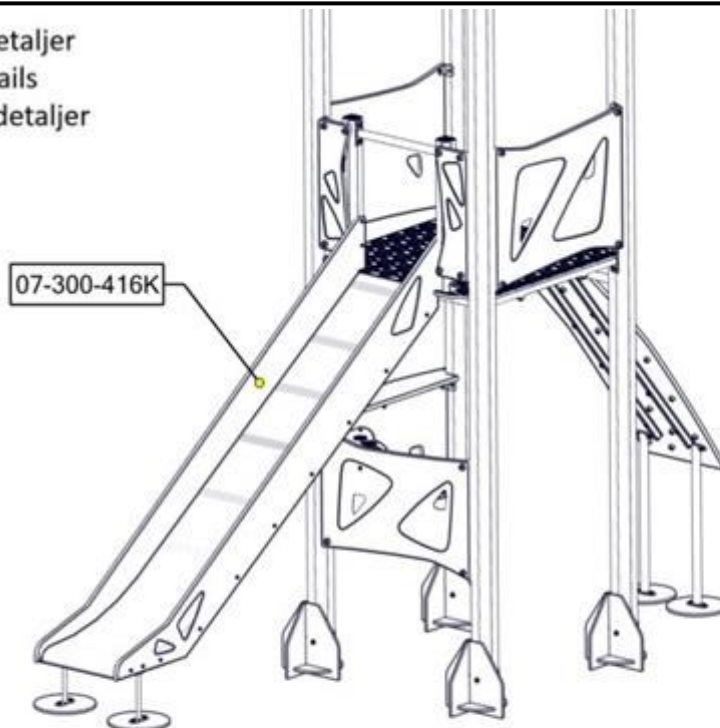

Part Name	Article nr.	Qty
Rutsjebane H1.4 med portal	07-300-416K	1

Se separat delmontering for detaljer
 See separate assembly for details
 Se separata delmontering för detaljer

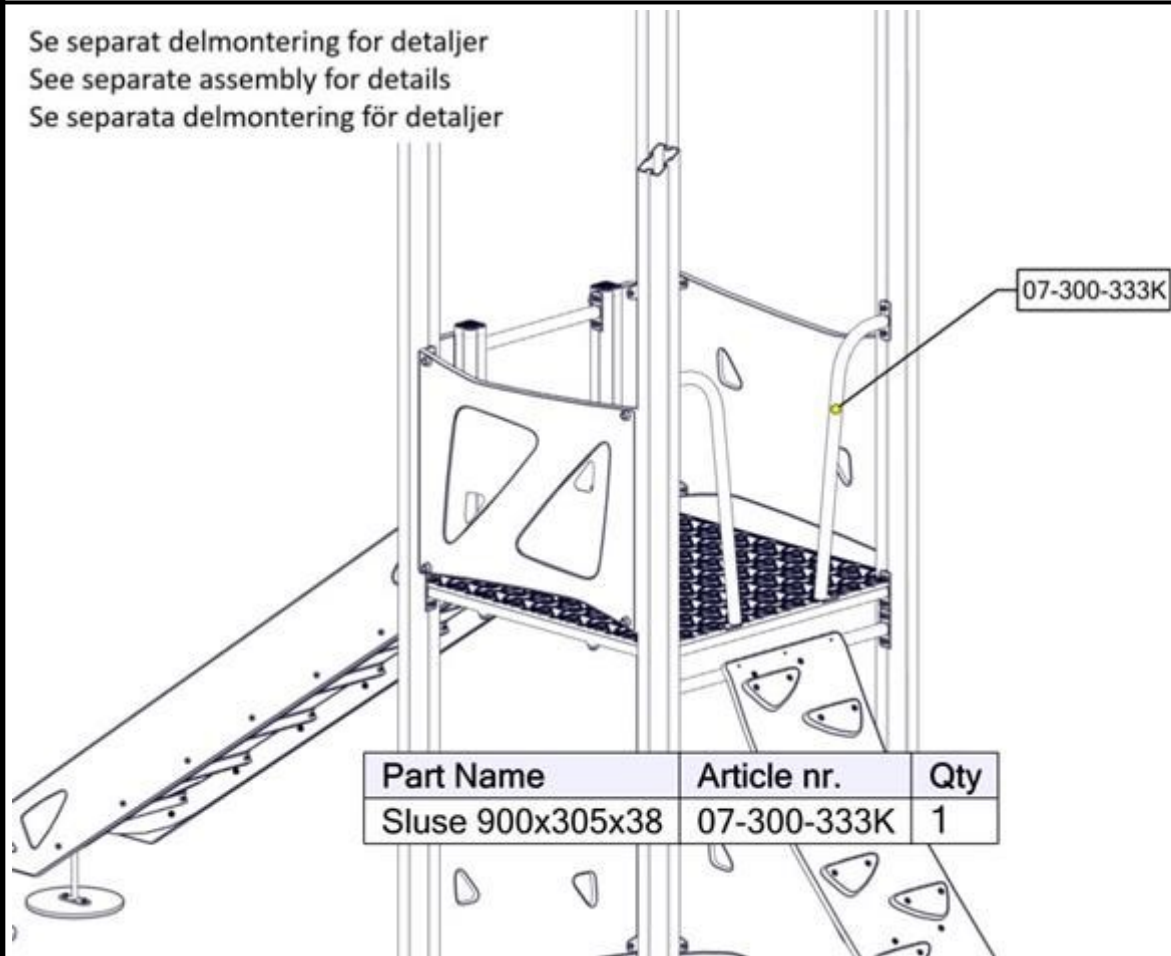

Part Name	Article nr.	Qty
Sluse 900x305x38	07-300-333K	1

Se separat delmontering for detaljer
 See separate assembly for details
 Se separata delmontering för detaljer

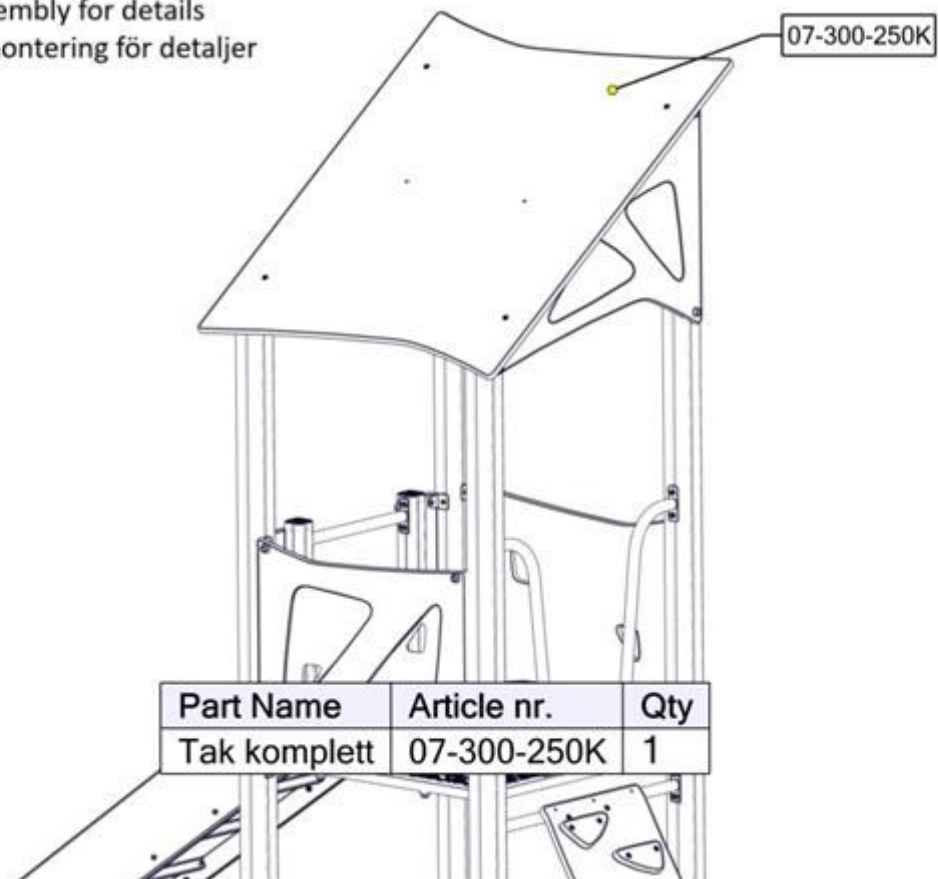





Part Name	Article nr.	Qty
Tak komplett	07-300-250K	1

Før utstyret tas i bruk / Before play begins / Innan lekredskapet tas i bruk	
N	<ul style="list-style-type: none"> ● Påse at fallunderlag er utlagt i henhold til gjeldende regler eller vår anbefaling ● Fjern alle monteringshjelpemidler (rester av betong, planker, paller, plast, og lignende) ● Før utstyret tas i bruk, burde man sjekke at det ikke er fare for at anorakksnorer og lignende som kan hekte seg fast noen steder på lekeapparatet. (Vedlagte snor med dobbe (kneledd) kan brukes til å sjekke at dette er i orden. Se vedlagte veiledning for bruk av denne. Dette gjøres for å oppdage eventuelle feilmonteringer.?) ● NB! Bør stå i 2-3 dager før bruk
EN	<ul style="list-style-type: none"> ● Make sure the area and depth of safer surfacing are according to the current standard, or to the manufacturer's recommendation ● Make sure all tools and surplus materials are removed before play begins ● PS! When complete, allow 2-3 days for the concrete to set before use
S	<ul style="list-style-type: none"> ● Kontrollera att fallunderlag är utlagt enligt gällande regler eller vårt rekommendation ● Ta bort alla monteringshjälpmedel (rester av betong, plankor, pallar, plast och liknande) ● Innan lekredskapet används, kontrollera att anoracksnoddar eller kläder/delar av kläder eller liknande inte kan fastna i några delar på redskapet. (Den bipackade "knävringen" kan man med fördel användas för denna kontroll. ● Detta görs för att upptäcka eventuella felmonteringar.)

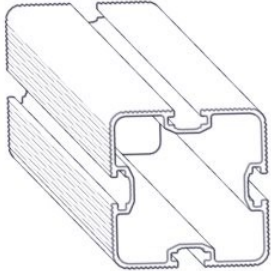
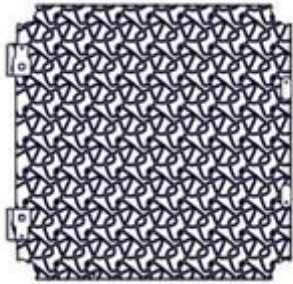



Boltepakker for / Boltpackage for / Bultpaket för

Sign. _____

Saturn Greip 11-500-020	Navn	Artnr/dimensjon	Ant	Lev
	Stolpe 95x95 skrå 55 Lengde = 3600 Sort	SFA5117/1	2	
	Stolpe 95x95 skrå 55 Lengde = 4325 Sort	SFA5117/1	2	
	Gulv 1075x1115x15 Portal-0-1-0	07-300-201	1	
	Produktmerke	00-100-400 (Montert hos Søve)	0	
	Sperrerør for gulv Lengde = 940 2 hull cc470 Sort	07-300-230	3	
	Sperrerør for gulv Lengde = 940 2 hull cc735 for portal Sort	07-300-232	1	
	Torx M8x25	04-000-025	16	

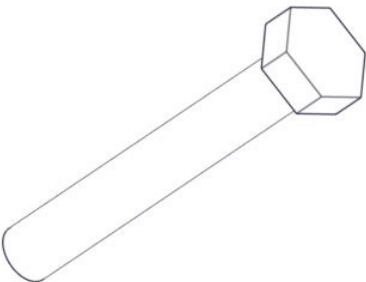
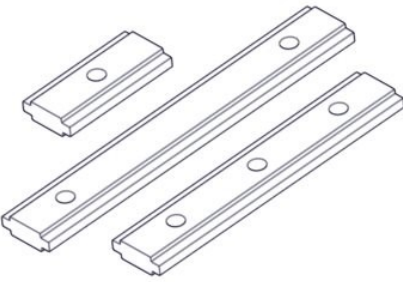

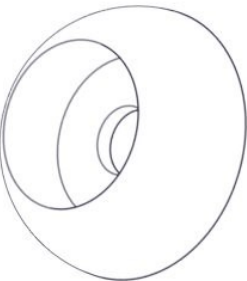
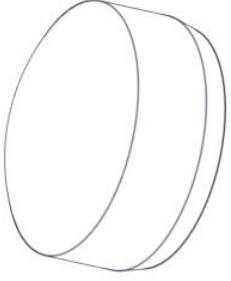
Boltepakker for / Boltpackage for / Bultpaket för

Sign. _____

Saturn Greip 11-500-020	Navn	Artnr/dimensjon	Ant	Lev
	Sekskant M8x55	04-008-055	8	
	Brikker 120 3xM8	04-060-120 (montert hos Søve)	0	
	Møbelknapp M8x11	04-030-011	8	
	Sikkerhets hette kropp	05-301-045	8	
	Sikkerhets hette topp	05-301-044	8	
	Avstandsskive for Ø38	04-210-010	8	



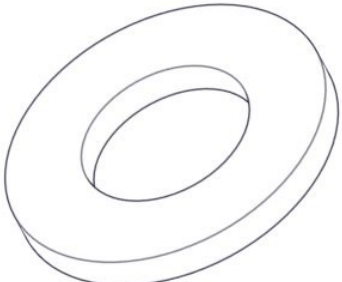
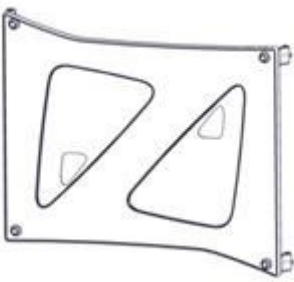
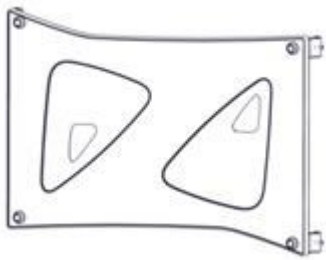
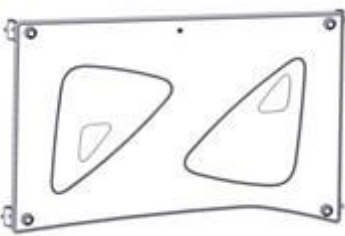

Boltepakker for / Boltpackage for / Bultpaket för

Sign. _____

Saturn Greip 11-500-020	Navn	Artnr/dimensjon	Ant	Lev
	Skive M8	04-050-008	8	
	Rekkverk 715x940x19 Blå/ pistasj	07-300-241K (se egen del- montering)	2	
	Rekkverk 600x940x19 Blå/ pistasj	07-300-243K (se egen del- montering)	1	
	Rekkverk butikkdisk 600x940x19 Blå/ pistasj	07-300-244K (se egen del- montering)	1	
	Butikkdisk 1122x200x19 Blå/ pistasj	07-300-290K (se egen del- montering)	1	
	Kokeplate Blå/ pistasj	07-300-292K (se egen del- montering)	1	

Boltepakker for / Boltpackage for / Bultpaket för

Sign. _____

Saturn Greip 11-500-020	Navn	Artnr/dimensjon	Ant	Lev
	Tak Blå/ pistasj	07-300-250K (se egen del- montering)	1	
	Sluse 900x305x38 Pistasj	07-300-333K (se egen del- montering)	1	
	Rutsjebane inkl.portal H=1.4m Blå/ pistasj	07-300-416K (se egen del- montering)	1	
	Opptrekkplate Blå/ pistasj	07-300-320K (se egen del- montering)	1	

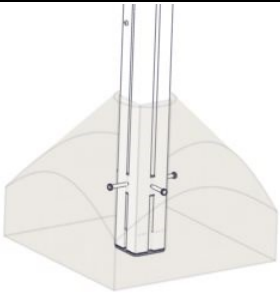
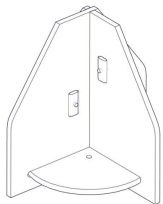
Boltepakker for / Boltpackage for / Bultpaket för		Sign. _____.		
Saturn Greip 11-500-020	Navn	Artnr/ dimensjon	Ant	Lev
	Fundament Støp			
	Støpefundament 95 x 95 stolpe	00-003-110K (se egen del- montering)	4	
	Fundament Nedgravning			
	Nedgravings fundament 95 x 95 Stolpe	00-003-004K (Se egen del- montering)	4	

Boltepakker for / Boltpackage for / Bultpaket för

Sign. _____

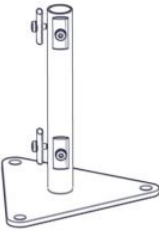
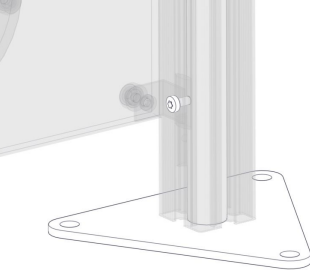
Saturn Greip 11-500-020	Navn	Artnr/ dimensjon	Ant	Lev
	For overflate montering			
	Fundament stolpe for betong- dekke 95x95	00-003-125K (se egen del- montering)	4	
	Fundament kortere boltfeste	00-003-132K (Se egen del- montering)	4	
	Changed part foundations 07-300-416K 07-300-320K Stolpe må kappes		2 2 4	

Revisjon:

07.07.2020

Oppdatert BOM

Oppdatert sikkerhetsone

Oppdatert areal

Oppdatert stolpeplassering

08.07.2020

Oppdatert vekt i tabell