

N

Monteringsanvisning

EN

Assembly Instructions

S

Monteringsanvisning

Produkt nr. / Product no. / Produkt nr.

11-500-031**Oransje / Lilla**

Ord. nr. _____

Dato. _____

Sign. _____

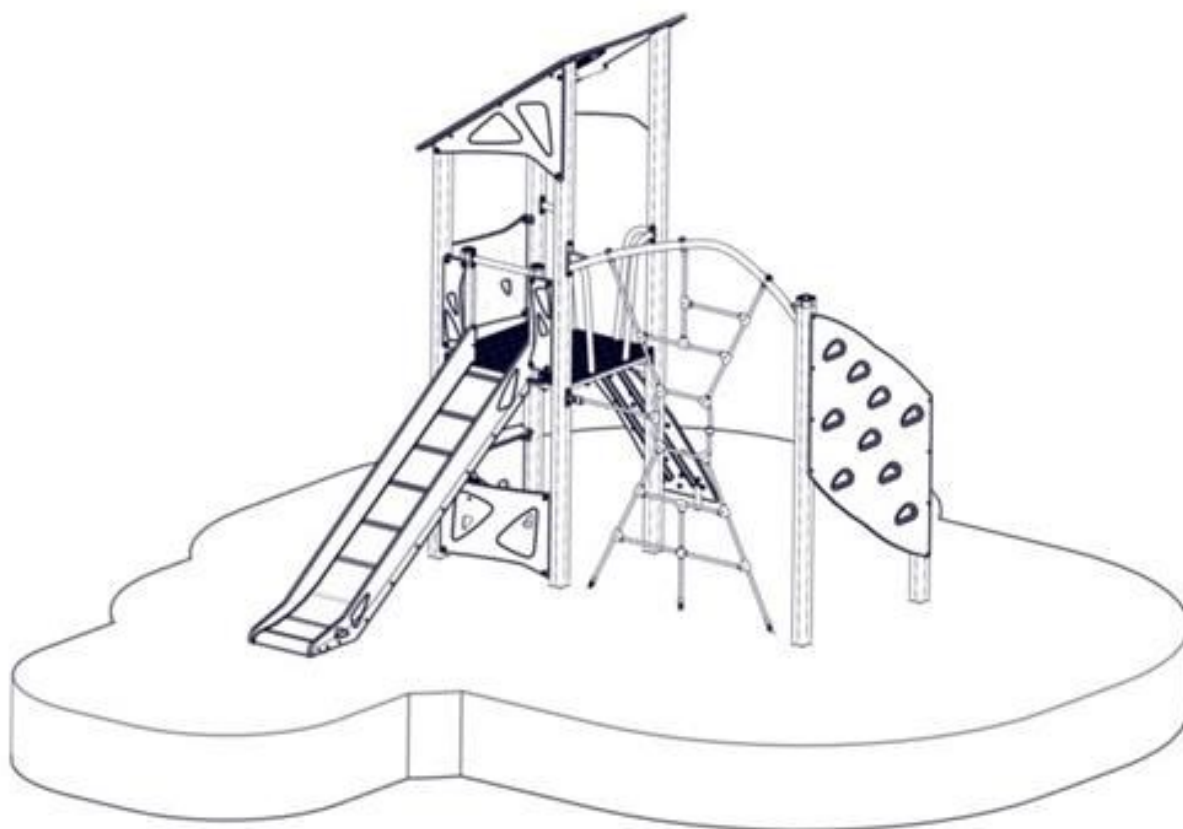
**søve**

Søve AS
Grønnvoldveien 290
3830 Ulefoss - Norway
Tlf: +47 35 94 65 65
www.sove.no

**søve**

Søve AB
EA Rosengrensgatan 32
421 31 Västra Frölunda
Phone: +46 (0)31 773 97 00
www.sove.se

Monteringstips / Assembly Advice / Monteringsstips

N

- Les monteringsanvisningen nøye før montering.
- Monter elementene i rekkefølgen som vist.
- Boltene bør ikke skrues for hardt til før alt er montert, vatret og loddet. Skru så boltene til.
- NB! Ved bruk av drill, kan boltene ryke.
- På grunn av at solen kan gjøre rutsjeflaten veldig varm, bør rutsjebanens utløp vende mot nord-øst eller nord-vest.
- Er lekeutstyret plassert i naturlige ferdselstraséer må området sikres mot gjennomgang.
- Innspringningshinder bør vurderes rundt lekeapparater hvor det er stor bevegelse, f.eks. ved huskestativ.
- Det bør være fritt innsyn til lekeutstyr som er beregnet for barn under 3 år.

NB! Under monteringsarbeidet må utstyr, som ikke er forankret forsvarlig i bakken, sikres slik at det ikke velte.

Området må avstenges under montering av apparatene med sperrebånd eller lignende.

EN

- Read the instruction carefully before assembling the play unit.
- Assemble the components in the sequence shown in these instructions. Fixings must not be fully tightened during assembly. Before casting the foundations, the structure must be level and plumb, at which point all fixings are tightened. PS! If use of drill, the bolts may be wrecked.
- Avoid positioning the slide facing due south because of overheating – ideal positions are facing north-east or north-west. Secure the construction-area to prevent people from walking through it.
- Consider installing barriers around play-equipment which gives rise to a lot of activity – i.e. swings.
- Ensure that clear vision is possible across the play area so that supervision is possible from any position, particularly where children under 3 years of age will be playing.

NB! During assembly of the equipment, ensure that all structures are securely propped, especially when left overnight. Also ensure that equipment is supported

Monteringstips / Assembly Advice / Monteringsstips**S**

- Läs monteringsanvisningen noga före montering.

- Montera delarna i den ordningen som anvisas
- Skruvarna bör inte skruvas för hårt tills allt är monterat, i våg och lodat.









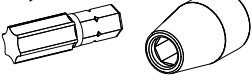

OBS! Används elektrisk skruvdragare, kan bulten gå sönder. Hårdra därför manuellt!

- Solen kan göra att rutchbanan blir väldigt varm. Banans nedfart rekommenderas att vändas i norrlig riktning
- Om lekplatsen placeras vid en gångväg mm bör området säkras mot genomfart av gående och cyklister.
- Insprängningshinder bör placeras runt lekutrustning med stor rörelse, t ex, gungställning.
- Det bör vara fri insyn till lekutrustning beräknat till barn under 3 år.

OBS! Under monteringsarbete bör utrustningen som inte ska förankras i marken, ställs så att den inte kan välta.

Området måste spärras när lekutrustningen byggs upp, med avspärrningsband eller liknande.

Nødvendig verktøy / Tools required / Nödvändiga verktyg



<p>(N)</p> <p>(EN)</p> <p>(S)</p>	<p>(A)</p> 	<p>(B)</p>  <p>Torx Nr 45</p>	<p>(C)</p> <p>5 mm 6 mm</p> 	<p>(D)</p> 	<p>(E)</p> 
		<p>Metermål Metric measure Tumstock</p> 	<p>Ø11mm Bor Ø11mm Drill Ø11mm Borr</p> 	<p>Merkebånd Mark ribbon Märkeband</p> 	<p>13 + 17mm</p> 

Nødvendig antall personer / Number of persons required / Rekommenderad antal personer



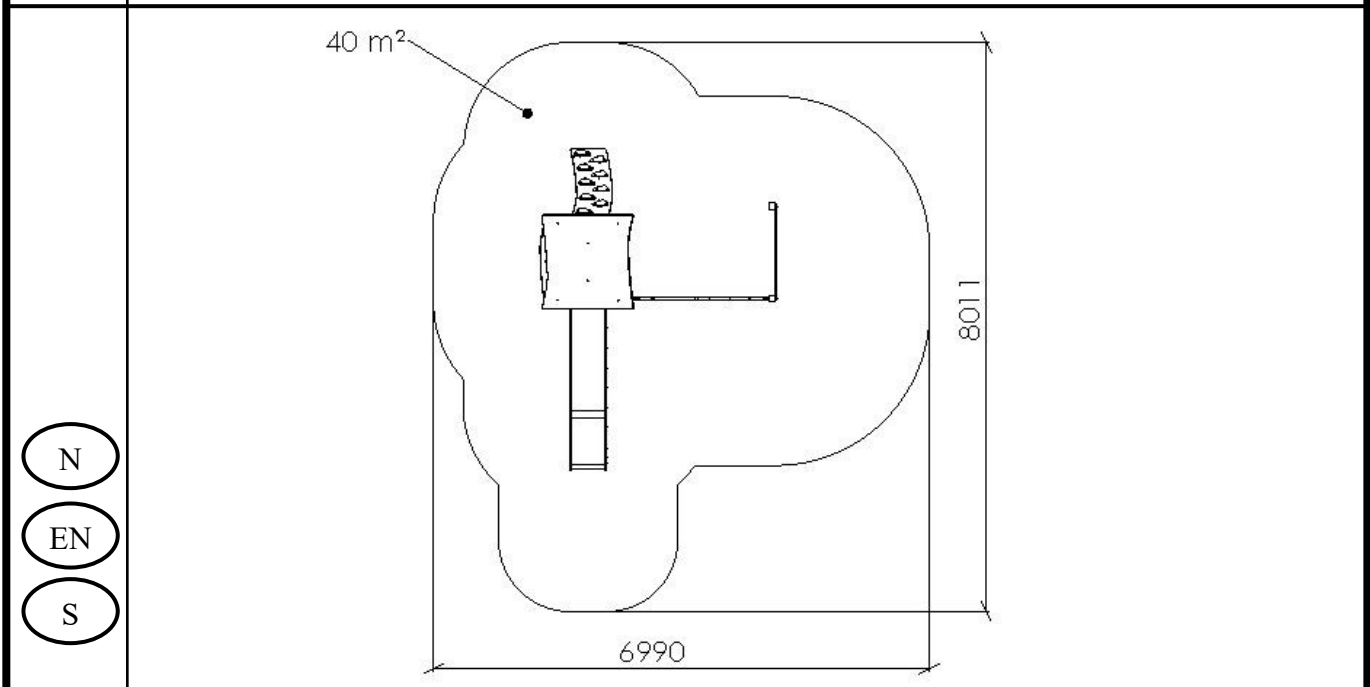

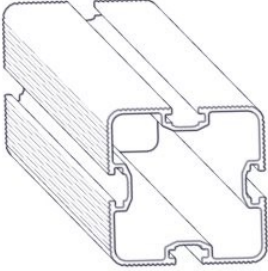
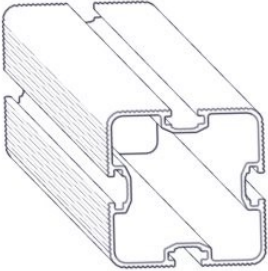
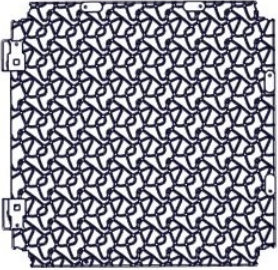
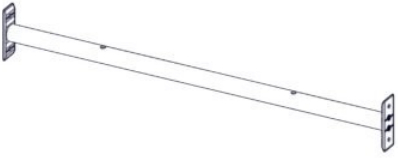

Anbefalt arealbehov ved montering / Recommended working space / Rekommenderad arealbehov vid montering



Boltepakker for / Boltpackage for / Bultpaket för		Sign. _____		
Saturn Hati 2 11-500-031	Navn	Artnr/ dimensjon	Ant	Lev
	Stolpe 95x95 Lengde = 2050 Sort	SFA5117/1	1	
	Stolpe 95x95 Lengde = 3030 Sort	SFA5117/1	1	
	Stolpe 95x95 skrå 55 Lengde = 3600 Sort	SFA5117/1	2	
	Stolpe 95x95 skrå 55 Lengde = 4325 Sort	SFA5117/1	2	
	Gulv 1075x1115x15 Portal-0-1-1 Grå	07-300-203	1	
	Sperrerør for gulv Lengde = 940 2hull cc470 Sort	07-300-230	3	
	Sperrerør for gulv Lengde = 940 2hull cc735 for portal Sort	07-300-232	1	
	Torx M8x25	04-000-025	16	

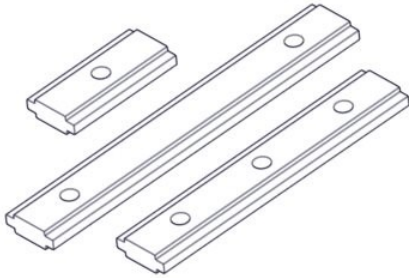

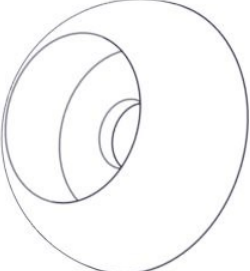
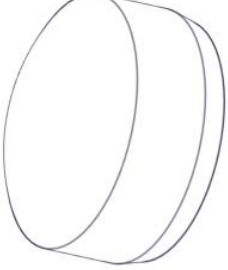
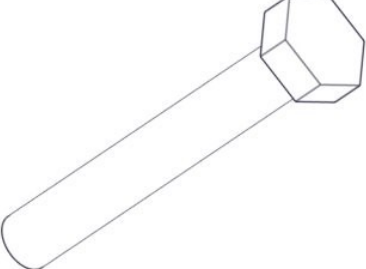
Boltepakker for / Boltpackage for / Bultpaket för





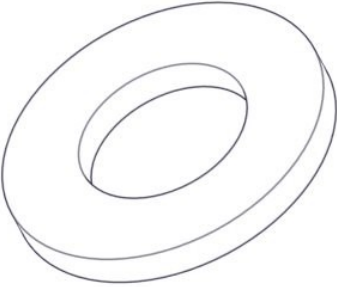

Sign. _____

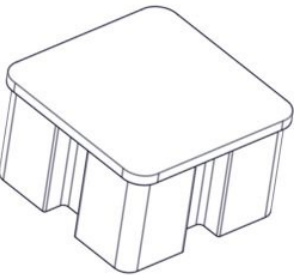
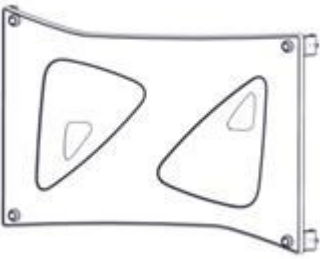
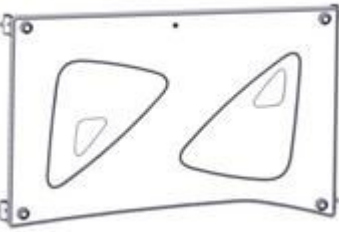
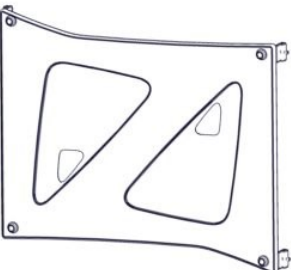
Saturn Hati 2 11-500-031	Navn	Artnr/ dimensjon	Ant	Lev
	Brikke 120 3xM8	04-060-120 (montert hos Søve)	0	
	Møbelknapp M8x11	04-030-011	8	
	Sikkerhets hette kropp	05-301-045	8	
	Sikkerhets hette topp	05-301-044	8	
	Sekskant M8x55	04-008-055	8	
	Avstandskive for Ø38	04-210-010	8	

Boltepakker for / Boltpackage for / Bultpaket för

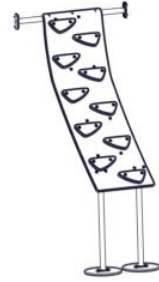

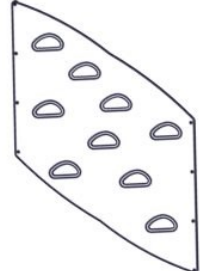
Sign. _____

Saturn Hati 2 11-500-031	Navn	Artnr/ dimensjon	Ant	Lev
	Skive M8	04-050-008	8	
	Produktmerke	00-100-400 (montert hos Søve)	0	
	Endelokk til 95x95 stolpe	00-400-998	2	
	Rekkverk 600 x 940 x 19 Oransje	07-300-242K (se egen delmontering)	1	
	Rekkverk butikkdisk 600 x 940 x 19 Oransje	07-300-245K (se egen delmontering)	1	
	Rekkverk 715 x 940 x 19 Oransje	07-300-240K (se egen delmontering)	1	

Boltepakker for / Boltpackage for / Bultpaket för		Sign. _____		
Saturn Hati 2 11-500-031	Navn	Artnr/ dimensjon	Ant	Lev
	Butikkdisk 1122 x 200 x 19 Oransje	07-300-291K (se egen delmontering)	1	
	Kokeplate Oransje	07-300-293K (se egen delmontering)	1	
	Opptrekkplate Oransje	07-300-321K (se egen delmontering)	1	
	Sluse 900 x 305 x 38 Lilla	07-300-332K (se egen delmontering)	2	
	Klatrevegg 2000 x 1325 Lilla	07-300-345K (se egen delmontering)	1	
	Edderkoppnett med rør Oransje	07-300-401K (se egen delmontering)	1	

Boltepakker for / Boltpackage for / Bultpaket för

Sign. _____.

Saturn Hati 2 11-500-031	Navn	Artnr/ dimensjon	Ant	Lev
	Rutsjebane med portal Gulvhøyde = 1.4m Oransje / Lilla	07-300-417K (se egen delmontering)	1	
	Tak Oransje	07-300-255K (se egen delmontering)	1	

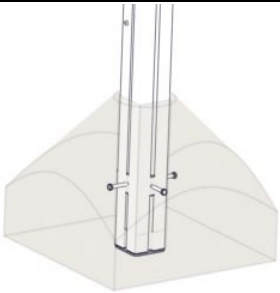
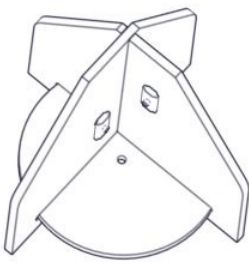
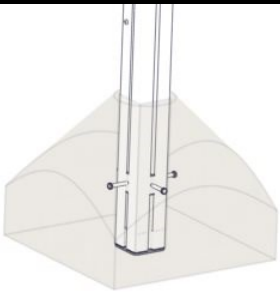
Boltepakker for / Boltpackage for / Bultpaket för		Sign. _____		
Saturn Hati 2 11-500-031	Navn	Artnr/ dimensjon	Ant	Lev
	Fundament Støp			
	Støpefundament 95 x 95 stolpe	00-003-110K (se egen delmontering)	6	
	Fundament Nedgravning			
	Nedgravningsfundament 95 x 95 stolpe	00-003-004K (se egen delmontering)	4	
	Støpefundament 95 x 95 stolpe	00-003-110K (se egen delmontering)	2	

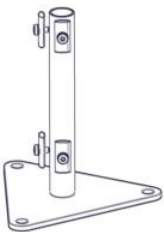
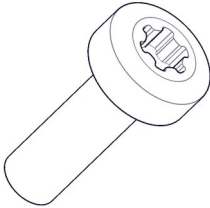
Boltepakker for / Boltpackage for / Bultpaket för		Sign. _____		
Saturn Hati 2 11-500-031	Navn	Artnr/ dimensjon	Ant	Lev
	Overflate fundamentering			
	Fundament 95x95 stolpe for betongdekke	00-003-125K (Se egen delmontering)	6	
	Deler som må Endres, Changed parts			
	Opptreksplate forankring	07-300-321K	(2)	
	Rutsjebane forankring	07-300-417K	(2)	
	Stolpene kappes	SFA5117/1	(6)	
	Bruk kortere bolter når du monterer den nederste delen av veggene	04-000-016	4	

Fundamentering med betong // Foundation concrete // Förankring med betong

- (N) Komprimert masse Ref NS-EN 1176-1
- (EN) Compressed mass §4.2.8.5
- (S) Komprimerad massa



- (N) Bakkenivå
- (EN) Ground level
- (S) marknivå

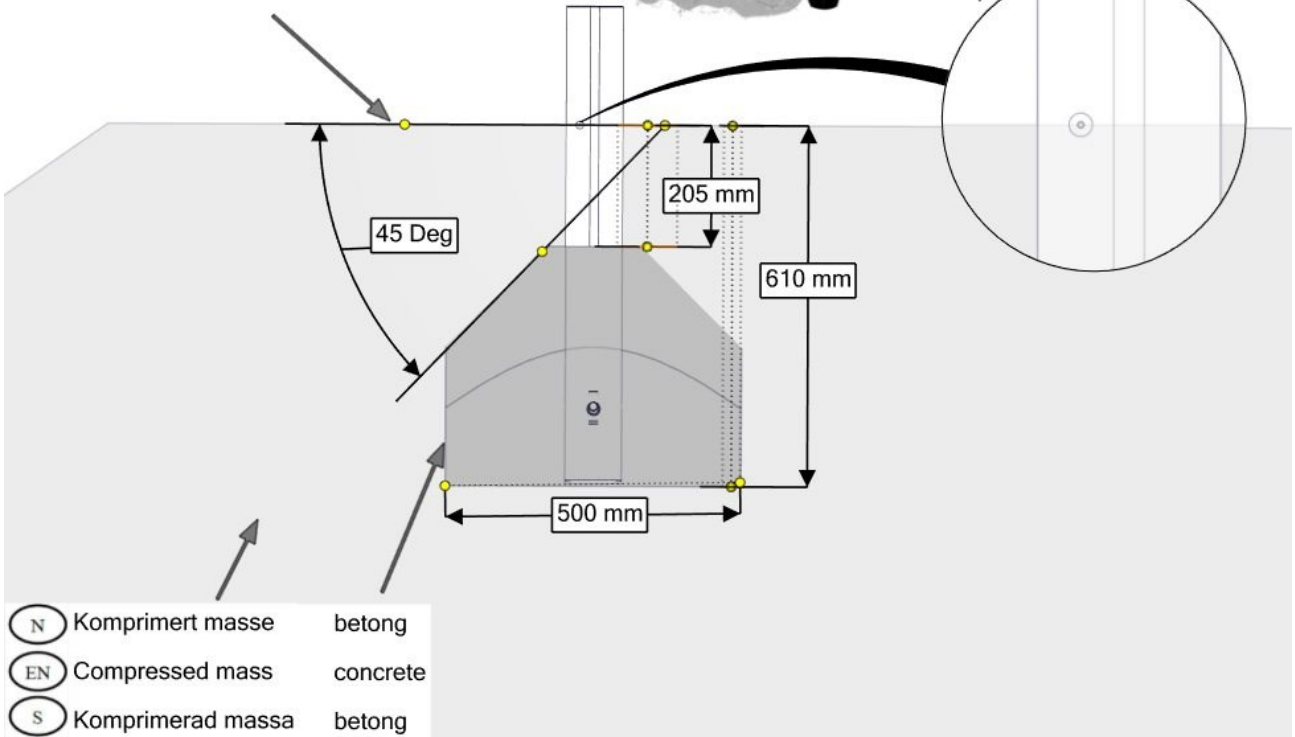

Fundamentering uten betong // Foundation without concrete // Förankring utan betong

- (N) Støtdempende materialer Ref NS-EN 1176-1
- (EN) Impact attenuating materials §4.2.8.5
- (S) Stötdämpande material

- (N) Bakkenivå
- (EN) Ground level
- (S) Marknivå

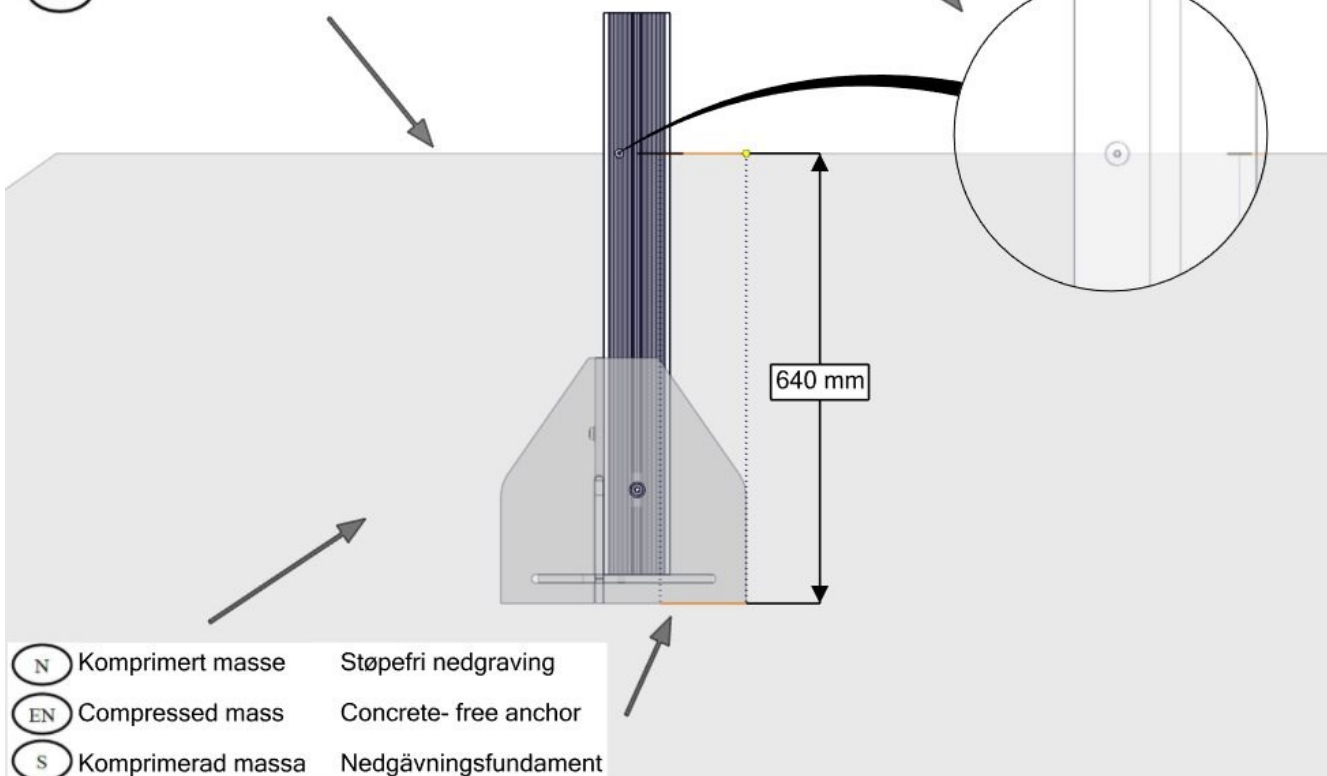

Overflatemontering, Surface mounting, Ytmontering

Ref
NS-EN 1176-1
§4.2.8.5

(N) (EN) (S)
Bakkenivå Ground level marknivå

Tykkelse/Thickness

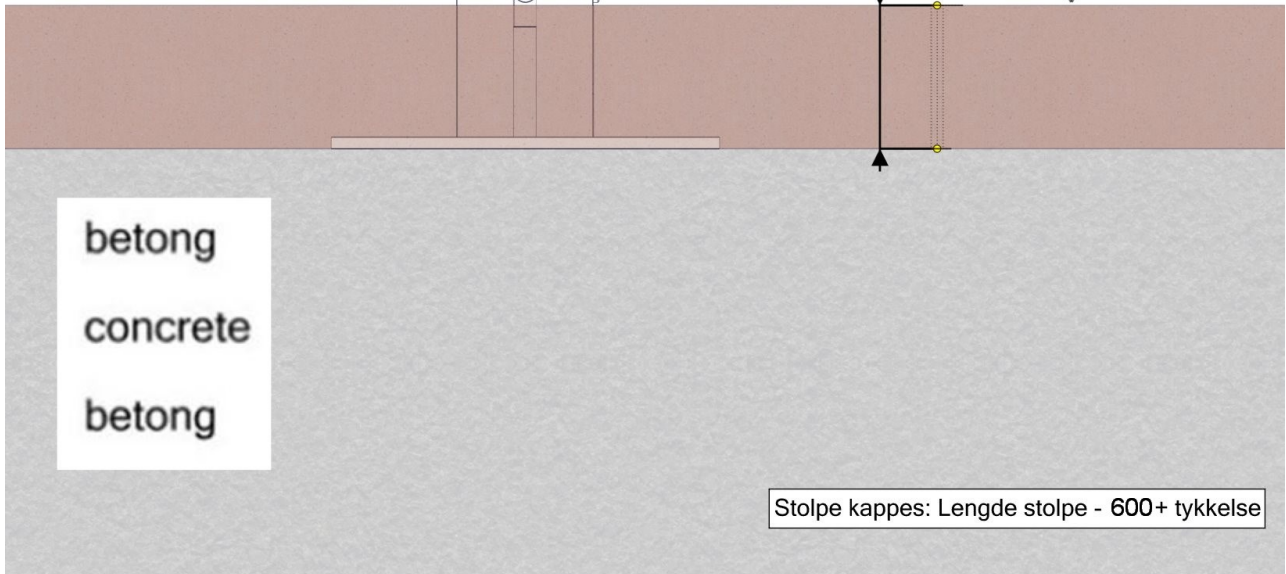

betong
concrete
betong

Stolpe kappes: Lengde stolpe - 600+ tykkelse

Når du har overflatemonteringsfundamenter bruk korte skurer på nedeste festepunkter.

If you are using 0-level anchors use short bolt for mounting lower lower parts

04-000-016

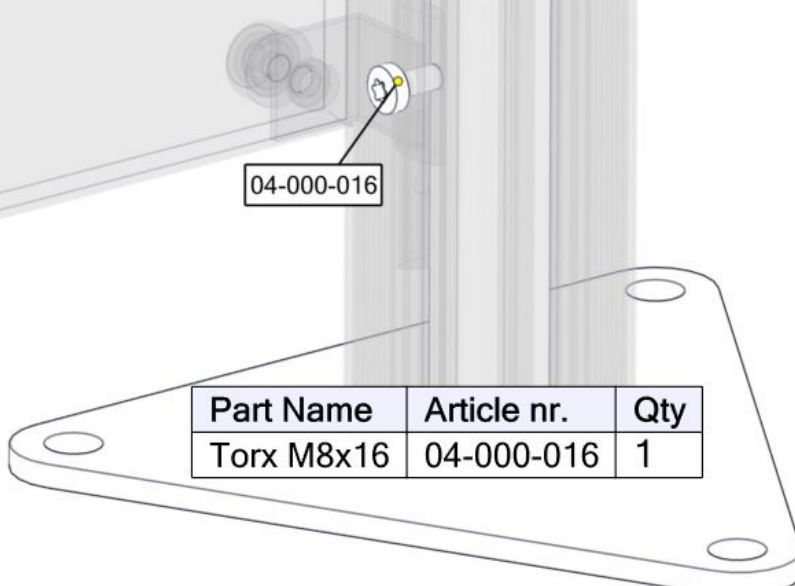

Part Name	Article nr.	Qty
Torx M8x16	04-000-016	1

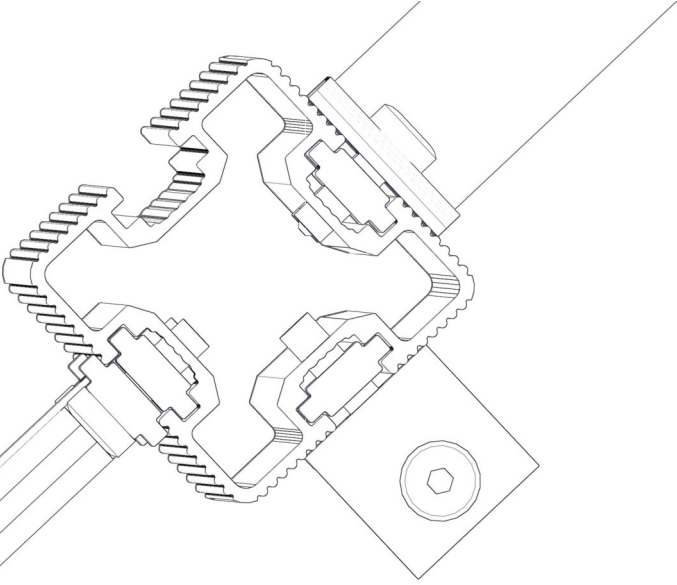
<p>(N) Bolten skrues HELT igjennom aluminiumen. Maks moment: 30Nm</p> <p>(EN) The bolt must be tightened in to the post, so that it peirces the aluminium Max torque: 30Nm</p> <p>(S) Bulten skuvas HELT genom aluminiumen. Maks vridmoment: 30Nm</p>					
NO		Betongkvalitet			
SE		Betongkvalitet	C25/30		
EN		Concrete quality			
NO		Mengde betong			
SE		Mängd betong		0,6	m ³
EN		Amount of concrete			
NO		Fundament størrelse			
SE		Stiftelsestorlek		0,5 x 0,5 x 0,4	m
EN		Foundation size			
NO		For sikkerhet må fundamentene med sand eller myk jord være minst 50% større i areal			
SE		För säkerheten måste grunden med sand eller mjuk jord vara minst 50% större i området			
EN		For safety, the foundations with sand or soft soil must be at least 50% larger in area			
NO		Tyngste element			
SE		Tyngsta element	07-300-411	49,2	Kg
EN		Heaviest element			
NO		Største element			
SE		Största element	07-300-411 SFA5117/1	2,97x0,53x0,45 4,325x0,095x0,095	m
EN		Biggest element			

Fallhøyder / Free height of fall / Fallhöjder

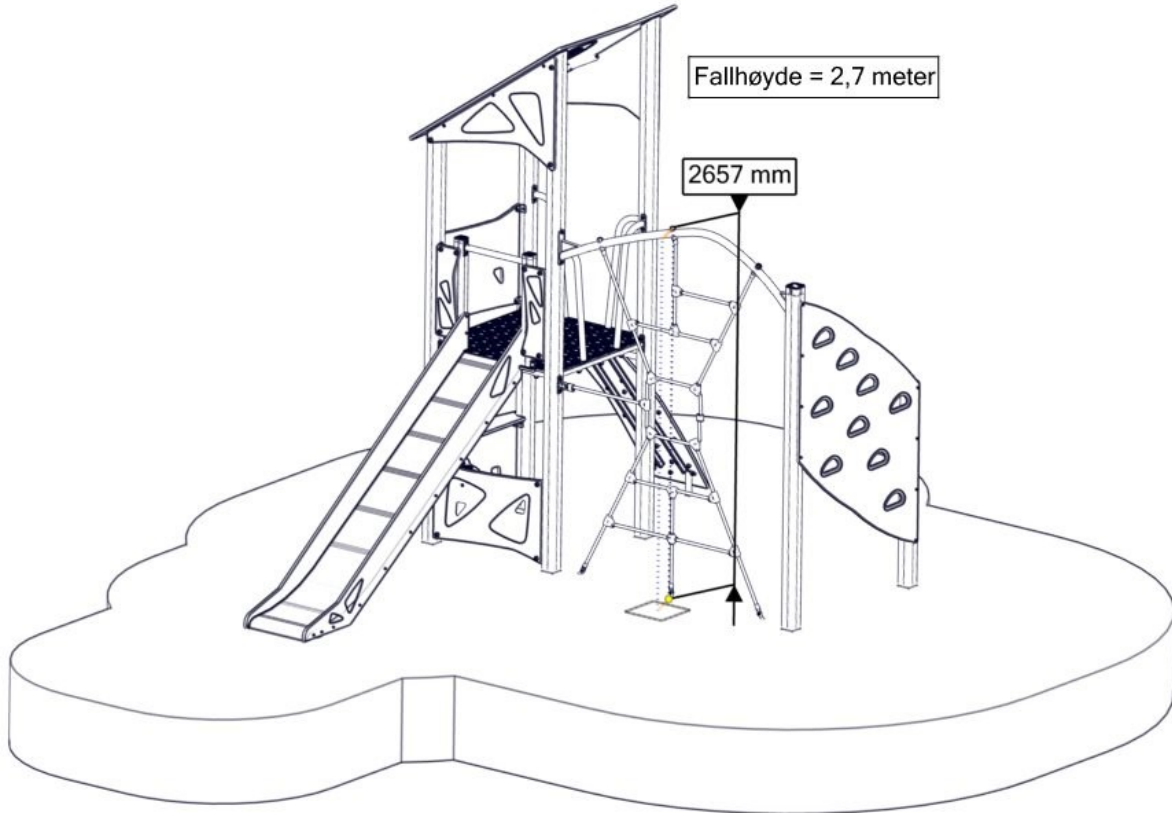

Sikkerhetszone / Safety zone / Säkerhetszon

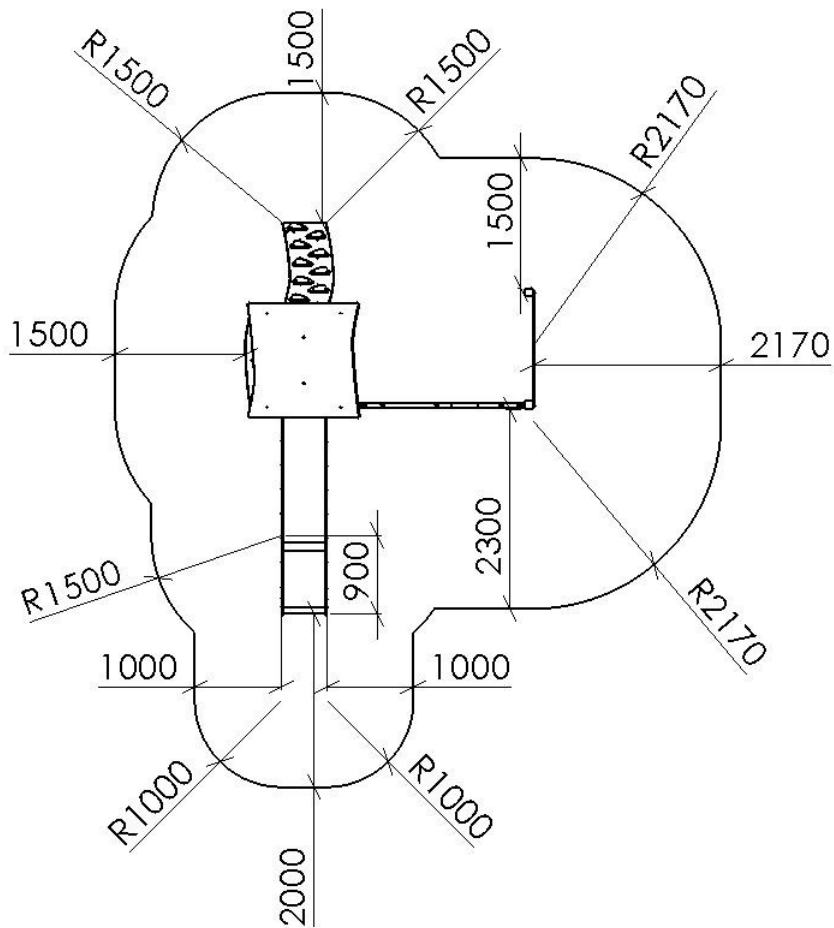

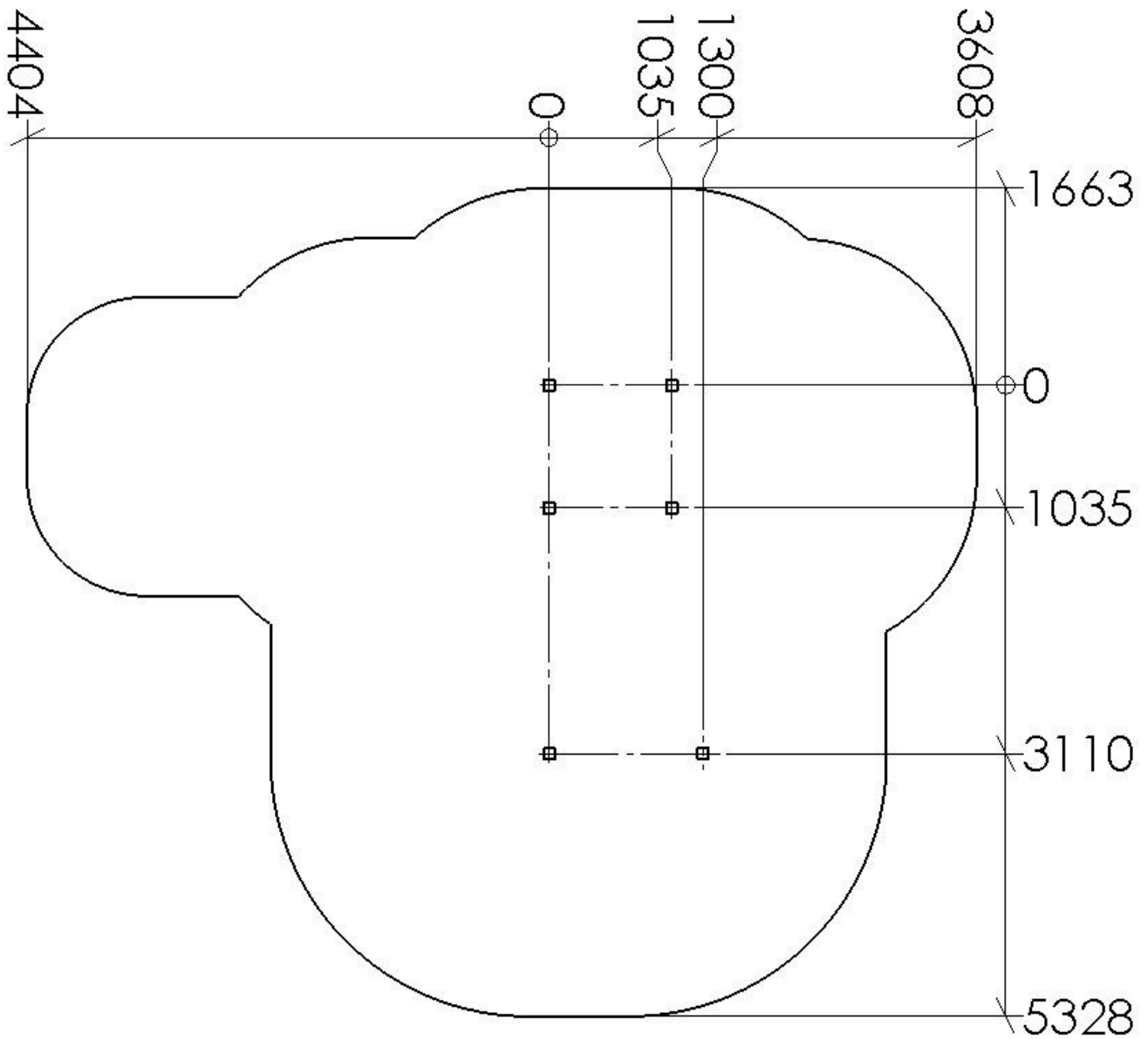
Plassering av forankringer / Ground plan / Placering av förankringar

N

Alle mål er oppgitt i millimeter

EN

Scale measured in mm

S

Alla mått är i millimeter.

Montering av lekeapparatet / Assembly instructions / Montering av lekredskapet

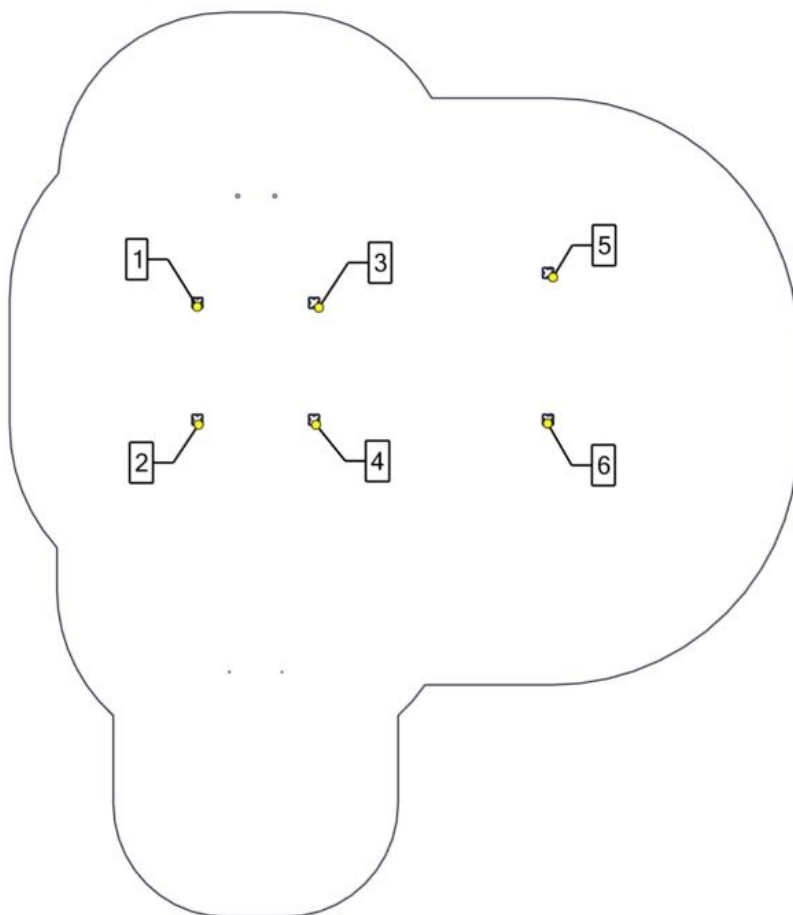

Se separat delmontering for detaljer
 See separate assembly for details
 Se separata delmontering för detaljer

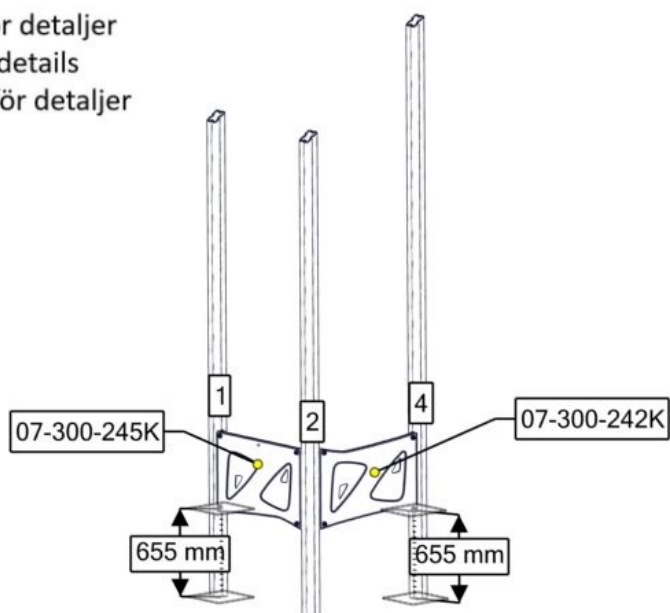

Part Name	Article nr.	Qty
Rekkverk 600x940x19	07-300-242K	1
Rekkverk 600x940x19 butikdisk	07-300-245K	1
Stolpe 95x95 Skrå L=3600	SFA5117/1	2
Stolpe 95x95 Skrå L=4325	SFA5117/1	1

Montering av lekeapparatet / Assembly instructions / Montering av lekredskapet

Se separat delmontering for detaljer
 See separate assembly for details
 Se separata delmontering för detaljer

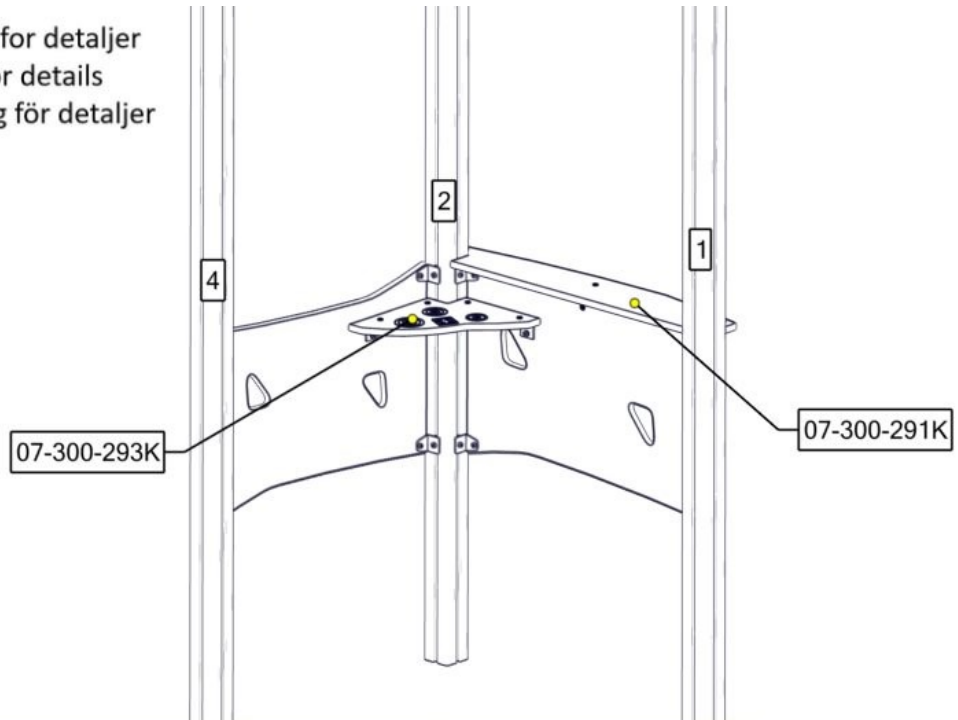

Part Name	Article nr.	Qty
Butikkdisk 1122x200x19 Komplet	07-300-291K	1
Kokeplate	07-300-293K	1

Se separat delmontering for detaljer
 See separate assembly for details
 Se separata delmontering för detaljer

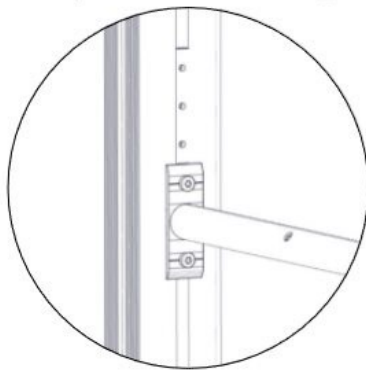

Brikke 120 3xM8
 Montert hos Søve
 Assembled at Søve
 Monterad hos Søve

07-300-321K

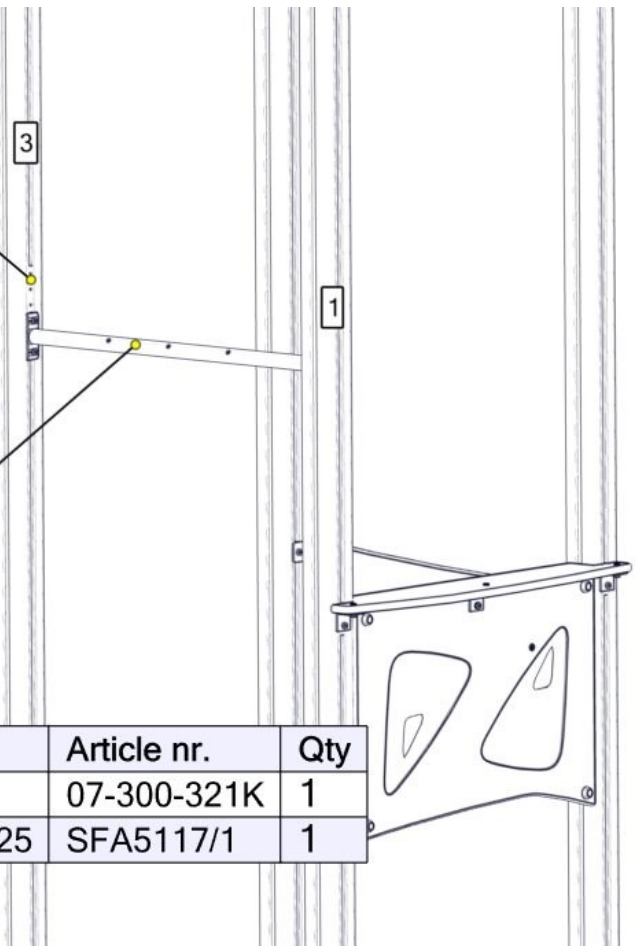

Part Name	Article nr.	Qty
Opptreksplate	07-300-321K	1
Stolpe 95x95 Skrå L=4325	SFA5117/1	1

Montering av lekeapparatet / Assembly instructions / Montering av lekredskapet

Se separat delmontering for detaljer
 See separate assembly for details
 Se separata delmontering för detaljer

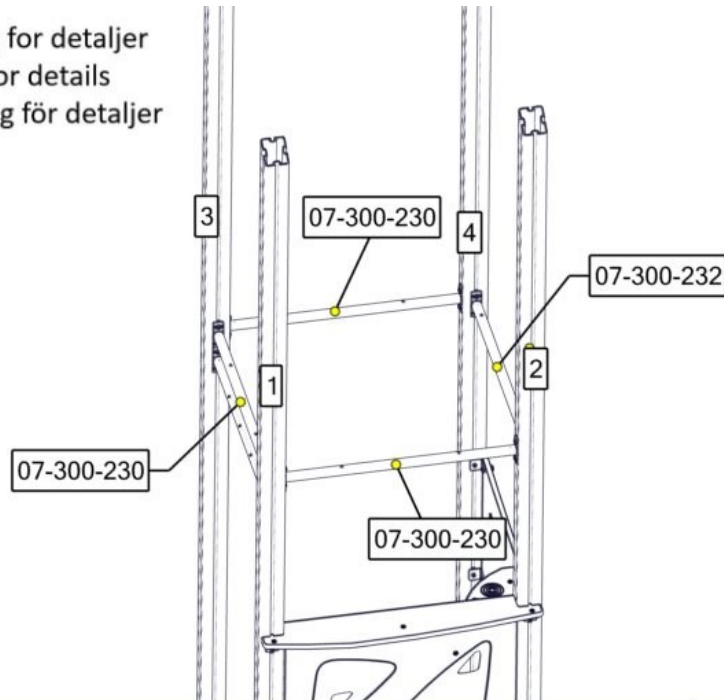

Part Name	Article nr.	Qty
Sperrerør gulv 2 hull cc735 for portal	07-300-232	1
Sperrerør gulv 2 hullcc 470	07-300-230	3
Torx M8x25	04-000-025	16

Se separat delmontering for detaljer
 See separate assembly for details
 Se separata delmontering för detaljer

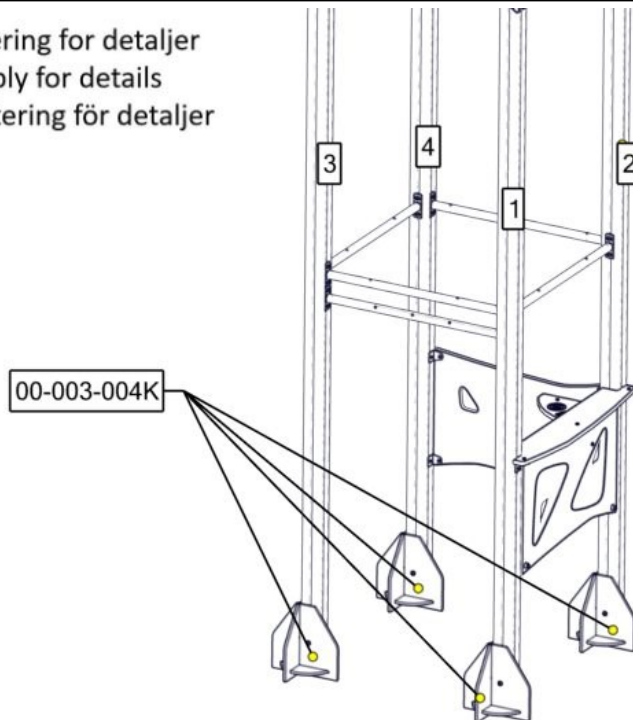

Part Name	Article nr.	Qty
Nedgravingsfundament 95x95	00-003-004K	4

Montering av lekeapparatet / Assembly instructions / Montering av lekredskapet

Se separat delmontering for detaljer
See separate assembly for details
Se separata delmontering för detaljer

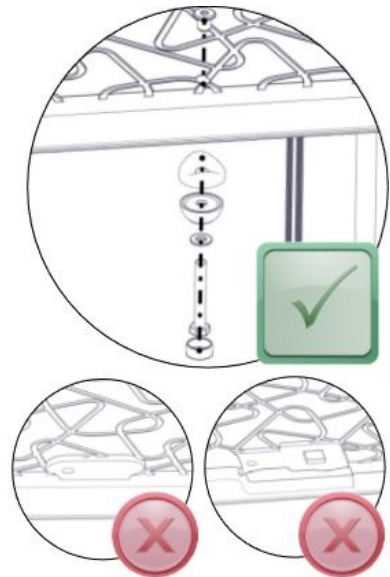
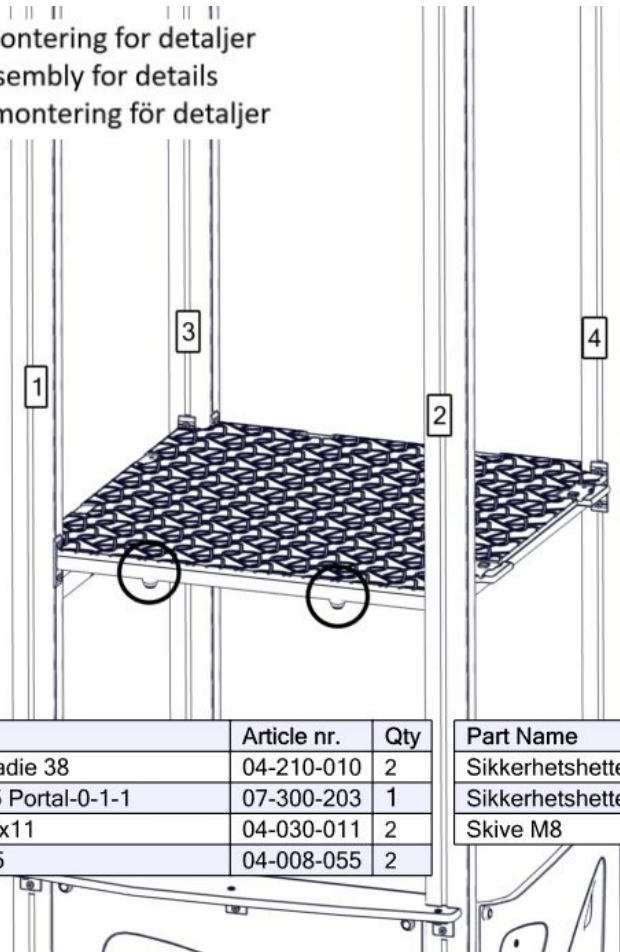

Part Name	Article nr.	Qty
Avstandskive Radie 38	04-210-010	2
Gulv 1075x1155 Portal-0-1-1	07-300-203	1
Møbelknapp M8x11	04-030-011	2
Sekskant M8x55	04-008-055	2

Part Name	Article nr.	Qty
Sikkerhetshette 20mm svart for M8	05-301-044	2
Sikkerhetshette kropp 32 svart for M8	05-301-045	2
Skive M8	04-050-008	2

Se separat delmontering for detaljer
See separate assembly for details
Se separata delmontering för detaljer

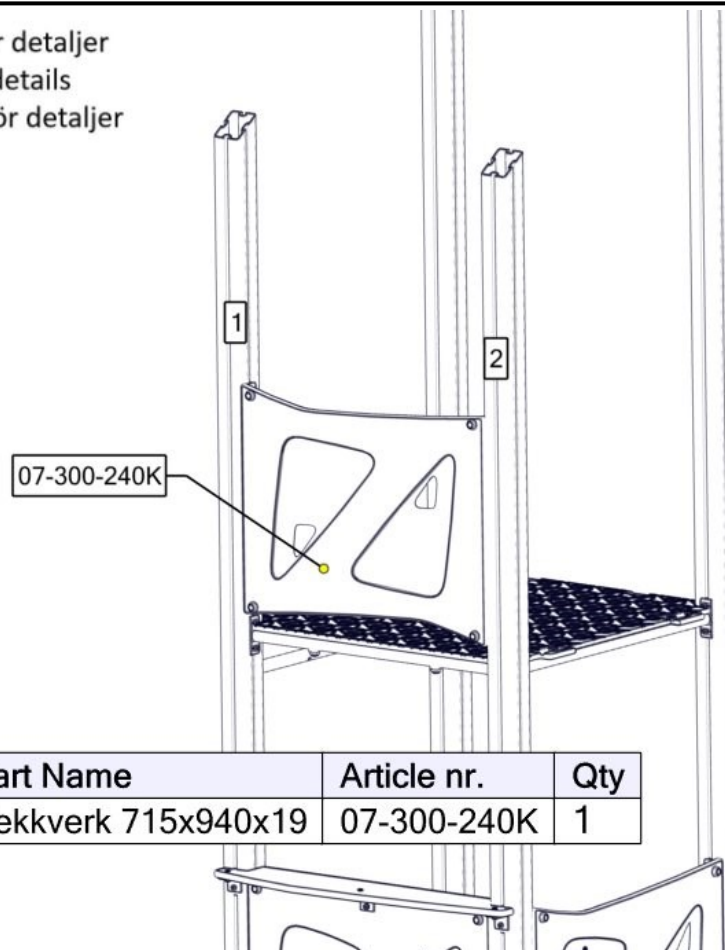

Part Name	Article nr.	Qty
Rekkverk 715x940x19	07-300-240K	1

Montering av lekeapparatet / Assembly instructions / Montering av lekredskapet

Se separat delmontering for detaljer
 See separate assembly for details
 Se separata delmontering för detaljer

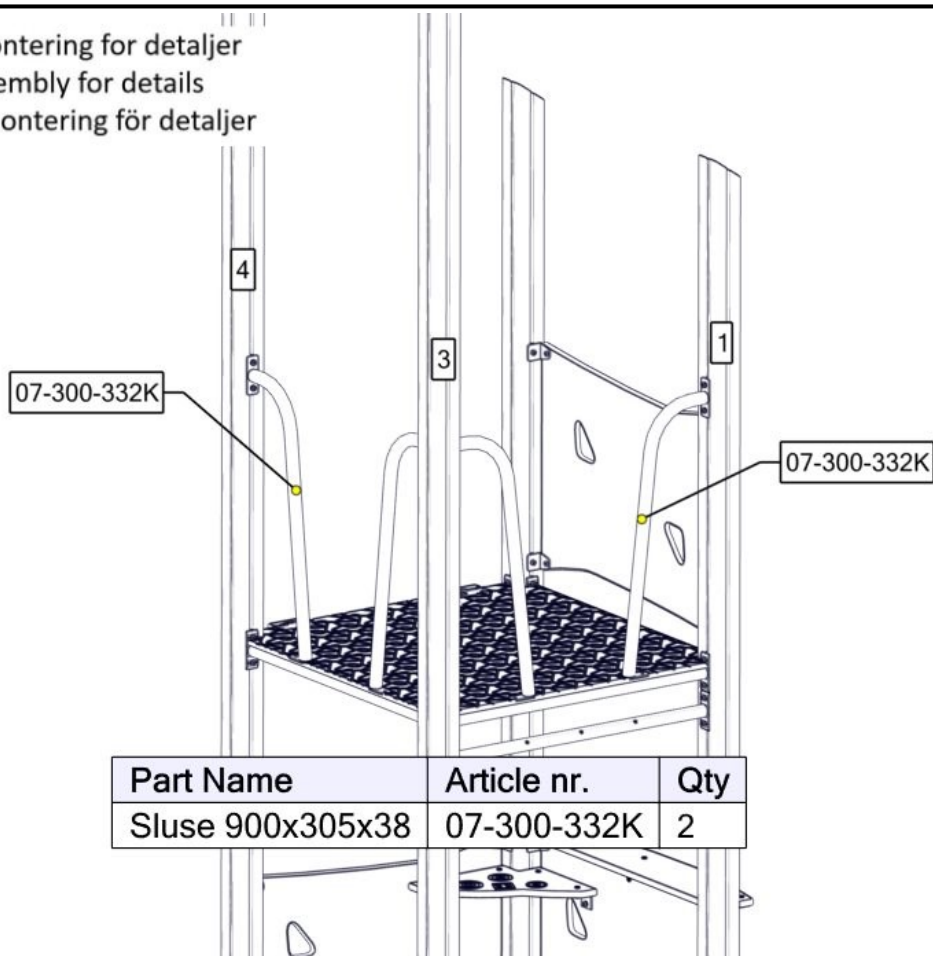

Part Name	Article nr.	Qty
Sluse 900x305x38	07-300-332K	2

Se separat delmontering for detaljer
 See separate assembly for details
 Se separata delmontering för detaljer

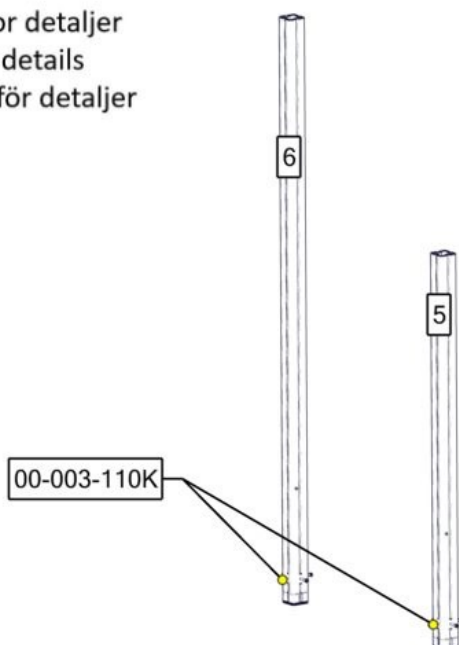

Part Name	Article nr.	Qty
Fundament til støp 95x95 stolpe	00-003-110K	2
Stolpe 95x95 L=2050	SFA5117/1	1
Stolpe 95x95 L=3030	SFA5117/1	1

Montering av lekeapparatet / Assembly instructions / Montering av lekredskapet

Se separat delmontering for detaljer
 See separate assembly for details
 Se separata delmontering för detaljer

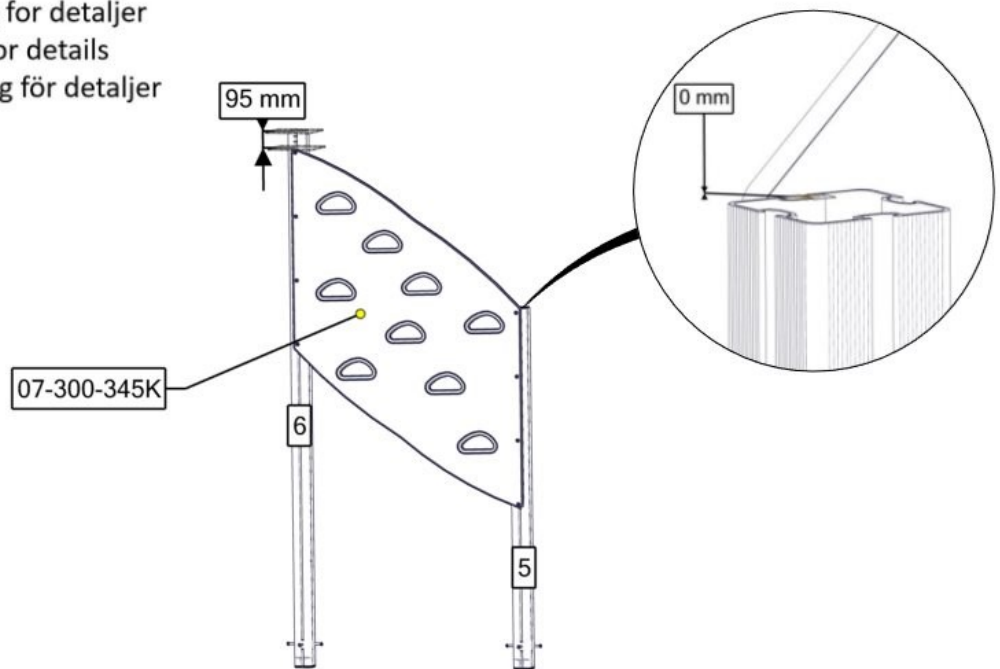

Part Name	Article nr.	Qty
Klatrevegg 2000x1325	07-300-345K	1

Se separat delmontering for detaljer
 See separate assembly for details
 Se separata delmontering för detaljer

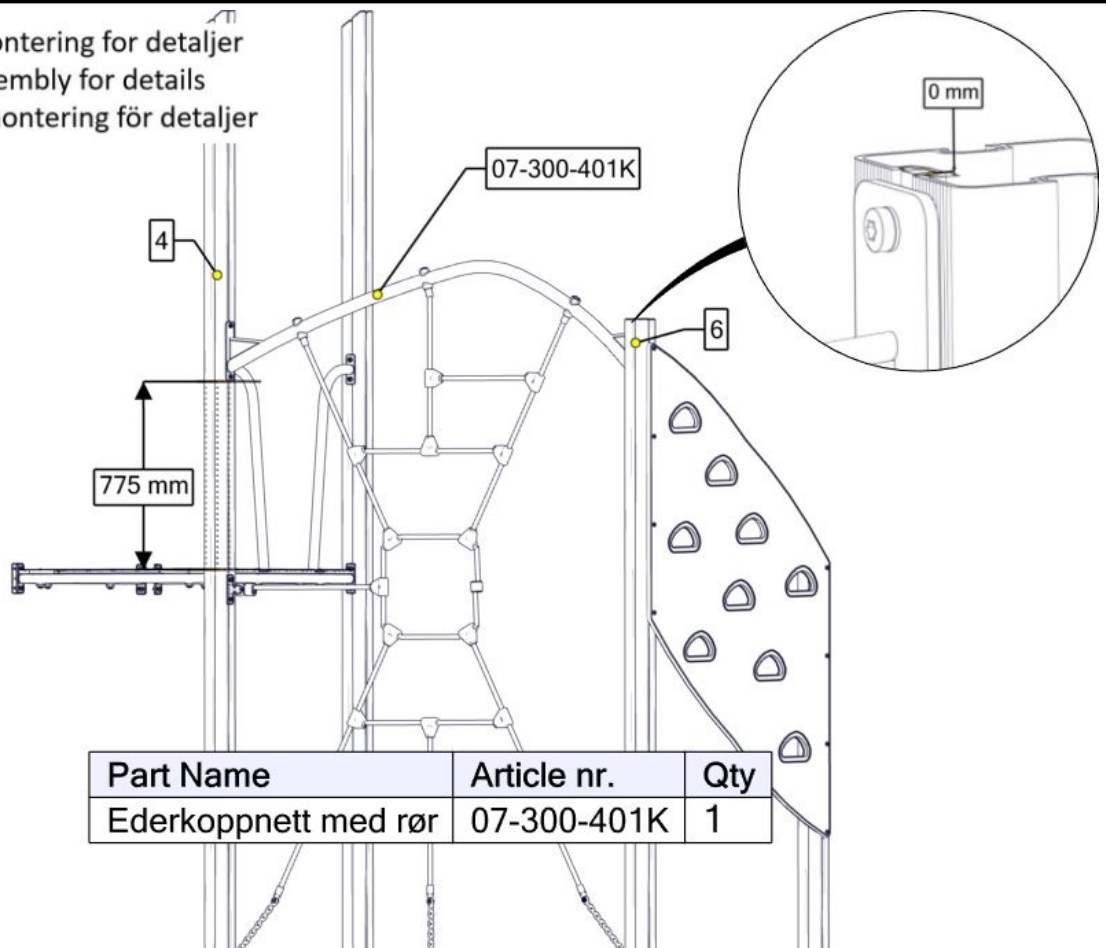

Part Name	Article nr.	Qty
Ederkoppnett med rør	07-300-401K	1

Montering av lekeapparatet / Assembly instructions / Montering av lekredskapet

Se separat delmontering for detaljer
 See separate assembly for details
 Se separata delmontering för detaljer

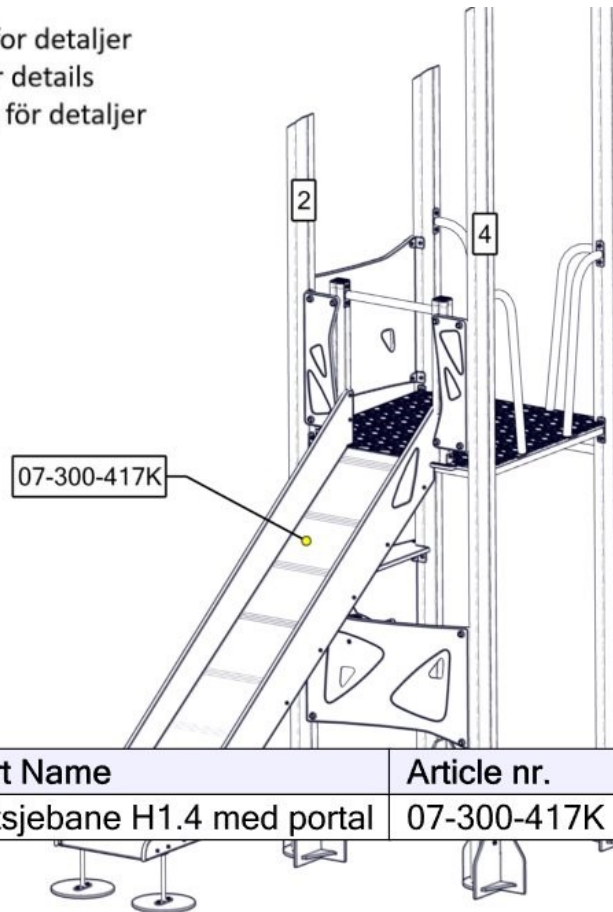

Part Name	Article nr.	Qty
Rutsjebane H1.4 med portal	07-300-417K	1

Se separat delmontering for detaljer
 See separate assembly for details
 Se separata delmontering för detaljer

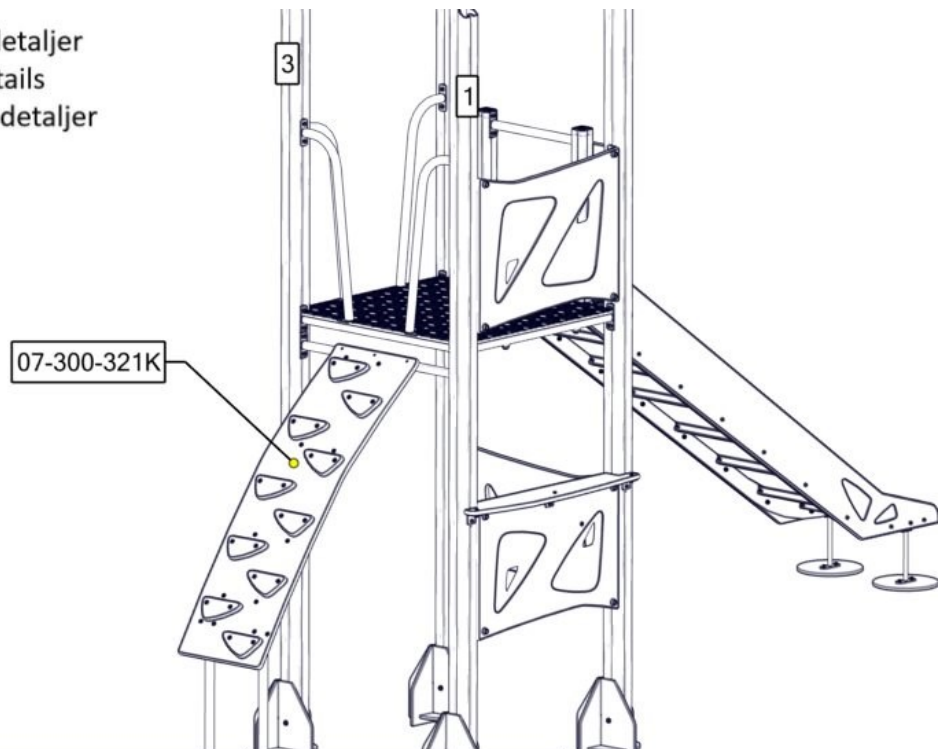

Part Name	Article nr.	Qty
Opptrekksplate	07-300-321K	1

Montering av lekeapparatet / Assembly instructions / Montering av lekredskapet

Se separat delmontering for detaljer
 See separate assembly for details
 Se separata delmontering för detaljer

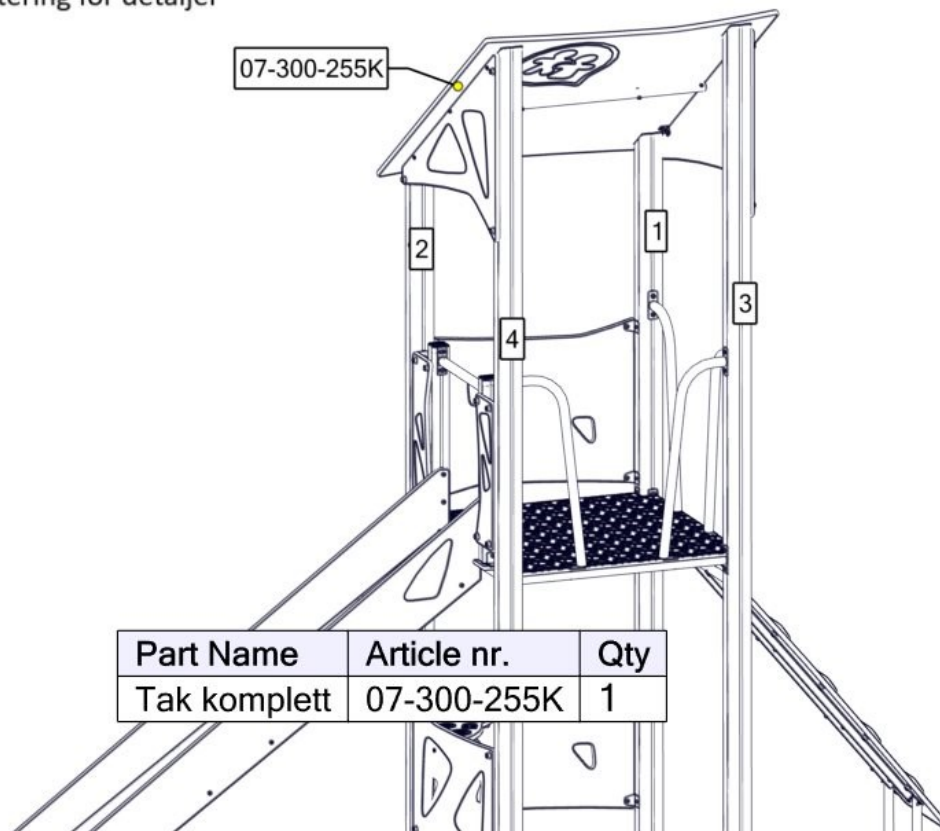



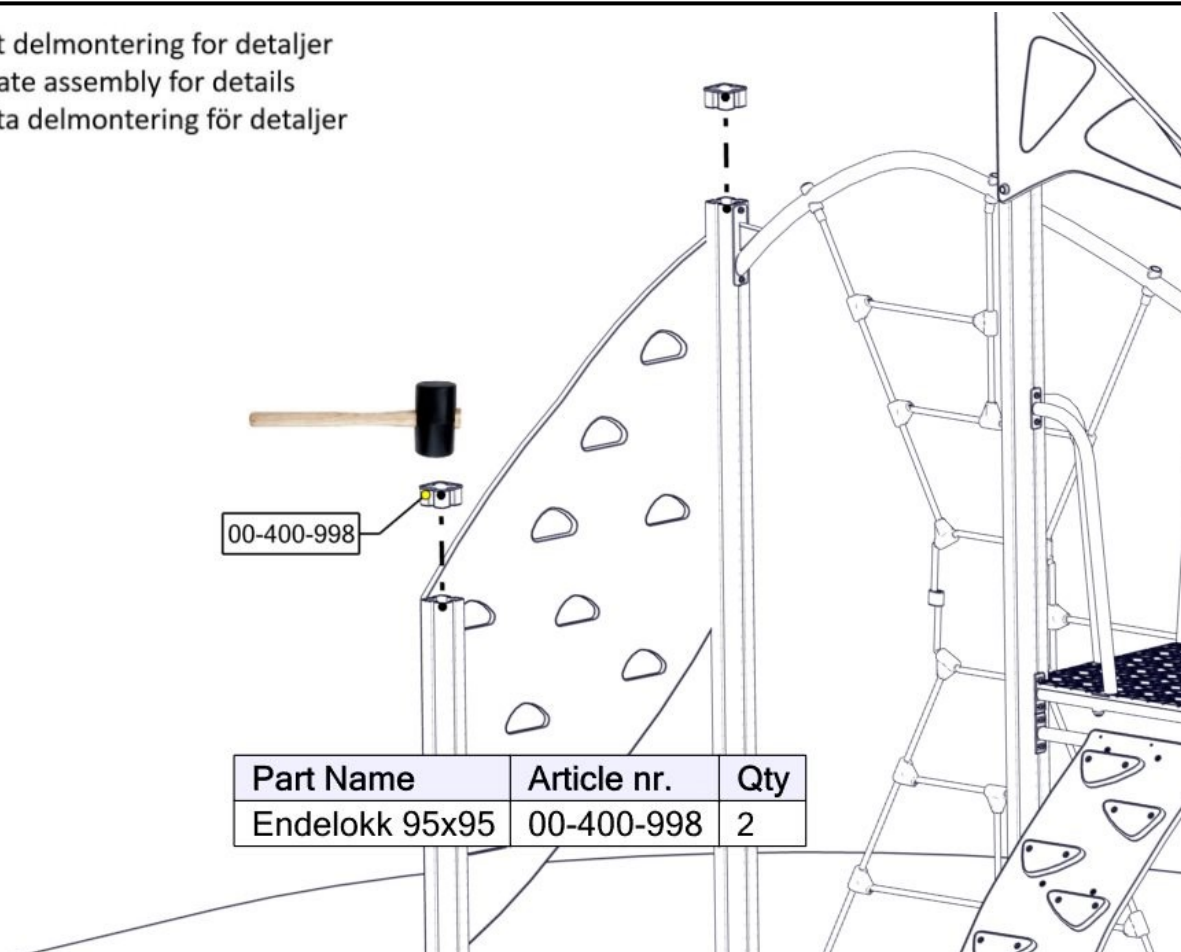

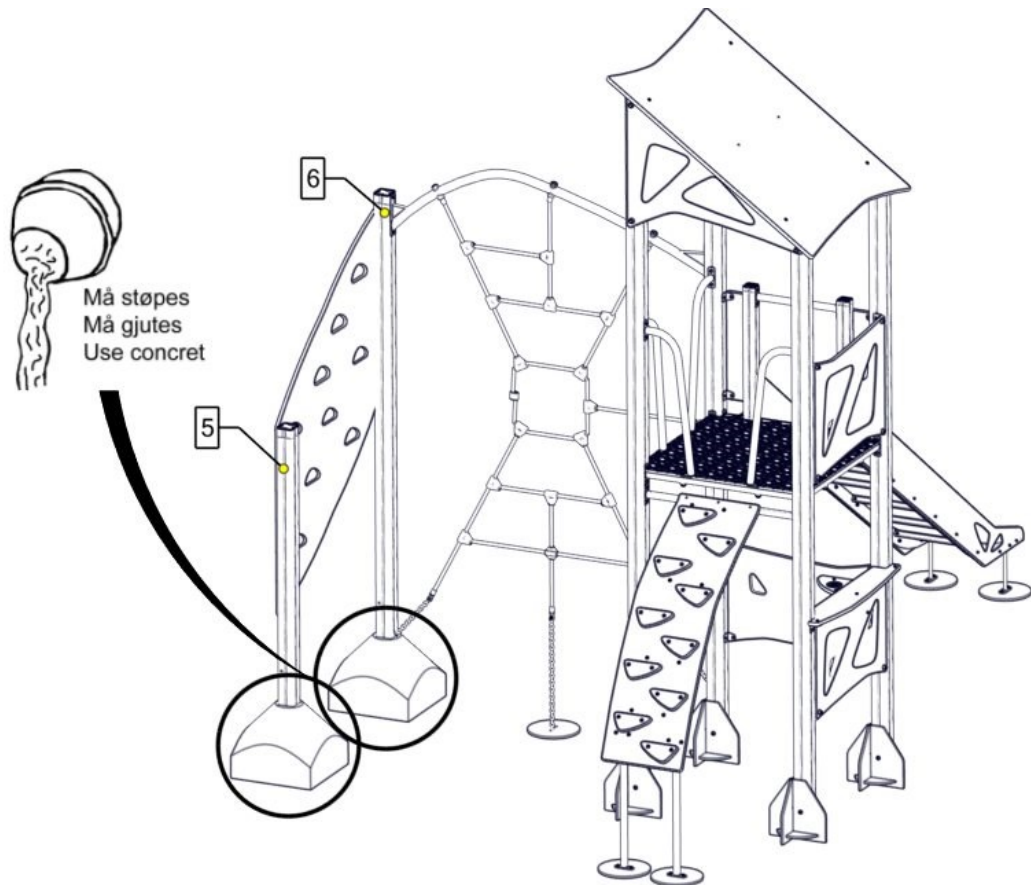
Se separat delmontering for detaljer
 See separate assembly for details
 Se separata delmontering för detaljer



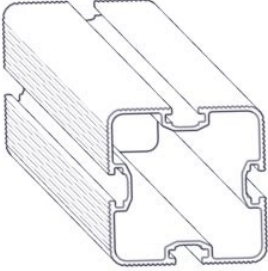
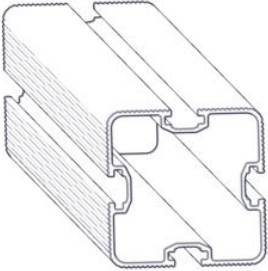
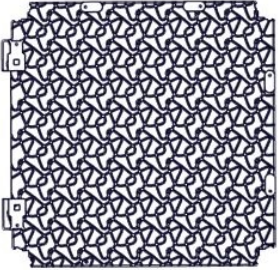
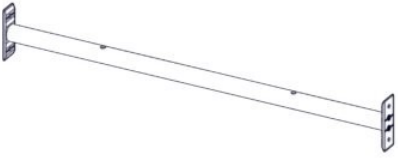



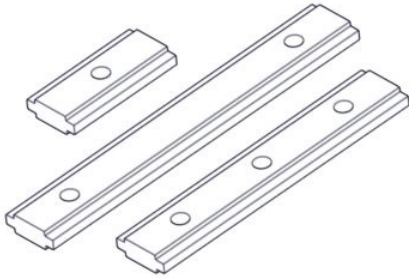

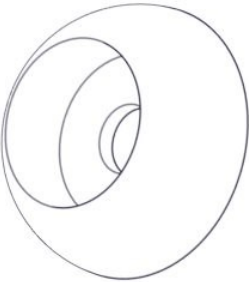
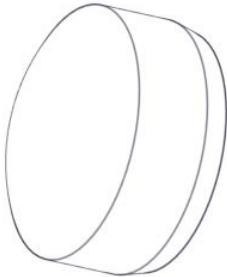
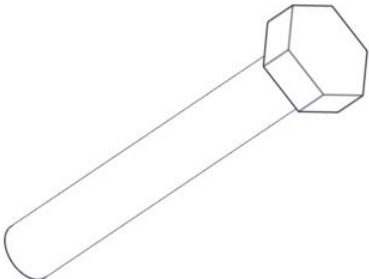
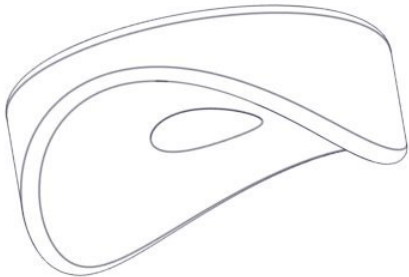

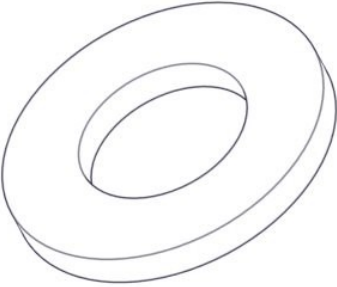
Montering av lekeapparatet / Assembly instructions / Montering av lekredskapet

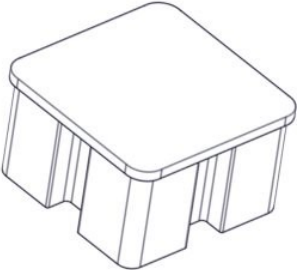
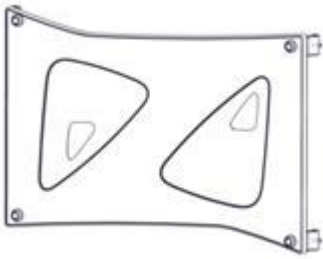
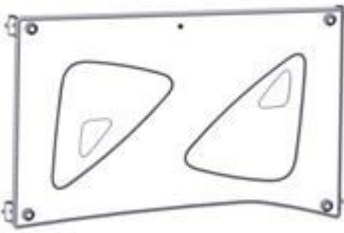
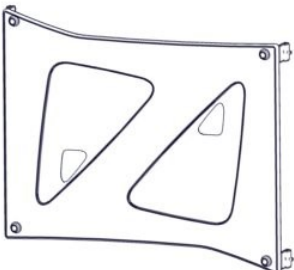
Før utstyret tas i bruk / Before play begins / Innan lekredskapet tas i bruk	
N	<ul style="list-style-type: none"> ● Påse at fallunderlag er utlagt i henhold til gjeldende regler eller vår anbefaling ● Fjern alle monteringshjelpemidler (rester av betong, planker, paller, plast, og lignende) ● Før utstyret tas i bruk, burde man sjekke at det ikke er fare for at anorakksnorer og lignende som kan hekte seg fast noen steder på lekeapparatet. (Vedlagte snor med dobbe (kneledd) kan brukes til å sjekke at dette er i orden. Se vedlagte veiledning for bruk av denne. Dette gjøres for å oppdage eventuelle feilmonteringer.?) ● NB! Bør stå i 2-3 dager før bruk
EN	<ul style="list-style-type: none"> ● Make sure the area and depth of safer surfacing are according to the current standard, or to the manufacturer's recommendation ● Make sure all tools and surplus materials are removed before play begins ● PS! When complete, allow 2-3 days for the concrete to set before use
S	<ul style="list-style-type: none"> ● Kontrollera att fallunderlag är utlagt enligt gällande regler eller vårt rekommendation ● Ta bort alla monteringshjälpmedel (rester av betong, plankor, pallar, plast och liknande) ● Innan lekredskapet används, kontrollera att anoracksnoddar eller kläder/delar av kläder eller liknande inte kan fastna i några delar på redskapet. (Den bipackade "knävringen" kan man med fördel användas för denna kontroll. ● Detta görs för att upptäcka eventuella felmonteringar.)

Boltepakker for / Boltpackage for / Bultpaket för		Sign. _____		
Saturn Hati 2 11-500-031	Navn	Artnr/ dimensjon	Ant	Lev
	Stolpe 95x95 Lengde = 2050 Sort	SFA5117/1	1	
	Stolpe 95x95 Lengde = 3030 Sort	SFA5117/1	1	
	Stolpe 95x95 skrå 55 Lengde = 3600 Sort	SFA5117/1	2	
	Stolpe 95x95 skrå 55 Lengde = 4325 Sort	SFA5117/1	2	
	Gulv 1075x1115x15 Portal-0-1-1 Grå	07-300-203	1	
	Sperrerør for gulv Lengde = 940 2hull cc470 Sort	07-300-230	3	
	Sperrerør for gulv Lengde = 940 2hull cc735 for portal Sort	07-300-232	1	
	Torx M8x25	04-000-025	16	

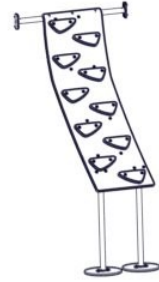

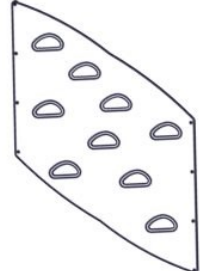
Boltepakker for / Boltpackage for / Bultpaket för		Sign. _____.		
Saturn Hati 2 11-500-031	Navn	Artnr/ dimensjon	Ant	Lev
	Brikke 120 3xM8	04-060-120 (montert hos Søve)	0	
	Møbelknapp M8x11	04-030-011	8	
	Sikkerhets hette kropp	05-301-045	8	
	Sikkerhets hette topp	05-301-044	8	
	Sekskant M8x55	04-008-055	8	
	Avstandskive for Ø38	04-210-010	8	

Boltepakker for / Boltpackage for / Bultpaket för		Sign. _____		
Saturn Hati 2 11-500-031	Navn	Artnr/ dimensjon	Ant	Lev
	Skive M8	04-050-008	8	
	Produktmerke	00-100-400 (montert hos Søve)	0	
	Endelokk til 95x95 stolpe	00-400-998	2	
	Rekkverk 600 x 940 x 19 Oransje	07-300-242K (se egen delmontering)	1	
	Rekkverk butikkdisk 600 x 940 x 19 Oransje	07-300-245K (se egen delmontering)	1	
	Rekkverk 715 x 940 x 19 Oransje	07-300-240K (se egen delmontering)	1	

Boltepakker for / Boltpackage for / Bultpaket för		Sign. _____		
Saturn Hati 2 11-500-031	Navn	Artnr/ dimensjon	Ant	Lev
	Butikkdisk 1122 x 200 x 19 Oransje	07-300-291K (se egen delmontering)	1	
	Kokeplate Oransje	07-300-293K (se egen delmontering)	1	
	Opptreksplate Oransje	07-300-321K (se egen delmontering)	1	
	Sluse 900 x 305 x 38 Lilla	07-300-332K (se egen delmontering)	2	
	Klatrevegg 2000 x 1325 Lilla	07-300-345K (se egen delmontering)	1	
	Edderkoppnett med rør Oransje	07-300-401K (se egen delmontering)	1	

Boltepakker for / Boltpackage for / Bultpaket för

Sign. _____.

Saturn Hati 2 11-500-031	Navn	Artnr/ dimensjon	Ant	Lev
	Rutsjebane med portal Gulvhøyde = 1.4m Oransje / Lilla	07-300-417K (se egen delmontering)	1	
	Tak Oransje	07-300-255K (se egen delmontering)	1	

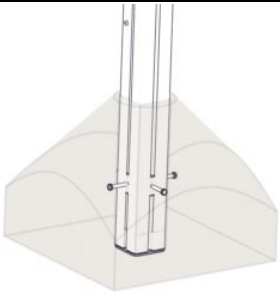
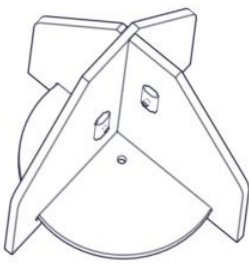
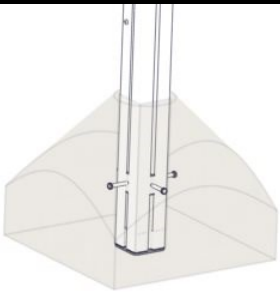
Boltepakker for / Boltpackage for / Bultpaket för		Sign. _____		
Saturn Hati 2 11-500-031	Navn	Artnr/ dimensjon	Ant	Lev
	Fundament Støp			
	Støpefundament 95 x 95 stolpe	00-003-110K (se egen delmontering)	6	
	Fundament Nedgravning			
	Nedgravningsfundament 95 x 95 stolpe	00-003-004K (se egen delmontering)	4	
	Støpefundament 95 x 95 stolpe	00-003-110K (se egen delmontering)	2	

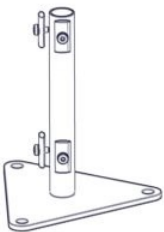
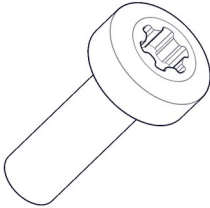
Boltepakker for / Boltpackage for / Bultpaket för		Sign. _____		
Saturn Hati 2 11-500-031	Navn	Artnr/ dimensjon	Ant	Lev
	Overflate fundamentering			
	Fundament 95x95 stolpe for betongdekke	00-003-125K (Se egen delmontering)	6	
	Deler som må Endres, Changed parts			
	Opptreksplate forankring	07-300-321K	(2)	
	Rutsjebane forankring	07-300-417K	(2)	
	Stolpene kappes	SFA5117/1	(6)	
	Bruk kortere bolter når du monterer den nederste delen av veggene	04-000-016	4	

Revisjon:

08.07.2020

Lagt til tabell/Oppdatert

Oppdatert BOM

Oppdatert div view