

N

Monteringsanvisning

EN

Assembly Instructions

S

Monteringsanvisning

Produkt nr. / Product no. / Produkt nr.

11-500-061**Oransje/ lilla**

Ord. nr. _____

Dato. _____

Sign. _____

**søve**

Søve AS
Grønnvoldveien 290
3830 Ulefoss - Norway
Tlf: +47 35 94 65 65
www.sove.no

**søve**

Søve AB
EA Rosengrensgatan 32
421 31 Västra Frölunda
Phone: +46 (0)31 773 97 00
www.sove.se

Monteringstips / Assembly Advice / Monteringsstips

N

- Les monteringsanvisningen nøye før montering.

- Monter elementene i rekkefølgen som vist.
- Boltene bør ikke skrues for hardt til før alt er montert, vatret og loddet. Skru så boltene til.
- NB! Ved bruk av drill, kan boltene ryke.
- På grunn av at solen kan gjøre rutsjeflaten veldig varm, bør rutsjebanens utløp vende mot nord-øst eller nord-vest.
- Er lekeutstyret plassert i naturlige ferdselstraséer må området sikres mot gjennomgang.
- Innspringningshinder bør vurderes rundt lekeapparater hvor det er stor bevegelse, f.eks. ved huskestativ.
- Det bør være fritt innsyn til lekeutstyr som er beregnet for barn under 3 år.

NB! Under monteringsarbeidet må utstyr, som ikke er forankret forsvarlig i bakken, sikres slik at det ikke velte.

Området må avstenges under montering av apparatene med sperrebånd eller lignende.

EN

- Read the instruction carefully before assembling the play unit.

- Assemble the components in the sequence shown in these instructions. Fixings must not be fully tightened during assembly. Before casting the foundations, the structure must be level and plumb, at which point all fixings are tightened. PS! If use of drill, the bolts may be wrecked.
- Avoid positioning the slide facing due south because of overheating – ideal positions are facing north-east or north-west. Secure the construction-area to prevent people from walking through it.
- Consider installing barriers around play-equipment which gives rise to a lot of activity – i.e. swings.
- Ensure that clear vision is possible across the play area so that supervision is possible from any position, particularly where children under 3 years of age will be playing.

NB! During assembly of the equipment, ensure that all structures are securely propped, especially when left overnight. Also ensure that equipment is supported

Monteringstips / Assembly Advice / Monteringsstips**S**

- Läs monteringsanvisningen noga före montering.

- Montera delarna i den ordningen som anvisas
- Skruvarna bör inte skruvas för hårt tills allt är monterat, i våg och lodat.











OBS! Används elektrisk skruvdragare, kan bulten gå sönder. Hårdra därför manuellt!

- Solen kan göra att rutchbanan blir väldigt varm. Banans nedfart rekommenderas att vändas i norrlig riktning
- Om lekplatsen placeras vid en gångväg mm bör området säkras mot genomfart av gående och cyklister.
- Insprängningshinder bör placeras runt lekutrustning med stor rörelse, t ex, gungställning.
- Det bör vara fri insyn till lekutrustning beräknat till barn under 3 år.

OBS! Under monteringsarbete bör utrustningen som inte ska förankras i marken, ställs så att den inte kan välta.

Området måste spärras när lekutrustningen byggs upp, med avspärrningsband eller liknande.

Nødvendig verktøy / Tools required / Nödvändiga verktyg

<p>(N)</p> <p>(EN)</p> <p>(S)</p>	<p>(A)</p> 	<p>(B)</p>  <p>Torx Nr 45</p>	<p>(C)</p> <p>5 mm 6 mm</p> 	<p>(D)</p> 	<p>(E)</p> 
		<p>Metermål Metric measure Tumstock</p> 	<p>Ø11mm Bor Ø11mm Drill Ø11mm Borr</p> 	<p>Merkebånd Mark ribbon Märkeband</p> 	<p>13 + 17mm</p> 

Nødvendig antall personer / Number of persons required / Rekommenderad antal personer



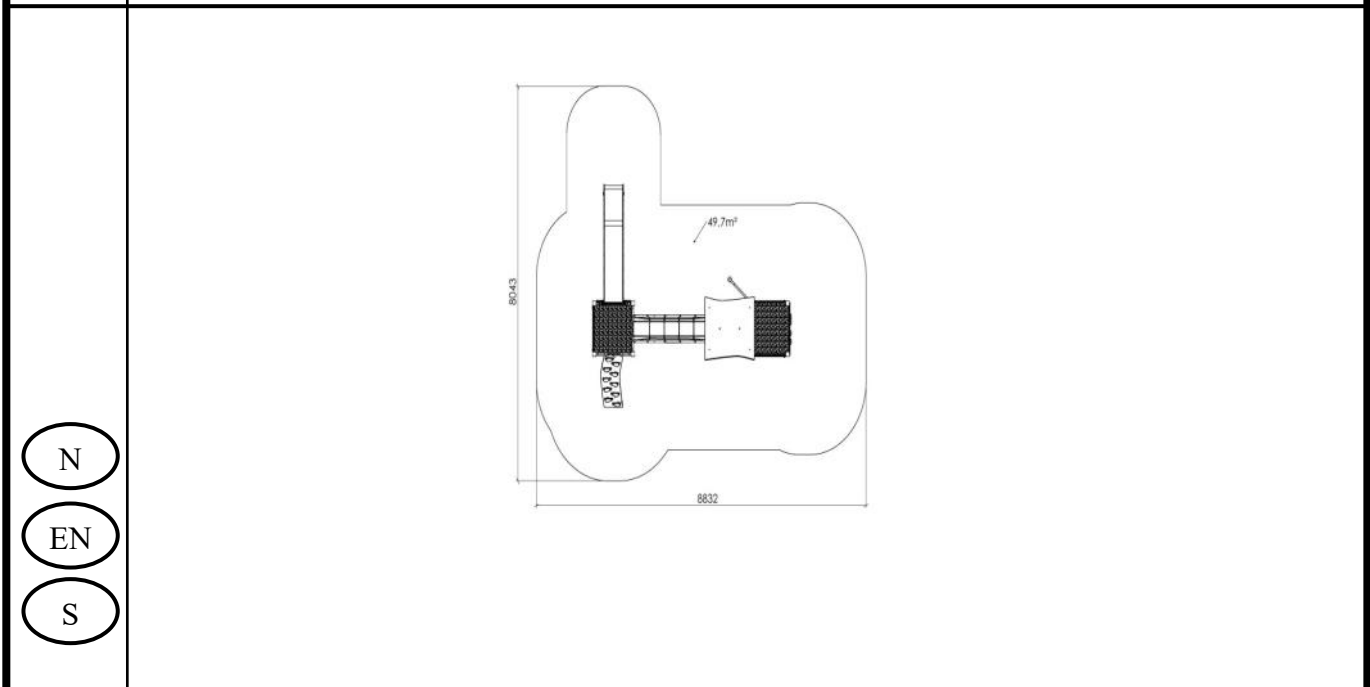

Anbefalt arealbehov ved montering / Recommended working space / Rekommenderad arealbehov vid montering



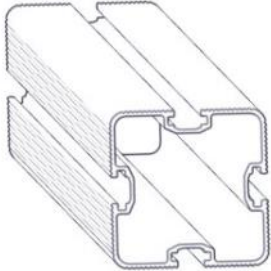
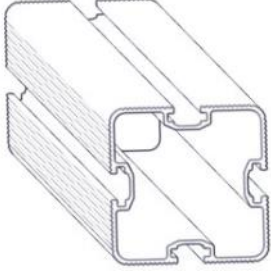

Boltepakker for / Boltpackage for / Bultpaket för

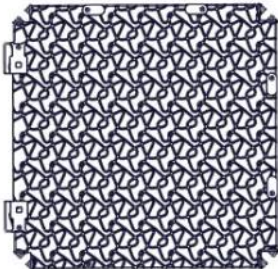
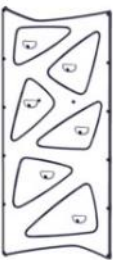
Sign. _____

Saturn Loge 11-500-061	Navn	Artnr/dimensjon	Ant	Lev
	Stolpe 95x95 skrå 55 Lengde = 3600 Sort	SFA5117/1	2	
	Stolpe 95x95 skrå 55 Lengde = 4325 Sort	SFA5117/1	2	
	Stolpe 95x95 Lengde = 3030 Sort	SFA5117/1	6	
	Produktmerke	00-100-400 (Montert hos Søve)	0	
	Gulv med sperrerør For klatrevegg 1080x2140x15 Grå	07-300-222K (Se egen delmontering)	1	
	Gulv med sperrerør 1075x1115 Grå	07-300-202K (Se egen delmontering)	1	
	Klatrevegg 2180x1065x19 Oransje/ lilla	07-300-342K (Se egen delmontering)	1	

Boltepakker for / Boltpackage for / Bultpaket för

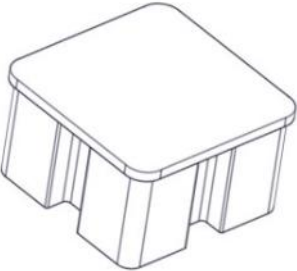
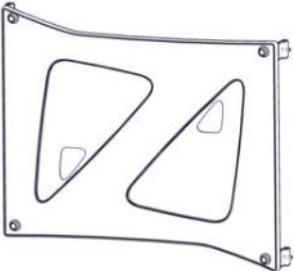
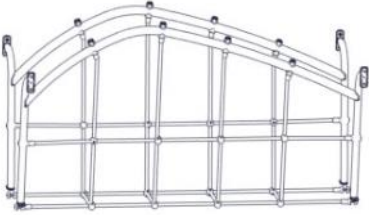
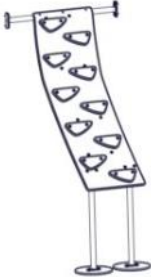
Sign. _____

Saturn Loge 11-500-061	Navn	Artnr/dimensjon	Ant	Lev
	Endelokk 95x95	00-400-998	6	
	Rekkverk 715x940x19 Oransje/ lilla	07-300-240K (se egen delmontering)	4	
	Brua rett Oransje	07-300-385K (Se egen delmontering)	1	
	Opptreksplate komplett Oransje/ lilla	07-300-321K (Se egen delmontering)	1	
	Sluse 900x305x38 Lilla	07-300-332K (Se egen delmontering)	2	
	Rutsjebane H1.4 med portal Oransje/ lilla	07-300-417K (Se egen delmontering)	1	



Boltepakker for / Boltpackage for / Bultpaket för

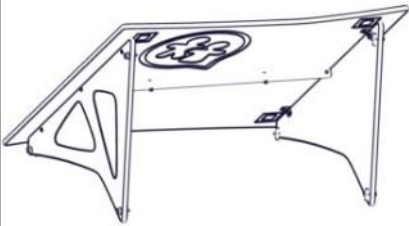

Sign. _____.

Saturn Loge 11-500-061	Navn	Artnr/dimensjon	Ant	Lev
	Brannstang gulv 1,4m L=2675 Lilla	07-300-398K (Se egen delmontering)	1	
	Tak komplett Oransje/ lilla	07-300-255K (Se egen delmontering)	1	

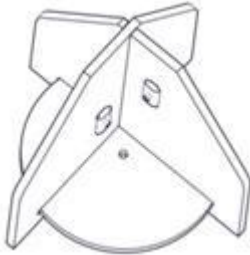
Boltepakker for / Boltpackage for / Bultpaket för

Sign. _____

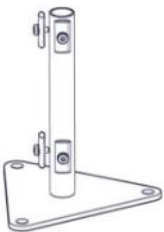
Saturn Loge 11-500-061	Navn	Artnr/ dimensjon	Ant	Lev
	<u>For nedgraving</u>			
	Nedgravingsfundament 95x95	00-003-004K (se egen delmontering)	10	
	<u>For støping</u>			
	Støpe fundament	00-003-110K	10	

Boltepakker for / Boltpackage for / Bultpaket för		Sign. _____.		
Saturn Loge 11-500-061	Navn	Artnr/ dimensjon	Ant	Lev
	Overflate fundamentering			
	Fundament 95x95 stolpe for betongdekke	00-003-125K (Se egen delmontering)	10	
	Deler som må Endres, Changed parts			
	Opptreksplate forankring	07-300-321K	(2)	
	Rutsjebane forankring	07-300-417K	(2)	
	Brannstang kappes	07-300-398K	(1)	
	Stolpene kappes	SFA5117/1	(10)	
	Bruk kortere bolter når du monterer den nederste delen av veggene	04-000-016	2	

Fundamentering med betong / Foundation concrete / Förankring med betong

- (N) Komprimert masse Ref NS-EN 1176-1
- (EN) Compressed mass §4.2.8.5
- (S) Komprimerad massa



- (N) Bakkenivå
- (EN) Ground level
- (S) marknivå

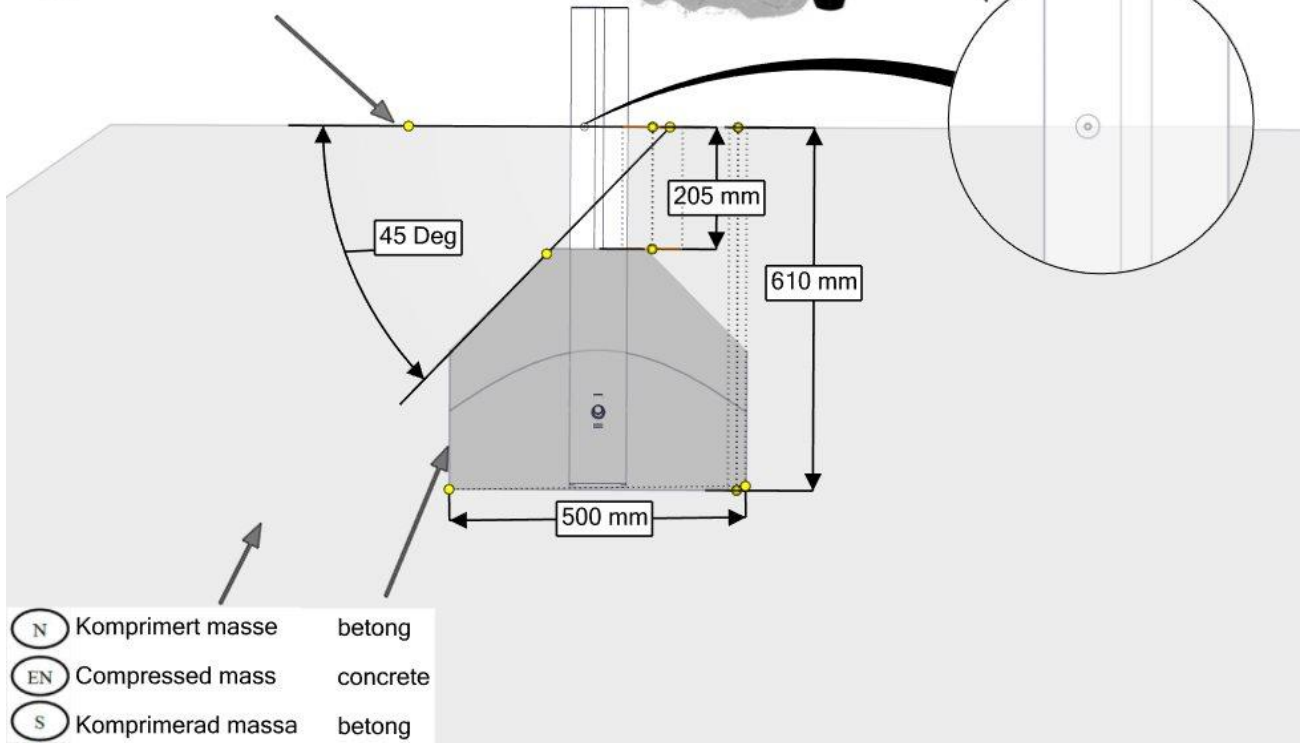

Fundamentering uten betong / Foundation without concrete / Förankring utan betong

- (N) Støtdempende materialer Ref NS-EN 1176-1
- (EN) Impact attenuating materials §4.2.8.5
- (S) Stötdämpande material

- (N) Bakkenivå
- (EN) Ground level
- (S) Marknivå

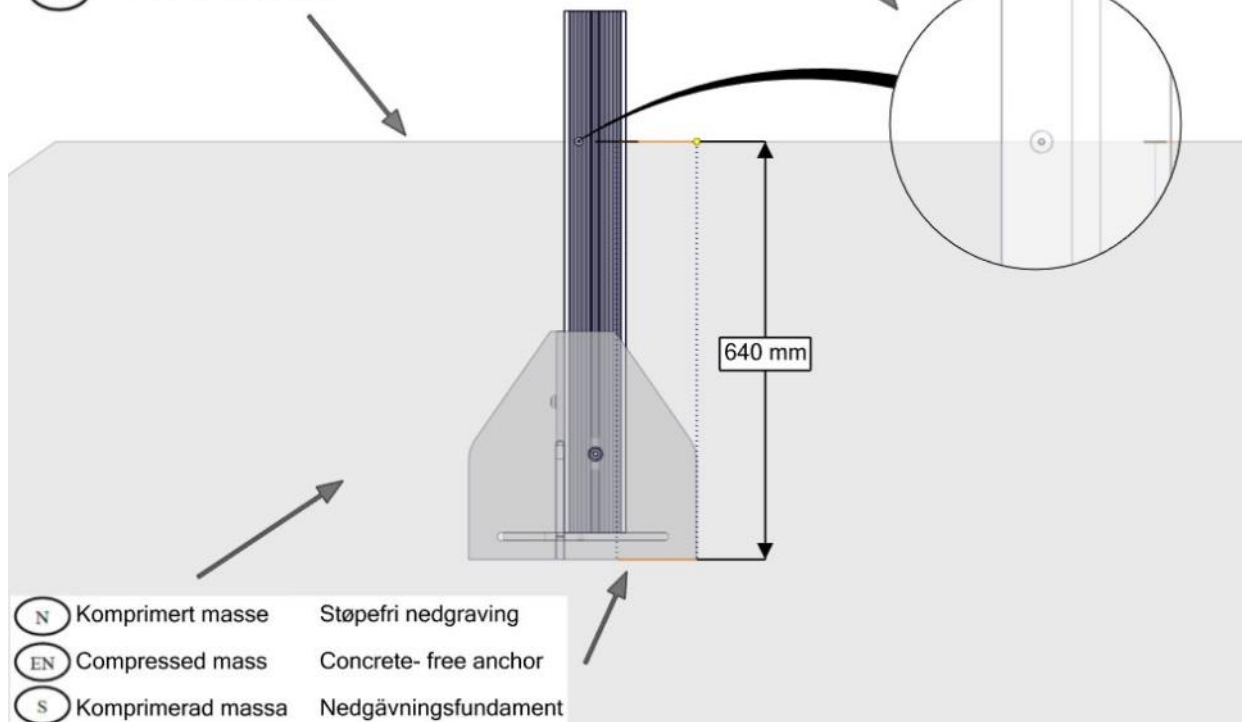

Overflatemontering, Surface mounting, Ytmontering

Ref
NS-EN 1176-1
§4.2.8.5

(N) (EN) (S)
Bakkenivå Ground level marknivå

Tykkelse/Thickness

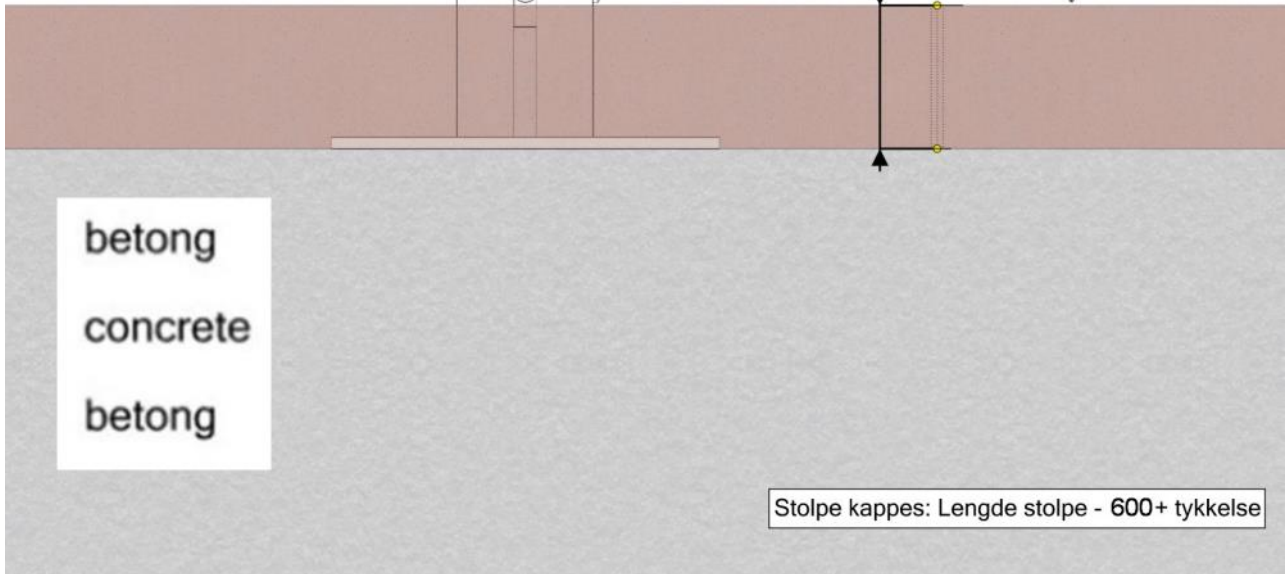

betong
concrete
betong

Stolpe kappes: Lengde stolpe - 600+ tykkelse

Når du har overfalte monteringsfundamenter bruk korte skurer på nedeste festepunkter.

If you are using 0-level anchors use short bolt for mounting lower lower parts

04-000-016

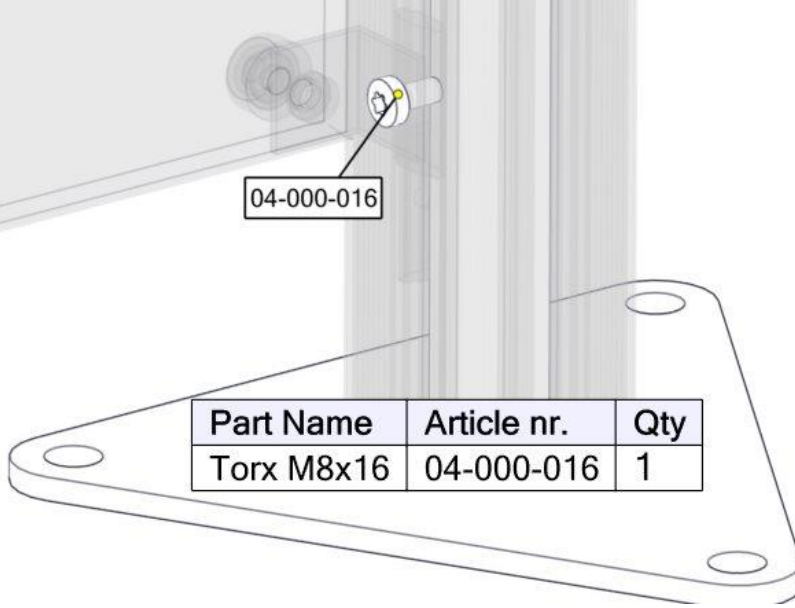

Part Name	Article nr.	Qty
Torx M8x16	04-000-016	1

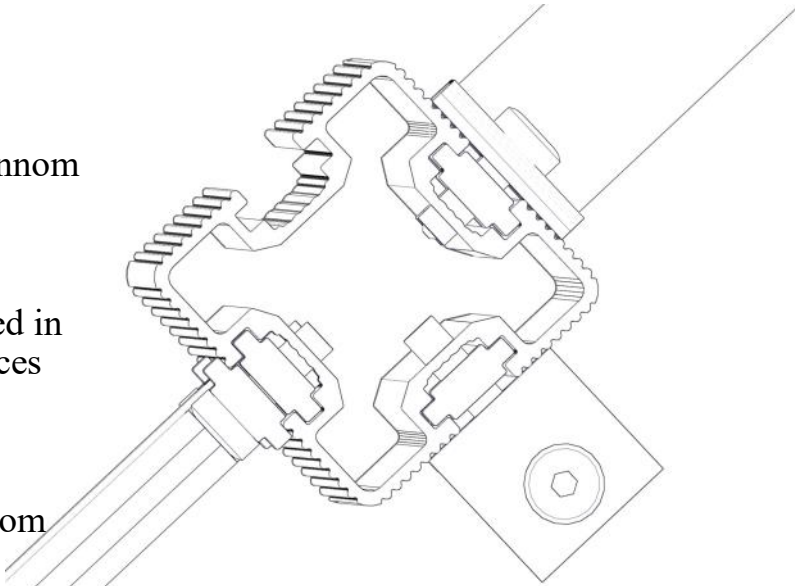
N	<p>Bolten skrues HELT igjennom aluminiumen. Maks moment: 30Nm</p>	
EN	<p>The bolt must be tightened in to the post, so that it pierces the aluminium Max torque: 30Nm</p>	
S	<p>Bulten skuvas HELT genom aluminiumen. Maks vridmoment: 30Nm</p>	

NO	Betongkvalitet	C25/30		
SE	Betongkvalitet			
EN	Concrete quality			
NO	Mengde betong		1	m ³
SE	Mängd betong			
EN	Amount of concrete			
NO	Fundament størrelse		0,5 x 0,5 x 0,4	m
SE	Stiftelsestorlek			
EN	Foundation size			
NO	For sikkerhet må fundamentene med sand eller myk jord være minst 50% større i areal			
SE	För säkerheten måste grunden med sand eller mjuk jord vara minst 50% större i området			
EN	For safety, the foundations with sand or soft soil must be at least 50% larger in area			
NO	Tyngste element	07-300-411	49,2	Kg
SE	Tyngsta element			
EN	Heaviest element			
NO	Største element	07-300-411 SFA5117/1	2,97x0,55x0,61 4,325x0,095x0,095	m
SE	Största element			
EN	Biggest element			

Fallhøyder / Free height of fall / Fallhöjder

Fallhøyde= 2,23 m

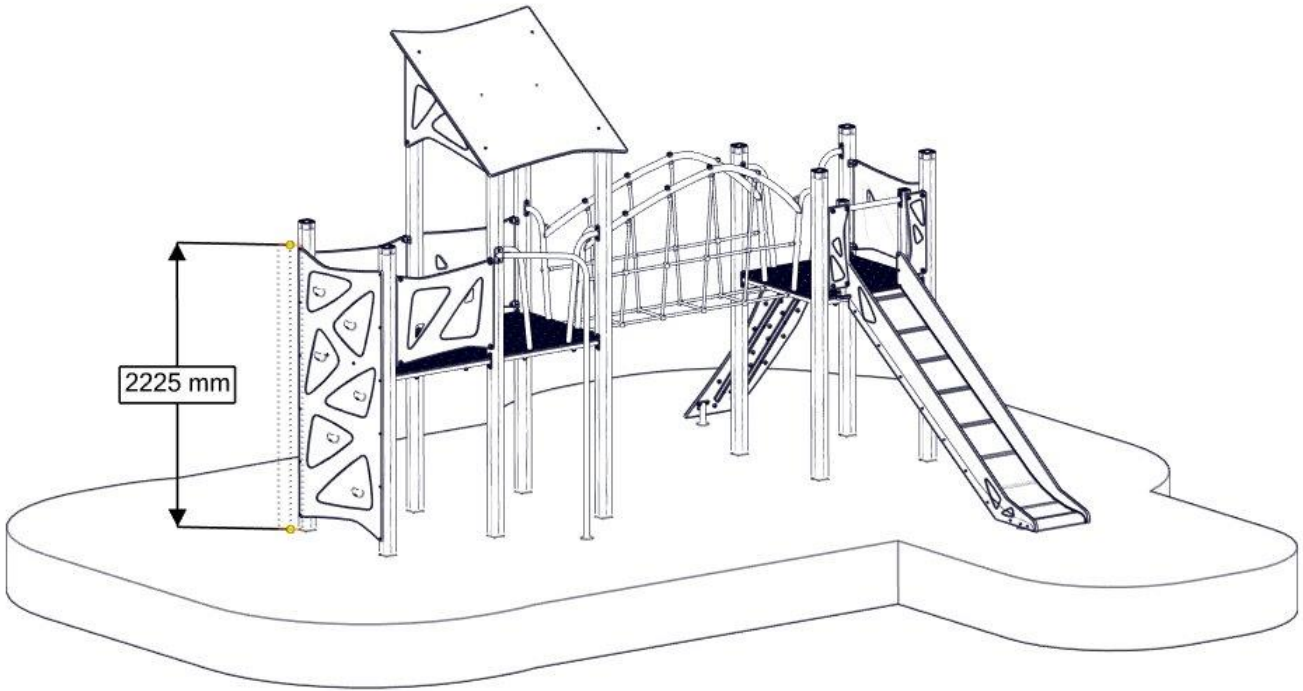

Minimum Sikkerhetszone / Safety zone / Säkerhetszon

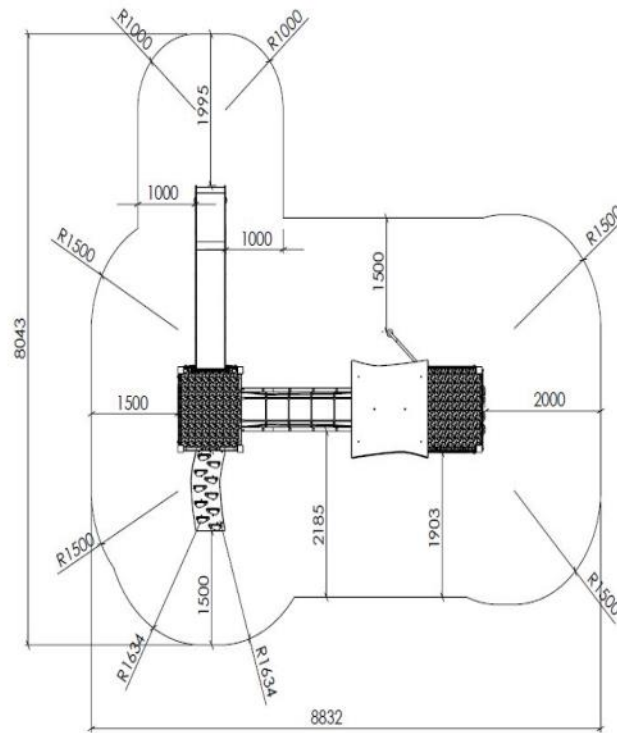

Plassering av forankringer / Ground plan / Placering av förankringar

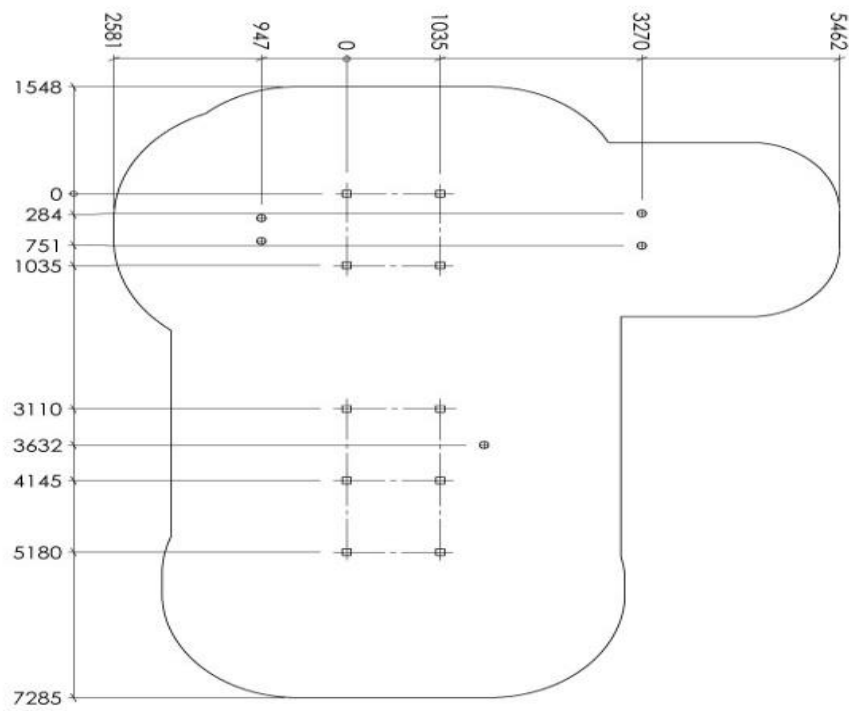

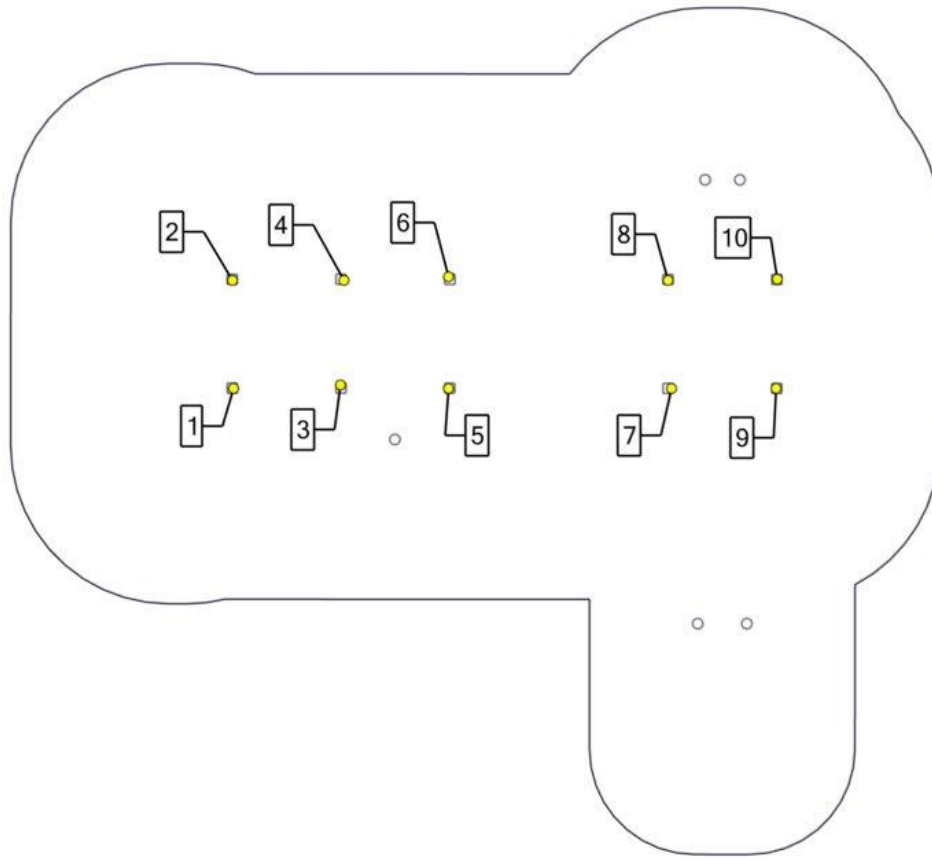

Se separat delmontering for detaljer
 See separate assembly for details
 Se separata delmontering för detaljer

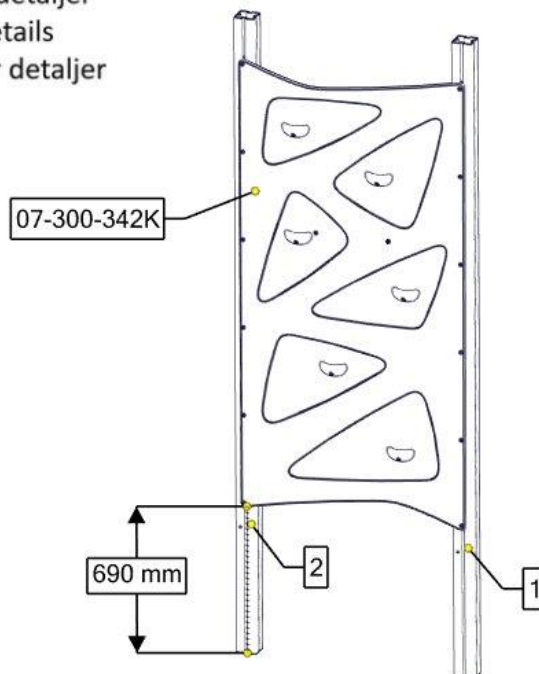

Part Name	Article nr.	Qty
Klatrevegg 2180x1065x19	07-300-342K	1
Stolpe 95x95 L=3030	SFA5117/1	2

Se separat delmontering for detaljer
 See separate assembly for details
 Se separata delmontering för detaljer

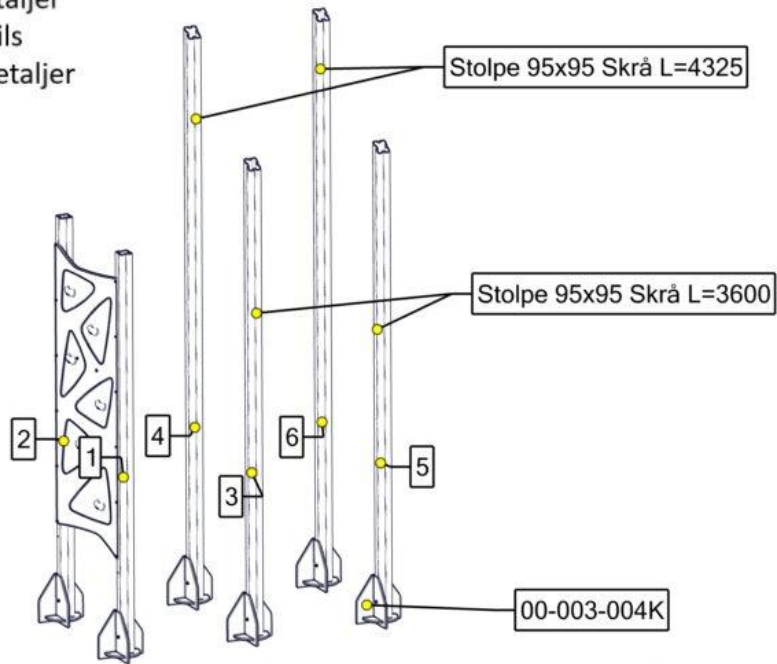

Part Name	Article nr.	Qty
Nedgravingsfundament 95x95	00-003-004K	6
Stolpe 95x95 Skrå L=3600	07-300-310	2
Stolpe 95x95 Skrå L=4325	07-300-311	2

Se separat delmontering for detaljer
 See separate assembly for details
 Se separata delmontering för detaljer

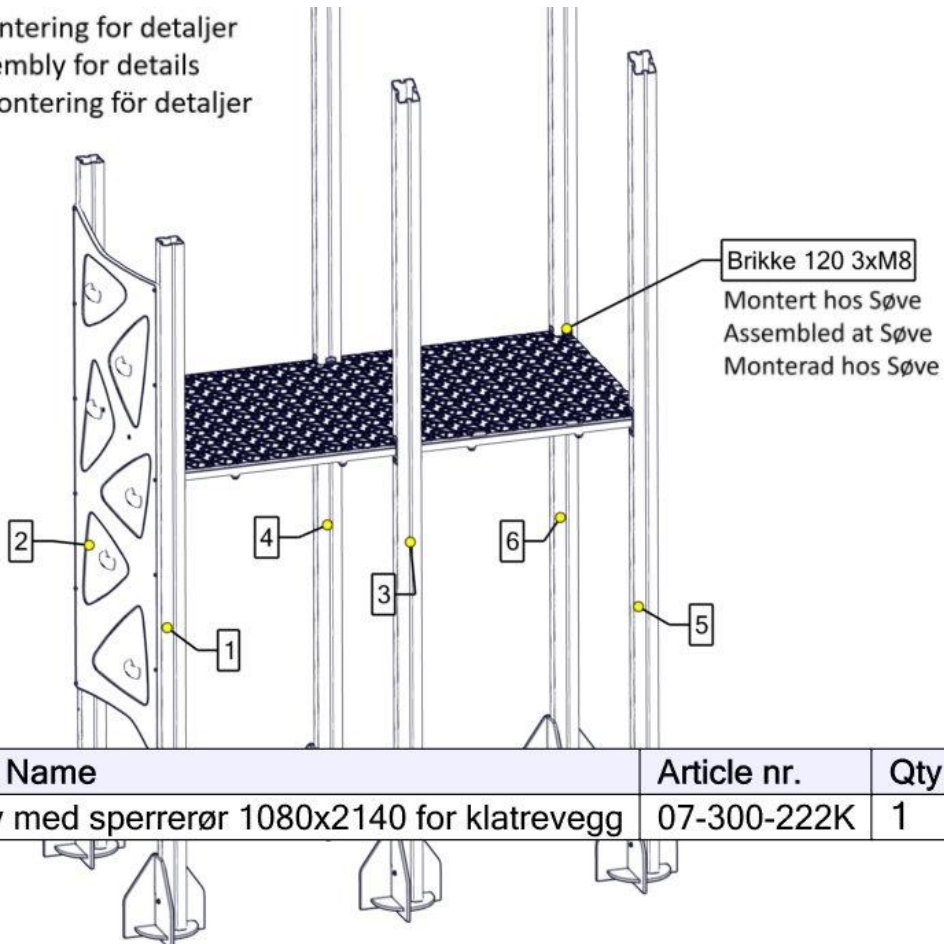

Part Name	Article nr.	Qty
Gulv med sperrerør 1080x2140 for klatrevegg	07-300-222K	1

Se separat delmontering for detaljer
 See separate assembly for details
 Se separata delmontering för detaljer

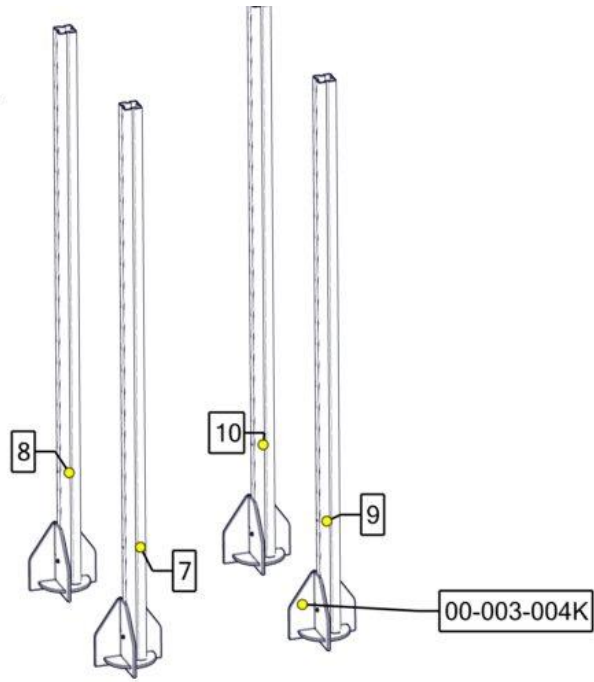

Part Name	Article nr.	Qty
Nedgravingsfundament 95x95	00-003-004K	4
Stolpe 95x95 L=3030	SFA5117/1	4

Se separat delmontering for detaljer
 See separate assembly for details
 Se separata delmontering för detaljer

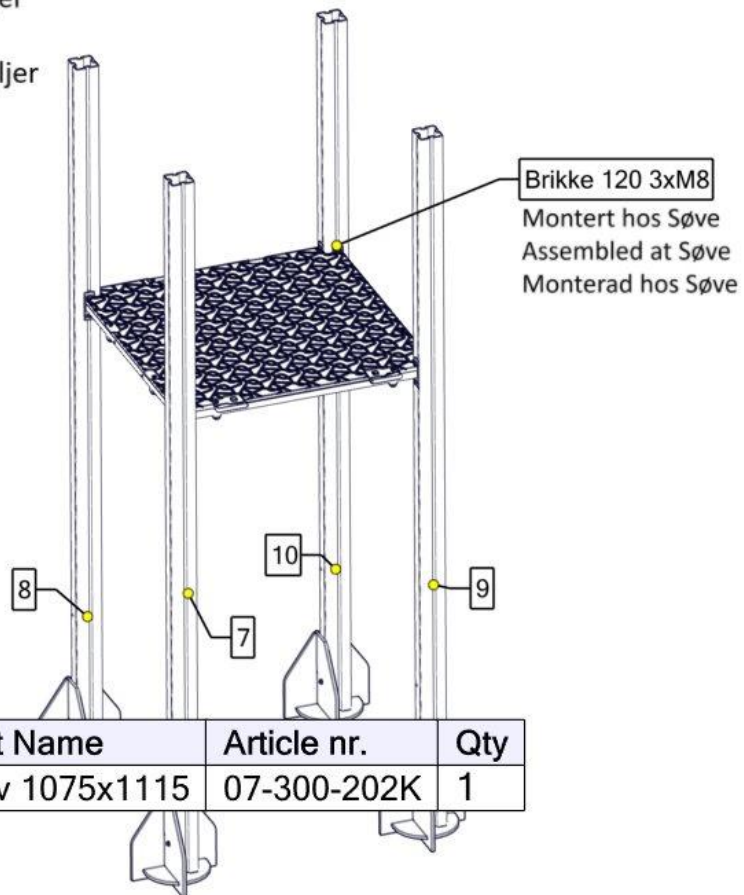

Part Name	Article nr.	Qty
Gulv 1075x1115	07-300-202K	1

Se separat delmontering for detaljer
 See separate assembly for details
 Se separata delmontering för detaljer

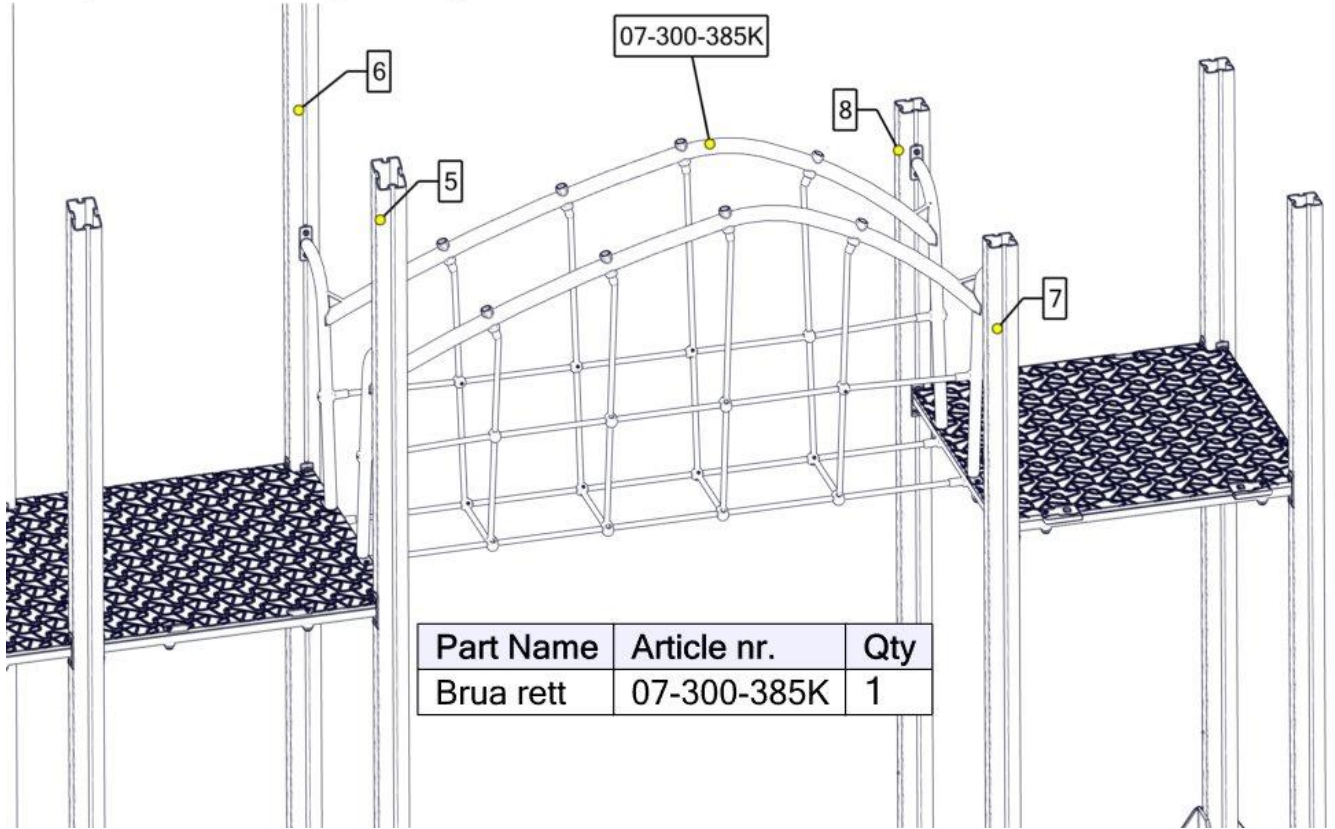

Part Name	Article nr.	Qty
Brua rett	07-300-385K	1

Se separat delmontering for detaljer
 See separate assembly for details
 Se separata delmontering för detaljer

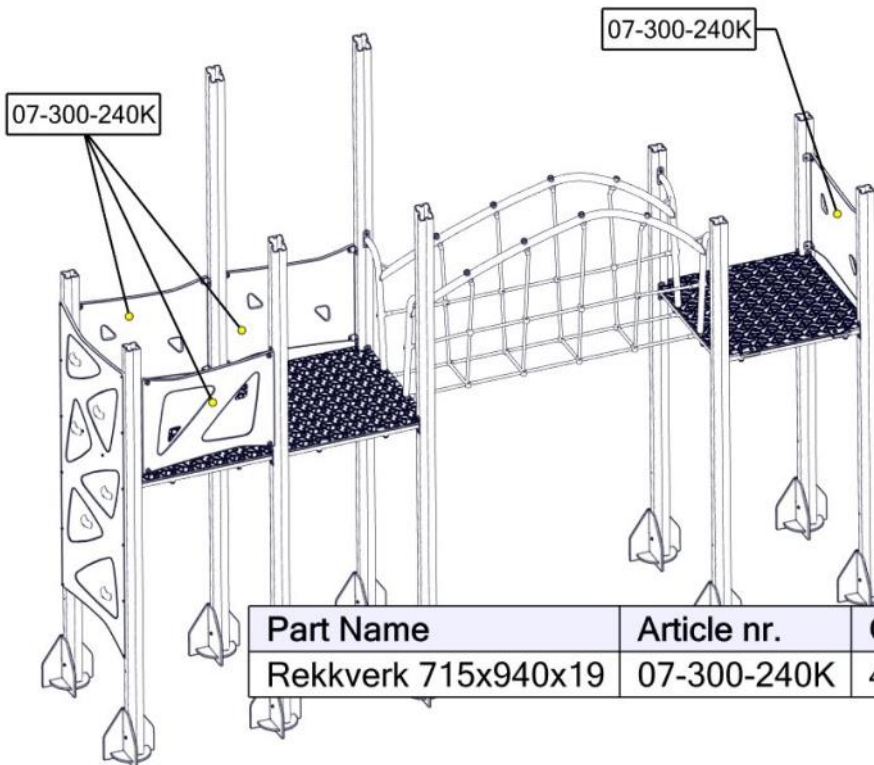

Part Name	Article nr.	Qty
Rekkverk 715x940x19	07-300-240K	4

Se separat delmontering for detaljer
 See separate assembly for details
 Se separata delmontering för detaljer

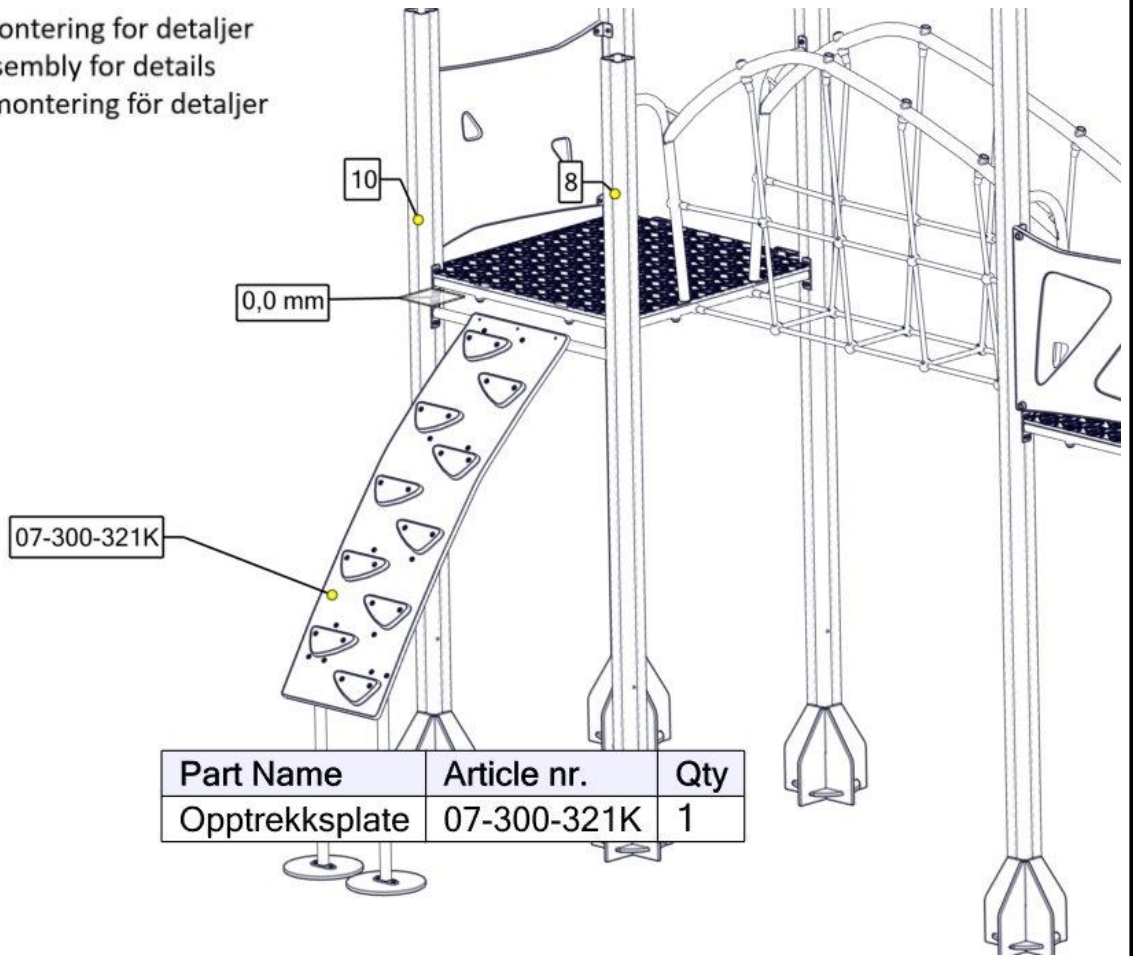

Part Name	Article nr.	Qty
Opptreksplate	07-300-321K	1

Se separat delmontering for detaljer
 See separate assembly for details
 Se separata delmontering för detaljer

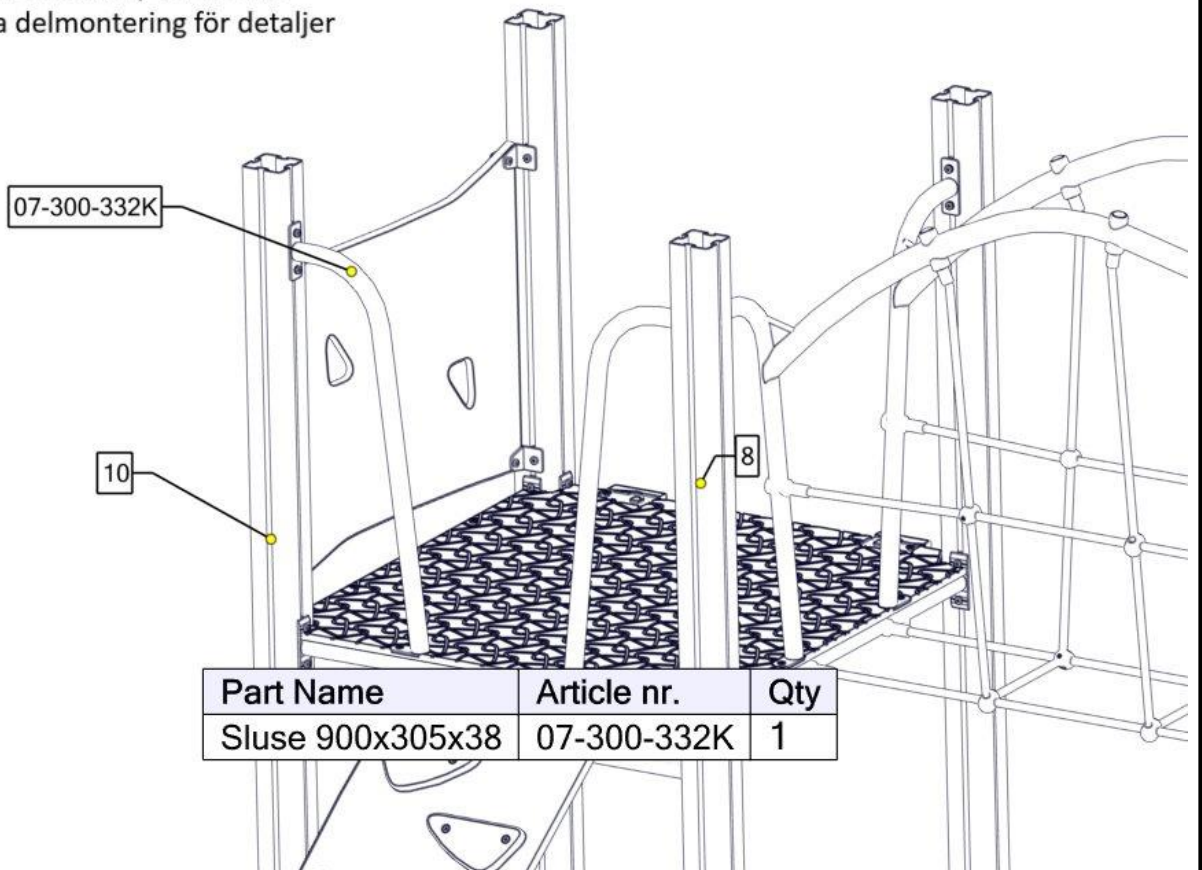

Part Name	Article nr.	Qty
Sluse 900x305x38	07-300-332K	1

Se separat delmontering for detaljer
 See separate assembly for details
 Se separata delmontering för detaljer

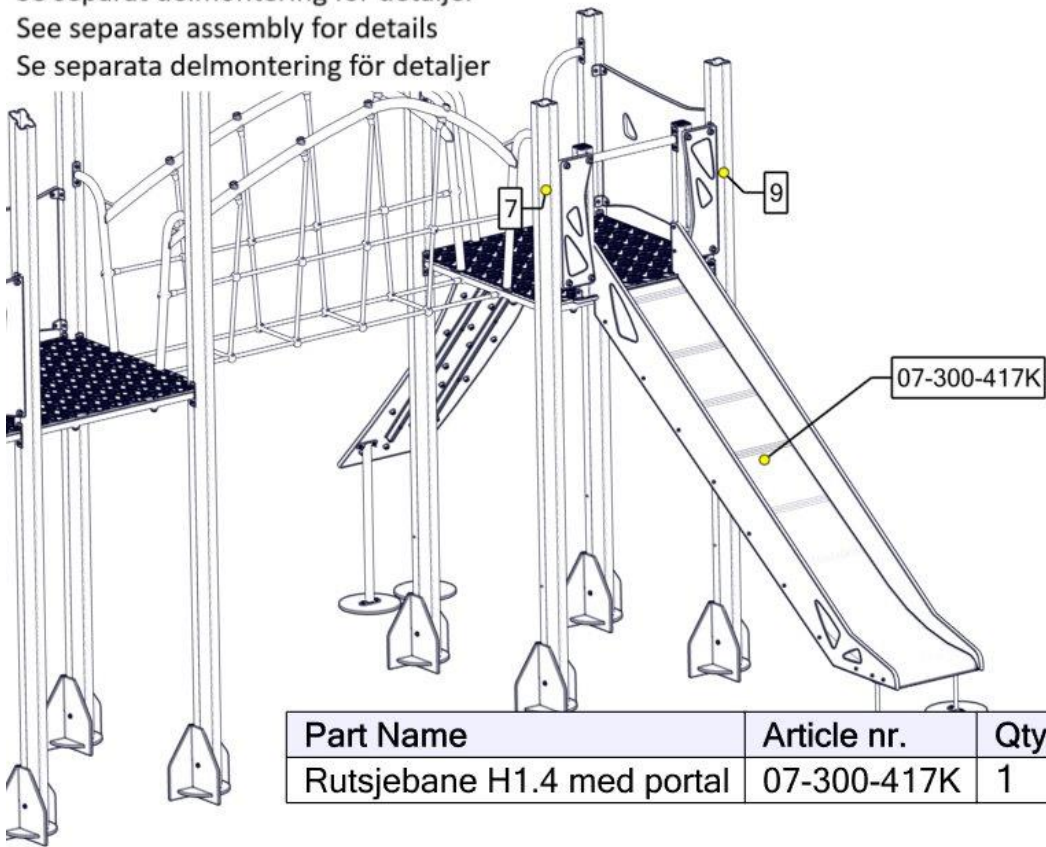

Part Name	Article nr.	Qty
Rutsjebane H1.4 med portal	07-300-417K	1

Se separat delmontering for detaljer
 See separate assembly for details
 Se separata delmontering för detaljer

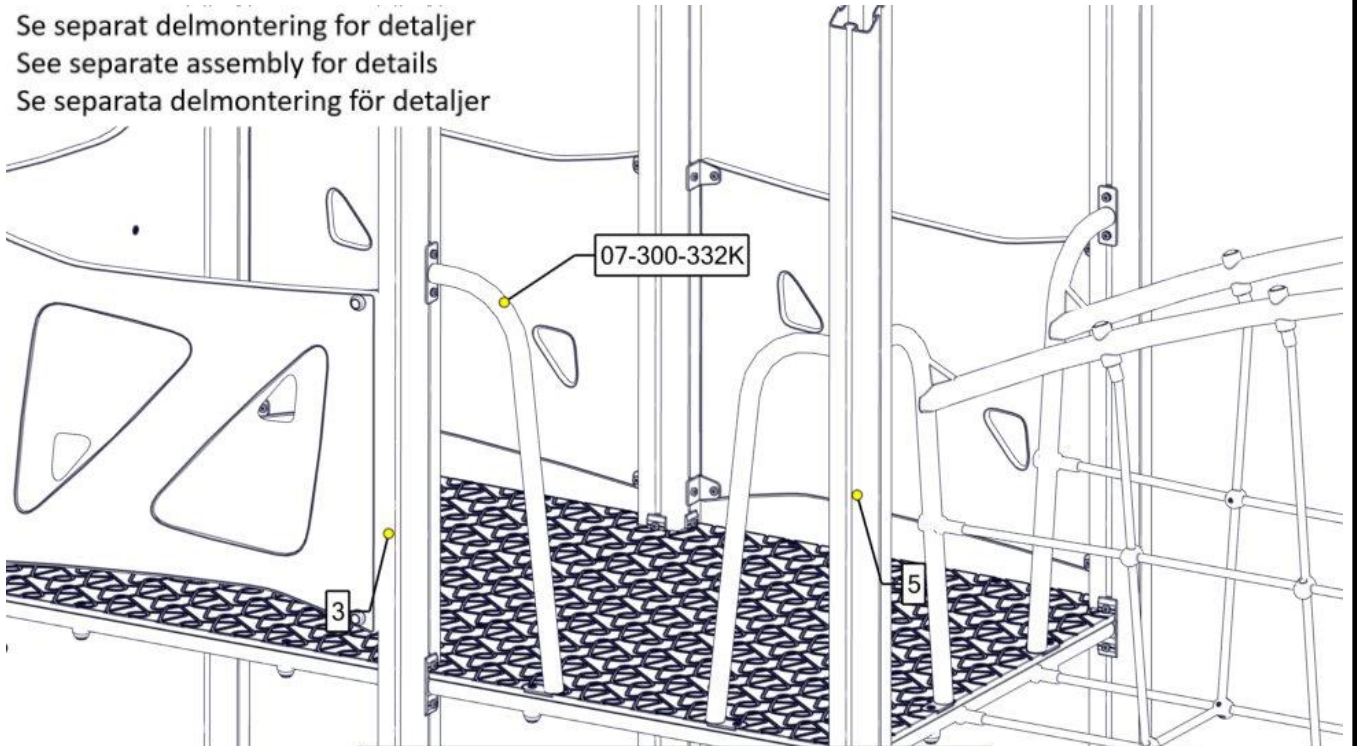

Part Name	Article nr.	Qty
Sluse 900x305x38	07-300-332K	1

Se separat delmontering for detaljer
 See separate assembly for details
 Se separata delmontering för detaljer

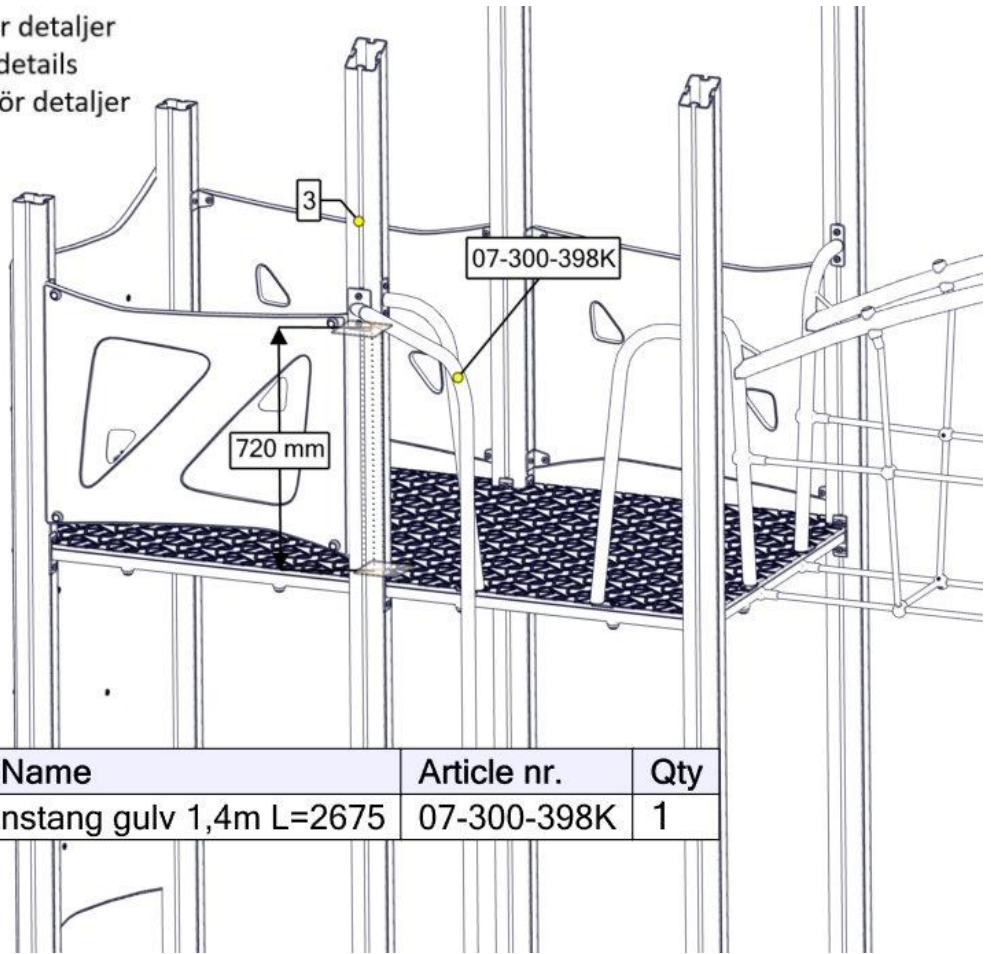

Part Name	Article nr.	Qty
Brannstang gulv 1,4m L=2675	07-300-398K	1

Se separat delmontering for detaljer
 See separate assembly for details
 Se separata delmontering för detaljer

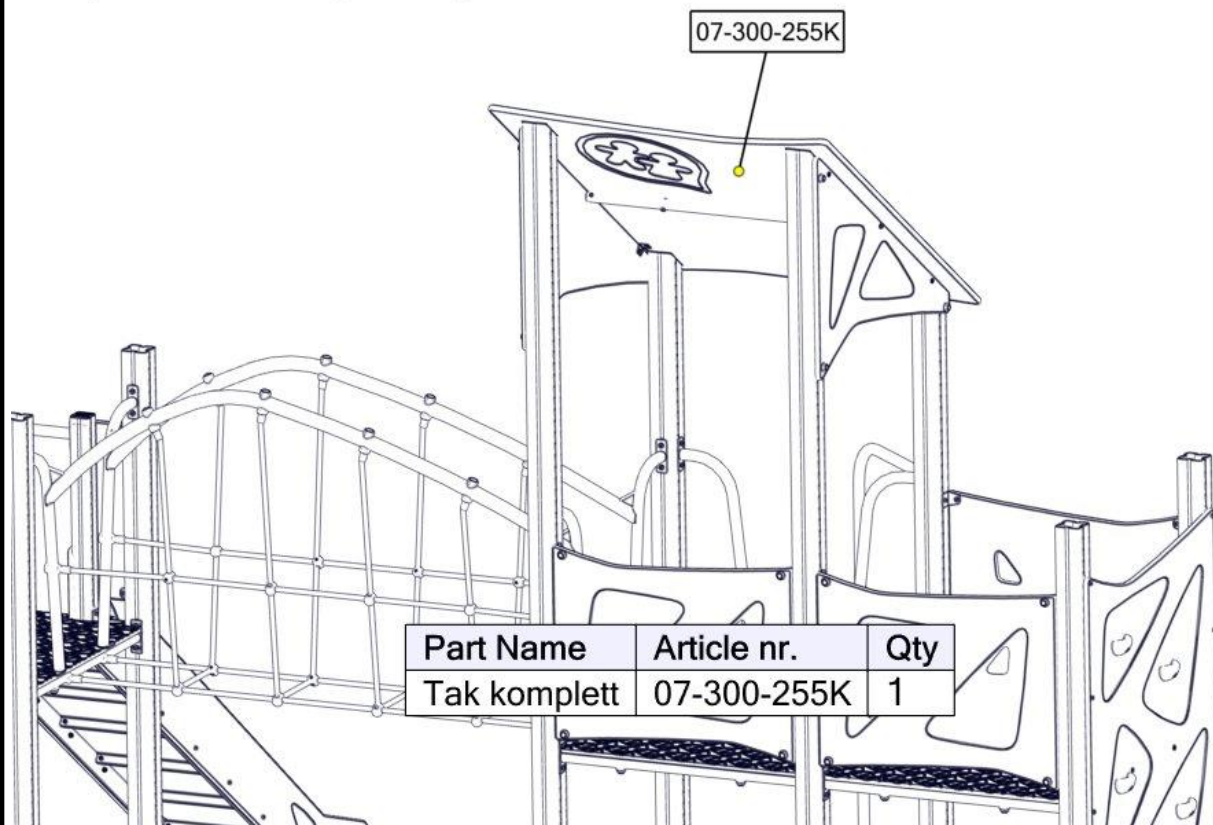

Part Name	Article nr.	Qty
Tak komplett	07-300-255K	1

Se separat delmontering for detaljer
See separate assembly for details
Se separata delmontering för detaljer

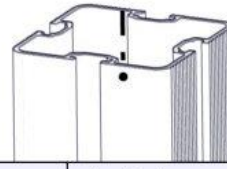
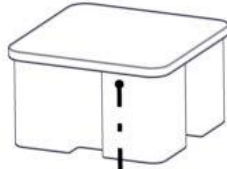



Part Name	Article nr.	Qty
Endelokk 95x95	00-400-998	6

Før utstyret tas i bruk / Before play begins / Innan lekredskapet tas i bruk	
N	<ul style="list-style-type: none"> ● Påse at fallunderlag er utlagt i henhold til gjeldende regler eller vår anbefaling ● Fjern alle monteringshjelpemidler (rester av betong, planker, paller, plast, og lignende) ● Før utstyret tas i bruk, burde man sjekke at det ikke er fare for at anorakksnorer og lignende som kan hekte seg fast noen steder på lekeapparatet. (Vedlagte snor med dobbe (kneledd) kan brukes til å sjekke at dette er i orden. Se vedlagte veiledning for bruk av denne. Dette gjøres for å oppdage eventuelle feilmonteringer.?) ● NB! Bør stå i 2-3 dager før bruk
EN	<ul style="list-style-type: none"> ● Make sure the area and depth of safer surfacing are according to the current standard, or to the manufacturer's recommendation ● Make sure all tools and surplus materials are removed before play begins ● PS! When complete, allow 2-3 days for the concrete to set before use
S	<ul style="list-style-type: none"> ● Kontrollera att fallunderlag är utlagt enligt gällande regler eller vårt rekommendation ● Ta bort alla monteringshjälpmedel (rester av betong, plankor, pallar, plast och liknande) ● Innan lekredskapet används, kontrollera att anoracksnoddar eller kläder/delar av kläder eller liknande inte kan fastna i några delar på redskapet. (Den bipackade "knävringen" kan man med fördel användas för denna kontroll. ● Detta görs för att upptäcka eventuella felmonteringar.)

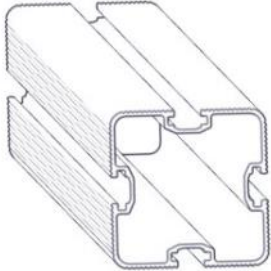
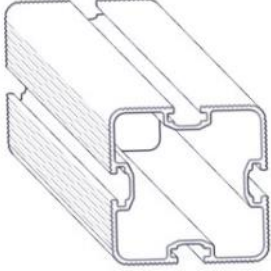

Boltepakker for / Boltpackage for / Bultpaket för

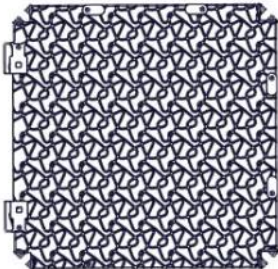
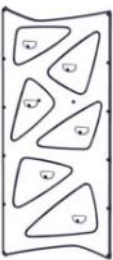
Sign. _____

Saturn Loge 11-500-061	Navn	Artnr/dimensjon	Ant	Lev
	Stolpe 95x95 skrå 55 Lengde = 3600 Sort	SFA5117/1	2	
	Stolpe 95x95 skrå 55 Lengde = 4325 Sort	SFA5117/1	2	
	Stolpe 95x95 Lengde = 3030 Sort	SFA5117/1	6	
	Produktmerke	00-100-400 (Montert hos Søve)	0	
	Gulv med sperrerør For klatrevegg 1080x2140x15 Grå	07-300-222K (Se egen delmontering)	1	
	Gulv med sperrerør 1075x1115 Grå	07-300-202K (Se egen delmontering)	1	
	Klatrevegg 2180x1065x19 Oransje/ lilla	07-300-342K (Se egen delmontering)	1	

Boltepakker for / Boltpackage for / Bultpaket för

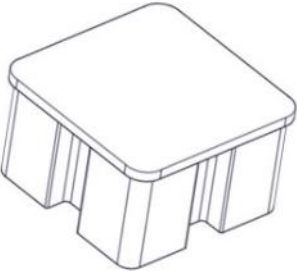
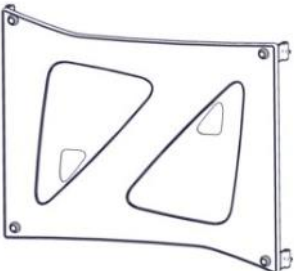
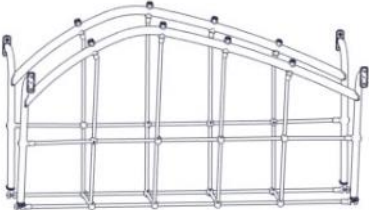
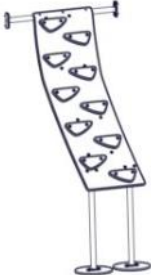
Sign. _____

Saturn Loge 11-500-061	Navn	Artnr/dimensjon	Ant	Lev
	Endelokk 95x95	00-400-998	6	
	Rekkverk 715x940x19 Oransje/ lilla	07-300-240K (se egen delmontering)	4	
	Brua rett Oransje	07-300-385K (Se egen delmontering)	1	
	Opptreksplate komplett Oransje/ lilla	07-300-321K (Se egen delmontering)	1	
	Sluse 900x305x38 Lilla	07-300-332K (Se egen delmontering)	2	
	Rutsjebane H1.4 med portal Oransje/ lilla	07-300-417K (Se egen delmontering)	1	



Boltepakker for / Boltpackage for / Bultpaket för

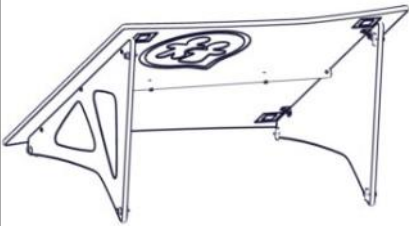

Sign. _____.

Saturn Loge 11-500-061	Navn	Artnr/dimensjon	Ant	Lev
	Brannstang gulv 1,4m L=2675 Lilla	07-300-398K (Se egen delmontering)	1	
	Tak komplett Oransje/ lilla	07-300-255K (Se egen delmontering)	1	

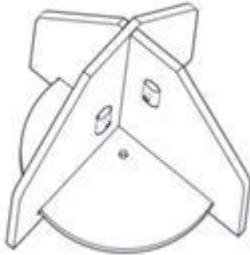
Boltepakker for / Boltpackage for / Bultpaket för

Sign. _____.

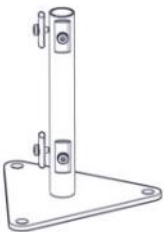
Saturn Loge 11-500-061	Navn	Artnr/ dimensjon	Ant	Lev
	<u>For nedgraving</u>			
	Nedgravingsfundament 95x95	00-003-004K (se egen delmontering)	10	
	<u>For støping</u>			
	Støpe fundament	00-003-110K	10	

Boltepakker for / Boltpackage for / Bultpaket för		Sign. _____.		
Saturn Loge 11-500-061	Navn	Artnr/ dimensjon	Ant	Lev
	Overflate fundamentering			
	Fundament 95x95 stolpe for betongdekke	00-003-125K (Se egen delmontering)	10	
	Deler som må Endres, Changed parts			
	Opptreksplate forankring	07-300-321K	(2)	
	Rutsjebane forankring	07-300-417K	(2)	
	Brannstang kappes	07-300-398K	(1)	
	Stolpene kappes	SFA5117/1	(10)	
	Bruk kortere bolter når du monterer den nederste delen av veggene	04-000-016	2	

Revidert

19-12-2019

Endret view 10

10.07.2020

Oppdater bilde for fundament

13.07.2020

Oppdatert vekt i tabell

Stolpe 95x95 skrå 55

Lengde = 3600

Sort 07-300-310 endret til SFA5117/1

Stolpe 95x95 skrå 55

Lengde = 4325

Sort 07-300-311 endret til SFA5117/1

Oppdatert BOM

Oppdatert div view inkl sikkerhetssone, areal og stolpeplassering

01-10-2021 SV

Endret høydemål for klatrevegg