

**N****Monteringsanvisning****EN****Assembly Instructions****S****Monteringsanvisning**

Produkt nr. / Product no. / Produkt nr.

**11-500-100****Blå / Pistasj**

Ord. nr. \_\_\_\_\_

Dato. \_\_\_\_\_

Sign. \_\_\_\_\_

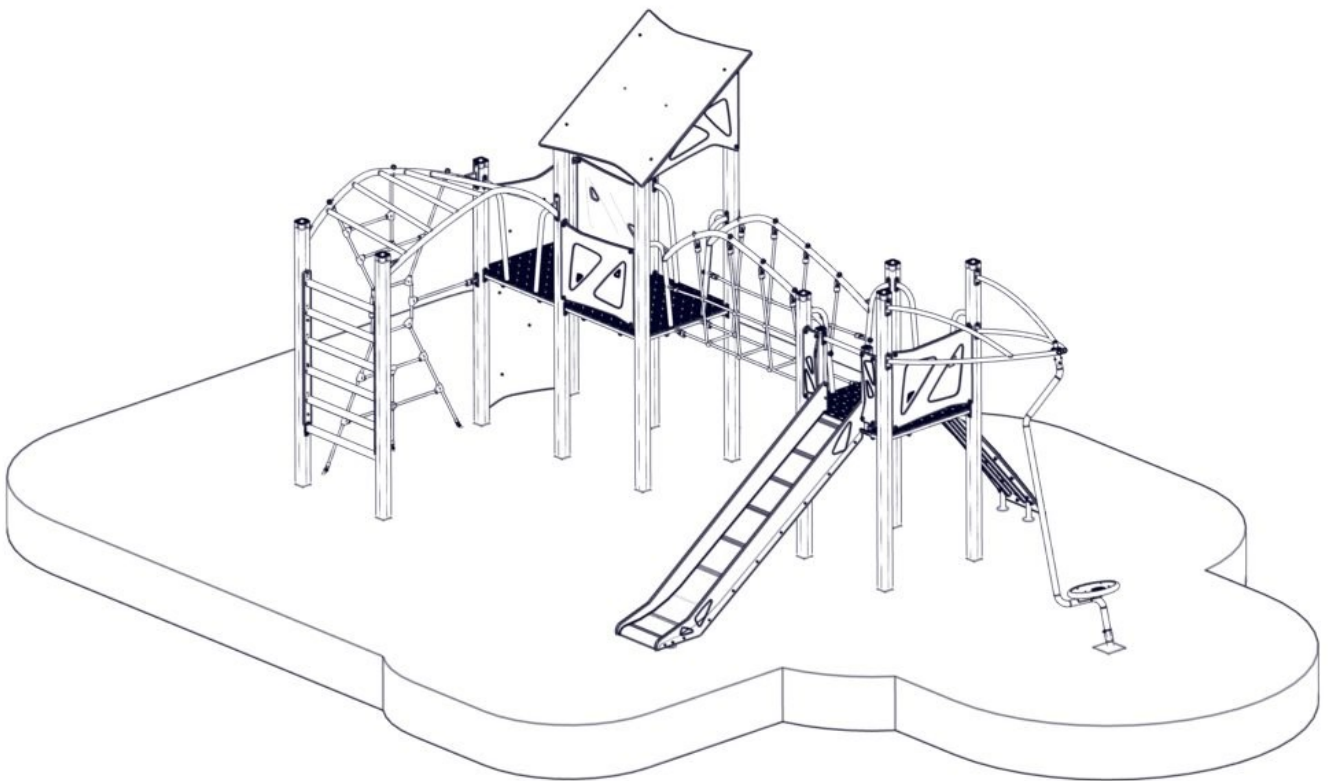
**søve**

Søve AS  
Grønnvoldveien 290  
3830 Ulefoss - Norway  
Tlf: +47 35 94 65 65  
[www.sove.no](http://www.sove.no)

**søve**

Søve AB  
EA Rosengrensgatan 32  
421 31 Västra Frölunda  
Phone: +46 (0)31 773 97 00  
[www.sove.se](http://www.sove.se)

## Monteringstips / Assembly Advice / Monteringsstips

N

- Les monteringsanvisningen nøye før montering.
- Monter elementene i rekkefølgen som vist.
- Boltene bør ikke skrues for hardt til før alt er montert, vatret og loddet. Skru så boltene til.
- NB! Ved bruk av drill, kan boltene ryke.
- På grunn av at solen kan gjøre rutsjeflaten veldig varm, bør rutsjebanens utløp vende mot nord-øst eller nord-vest.
- Er lekeutstyret plassert i naturlige ferdselstraséer må området sikres mot gjennomgang.
- Innspringningshinder bør vurderes rundt lekeapparater hvor det er stor bevegelse, f.eks. ved huskestativ.
- Det bør være fritt innsyn til lekeutstyr som er beregnet for barn under 3 år.

**NB! Under monteringsarbeidet må utstyr, som ikke er forankret forsvarlig i bakken, sikres slik at det ikke velte.**

**Området må avstenges under montering av apparatene med sperrebånd eller lignende.**

EN

- Read the instruction carefully before assembling the play unit.
- Assemble the components in the sequence shown in these instructions. Fixings must not be fully tightened during assembly. Before casting the foundations, the structure must be level and plumb, at which point all fixings are tightened. PS! If use of drill, the bolts may be wrecked.
- Avoid positioning the slide facing due south because of overheating – ideal positions are facing north-east or north-west. Secure the construction-area to prevent people from walking through it.
- Consider installing barriers around play-equipment which gives rise to a lot of activity – i.e.swings.
- Ensure that clear vision is possible across the play area so that supervision is possible from any position, particularly where children under 3 years of age will be playing.

**NB! During assembly of the equipment, ensure that all structures are securely propped, especially when left overnight. Also ensure that equipment is supported**

**Monteringstips / Assembly Advice / Monteringsstips****S**

- Läs monteringsanvisningen noga före montering.

- Montera delarna i den ordningen som anvisas
- Skruvarna bör inte skruvas för hårt tills allt är monterat, i våg och lodat.

OBS! Används elektrisk skruvdragare, kan bulten gå sönder. Hårdra därför manuellt!

- Solen kan göra att rutchbanan blir väldigt varm. Banans nedfart rekommenderas att vändas i norrlig riktning
- Om lekplatsen placeras vid en gångväg mm bör området säkras mot genomfart av gående och cyklister.
- Insprängningshinder bör placeras runt lekutrustning med stor rörelse, t ex, gungställning.
- Det bör vara fri insyn till lekutrustning beräknat till barn under 3 år.

**OBS! Under monteringsarbete bör utrustningen som inte ska förankras i marken, ställs så att den inte kan välta.**

**Området måste spärras när lekutrustningen byggs upp, med avspärrningsband eller liknande.**

**N**

Alle mål er oppgitt i millimeter









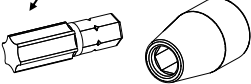

**EN**

Scale measured in mm

**S**

Alla mått är i millimeter.

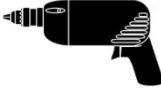
**Nødvendig verktøy / Tools required / Nödvändiga verktyg**

<p>(N)</p> <p>(EN)</p> <p>(S)</p>	<p>(A)</p> 	<p>(B)</p>  <p>Torx Nr 45</p> 	<p>(C)</p> <p>5 mm 6 mm</p> 	<p>(D)</p> 	<p>(E)</p> 
		<p>Metermål</p> <p>Metric measure</p> <p>Tumstock</p> 	<p>Ø11mm Bor</p> <p>Ø11mm Drill</p> <p>Ø11mm Borr</p> 	<p>Merkebånd</p> <p>Mark ribbon</p> <p>Märkeband</p> 	<p>13 + 17mm</p> 

**Nødvendig antall personer / Number of persons required / Rekommenderad antal personer**

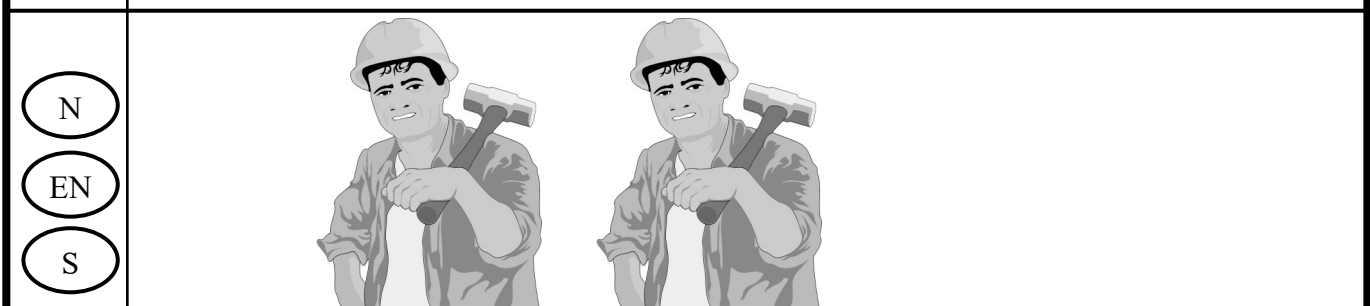

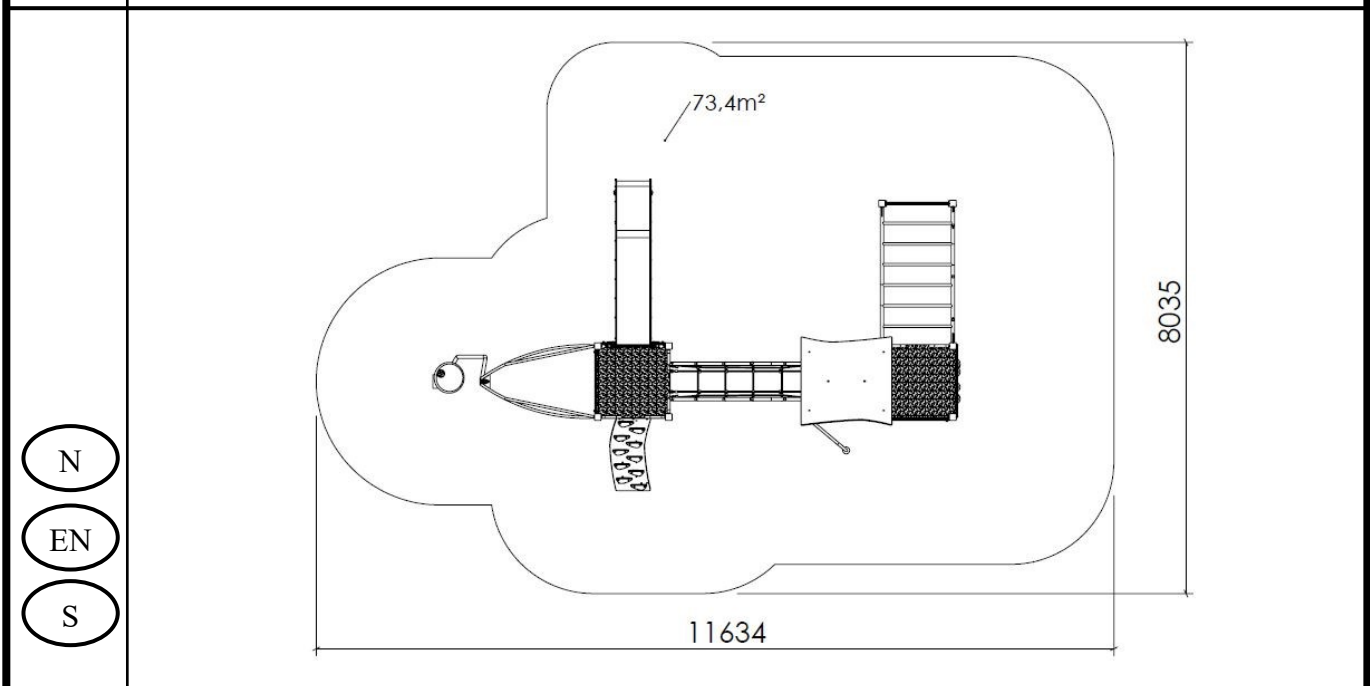

**Anbefalt arealbehov ved montering / Recommended working space / Rekommenderad arealbehov vid montering**



**Boltepakker for / Boltpackage for / Bultpaket för**

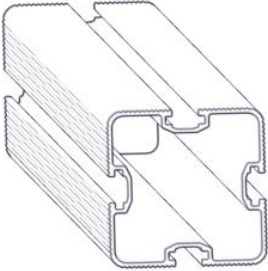
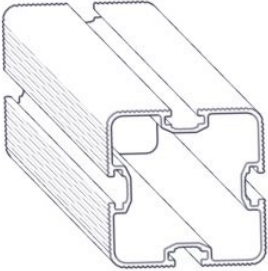
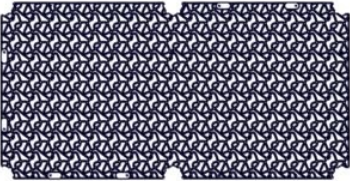
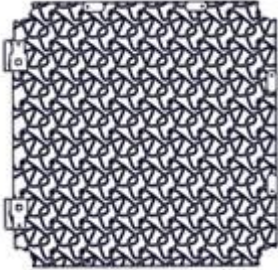

Sign. \_\_\_\_\_

Saturn Narvi 11-500-100	Navn	Artnr/ dimensjon	Ant	Lev
	Stolpe 95x95 Lengde = 3030 Sort	SFA5117/1	6	
	Stolpe 95x95 Lengde = 3350 Sort	SFA5117/1	2	
	Stolpe 95x95 skrå 55 Lengde = 3600 Sort	SFA5117/1	2	
	Stolpe 95x95 skrå 55 Lengde = 4325 Sort	SFA5117/1	2	
	Gulv 2135x1075x15 LK-0-1-1-0-1 Grå	07-300-220	1	
	Gulv 1075x1115x15 Portal-1-1-0 Grå	07-300-202	1	
	Sperrerør for gulv Lengde = 940 2hull cc470 Sort	07-300-230	8	
	Sperrerør for gulv Lengde = 940 2hull cc735 for portal Sort	07-300-232	1	





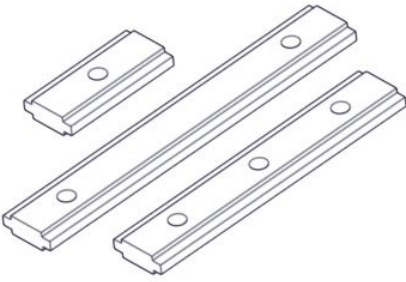
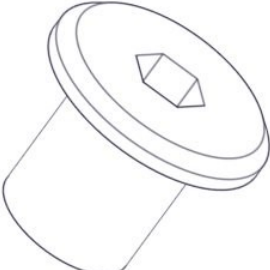
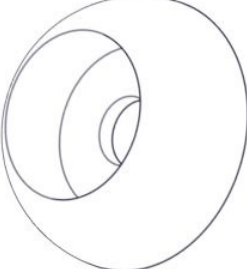
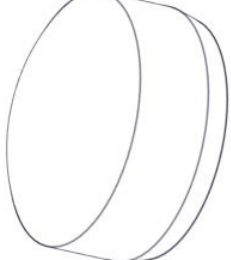

**Boltepakker for / Boltpackage for / Bultpaket för**

Sign. \_\_\_\_\_

Saturn Narvi 11-500-100	Navn	Artnr/ dimensjon	Ant	Lev
	Sperrerør Lengde = 940 2hull cc470 + 2hull cc300 Bru Sort	07-300-233	2	
	Torx M8x25	04-000-025	44	
	Brikke 120 3xM8	04-060-120 (montert hos Søve)	0	
	Møbelknapp M8x11	04-030-011	22	
	Sikkerhets hette kropp	05-301-045	22	
	Sikkerhets hette topp	05-301-044	22	

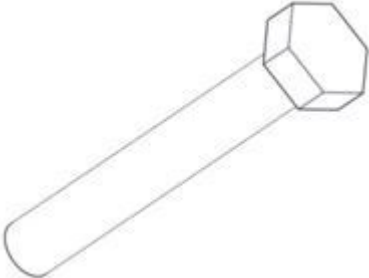
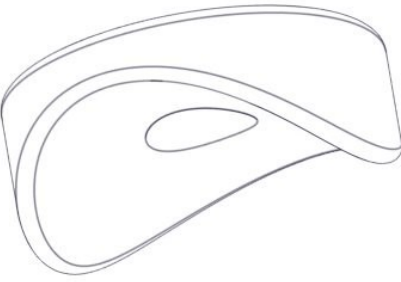
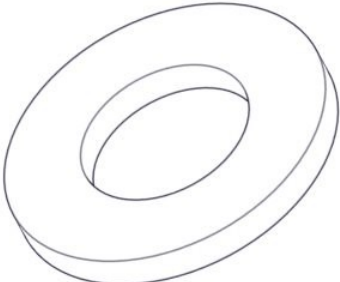



**Boltepakker for / Boltpackage for / Bultpaket för**

Sign. \_\_\_\_\_.

Saturn Narvi 11-500-100	Navn	Artnr/ dimensjon	Ant	Lev
	Sekskant M8x55	04-008-055	22	
	Avstandskive for Ø38	04-210-010	22	
	Skive M8	04-050-008	22	
	Produktmerke	00-100-400 (montert hos Søve)	0	
	Brannstang Gulv 1,4m Pistasj	07-300-397K (se egen del- montering)	1	
	Sving CC1035 Blå / Pistasj	07-250-009K (se egen del- montering)	1	

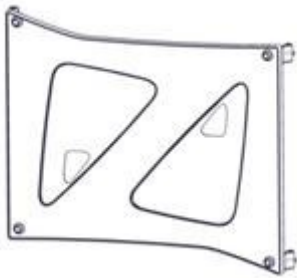
**Boltepakker for / Boltpackage for / Bultpaket för**





Sign. \_\_\_\_\_

Saturn Narvi 11-500-100	Navn	Artnr/ dimensjon	Ant	Lev
	Rekkverk 715x940x19 Blå	07-300-241K (se egen del- montering)	3	
	Tak Blå	07-300-250K (se egen del- montering)	1	
	Sluse Pistasj	07-300-333K (se egen del- montering)	3	
	Klatrevegg 2180x1605x19 Blå	07-300-340K (se egen del- montering)	1	
	Rutsjebane med portal H=1,4m Blå—pistasj	07-300-416K (se egen del- montering)	1	

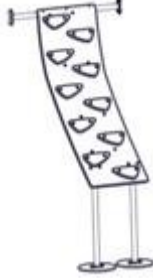

**Boltepakker for / Boltpackage for / Bultpaket för**

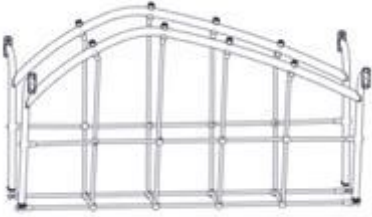
Sign. \_\_\_\_\_.

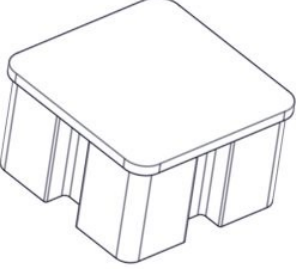
Saturn Narvi 11-500-100	Navn	Artnr/ dimensjon	Ant	Lev
	Opptrekksplate Blå	07-300-320K (se egen del- montering)	1	
	Armgang med nett Pistasj	07-300-353K (se egen del- montering)	1	
	Brua rett Blå	07-300-387K (se egen del- montering)	1	
	Sperrør L=940 sort	00-400-156K (se egen del- montering)	6	
	Endelokk 95x95	00-400-998	8	

**Boltepakker for / Boltpackage for / Bultpaket för**

Sign. \_\_\_\_\_.

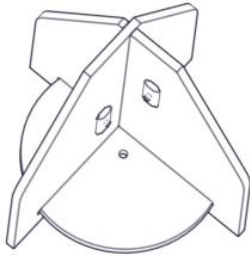
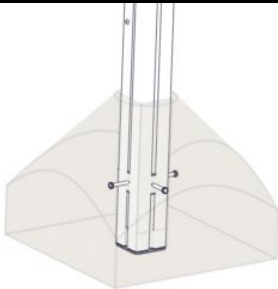
Saturn Narvi 11-500-100	Navn	Artnr/ dimensjon	Ant	Lev
	<b>Fundament Nedgravning</b>			
	Nedgravingsfundament 95x95	00-003-004K (se egen del- montering)	10	
	Støpefundament 95 x 95 stolpe	00-003-110K (se egen del- montering)	2	

**Boltepakker for / Boltpackage for / Bultpaket för**

Sign. \_\_\_\_\_.

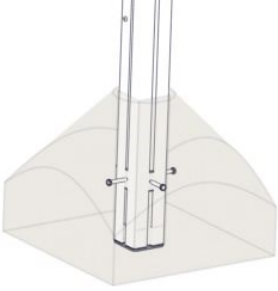
Saturn Narvi 11-500-100	Navn	Artnr/ dimensjon	Ant	Lev
	<b>Fundament Støp</b>			
	Støpefundament 95 x 95 stolpe	00-003-110K (se egen del- montering)	12	

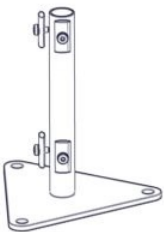
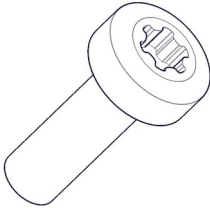
<b>Boltepakker for / Boltpackage for / Bultpaket för</b>		Sign. _____		
Saturn Narvi 11-500-100	Navn	Artnr/ dimensjon	Ant	Lev
	<b>Overflate fun- damentering</b>			
	Fundament 95x95 stolpe for betongdekke	00-003-125K (Se egen del- montering)	12	
	<b>Deler som må Endres, Changed parts</b>			
	Opptreksplate forankring	07-300-320K	(2)	
	Rutsjebane forankring	07-300-416K	(2)	
	Sving kappes	07-250-009K	(1)	
	Brannstang kappes	07-300-397K	(1)	
	Stolpene kappes	SFA5117/1	(12)	
	Bruk kortere bolter når du monterer den nederste delen av veggene	04-000-016	2	

**Fundamentering med betong // Foundation concrete // Förankring med betong**

- (N) Komprimert masse Ref NS-EN 1176-1
- (EN) Compressed mass §4.2.8.5
- (S) Komprimerad massa



- (N) (EN) (S)
- Bakkenivå Ground level marknivå

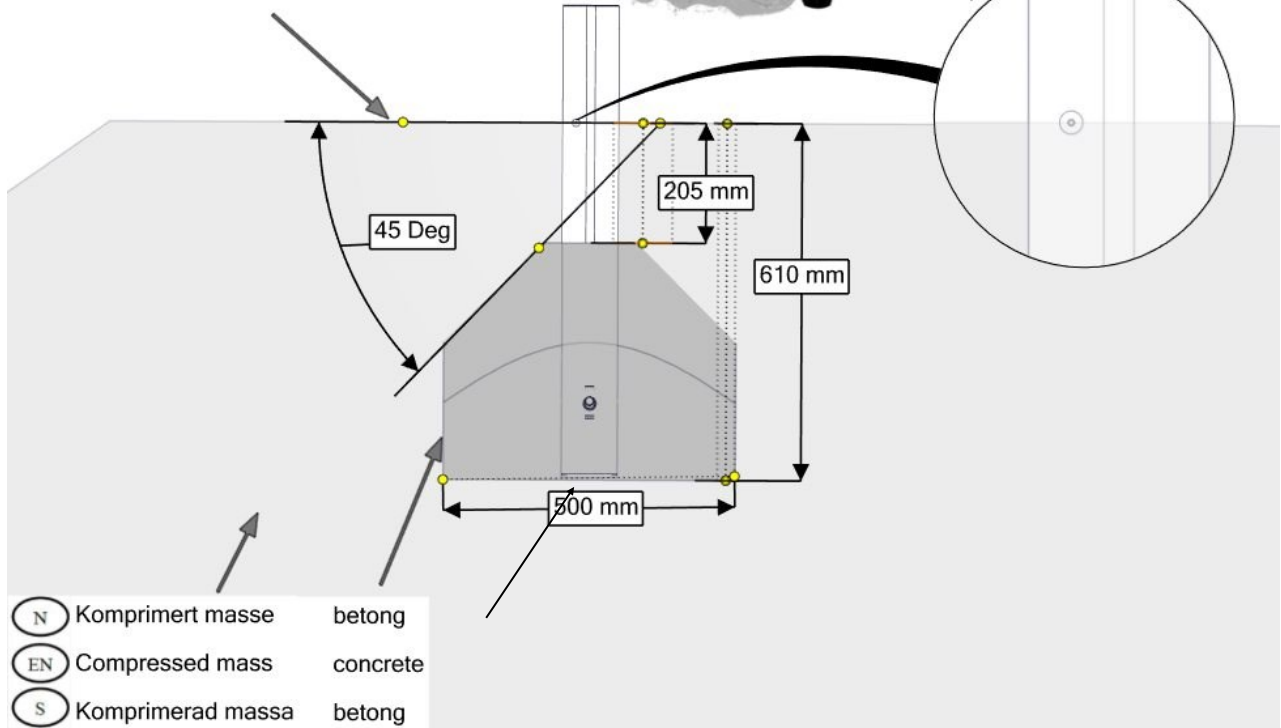

- (N) Komprimert masse betong
- (EN) Compressed mass concrete
- (S) Komprimerad massa betong

**Fundamentering uten betong // Foundation without concrete // Förankring utan betong**

- (N) Støtdempende materialer Ref NS-EN 1176-1
- (EN) Impact attenuating materials §4.2.8.5
- (S) Støtdämpande material

- (N) (EN) (S)
- Bakkenivå Ground level Marknivå

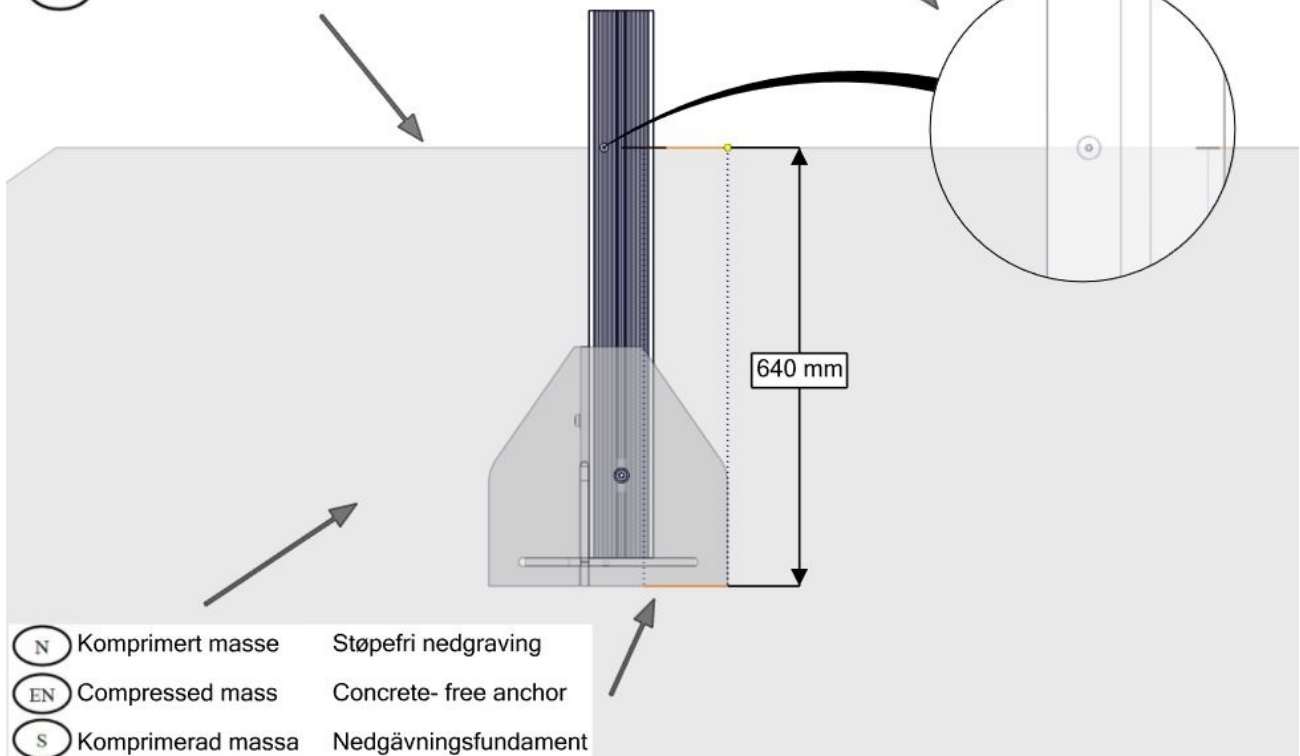

- (N) Komprimert masse Støpefri nedgraving
- (EN) Compressed mass Concrete-free anchor
- (S) Komprimerad massa Nedgävningsfundament

**Overflatemontering, Surface mounting, Ytmontering**

Ref  
NS-EN 1176-1  
§4.2.8.5

(N) (EN) (S)  
Bakkenivå Ground level marknivå

Tykkelse/Thickness

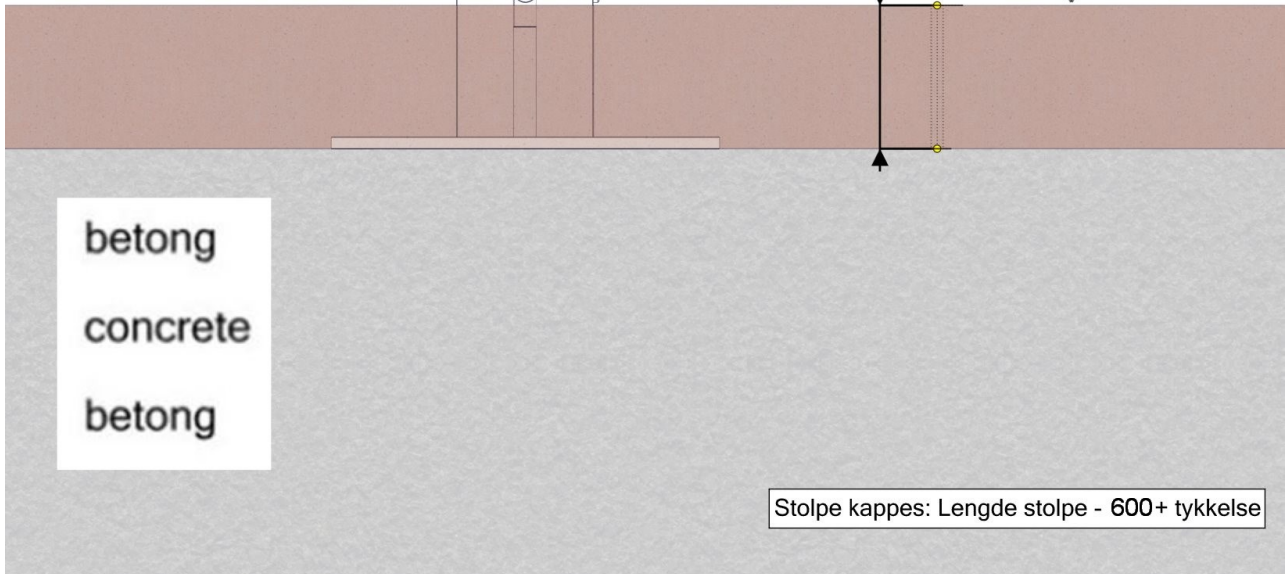

betong  
concrete  
betong

Stolpe kappes: Lengde stolpe - 600+ tykkelse

Når du har overfalte monteringsfundamenter bruk korte skurer på nedeste festepunkter.

If you are using 0-level anchors use short bolt for mounting lower lower parts

04-000-016



Part Name	Article nr.	Qty
Torx M8x16	04-000-016	1

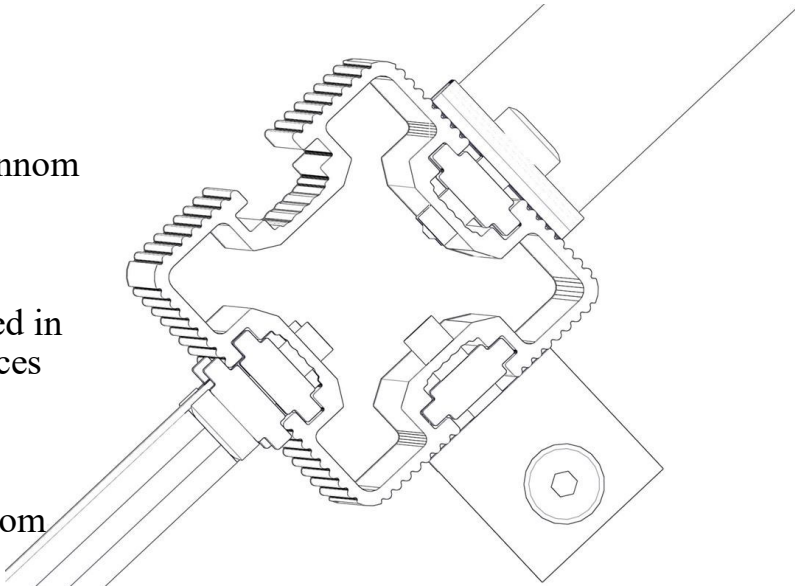

<p>(N) Bolten skrues HELT igjennom aluminiumen. Maks moment: 30Nm</p> <p>(EN) The bolt must be tightened in to the post, so that it peirces the aluminium Max torque: 30Nm</p> <p>(S) Bulten skuvas HELT genom aluminiumen. Maks vridmoment: 30Nm</p>					
NO		Betongkvalitet			
SE		Betongkvalitet	C25/30		
EN		Concrete quality			
NO		Mengde betong		1,2	m <sup>3</sup>
SE		Mängd betong		1,2	m <sup>3</sup>
EN		Amount of concrete		1,2	m <sup>3</sup>
NO		Fundament størrelse		0,5 x 0,5 x 0,4	m
SE		Stiftelsestorlek		0,5 x 0,5 x 0,4	m
EN		Foundation size		0,5 x 0,5 x 0,4	m
NO	For sikkerhet må fundamentene med sand eller myk jord være minst 50% større i areal				
SE	För säkerheten måste grunden med sand eller mjuk jord vara minst 50% större i området				
EN	For safety, the foundations with sand or soft soil must be at least 50% larger in area				
NO		Tyngste element	07-300-410	49,2	Kg
SE		Tyngsta element	07-300-410	49,2	Kg
EN		Heaviest element	07-300-410	49,2	Kg
NO		Største element	07-300-410	2,97x0,55x0,61	m
SE		Största element	SFA5117/1	4,325x0,095x0,095	m
EN		Biggest element	SFA5117/1	4,325x0,095x0,095	m

### Fallhøyder / Free height of fall / Fallhöjder

Fallhøyde = 2,7 m

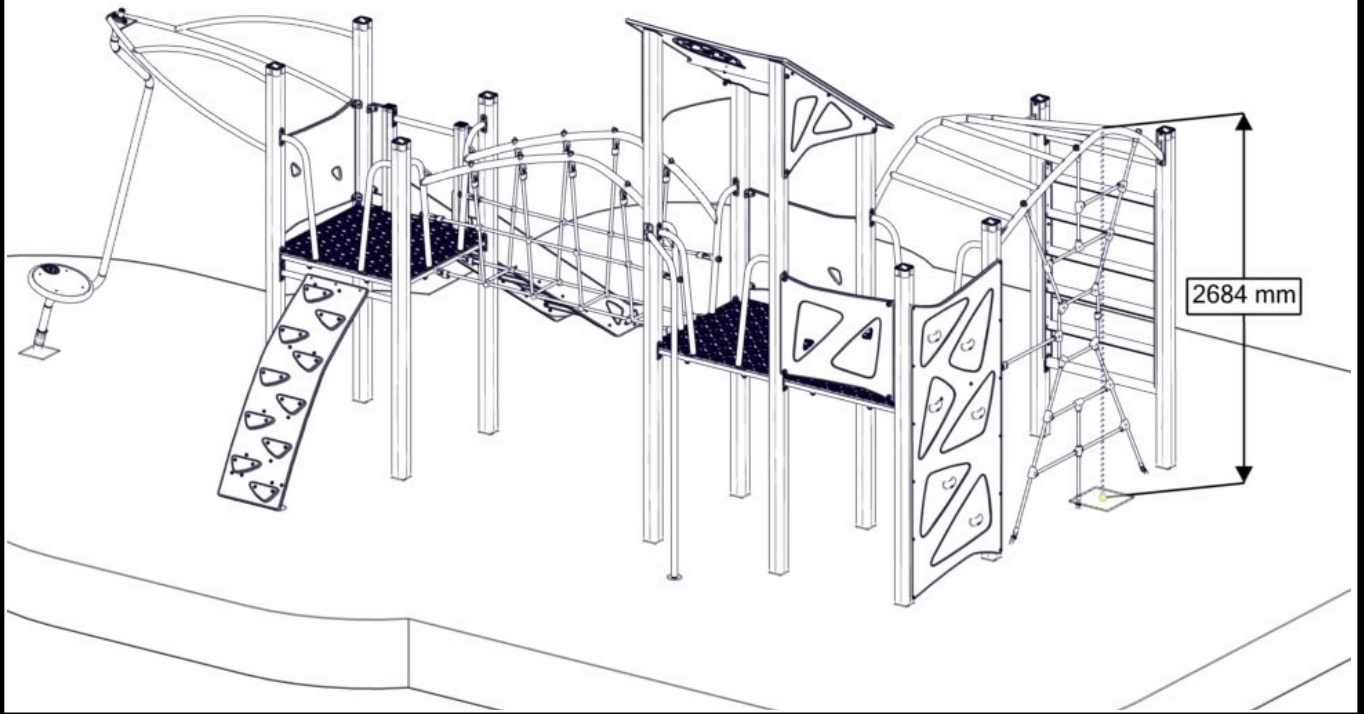

### Sikkerhetszone / Safety zone / Säkerhetszon

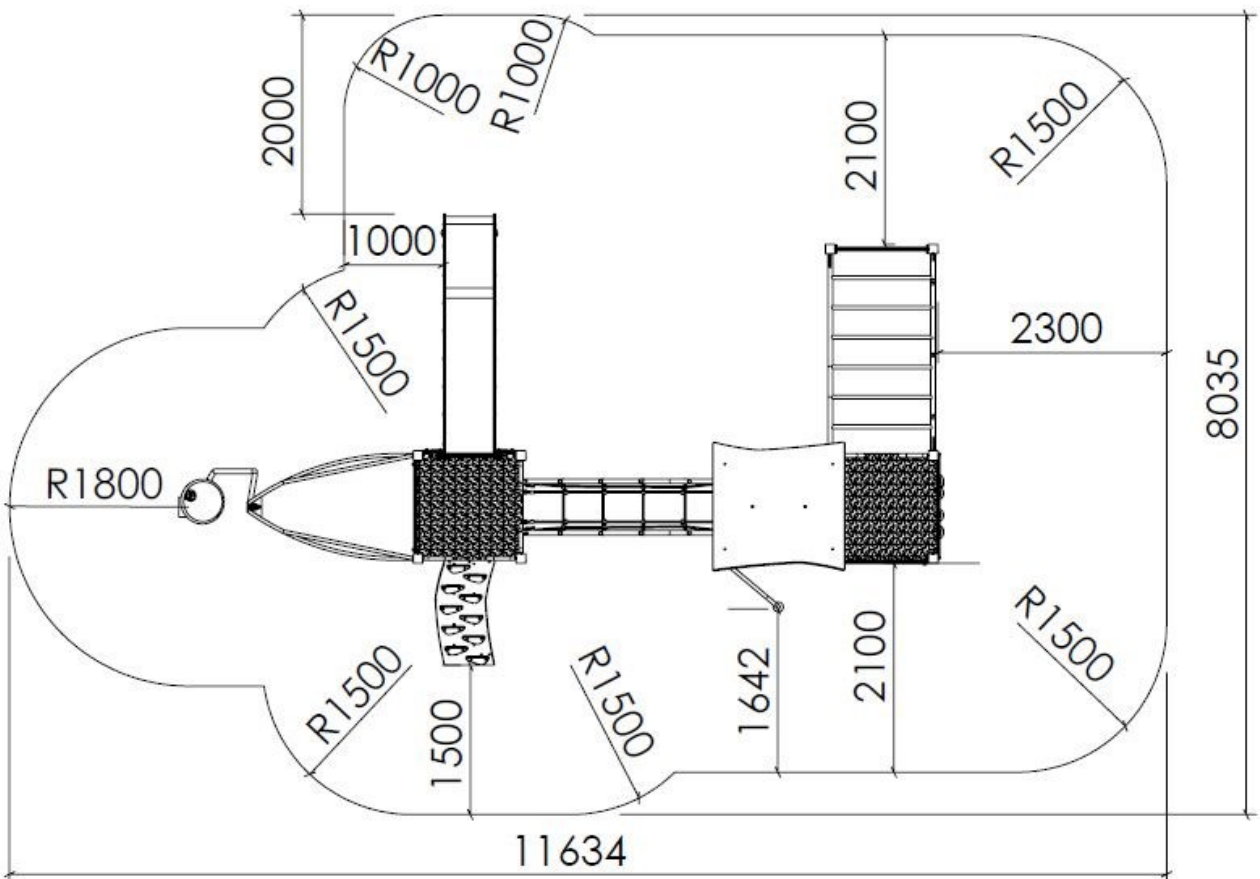

**Plassering av forankringer / Ground plan / Placering av förankringar**

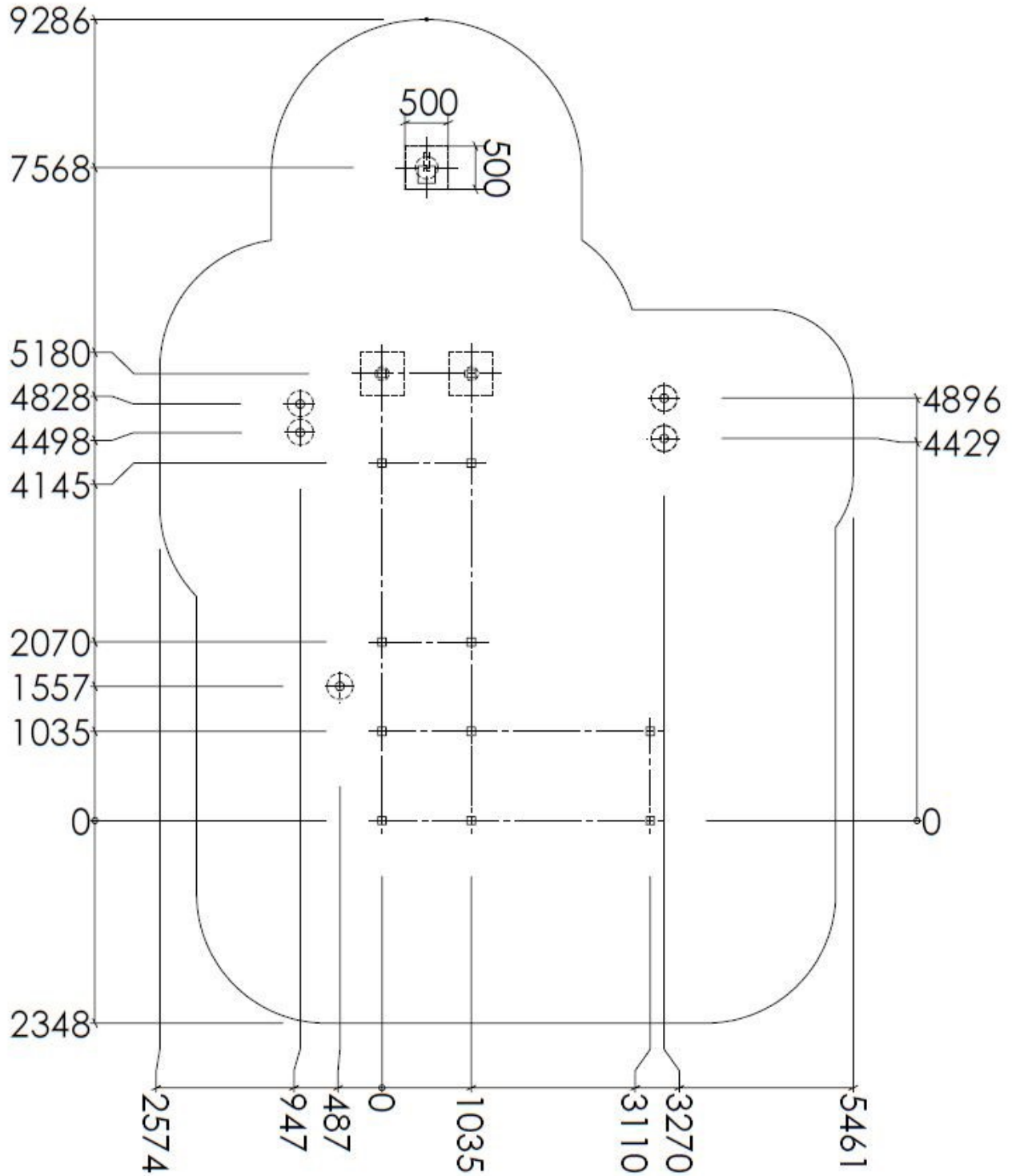

**Montering av lekeapparatet / Assembly instructions / Montering av lekredskapet**

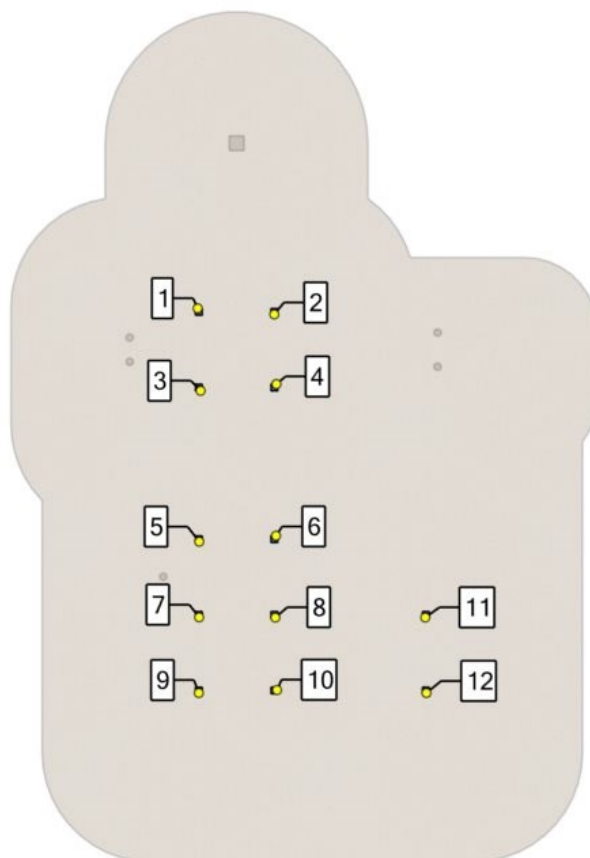
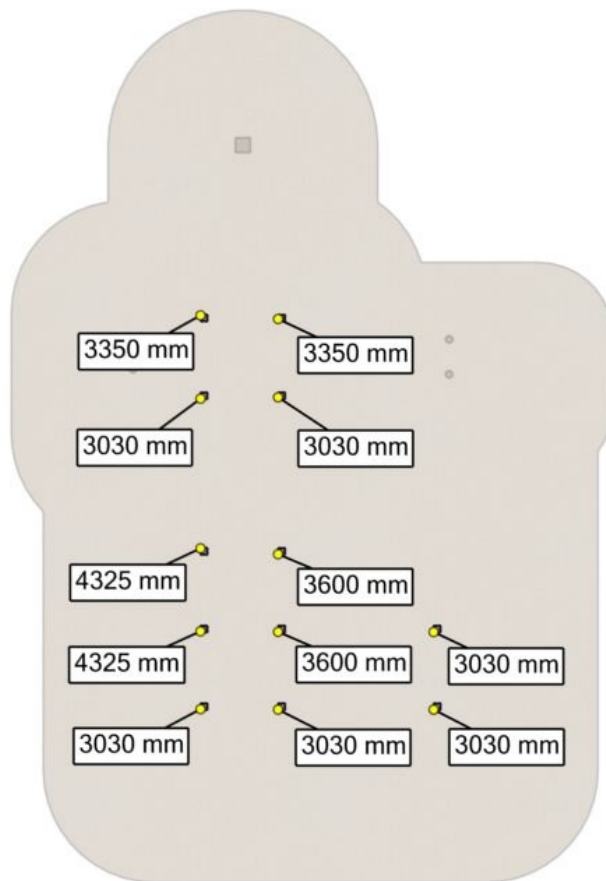

Se separat delmontering for detaljer  
 See separate assembly for details  
 Se separata delmontering för detaljer

Brikke 120 3xM8

Montert hos Søve  
 Assembled at Søve  
 Monterad hos Søve

07-300-320K

Part Name	Article nr.	Qty
Opptreksplate komplett	07-300-320K	1
Stolpe 95x95 L=3235	SFA5117/1	1
Stolpe 95x95 L=3035	SFA5117/1	1

Se separat delmontering for detaljer  
 See separate assembly for details  
 Se separata delmontering för detaljer

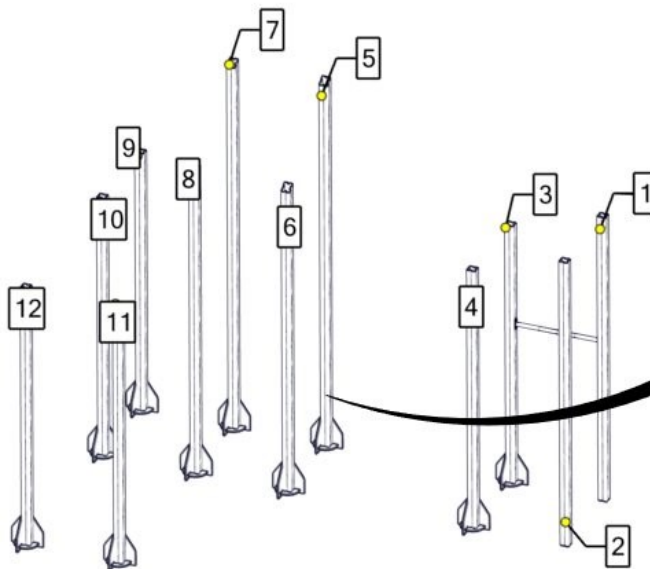

Bakkeniva-skruer

Montert hos Søve  
 Assembled at Søve  
 Monterad hos Søve

Part Name	Article nr.	Qty
Nedgravingsfundament 95x95	00-003-004K	10
Stolpe 95x95 L=3235	SFA5117/1	2
Stolpe 95x95 L=3035	SFA5117/1	6

Part Name	Article nr.	Qty
Stolpe 95x95 Skrå L=3600	SFA5117/1	2
Stolpe 95x95 Skrå L=4325	SFA5117/1	2

## Montering av lekeapparatet / Assembly instructions / Montering av lekredskapet

Se separat delmontering for detaljer  
 See separate assembly for details  
 Se separata delmontering för detaljer

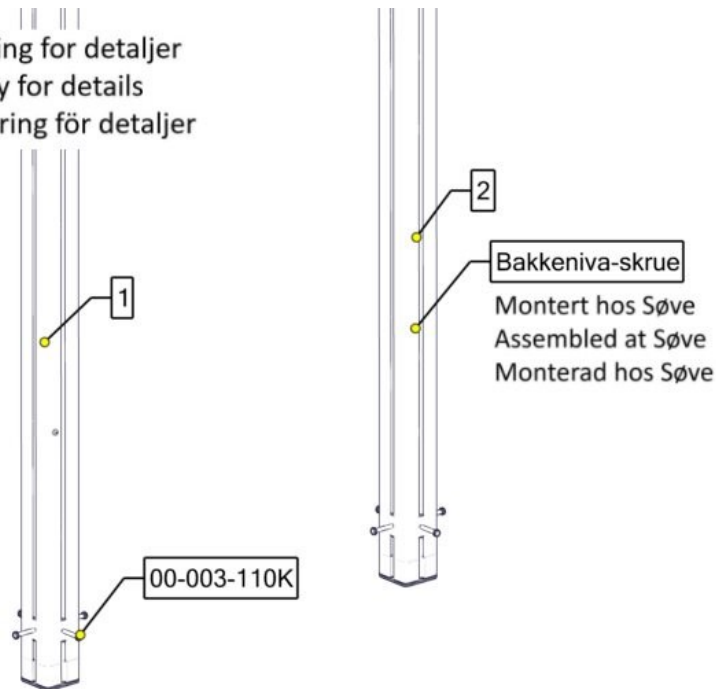

Part Name	Article nr.	Qty
Fundament til støp 95x95 stolpe	00-003-110K	2

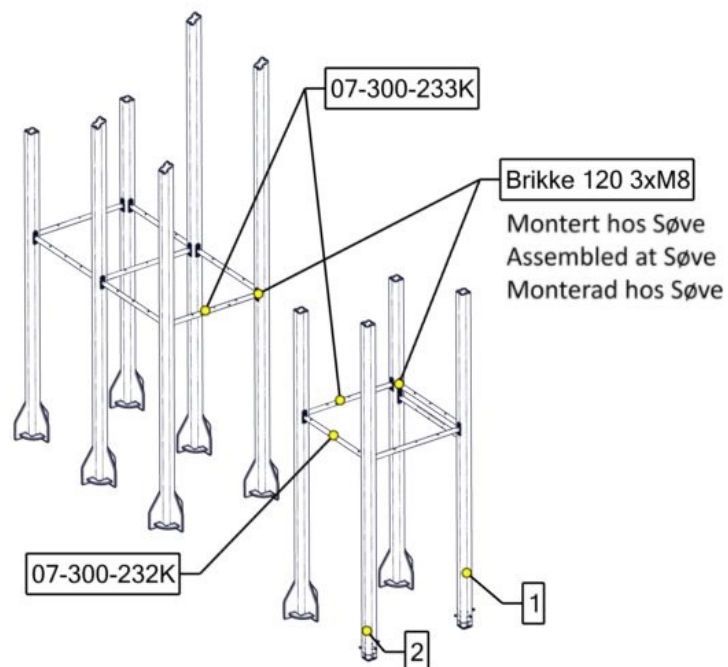
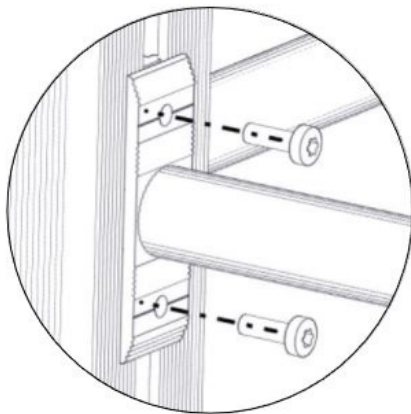

Part Name	Article nr.	Qty
Torx M8x25	04-000-025	44
Sperrerør gulv 2 hullcc 470	07-300-230	8
Sperrerør gulv 2 hull cc735 for portal	07-300-232	1
Sperrerør gulv 2 hullcc470 Hull BruaCC300	07-300-233	2



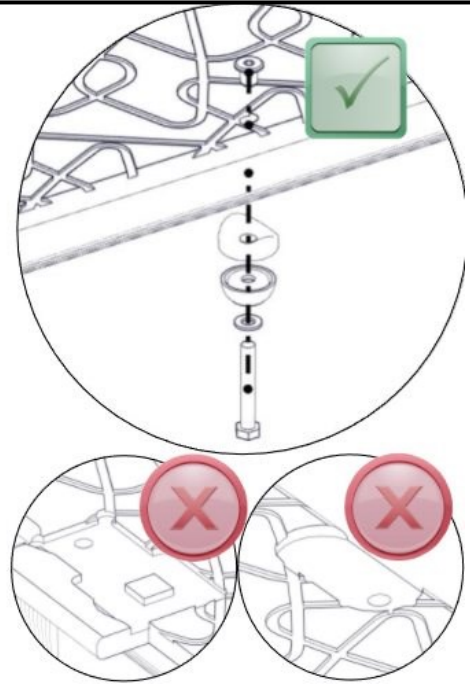
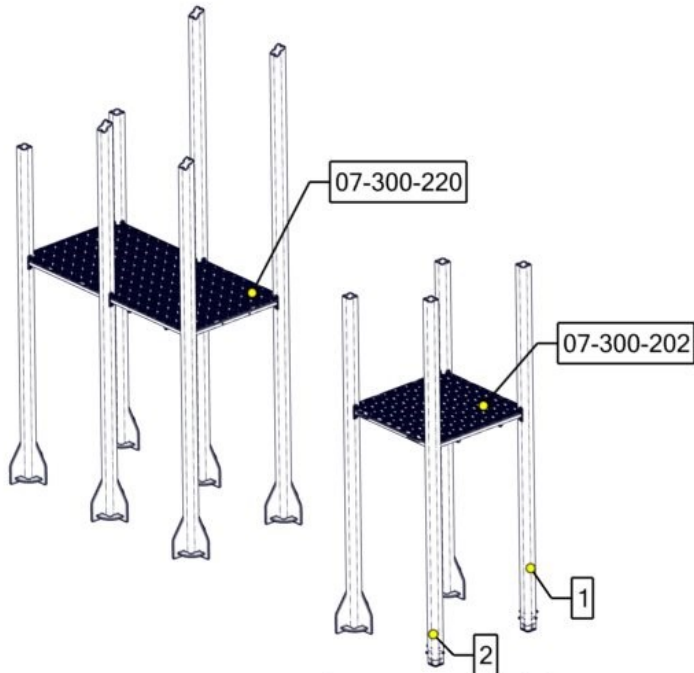

Part Name	Article nr.	Qty
Sekskant M8x55	04-008-055	10
Møbelknapp M8x11	04-030-011	10
Skive M8	04-050-008	10
Avstandskive Radie 38	04-210-010	10

Part Name	Article nr.	Qty
Sikkerhetshette kropp 32 svart for M8	05-301-045	10
Gulv 1075x1115 Portal-1-1-0	07-300-202	1
Gulv 2135x1075 LK_0-1-1-0-1	07-300-220	1

Se separat delmontering for detaljer  
 See separate assembly for details  
 Se separata delmontering för detaljer

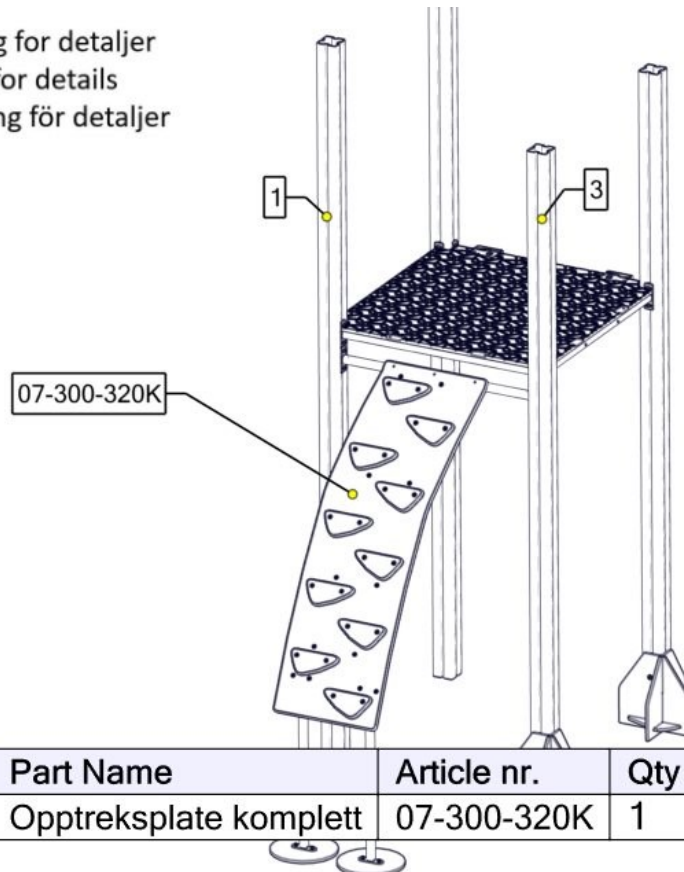

Part Name	Article nr.	Qty
Opptreksplate komplett	07-300-320K	1

Se separat delmontering for detaljer  
 See separate assembly for details  
 Se separata delmontering för detaljer

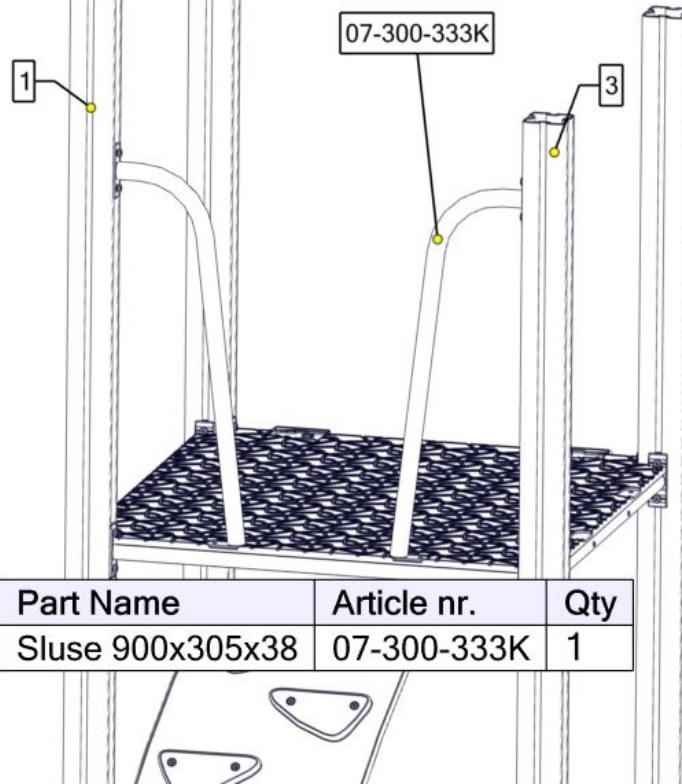

Part Name	Article nr.	Qty
Sluse 900x305x38	07-300-333K	1

Se separat delmontering for detaljer  
 See separate assembly for details  
 Se separata delmontering för detaljer

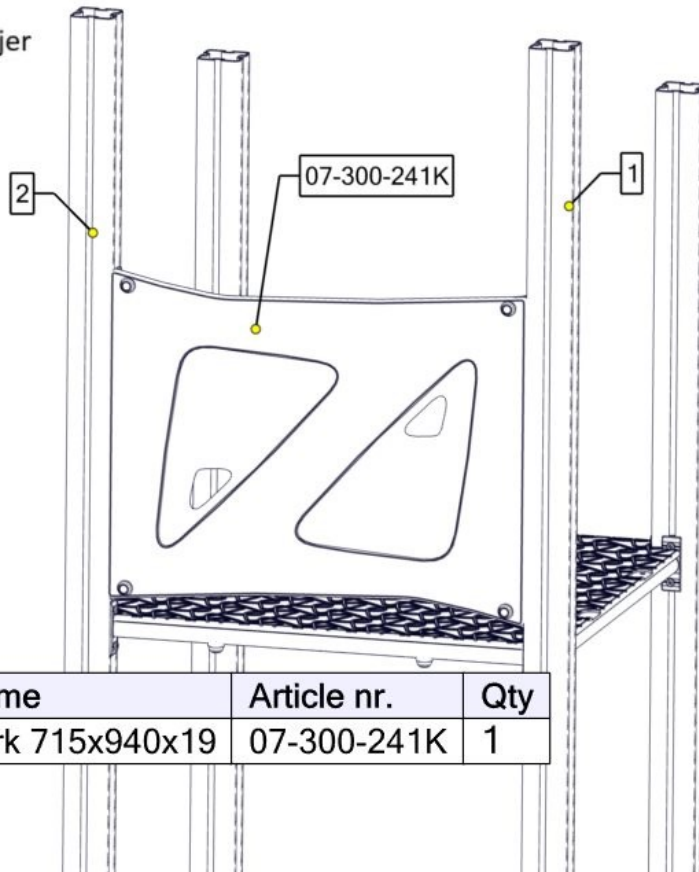

Part Name	Article nr.	Qty
Rekkverk 715x940x19	07-300-241K	1

Se separat delmontering for detaljer  
 See separate assembly for details  
 Se separata delmontering för detaljer

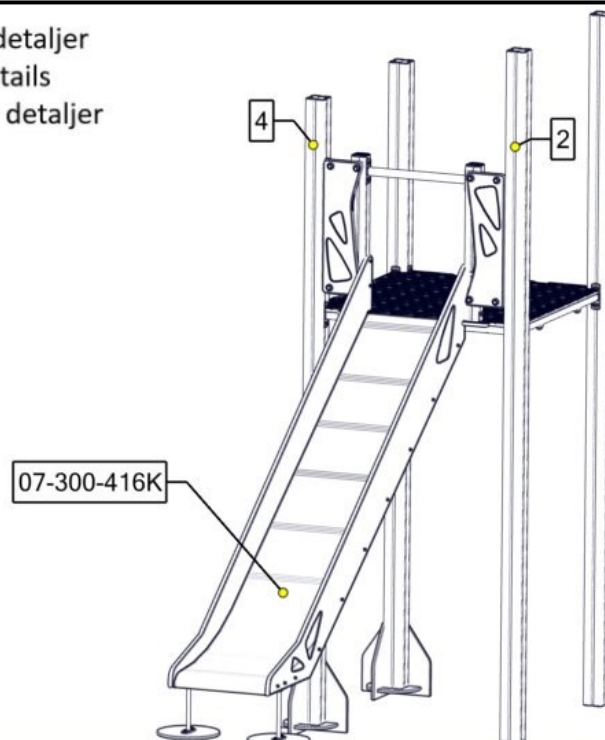

Part Name	Article nr.	Qty
Rutsjebane H1.4 med portal	07-300-416K	1

Se separat delmontering for detaljer  
 See separate assembly for details  
 Se separata delmontering för detaljer

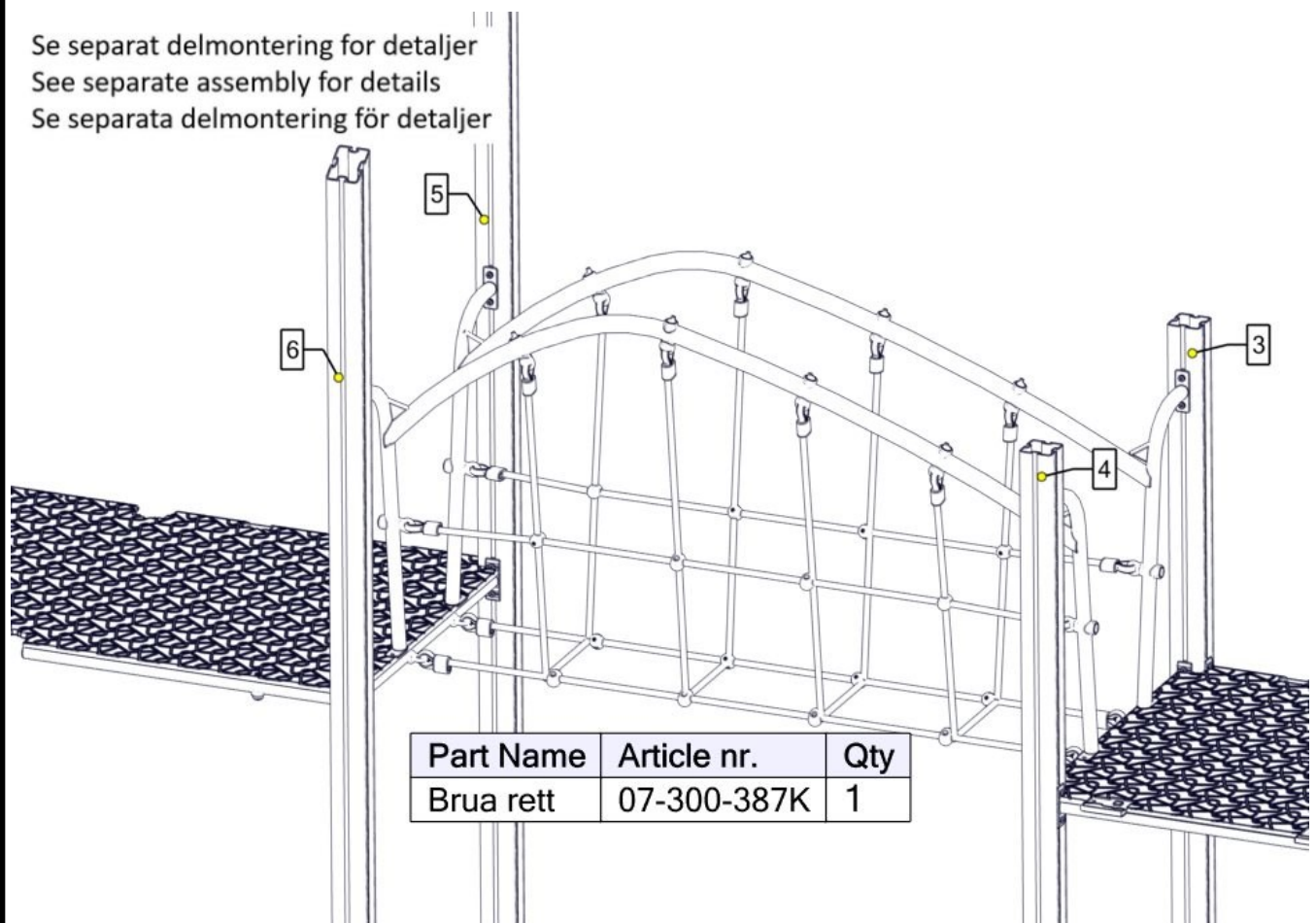

Part Name	Article nr.	Qty
Brua rett	07-300-387K	1

Se separat delmontering for detaljer  
 See separate assembly for details  
 Se separata delmontering för detaljer

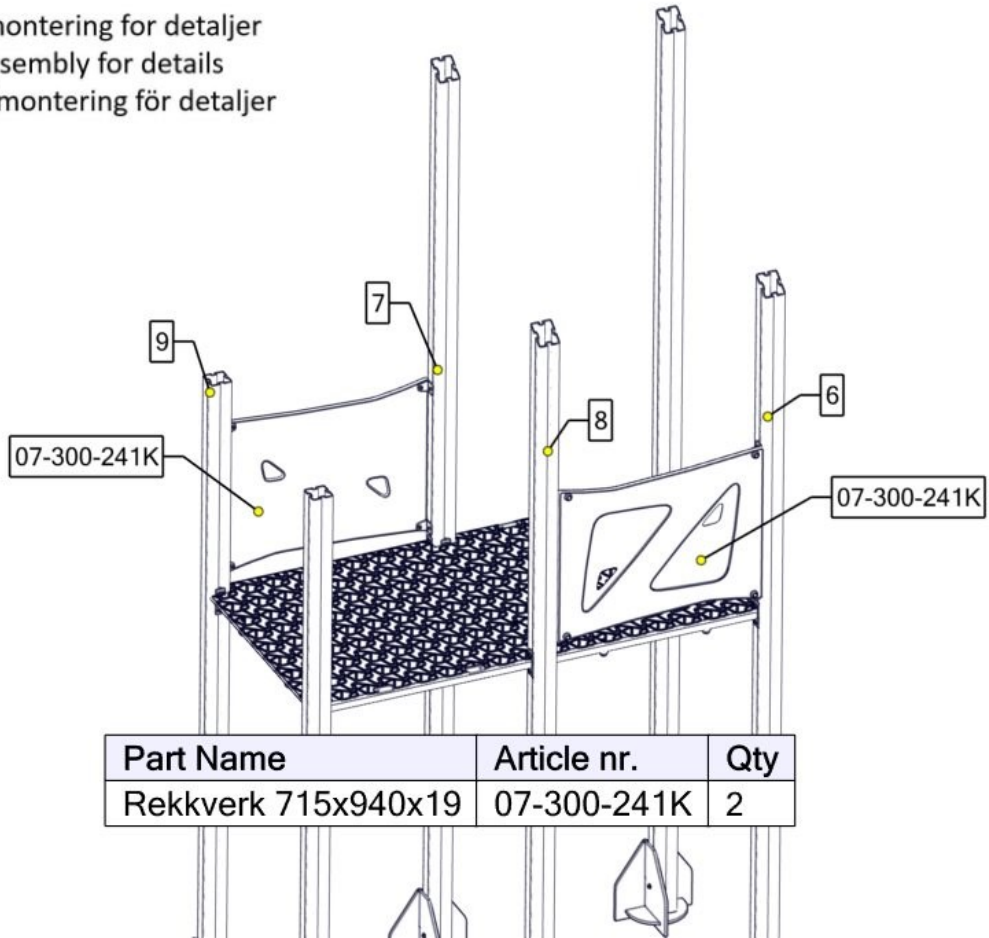

Se separat delmontering for detaljer  
 See separate assembly for details  
 Se separata delmontering för detaljer

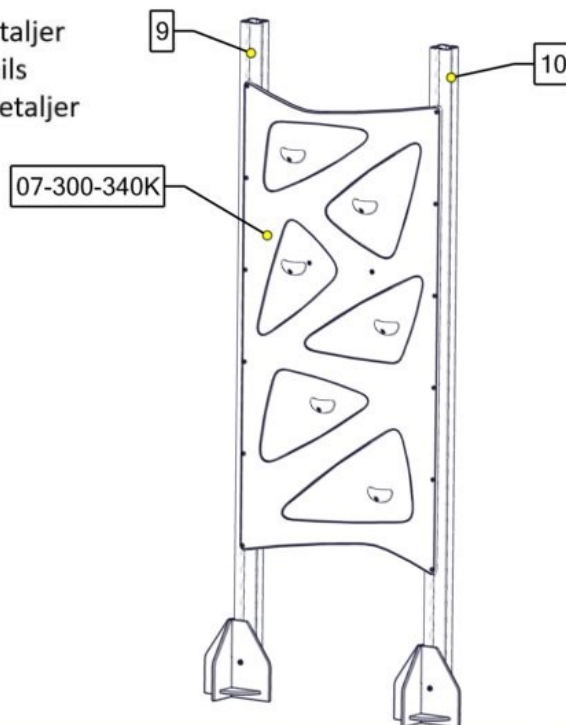



Se separat delmontering for detaljer  
 See separate assembly for details  
 Se separata delmontering för detaljer

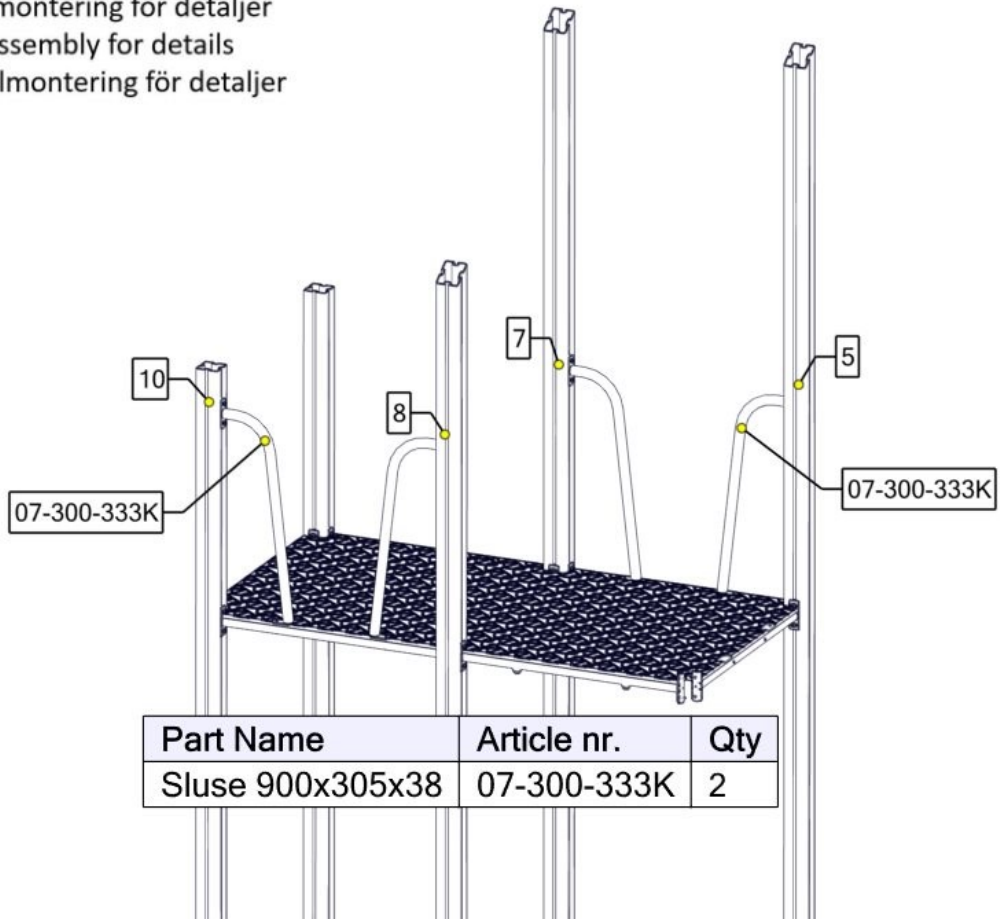

Part Name	Article nr.	Qty
Sluse 900x305x38	07-300-333K	2

Se separat delmontering for detaljer  
 See separate assembly for details  
 Se separata delmontering för detaljer

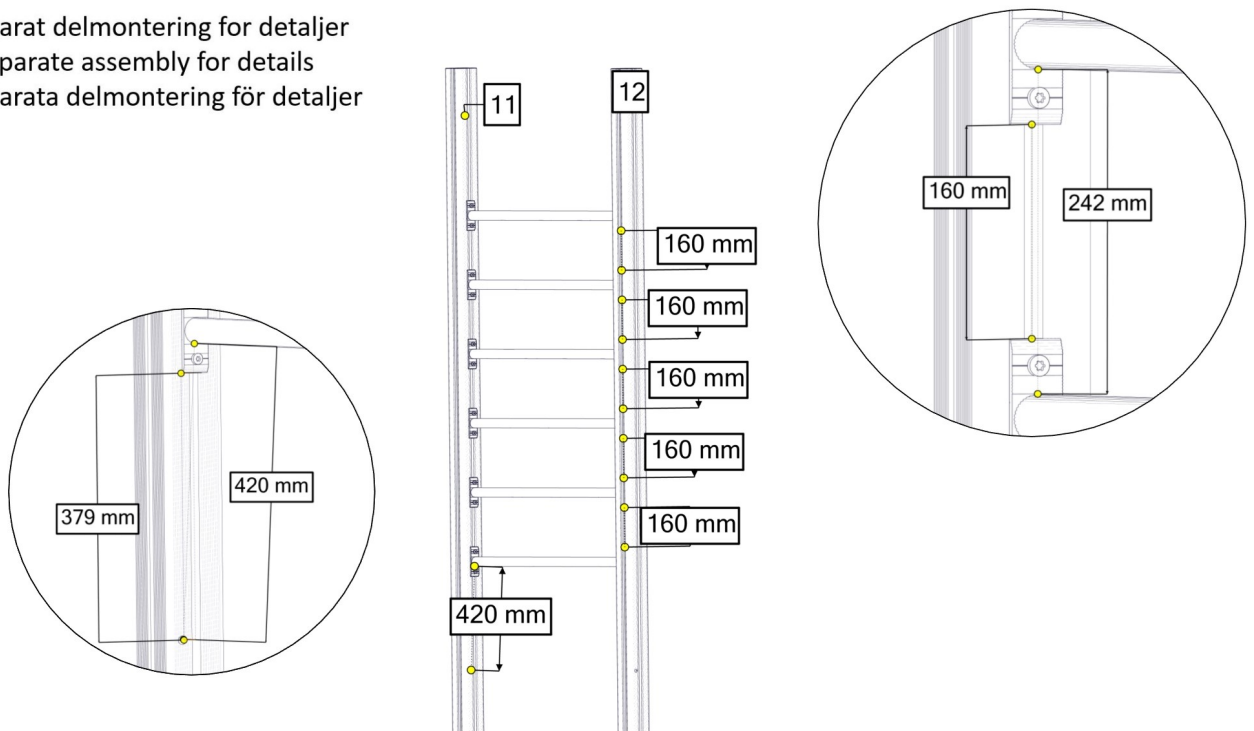

PartName	Artnr	Antall
Sperrerør L=940	00-400-156K	6

Se separat delmontering for detaljer  
 See separate assembly for details  
 Se separata delmontering för detaljer

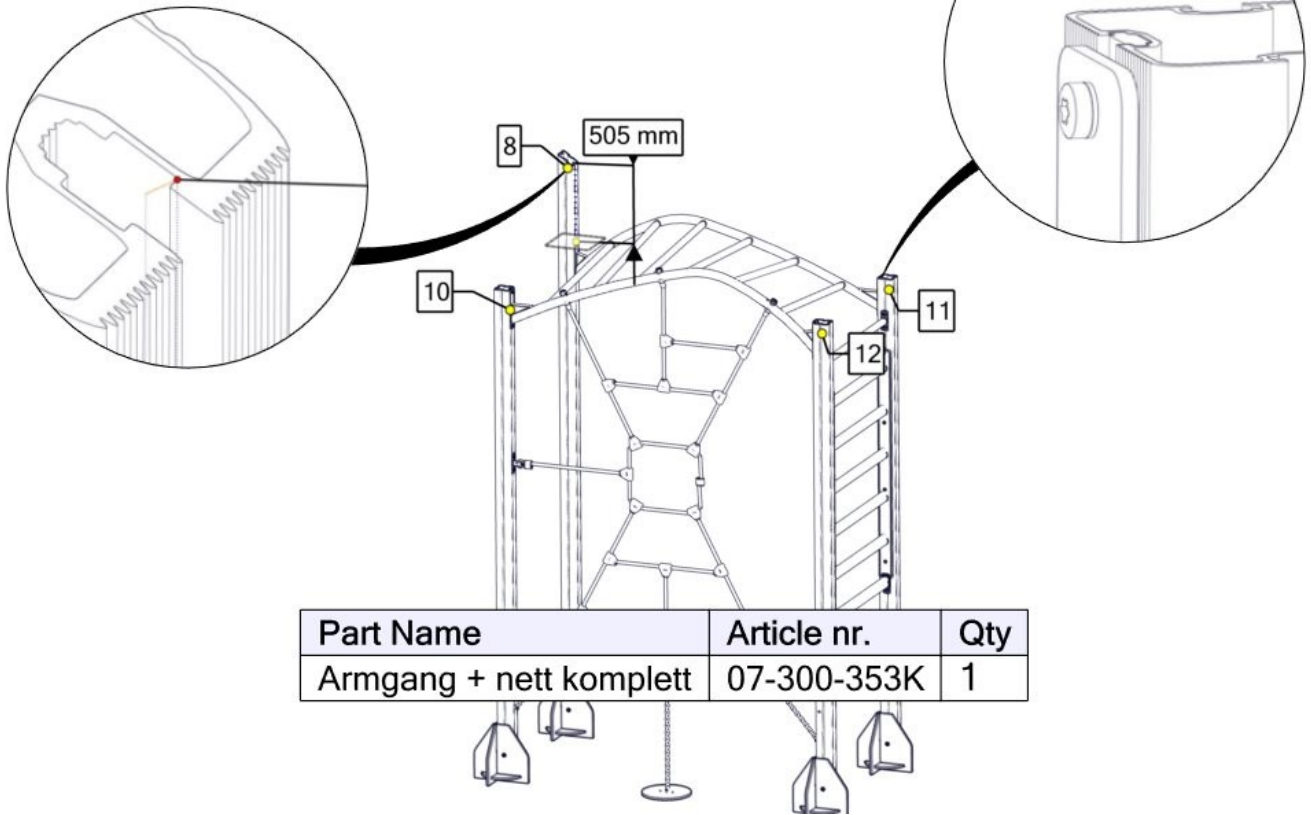

Part Name	Article nr.	Qty
Armgang + nett komplett	07-300-353K	1

Se separat delmontering for detaljer  
 See separate assembly for details  
 Se separata delmontering för detaljer

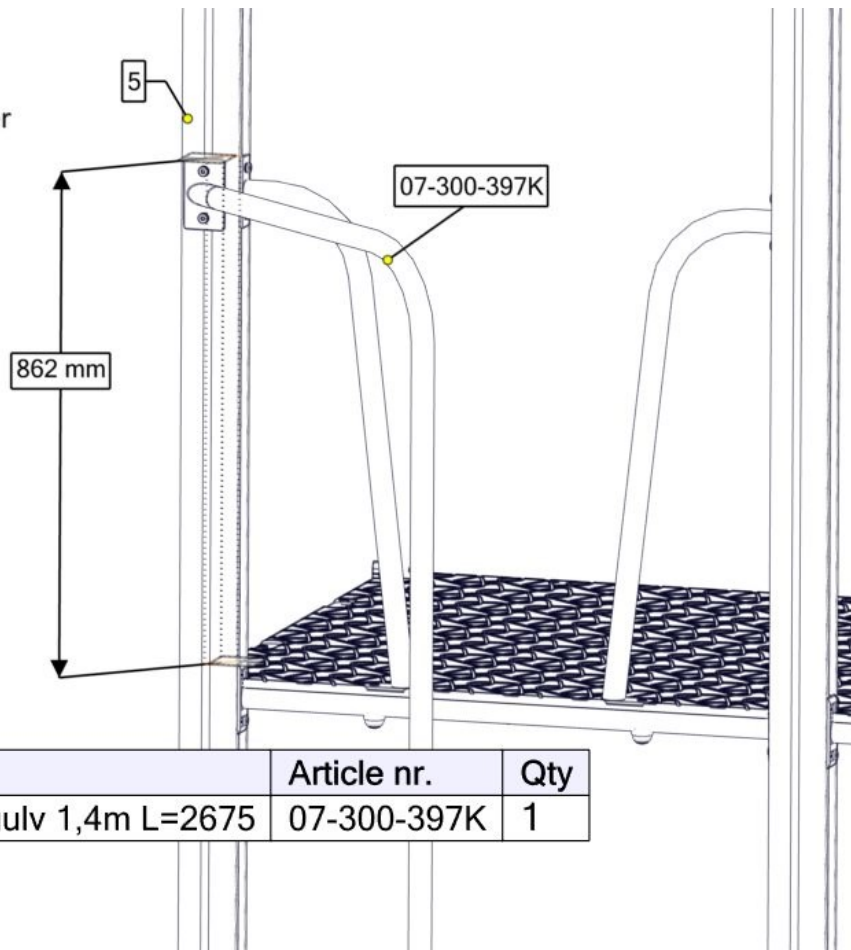

Part Name	Article nr.	Qty
Brannstang gulv 1,4m L=2675	07-300-397K	1



Se separat delmontering for detaljer  
 See separate assembly for details  
 Se separata delmontering för detaljer

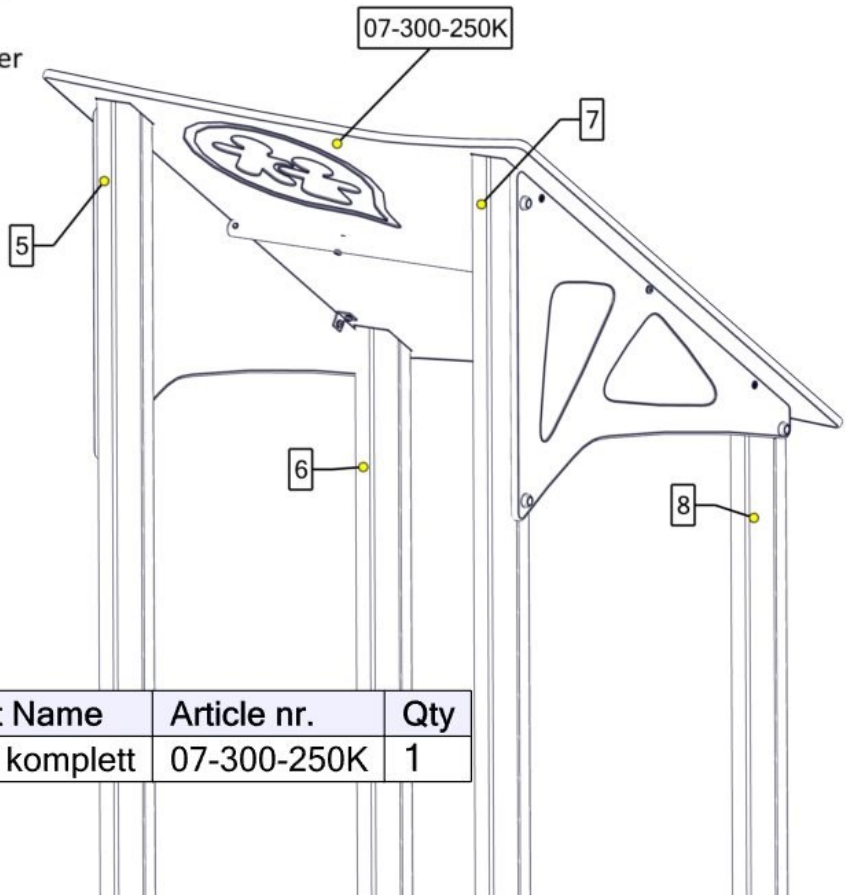

Part Name	Article nr.	Qty
Tak komplett	07-300-250K	1

Se separat delmontering for detaljer  
 See separate assembly for details  
 Se separata delmontering för detaljer

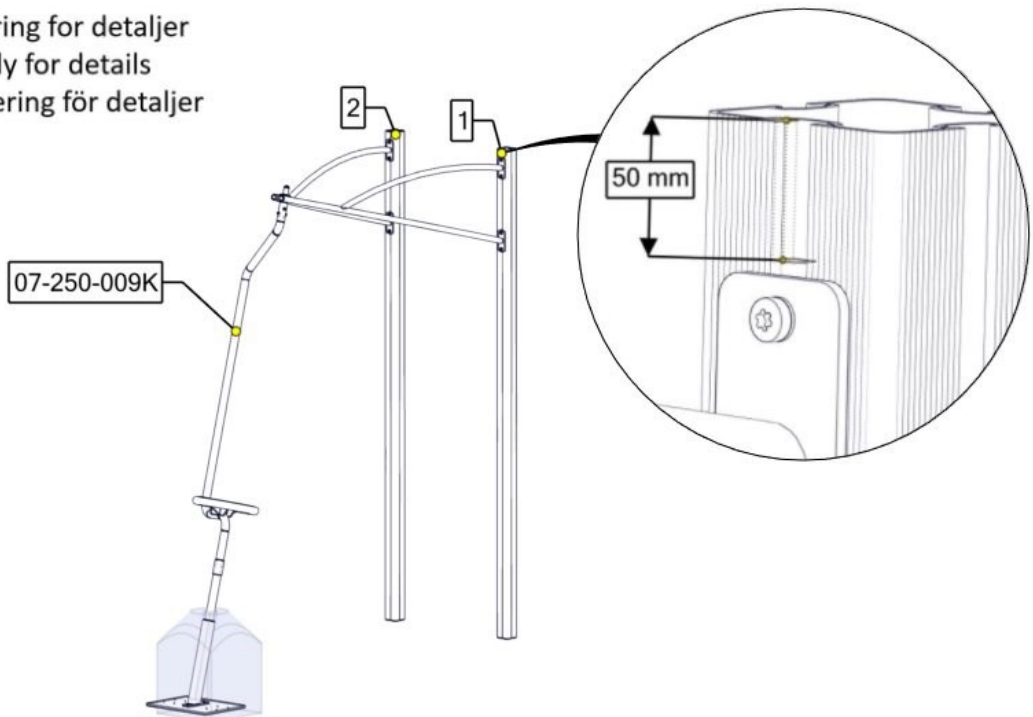

Part Name	Article nr.	Qty
Sving komplett	07-250-009K	1

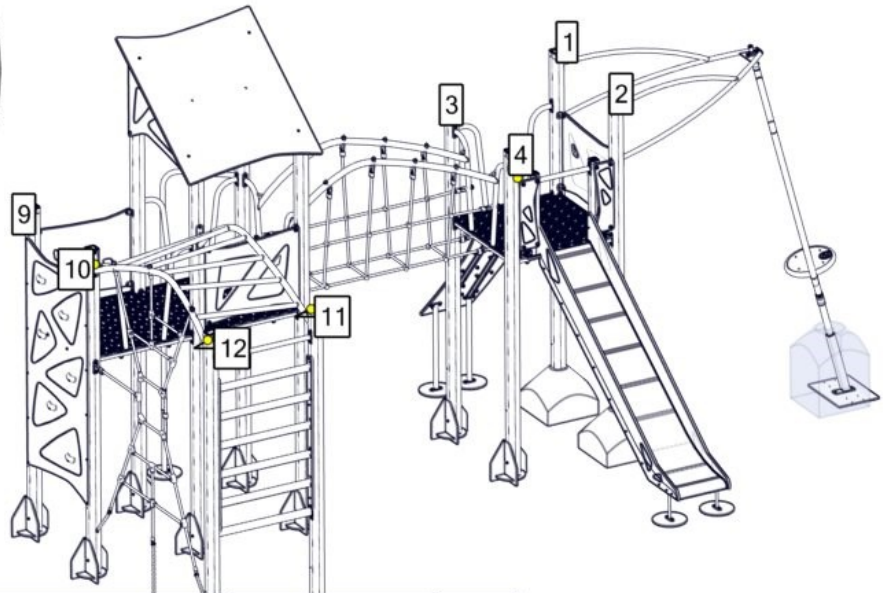
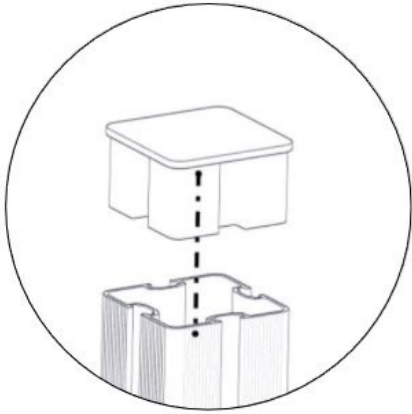

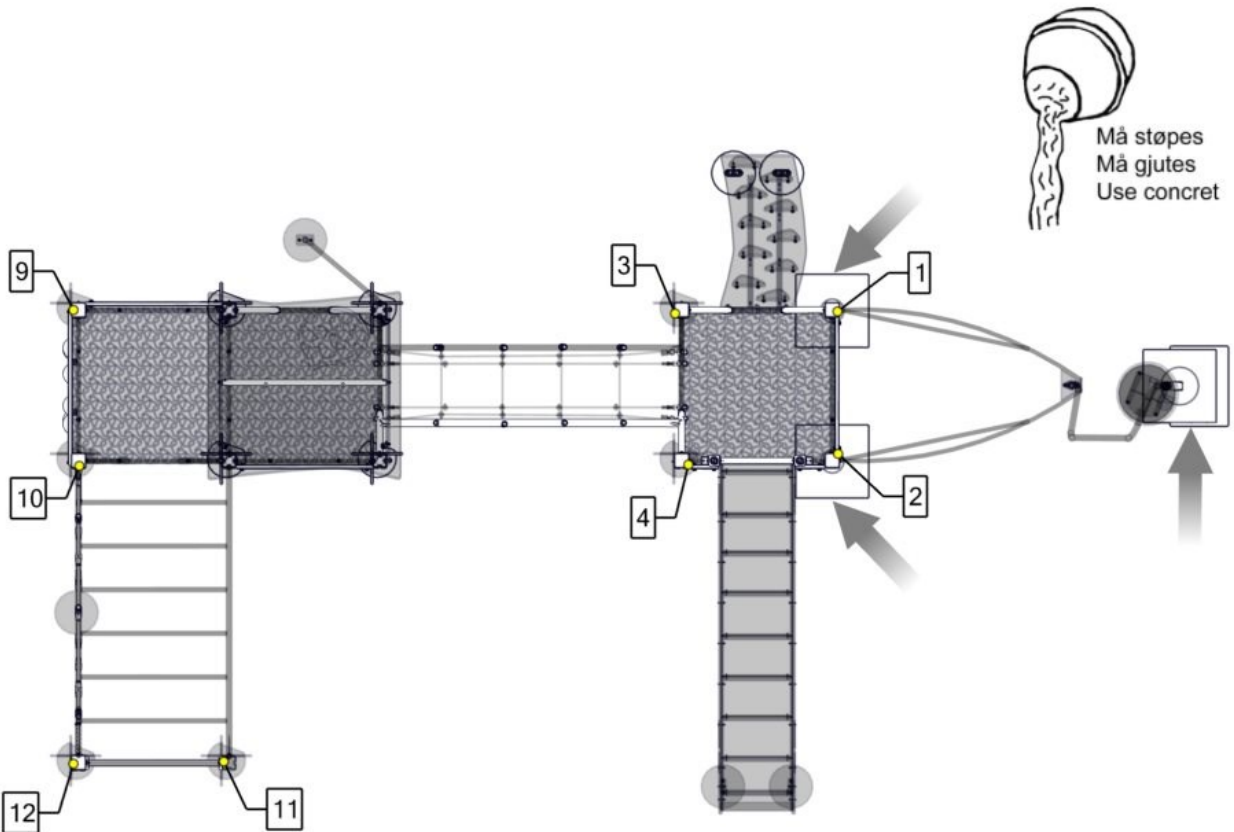

Part Name	Article nr.	Qty
Endelokk 95x95	00-400-998	8



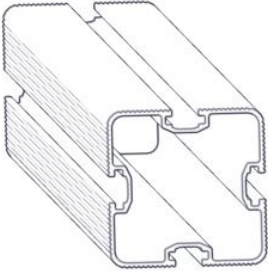
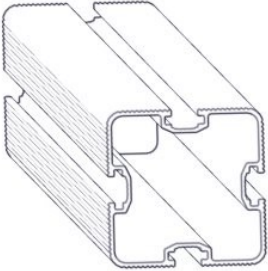
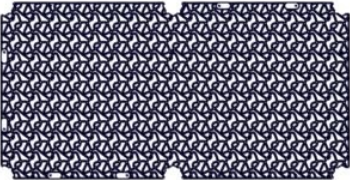
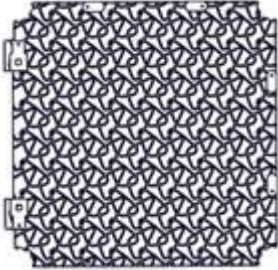

<b>Før utstyret tas i bruk / Before play begins // Innan lekredskapet tas i bruk</b>	
<b>N</b>	<ul style="list-style-type: none"> <li>● Påse at fallunderlag er utlagt i henhold til gjeldende regler eller vår anbefaling</li> <li>● Fjern alle monteringshjelpemidler ( rester av betong, planker, paller, plast, og lignende)</li> <li>● Før utstyret tas i bruk, burde man sjekke at det ikke er fare for at anorakksnorer og lignende som kan hekte seg fast noen steder på lekeapparatet. (Vedlagte snor med dobbe (kneledd) kan brukes til å sjekke at dette er i orden. Se vedlagte veiledning for bruk av denne. Dette gjøres for å oppdage eventuelle feilmonteringer.?)</li> <li>● NB! Bør stå i 2-3 dager før bruk</li> </ul>
<b>EN</b>	<ul style="list-style-type: none"> <li>● Make sure the area and depth of safer surfacing are according to the current standard, or to the manufacturer's recommendation</li> <li>● Make sure all tools and surplus materials are removed before play begins</li> <li>● PS! When complete, allow 2-3 days for the concrete to set before use</li> </ul>
<b>S</b>	<ul style="list-style-type: none"> <li>● Kontrollera att fallunderlag är utlagt enligt gällande regler eller vårt rekommendation</li> <li>● Ta bort alla monteringshjälpmedel (rester av betong, plankor, pallar, plast och liknande)</li> <li>● Innan lekredskapet används, kontrollera att anoracksnoddar eller kläder/delar av kläder eller liknande inte kan fastna i några delar på redskapet. (Den bipackade "knävringen" kan man med fördel användas för denna kontroll.</li> <li>● Detta görs för att upptäcka eventuella felmonteringar.)</li> </ul>





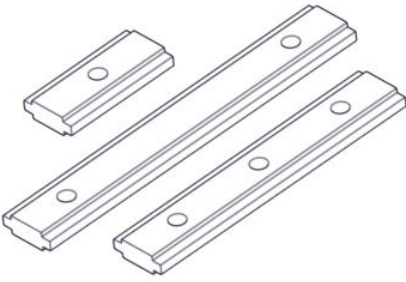
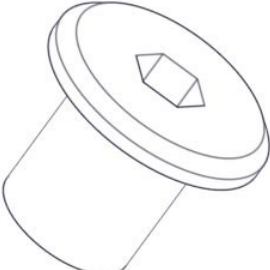
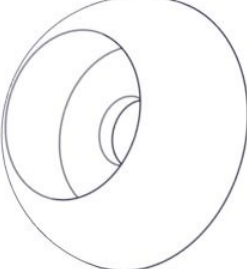
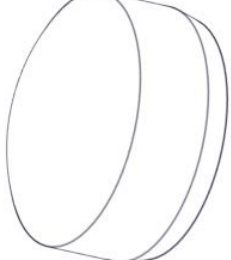

<b>Boltepakker for / Boltpackage for / Bultpaket för</b>		Sign. _____		
<b>Saturn Narvi 11-500-100</b>	<b>Navn</b>	<b>Artnr/ dimensjon</b>	<b>Ant</b>	<b>Lev</b>
	Stolpe 95x95 Lengde = 3030 Sort	SFA5117/1	6	
	Stolpe 95x95 Lengde = 3350 Sort	SFA5117/1	2	
	Stolpe 95x95 skrå 55 Lengde = 3600 Sort	SFA5117/1	2	
	Stolpe 95x95 skrå 55 Lengde = 4325 Sort	SFA5117/1	2	
	Gulv 2135x1075x15 LK-0-1-1-0-1 Grå	07-300-220	1	
	Gulv 1075x1115x15 Portal-1-1-0 Grå	07-300-202	1	
	Sperrerør for gulv Lengde = 940 2hull cc470 Sort	07-300-230	8	
	Sperrerør for gulv Lengde = 940 2hull cc735 for portal Sort	07-300-232	1	

**Boltepakker for / Boltpackage for / Bultpaket för**

Sign. \_\_\_\_\_

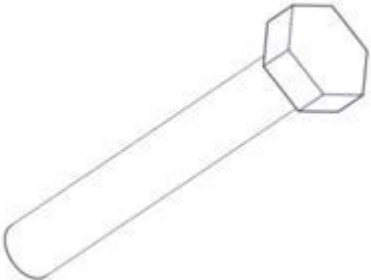
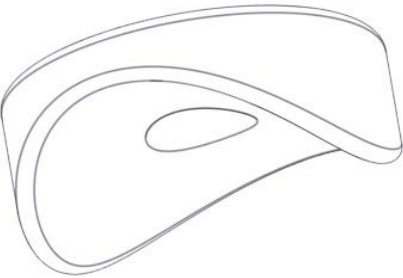
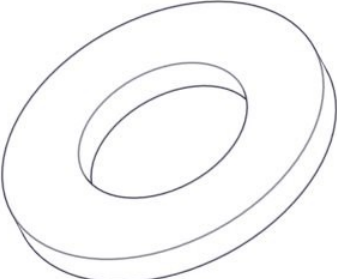



Saturn Narvi 11-500-100	Navn	Artnr/ dimensjon	Ant	Lev
	Sperrerør Lengde = 940 2hull cc470 + 2hull cc300 Bru Sort	07-300-233	2	
	Torx M8x25	04-000-025	44	
	Brikke 120 3xM8	04-060-120 (montert hos Søve)	0	
	Møbelknapp M8x11	04-030-011	22	
	Sikkerhets hette kropp	05-301-045	22	
	Sikkerhets hette topp	05-301-044	22	



<b>Boltepakker for / Boltpackage for / Bultpaket för</b>		Sign. _____.		
<b>Saturn Narvi 11-500-100</b>	<b>Navn</b>	<b>Artnr/ dimensjon</b>	<b>Ant</b>	<b>Lev</b>
	Sekskant M8x55	04-008-055	22	
	Avstandskive for Ø38	04-210-010	22	
	Skive M8	04-050-008	22	
	Produktmerke	00-100-400 (montert hos Søve)	0	
	Brannstang Gulv 1,4m Pistasj	07-300-397K (se egen del- montering)	1	
	Swing CC1035 Blå / Pistasj	07-250-009K (se egen del- montering)	1	

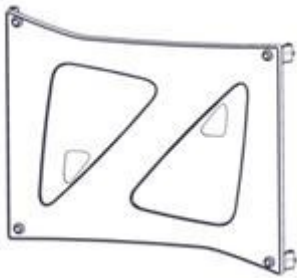



**Boltepakker for / Boltpackage for / Bultpaket för**

Sign. \_\_\_\_\_

Saturn Narvi 11-500-100	Navn	Artnr/ dimensjon	Ant	Lev
	Rekkverk 715x940x19 Blå	07-300-241K (se egen del- montering)	3	
	Tak Blå	07-300-250K (se egen del- montering)	1	
	Sluse Pistasj	07-300-333K (se egen del- montering)	3	
	Klatrevegg 2180x1605x19 Blå	07-300-340K (se egen del- montering)	1	
	Rutsjebane med portal H=1,4m Blå—pistasj	07-300-416K (se egen del- montering)	1	

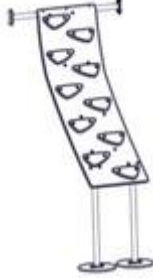
**Boltepakker for / Boltpackage for / Bultpaket för**

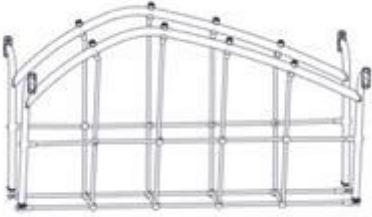
Sign. \_\_\_\_\_.

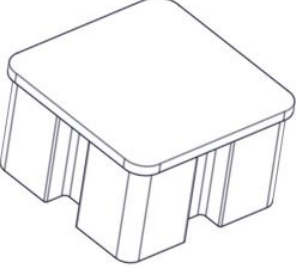
Saturn Narvi 11-500-100	Navn	Artnr/ dimensjon	Ant	Lev
	Opptrekksplate Blå	07-300-320K (se egen del- montering)	1	
	Armgang med nett Pistasj	07-300-353K (se egen del- montering)	1	
	Brua rett Blå	07-300-387K (se egen del- montering)	1	
	Sperrør L=940 sort	00-400-156K (se egen del- montering)	6	
	Endelokk 95x95	00-400-998	8	

**Boltepakker for / Boltpackage for / Bultpaket för**

Sign. \_\_\_\_\_.

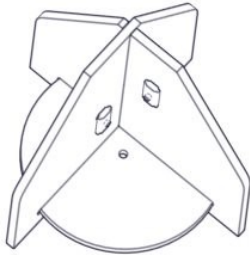
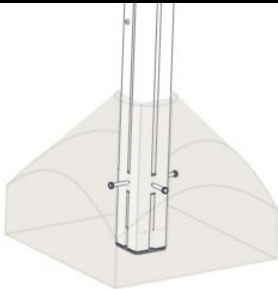
Saturn Narvi 11-500-100	Navn	Artnr/ dimensjon	Ant	Lev
	<b>Fundament Nedgravning</b>			
	Nedgravingsfundament 95x95	00-003-004K (se egen del- montering)	10	
	Støpefundament 95 x 95 stolpe	00-003-110K (se egen del- montering)	2	

**Boltepakker for / Boltpackage for / Bultpaket för**

Sign. \_\_\_\_\_.

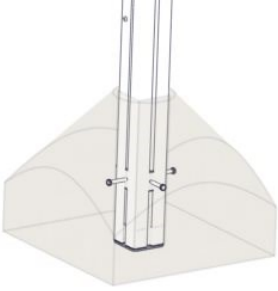
Saturn Narvi 11-500-100	Navn	Artnr/ dimensjon	Ant	Lev
	<b>Fundament Støp</b>			
	Støpefundament 95 x 95 stolpe	00-003-110K (se egen del- montering)	12	

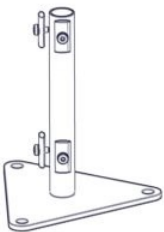
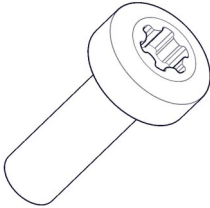
<b>Boltepakker for / Boltpackage for / Bultpaket för</b>		Sign. _____		
Saturn Narvi 11-500-100	Navn	Artnr/ dimensjon	Ant	Lev
	<b>Overflate fun- damentering</b>			
	Fundament 95x95 stolpe for betongdekke	00-003-125K (Se egen del- montering)	12	
	<b>Deler som må Endres, Changed parts</b>			
	Opptreksplate forankring	07-300-320K	(2)	
	Rutsjebane forankring	07-300-416K	(2)	
	Sving kappes	07-250-009K	(1)	
	Brannstang kappes	07-300-397K	(1)	
	Stolpene kappes	SFA5117/1	(12)	
	Bruk kortere bolter når du monterer den nederste delen av veggene	04-000-016	2	

**Revisjon:**

13.07.2020

Lagt til tabell

Oppdatert BOM

Oppdatert plukklister for rutsjebane

Oppdatert fundamentbilder

14.07.2020

Oppdatert plukklister for fundamenter

Oppdatert sikkerhetszone, areal og stolpeplassering

Oppdatert div view

12.07.2023

Endret ribbevegg med plast sider til 6 sperrør.

(07-300-390 byttet ut til 6stk 00-400-156K)