

N

**Monteringsanvisning**

EN

**Assembly Instructions**

S

**Monteringsanvisning**

Produkt nr. / Product no. / Produkt nr.

**11-500-151****Oransje / Lilla**

Ord. nr. \_\_\_\_\_

Dato. \_\_\_\_\_

Sign. \_\_\_\_\_

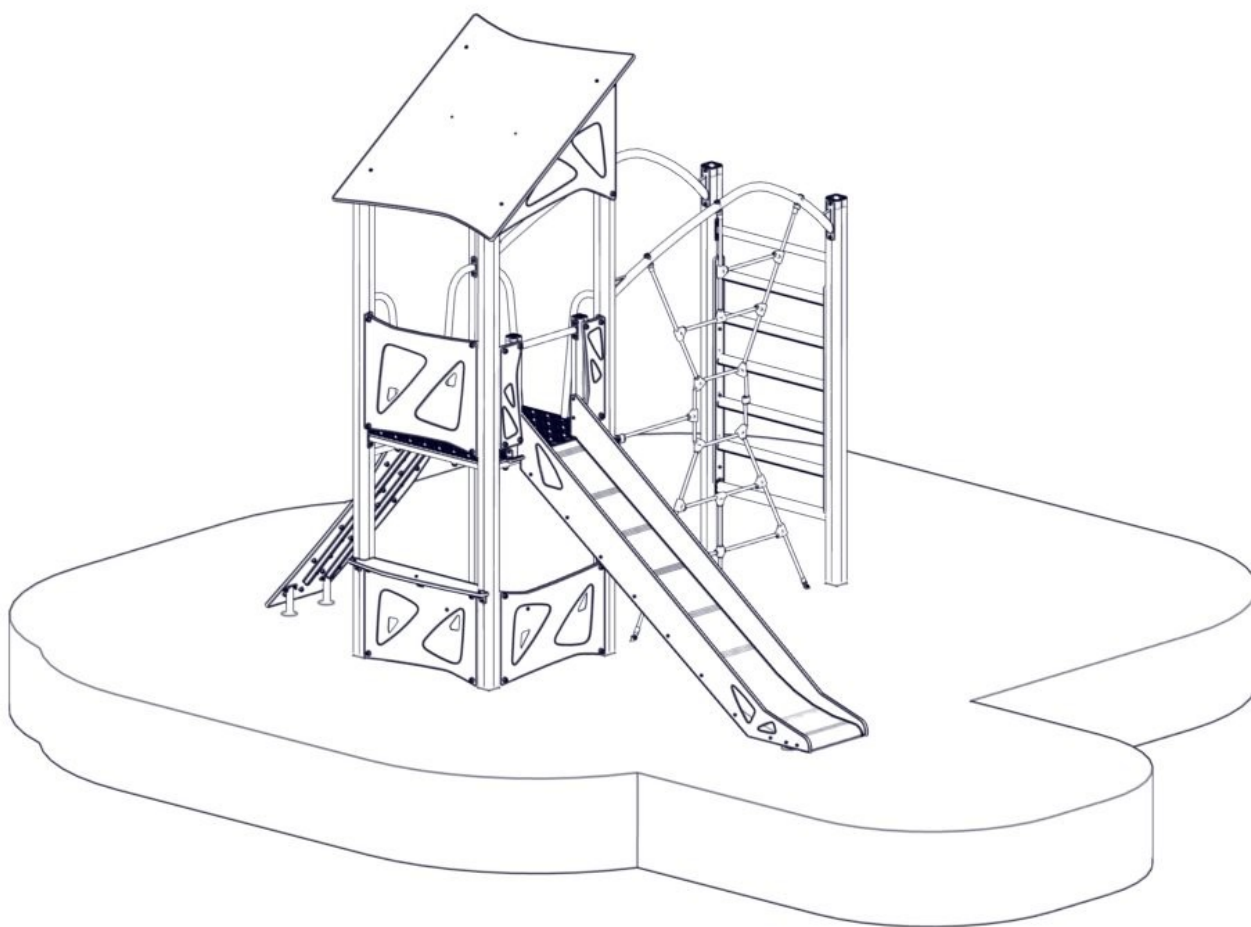
**søve**

Søve AS  
Grønnvoldveien 290  
3830 Ulefoss - Norway  
Tlf: +47 35 94 65 65  
[www.sove.no](http://www.sove.no)

**søve**

Søve AB  
EA Rosengrensgatan 32  
421 31 Västra Frölunda  
Phone: +46 (0)31 773 97 00  
[www.sove.se](http://www.sove.se)

## Monteringstips / Assembly Advice / Monteringsstips

N

- Les monteringsanvisningen nøye før montering.
- Monter elementene i rekkefølgen som vist.
- Boltene bør ikke skrues for hardt til før alt er montert, vatret og loddet. Skru så boltene til.
- NB! Ved bruk av drill, kan boltene ryke.
- På grunn av at solen kan gjøre rutsjeflaten veldig varm, bør rutsjebanens utløp vende mot nord-øst eller nord-vest.
- Er lekeutstyret plassert i naturlige ferdselstraséer må området sikres mot gjennomgang.
- Innspringningshinder bør vurderes rundt lekeapparater hvor det er stor bevegelse, f.eks. ved huskestativ.
- Det bør være fritt innsyn til lekeutstyr som er beregnet for barn under 3 år.

**NB! Under monteringsarbeidet må utstyr, som ikke er forankret forsvarlig i bakken, sikres slik at det ikke velte.**

**Området må avstenges under montering av apparatene med sperrebånd eller lignende.**

EN

- Read the instruction carefully before assembling the play unit.
- Assemble the components in the sequence shown in these instructions.  
Fixings must not be fully tightened during assembly. Before casting the foundations, the structure must be level and plumb, at which point all fixings are tightened.  
PS! If use of drill, the bolts may be wrecked.
- Avoid positioning the slide facing due south because of overheating – ideal positions are facing north-east or north-west.  
Secure the construction-area to prevent people from walking through it.
- Consider installing barriers around play-equipment which gives rise to a lot of activity – i.e. swings.
- Ensure that clear vision is possible across the play area so that supervision is possible from any position, particularly where children under 3 years of age will be playing.

**NB! During assembly of the equipment, ensure that all structures are securely propped, especially when left overnight. Also ensure that equipment is supported**

**Monteringstips / Assembly Advice / Monteringsstips****S**

- Läs monteringsanvisningen noga före montering.

- Montera delarna i den ordningen som anvisas
- Skruvarna bör inte skruvas för hårt tills allt är monterat, i våg och lodat.









OBS! Används elektrisk skruvdragare, kan bulten gå sönder. Hårdra därför manuellt!

- Solen kan göra att rutchbanan blir väldigt varm. Banans nedfart rekommenderas att vändas i norrlig riktning
- Om lekplatsen placeras vid en gångväg mm bör området säkras mot genomfart av gående och cyklister.
- Insprängningshinder bör placeras runt lekutrustning med stor rörelse, t ex, gungställning.
- Det bör vara fri insyn till lekutrustning beräknat till barn under 3 år.

**OBS! Under monteringsarbete bör utrustningen som inte ska förankras i marken, ställs så att den inte kan välta.**

**Området måste spärras när lekutrustningen byggs upp, med avspärrningsband eller liknande.**

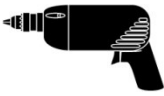
**Nødvendig verktøy / Tools required / Nödvändiga verktyg**

<p>(N)</p> <p>(EN)</p> <p>(S)</p>	<p>(A)</p> 	<p>(B)</p>  <p>Torx Nr 45</p>	<p>(C)</p> <p>5 mm 6 mm</p> 	<p>(D)</p> 	<p>(E)</p> 
		<p>Metermål Metric measure Tumstock</p> 	<p>Ø11mm Bor Ø11mm Drill Ø11mm Borr</p> 	<p>Merkebånd Mark ribbon Märkeband</p> 	<p>13 + 17mm</p> 

**Nødvendig antall personer / Number of persons required / Rekommenderad antal personer**

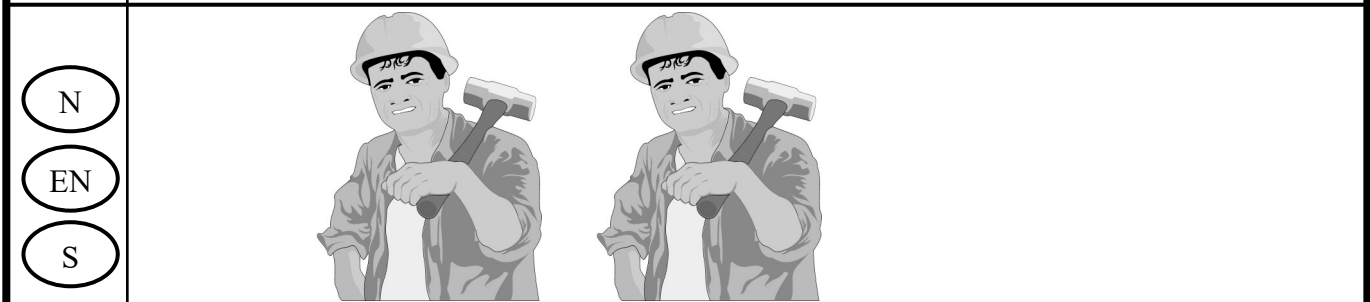

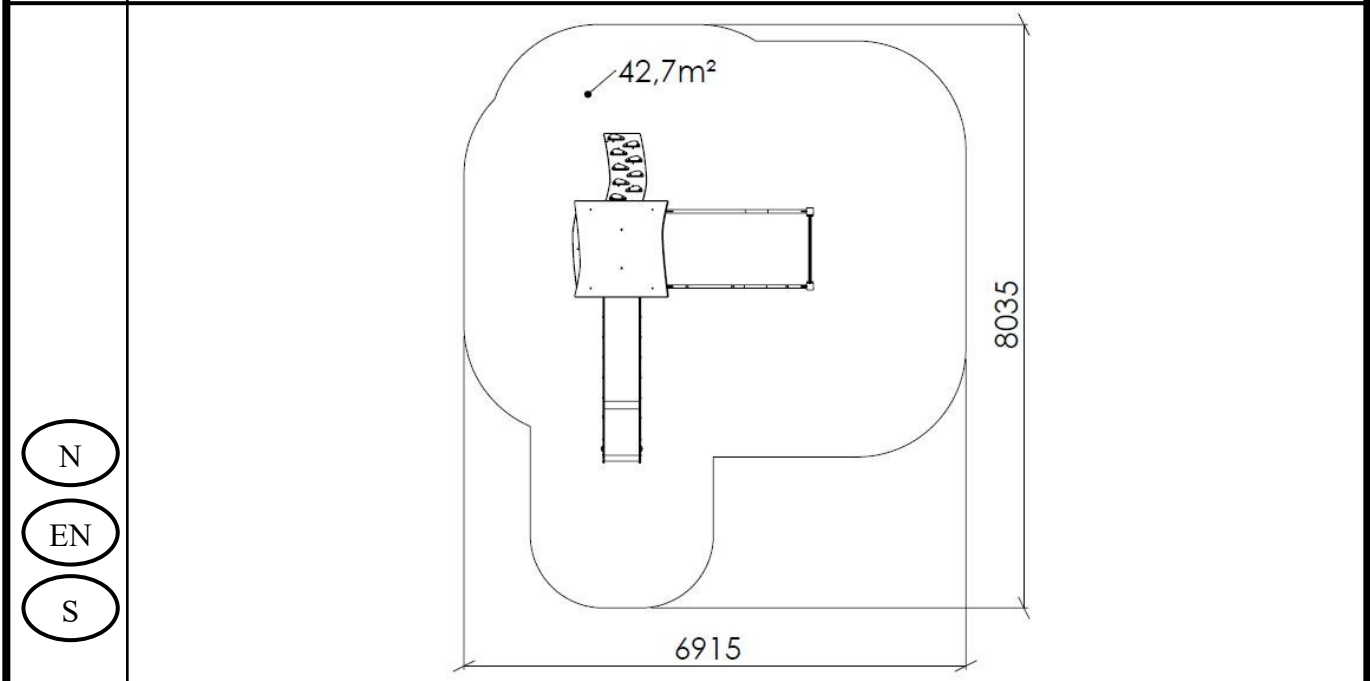

**Anbefalt arealbehov ved montering / Recommended working space / Rekommenderad arealbehov vid montering**



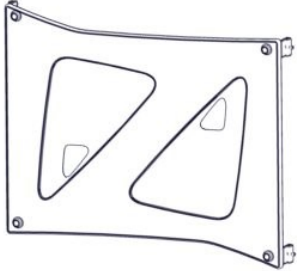
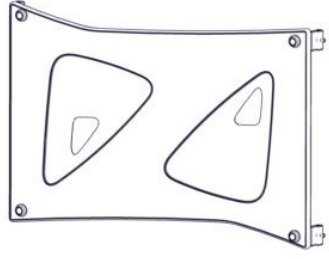
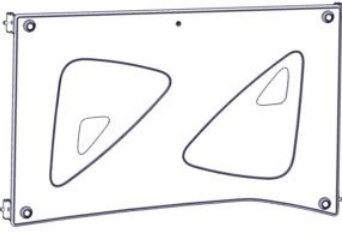
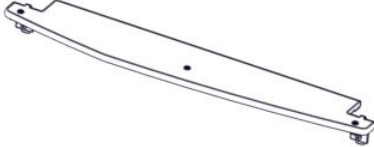

**Boltepakker for / Boltpackage for / Bultpaket för**

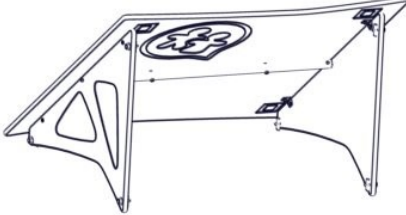

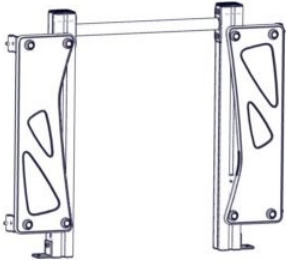
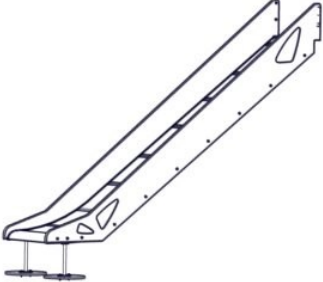

Sign. \_\_\_\_\_

Saturn Thrymr 2 11-500-151	Navn	Artnr/ dimensjon	Ant	Lev
	Rekkverk Oransje 715x940x19	07-300-240K (se egen del- montering)	1	
	Rekkverk Oransje 600x940x19	07-300-242K (se egen del- montering)	1	
	Rekkverk Butikkdisk Oransje 600x940x19	07-300-245K (se egen del- montering)	1	
	Butikkdisk Oransje 1122x200x19	07-300-291K (se egen del- montering)	1	
	Kokeplate Oransje	07-300-293K (se egen del- montering)	1	
	Tak Oransje	07-300-255K (se egen del- montering)	1	

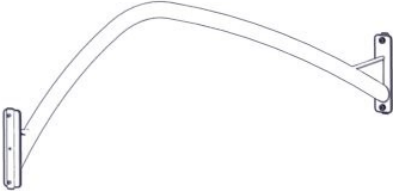
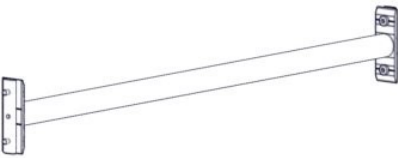
**Boltepakker for / Boltpackage for / Bultpaket för**

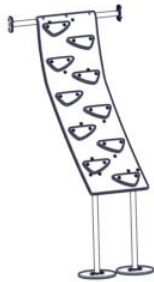

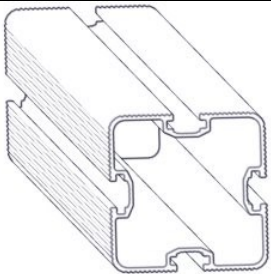
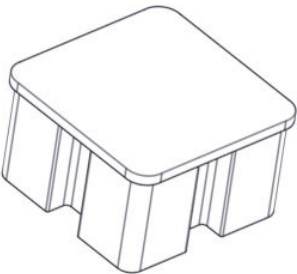
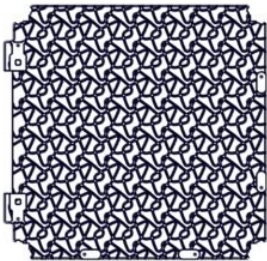

Sign. \_\_\_\_\_

Saturn Thrymr 2 11-500-151	Navn	Artnr/ dimensjon	Ant	Lev
	Portal med sperrerør Oransje	07-300-282K (se egen del- montering)	1	
	Rutsjebane Oransje / Lilla H=1,4m	07-300-411K (se egen del- montering)	1	
	Edderkoppnett + rør Oransje	07-300-401K (se egen del- montering)	1	
	Rør uten hull Oransje	07-300-406K (se egen del- montering)	1	
	Sperrerør L=940 Uten hull Sort	00-400-156K (se egen del- montering)	6	

<b>Boltepakker for / Boltpackage for / Bultpaket för</b>		Sign. _____		
<b>Saturn Thrymr 2 11-500-151</b>	<b>Navn</b>	<b>Artnr/ dimensjon</b>	<b>Ant</b>	<b>Lev</b>
	Opptrekkplate Oransje	07-300-321K (se egen del- montering)	1	
	Sluse Lilla 900x305x38	07-300-332K (se egen del- montering)	2	
	Stolpe 95x95 L=3600 skrå Sort	SFA5117/1	2	
	Stolpe 95x95 L=4325 skrå Sort	SFA5117/1	2	
	Stolpe 95x95 L=3030 Sort	SFA5117/1	2	
	Endelokk 95x95	00-400-998	2	
	Gulv Portal-0-1-1 Grå 1075x1115	07-300-203	1	
	Produktmerke	00-100-400 (Montert hos Søve)	0	

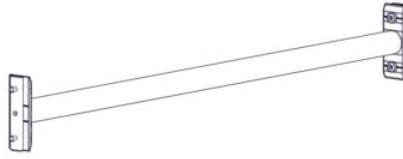
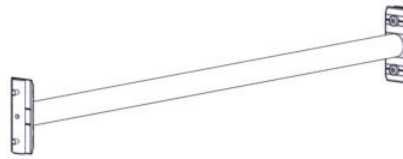
**Boltepakker for / Boltpackage for / Bultpaket för**

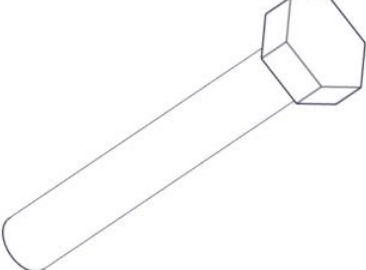
Sign. \_\_\_\_\_

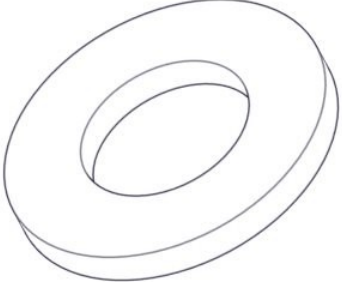

Saturn Thrymr 2 11-500-151	Navn	Artnr/ dimensjon	Ant	Lev
	Sperrerør gulv Sort L=940 2 Hull cc470	07-300-230	3	
	Sperrerør gulv Sort L=940 2 Hull cc735 for portal	07-300-232	1	
	Torx Skrue M8x25	04-000-025	16	
	Sekskant skrue M8x55	04-008-055	8	
	Møbelknapp M8x11	04-030-011	8	
	Skive M8	04-050-008	8	

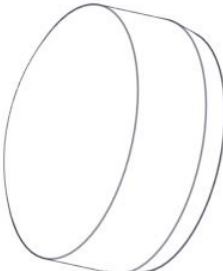
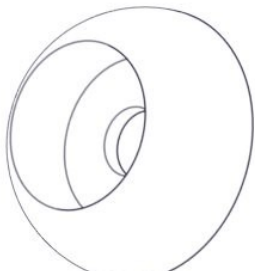
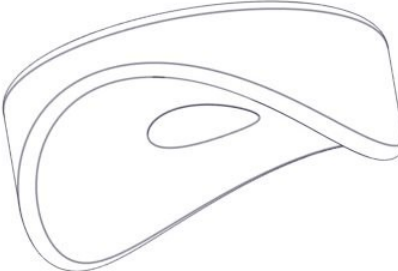

**Boltepakker for / Boltpackage for / Bultpaket för**

Sign. \_\_\_\_\_.

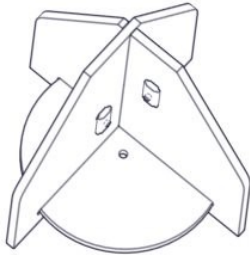
Saturn Thrymr 2 11-500-151	Navn	Artnr/ dimensjon	Ant	Lev
	Sikkerhetshette topp Sort 20mm for M8	05-301-044	8	
	Sikkerhetshette kropp Sort 32mm for M8	05-301-045	8	
	Avstandskive plast Sort Radié for 38mm	04-210-010	8	

<b>Boltepakker for / Boltpackage for / Bultpaket för</b>		Sign. _____.		
Saturn Thrymr 2 11-500-151	Navn	Artnr/ dimensjon	Ant	Lev
	<b>Fundament Nedgraving</b>			
	Nedgravingsfundament 95x95	00-003-004K (se egen del- montering)	6	
	<b>Fundament Støp</b>			
	Støpe fundament	00-003-110K (se egen del- montering)	6	

**Fundamentering med betong // Foundation concrete // Förankring med betong**

- (N) Komprimert masse Ref NS-EN 1176-1
- (EN) Compressed mass §4.2.8.5
- (S) Komprimerad massa



- (N) Bakkenivå
- (EN) Ground level
- (S) marknivå

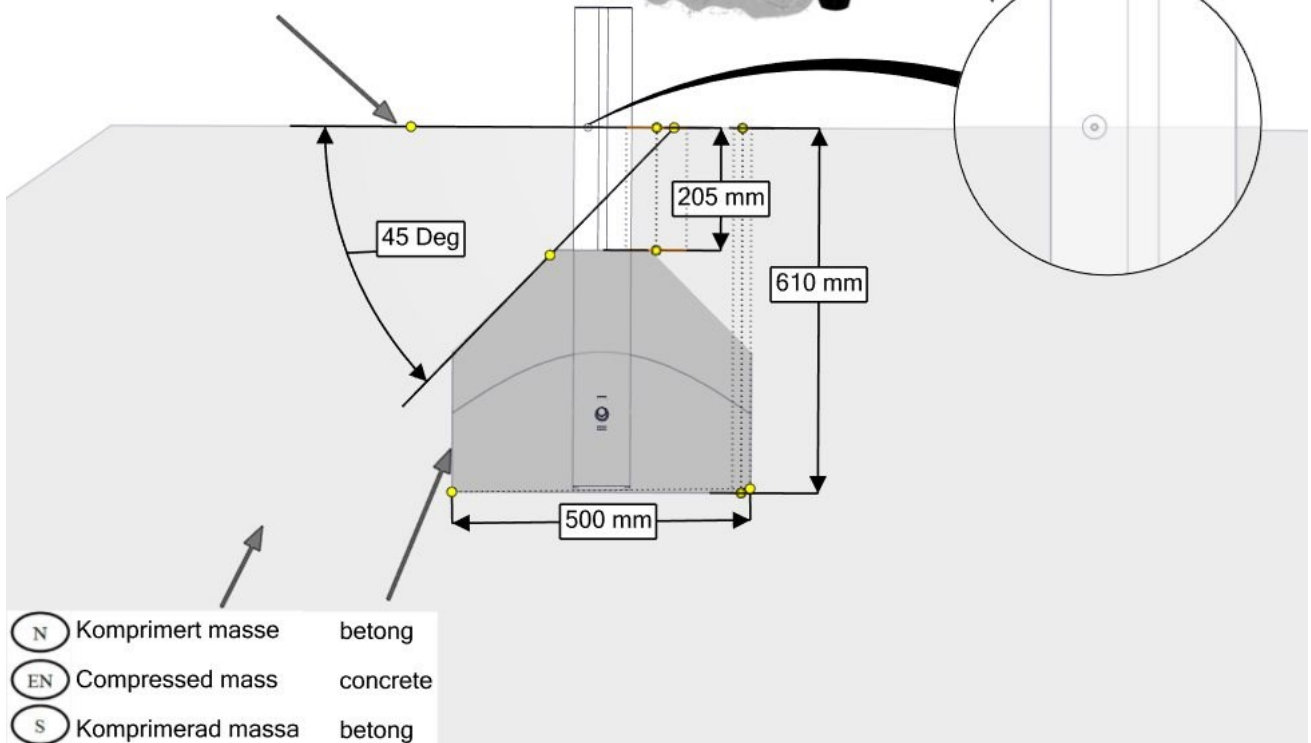

- (N) Komprimert masse betong
- (EN) Compressed mass concrete
- (S) Komprimerad massa betong

**Fundamentering uten betong // Foundation without concrete // Förankring utan betong**

- (N) Støtdempende materialer Ref NS-EN 1176-1
- (EN) Impact attenuating materials §4.2.8.5
- (S) Støtdämpande material

- (N) Bakkenivå
- (EN) Ground level
- (S) Marknivå

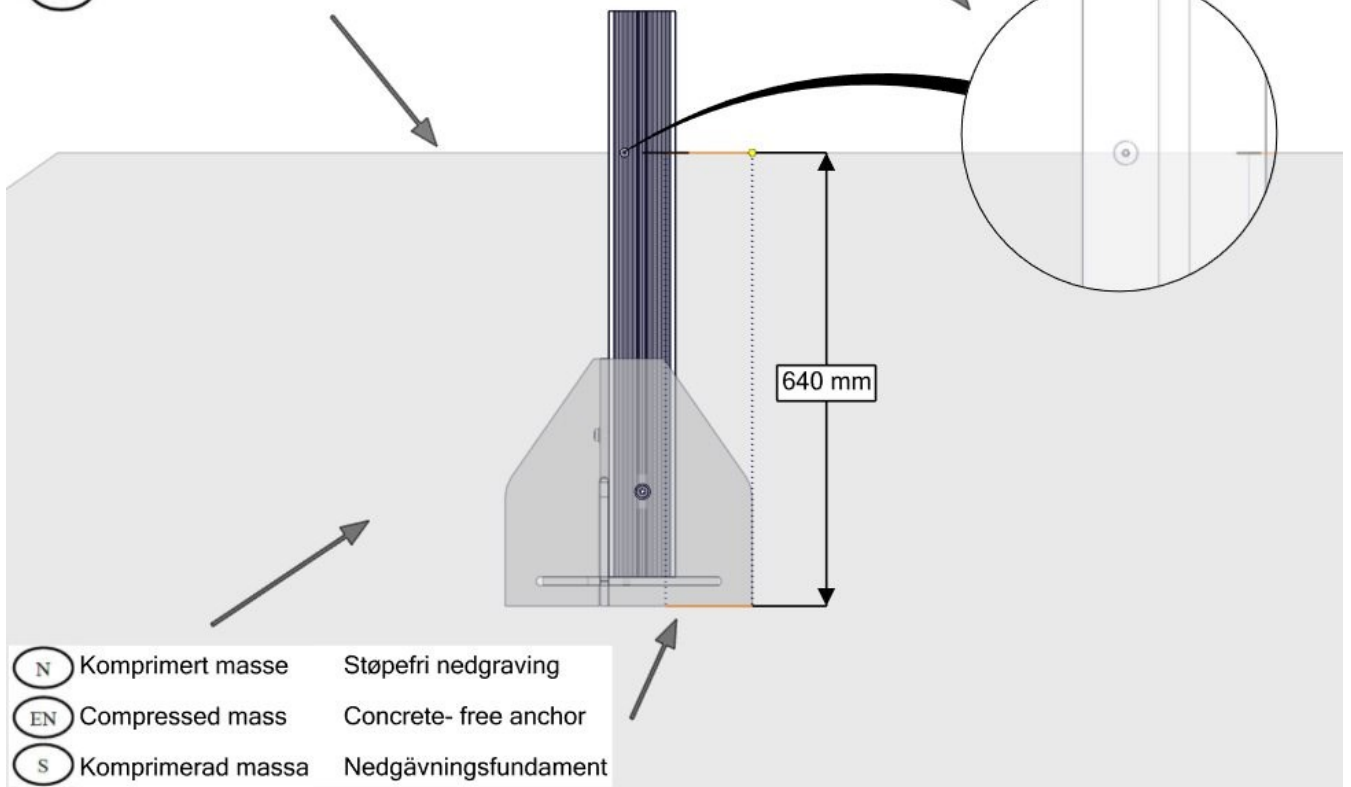

- (N) Komprimert masse Støpefri nedgraving
- (EN) Compressed mass Concrete-free anchor
- (S) Komprimerad massa Nedgävningsfundament

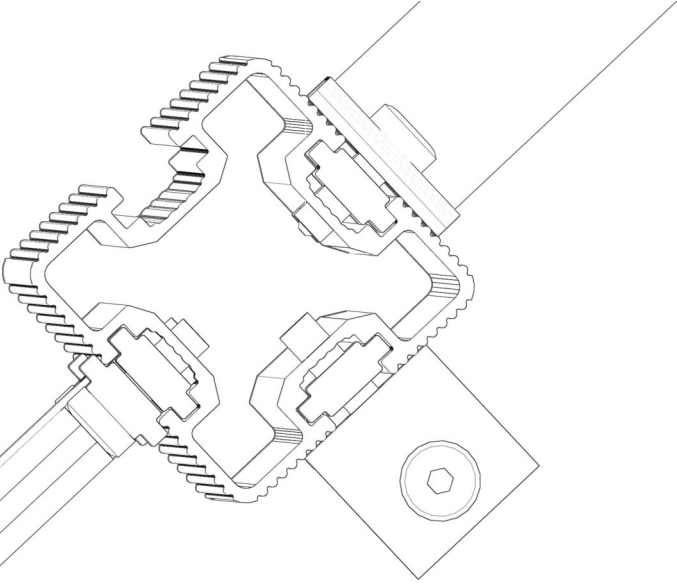
<p>(N) Bolten skrues HELT igjennom aluminiumen. Maks moment: 30Nm</p> <p>(EN) The bolt must be tightened in to the post, so that it peirces the aluminium Max torque: 30Nm</p> <p>(S) Bulten skuvas HELT genom aluminiumen. Maks vridmoment: 30Nm</p>					
NO		Betongkvalitet			
SE		Betongkvalitet	C25/30		
EN		Concrete quality			
NO		Mengde betong			
SE		Mängd betong		0,6	m <sup>3</sup>
EN		Amount of concrete			
NO		Fundament størrelse			
SE		Stiftelsestorlek		0,5 x 0,5 x 0,4	m
EN		Foundation size			
NO		For sikkerhet må fundamentene med sand eller myk jord være minst 50% større i areal			
SE		För säkerheten måste grunden med sand eller mjuk jord vara minst 50% större i området			
EN		For safety, the foundations with sand or soft soil must be at least 50% larger in area			
NO		Tyngste element			
SE		Tyngsta element	07-300-411	49,2	Kg
EN		Heaviest element			
NO		Største element			
SE		Största element	07-300-411 SFA5117/1	2,97x0,55x0,61 4,325x0,095x0,095	m
EN		Biggest element			

### Fallhøyder / Free height of fall / Fallhöjder

Fallhøyde = 2,7m

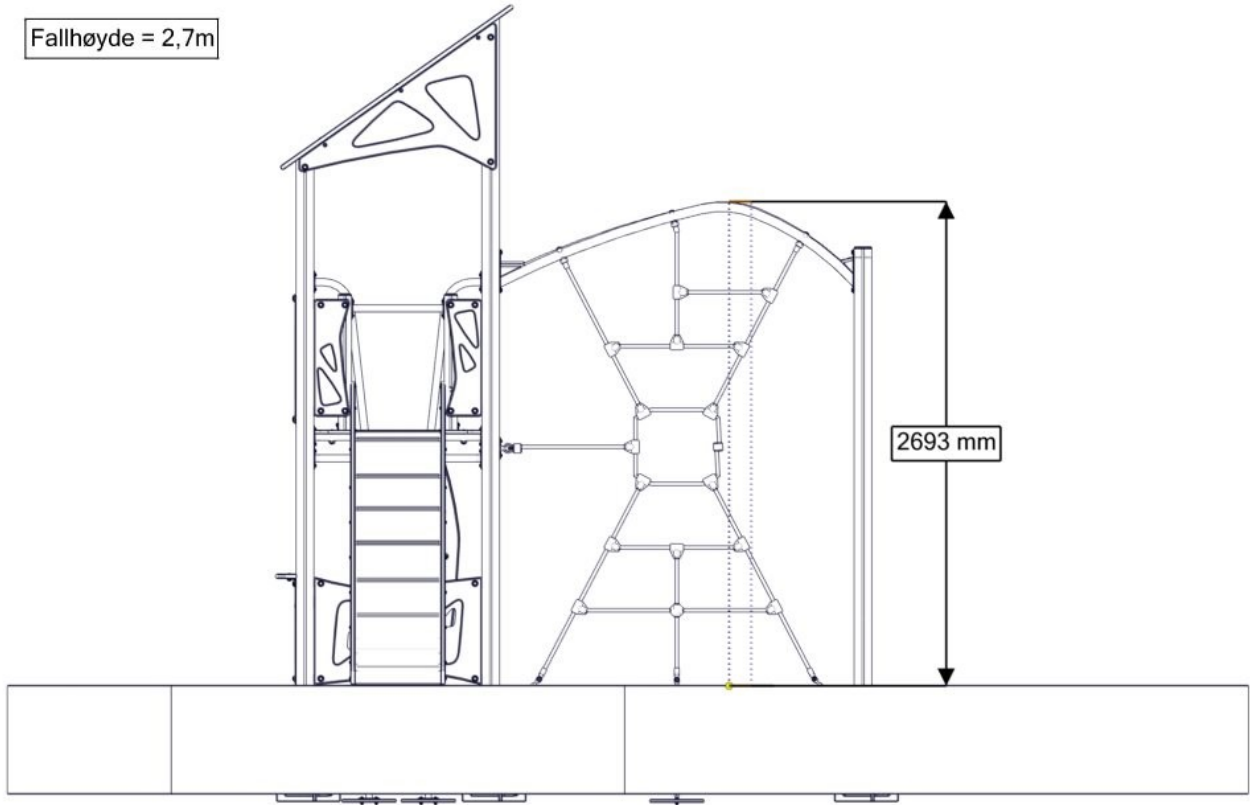

### Sikkerhetszone / Safety zone / Säkerhetszon

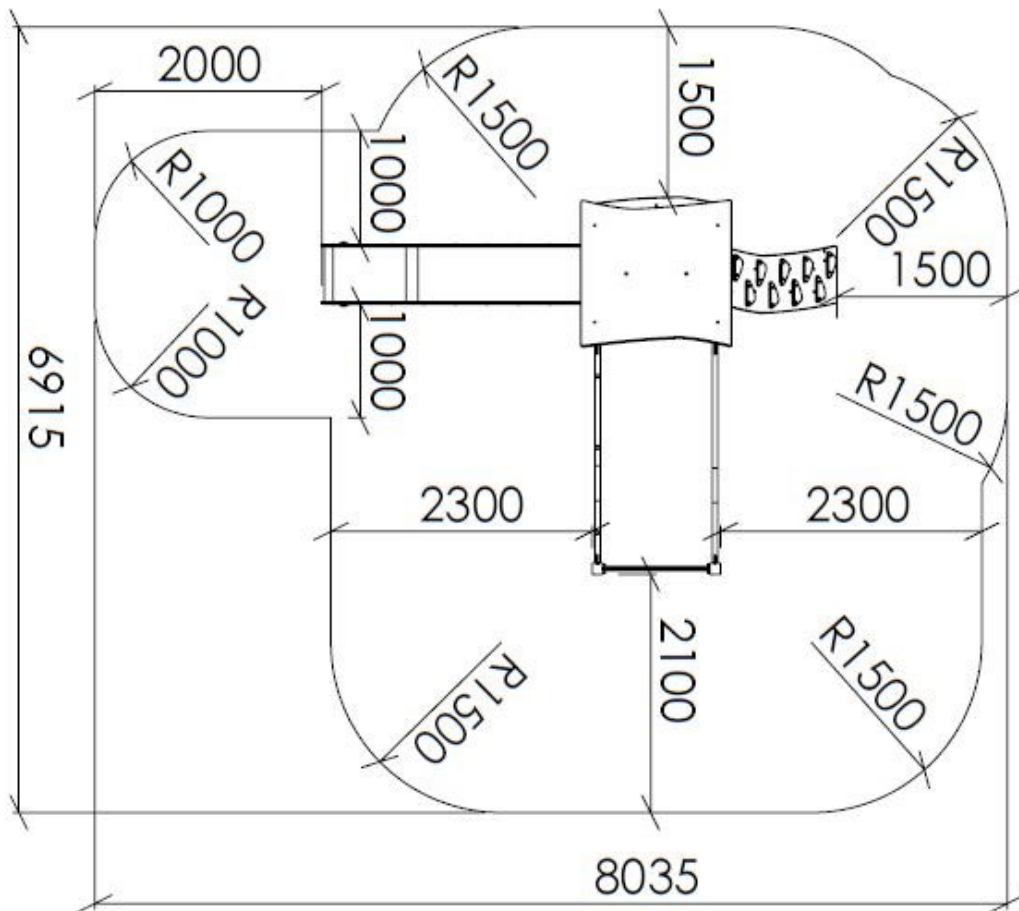

**Plassering av forankringer / Ground plan / Placering av förankringar**

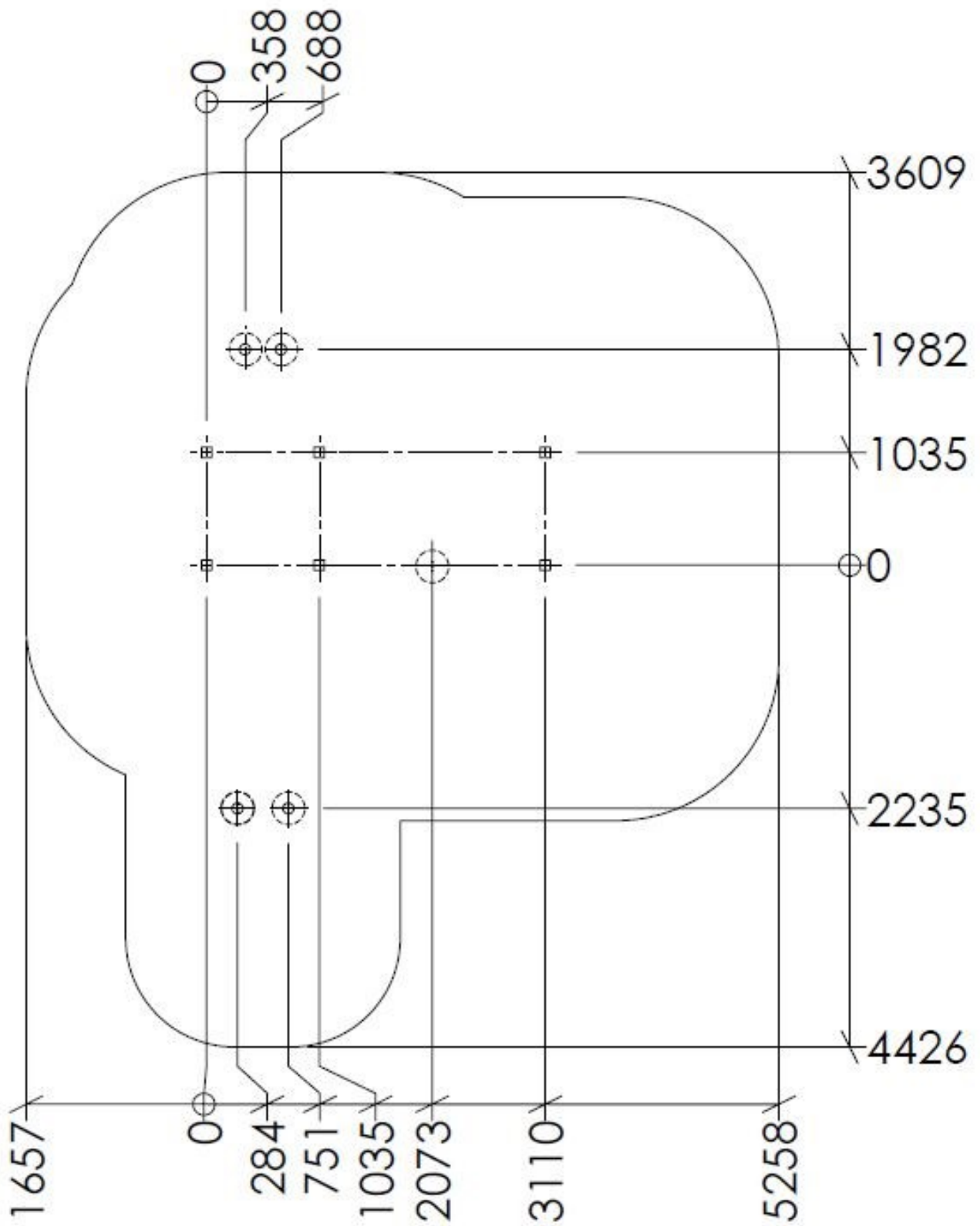

**Montering av lekeapparatet / Assembly instructions / Montering av lekredskapet**

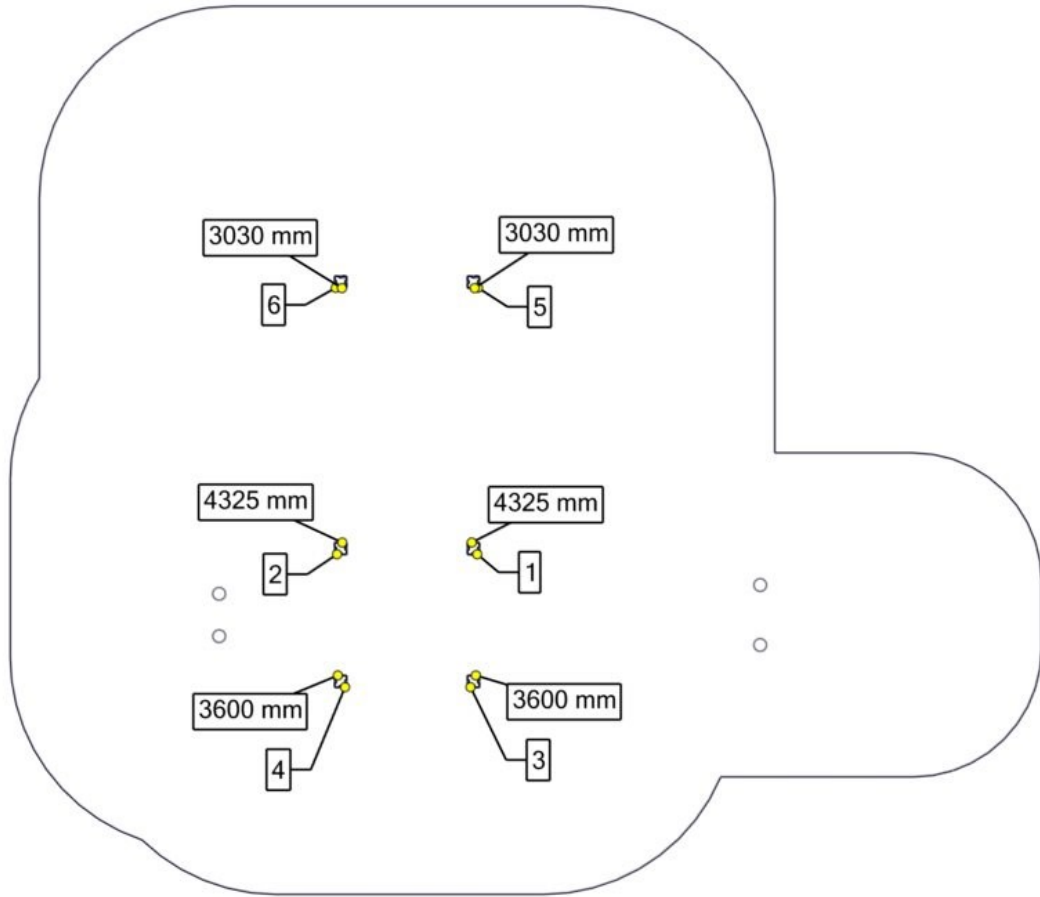

Se separat delmontering for detaljer  
 See separate assembly for details  
 Se separata delmontering för detaljer

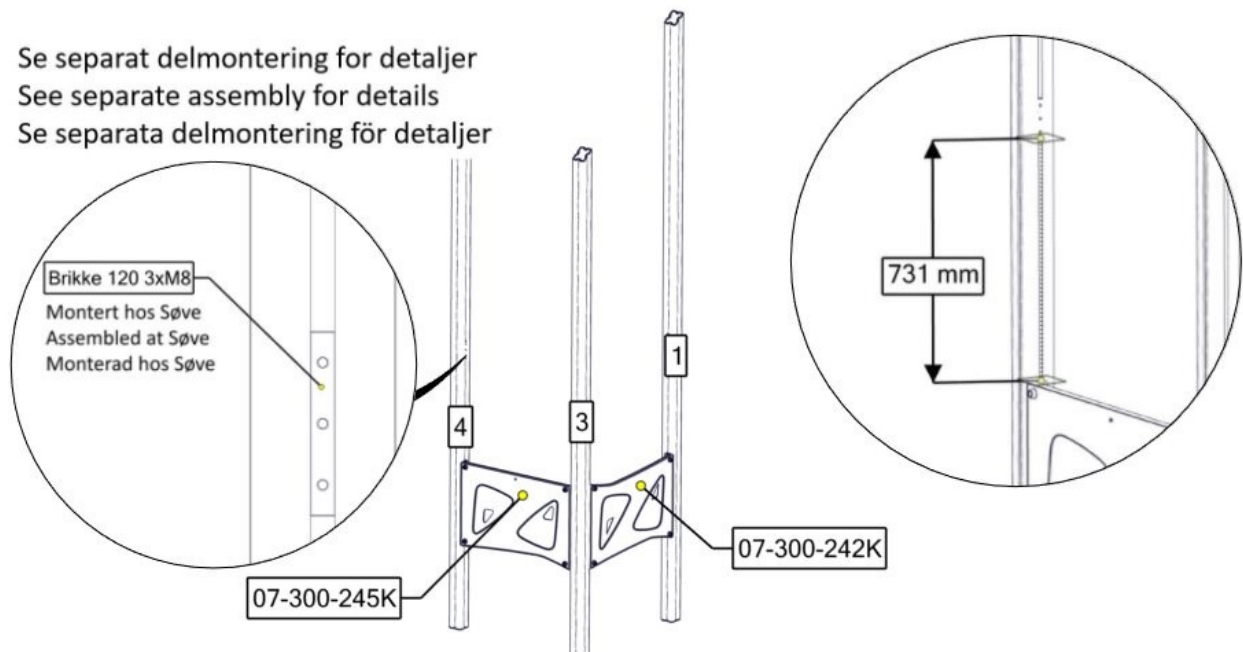

Part Name	Article nr.	Qty
Rekkverk 600x940x19	07-300-242K	1
Rekkverk 600x940x19 butikdisk	07-300-245K	1
Stolpe 95x95 Skrå L=3600	SFA5117/1	1
Stolpe 95x95 Skrå L=3600	SFA5117/1	1
Stolpe 95x95 Skrå L=4325	SFA5117/1	1

## Montering av lekeapparatet / Assembly instructions / Montering av lekredskapet

Se separat delmontering for detaljer  
 See separate assembly for details  
 Se separata delmontering för detaljer

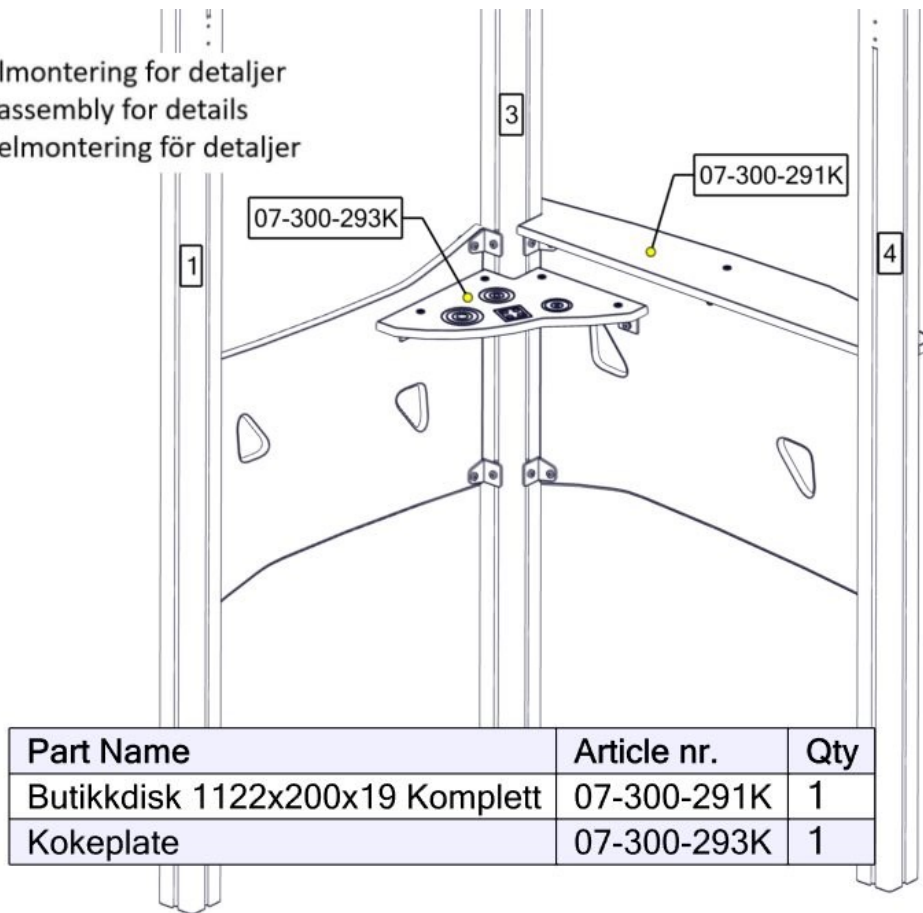

Se separat delmontering for detaljer  
 See separate assembly for details  
 Se separata delmontering för detaljer

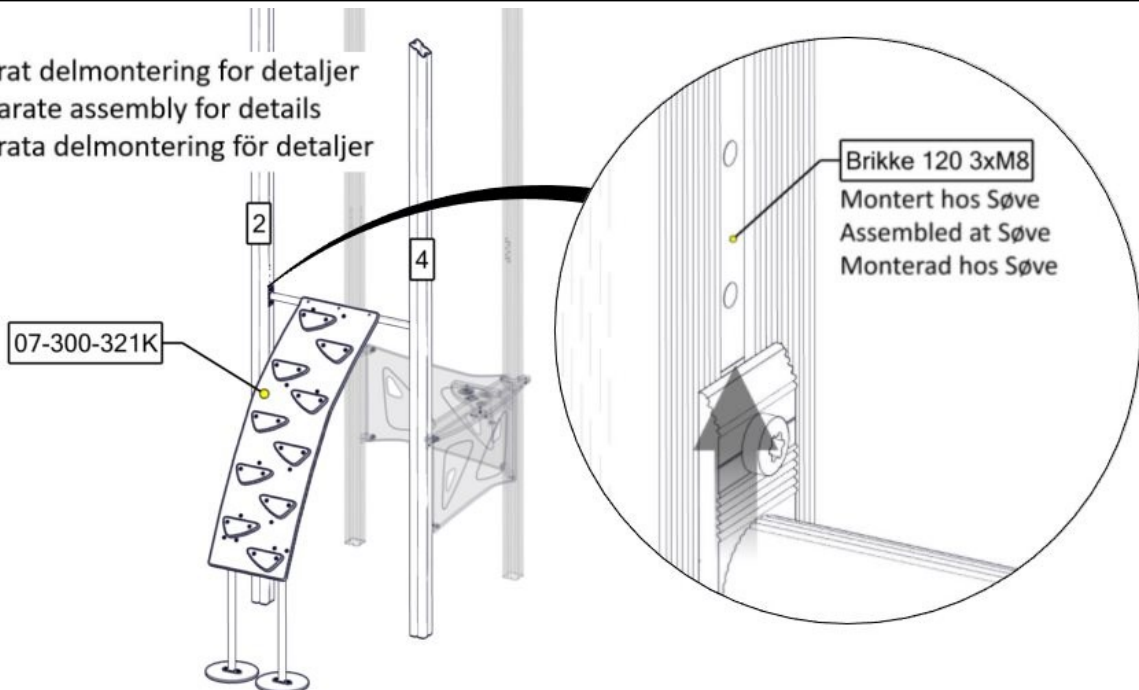

Part Name	Article nr.	Qty
Opptreksplate	07-300-321K	1
Stolpe 95x95 Skrå L=4325	SFA5117/1	1



## Montering av lekeapparatet / Assembly instructions / Montering av lekredskapet

Se separat delmontering for detaljer  
 See separate assembly for details  
 Se separata delmontering för detaljer

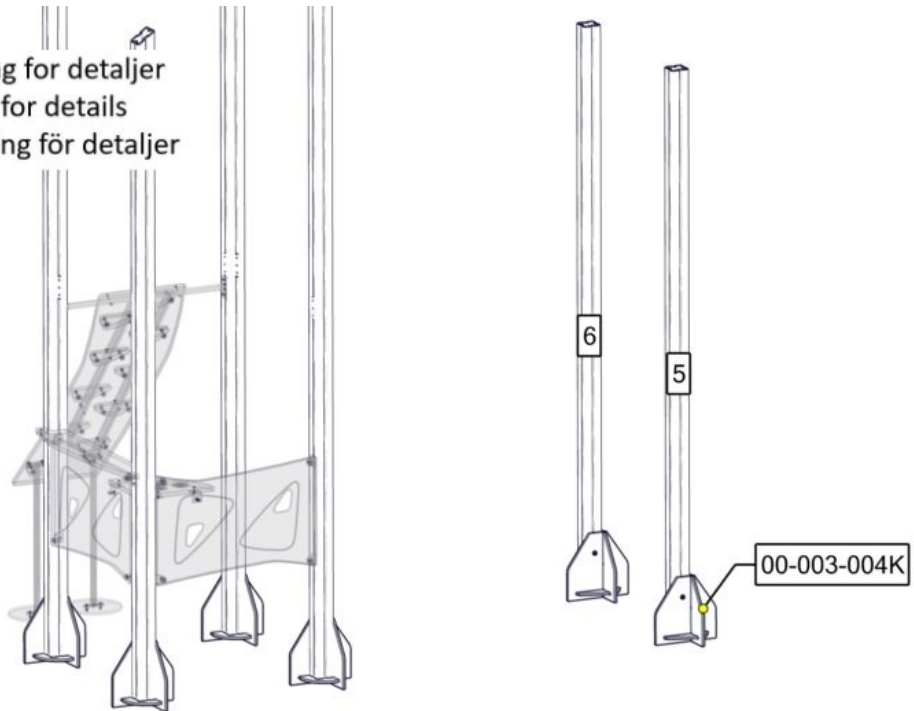

Part Name	Article nr.	Qty
Nedgravingsfundament 95x95	00-003-004K	6
Stolpe 95x95 L=3035	SFA5117/1	2

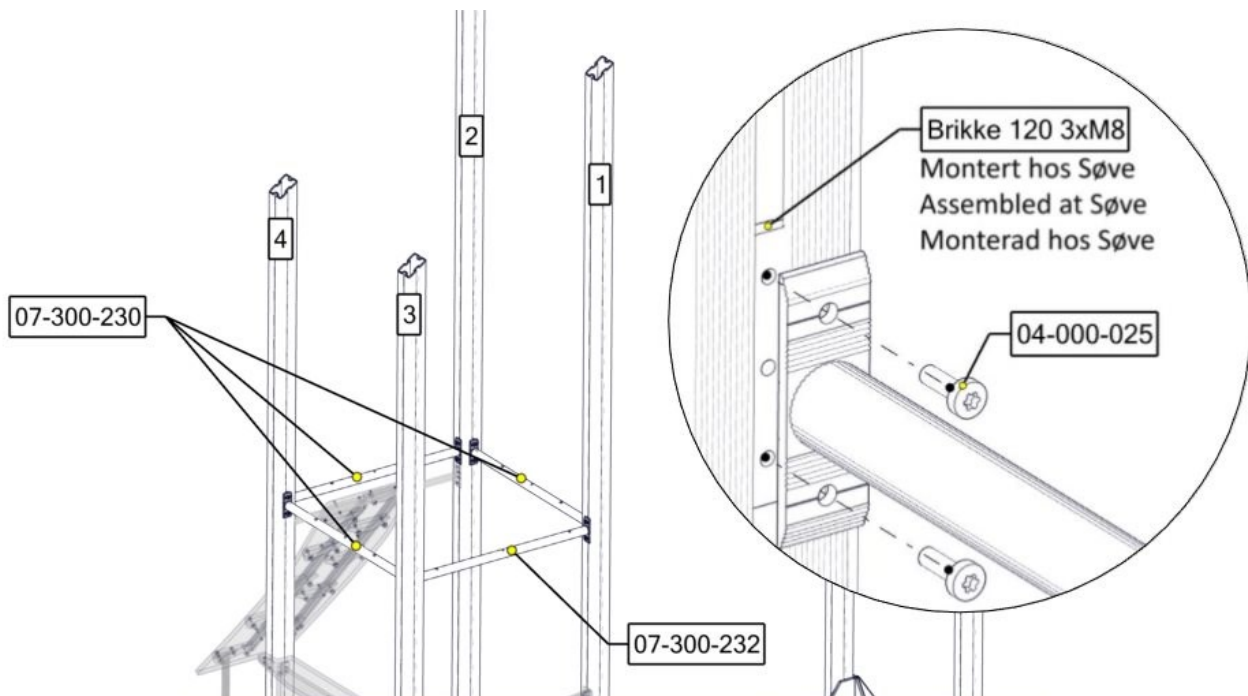

Part Name	Article nr.	Qty
Torx M8x25	04-000-025	16
Sperrerør gulv 2 hull cc735 for portal	07-300-232	1
Sperrerør gulv 2 hullcc 470	07-300-230	3

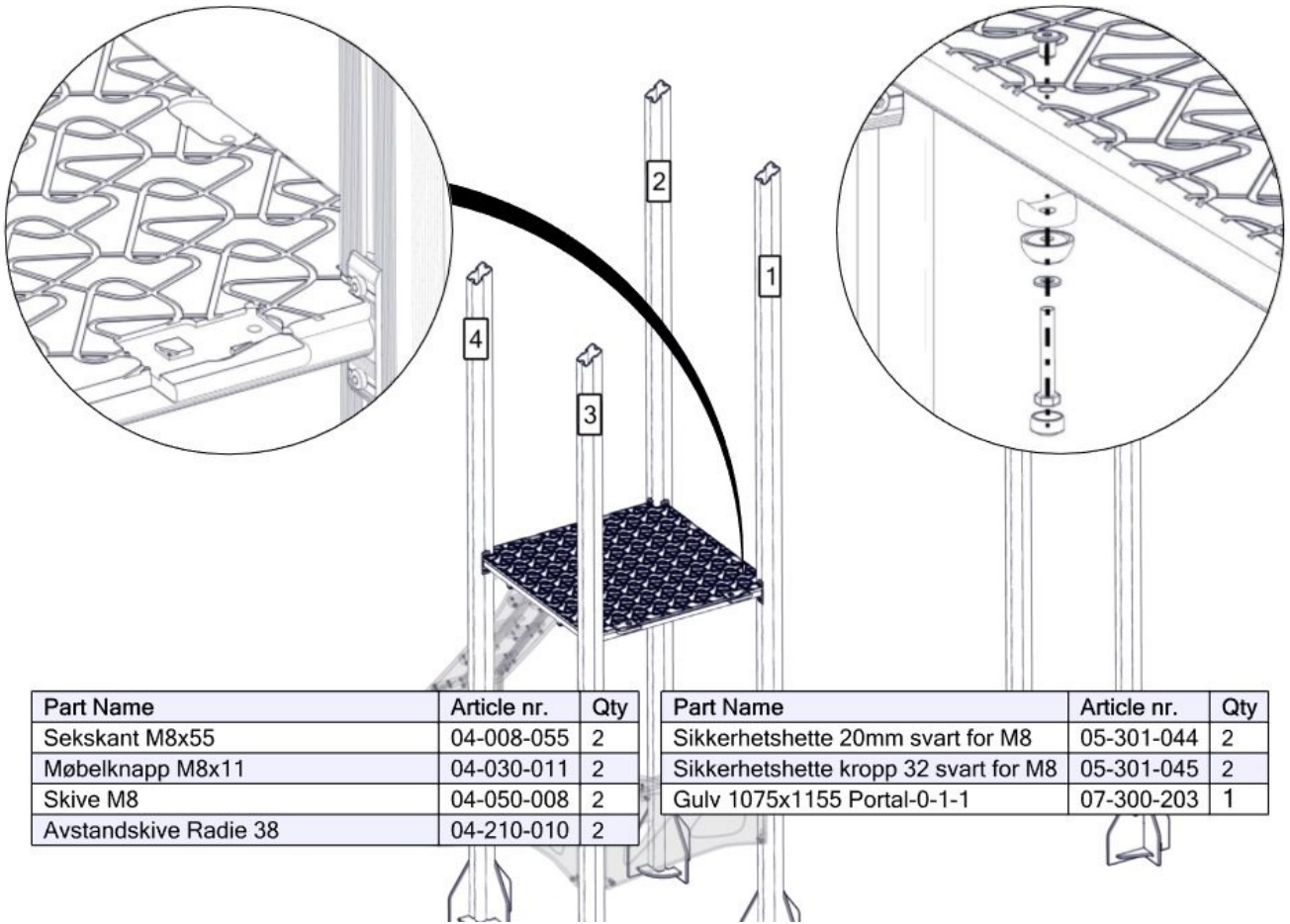

Part Name	Article nr.	Qty
Sekskant M8x55	04-008-055	2
Møbelknapp M8x11	04-030-011	2
Skive M8	04-050-008	2
Avstandskive Radie 38	04-210-010	2

Part Name	Article nr.	Qty
Sikkerhetslette 20mm svart for M8	05-301-044	2
Sikkerhetslette kropp 32 svart for M8	05-301-045	2
Gulv 1075x1155 Portal-0-1-1	07-300-203	1

Se separat delmontering for detaljer  
 See separate assembly for details  
 Se separata delmontering för detaljer

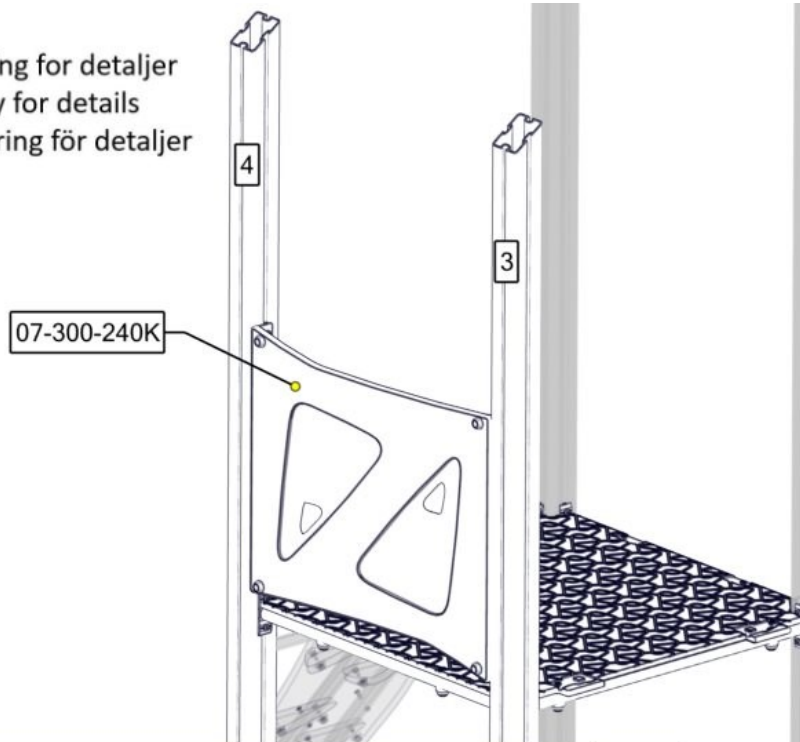

Part Name	Article nr.	Qty
Rekkverk 715x940x19	07-300-240K	1

## Montering av lekeapparatet / Assembly instructions / Montering av lekredskapet

Se separat delmontering for detaljer  
 See separate assembly for details  
 Se separata delmontering för detaljer

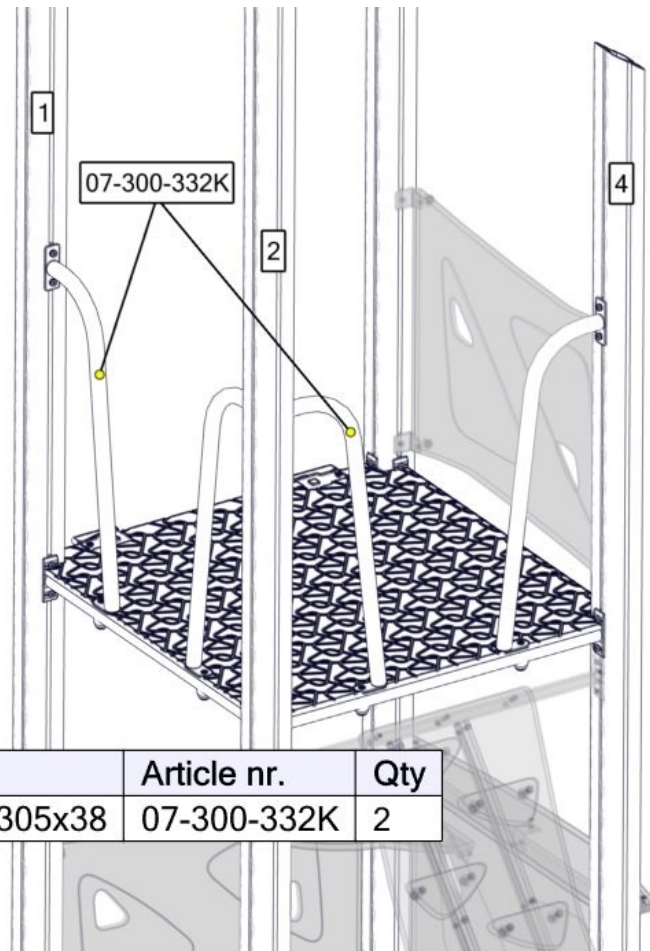

Part Name	Article nr.	Qty
Sluse 900x305x38	07-300-332K	2

Se separat delmontering for detaljer  
 See separate assembly for details  
 Se separata delmontering för detaljer

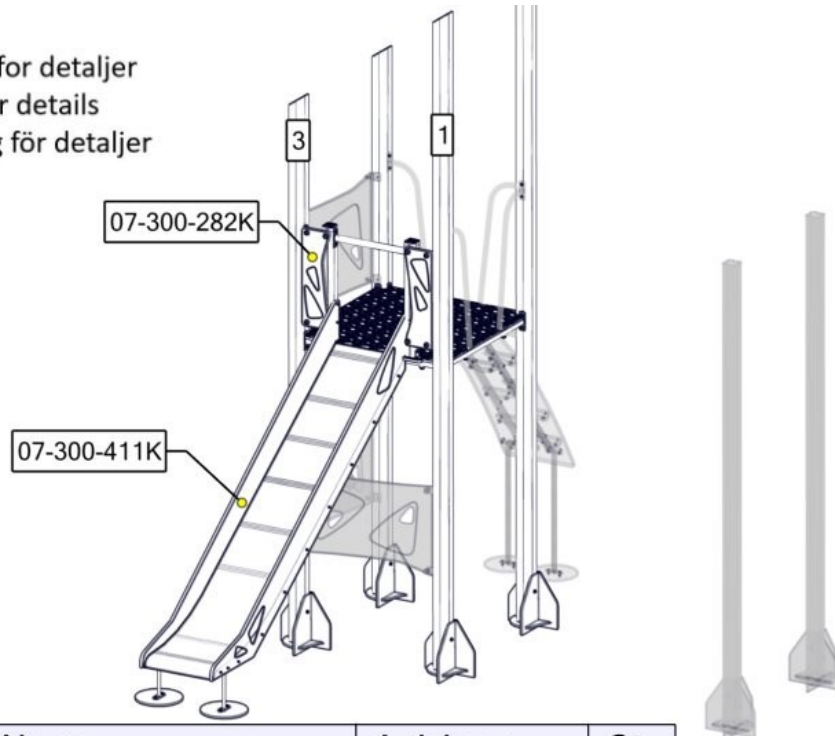

Part Name	Article nr.	Qty
Portal med sperre komplett	07-300-282K	1
Rutsjebane H1.4 komplett	07-300-411K	1

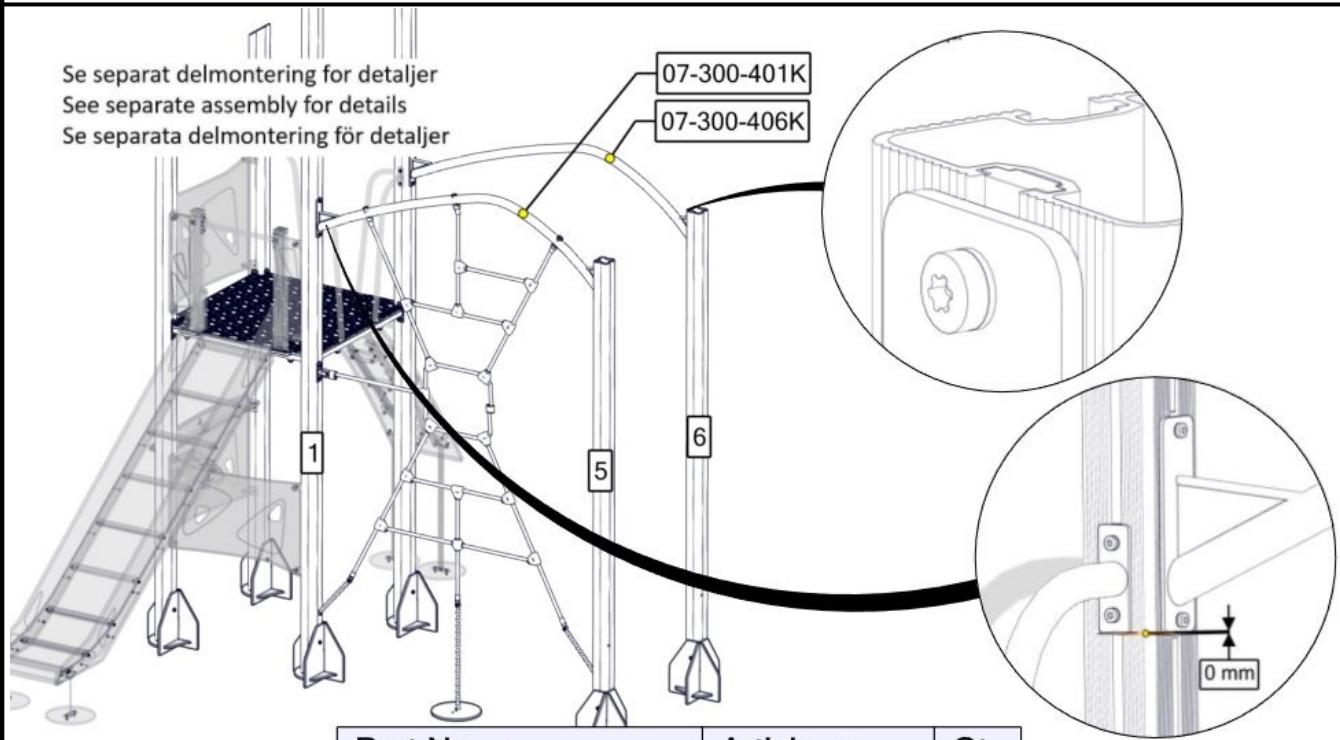

Part Name	Article nr.	Qty
Ederkoppnett med rør	07-300-401K	1
Rør uten hull komplett	07-300-406K	1

Se separat delmontering for detaljer  
See separate assembly for details  
Se separata delmontering för detaljer

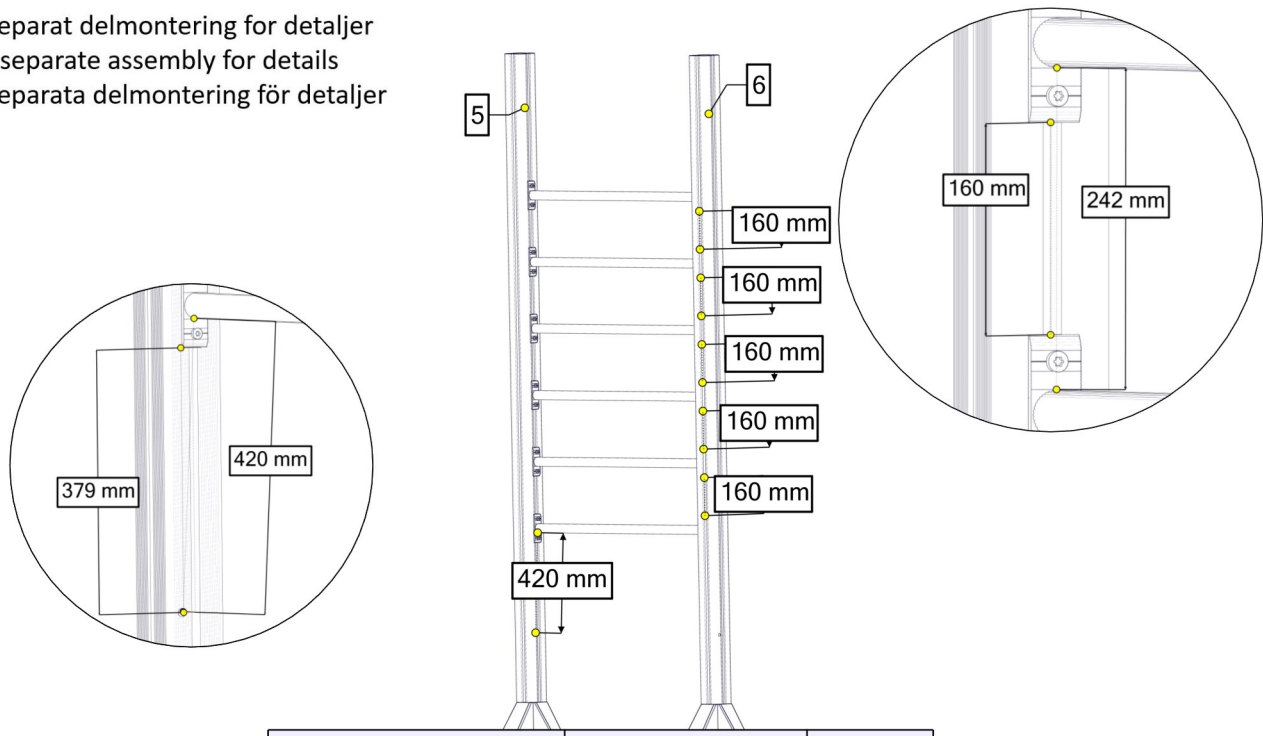

PartName	Artnr	Antall
Sperrør L=940	00-400-156K	6

Se separat delmontering for detaljer  
 See separate assembly for details  
 Se separata delmontering för detaljer

07-300-255K

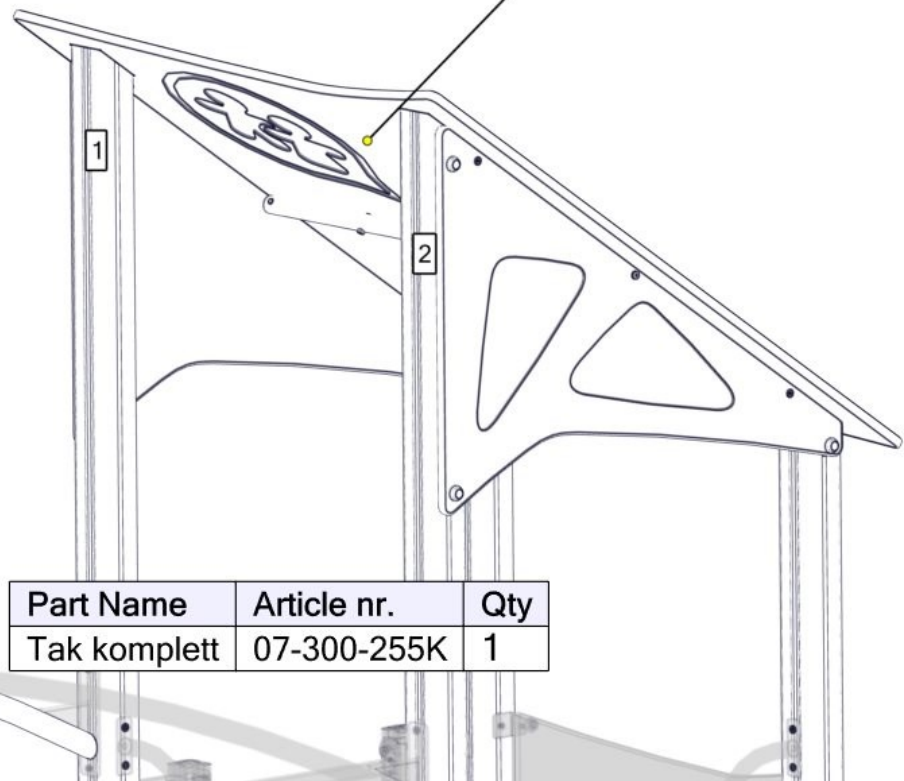

Part Name	Article nr.	Qty
Tak komplett	07-300-255K	1

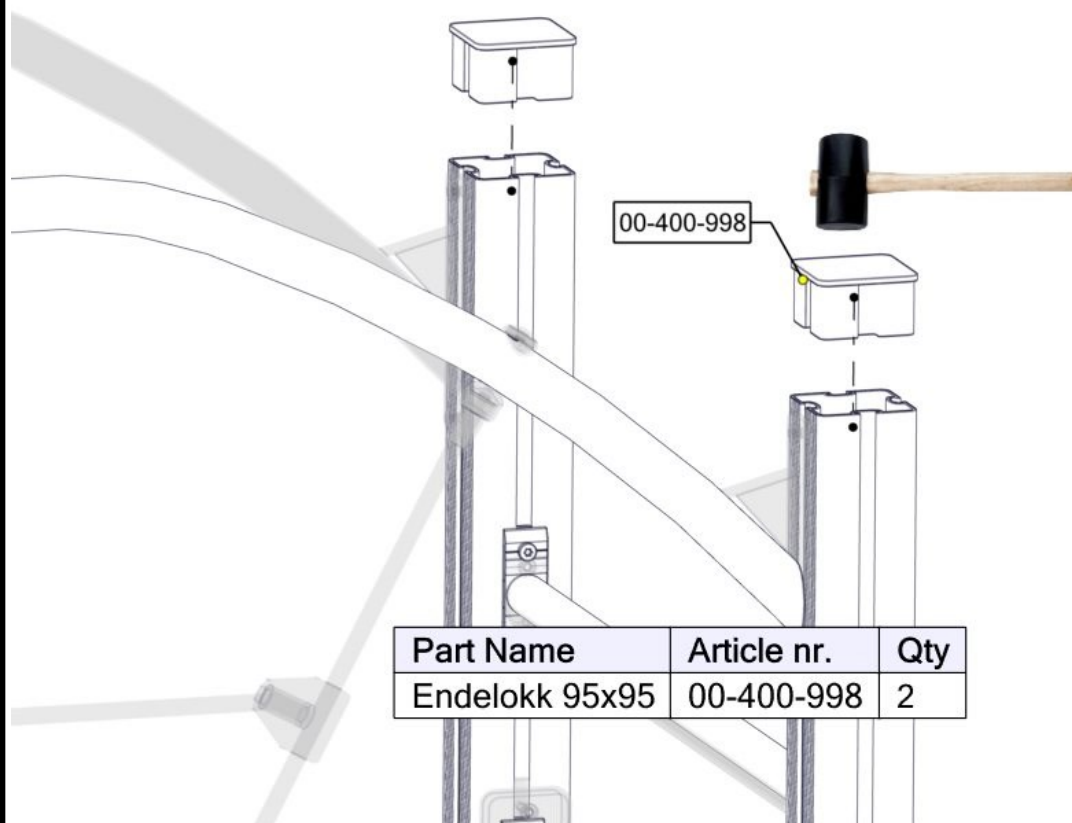



Part Name	Article nr.	Qty
Endelukk 95x95	00-400-998	2

<b>Før utstyret tas i bruk / Before play begins / Innan lekredskapet tas i bruk</b>	
<b>N</b>	<ul style="list-style-type: none"> <li>● Påse at fallunderlag er utlagt i henhold til gjeldende regler eller vår anbefaling</li> <li>● Fjern alle monteringshjelpemidler ( rester av betong, planker, paller, plast, og lignende)</li> <li>● Før utstyret tas i bruk, burde man sjekke at det ikke er fare for at anorakksnorer og lignende som kan hekte seg fast noen steder på lekeapparatet. (Vedlagte snor med dobbe (kneledd) kan brukes til å sjekke at dette er i orden. Se vedlagte veiledning for bruk av denne. Dette gjøres for å oppdage eventuelle feilmonteringer.?)</li> <li>● NB! Bør stå i 2-3 dager før bruk</li> </ul>
<b>EN</b>	<ul style="list-style-type: none"> <li>● Make sure the area and depth of safer surfacing are according to the current standard, or to the manufacturer's recommendation</li> <li>● Make sure all tools and surplus materials are removed before play begins</li> <li>● PS! When complete, allow 2-3 days for the concrete to set before use</li> </ul>
<b>S</b>	<ul style="list-style-type: none"> <li>● Kontrollera att fallunderlag är utlagt enligt gällande regler eller vårt rekommendation</li> <li>● Ta bort alla monteringshjälpmedel (rester av betong, plankor, pallar, plast och liknande)</li> <li>● Innan lekredskapet används, kontrollera att anoracksnoddar eller kläder/delar av kläder eller liknande inte kan fastna i några delar på redskapet. (Den bipackade "knävringen" kan man med fördel användas för denna kontroll.</li> <li>● Detta görs för att upptäcka eventuella felmonteringar.)</li> </ul>

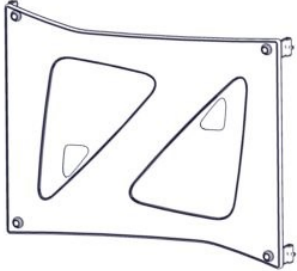
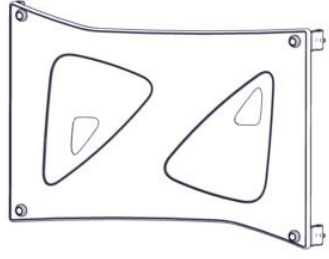
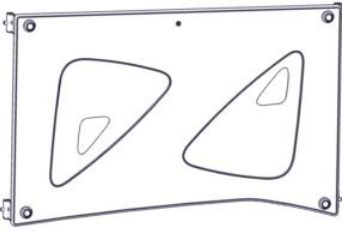
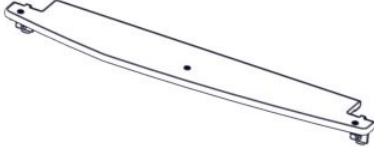

**Boltepakker for / Boltpackage for / Bultpaket för**

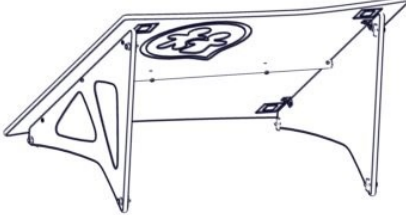
Sign. \_\_\_\_\_



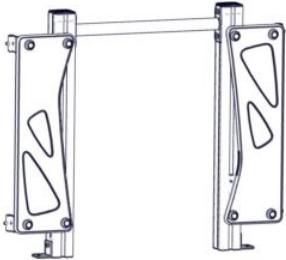
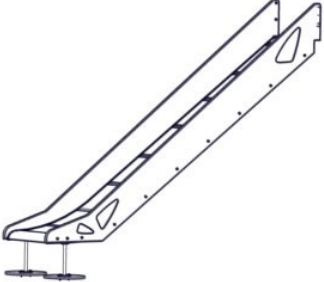

Saturn Thrymr 2 11-500-151	Navn	Artnr/ dimensjon	Ant	Lev
	Rekkverk Oransje 715x940x19	07-300-240K (se egen del- montering)	1	
	Rekkverk Oransje 600x940x19	07-300-242K (se egen del- montering)	1	
	Rekkverk Butikkdisk Oransje 600x940x19	07-300-245K (se egen del- montering)	1	
	Butikkdisk Oransje 1122x200x19	07-300-291K (se egen del- montering)	1	
	Kokeplate Oransje	07-300-293K (se egen del- montering)	1	
	Tak Oransje	07-300-255K (se egen del- montering)	1	

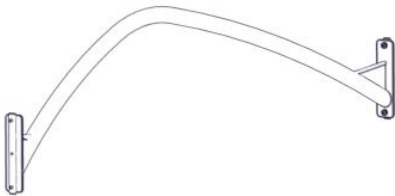
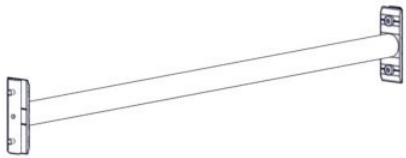
**Boltepakker for / Boltpackage for / Bultpaket för**

Sign. \_\_\_\_\_

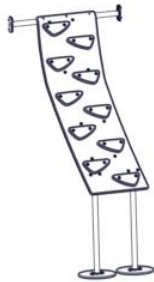

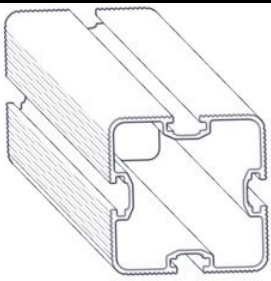
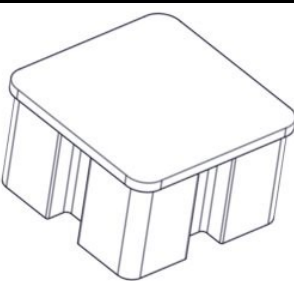
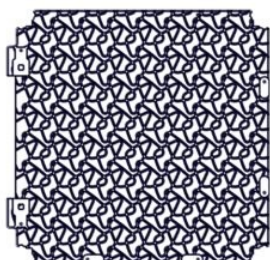

Saturn Thrymr 2 11-500-151	Navn	Artnr/ dimensjon	Ant	Lev
	Portal med sperrerør Oransje	07-300-282K (se egen del- montering)	1	
	Rutsjebane Oransje / Lilla H=1,4m	07-300-411K (se egen del- montering)	1	
	Edderkoppnett + rør Oransje	07-300-401K (se egen del- montering)	1	
	Rør uten hull Oransje	07-300-406K (se egen del- montering)	1	
	Sperrerør L=940 Uten hull Sort	00-400-156K (se egen del- montering)	6	

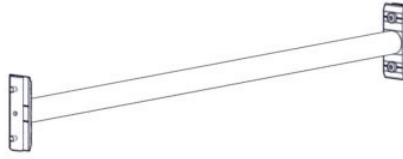
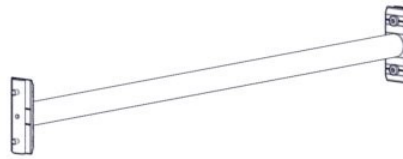

<b>Boltepakker for / Boltpackage for / Bultpaket för</b>		Sign. _____		
<b>Saturn Thrymr 2 11-500-151</b>	<b>Navn</b>	<b>Artnr/ dimensjon</b>	<b>Ant</b>	<b>Lev</b>
	Opptrekkplate Oransje	07-300-321K (se egen del- montering)	1	
	Sluse Lilla 900x305x38	07-300-332K (se egen del- montering)	2	
	Stolpe 95x95 L=3600 skrå Sort	SFA5117/1	2	
	Stolpe 95x95 L=4325 skrå Sort	SFA5117/1	2	
	Stolpe 95x95 L=3030 Sort	SFA5117/1	2	
	Endelokk 95x95	00-400-998	2	
	Gulv Portal-0-1-1 Grå 1075x1115	07-300-203	1	
	Produktmerke	00-100-400 (Montert hos Søve)	0	

**Boltepakker for / Boltpackage for / Bultpaket för**

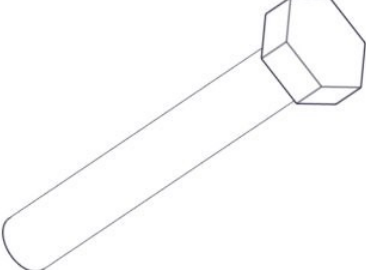

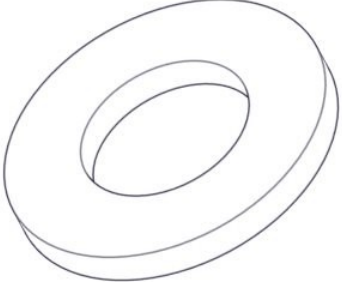
Sign. \_\_\_\_\_

Saturn Thrymr 2 11-500-151	Navn	Artnr/ dimensjon	Ant	Lev
	Sperrerør gulv Sort L=940 2 Hull cc470	07-300-230	3	
	Sperrerør gulv Sort L=940 2 Hull cc735 for portal	07-300-232	1	
	Torx Skrue M8x25	04-000-025	16	
	Sekskant skrue M8x55	04-008-055	8	
	Møbelknapp M8x11	04-030-011	8	
	Skive M8	04-050-008	8	

**Boltepakker for / Boltpackage for / Bultpaket för**

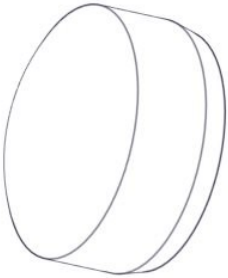
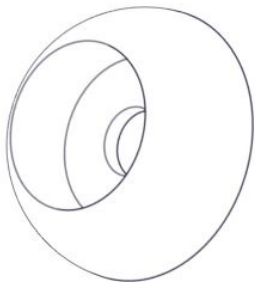
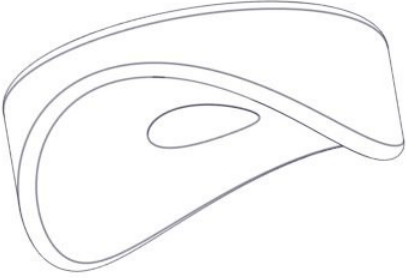
Sign. \_\_\_\_\_.

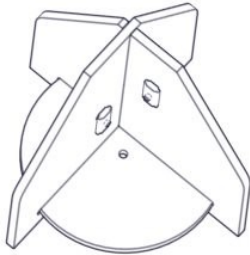
Saturn Thrymr 2 11-500-151	Navn	Artnr/ dimensjon	Ant	Lev
	Sikkerhetshette topp Sort 20mm for M8	05-301-044	8	
	Sikkerhetshette kropp Sort 32mm for M8	05-301-045	8	
	Avstandskive plast Sort Radie for 38mm	04-210-010	8	

<b>Boltepakker for / Boltpackage for / Bultpaket för</b>		Sign. _____.		
Saturn Thrymr 2 11-500-151	Navn	Artnr/ dimensjon	Ant	Lev
	<b>Fundament Nedgraving</b>			
	Nedgravingsfundament 95x95	00-003-004K (se egen del- montering)	6	
	<b>Fundament Støp</b>			
	Støpe fundament	00-003-110K (se egen del- montering)	6	

**Revisjon:**

03.08.2020

Oppdatert fundamentbilder

Endret art. nr for stolper til SFA5117/1

Oppdatert BOM

Lagt til tabell og oppdatert mål/vekt/betong

Oppdatert sikkerhetssone, areal og stolpeplassering

Oppdatert div view

Lagt til nummerering på stolper

14.08.2020 MTF

Oppdatert div view og BOM

12.07.2023 Endret ribbevegg med plast sider til 6 sperrør.  
(07-300-391 byttet ut til 6stk 00-400-156K