

**(N) Monteringsanvisning**

**(UK) Assembly Instructions**

**(S) Monteringsanvisning**

Produkt nr. / Product no. / Produkt nr.

**12-100-025**

Ordr. nr. \_\_\_\_\_

Dato. \_\_\_\_\_

Sign. \_\_\_\_\_



**Søve Lekemiljø AS**  
3830 Ulefoss - Norway  
Tlf: +47 35 94 65 65  
[www.sove.no](http://www.sove.no)



**Søve AB**  
412 50 Göteborg  
Phone: +46 (0)31 773 97 00  
[www.sove.se](http://www.sove.se)

08.11.2010

# 1

## Monteringstips / Assembly Advice / Monteringsstips

### N

- ▮ Les monteringsanvisningen nøye før montering.
  - ▮ Monter elementene i rekkefølgen som vist.
  - ▮ Boltene bør ikke skrues for hardt til før alt er montert, vatret og loddet. Skru så boltene til.
- NB! Ved bruk av drill, kan boltene ryke.
- ▮ På grunn av at solen kan gjøre rutsjeflaten veldig varm, bør rutsjebanens utløp vende mot nord-øst eller nord-vest.
  - ▮ Er lekeutstyret plassert i naturlige ferdselstraséer må området sikres mot spontan gjennomgang.
  - ▮ Innspringningshinder bør vurderes rundt lekeapparater hvor det er stor bevegelse, f.eks. ved huskestativ.
  - ▮ Det bør være fritt innsyn til lekeutstyr som er beregnet for barn under 3 år.

**NB! Under monteringsarbeidet må utstyr, som ikke er forankret forsvarlig i bakken, avstives slik at det ikke velte. Området må avstenges under oppsettelse av apparatene med sperrebånd eller lignende.**

### UK

- ▮ Read the instruction carefully before assembling the play unit.
  - ▮ Assemble the components in the sequence shown in these instructions.
  - ▮ Fixings must not be fully tightened during assembly. Before casting the foundations, the structure must be level and plumb, at which point all fixings are tightened.
- PS! If use of drill, the bolts may be wrecked.
- ▮ Avoid positioning the slide facing due south because of overheating – ideal positions are facing north-east or north-west.
  - ▮ Secure the construction-area to prevent people from walking through it.
  - ▮ Consider installing barriers around play-equipment which gives rise to a lot of activity – i.e. swings.
  - ▮ Ensure that clear vision is possible across the play area so that supervision is possible from any position, particularly where children under 3 years of age will be playing.

**NB! During assembly of the equipment, ensure that all structures are securely propped, especially when left overnight. Also ensure that equipment is supported whilst concrete foundations are setting and enclose the area securely to prevent access.**

▮ Läs monteringsanvisningen noga före montering.

▮ Montera delarna i den ordningen som anvisas

▮ Skruvarna bör inte skruvas för hårt tills allt är monterat, i våg och lodat.

**OBS!** Används elektrisk skruvdragare, kan bulten gå sönder. Hårdra därför manuellt!

▮ Solen kan göra att rutchbanan blir väldigt varm. Banans nedfart rekommenderas att vändas i norrlig riktning

▮ Om lekplatsen placeras vid en gångväg mm bör området säkras mot genomfart av gående och cyklister.

▮ Inspringningshinder bör placeras runt lekutrustning med stor rörelse, t ex, gungställning.

▮ Det bör vara fri insyn till lekutrustning beräknat till barn under 3 år.

**OBS! Under monteringsarbete bör utrustningen som inte ska förankras i marken, ställs så att den inte kan välta.**

**Området måste spärras när lekutrustningen byggs upp, med avspärrningsband eller liknande.**

2

Nødvendig verktøy / Tools required / Nödvändiga verktyg

N  
UK  
S

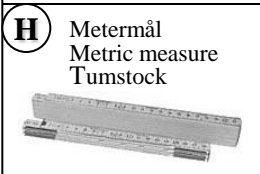
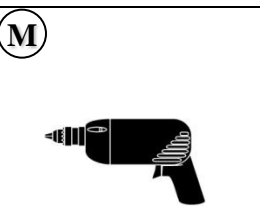
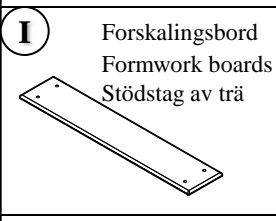
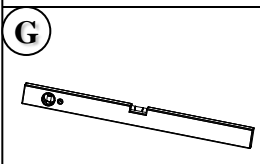
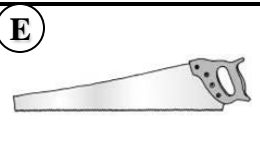
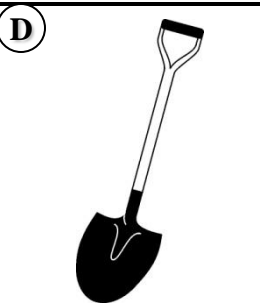
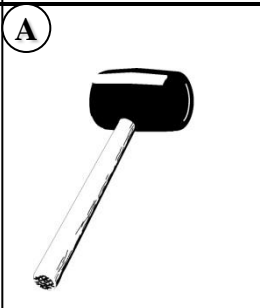

3

Nødvendig antall personer / Number of persons required / Lämpligt antal personer

N  
UK  
S

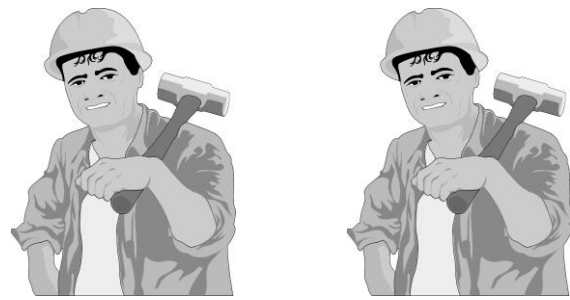

4





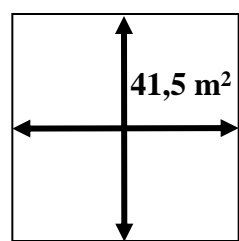

Anbefalt arealbehov ved montering / Recommended working space / Rekommenderad arealbehov vid montering

N  
UK  
S

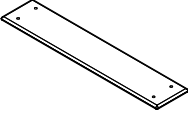
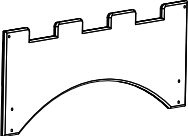
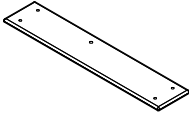
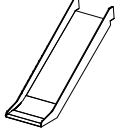
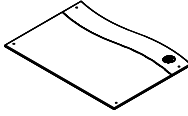

**5**
**Pakkliste for / Parts list for / Packlista för :**  
**12-100-025**

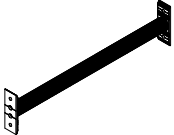

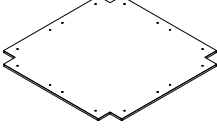
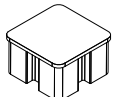





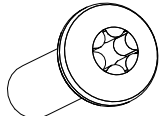

Sign. \_\_\_\_\_

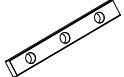
N UK S	Komponenter	Dimensjon	Ant	Lev	Komponenter	Dimensjon	Ant	Lev
	Components	Dimension	Qty	Lev	Components	Dimension	Qty	Lev
	Komponenter	Dimension	Ant	Lev	Komponenter	Dimension	Ant	Lev
	00-400-015 	3230 x 95 x 95 Med 2 brikker i hver stolpe	4		01-400-615 	1750 x 174 x 520	1	
	01-450-111 	710 x 145 x 15	3		01-450-502 	710 x 300 x 12	4	
	01-450-112 	710 x 145 x 15	1		40-142-101 	0,5m x 3 m	1	
	01-125-011 	688 x 638 x 12	2			00-400-980	4	
	00-450-155 	520 x 120 x 40	2					
	00-100-310 	512 x 120	4					
	00-450-305 	740 x 740 x 15	1					
	00-400-998 	55 x 95 x 95	4					
	00-400-997 Med hull		4					

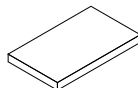









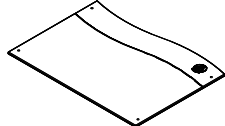

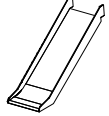



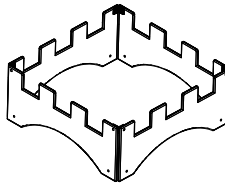

5

**Pakkliste for / Parts list for / Packlista för :  
12-100-025**

Sign. \_\_\_\_\_

	Bolter/skruer Bolts/Screws Komponenter	Dimensjon Dimension Dimension	Ant Qty Ant	Lev Lev Lev	Bolter/skruer Bolts/Screws Bultar/Skruvar	Dimensjon Dimension Dimension	Ant Qty Ant	Lev Lev Lev
		04-000-025 8 x 25 mm Torx 04-000-030 8 x 30 mm Torx 04-000-035 8 x 35 mm Torx	8 2 16		 Produkt merking Product marking Produkt märkning			1
	04-060-120 120 x 15 x 8 mm	4		 Avstandskloss Distance piece Distanskloss		89 mm	2	
	04-040-008 8 mm	2						
	04-075-050 50 x 50 x 5 mm	1				04-000-012 8 x 12 mm Torx	1	
	04-050-008 8 mm	2						
	04-090-002	7				04-030-016 8 x 16 mm	1	

**Boltepakker for / Boltpackage for / Bultpaket för 12-100-025**

01-125-011  Antall Number Antal	 04-060-040 40 x 15 x 8 mm	4 X 2	40-142-101  Antall Number Antal	 04-060-160 160 x 15 x 8 mm	2
	 04-000-035 8 x 35 mm Torx	4 X 2		 04-000-045 8 x 45 mm Torx 04-000-035 8 x 35 mm Torx	2 4
				 04-040-008 8 x 25 mm	2
01-400-615  Antall Number Antal	 04-060-040 050 x 15 x 8 mm	2	01-450-501  Antall Number Antal	 04-060-040 40 x 15 x 8 mm	8
	 04-000-025 8 x 25 mm Torx	2		 04-000-035 8 x 35 mm Torx	8
	 04-000-035 8 x 35 mm Torx	2		 04-000-025 8 x 25 mm Torx	8
	 04-030-016 8 x 16 mm	2		 04-040-008 8 mm	8
	 04-090-002	6		 04-076-050 50 x 50 x 5 mm	4

**5** Pakkliste for / Parts list for / Packlista för :  
12-100-025

Sign. \_\_\_\_\_

**Forankring / Foundations / Markförankring**

**00-003-003**

N Er bestilt       Ikke bestilt  
 UK In order       Not in order  
 S Beställt       Ej beställt

00-400-997

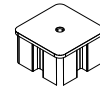

-4

00-003-100 00-003-101 00-003-102	4	04-000-035 8 x 35 mm Torx	12
		04-050-008 8 mm	12
		04-060-120 120 x 15 x 8 mm	8
00-003-103 	0	04-000-040 8 x 40 mm Torx	0
		04-040-008 8 mm	0
		04-050-008 8 mm	0
00-003-105  00-003-106 	4	04-010-035 10 x 35 mm	8
		04-040-010 10 mm	8
		04-050-010 10 mm	8

Eller  
Or  
Eller

**6****Fundamentering med betong / Foundation concrete / Förankring med betong**

(N) Bakkenivå (UK) Ground level (S) Marknivå

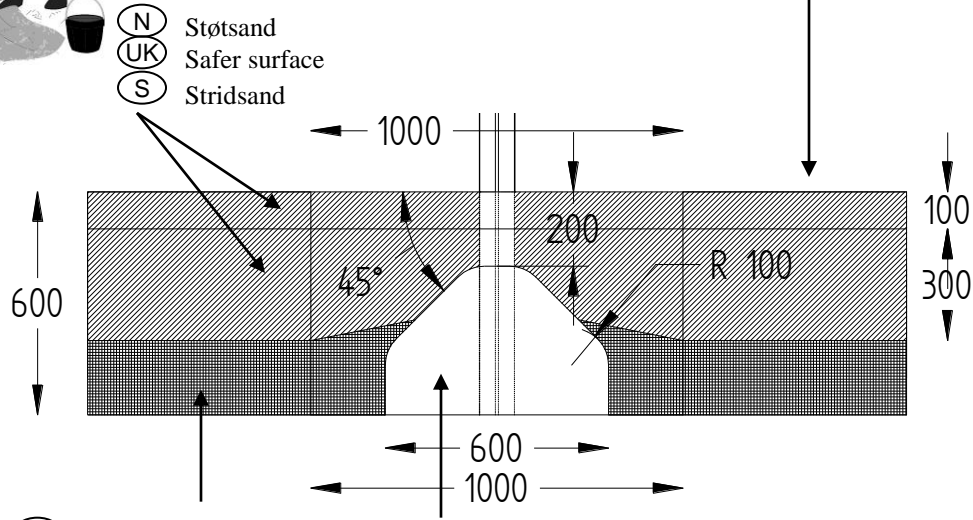

(N) Komprimert masse.      betong  
 (UK) Compressed mass.      concrete  
 (S) Komprimerad massa.      betong

**6****Fundamentering uten betong / Foundation without concrete / Förankring utan betong**

(N) Bakkenivå (UK) Ground level (S) Marknivå

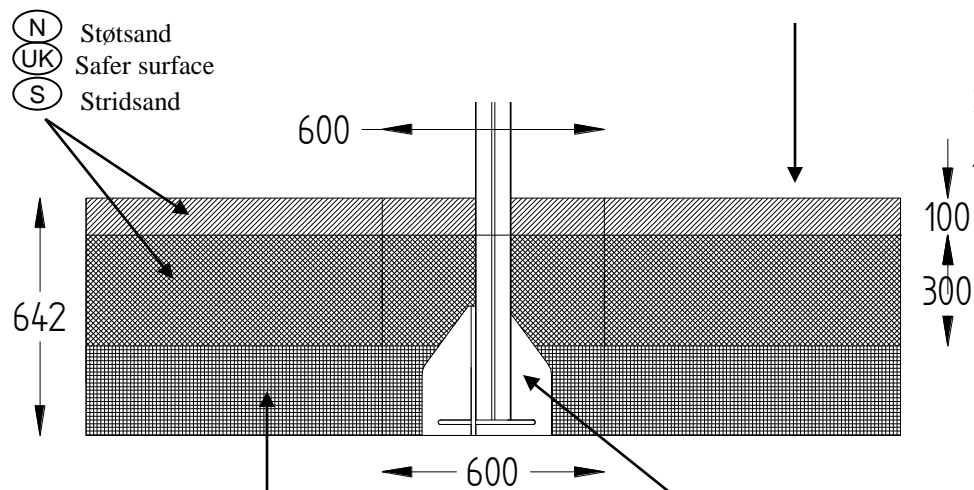

(N) Komprimert masse      Støpefri nedgraving  
 (UK) Compressed mass      Concrete-free anchor  
 (S) Komprimerad massa      Nedgravningsfundament

(N) Alle mål er oppgitt i millimeter  
 (UK) Scale measured in mm  
 (S) Alla mått är i millimeter.



- (N) For klatrenett
- (UK) For climbing net
- (S) För klätternät

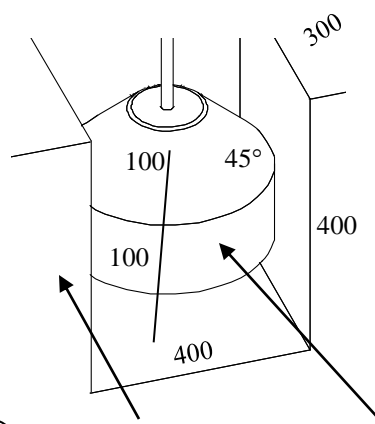

- (N) Komprimert masse. betong
- (UK) Compressed mass. concrete
- (S) Komprimerad massa. betong

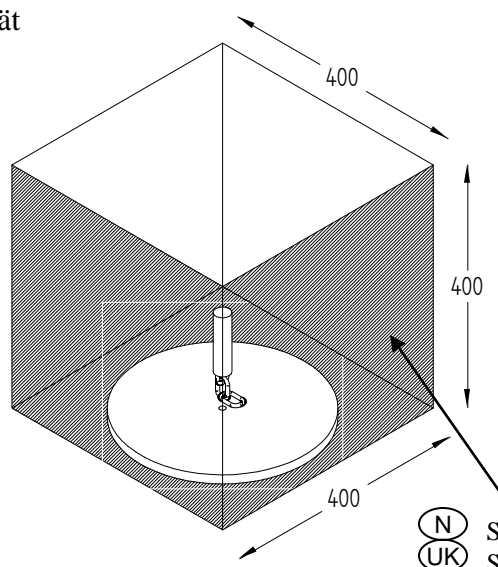

- (N) Støtsand
- (UK) Safer surface
- (S) Stridsand

- (N) Alle mål er oppgitt i millimeter
- (UK) Scale measured in mm
- (S) Alla mått är i millimeter.

6

(N) Dybde for støping og forankring

(UK) Depth of foundations /

(S) Djup för gjutning och markförankring

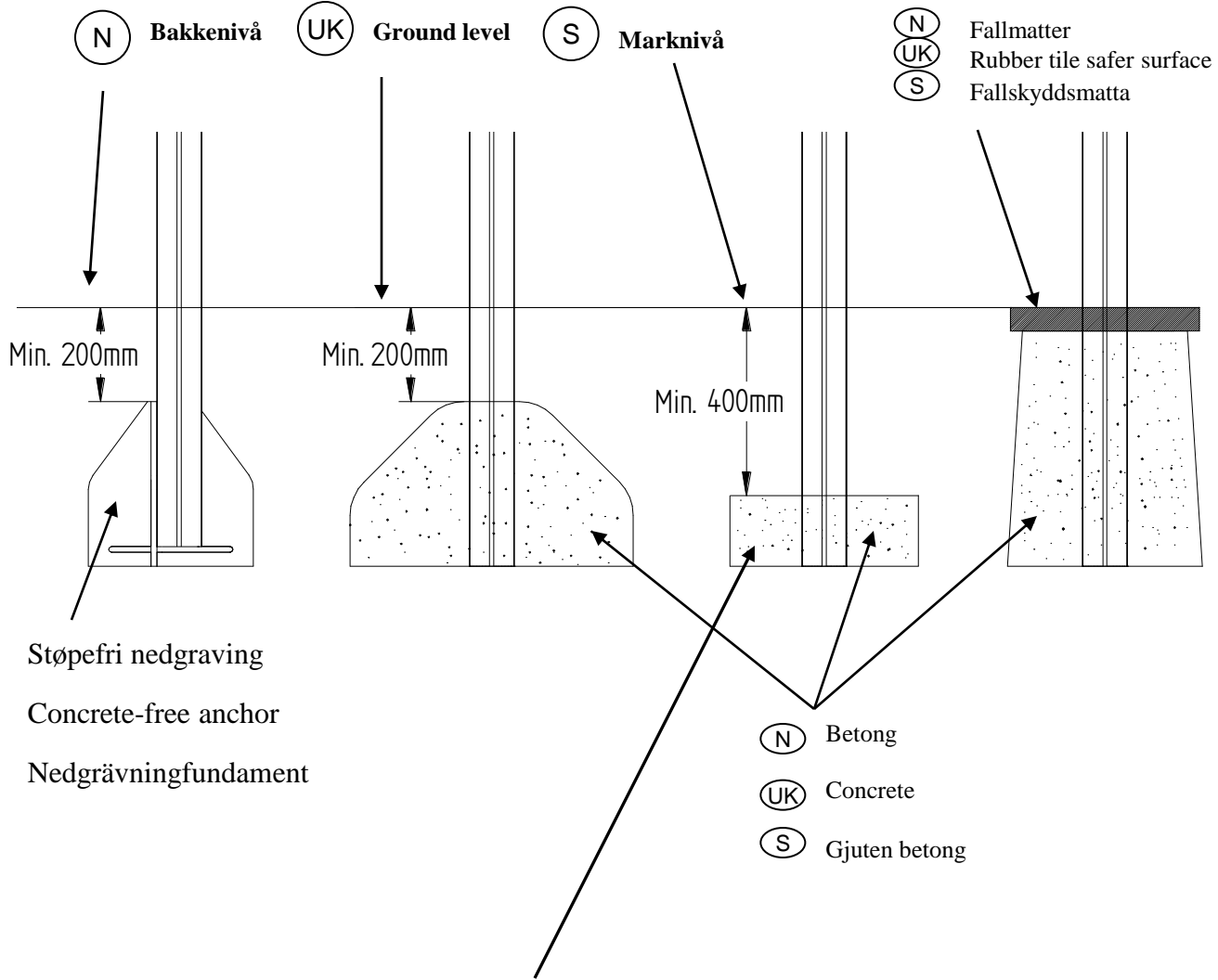

- (N) Støpefri nedgraving
- (UK) Concrete-free anchor
- (S) Nedgrävningfundament

- (N) Betong
- (UK) Concrete
- (S) Gjuten betong

(N) Denne støpemetoden anbefales ikke grunnet dårlig stabilitet av lekeapparatet.

(UK) This anchor is recommend not to use because of poor stability of the play unit.

(S) Denna förankring avrådes från att användas, därför att lekutrustningen får dålig fäste.

1

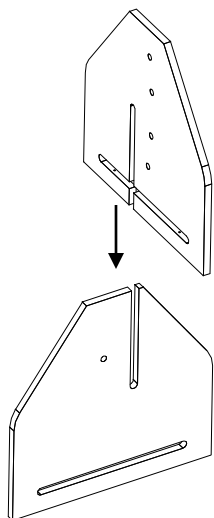

2

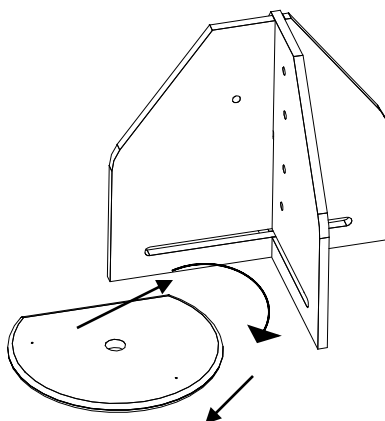

3

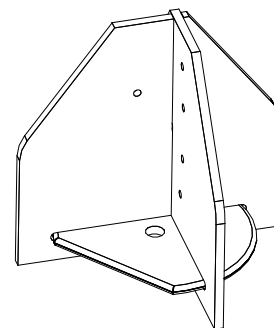

4

04-060-120 x 2  
120 x 15 x 8 mm

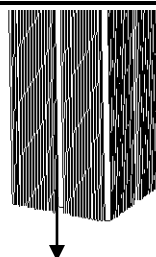

04-000-035 x 3  
8 x 35 mm Torx

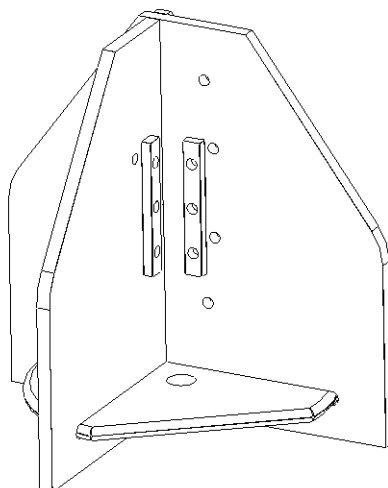

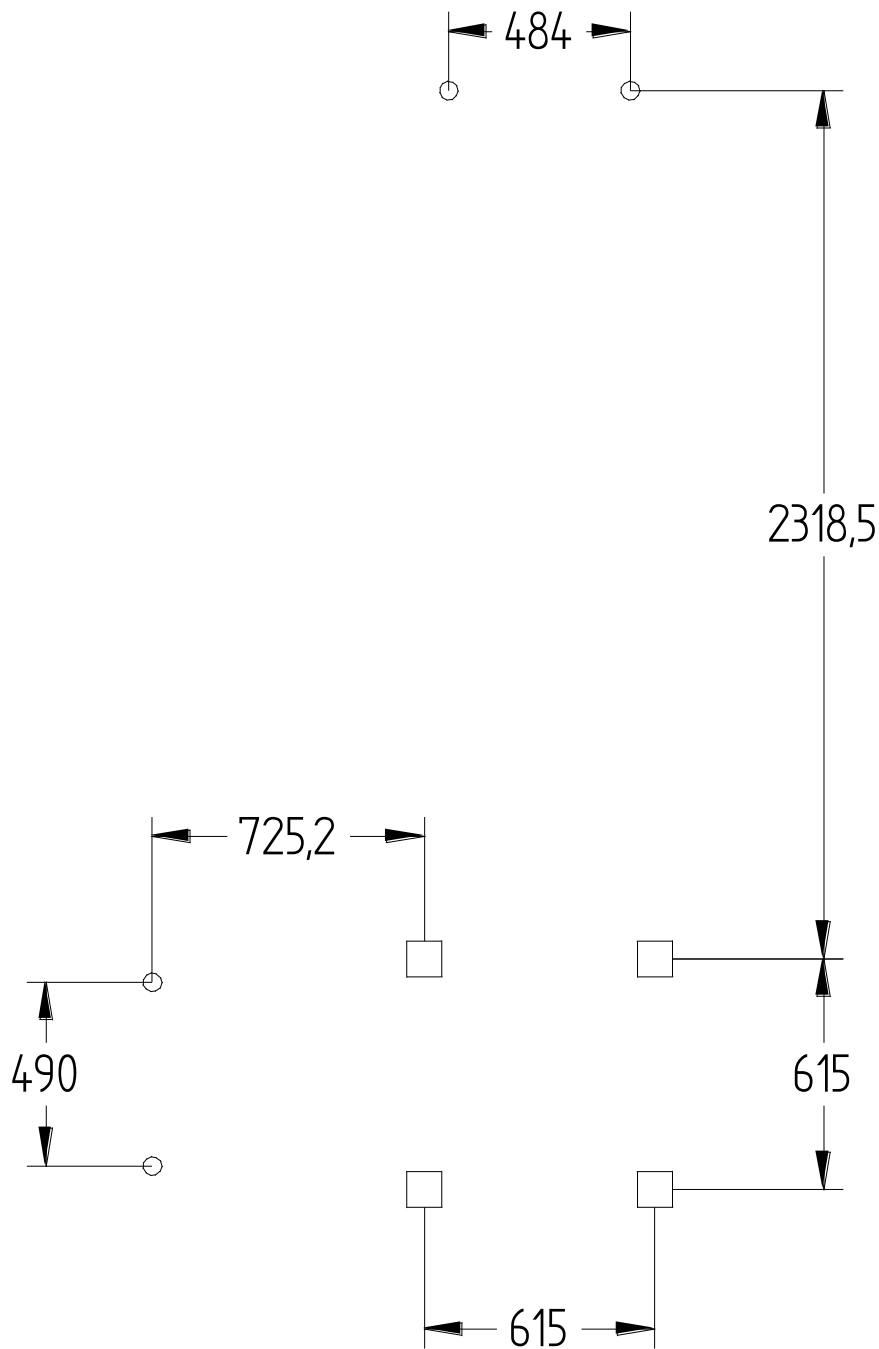

N

Alle mål er oppgitt i millimeter

UK

Scale measured in mm

S

Alla mått är i millimeter.

8

**Sikkerhetszone / Safty zone / Säkerhetszon**

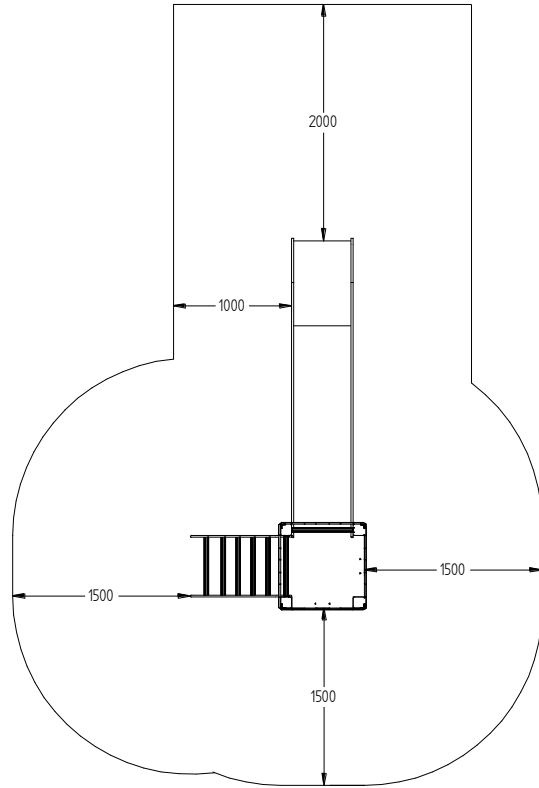

(N)

Alle mål er oppgitt i millimeter

(UK)

Scale measured in mm

(S)

Alla mått är i millimeter.

9

**Fallhøyder / Free height of fall / Fallhöjder**



(N)

Alle mål er oppgitt i millimeter

(UK)

Scale measured in mm

(S)

Alla mått är i millimeter.

**OBS !**

- Ⓝ Bolter skrues helt igjennom aluminiumstolpene. Om elektrisk drill brukes anbefales 18 V
- ⓊⓀ Bolts must be tightened through the post, so that it pierces the aluminium.
- Ⓢ Bultarna skruvas rakt igenom aluminiumstolparna. Om elektrisk skruvdragare används rekommenderas 18 V

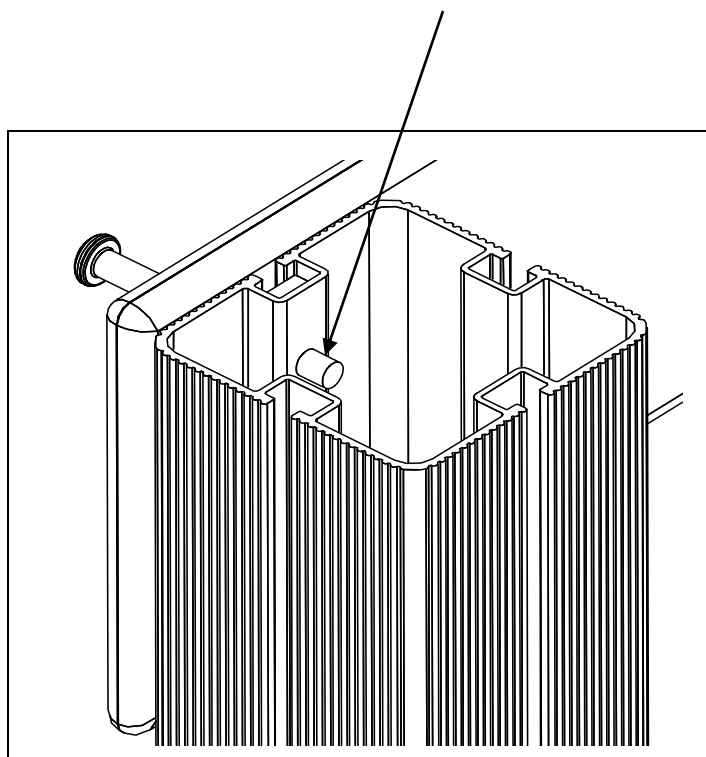

- (N) Med bruk av betong
- (UK) With use of concrete
- (S) Med bruk av betong

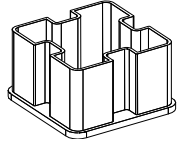
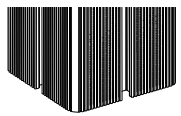

00-400-997

00-400-013 x 4

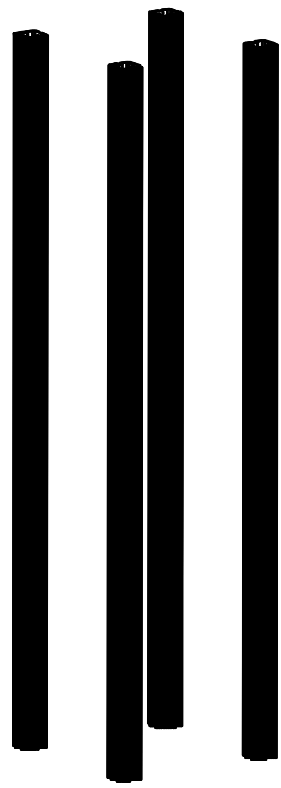

1

01-450-112

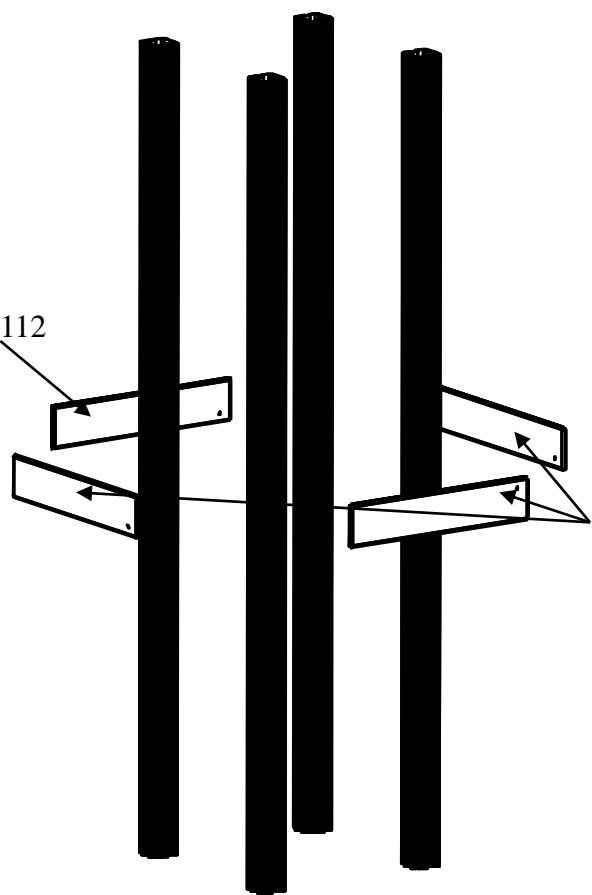

00-450-110 x 3

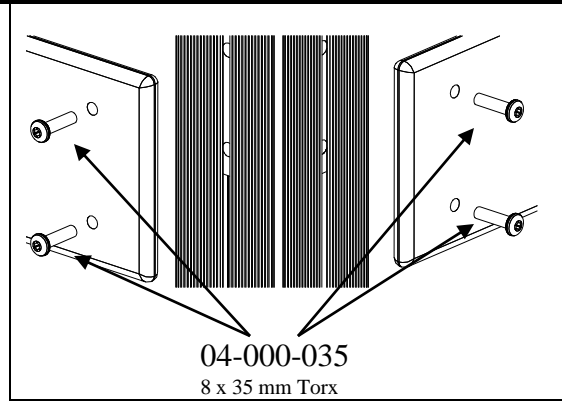

04-000-035  
8 x 35 mm Torx

2

00-450-305

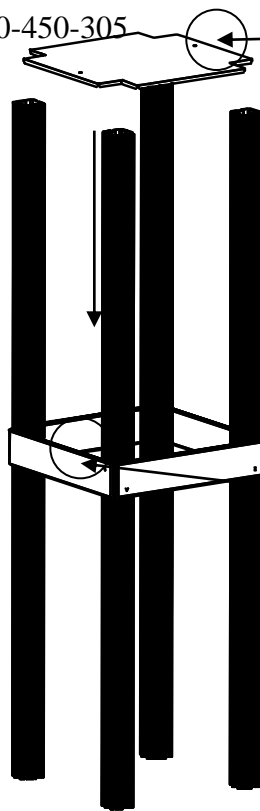

04-090-002 x 7



- (N) Resterende hull
- (UK) Remaining holes
- (S) Resterande hull

04-030-016  
8 x 16 mm

04-075-050  
50 x 50 x 5 mm

04-040-008  
8 mm

04-050-008  
8 mm

04-000-012  
8 x 12 mm Torx

04-000-030  
8 x 30 mm Torx

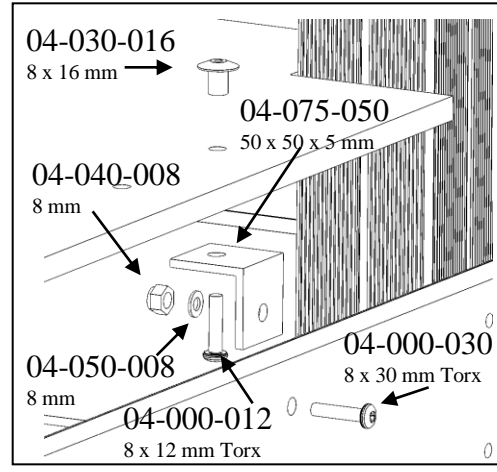

3

04-060-040

TorxM8-1

04-000-035

04-060-040

BOM ID	Name	SW Configuration	Artnr (config)	Qty
1	TorxM8-	TXM8x35	04-000-035	2
2	brikke SFA5116-	50 1T	04-060-040	2

01-400-615

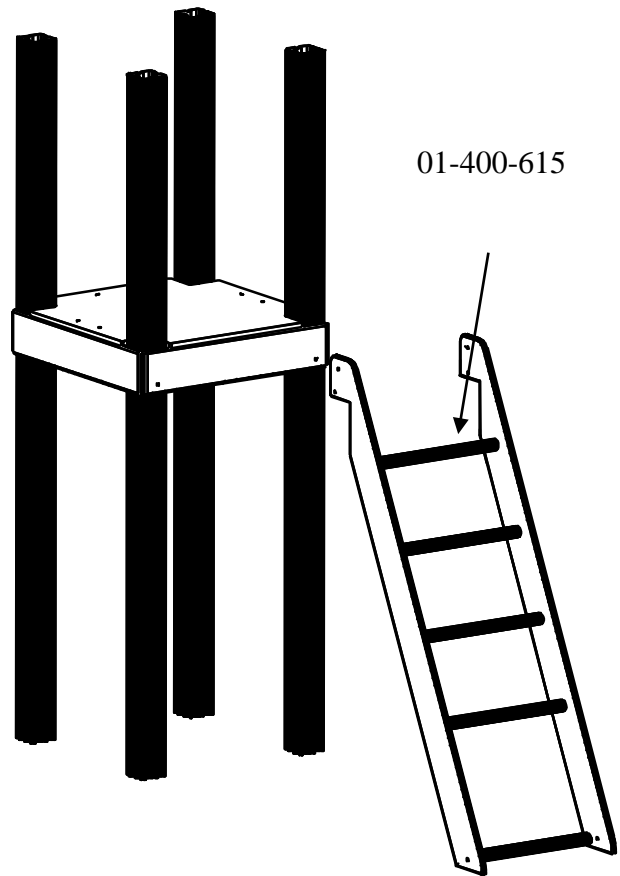

4



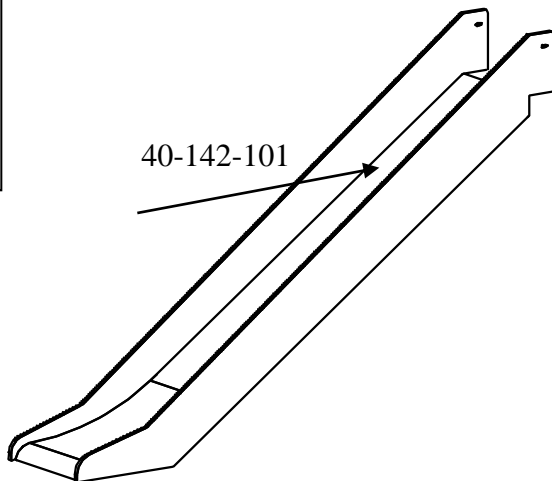
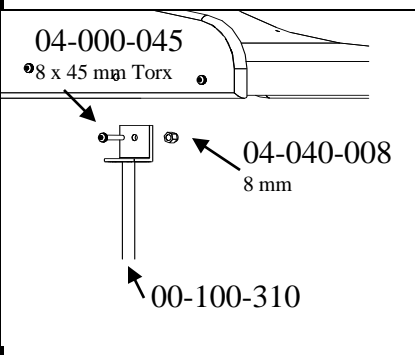
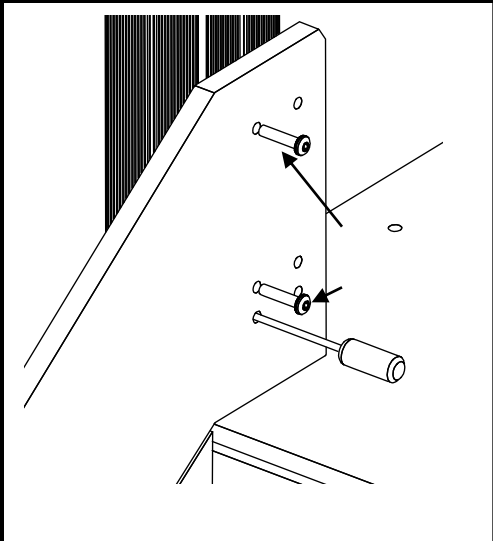

5

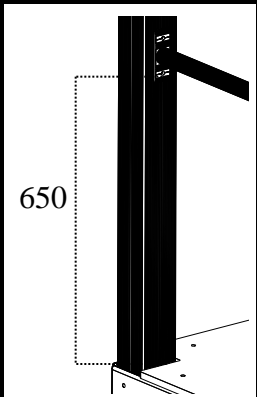

00-450-155 x 2

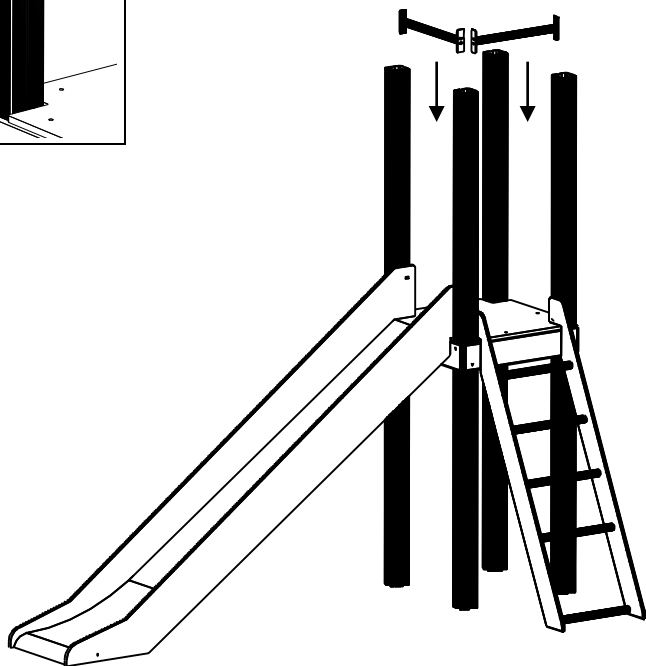
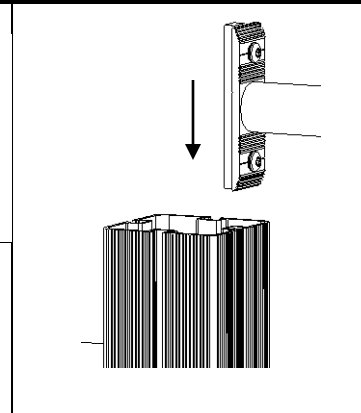
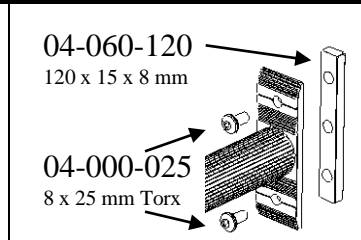

6

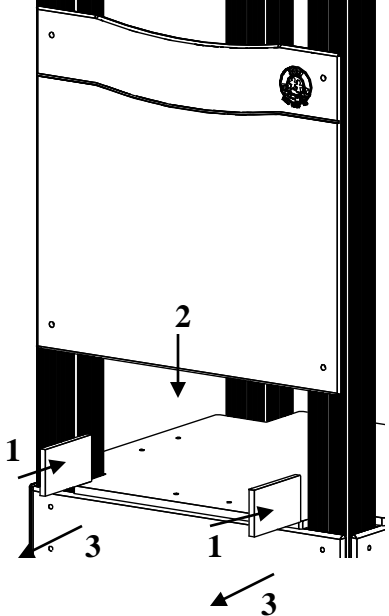

- (N) Avstandskloss
- (UK) Distance piece
- (S) Distanskloss

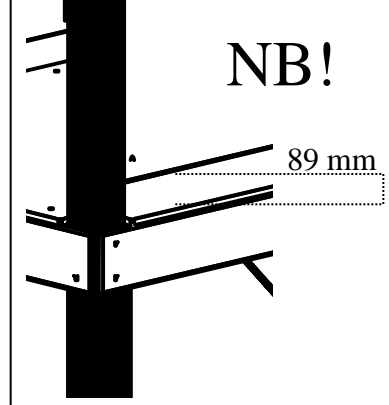

NB!

89 mm

01-125-011 x 2

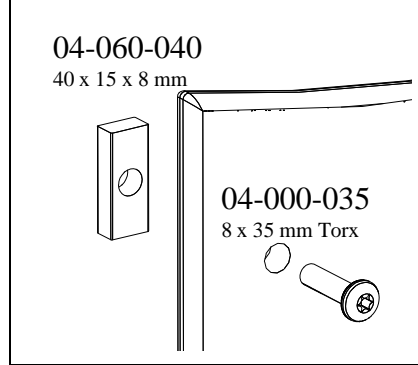
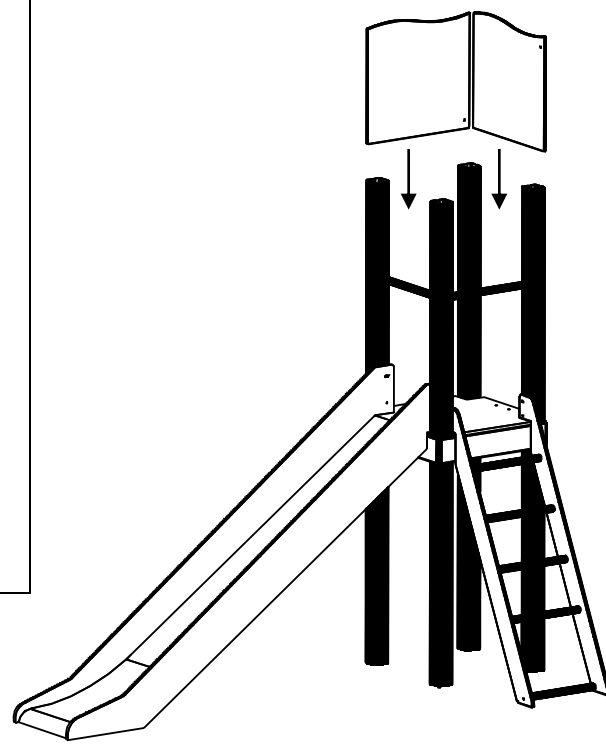

04-060-040  
40 x 15 x 8 mm

04-000-035  
8 x 35 mm Torx

7

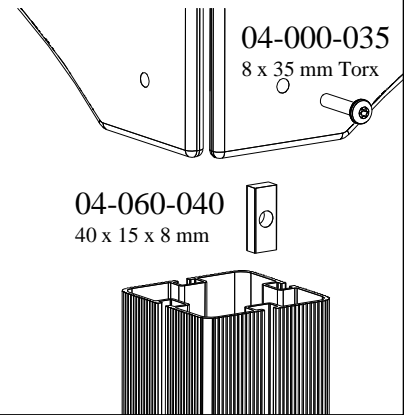

04-000-035  
8 x 35 mm Torx

04-060-040  
40 x 15 x 8 mm

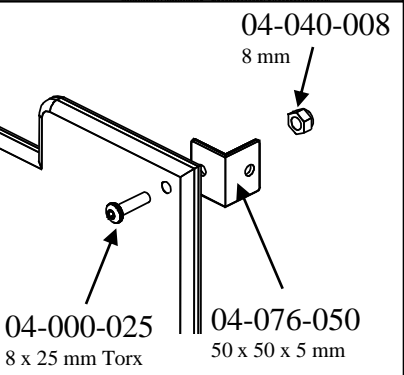

04-040-008  
8 mm

04-000-025  
8 x 25 mm Torx

04-076-050  
50 x 50 x 5 mm

01-450-501

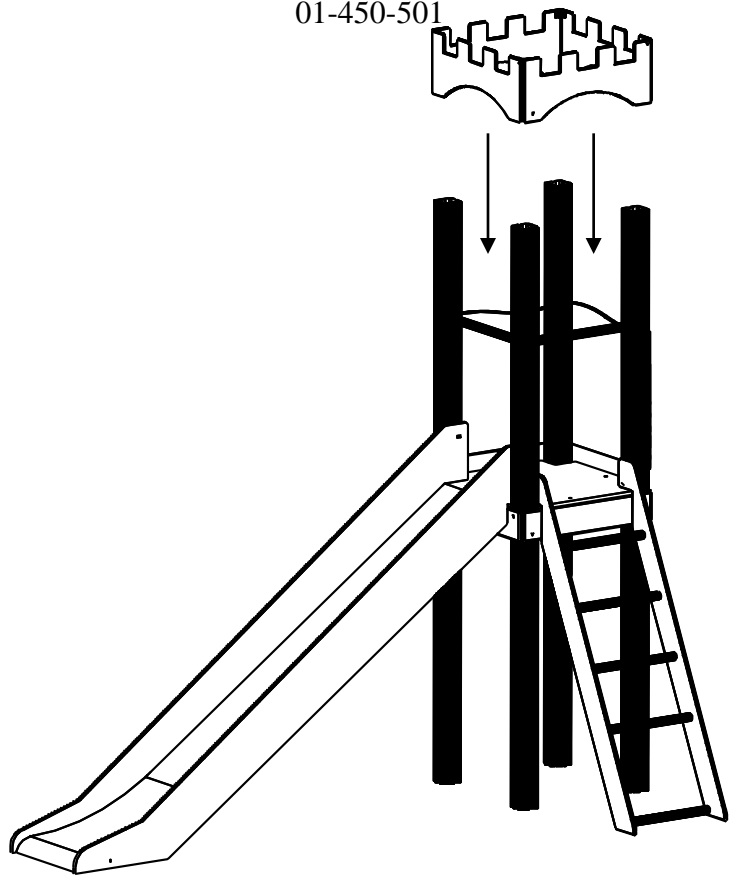

8

00-400-998 x 4

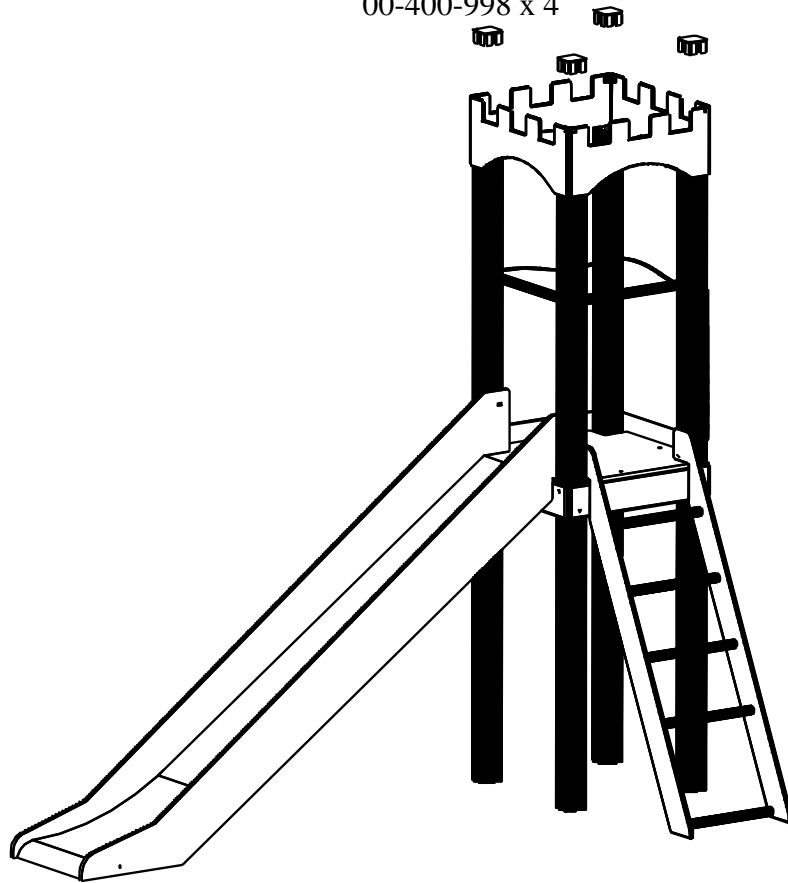

1

00-400-980

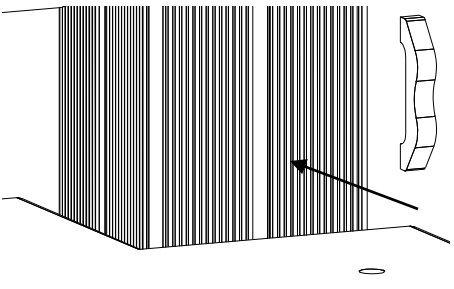

2

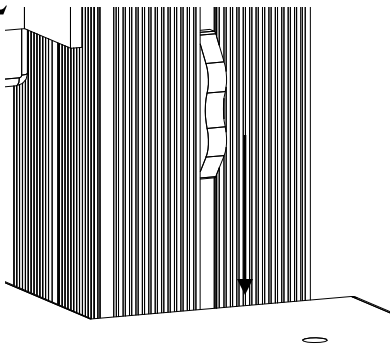

3

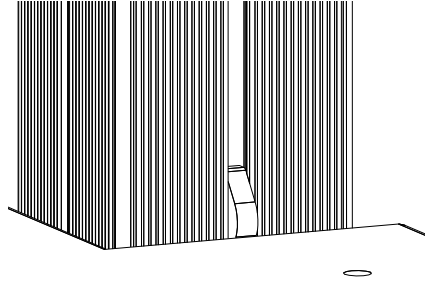

N

- ▣ Påse at fallunderlag er lagt i henhold til gjeldende regler eller vår anbefaling
- ▣ Fjern alle monteringshjelpemidler ( rester av betong, planker, paller, plast, og lignende)
- ▣ Før utstyret tas i bruk, sjekk at det ikke er hektefare for anorakksnorer og lignende noen steder på lekeapparatet.

NB! Bør stå i 2-3 dager før bruk når forankring støpes.

UK

- ▣ Make sure the area and depth of safer surfacing are according to the current standard, or to the manufacturer's recommendation
- ▣ Make sure all tools and surplus materials are removed before play begins

PS! When complete, allow 2-3 days for the concrete to set before use.







S

- ▣ Kontrollera att fallunderlag är utlagt enligt gällande regler eller vår rekommendation
- ▣ Ta bort alla monteringshjälpmedel (rester av betong, plankor, pallar, plast och liknande)
- ▣ Innan lekredskapet används, kontrollera att anoracksnoddar eller kläder/delar av kläder eller liknande inte kan fastna i några delar på redskapet.

- ▣ OBS! Bör stå i 2-3 dagar innan användning när det gjuts

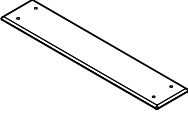
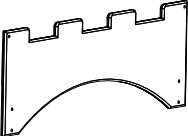
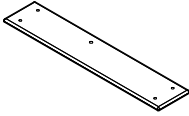
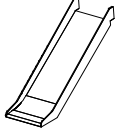
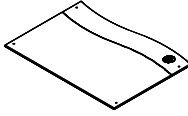
**5**
**Pakkliste for / Parts list for / Packlista för :**  
**12-100-025**

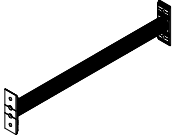

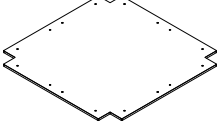
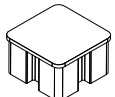





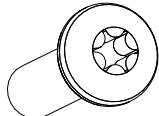

Sign. \_\_\_\_\_

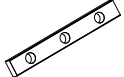
N UK S	Komponenter	Dimensjon	Ant	Lev	Komponenter	Dimensjon	Ant	Lev
	Components	Dimension	Qty	Lev	Components	Dimension	Qty	Lev
	Komponenter	Dimension	Ant	Lev	Komponenter	Dimension	Ant	Lev
	00-400-015 	3230 x 95 x 95 Med 2 brikker i hver stolpe	4		01-400-615 	1750 x 174 x 520	1	
	01-450-111 	710 x 145 x 15	3		01-450-502 	710 x 300 x 12	4	
	01-450-112 	710 x 145 x 15	1		40-142-101 	0,5m x 3 m	1	
	01-125-011 	688 x 638 x 12	2			00-400-980	4	
	00-450-155 	520 x 120 x 40	2					
	00-100-310 	512 x 120	4					
	00-450-305 	740 x 740 x 15	1					
	00-400-998 	55 x 95 x 95	4					
	00-400-997 Med hull		4					

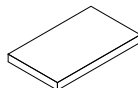









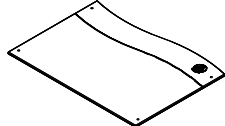

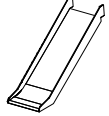

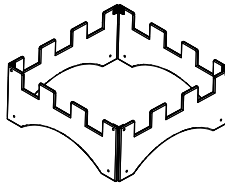

5

**Pakkliste for / Parts list for / Packlista för :  
12-100-025**

Sign. \_\_\_\_\_

	Bolter/skruer Bolts/Screws Komponenter	Dimensjon Dimension Dimension	Ant Qty Ant	Lev Lev Lev	Bolter/skruer Bolts/Screws Bultar/Skruvar	Dimensjon Dimension Dimension	Ant Qty Ant	Lev Lev Lev
		04-000-025 8 x 25 mm Torx 04-000-030 8 x 30 mm Torx 04-000-035 8 x 35 mm Torx	8 2 16		 Produkt merking Product marking Produkt märkning			1
	04-060-120 120 x 15 x 8 mm	4		 Avstandskloss Distance piece Distanskloss		89 mm	2	
	04-040-008 8 mm	2						
	04-075-050 50 x 50 x 5 mm	1				04-000-012 8 x 12 mm Torx	1	
	04-050-008 8 mm	2						
	04-090-002	7				04-030-016 8 x 16 mm	1	

**Boltepakker for / Boltpackage for / Bultpaket för 12-100-025**

01-125-011  Antall Number Antal		04-060-040 40 x 15 x 8 mm	4 X 2	40-142-101  Antall Number Antal		04-060-160 160 x 15 x 8 mm	2
		04-000-035 8 x 35 mm Torx	4 X 2			04-000-045 8 x 45 mm Torx 04-000-035 8 x 35 mm Torx	2 4
						04-040-008 8 x 25 mm	2
01-400-615  Antall Number Antal		04-060-040 050 x 15 x 8 mm	2	01-450-501  Antall Number Antal		04-060-040 40 x 15 x 8 mm	8
		04-000-025 8 x 25 mm Torx	2			04-000-035 8 x 35 mm Torx 04-000-025 8 x 25 mm Torx	8 8
		04-030-016 8 x 16 mm	2			04-040-008 8 mm	8
		04-090-002	6			04-076-050 50 x 50 x 5 mm	4

**5** Pakkliste for / Parts list for / Packlista för :  
12-100-025

Sign. \_\_\_\_\_

**Forankring / Foundations / Markförankring**

**00-003-003**

N Er bestilt       Ikke bestilt  
 UK In order       Not in order  
 S Beställt       Ej beställt

00-400-997

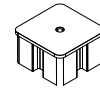

-4

00-003-100 00-003-101 00-003-102	4	04-000-035 8 x 35 mm Torx	12
		04-050-008 8 mm	12
		04-060-120 120 x 15 x 8 mm	8
00-003-103 	0	04-000-040 8 x 40 mm Torx	0
		04-040-008 8 mm	0
		04-050-008 8 mm	0
00-003-105  00-003-106 	4	04-010-035 10 x 35 mm	8
		04-040-010 10 mm	8
		04-050-010 10 mm	8

Eller  
Or  
Eller