

(N) Monteringsanvisning

(UK) Assembly Instructions

(S) Monteringsanvisning

Produkt nr. / Product no. / Produkt nr.

12-100-055

Ordr. nr. _____

Dato. _____

Sign. _____

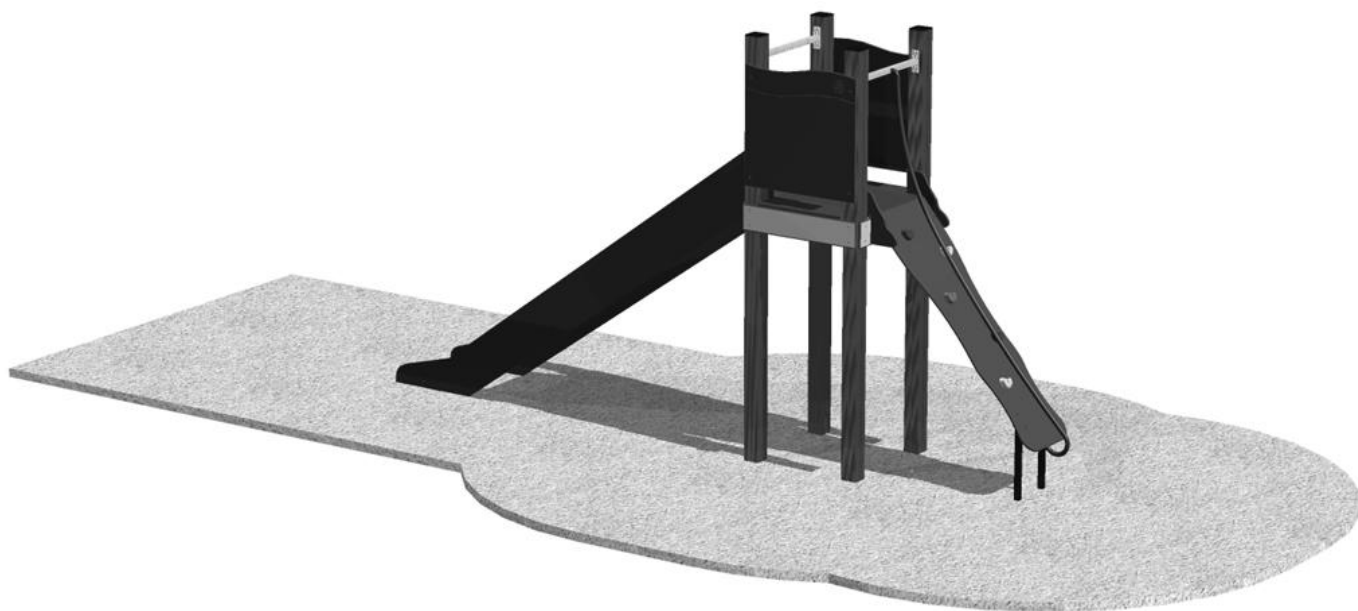

Søve Lekemiljø AS

3830 Ulefoss - Norway

Tlf: +47 35 94 65 65

www.sove.no



Søve AB

412 50 Göteborg

Phone: +46 (0)31 773 97 00

www.sove.se

21.12.2011

1

Monteringstips / Assembly Advice / Monteringsstips

N

- ▣ Les monteringsanvisningen nøye før montering.
 - ▣ Monter elementene i rekkefølgen som vist.
 - ▣ Boltene bør ikke skrues for hardt til før alt er montert, vatret og loddet. Skru så boltene til.
- NB! Ved bruk av drill, kan boltene ryke.
- ▣ På grunn av at solen kan gjøre rutsjeflaten veldig varm, bør rutsjebanens utløp vende mot nord-øst eller nord-vest.
 - ▣ Er lekeutstyret plassert i naturlige ferdselstraséer må området sikres mot spontan gjennomgang.
 - ▣ Innspringningshinder bør vurderes rundt lekeapparater hvor det er stor bevegelse, f.eks. ved huskestativ.
 - ▣ Det bør være fritt innsyn til lekeutstyr som er beregnet for barn under 3 år.

NB! Under monteringsarbeidet må utstyr, som ikke er forankret forsvarlig i bakken, avstives slik at det ikke velte. Området må avstenges under oppsettelse av apparatene med sperrebånd eller lignende.

UK

- ▣ Read the instruction carefully before assembling the play unit.
 - ▣ Assemble the components in the sequence shown in these instructions.
 - ▣ Fixings must not be fully tightened during assembly. Before casting the foundations, the structure must be level and plumb, at which point all fixings are tightened.
- PS! If use of drill, the bolts may be wrecked.
- ▣ Avoid positioning the slide facing due south because of overheating – ideal positions are facing north-east or north-west.
 - ▣ Secure the construction-area to prevent people from walking through it.
 - ▣ Consider installing barriers around play-equipment which gives rise to a lot of activity – i.e. swings.
 - ▣ Ensure that clear vision is possible across the play area so that supervision is possible from any position, particularly where children under 3 years of age will be playing.

NB! During assembly of the equipment, ensure that all structures are securely propped, especially when left overnight. Also ensure that equipment is supported whilst concrete foundations are setting and enclose the area securely to prevent access.

▮ Läs monteringsanvisningen noga före montering.

▮ Montera delarna i den ordningen som anvisas

▮ Skruvarna bör inte skruvas för hårt tills allt är monterat, i våg och lodat.

OBS! Används elektrisk skruvdragare, kan bulten gå sönder. Hårdra därför manuellt!

▮ Solen kan göra att rutchbanan blir väldigt varm. Banans nedfart rekommenderas att vändas i norrlig riktning

▮ Om lekplatsen placeras vid en gångväg mm bör området säkras mot genomfart av gående och cyklister.

▮ Inspringningshinder bör placeras runt lekutrustning med stor rörelse, t ex, gungställning.

▮ Det bör vara fri insyn till lekutrustning beräknat till barn under 3 år.

OBS! Under monteringsarbete bör utrustningen som inte ska förankras i marken, ställs så att den inte kan välta.

Området måste spärras när lekutrustningen byggs upp, med avspärrningsband eller liknande.

2

Nødvendig verktøy / Tools required / Nödvändiga verktyg

N
UK
S

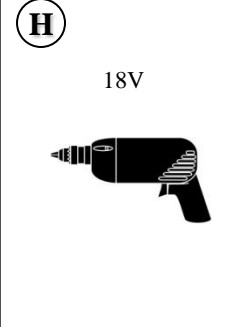
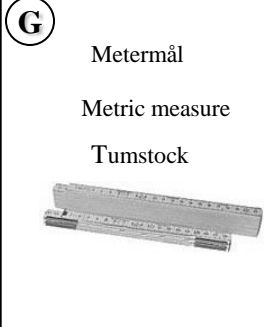
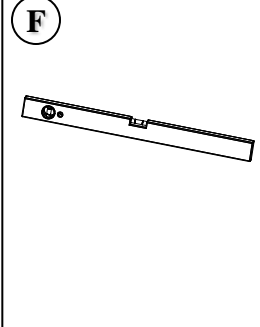
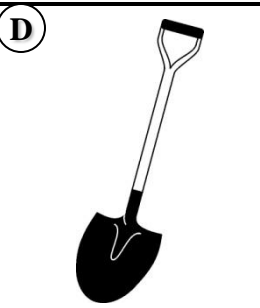
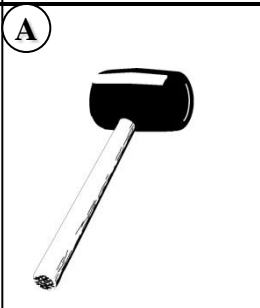

3

Nødvendig antall personer / Number of persons required / Lämpligt antal personer

N
UK
S

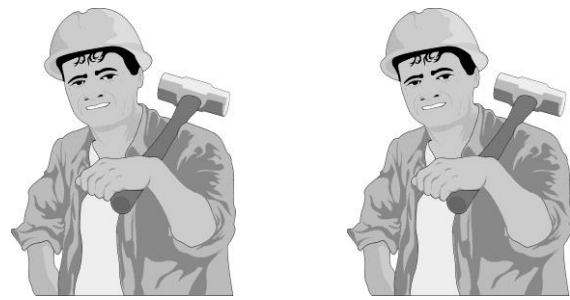

4

Anbefalt arealbehov ved montering / Recommended working space / Rekommenderad arealbehov vid montering



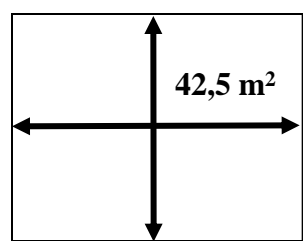



N
UK
S

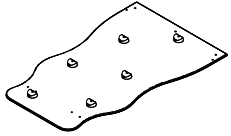
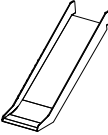
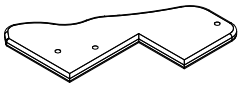
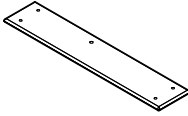

5

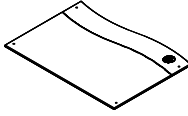
Pakkliste for / Parts list for / Packlista för :
12-100-055

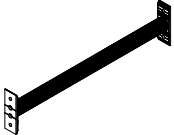
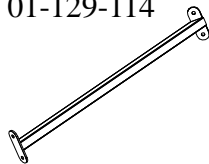

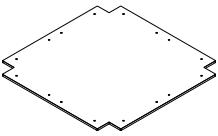
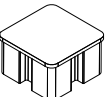







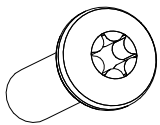
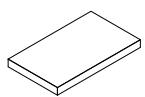
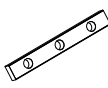







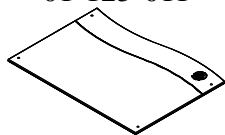

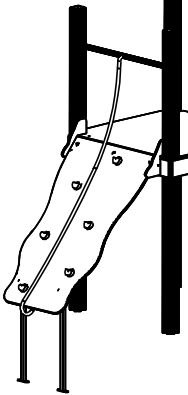

Sign. _____

N UK S	Komponenter	Dimensjon	Ant	Lev	Komponenter	Dimensjon	Ant	Lev
	Components	Dimension	Qty	Lev	Components	Dimension	Qty	Lev
	Komponenter	Dimension	Ant	Lev	Komponenter	Dimension	Ant	Lev
	00-400-013 	2900 x 95 x 95 Med 2 brikker i hver stolpe	4		01-130-112 	1480 x 490 x 15	1	
	40-142-101 	0,5m x 3 m	1		01-129-113 	282 x 263 x 15	2	
	01-450-112 	710 x 145 x 15	4		00-261-520 	520 x 120	1	
	01-125-011 	688 x 638 x 12	2		04-080-004 	490 x 40 x 33	1	
	00-450-155 	520 x 120 x 40	1		01-129-114 	810 x 120 x 40	2	
	00-100-310 	512 x 120	2					
	00-450-305 	740 x 740 x 15	1					
	00-400-998 	55 x 95 x 95	4					
	00-400-997 Med hull		4					5

5

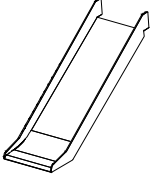
**Pakkliste for / Parts list for / Packlista för :
12-100-055**

Sign. _____

Bolter/skruer Bolts/Screws Komponenter		Dimensjon Dimension Dimension	Ant Qty Ant	Lev Lev Lev	Bolter/skruer Bolts/Screws Bultar/Skruvar		Dimensjon Dimension Dimension	Ant Qty Ant	Lev Lev Lev
	04-000-012 8 x 12 mm Torx	2	16		(N) Produkt merking (UK) Product marking			1	
	04-000-025 8 x 25 mm Torx	8							
04-000-030 8 x 30 mm Torx	2	(N) Avstandskloss (UK) Distance piece (S) Distanskloss				89 mm	2		
04-000-035 8 x 35 mm Torx									
	04-060-120 120 x 15 x 8 mm	4							
	04-040-008 8 mm	2							
	04-075-050 50 x 50 x 5 mm	2							
	04-050-008 8 mm	2							
	04-090-002	7					04-060-120 120 x 15 x 8 mm	2	
	04-030-016 8 x 16 mm	2					04-060-040 40 x 15 x 8 mm	2	
Boltepakker / Boltpackage / Bultpaket									
01-125-011  Antall Number Antal		04-060-040 40 x 15 x 8 mm	4 X 2				04-000-025 8 x 25 mm Torx	5	
		04-000-035 8 x 35 mm Torx	4 X 2				04-000-030 8 x 30 mm Torx	8	
				04-000-035 8 x 35 mm Torx			2		
				04-000-040 8 x 40 mm Torx			3		
				04-000-045 8 x 45 mm Torx			2		
							04-040-008 8 mm	8	
							04-070-035 35 x 35 x 3 mm	2	
							04-030-016 8 x 16 mm	4	
							04-050-008 8 mm	9	
							04-090-001	2	
40-142-101  Antall Number Antal		04-060-160 160 x 15 x 8 mm	2						
		04-000-035 8 x 35 mm Torx	4						
		04-000-045 8 x 45 mm Torx	2						
		04-040-008 8 mm	2						
	Monteringsanvisning Assembly Instructions Monteringsanvisning			1					

5 Pakkliste for / Parts list for / Packlista för :
12-100-055

Sign. _____

Forankring / Foundations / Markförankring

00-003-003

N Er bestilt Ikke bestilt
 UK In order Not in order
 S Beställt Ej beställt

00-400-997

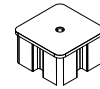

-4

00-003-100 00-003-101 00-003-102	4	04-000-035 8 x 35 mm Torx	12
		04-050-008 8 mm	12
		04-060-120 120 x 15 x 8 mm	8
00-003-103 	0	04-000-040 8 x 40 mm Torx	0
		04-040-008 8 mm	0
		04-050-008 8 mm	0
00-003-105 00-003-106 	4	04-010-035 10 x 35 mm	8
		04-040-010 10 mm	8
		04-050-010 10 mm	8

6**Fundamentering med betong / Foundation concrete / Förankring med betong**

(N) Bakkenivå (UK) Ground level (S) Marknivå

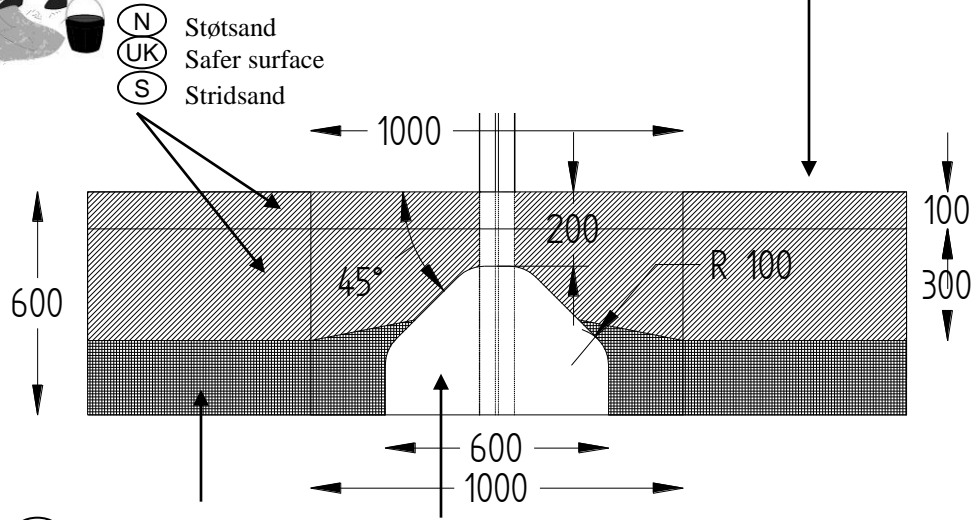

Ref NS-EN 1177

(N) Komprimert masse. betong
 (UK) Compressed mass. concrete
 (S) Komprimerad massa. betong

6**Fundamentering uten betong / Foundation without concrete / Förankring utan betong**

(N) Bakkenivå (UK) Ground level (S) Marknivå

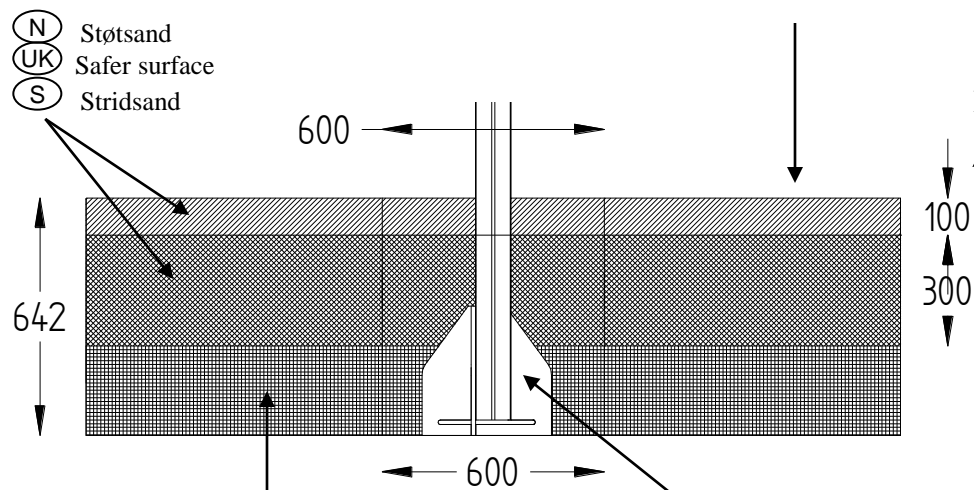

Ref NS-EN 1177

(N) Støtsand
 (UK) Safer surface
 (S) Stridsand

(N) Komprimert masse Støpefri nedgraving
 (UK) Compressed mass Concrete-free anchor
 (S) Komprimerad massa Nedgravningsfundament

(N)

Alle mål er oppgitt i millimeter

(UK)

Scale measured in mm

(S)

Alla mått är i millimeter.

- (N) For klatrenett
- (UK) For climbing net
- (S) För klätternät

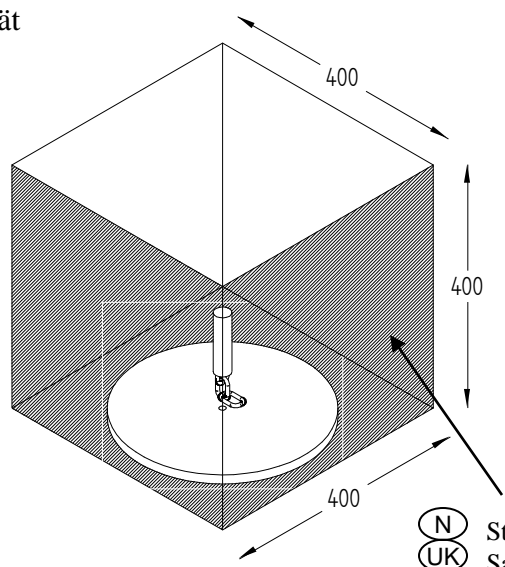
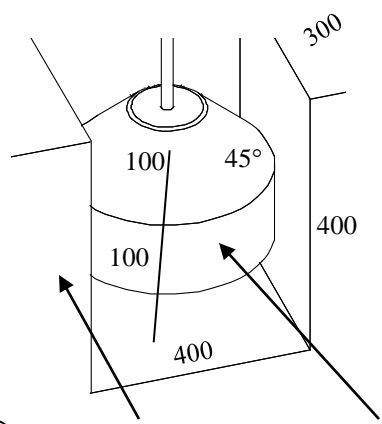

- (N) Komprimert masse. betong
- (UK) Compressed mass. concrete
- (S) Komprimerad massa. betong

- (N) Støtsand
- (UK) Safer surface
- (S) Stridsand

- (N) Alle mål er oppgitt i millimeter
- (UK) Scale measured in mm
- (S) Alla mått är i millimeter.

6

(N) Dybde for støping og forankring

(UK) Depth of foundations /

(S) Djup för gjutning och markförankring

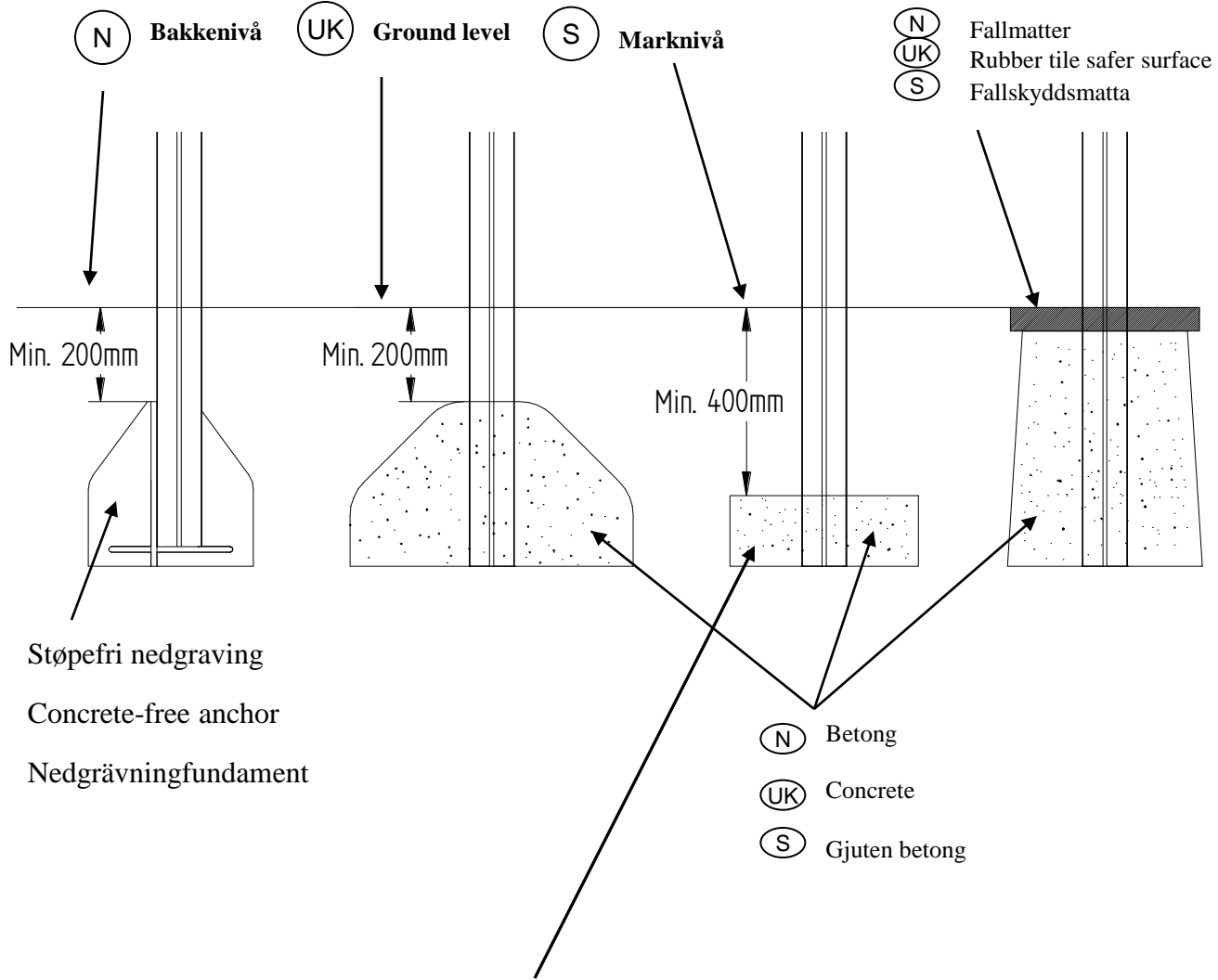

- (N) Støpefri nedgraving
- (UK) Concrete-free anchor
- (S) Nedgrävningfundament

(N) Denne støpemetoden anbefales ikke grunnet dårlig stabilitet av lekeapparatet.

(UK) This anchor is recommend not to use because of poor stability of the play unit.

(S) Denna förankring avrådes från att användas, därför att lekutrustningen får dålig fäste.

1

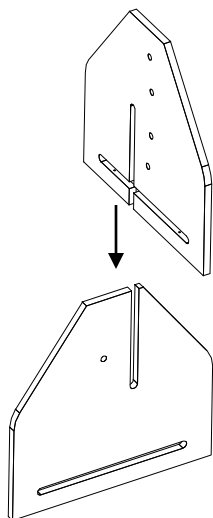

2

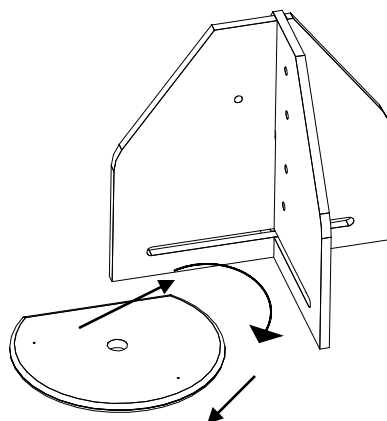

3

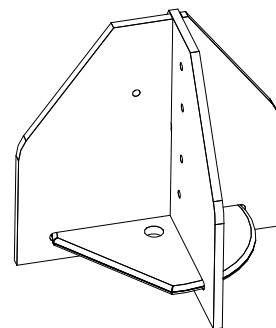

4

04-060-120 x 2
120 x 15 x 8 mm

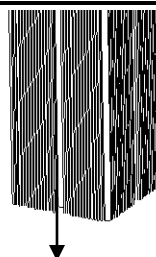

04-000-035 x 3
8 x 35 mm Torx

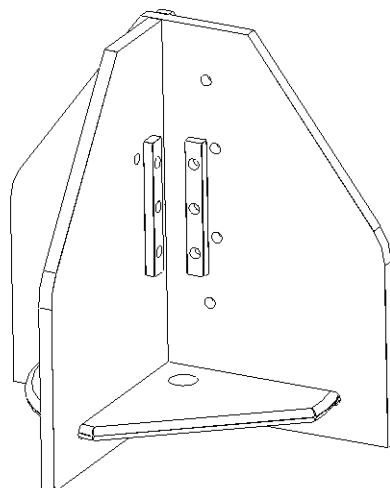

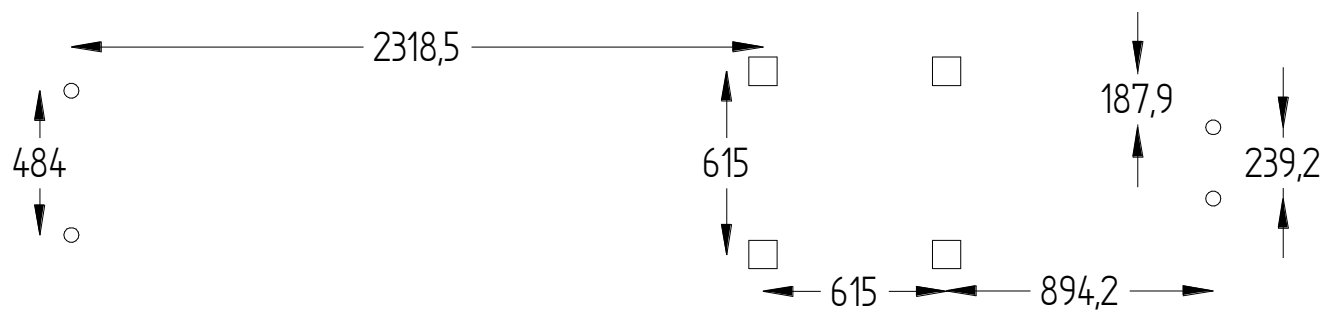

N

Alle mål er oppgitt i millimeter

UK

Scale measured in mm

S

Alla mått är i millimeter.

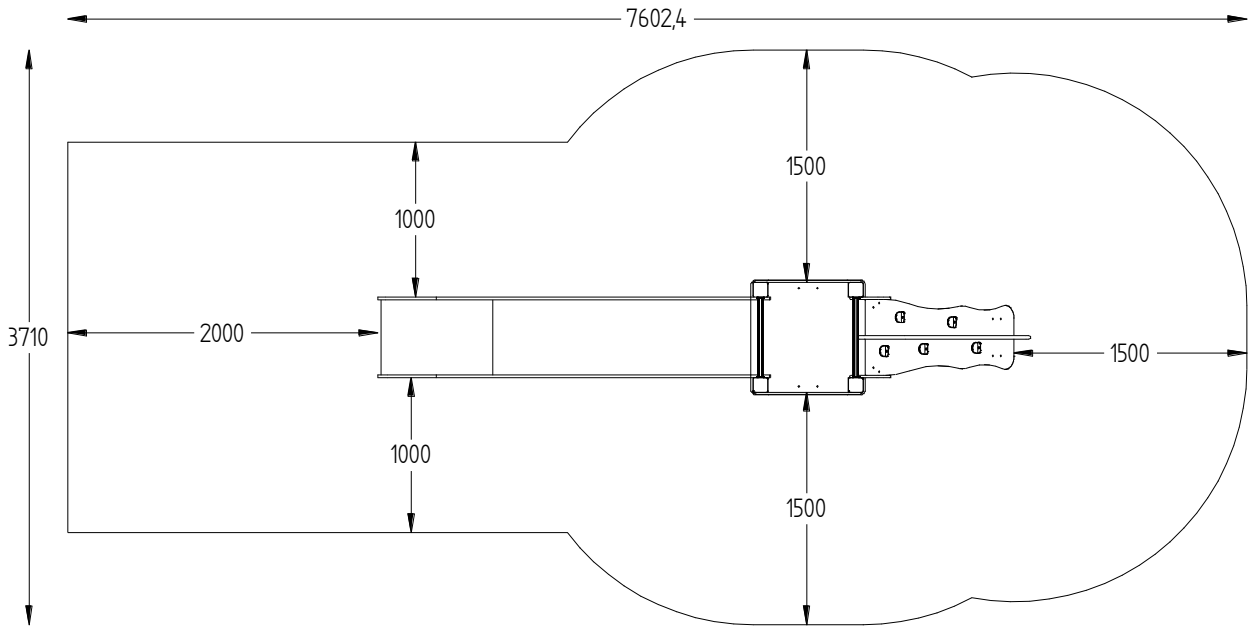
8**Sikkerhetszone / Safty zone / Säkerhetszon****N**

Alle mål er oppgitt i millimeter

UK

Scale measured in mm

S

Alla mått är i millimeter.

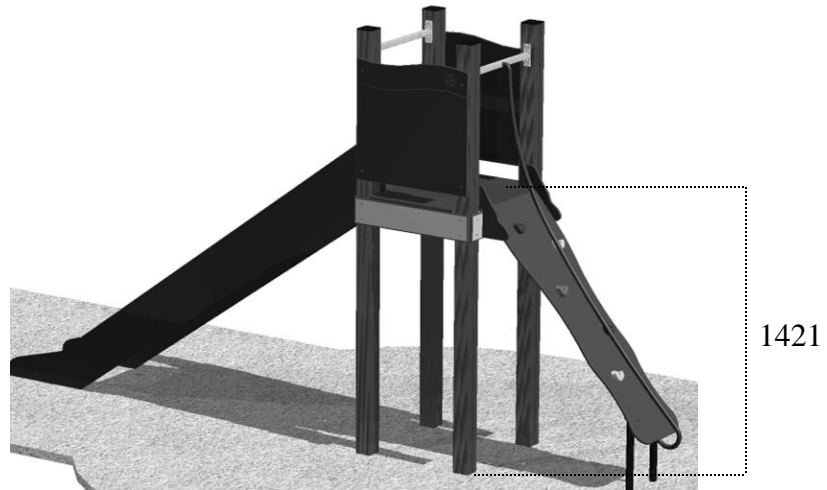
9**Fallhøyder / Free height of fall / Fallhöjder****N**

Alle mål er oppgitt i millimeter

UK

Scale measured in mm

S

Alla mått är i millimeter.

OBS !

- Ⓝ Bolter skrues helt igjennom aluminiumstolpene. Om elektrisk drill brukes anbefales 18 V
- ⓊⓀ Bolts must be tightened through the post, so that it pierces the aluminium.
- Ⓢ Bultarna skruvas rakt igenom aluminiumstolparna. Om elektrisk skruvdragare används rekommenderas 18 V

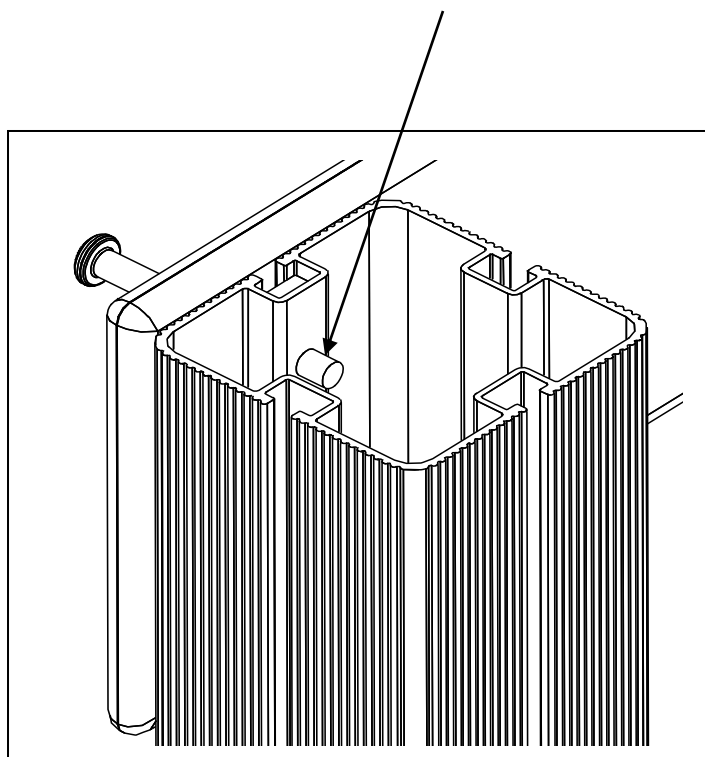

- (N) Uten betong
- (UK) Without concrete
- (S) Utan betong

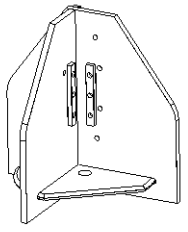

00-003-003

- (N) Med bruk av betong
- (UK) With use of concrete
- (S) Användning av betong

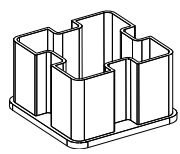
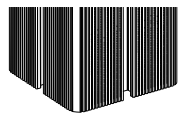

00-400-997

00-400-013 x 4

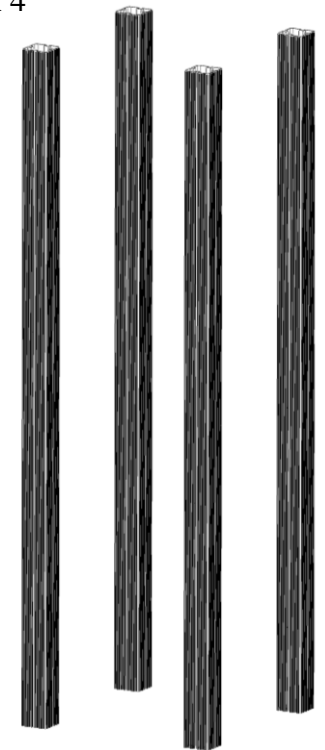

1

01-450-112

01-450-112

01-450-112

01-450-112

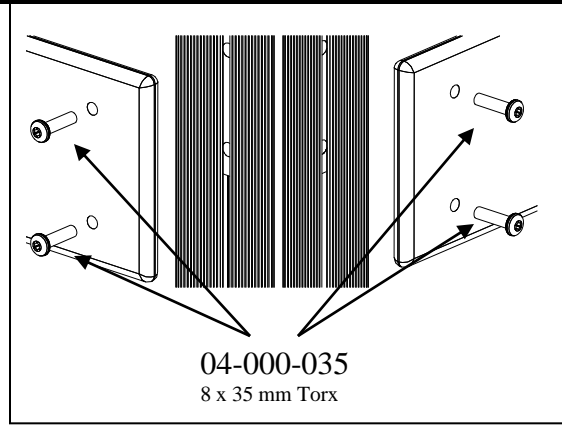
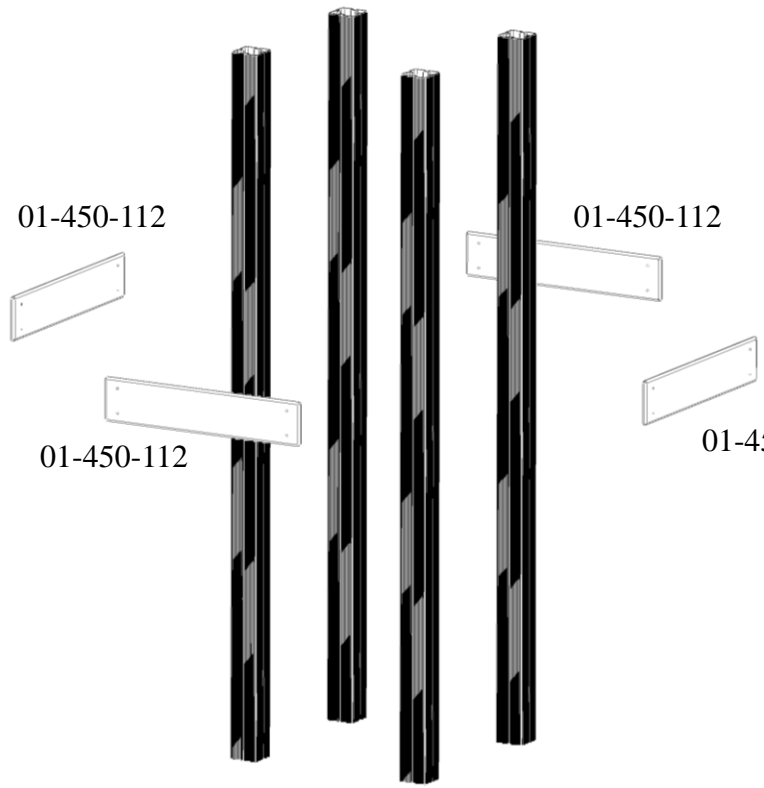

04-000-035
8 x 35 mm Torx

2

04-030-016

8 x 16 mm →

04-075-050

50 x 50 x 5 mm

04-040-008

8 mm

04-050-008

8 mm

04-000-016

8 x 12 mm Torx

04-000-030

8 x 30 mm Torx

00-450-305

04-090-002 x 7



(N)

Resterende hull

(UK)

Remaining holes

(S)

Resterande hull

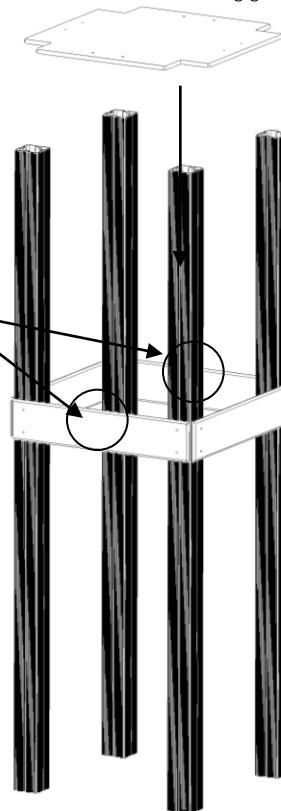

(N)

Gulvet festes kun med 2 vinkler

(UK)

The floor is connected at 2 points

(S)

Golvet fästes endast med 2 vinklar

3

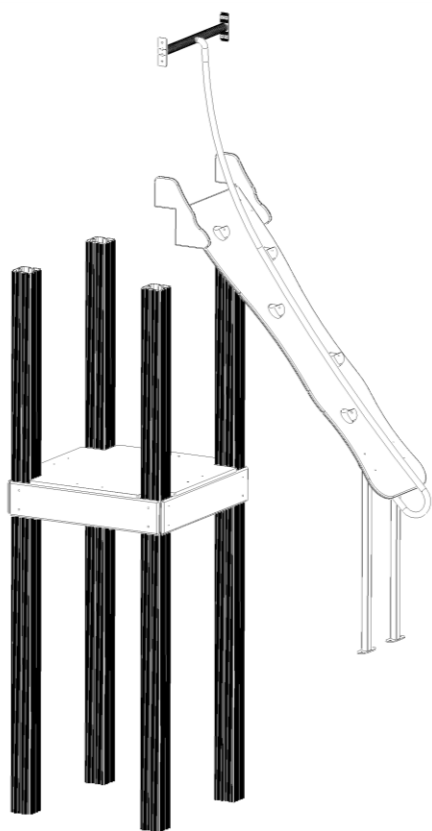

01-129-113

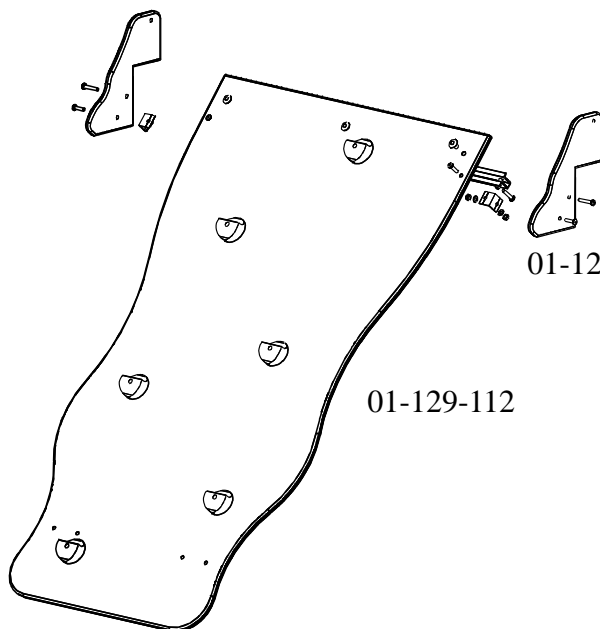

01-129-113

01-129-112

4

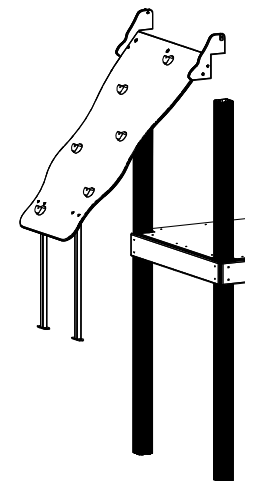
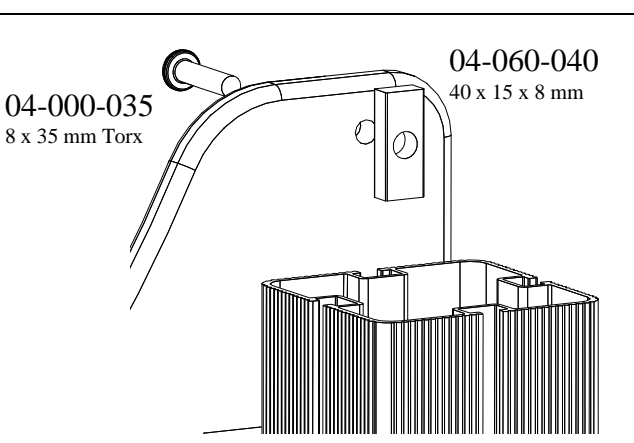
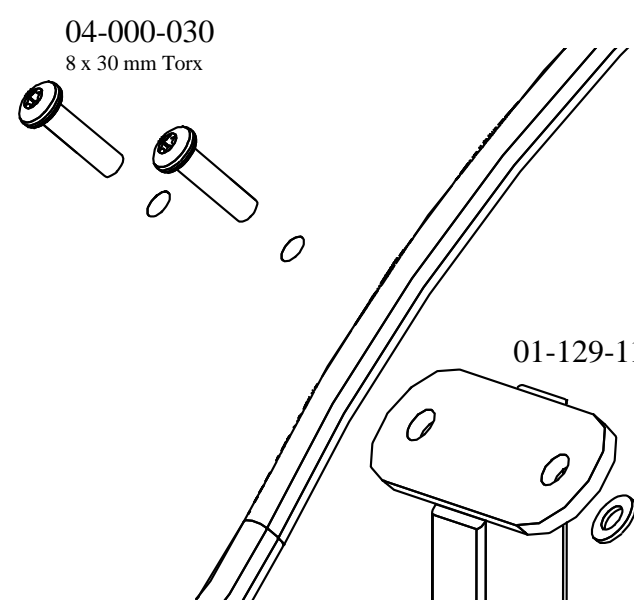
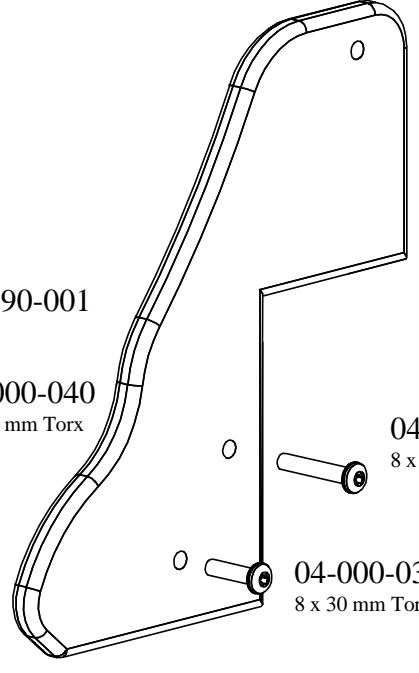
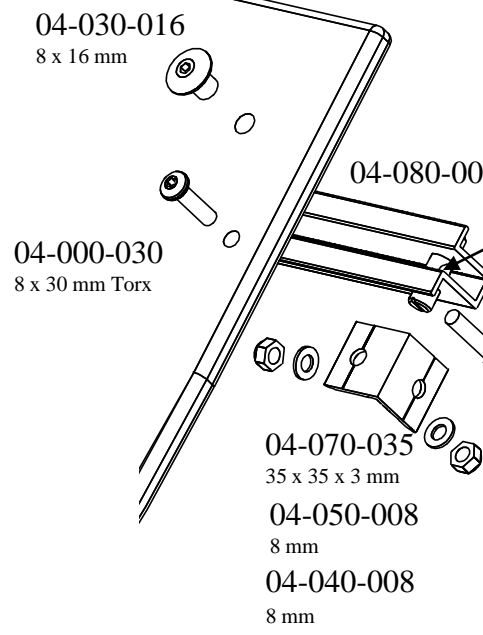

00-261-520

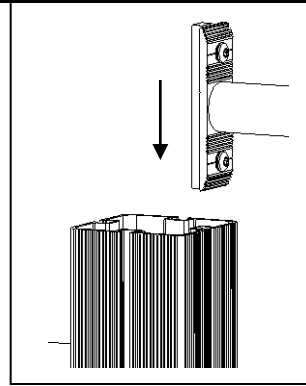
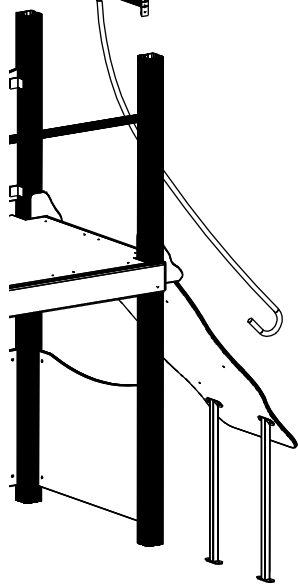

04-060-120
120 x 15 x 8 mm

04-000-025
8 x 25 mm Torx

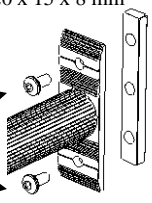

650

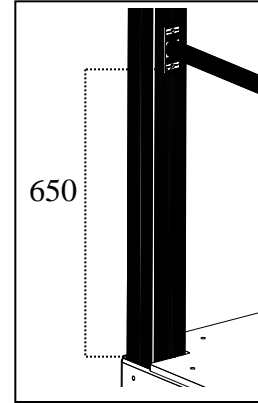

04-030-016
8 x 16 mm

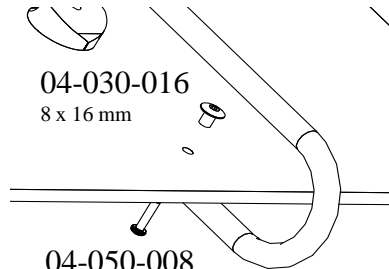

Ø 11 mm

04-050-008
8 mm
04-000-012
8 x 12 mm Torx

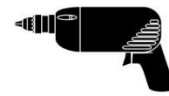

6

40-142-101

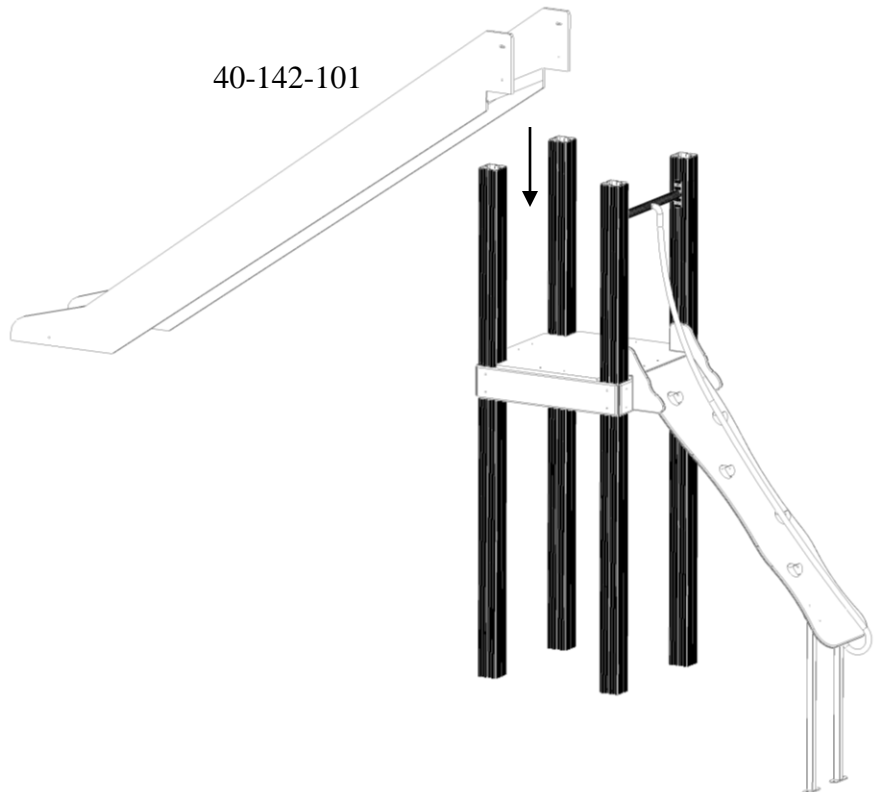

04-000-045
8 x 45 mm Torx

00-100-310

04-040-008
8 mm

04-050-008
8 mm

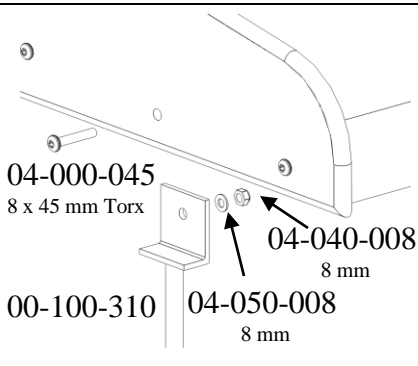

04-000-035
8 x 35 mm Torx x 4

04-060-160
160 x 15 x 8 mm

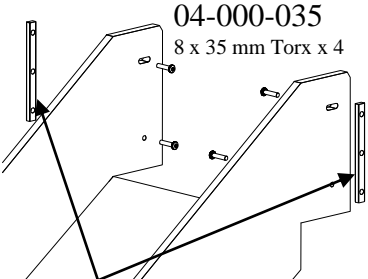

7

650

04-060-120
120 x 15 x 8 mm

04-000-025
8 x 25 mm Torx

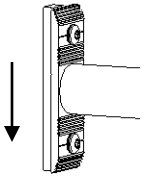

00-450-155

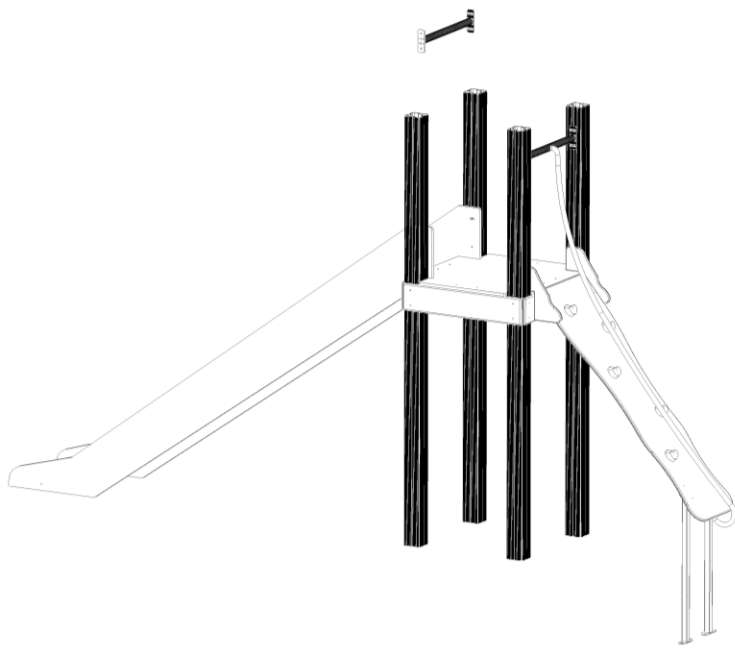

8

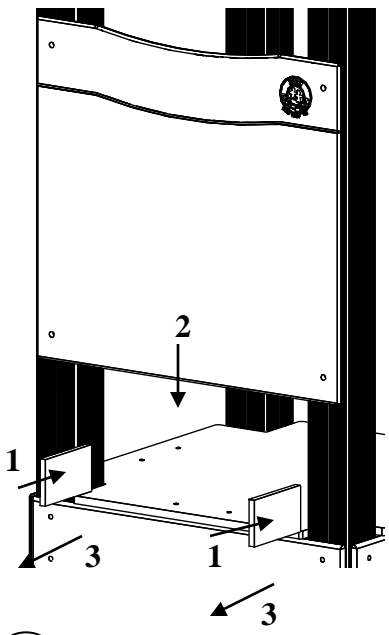

01-125-011 x 2

NB!

89 mm

04-060-040
40 x 15 x 8 mm

04-000-035
8 x 35 mm Torx

- (N) Avstandskloss
- (UK) Distance piece
- (S) Distanskloss

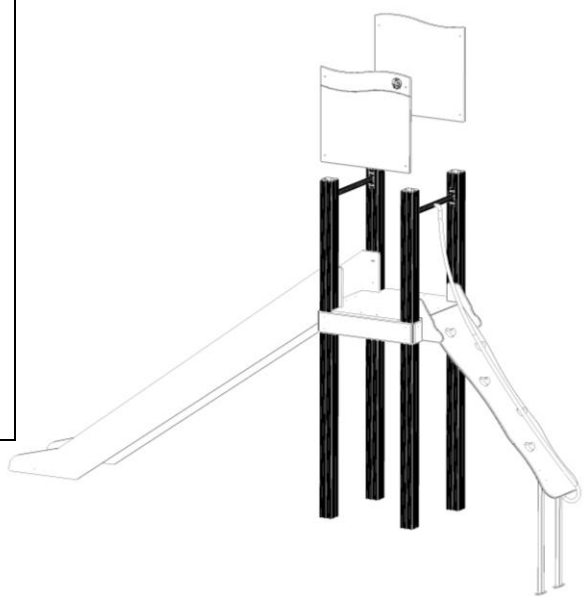

9

00-400-998 x 4

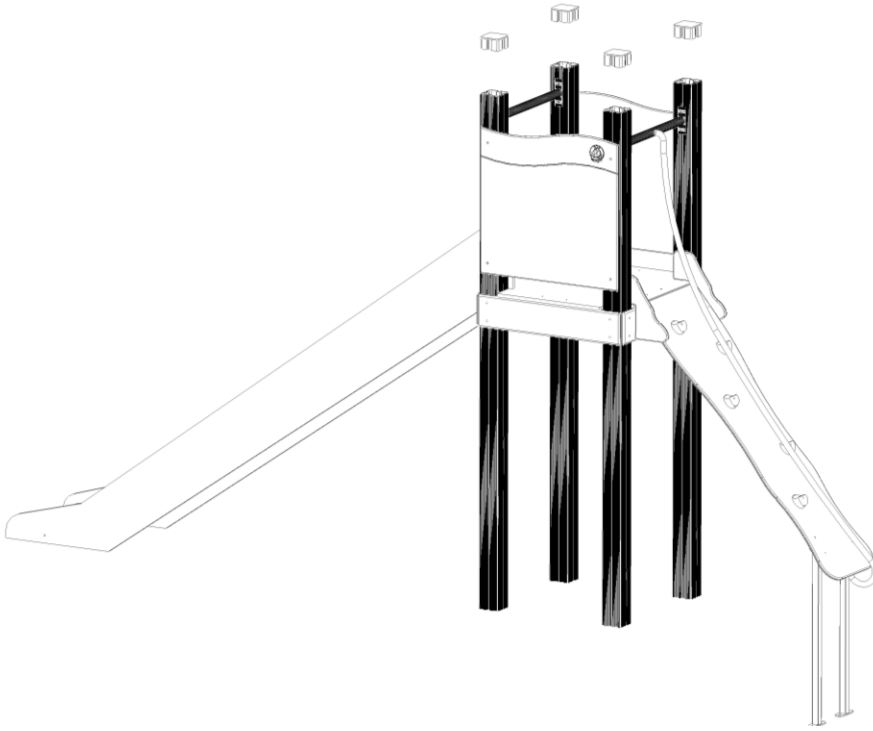

10

1

00-400-980

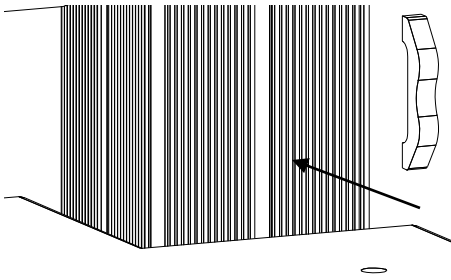

2

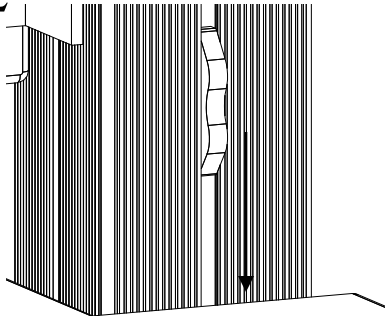

3

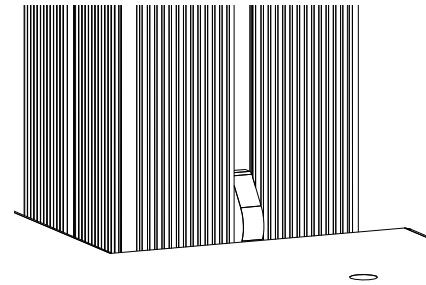

N

- ▣ Påse at fallunderlag er lagt i henhold til gjeldende regler eller vår anbefaling
- ▣ Fjern alle monteringshjelpemidler (rester av betong, planker, paller, plast, og lignende)
- ▣ Før utstyret tas i bruk, sjekk at det ikke er hektefare for anorakksnorer og lignende noen steder på lekeapparatet.

NB! Bør stå i 2-3 dager før bruk når forankring støpes.

UK

- ▣ Make sure the area and depth of safer surfacing are according to the current standard, or to the manufacturer's recommendation
- ▣ Make sure all tools and surplus materials are removed before play begins

PS! When complete, allow 2-3 days for the concrete to set before use.

S







- ▣ Kontrollera att fallunderlag är utlagt enligt gällande regler eller vår rekommendation
- ▣ Ta bort alla monteringshjälpmedel (rester av betong, plankor, pallar, plast och liknande)
- ▣ Innan lekredskapet används, kontrollera att anoracksnoddar eller kläder/delar av kläder eller liknande inte kan fastna i några delar på redskapet.

- ▣ OBS! Bör stå i 2-3 dagar innan användning när det gjuts

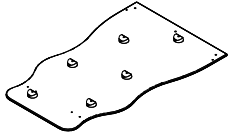
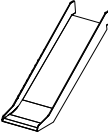
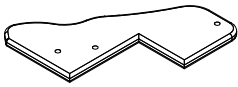
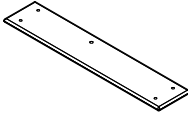
5

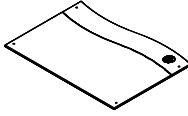
Pakkliste for / Parts list for / Packlista för :
12-100-055

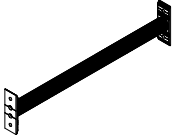
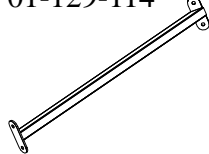

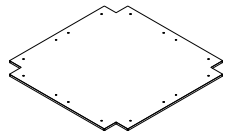
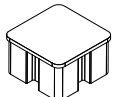







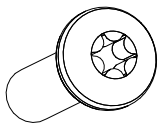
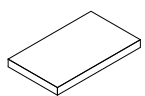
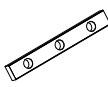



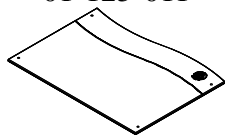

Sign. _____

N UK S	Komponenter	Dimensjon	Ant	Lev	Komponenter	Dimensjon	Ant	Lev
	Components	Dimension	Qty	Lev	Components	Dimension	Qty	Lev
	Komponenter	Dimension	Ant	Lev	Komponenter	Dimension	Ant	Lev
	00-400-013 	2900 x 95 x 95 Med 2 brikker i hver stolpe	4		01-130-112 	1480 x 490 x 15	1	
	40-142-101 	0,5m x 3 m	1		01-129-113 	282 x 263 x 15	2	
	01-450-112 	710 x 145 x 15	4		00-261-520 	520 x 120	1	
	01-125-011 	688 x 638 x 12	2		04-080-004 	490 x 40 x 33	1	
	00-450-155 	520 x 120 x 40	1		01-129-114 	810 x 120 x 40	2	
	00-100-310 	512 x 120	2					
	00-450-305 	740 x 740 x 15	1					
	00-400-998 	55 x 95 x 95	4					
	00-400-997 Med hull		4					22

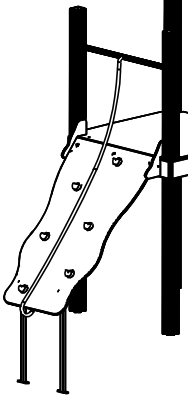
5

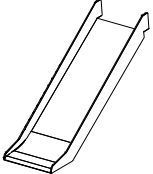
**Pakkliste for / Parts list for / Packlista för :
12-100-055**

Sign. _____

Bolter/skruer Bolts/Screws Komponenter		Dimensjon Dimension Dimension	Ant Qty Ant	Lev Lev	Bolter/skruer Bolts/Screws Bultar/Skruvar		Dimensjon Dimension Dimension	Ant Qty Ant	Lev Lev
	04-000-012 8 x 12 mm Torx	2	16		(N) Produkt merking (UK) Product marking			1	
	04-000-025 8 x 25 mm Torx	8							
04-000-030 8 x 30 mm Torx	2	(N) Avståndskloss (UK) Distance piece (S) Distanskloss				89 mm	2		
04-000-035 8 x 35 mm Torx									
	04-060-120 120 x 15 x 8 mm	4							
	04-040-008 8 mm	2							
	04-075-050 50 x 50 x 5 mm	2							
	04-050-008 8 mm	2							
	04-090-002	7					04-060-120 120 x 15 x 8 mm	2	
	04-030-016 8 x 16 mm	2					04-060-040 40 x 15 x 8 mm	2	
Boltepakker / Boltpackage / Bultpaket									
01-125-011  Antall Number Antal		04-060-040 40 x 15 x 8 mm	4 X 2				04-000-025 8 x 25 mm Torx	5	
		04-000-035 8 x 35 mm Torx	4 X 2				04-000-030 8 x 30 mm Torx	8	
				04-000-035 8 x 35 mm Torx			2		
				04-000-040 8 x 40 mm Torx			3		
				04-000-045 8 x 45 mm Torx			2		
				04-040-008 8 mm			8		
				04-070-035 35 x 35 x 3 mm			2		
				04-030-016 8 x 16 mm			4		
				04-050-008 8 mm			9		
				04-090-001			2		
40-142-101  Antall Number Antal		04-060-160 160 x 15 x 8 mm	2						
		04-000-035 8 x 35 mm Torx	4						
		04-000-045 8 x 45 mm Torx	2						
		04-040-008 8 mm	2						
	Monteringsanvisning Assembly Instructions Monteringsanvisning			1					

5 Pakkliste for / Parts list for / Packlista för :
12-100-055

Sign. _____

Forankring / Foundations / Markförankring

00-003-003

N Er bestilt Ikke bestilt
 UK In order Not in order
 S Beställt Ej beställt

00-400-997



-4

00-003-100 00-003-101 00-003-102	4	04-000-035 8 x 35 mm Torx	12
		04-050-008 8 mm	12
		04-060-120 120 x 15 x 8 mm	8
00-003-103 	0	04-000-040 8 x 40 mm Torx	0
		04-040-008 8 mm	0
		04-050-008 8 mm	0
00-003-105 00-003-106 Eller Or Eller	4	04-010-035 10 x 35 mm	8
		04-040-010 10 mm	8
		04-050-010 10 mm	8