

N

**Monteringsanvisning**

EN

**Assembly Instructions**

S

**Monteringsanvisning**

Produkt nr. / Product no. / Produkt nr.

**14-101-015****Grønn / Grå**

Ord. nr. \_\_\_\_\_

Dato. \_\_\_\_\_

Sign. \_\_\_\_\_

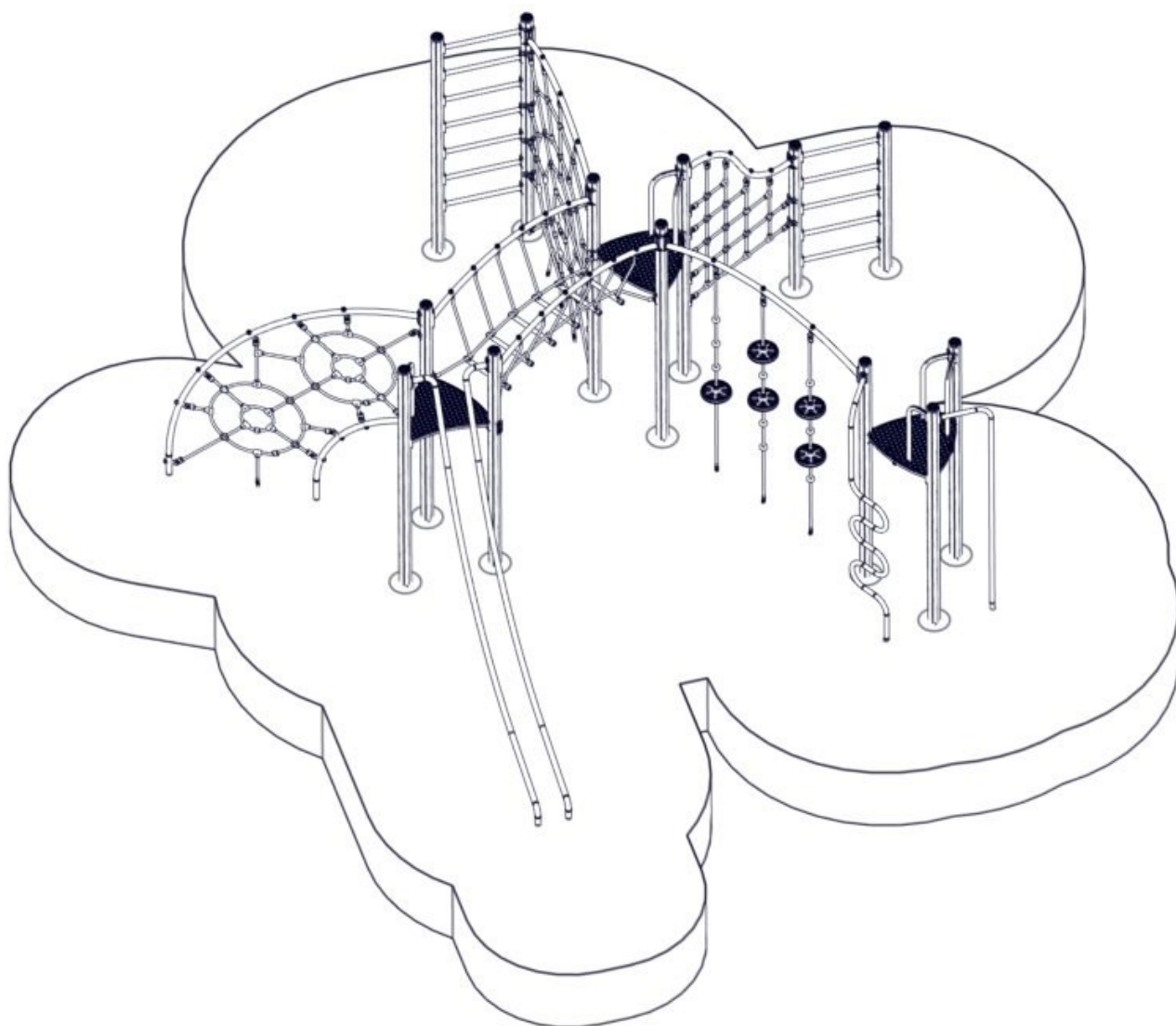
**søve**

Søve AS  
Grønnvoldveien 290  
3830 Ulefoss - Norway  
Tlf: +47 35 94 65 65  
[www.sove.no](http://www.sove.no)

**søve**

Søve AB  
EA Rosengrensgatan 32  
421 31 Västra Frölunda  
Phone: +46 (0)31 773 97 00  
[www.sove.se](http://www.sove.se)

**Monteringstips / Assembly Advice / Monteringsstips****N**

- Les monteringsanvisningen nøye før montering.
- Monter elementene i rekkefølgen som vist.
- Boltene bør ikke skrues for hardt til før alt er montert, vatret og loddet. Skru så boltene til.
- NB! Ved bruk av drill, kan boltene ryke.
- På grunn av at solen kan gjøre rutsjeflaten veldig varm, bør rutsjebanens utløp vende mot nord-øst eller nord-vest.
- Er lekeutstyret plassert i naturlige ferdselstraséer må området sikres mot gjennomgang.
- Innspringningshinder bør vurderes rundt lekeapparater hvor det er stor bevegelse, f.eks. ved huskestativ.
- Det bør være fritt innsyn til lekeutstyr som er beregnet for barn under 3 år.

**NB! Under monteringsarbeidet må utstyr, som ikke er forankret forsvarlig i bakken, sikres slik at det ikke velte. Området må avstenges under montering av apparatene med sperrebånd eller lignende.**

**EN**

- Read the instruction carefully before assembling the play unit.
- Assemble the components in the sequence shown in these instructions. Fixings must not be fully tightened during assembly. Before casting the foundations, the structure must be level and plumb, at which point all fixings are tightened. PS! If use of drill, the bolts may be wrecked.
- Avoid positioning the slide facing due south because of overheating – ideal positions are facing north-east or north-west. Secure the construction-area to prevent people from walking through it.
- Consider installing barriers around play-equipment which gives rise to a lot of activity – i.e. swings.
- Ensure that clear vision is possible across the play area so that supervision is possible from any position, particularly where children under 3 years of age will be playing.

**NB! During assembly of the equipment, ensure that all structures are securely propped, especially when left overnight. Also ensure that equipment is supported**

**Monteringstips / Assembly Advice / Monteringsstips****S**

- Läs monteringsanvisningen noga före montering.

- Montera delarna i den ordningen som anvisas
- Skruvarna bör inte skruvas för hårt tills allt är monterat, i våg och lodat.









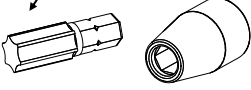

OBS! Används elektrisk skruvdragare, kan bulten gå sönder. Hårdra därför manuellt!

- Solen kan göra att rutchbanan blir väldigt varm. Banans nedfart rekommenderas att vändas i norrlig riktning
- Om lekplatsen placeras vid en gångväg mm bör området säkras mot genomfart av gående och cyklister.
- Inspringningshinder bör placeras runt lekutrustning med stor rörelse, t ex, gungställning.
- Det bör vara fri insyn till lekutrustning beräknat till barn under 3 år.

**OBS! Under monteringsarbete bör utrustningen som inte ska förankras i marken, ställs så att den inte kan välta.**

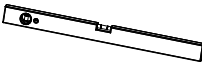
**Området måste spärras när lekutrustningen byggs upp, med avspärrningsband eller liknande.**

**Nødvendig verktøy / Tools required / Nödvändiga verktyg**

<p>(N)</p> <p>(EN)</p> <p>(S)</p>	<p>(A)</p> 	<p>(B)</p>  <p>Torx Nr 45 High quality</p> 	<p>(C)</p>  <p>13 + 17mm</p> 	<p>(D)</p> 	<p>(E)</p> 
		<p>Metermål</p> <p>Metric measure</p> <p>Tumstock</p> 	<p>16 V</p> 	<p>Merkebånd</p> <p>Mark ribbon</p> <p>Märkeband</p> 	<p>5 mm</p> <p>6 mm</p> 

**Nødvendig antall personer / Number of persons required / Rekommenderad antal personer**





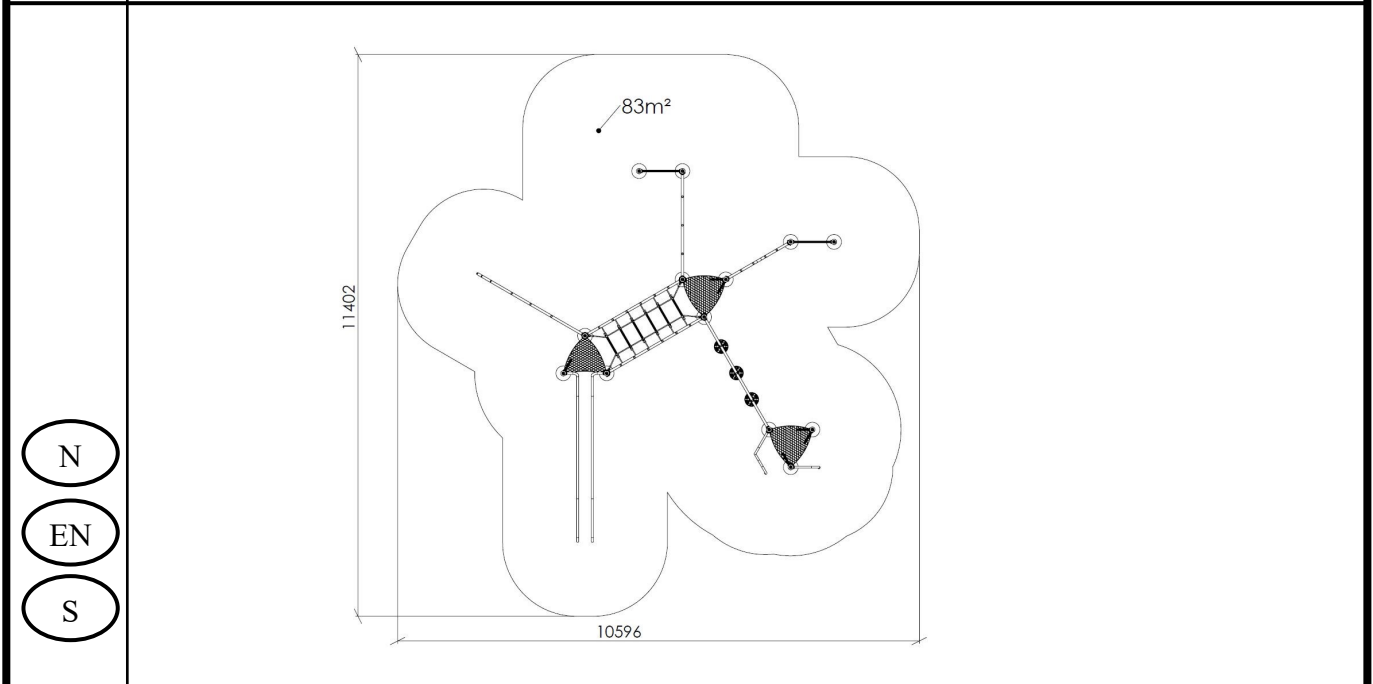

**Anbefalt arealbehov ved montering / Recommended working space / Rekommenderad arealbehov vid montering**



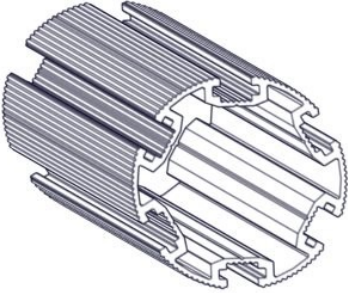
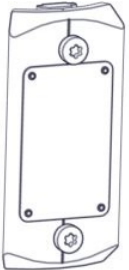

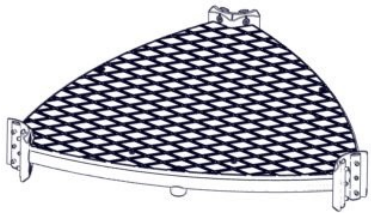
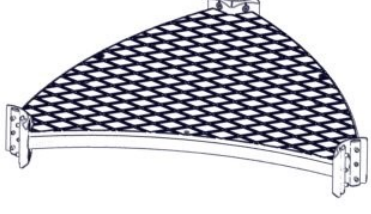

**Boltepakker for / Boltpackage for / Bultpaket för**

Sign. \_\_\_\_\_

Adventure Ormtjern 14-101-015	Navn	Artnr/dimensjon	Ant	Lev
	Stolpe Ø110 L=3450 Grå  Stolpe Ø110 L=2500 Grå	SFA5126/2  SFA5126/2	11  2	
	Produktmerke 14-100-015	07-500-500 (se egen delmontering)	1	
	Endelokk til Ø110 stolpe	00-400-995	13	
	Gulv 3-kant standard CC880 Grå	07-300-104K (se egen delmontering)	2	
	Gulv 3-kant 1konkav CC880 Grå	07-300-105K (se egen delmontering)	1	
	Sperrerør rett L=750 Uten hull Grønn	07-500-059K (se egen delmontering)	12	

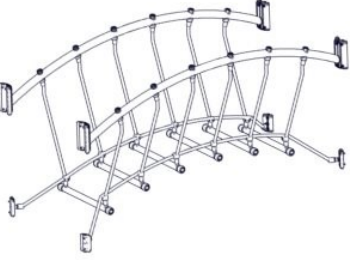
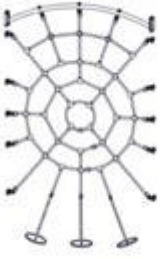

**Boltepakker for / Boltpackage for / Bultpaket för**

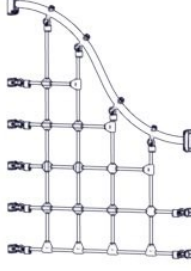

Sign. \_\_\_\_\_

Adventure Ormtjern 14-101-015	Navn	Artnr/dimensjon	Ant	Lev
	Sluse H=790 Grønn	07-500-074K (se egen delmontering)	6	
	Monkeyseats x3 Grønn	07-500-122K (se egen delmontering)	1	
	Trapez bro Grønn	07-500-011K (se egen delmontering)	1	
	Edderkoppnett 30gr Grønn	07-500-032K (se egen delmontering)	1	
	Slider komplett	07-200-010K (se egen delmontering)	1	
	S-nett Grønn	07-500-021K (se egen delmontering)	1	

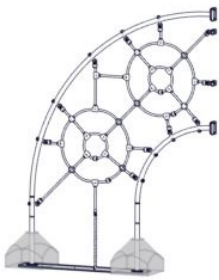

**Boltepakker for / Boltpackage for / Bultpaket för**

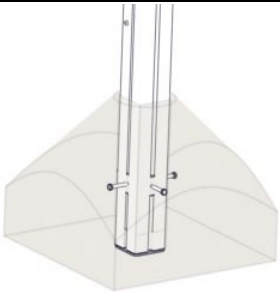
Sign. \_\_\_\_\_.

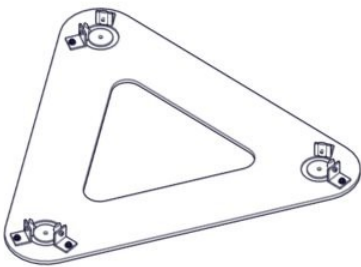
Adventure Ormtjern 14-101-015	Navn	Artnr/dimensjon	Ant	Lev
	Edderkoppnett dobbelt 30gr Grønn	07-500-028K (se egen delmontering)	1	
	Brannstang Grå	07-200-037K (se egen delmontering)	1	
	Klatrestang Grå	07-200-038K (se egen delmontering)	1	

<b>Boltepakker for / Boltpackage for / Bultpaket för</b>		Sign. _____		
<b>Adventure Ormtjern 14-101-015</b>	<b>Navn</b>	<b>Artnr/ dimensjon</b>	<b>Ant</b>	<b>Lev</b>
	<b>Fundament Støp</b>			
	Støpefundament stolpe Ø110	00-003-111K (se egen delmontering)	13	
	<b>Fundament Nedgraving</b>			
	Fundamentplate 2xØ110 stolpe	07-400-102K (se egen delmontering)	2	
	Fundamentplate 3xØ110 stolpe	07-400-103K (se egen delmontering)	3	



<b>Boltepakker for / Boltpackage for / Bultpaket för</b>		Sign. _____		
<b>Adventure Ormtjern 14-101-015</b>	<b>Navn</b>	<b>Artnr/ dimensjon</b>	<b>Ant</b>	<b>Lev</b>
	<b>Overflatemon- tering</b>			
	Fundament 2xØ110 stolpe for betongdekke	00-003-114K (Se egen delmontering)	2	
	Fundament 3x110 stolpe for betongdekke	00-003-115K (Se egen delmontering)	3	
	Slider kappes Brannstang kappes Klatrestang kappes Edderkoppnett kappes	07-200-010K 07-200-037K 07-200-038K 07-500-028K	(1) (1) (1) (1)	
	Stolpe Ø110 må kappes	SFA5126/1	(8)	
	Bruk kortere bolter når nett skal monteres.	04-000-016	4	

**Fundamentering med betong // Foundation concrete // Förankring med betong**

- (N) Støtdempende materialer
- (EN) Impact attenuating materials
- (S) Støtdämpande material Ref NS-EN 1176-1 §4.2.8.5

- (N) Bakkenivå
- (EN) Ground level
- (S) Marknivå

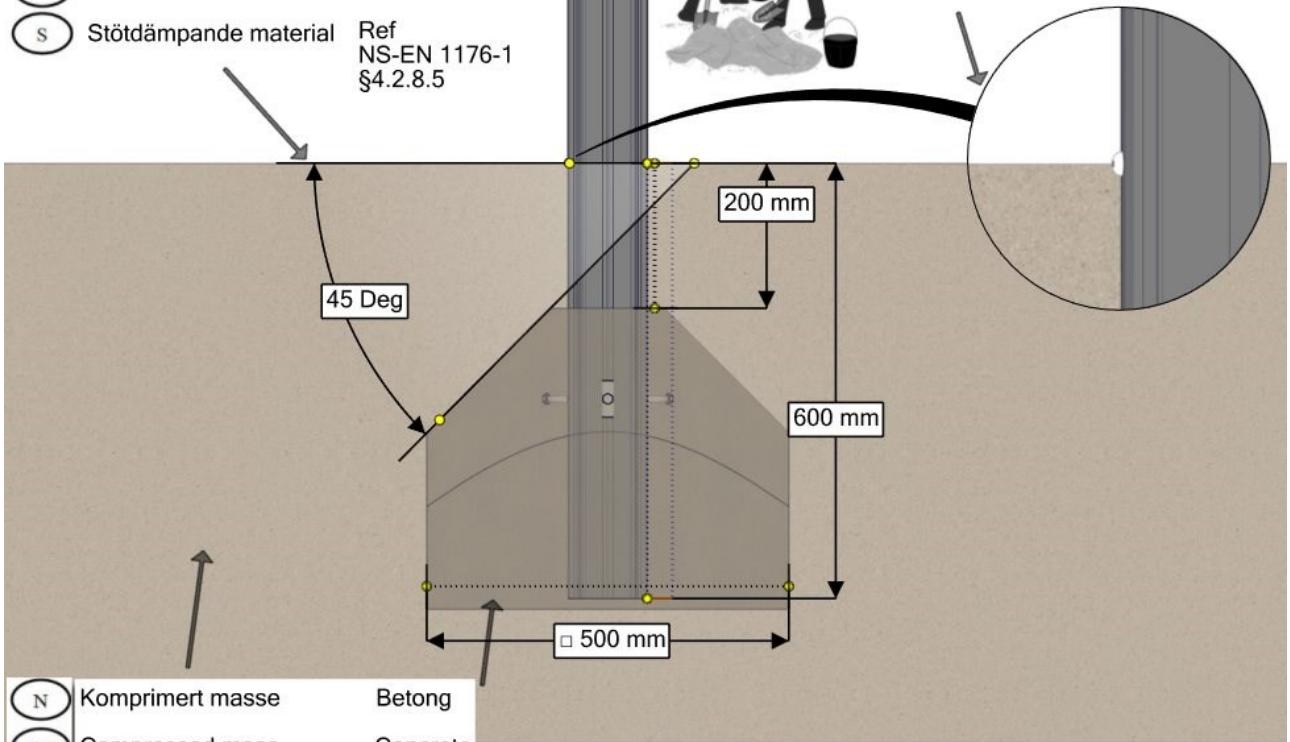

- (N) Komprimert masse Betong
- (EN) Compressed mass Concrete
- (S) Komprimerad massa Betong

**Fundamentering uten betong // Foundation without concrete // Förankring utan betong**

- (N) Støtdempende materialer
- (EN) Impact attenuating materials Ref NS-EN 1176-1 §4.2.8.5
- (S) Støtdämpande material

- (N) Bakkenivå
- (EN) Ground level
- (S) marknivå

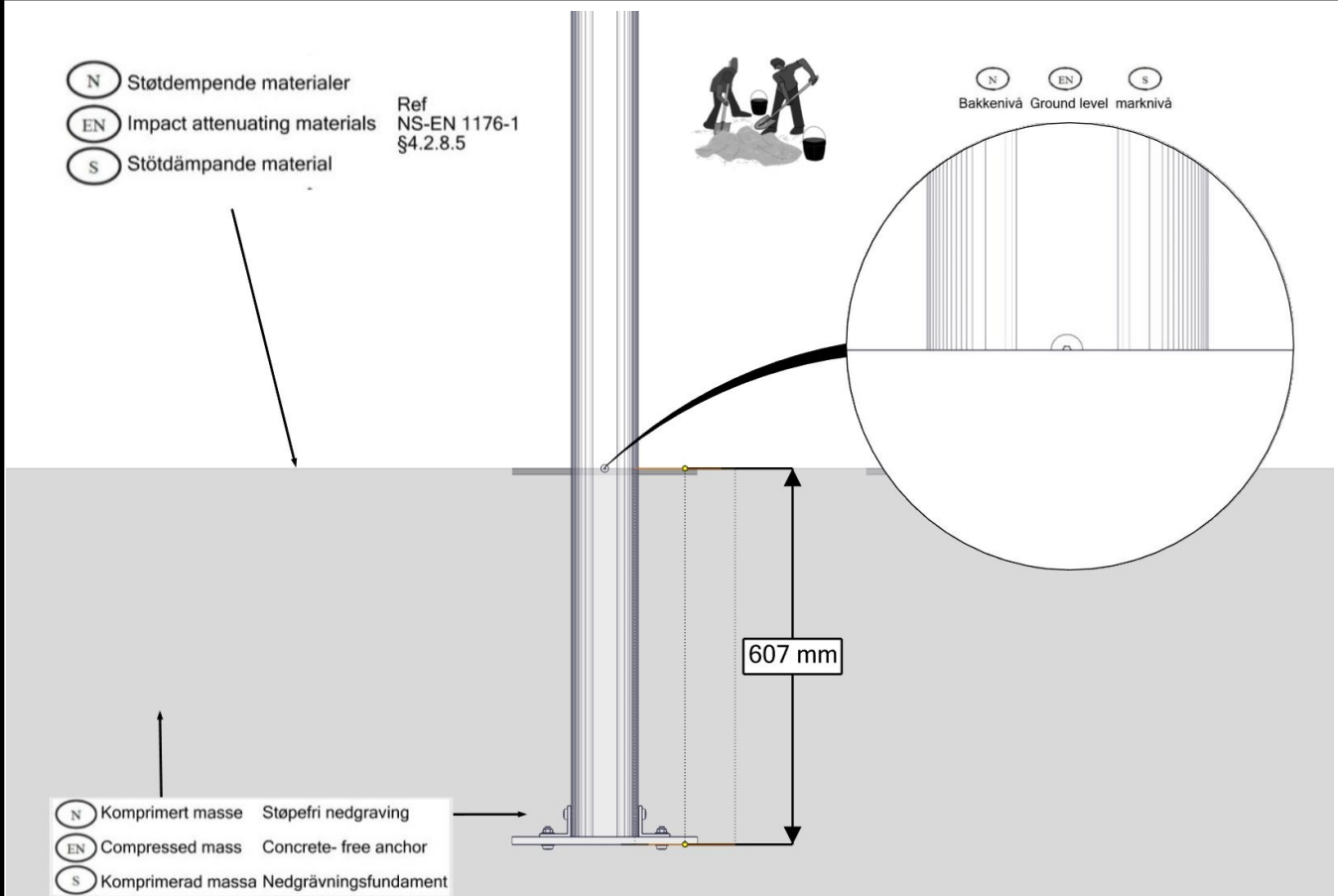

- (N) Komprimert masse Støpefri nedgraving
- (EN) Compressed mass Concrete-free anchor
- (S) Komprimerad massa Nedgravningsfundament

**Fundamentering overflate / Foundation surface / Förankring grundytan**

Ref.  
NS-EN 1176-1  
§4.2.8.5

(N) (EN) (S)  
Bakkenivå Ground level marknivå

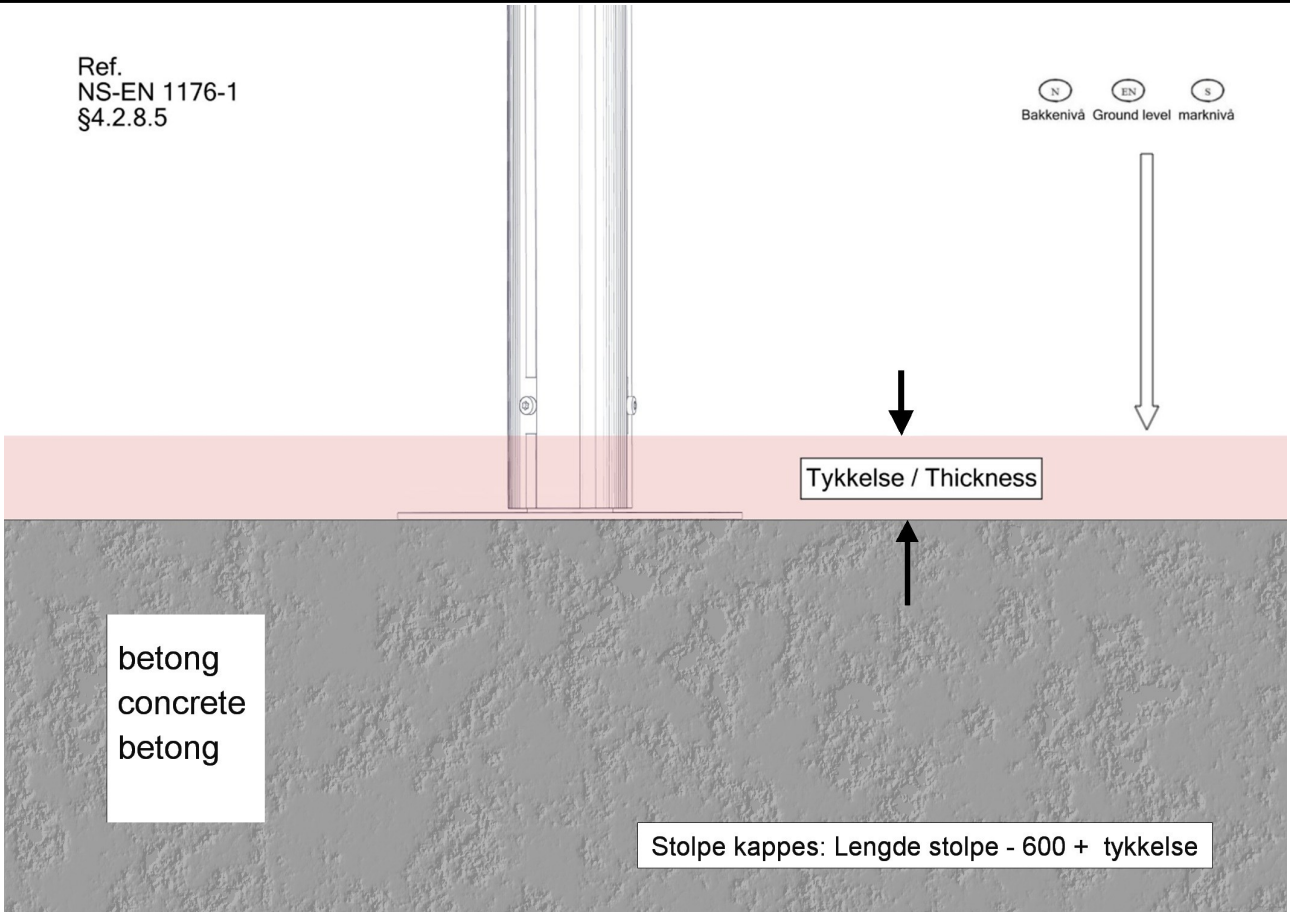

Når du har overfalte monteringsfundamenter bruk korte skurer på nedeste festepunkter.

If you are using 0-level anchors use short bolt for mounting lower parts

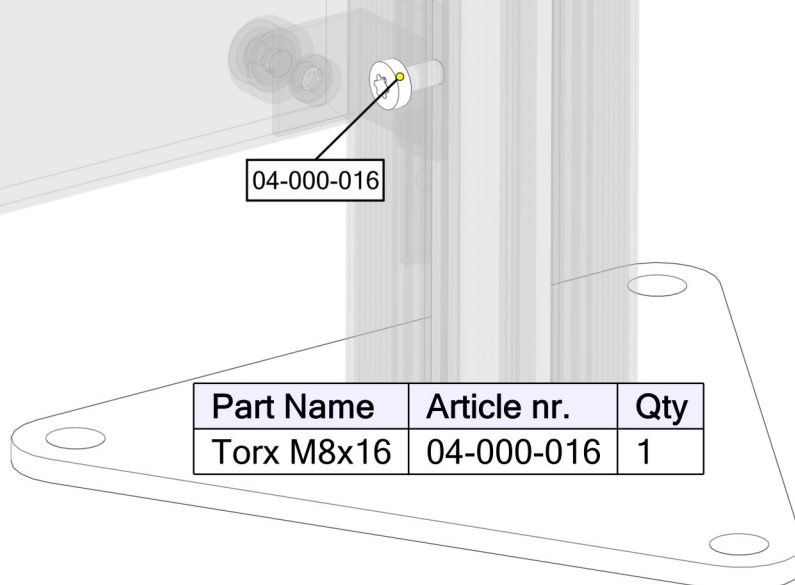

04-000-016

Part Name	Article nr.	Qty
Torx M8x16	04-000-016	1

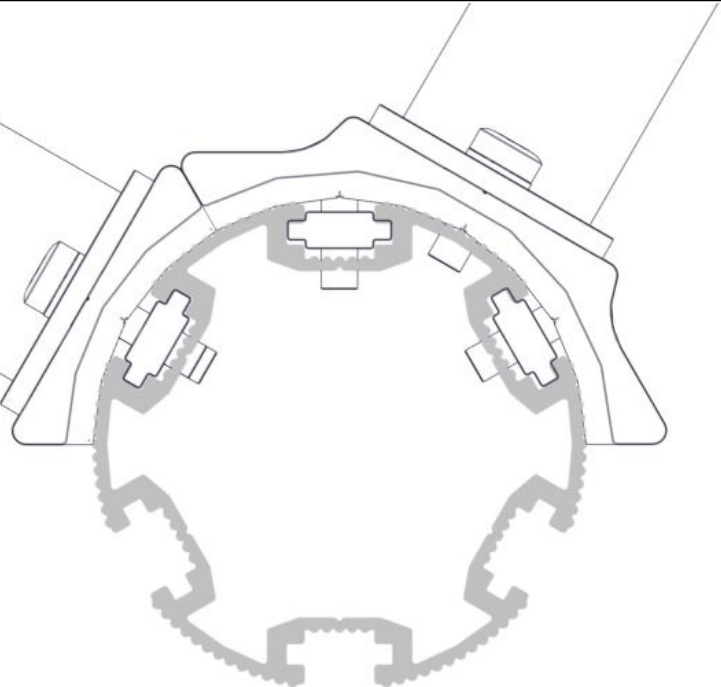

**N** Bolten skrues HELT igjennom aluminiumen. Maks dreiemoment: 30Nm

**EN** The bolt must be tightened in to the post, so that it peirces the aluminium Max torque: 30Nm

**S** Bulten skruvas HELT ignom aluminiumen. Maks vridmoment: 30Nm

NO	Betongkvalitet	C25/30		
SE	Betongkvalitet			
EN	Concrete quality			
NO	Mengde betong		1,5	m <sup>3</sup>
SE	Mängd betong			
EN	Amount of concrete			
NO	Fundament størrelse		0,5 x 0,5 x 0,4	m
SE	Stiftelsestorlek			
EN	Foundation size			
NO	For sikkerhet må fundamentene med sand eller myk jord være minst 50% større i areal			
SE	För säkerheten måste grunden med sand eller mjuk jord vara minst 50% större i området			
EN	For safety, the foundations with sand or soft soil must be at least 50% larger in area			
NO	Tyngste element	07-200-010	18	Kg
SE	Tyngsta element			
EN	Heaviest element			
NO	Største element	07-200-010 07-200-034	4,85x0,72x0,25 4,18x1,06x0,06	m
SE	Största element			
EN	Biggest element			

### Fallhøyder / Free height of fall / Fallhöjder

Fallhøyde = 3 meter

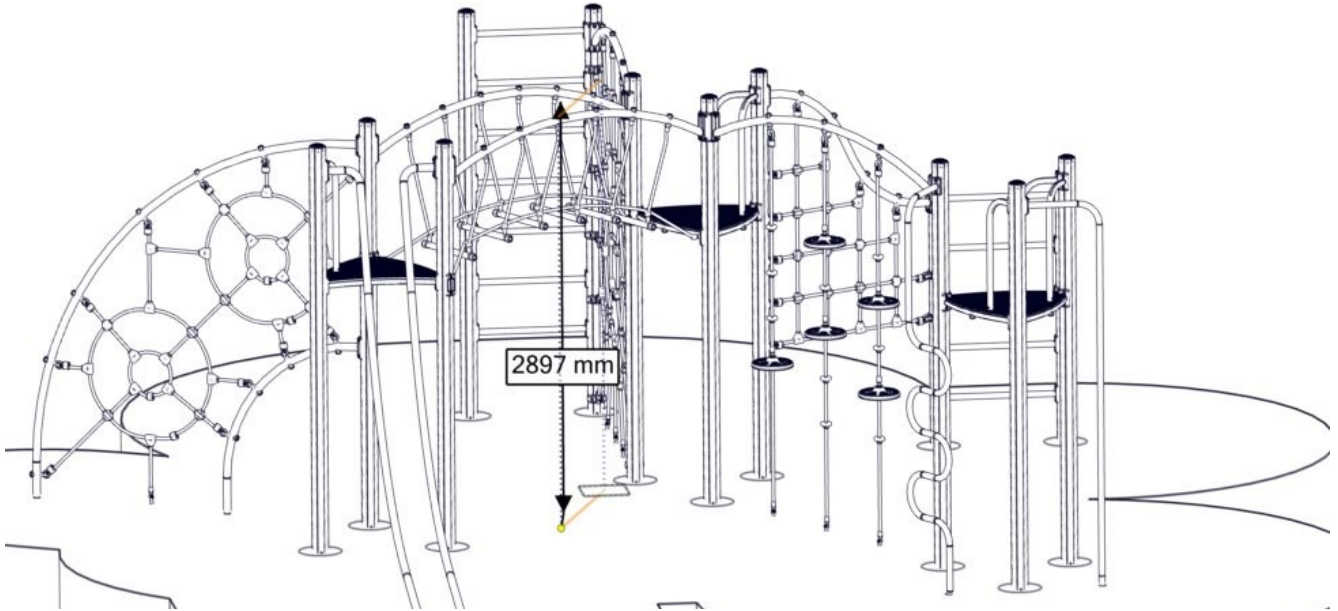

### Sikkerhetszone / Safety zone / Säkerhetszon

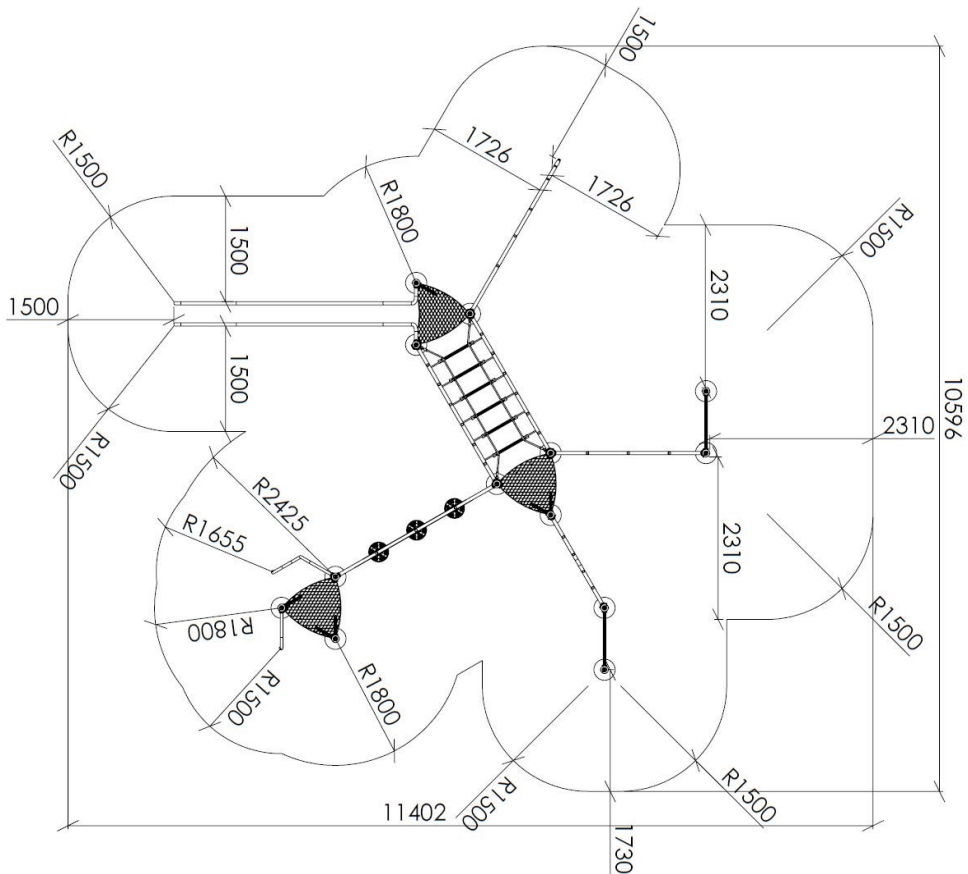

**Plassering av forankringer / Ground plan / Placering av förankringar**

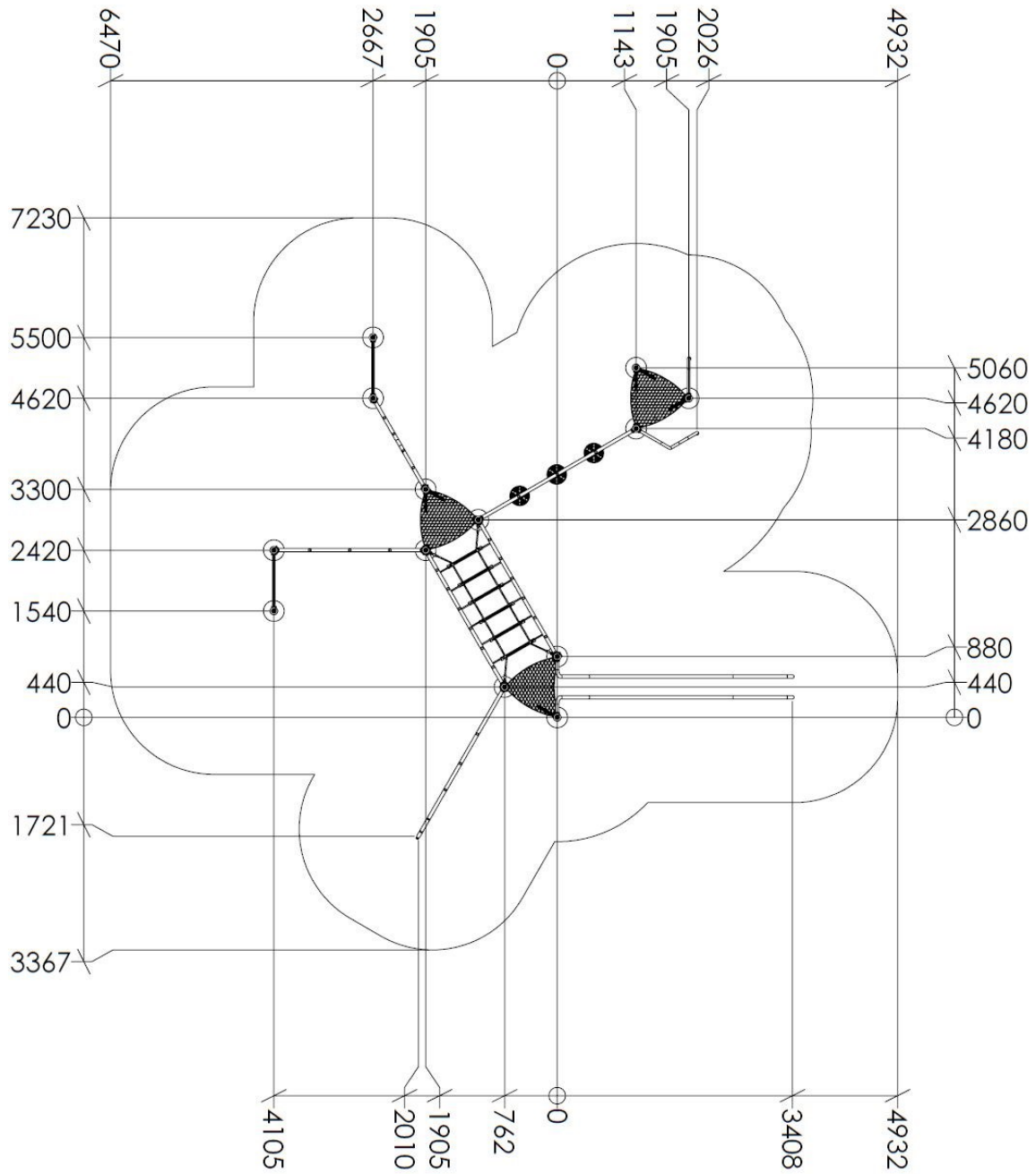

N

Alle mål er oppgitt i millimeter

EN

Scale measured in mm

S

Alla mått är i millimeter.

## Montering av lekeapparatet / Assembly instructions / Montering av lekredskapet

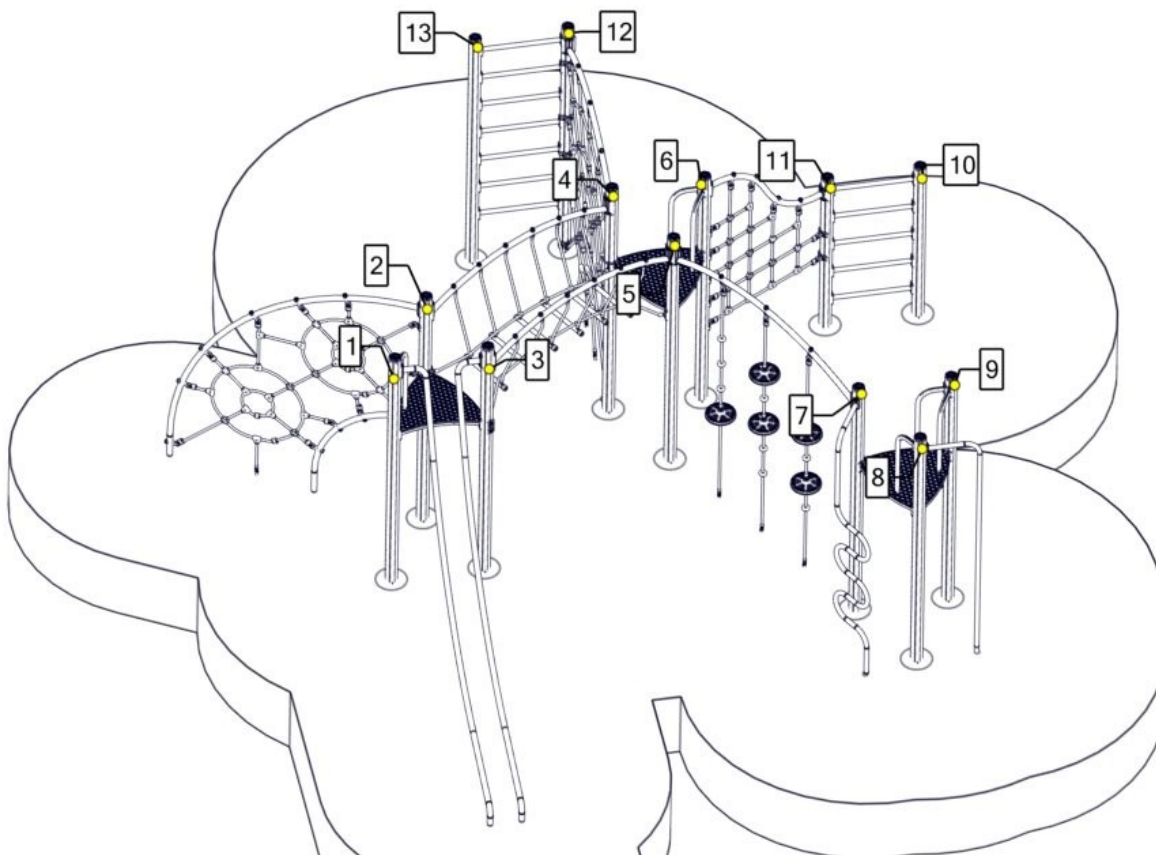

Se separat delmontering for detaljer  
 See separate assembly for details  
 Se separata delmontering för detaljer

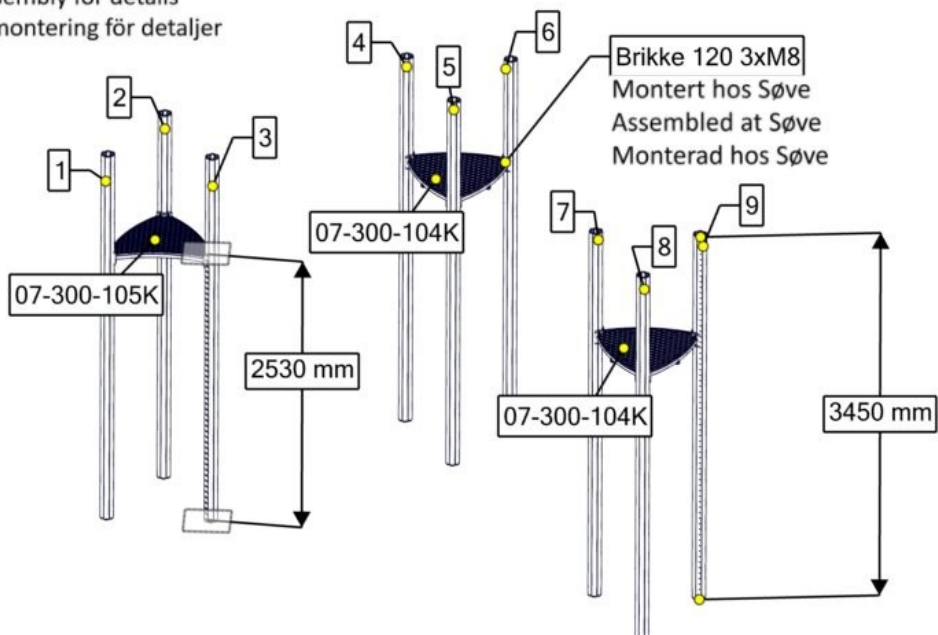

nr	PartName	Artnr	Antall
1	Gulv 3-kant 880x880 STD komplett	07-300-104K	2
2	Gulv 3-kant 880x880 1Konkav komplett	07-300-105K	1

Se separat delmontering for detaljer  
 See separate assembly for details  
 Se separata delmontering för detaljer

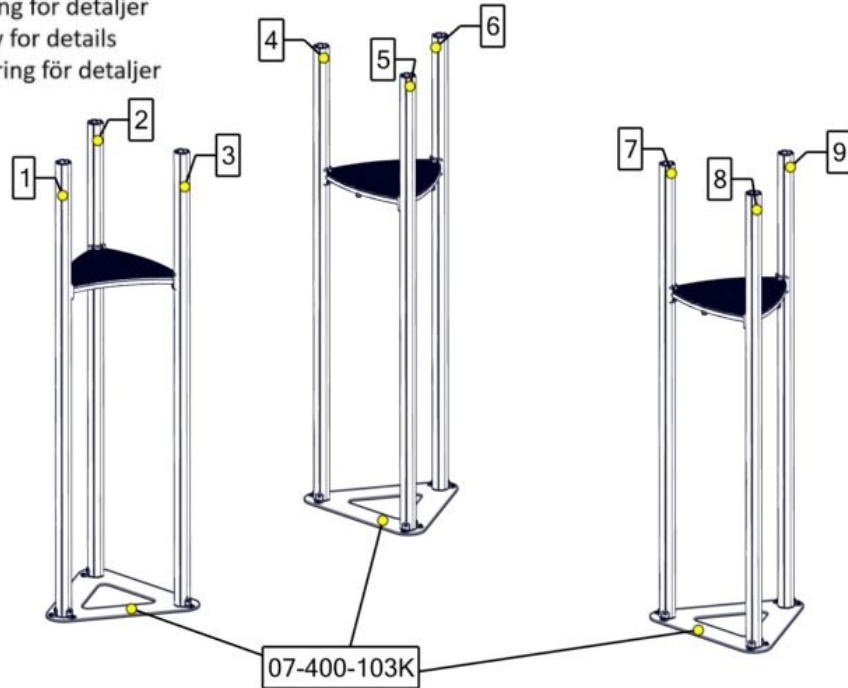

nr	PartName	Artnr	Antall
1	Fundamentplater 3x110 stolpe komplett	07-400-103K	3

Se separat delmontering for detaljer  
 See separate assembly for details  
 Se separata delmontering för detaljer

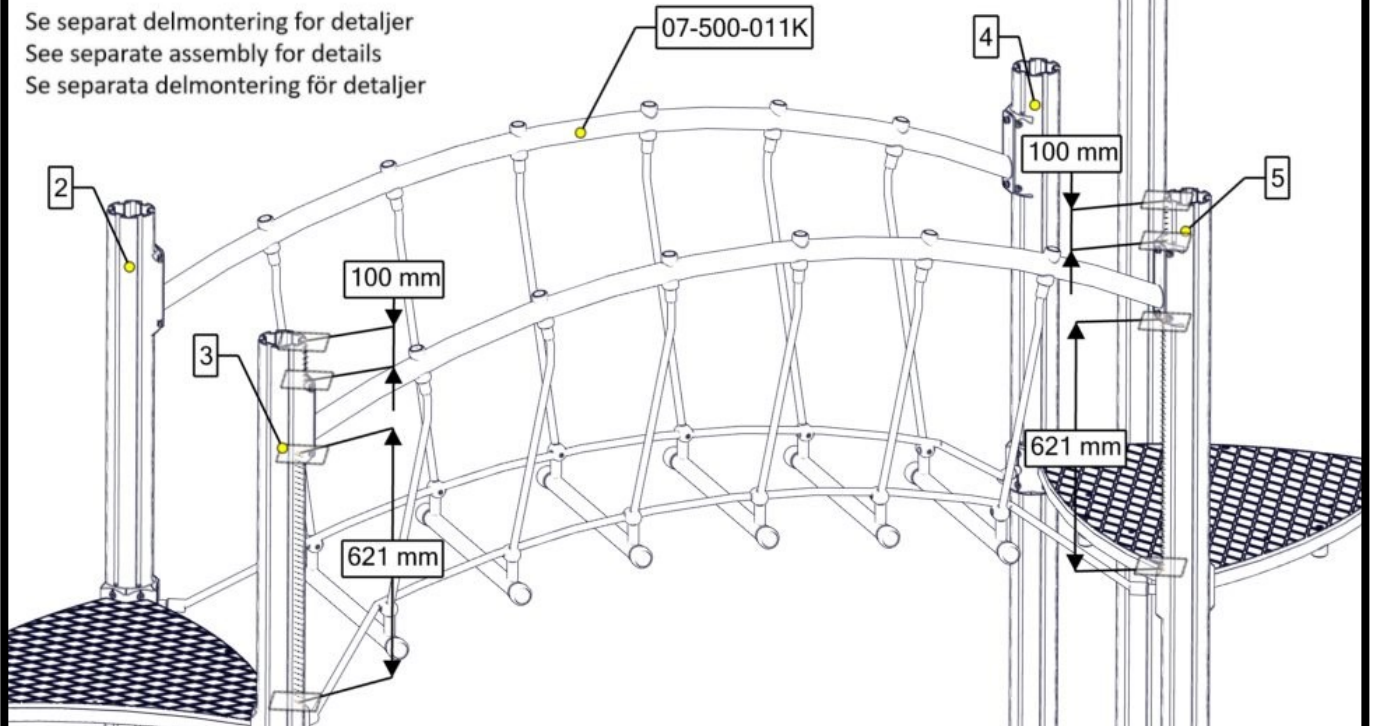

nr	PartName	Artnr	Antall
1	Trapes bro komplett med rør	07-500-011K	1



Se separat delmontering for detaljer  
 See separate assembly for details  
 Se separata delmontering för detaljer

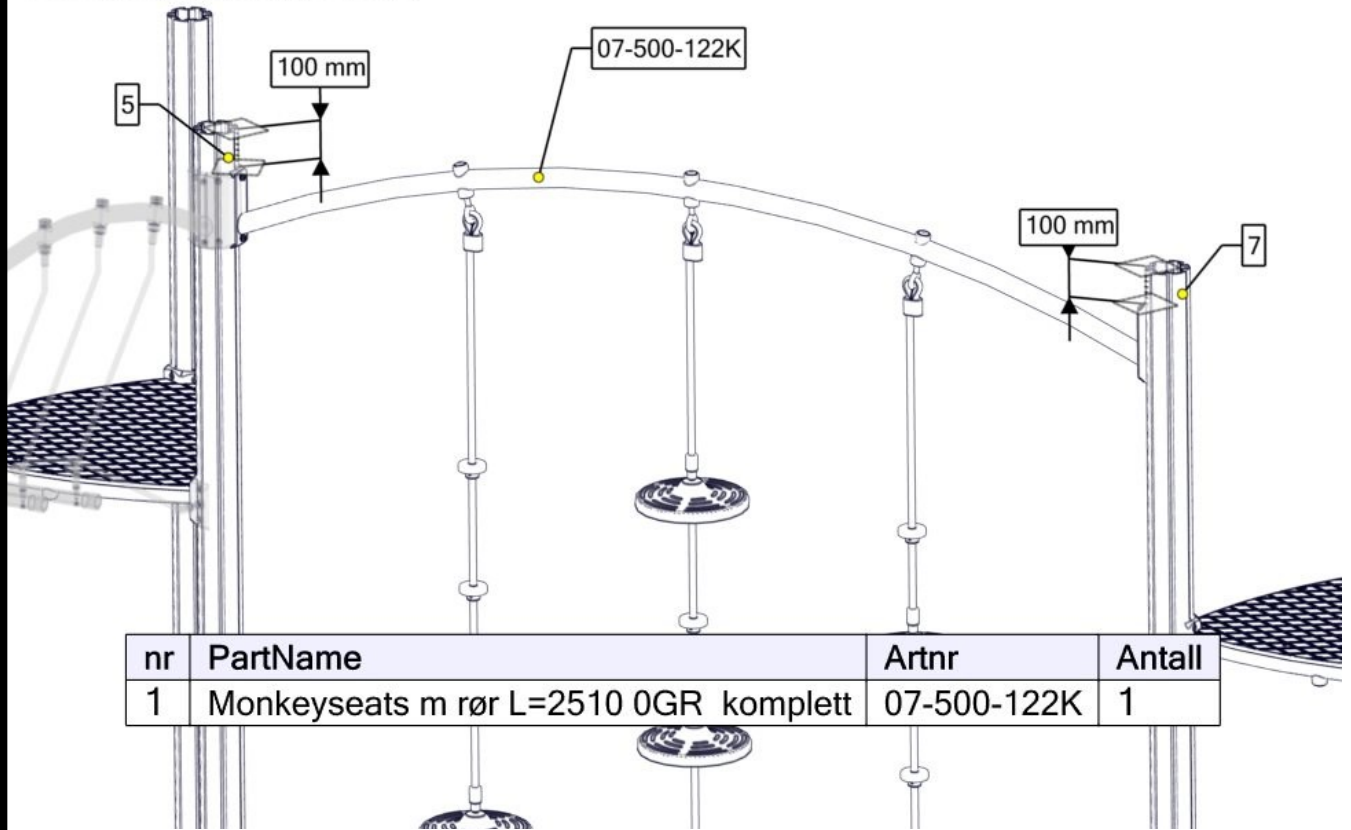

nr	PartName	Artnr	Antall
1	Monkeyseats m rør L=2510 0GR komplett	07-500-122K	1

Se separat delmontering for detaljer  
 See separate assembly for details  
 Se separata delmontering för detaljer

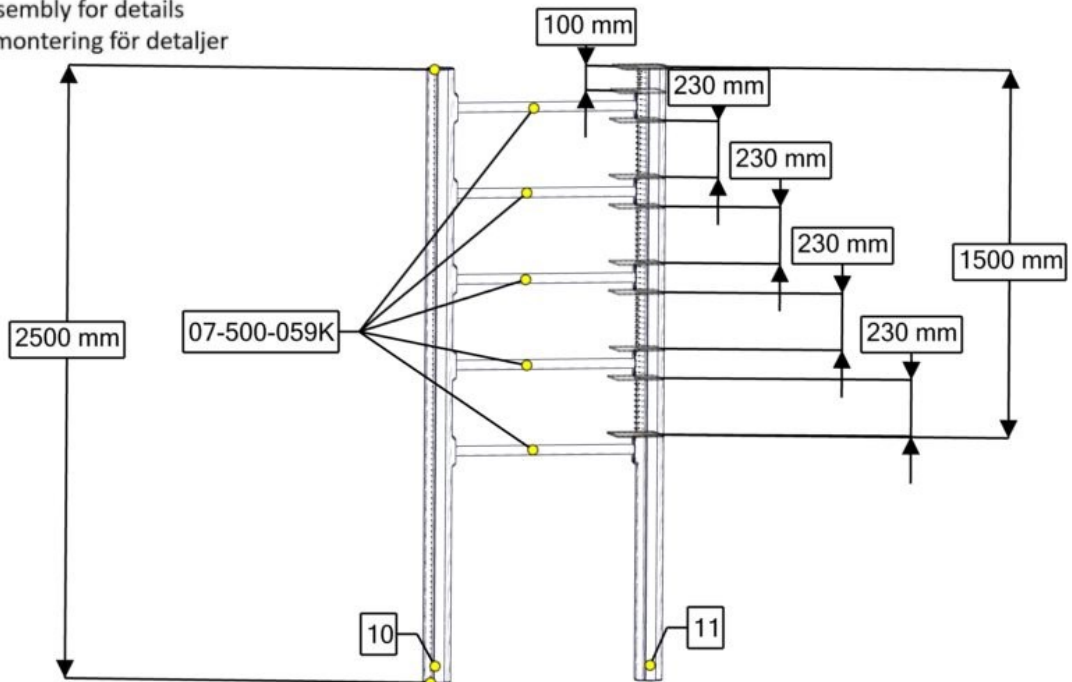

nr	PartName	Artnr	Antall
6	Sperrerør rett L=750 uten hull	07-500-059K	5

Se separat delmontering for detaljer  
 See separate assembly for details  
 Se separata delmontering för detaljer

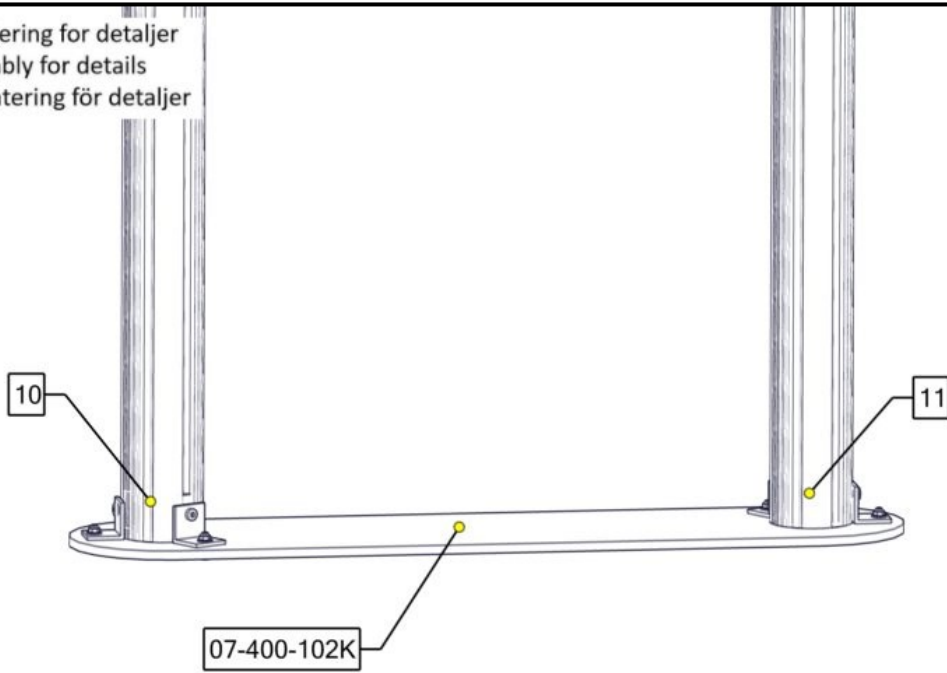

nr	PartName	Artnr	Antall
1	Fundament 2xØ110 stolpe	07-400-102K	1

Se separat delmontering for detaljer  
 See separate assembly for details  
 Se separata delmontering för detaljer

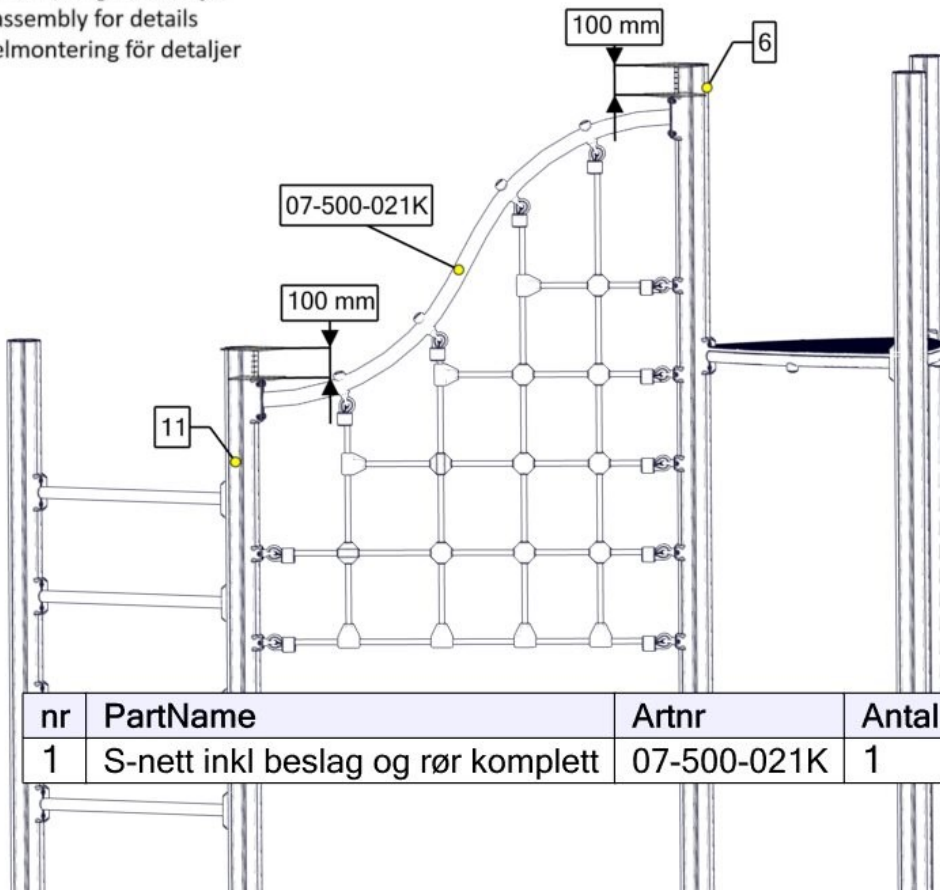

nr	PartName	Artnr	Antall
1	S-nett inkl beslag og rør komplett	07-500-021K	1

Se separat delmontering for detaljer  
 See separate assembly for details  
 Se separata delmontering för detaljer

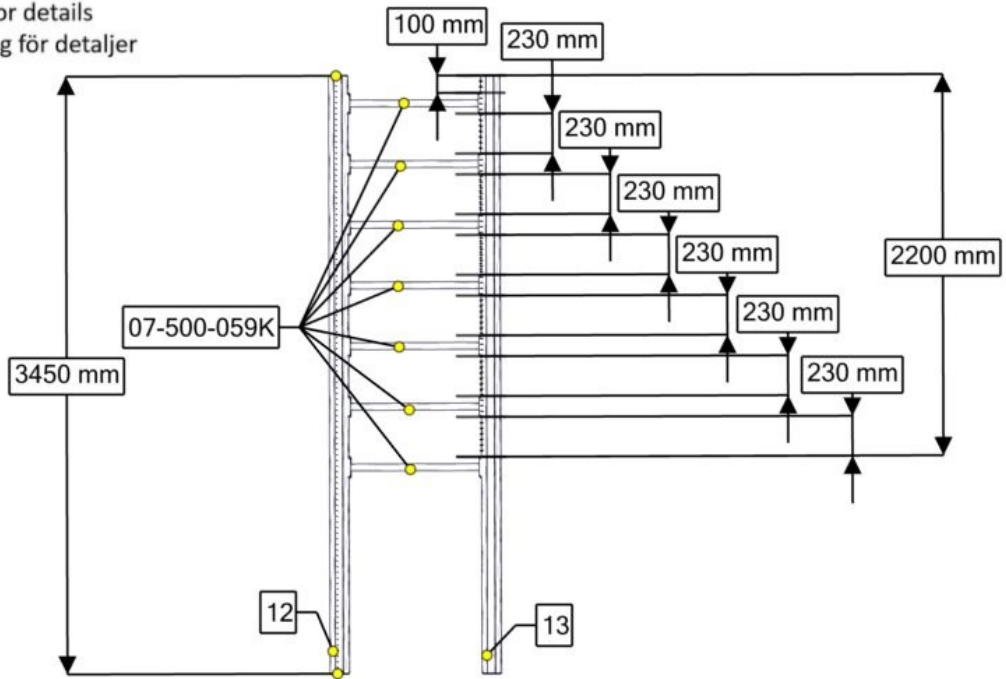

nr	PartName	Artnr	Antall
1	Sperrerør rett L=750 uten hull	07-500-059K	7

Se separat delmontering for detaljer  
 See separate assembly for details  
 Se separata delmontering för detaljer

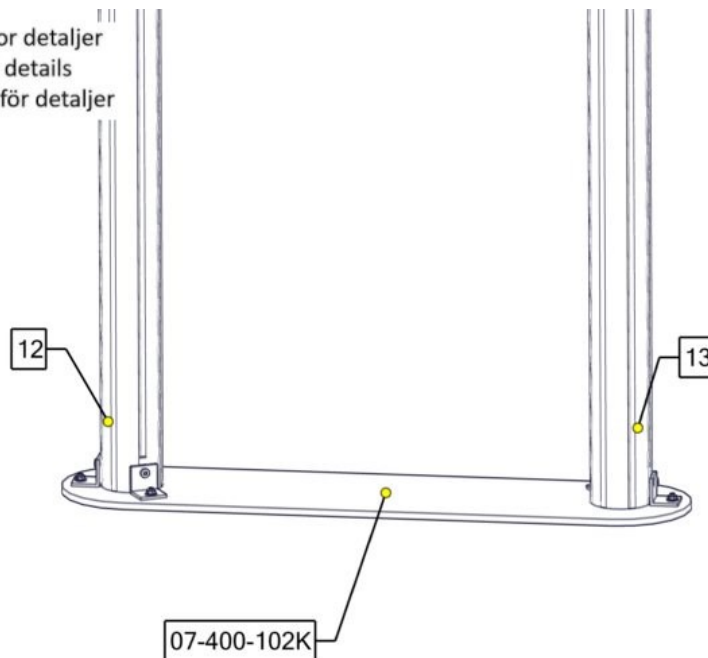

nr	PartName	Artnr	Antall
1	Fundament 2xØ110 stolpe	07-400-102K	1

Se separat delmontering for detaljer  
 See separate assembly for details  
 Se separata delmontering för detaljer

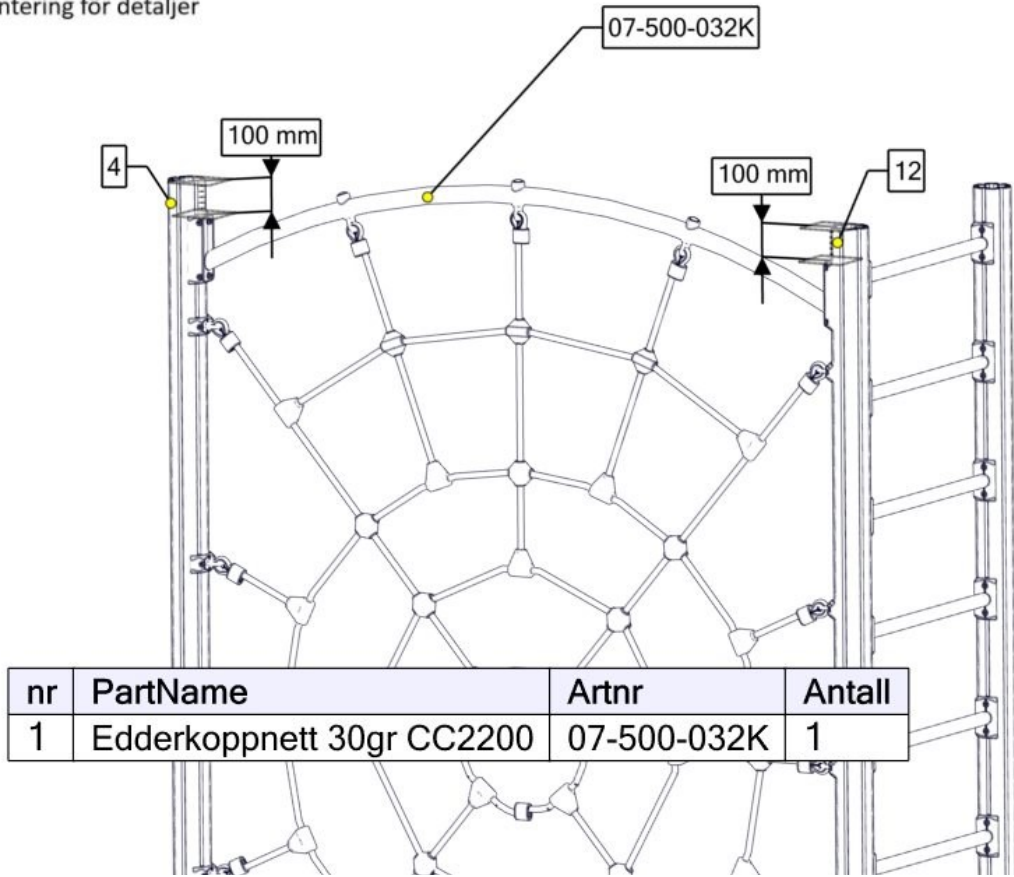

Se separat delmontering for detaljer  
 See separate assembly for details  
 Se separata delmontering för detaljer

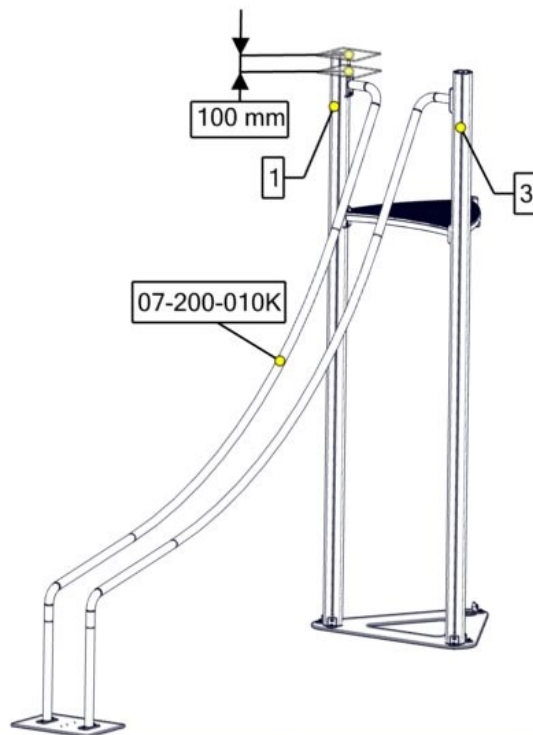

nr	PartName	Artnr	Antall
1	Slider rør 2 stk komplett	07-200-010K	1

Se separat delmontering for detaljer  
 See separate assembly for details  
 Se separata delmontering för detaljer

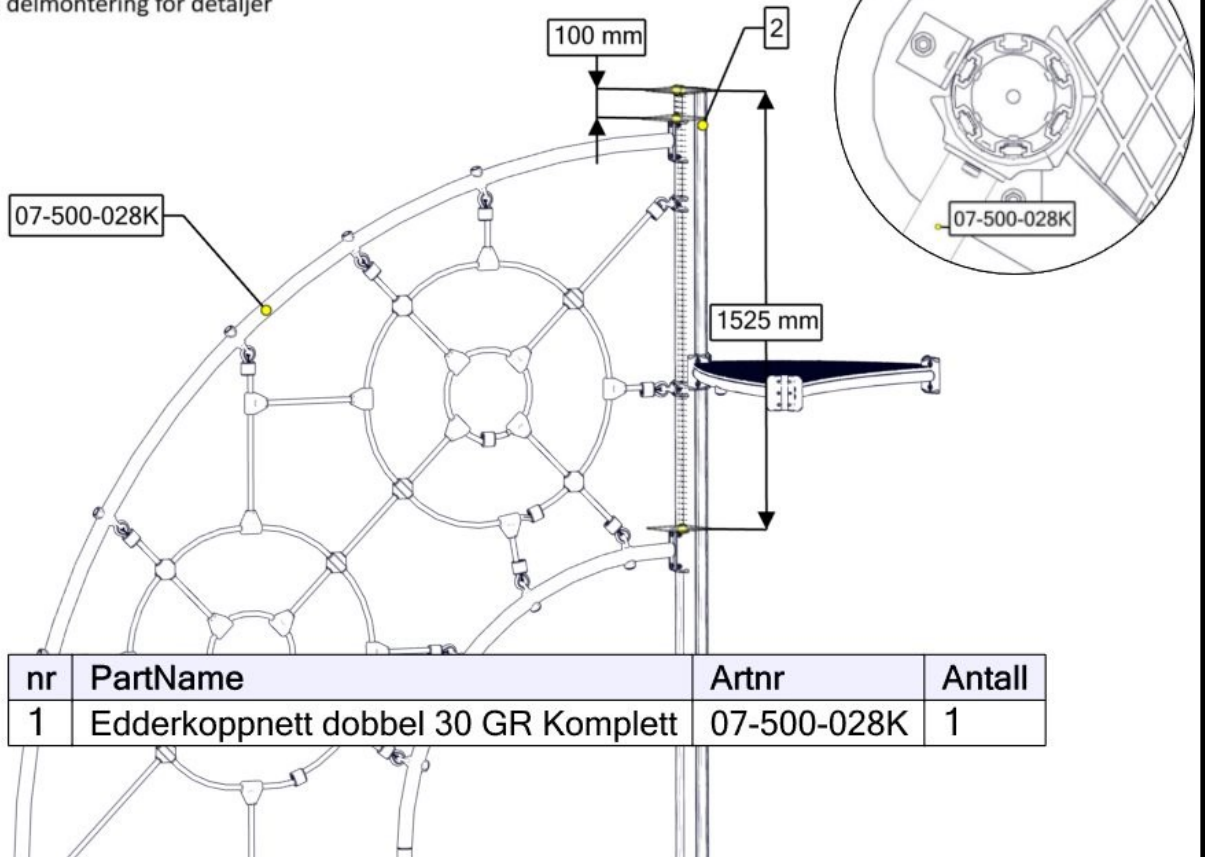

nr	PartName	Artnr	Antall
1	Edderkoppnett dobbel 30 GR Komplett	07-500-028K	1

Se separat delmontering for detaljer  
 See separate assembly for details  
 Se separata delmontering för detaljer

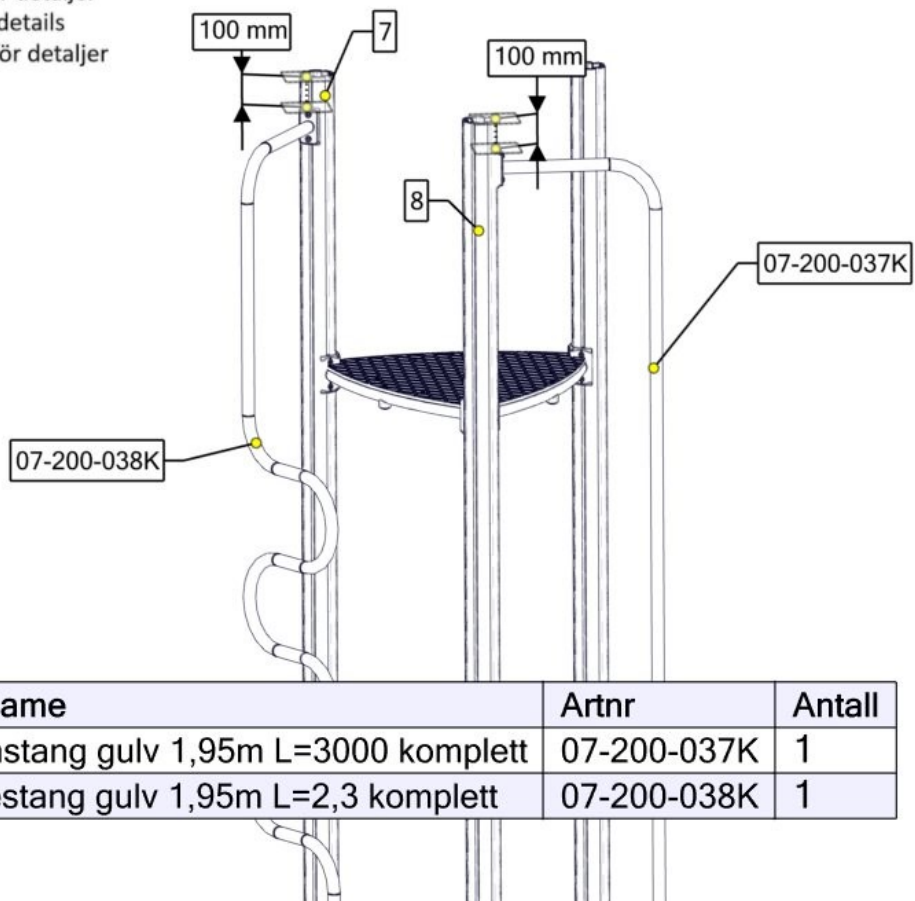

nr	PartName	Artnr	Antall
1	Brannstang gulv 1,95m L=3000 komplett	07-200-037K	1
2	Klatrestang gulv 1,95m L=2,3 komplett	07-200-038K	1

Se separat delmontering for detaljer  
 See separate assembly for details  
 Se separata delmontering för detaljer

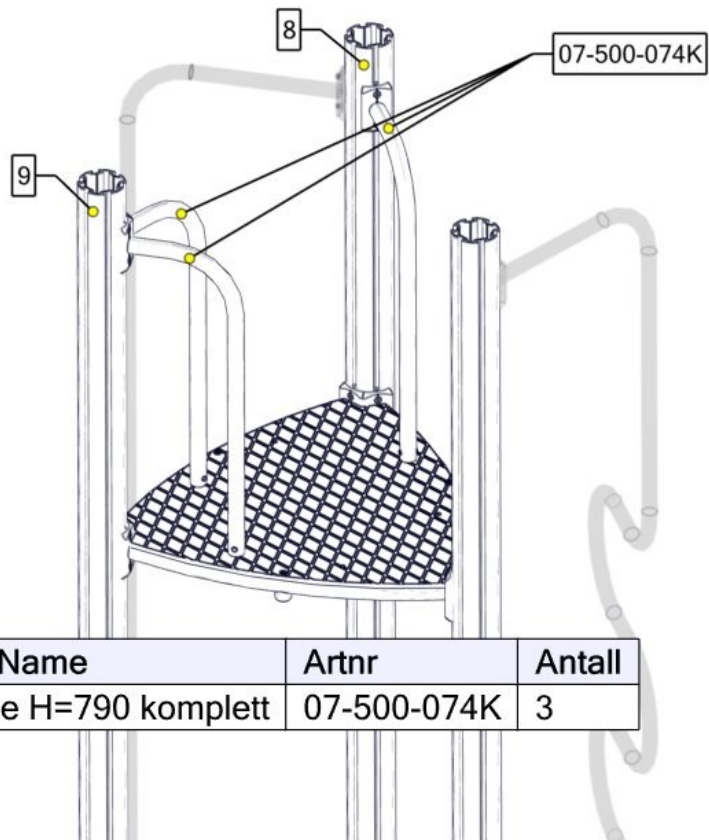

Se separat delmontering for detaljer  
 See separate assembly for details  
 Se separata delmontering för detaljer

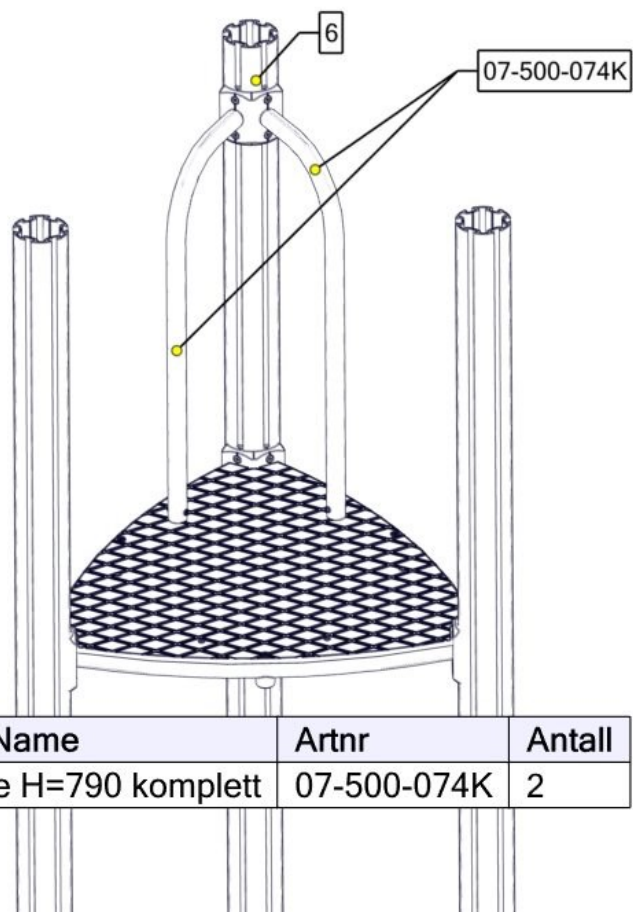

Se separat delmontering for detaljer  
 See separate assembly for details  
 Se separata delmontering för detaljer

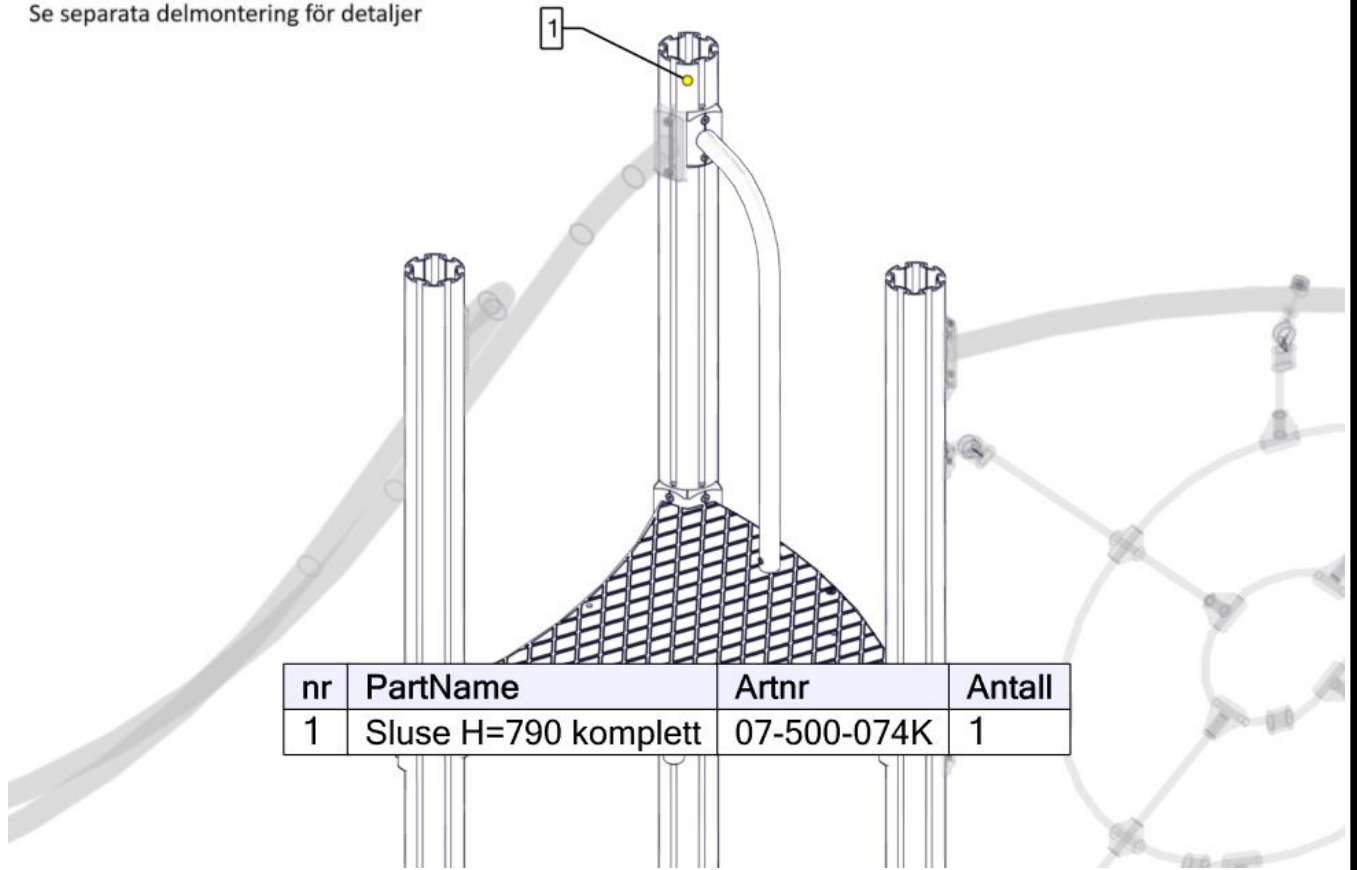

nr	PartName	Artnr	Antall
1	Sluse H=790 komplett	07-500-074K	1

Se separat delmontering for detaljer  
 See separate assembly for details  
 Se separata delmontering för detaljer

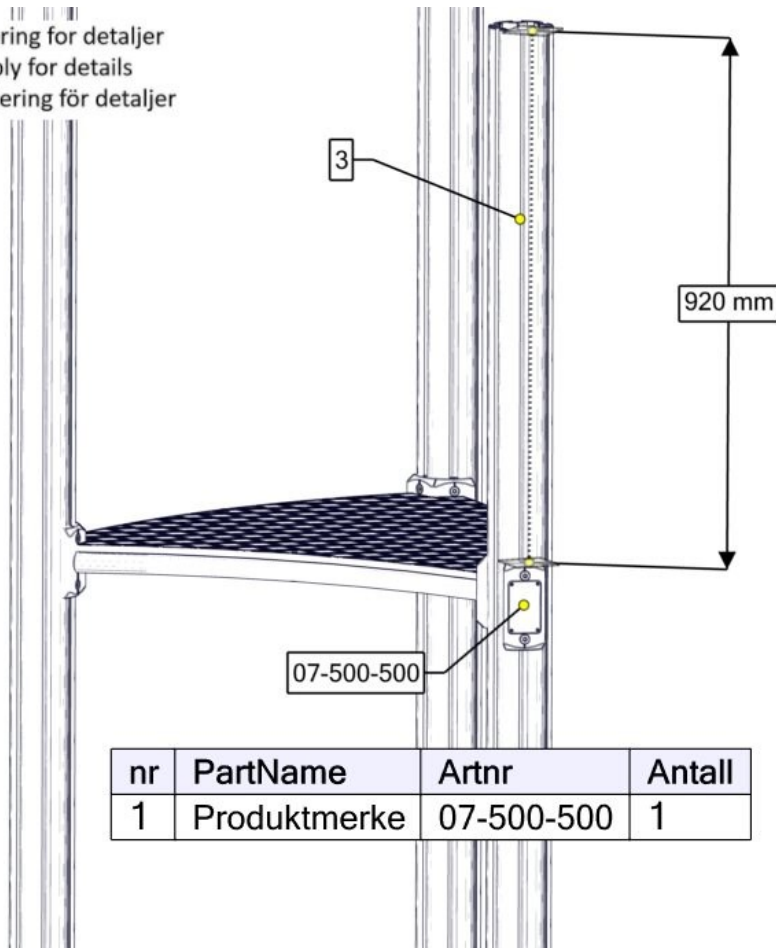

nr	PartName	Artnr	Antall
1	Produktmerke	07-500-500	1

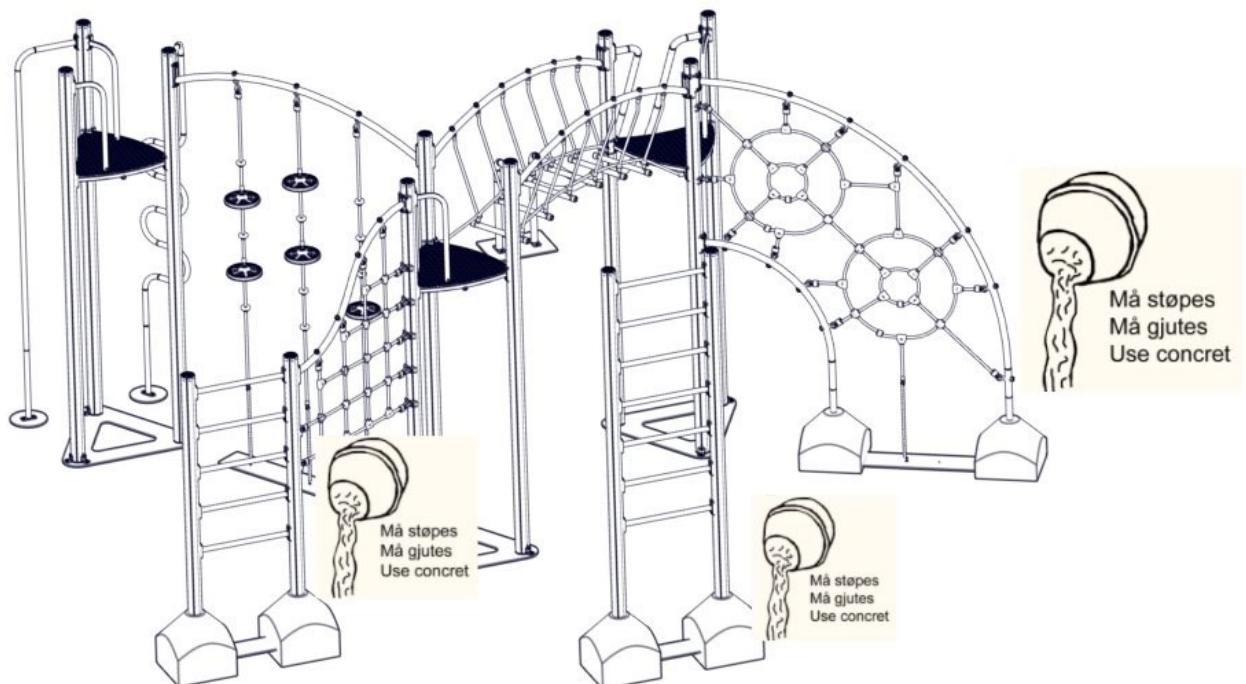
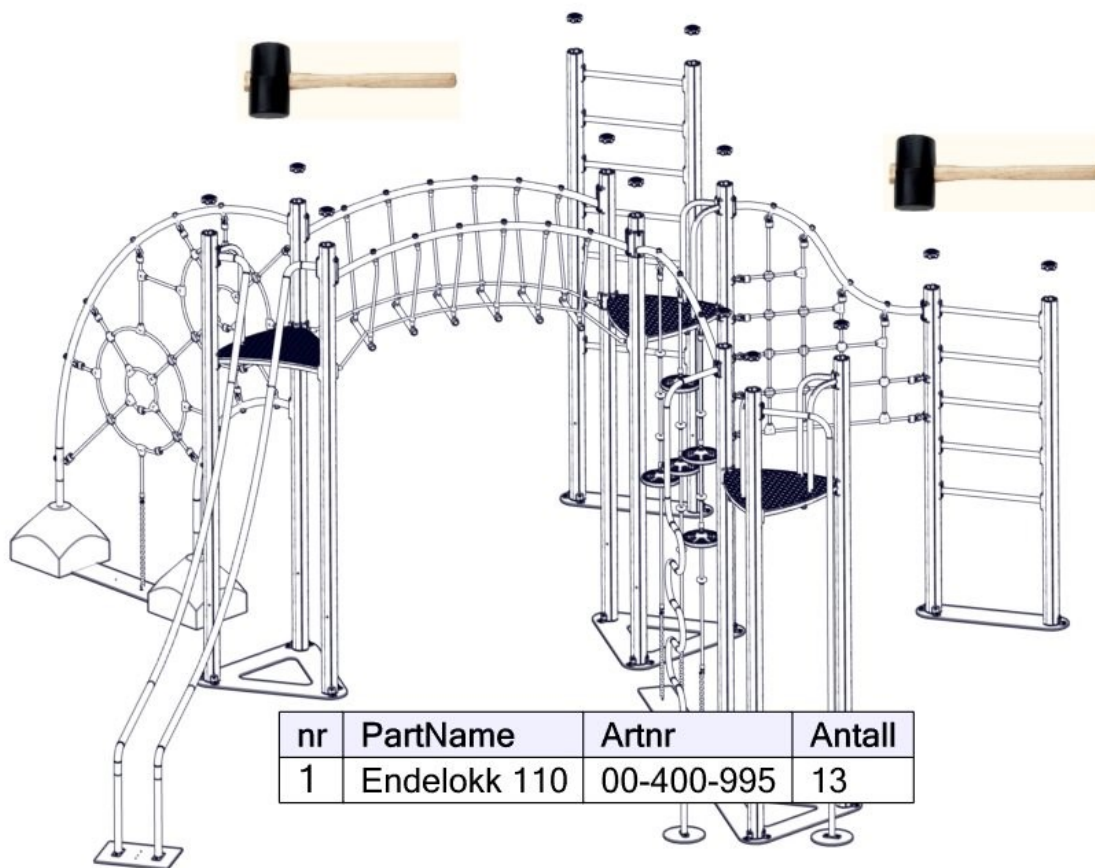







<b>Før utstyret tas i bruk / Before play begins / Innan lekredskapet tas i bruk</b>	
<b>N</b>	<ul style="list-style-type: none"> <li>● Påse at fallunderlag er utlagt i henhold til gjeldende regler eller vår anbefaling</li> <li>● Fjern alle monteringshjelpemidler ( rester av betong, planker, paller, plast, og lignende)</li> <li>● Før utstyret tas i bruk, burde man sjekke at det ikke er fare for at anorakksnorer og lignende som kan hekte seg fast noen steder på lekeapparatet. (Vedlagte snor med dobbe (kneledd) kan brukes til å sjekke at dette er i orden. Se vedlagte veiledning for bruk av denne. Dette gjøres for å oppdage eventuelle feilmonteringer.?)</li> <li>● NB! Bør stå i 2-3 dager før bruk</li> </ul>
<b>EN</b>	<ul style="list-style-type: none"> <li>● Make sure the area and depth of safer surfacing are according to the current standard, or to the manufacturer's recommendation</li> <li>● Make sure all tools and surplus materials are removed before play begins</li> <li>● PS! When complete, allow 2-3 days for the concrete to set before use</li> </ul>
<b>S</b>	<ul style="list-style-type: none"> <li>● Kontrollera att fallunderlag är utlagt enligt gällande regler eller vårt rekommendation</li> <li>● Ta bort alla monteringshjälpmedel (rester av betong, plankor, pallar, plast och liknande)</li> <li>● Innan lekredskapet används, kontrollera att anoracksnoddar eller kläder/delar av kläder eller liknande inte kan fastna i några delar på redskapet. (Den bipackade "knävringen" kan man med fördel användas för denna kontroll.</li> <li>● Detta görs för att upptäcka eventuella felmonteringar.)</li> </ul>

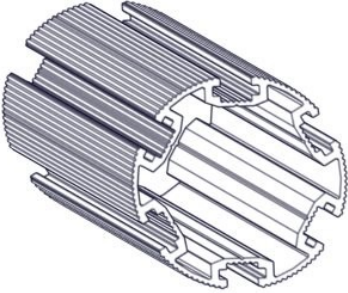
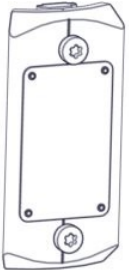

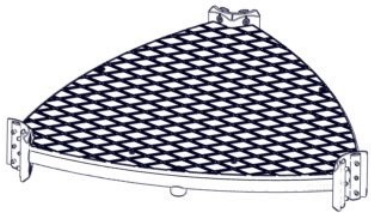
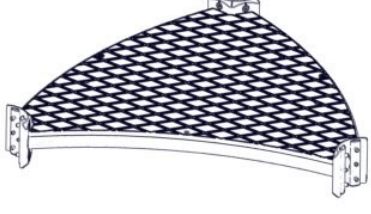

**Boltepakker for / Boltpackage for / Bultpaket för**

Sign. \_\_\_\_\_

Adventure Ormtjern 14-101-015	Navn	Artnr/dimensjon	Ant	Lev
	Stolpe Ø110 L=3450 Grå Stolpe Ø110 L=2500 Grå	SFA5126/2 SFA5126/2	11 2	
	Produktmerke 14-100-015	07-500-500 (se egen delmontering)	1	
	Endelokk til Ø110 stolpe	00-400-995	13	
	Gulv 3-kant standard CC880 Grå	07-300-104K (se egen delmontering)	2	
	Gulv 3-kant 1konkav CC880 Grå	07-300-105K (se egen delmontering)	1	
	Sperrerør rett L=750 Uten hull Grønn	07-500-059K (se egen delmontering)	12	

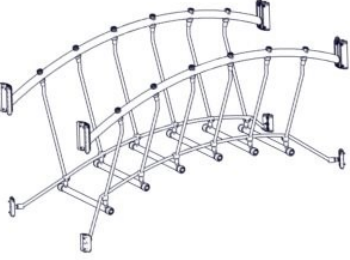
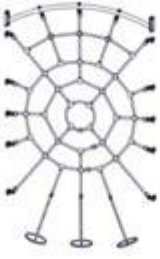

**Boltepakker for / Boltpackage for / Bultpaket för**

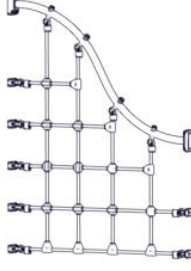
Sign. \_\_\_\_\_.

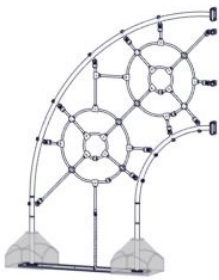

Adventure Ormtjern 14-101-015	Navn	Artnr/dimensjon	Ant	Lev
	Sluse H=790 Grønn	07-500-074K (se egen delmontering)	6	
	Monkeyseats x3 Grønn	07-500-122K (se egen delmontering)	1	
	Trapez bro Grønn	07-500-011K (se egen delmontering)	1	
	Edderkoppnett 30gr Grønn	07-500-032K (se egen delmontering)	1	
	Slider komplett	07-200-010K (se egen delmontering)	1	
	S-nett Grønn	07-500-021K (se egen delmontering)	1	

**Boltepakker for / Boltpackage for / Bultpaket för**

Sign. \_\_\_\_\_

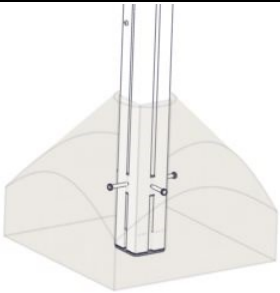
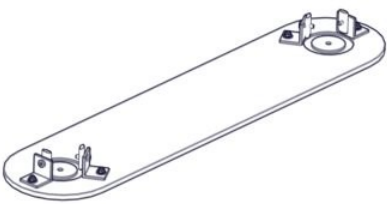
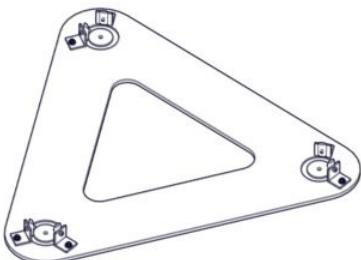
Adventure Ormtjern 14-101-015	Navn	Artnr/dimensjon	Ant	Lev
	Edderkoppnett dobbelt 30gr Grønn	07-500-028K (se egen delmontering)	1	
	Brannstang Grå	07-200-037K (se egen delmontering)	1	
	Klatrestang Grå	07-200-038K (se egen delmontering)	1	

<b>Boltepakker for / Boltpackage for / Bultpaket för</b>		Sign. _____		
<b>Adventure Ormtjern 14-101-015</b>	<b>Navn</b>	<b>Artnr/ dimensjon</b>	<b>Ant</b>	<b>Lev</b>
	<b>Fundament Støp</b>			
	Støpefundament stolpe Ø110	00-003-111K (se egen delmontering)	13	
	<b>Fundament Nedgraving</b>			
	Fundamentplate 2xØ110 stolpe	07-400-102K (se egen delmontering)	2	
	Fundamentplate 3xØ110 stolpe	07-400-103K (se egen delmontering)	3	

<b>Boltepakker for / Boltpackage for / Bultpaket för</b>		Sign. _____		
<b>Adventure Ormtjern 14-101-015</b>	<b>Navn</b>	<b>Artnr/ dimensjon</b>	<b>Ant</b>	<b>Lev</b>
	<b>Overflatemon- tering</b>			
	Fundament 2xØ110 stolpe for betongdekke	00-003-114K (Se egen delmontering)	2	
	Fundament 3x110 stolpe for betongdekke	00-003-115K (Se egen delmontering)	3	
	Slider kappes Brannstang kappes Klatrestang kappes Edderkoppnett kappes	07-200-010K 07-200-037K 07-200-038K 07-500-028K	(1) (1) (1) (1)	
	Stolpe Ø110 må kappes	SFA5126/1	(8)	
	Bruk kortere bolter når nett skal monteres.	04-000-016	4	

**Revisjon:**

20.08.2020\_MTF

Oppdatert BOM

Oppdatert div view

Lagt til tabell og oppdatert mål/vekt/betong

Oppdatert fundamentbilder

Oppdatert/lagt til plukklister for fundamenter

24.08.2020\_MTF

Oppdatert sikkerhetszone/ground

Oppdatert art nr for stolper

Oppdatert div view

19-11-2021 SV

Endret sonebilder for slider