

N**Monteringsanvisning****EN****Assembly Instructions****S****Monteringsanvisning**

Produkt nr. / Product no. / Produkt nr.

14-101-019**Grå/Grønn**

Ord. nr. _____

Dato. _____

Sign. _____

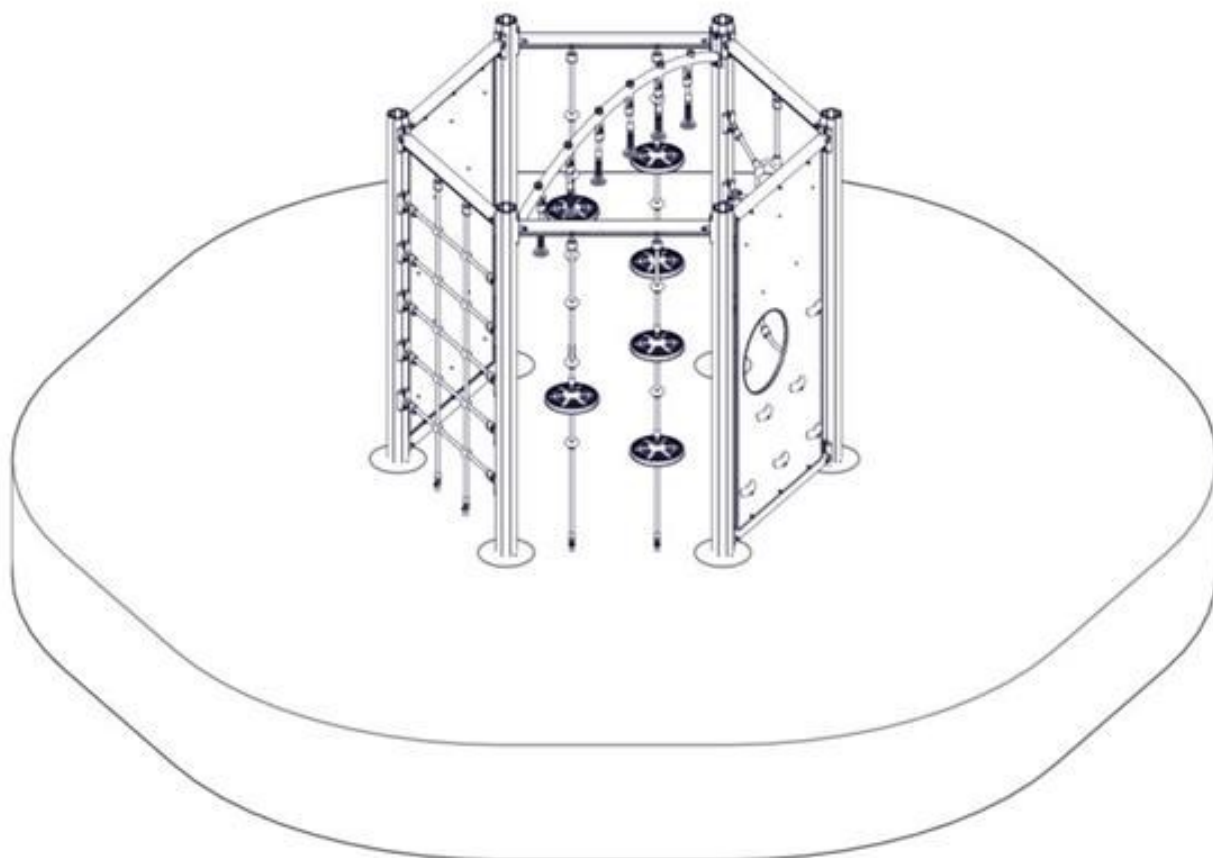
**søve**

Søve AS
Grønnvoldveien 290
3830 Ulefoss - Norway
Tlf: +47 35 94 65 65
www.sove.no

**søve**

Søve AB
EA Rosengrensgatan 32
421 31 Västra Frölunda
Phone: +46 (0)31 773 97 00
www.sove.se

Monteringstips / Assembly Advice / Monteringsstips

N

- Les monteringsanvisningen nøye før montering.
- Monter elementene i rekkefølgen som vist.
- Boltene bør ikke skrues for hardt til før alt er montert, vatret og loddet. Skru så boltene til.
- NB! Ved bruk av drill, kan boltene ryke.
- Er lekeutstyret plassert i naturlige ferdselstraséer må området sikres mot gjennomgang.
- Innspringningshinder bør vurderes rundt lekeapparater hvor det er stor bevegelse, f.eks. ved huskestativ.
- Det bør være fritt innsyn til lekeutstyr som er beregnet for barn under 3 år.

NB! Under monteringsarbeidet må utstyr, som ikke er forankret forsvarlig i bakken, sikres slik at det ikke velte.

Området må avstenges under montering av apparatene med sperrebånd eller lignende.

EN

- Read the instruction carefully before assembling the play unit..
- Assemble the components in the sequence shown in these instructions.
- Fixings must not be fully tightened during assembly. Before casting the foundations, the structure must be level and plumb, at which point all fixings are tightened.
- PS! If use of drill, the bolts may be wrecked.
- Secure the construction-area to prevent people from walking through it.
- Consider installing barriers around play-equipment which gives rise to a lot of activity – i.e.swings.
- Ensure that clear vision is possible across the play area so that supervision is possible from any position, particularly where children under 3 years of age will be playing.

NB! During assembly of the equipment, ensure that all structures are securely propped, especially when left overnight. Also ensure that equipment is supported whilst concrete foundations are setting and enclose the area securely to prevent access.

Monteringstips / Assembly Advice / Monteringsstips**S**

- Läs monteringsanvisningen noga före montering.
- Montera delarna i den ordningen som anvisas
- Skruvarna bör inte skruvas för hårt tills allt är monterat, i våg och lodat.

OBS! Används elektrisk skruvdragare, kan bulten gå sönder. Hårdra därför manuellt!









- Om lekplatsen placeras vid en gångväg mm bör området säkras mot genomfart av gående och cyklister.
- Inspringshinder bör placeras runt lekutrustning med stor rörelse, t ex, gungställning.
- Det bör vara fri insyn till lekutrustning beräknat till barn under 3 år.

OBS! Under monteringsarbete bör utrustningen som inte ska förankras i marken, ställs så att den inte kan välta.

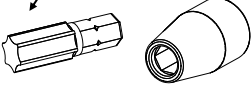
Området måste spärras när lekutrustningen byggs upp, med avspärningsband eller liknande.

NO	Betongkvalitet	C25/30		
SE	Betongkvalitet			
EN	Concrete quality			
NO	Mengde betong		0,6	m ³
SE	Mängd betong			
EN	Amount of concrete			
NO	Fundament størrelse		0,5x0,5x0,4	m
SE	Stiftelsestorlek			
EN	Foundation size			
NO	For sikkerhet må fundamentene med sand eller myk jord være minst 50% større i areal			
SE	För säkerheten måste grunden med sand eller mjuk jord vara minst 50% större i området			
EN	For safety, the foundations with sand or soft soil must be at least 50% larger in area			
NO	Tyngste element	07-500-392	31	Kg
SE	Tyngsta element			
EN	Heaviest element			
NO	Største element	07-500-392 SFA5126/2	1,9x0,9x0,054 2,7 x Ø0,11	m
SE	Största element			
EN	Biggest element			

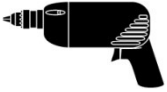
Nødvendig verktøy / Tools required / Nödvändiga verktyg

<p>(N)</p> <p>(EN)</p> <p>(S)</p>	<p>(A)</p> 	<p>(B)</p>  <p>Torx Nr 45 High quality</p> 	<p>(C)</p>	<p>(D)</p> 	<p>(E)</p> 
		<p>Metermål</p> <p>Metric measure</p> <p>Tumstock</p> 	<p>16 V</p> 	<p>Merkebånd</p> <p>Mark ribbon</p> <p>Märkeband</p> 	

Nødvendig antall personer / Number of persons required / Rekommenderad antal personer



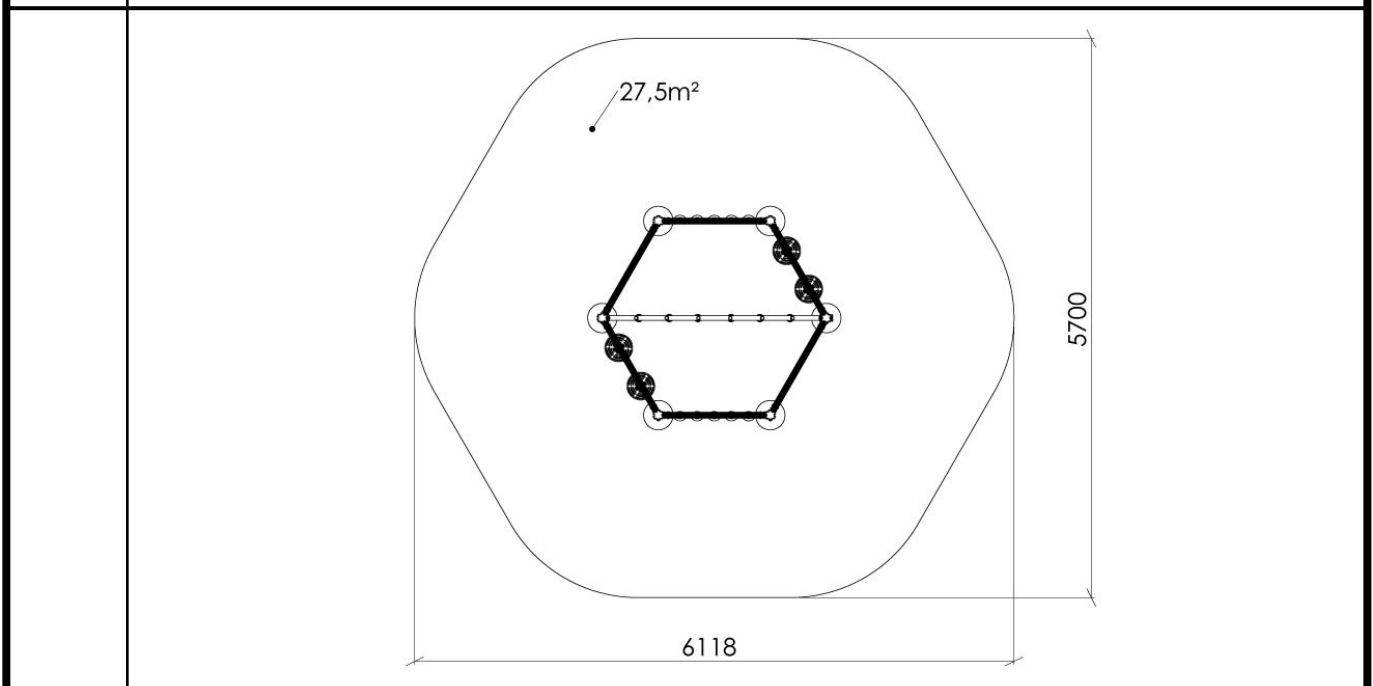

<p>(N)</p> <p>(EN)</p> <p>(S)</p>	
-----------------------------------	---

Anbefalt arealbehov ved montering / Recommended working space / Rekommenderad arealbehov vid montering



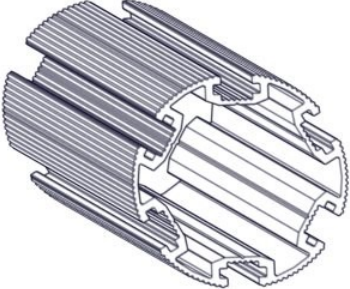





Boltepakker for / Boltpackage for / Bultpaket för

Sign. _____

6-Kant Grå/Grønn 14-101-019	Navn	Artnr/ dimensjon	Ant	Lev
	Produktmerke	07-500-500 (Se egen delmontering)	1	
	Stolpe Ø110 L=2700 (2100-600) Grå	SFA5126/2	6	
	Drager med 0gr beslag cc1143 3H cc300 Sort	07-500-373K (Se egen delmontering)	4	
	Drager med 0gr beslag cc1143 2H cc450 Sort	07-500-372K (Se egen delmontering)	2	
	Drager med 0gr beslag cc1143 2H cc300 Sort	07-500-371K (Se egen delmontering)	1	
	Drager med 0gr beslag cc1143 1 hull Sort	07-500-370K (Se egen delmontering)	1	

Boltepakker for / Boltpackage for / Bultpaket för

Sign. _____

6-Kant Grå/Grønn 14-101-019	Navn	Artnr/ dimensjon	Ant	Lev
	Armgang Polyfix handtak 0gr Komplet L=2156 Grønn	07-500-456K (Se egen delmontering)	1	
	Klatreplate med hull Komplet Grå/Gul	07-500-391K (Se egen delmontering)	1	
	Klatrenett Komplet Sort/Grønn	07-500-385K (Se egen delmontering)	1	
	Klatreplate Komplet Grå/Gul	07-500-392K (Se egen delmontering)	1	
	Spidernett Komplet Sort/Grønn	07-500-378K (Se egen delmontering)	1	
	Monkeyseats Sett Sort/Grønn	07-500-379K (Se egen delmontering)	2	

Boltepakker for / Boltpackage for / Bultpaket för

Sign. _____.

6-Kant Grå/Grønn 14-101-019	Navn	Artnr/ dimensjon	Ant	Lev
	Endelokk Ø110	00-400-995	6	

Boltepakker for / Boltpackage for / Bultpaket för

Sign. _____.

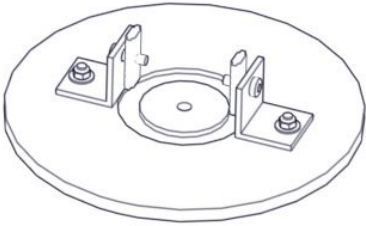
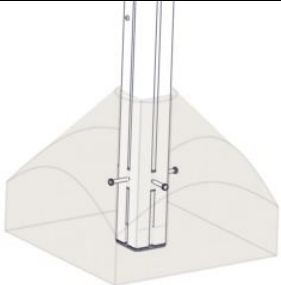
6-Kant Grå/Grønn 14-101-019	Navn	Artnr/ dimensjon	Ant	Lev
	Fundament Nedgravning			
	Fundamentplate 1x110 stolpe komplett	07-400-101K (Se egen delmontering)	6	
	Fundament Støp			
	Støpefundament	00-003-111K (se egen delmontering)	6	

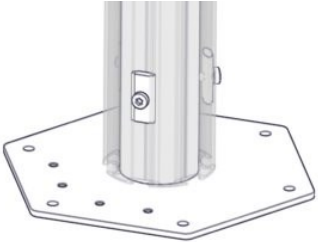
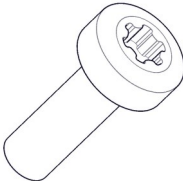
Boltepakker for / Boltpackage for / Bultpaket för		Sign. _____		
6-Kant Grå/Grønn 14-101-019	Navn	Artnr/ dimensjon	Ant	Lev
	Overflatemon- tering			
	Fundament 1x 110 stolpe for betongdekke	00-003-113K (Se egen delmontering)	6	
	Stolpe Ø110 må kappes	SFA5126/1	(6)	
	Bruk kortere bolter når nett skal monteres.	04-000-016	8	

Fundamentering med betong // Foundation concrete // Förankring med betong

- (N) Støtdempende materialer
- (EN) Impact attenuating materials
- (S) Støtdämpande material Ref NS-EN 1176-1 §4.2.8.5

- (N) Bakkenivå
- (EN) Ground level
- (S) Marknivå

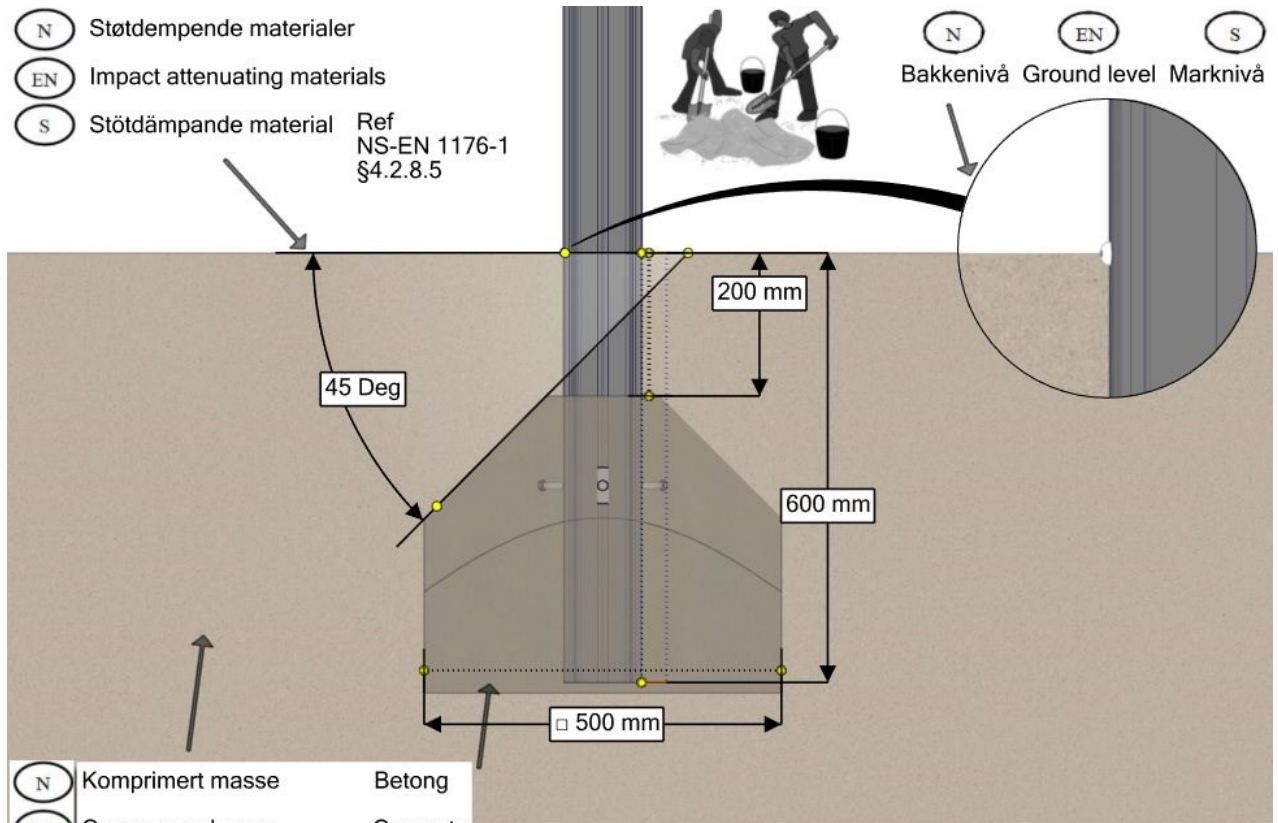

- (N) Komprimert masse Betong
- (EN) Compressed mass Concrete
- (S) Komprimerad massa Betong

Fundamentering uten betong // Foundation without concrete // Förankring utan betong

- (N) Støtdempende materialer
- (EN) Impact attenuating materials Ref NS-EN 1176-1 §4.2.8.5
- (S) Støtdämpande material

- (N) Bakkenivå
- (EN) Ground level
- (S) marknivå

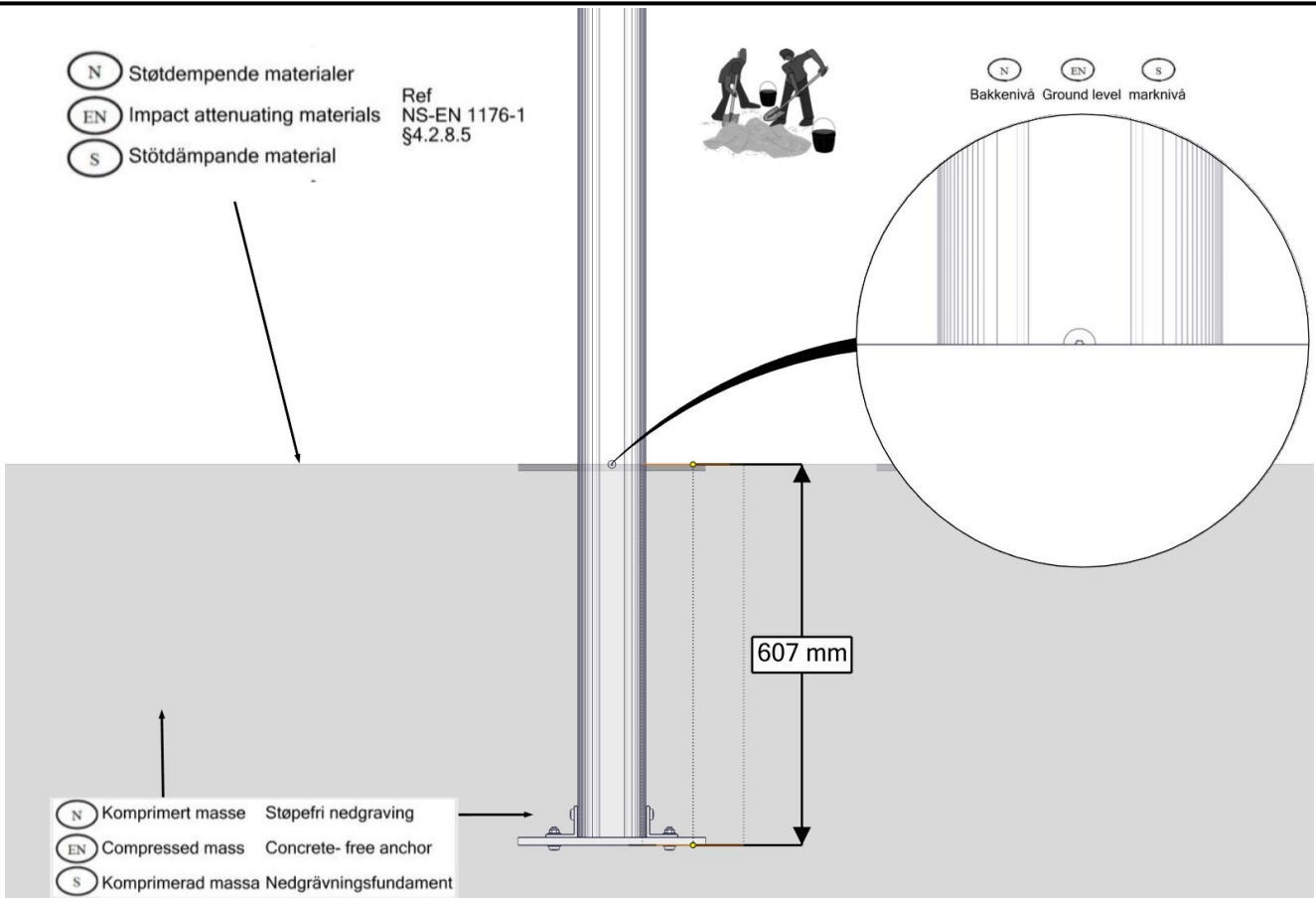

- (N) Komprimert masse Støpefri nedgraving
- (EN) Compressed mass Concrete-free anchor
- (S) Komprimerad massa Nedgravningsfundament

Fundamentering overflate / Foundation surface / Förankring grundytan

Ref.
NS-EN 1176-1
§4.2.8.5

(N) (EN) (S)
Bakkenivå Ground level marknivå

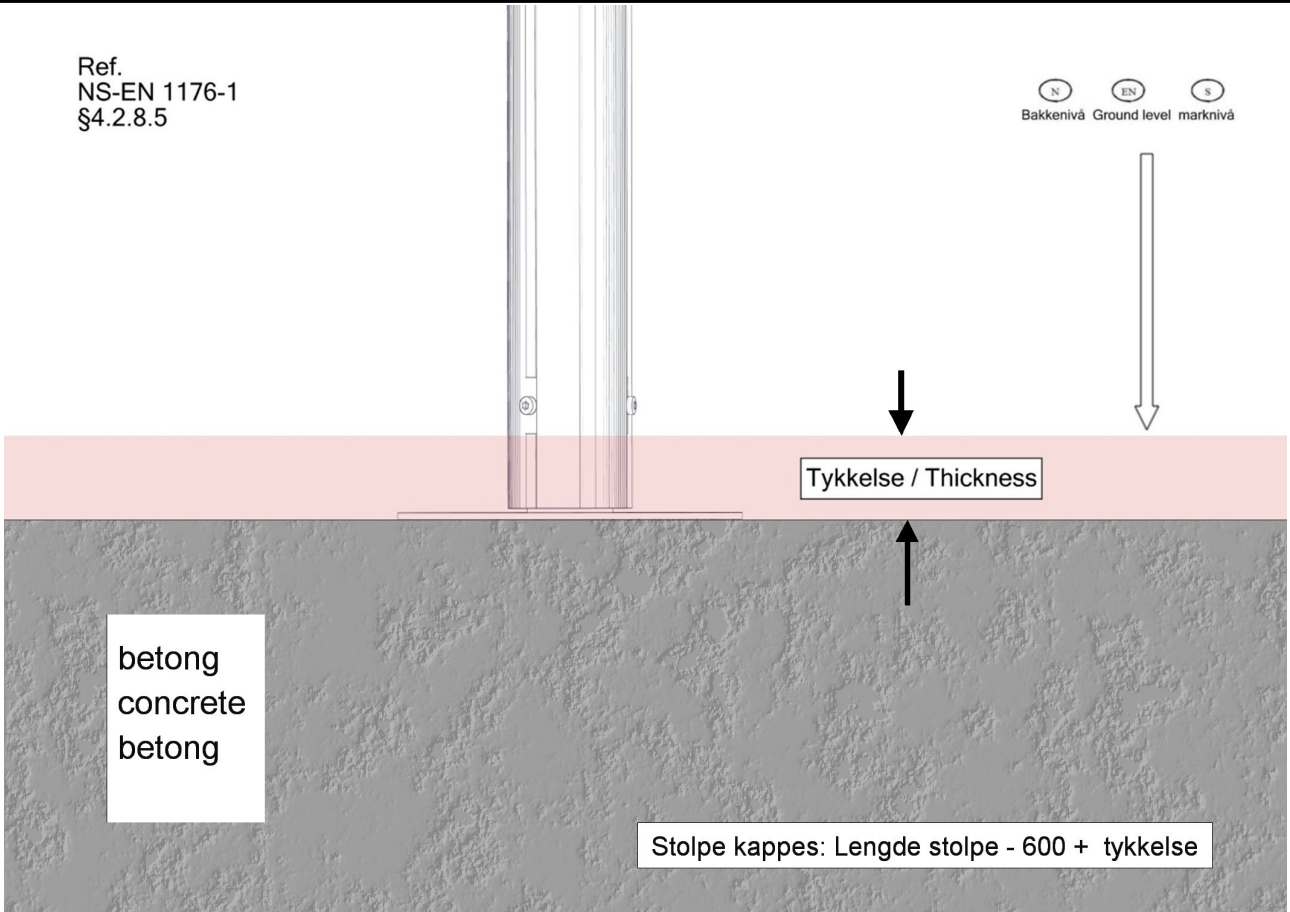

Når du har overfaltemonteringsfundamenter bruk korte skurer på nedeste festepunkter.

If you are using 0-level anchors use short bolt for mounting lower parts

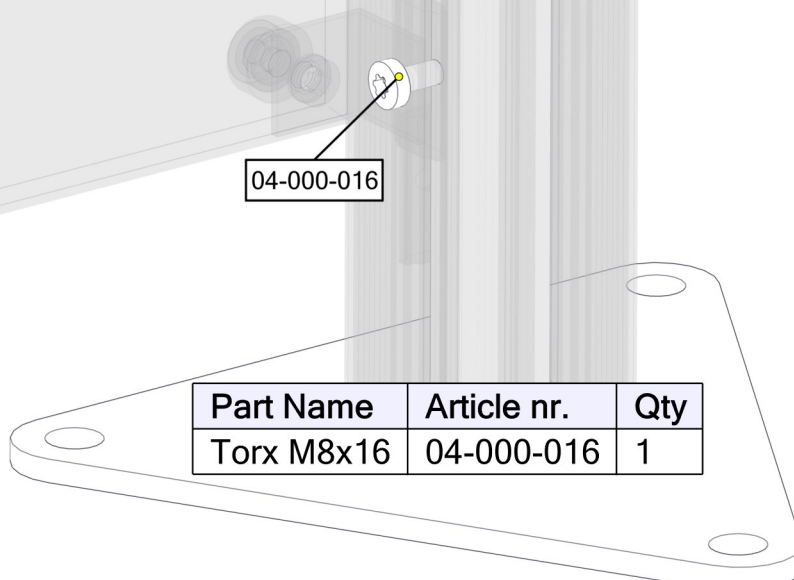

Part Name	Article nr.	Qty
Torx M8x16	04-000-016	1

<p>N</p>	<p>Bolten skrues HELT igjennom aluminiumen. Maks moment: 30Nm</p>
<p>EN</p>	<p>The bolt must be tightened in to the post, so that it peirces the aluminium Max torque: 30Nm</p>
<p>S</p>	<p>Bulten skivas HELT genom aluminiumen. Maks Vridmoment: 30Nm</p>
<p>N</p>	<p>Alle mål er oppgitt i millimeter</p>
<p>EN</p>	<p>Scale measured in mm</p>
<p>S</p>	<p>Alla mått är i millimeter.</p>

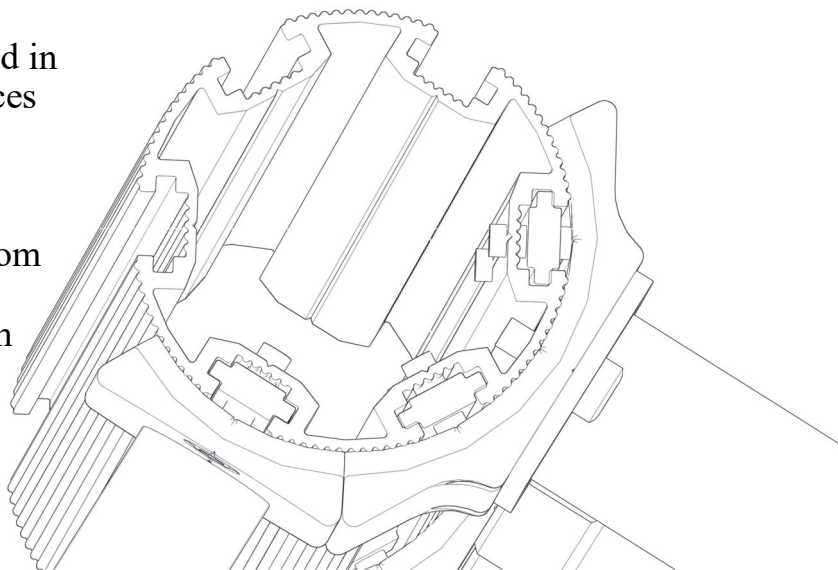

Fallhøyder / Free height of fall / Fallhöjder

Fallhøyde < 2,2 meter

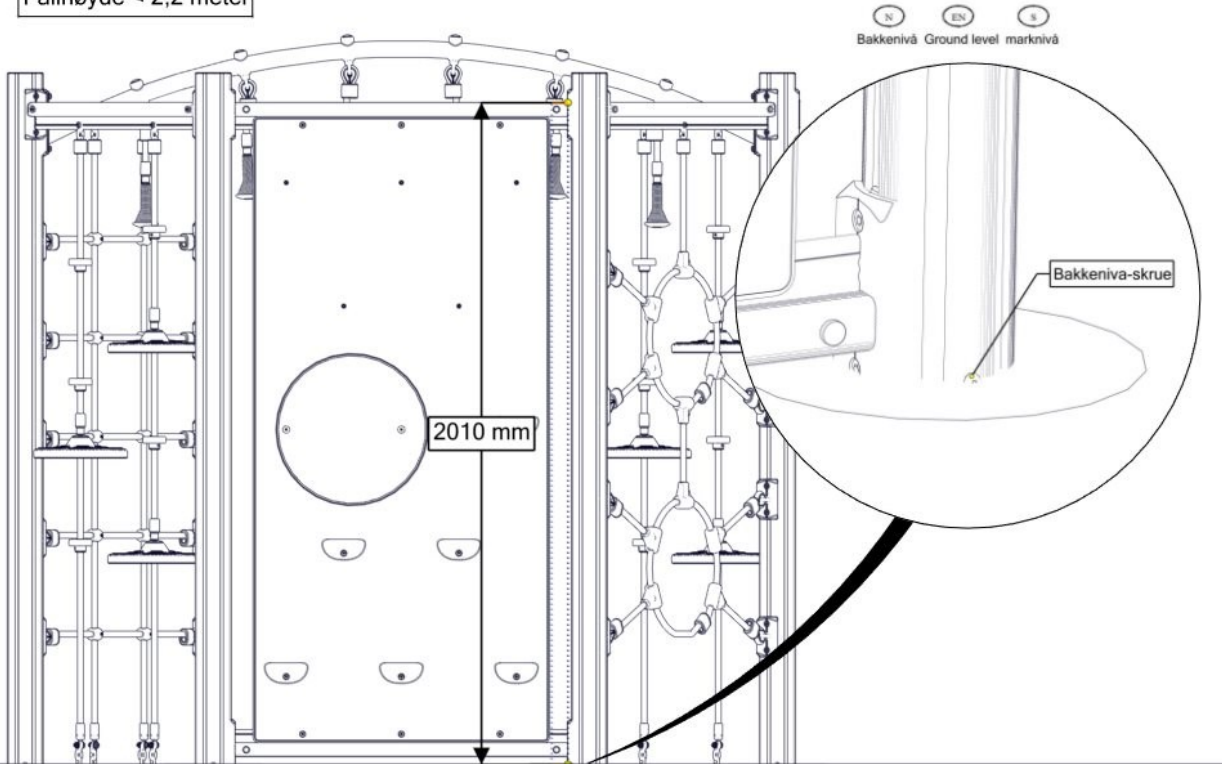

Sikkerhetszone / Safety zone / Säkerhetszon

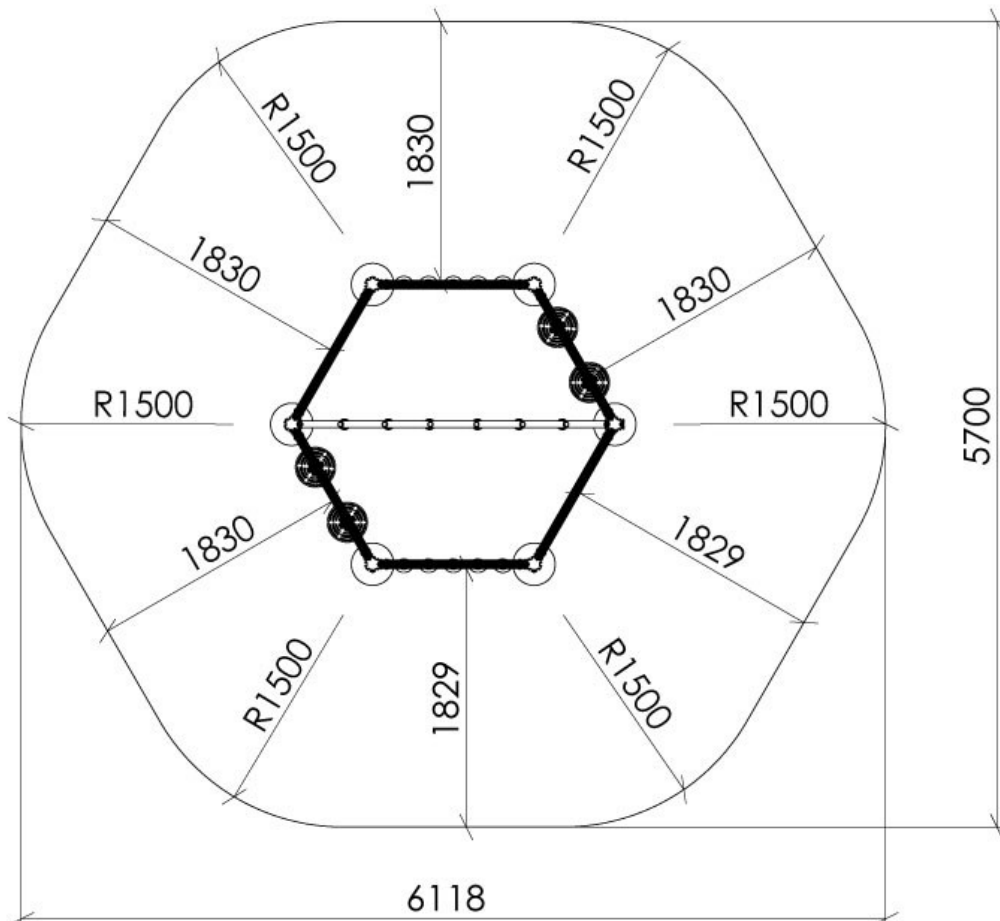

Plassering av forankringer / Ground plan / Placering av förankringar

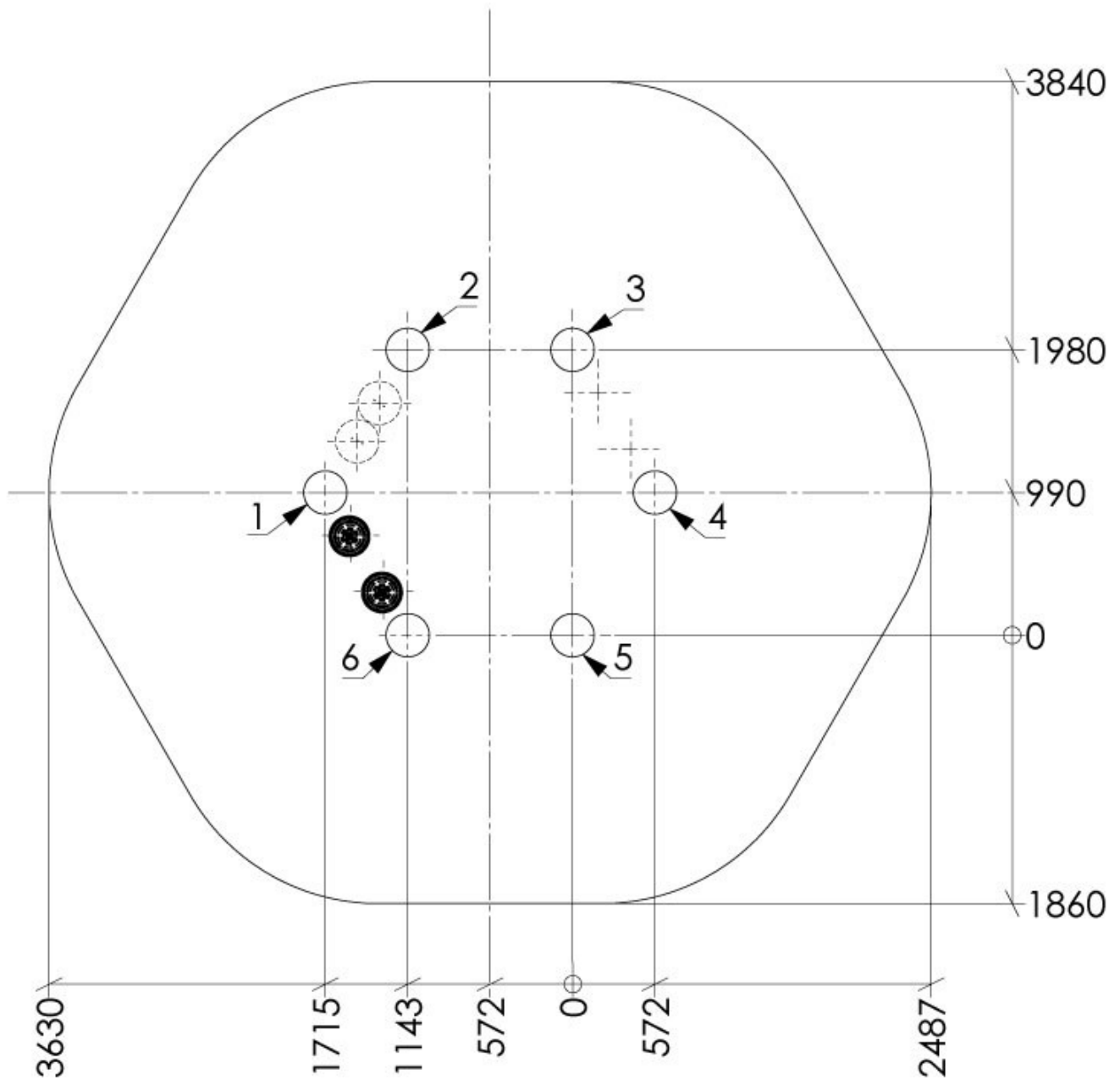

Plassering av forankringer / Ground plan / Placering av förankringar

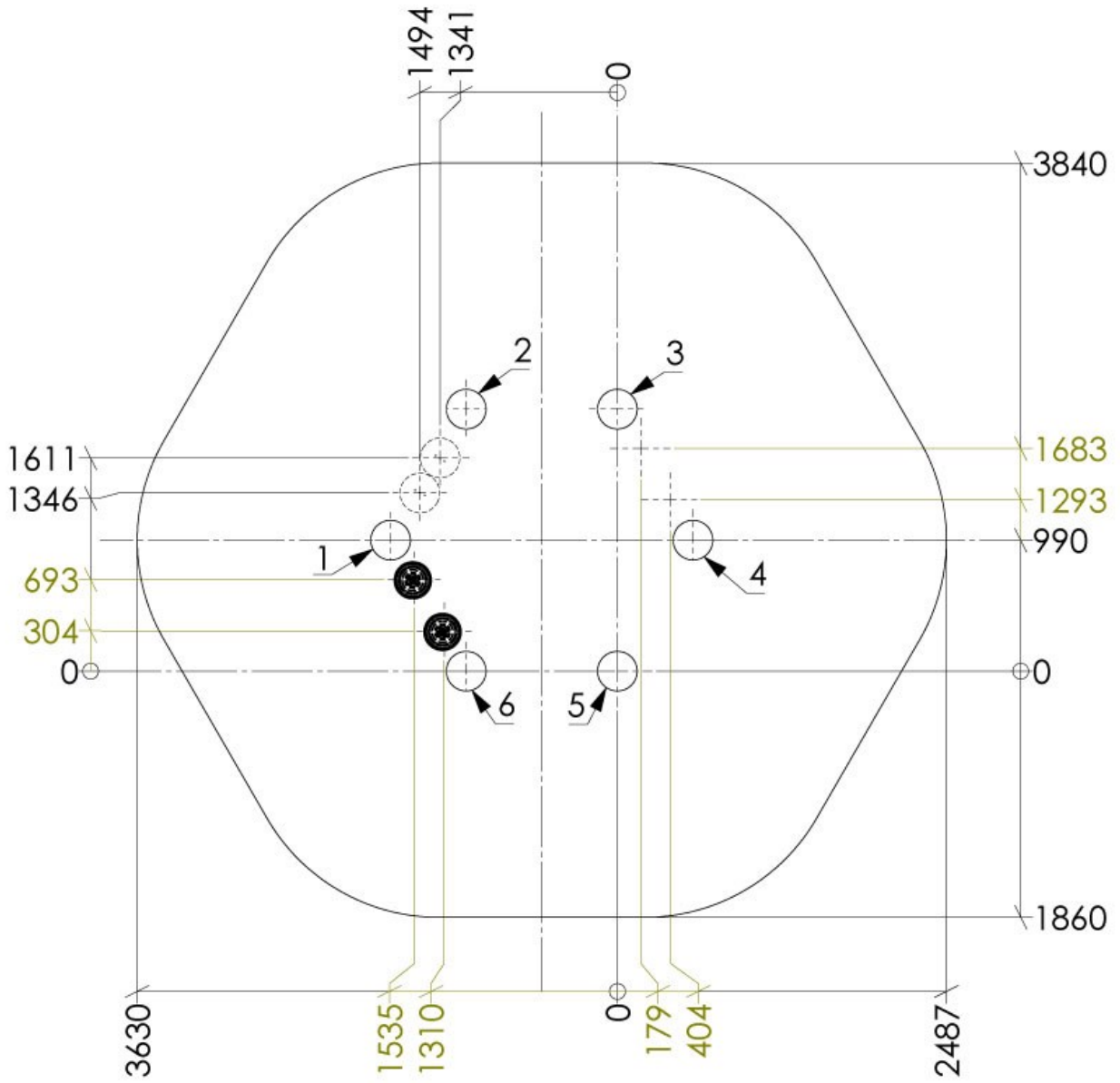

Montering av lekeapparatet / Assembly instructions / Montering av lekredskapet

Se separat delmontering for detaljer
 See separate assembly for details
 Se separata delmontering för detaljer

6x

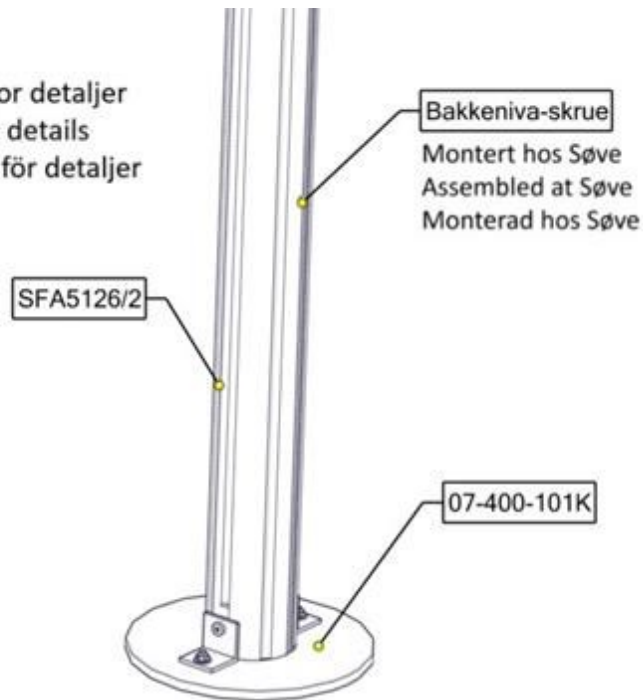

Part Name	Article nr.	Qty
Stolpe Ø110 Lengde=2700	SFA5126/2	1
Fundamentplate 1x110 stolpe komplett	07-400-101K	1

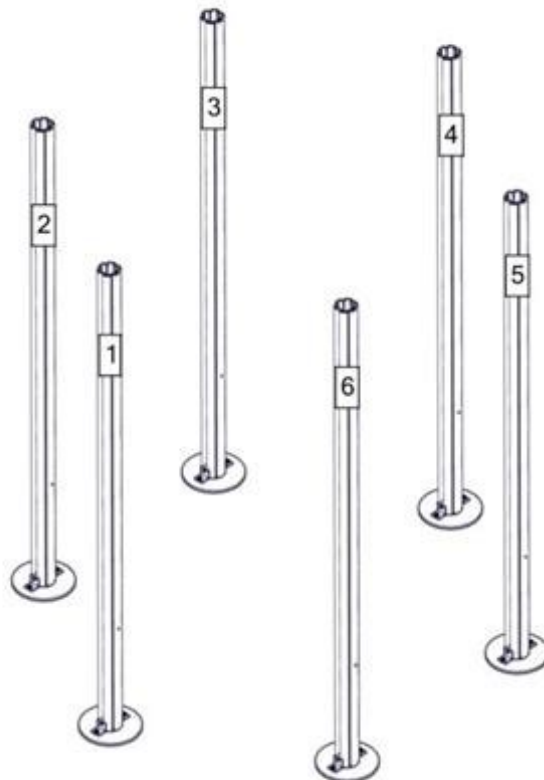

Se separat delmontering for detaljer
 See separate assembly for details
 Se separata delmontering för detaljer

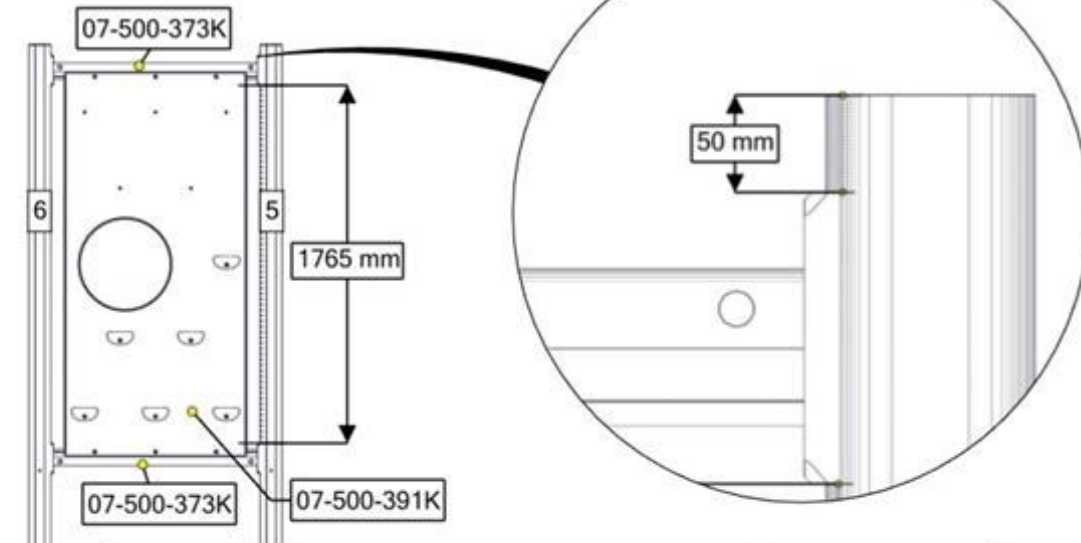

Part Name	Article nr.	Qty
Drager med 0gr beslag cc1143 3H cc300	07-500-373K	2
Klatreplate m hull Grå/Gul	07-500-391K	1

Se separat delmontering for detaljer
 See separate assembly for details
 Se separata delmontering för detaljer

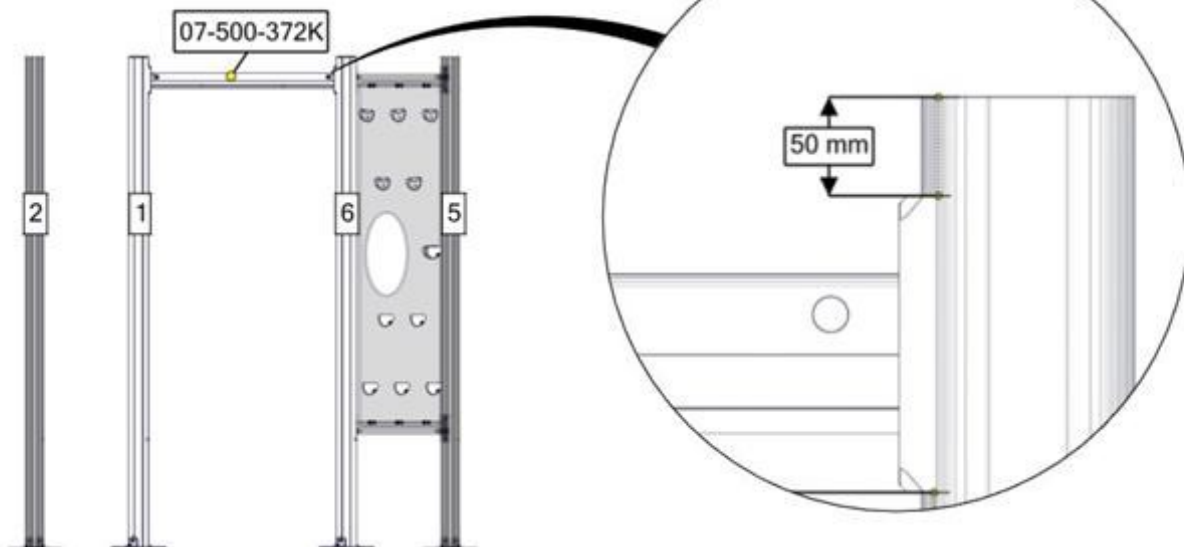

Part Name	Article nr.	Qty
Drager med 0gr beslag cc1143 2H cc450	07-500-372K	1

Se separat delmontering for detaljer
 See separate assembly for details
 Se separata delmontering för detaljer

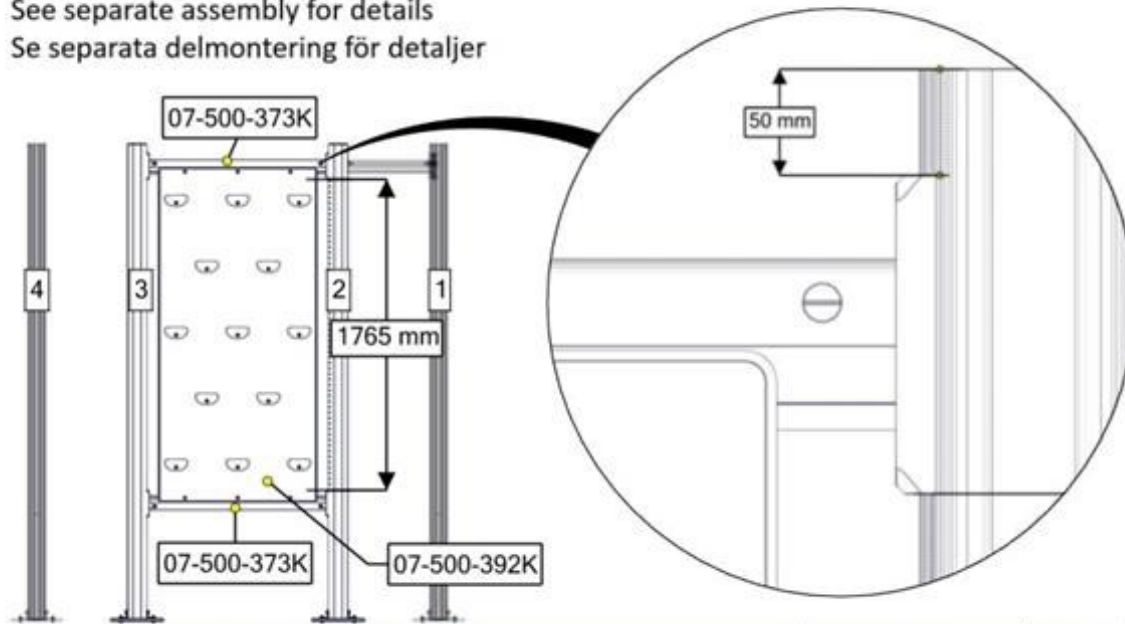

Part Name	Article nr.	Qty
Drager med 0gr beslag cc1143 3H cc300	07-500-373K	2
Klatreplate Grå/Gul	07-500-392K	1

Se separat delmontering for detaljer
 See separate assembly for details
 Se separata delmontering för detaljer

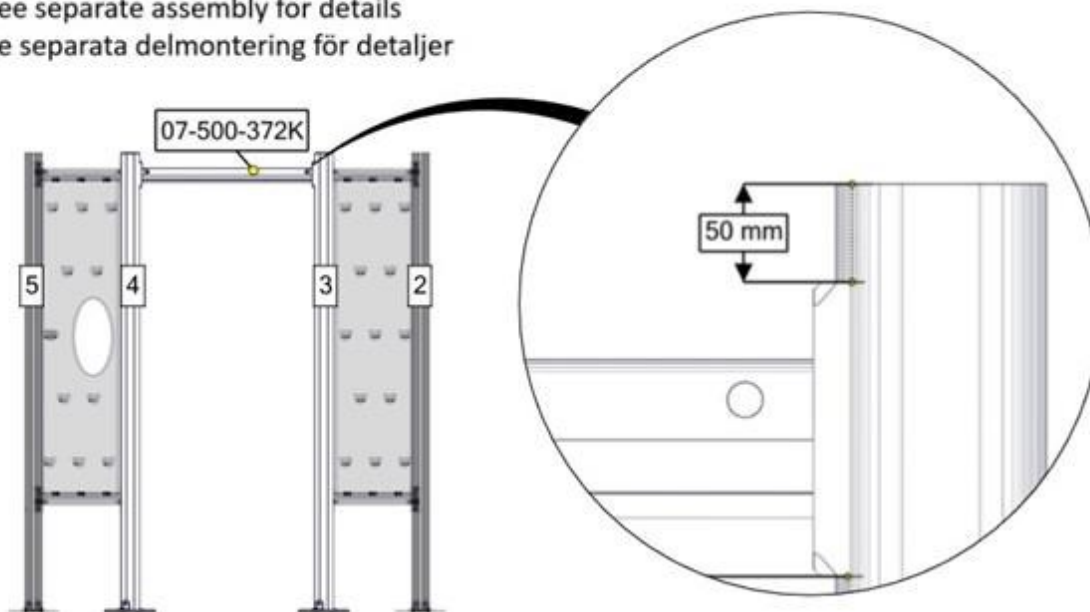

Part Name	Article nr.	Qty
Drager med 0gr beslag cc1143 2H cc450	07-500-372K	1

Se separat delmontering for detaljer
 See separate assembly for details
 Se separata delmontering för detaljer

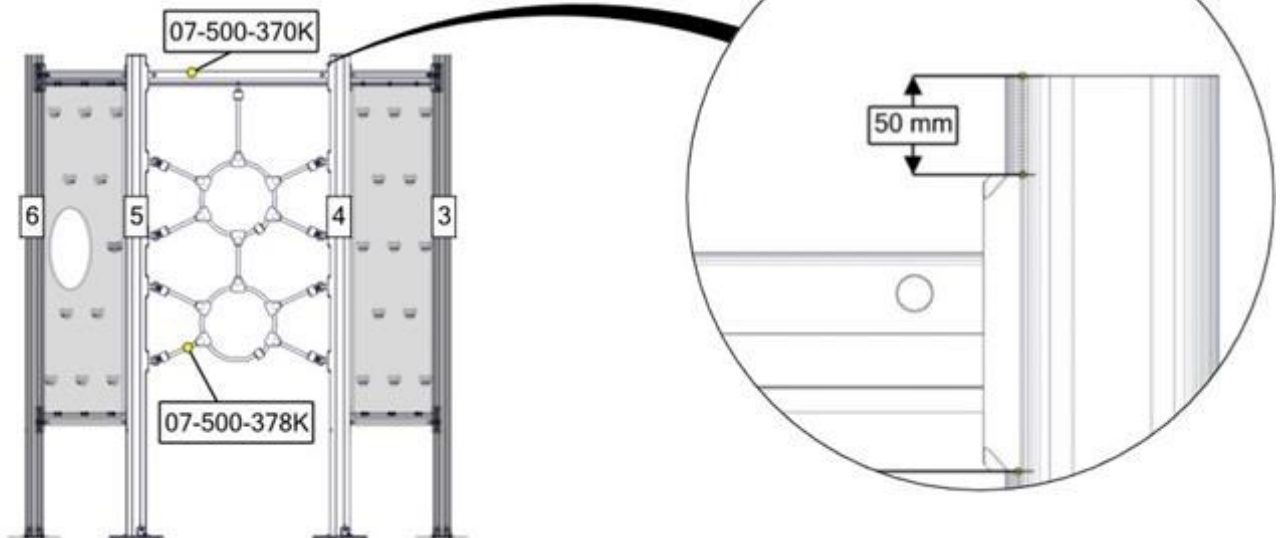

Part Name	Article nr.	Qty
Drager med 0gr beslag cc1143 1 hull	07-500-370K	1
Spidernet Sort/Grønn	07-500-378K	1

Se separat delmontering for detaljer
 See separate assembly for details
 Se separata delmontering för detaljer

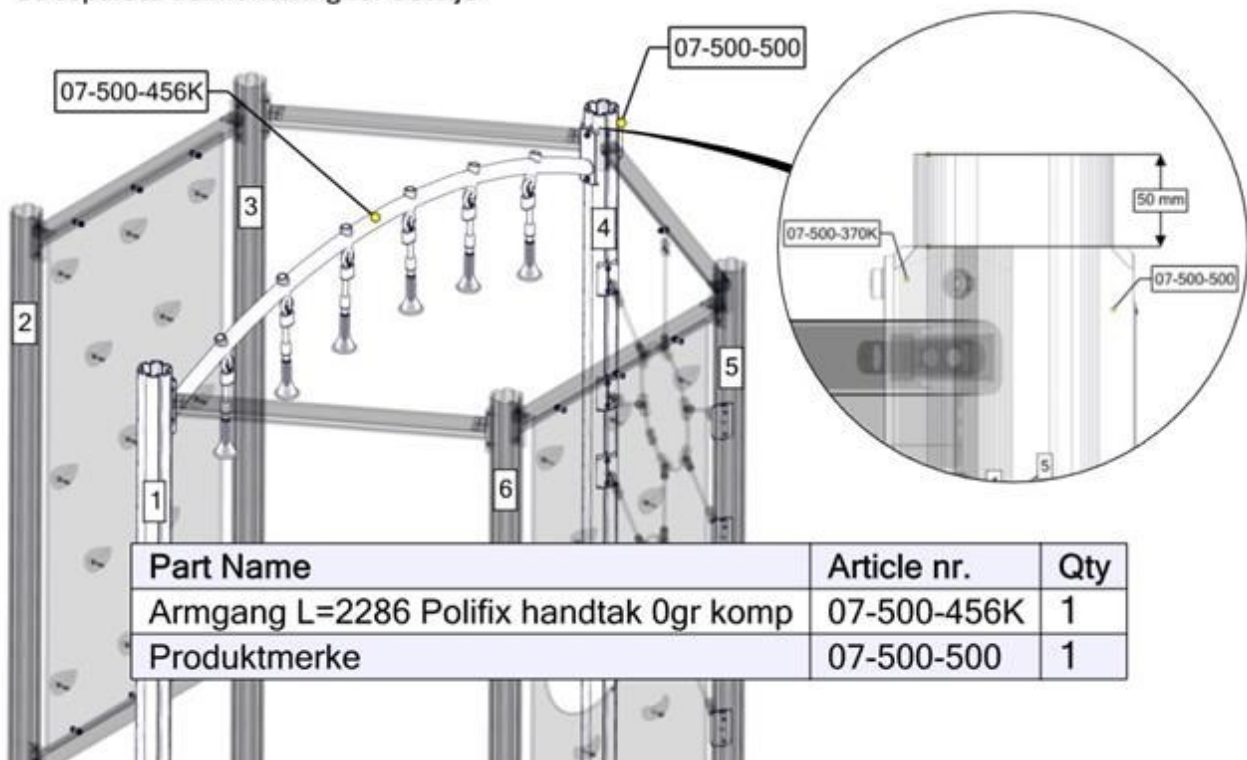

Part Name	Article nr.	Qty
Armgang L=2286 Polifix handtak 0gr komp	07-500-456K	1
Produktmerke	07-500-500	1

Se separat delmontering for detaljer
 See separate assembly for details
 Se separata delmontering för detaljer

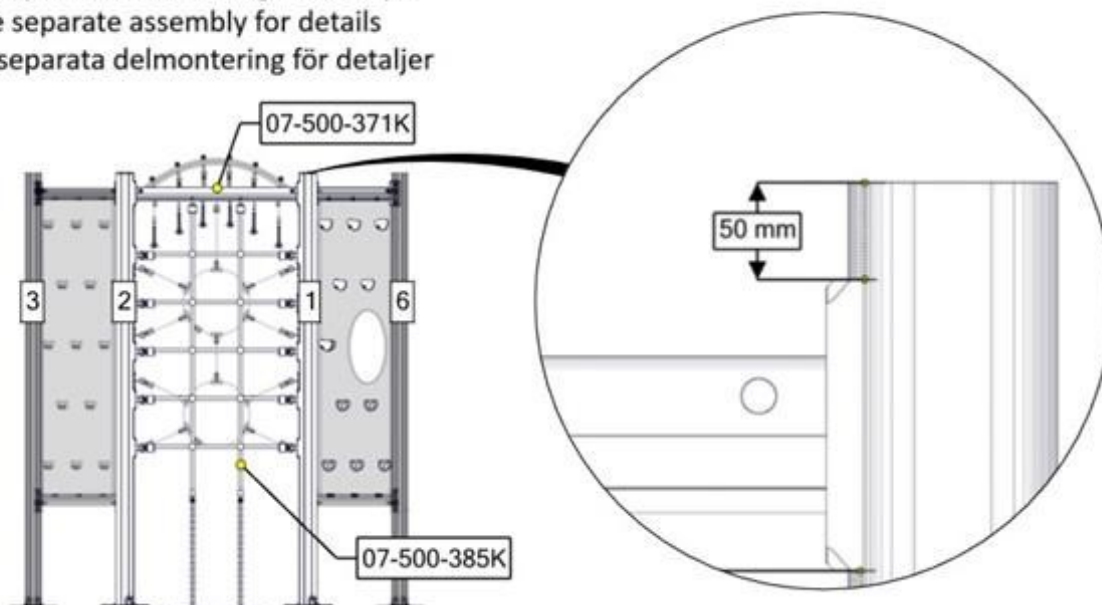

Part Name	Article nr.	Qty
Drager med 0gr beslag cc1143 2H cc300	07-500-371K	1
Klatrenett Sort/Grønn	07-500-385K	1

Se separat delmontering for detaljer
 See separate assembly for details
 Se separata delmontering för detaljer

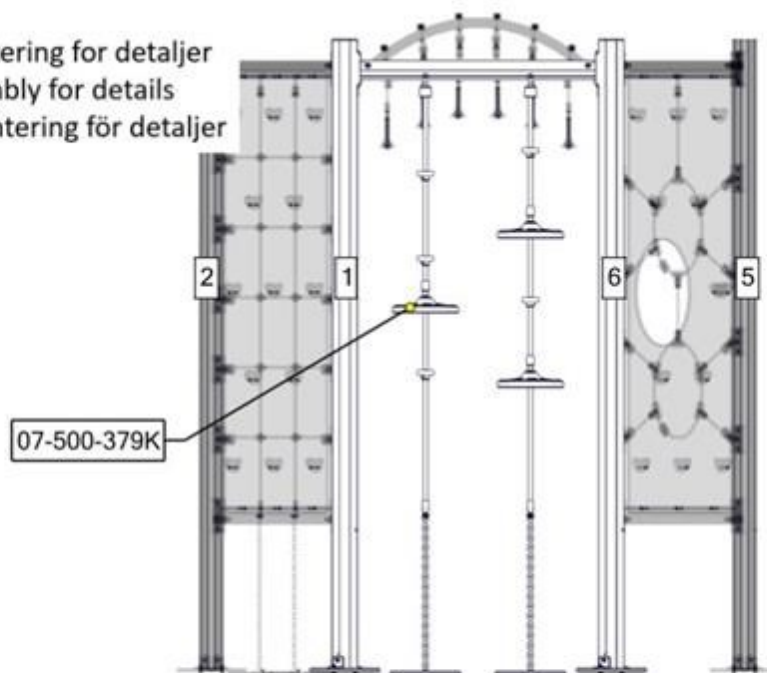

Part Name	Article nr.	Qty
Monkeyseats Sett Sort/Grønn	07-500-379K	1

Se separat delmontering for detaljer
 See separate assembly for details
 Se separata delmontering för detaljer

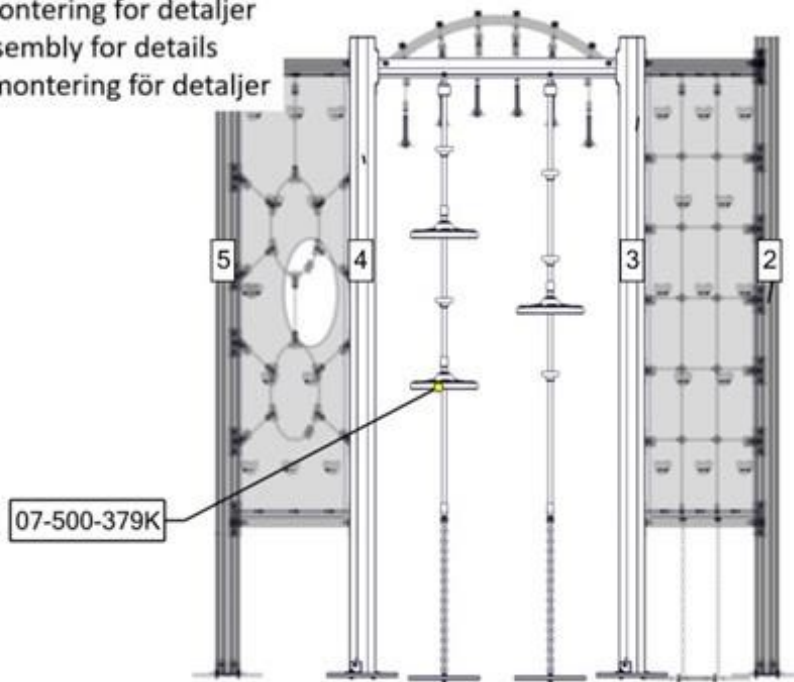



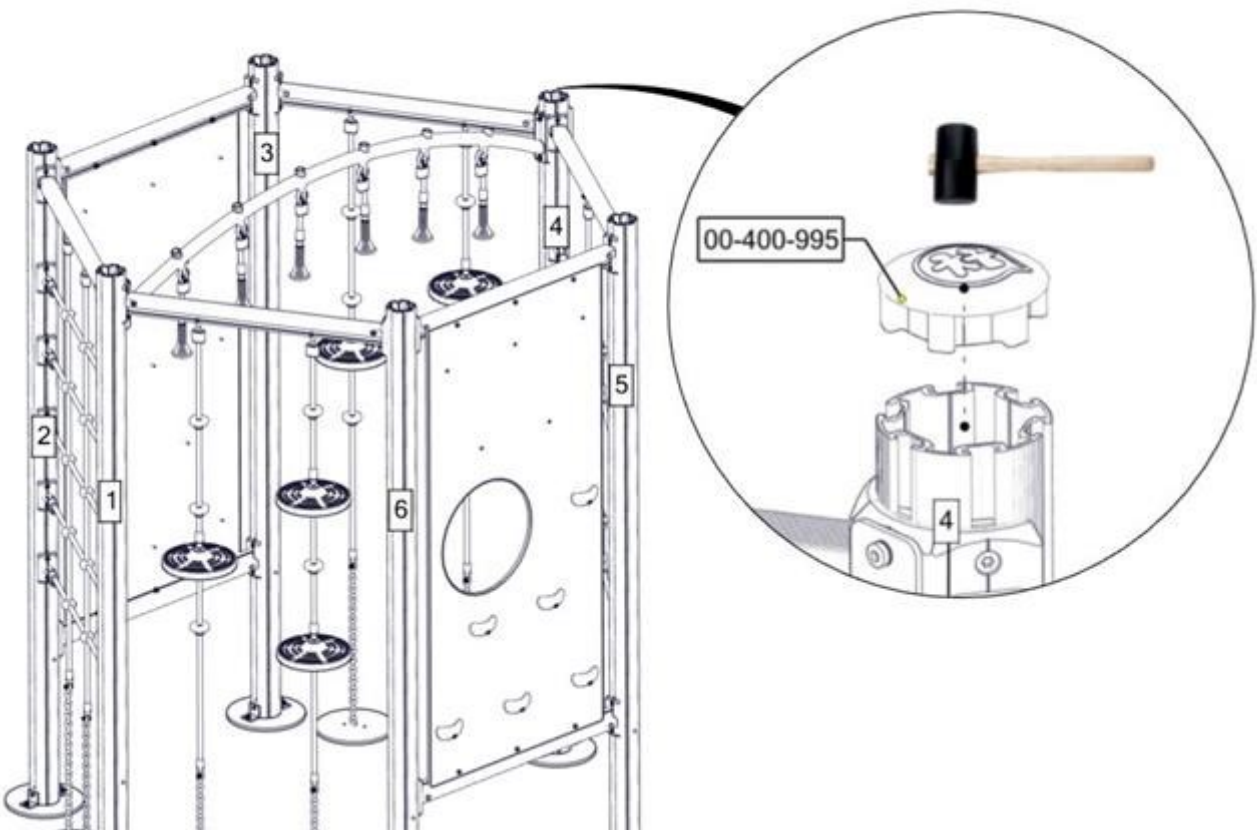

Part Name	Article nr.	Qty
Monkeyseats Sett Sort/Grønn	07-500-379K	1





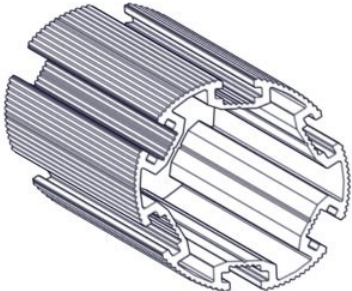



Før utstyret tas i bruk / Before play begins / Innan lekredskapet tas i bruk	
N	<ul style="list-style-type: none"> • Påse at fallunderlag er utlagt i henhold til gjeldende regler eller vår anbefaling • Fjern alle monteringshjelpemidler (rester av betong, planker, paller, plast, og lignende) • Før utstyret tas i bruk, burde man sjekke at det ikke er fare for at anorakksnorer og lignende som kan hekte seg fast noen steder på lekeapparatet. (Vedlagte snor med dobbe (kneledd) kan brukes til å sjekke at dette er i orden. Se vedlagte veiledning for bruk av denne. Dette gjøres for å oppdage eventuelle feilmonteringer.?) • NB! Bør stå i 2-3 dager før bruk
UK	<ul style="list-style-type: none"> • Make sure the area and depth of safer surfacing are according to the current standard, or to the manufacturer's recommendation • Make sure all tools and surplus materials are removed before play begins • PS! When complete, allow 2-3 days for the concrete to set before use
S	<ul style="list-style-type: none"> • Kontrollera att fallunderlag är utlagt enligt gällande regler eller vårt rekomenation • Ta bort alla monteringshjälpmiddel (rester av betong, plankor, pallar, plast och liknande) • Innan lekredskapet används, kontrollera att anoracksnoddar eller kläder/delar av kläder eller liknande inte kan fastna i några delar på redskapet. (Den bipackade "knävringen" kan man med fördel användas för denna kontroll. • Detta görs för att upptäcka eventuella felmonteringar.)

Boltepakker for / Boltpackage for / Bultpaket för

Sign. _____

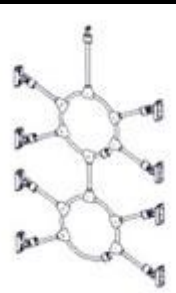
6-Kant Grå/Grønn 14-101-019	Navn	Artnr/ dimensjon	Ant	Lev
	Produktmerke	07-500-500 (Se egen delmontering)	1	
	Stolpe Ø110 L=2700 (2100-600) Grå	SFA5126/2	6	
	Drager med 0gr beslag cc1143 3H cc300 Sort	07-500-373K (Se egen delmontering)	4	
	Drager med 0gr beslag cc1143 2H cc450 Sort	07-500-372K (Se egen delmontering)	2	
	Drager med 0gr beslag cc1143 2H cc300 Sort	07-500-371K (Se egen delmontering)	1	
	Drager med 0gr beslag cc1143 1 hull Sort	07-500-370K (Se egen delmontering)	1	

Boltepakker for / Boltpackage for / Bultpaket för		Sign. _____		
6-Kant Grå/Grønn 14-101-019	Navn	Artnr/ dimensjon	Ant	Lev
	Armgang Polyfix handtak 0gr Komplett L=2156 Grønn	07-500-456K (Se egen delmontering)	1	
	Klatreplate med hull Komplett Grå/Gul	07-500-391K (Se egen delmontering)	1	
	Klatrenett Komplett Sort/Grønn	07-500-385K (Se egen delmontering)	1	
	Klatreplate Komplett Grå/Gul	07-500-392K (Se egen delmontering)	1	
	Spidernett Komplett Sort/Grønn	07-500-378K (Se egen delmontering)	1	
	Monkeyseats Sett Sort/Grønn	07-500-379K (Se egen delmontering)	2	

Boltepakker for / Boltpackage for / Bultpaket för

Sign. _____.

6-Kant Grå/Grønn 14-101-019	Navn	Artnr/ dimensjon	Ant	Lev
	Endelokk Ø110	00-400-995	6	

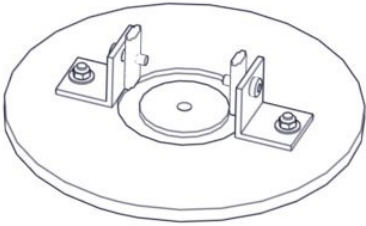
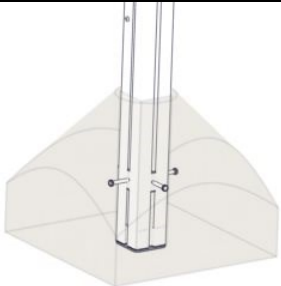
Boltepakker for / Boltpackage for / Bultpaket för		Sign. _____.		
6-Kant Grå/Grønn 14-101-019	Navn	Artnr/ dimensjon	Ant	Lev
	Fundament Nedgravning			
	Fundamentplate 1x110 stolpe komplett	07-400-101K (Se egen delmontering)	6	
	Fundament Støp			
	Støpefundament	00-003-111K (se egen delmontering)	6	

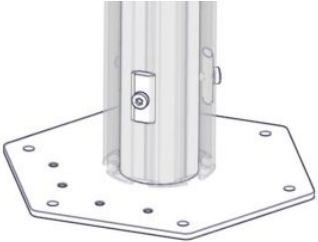
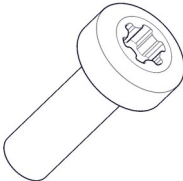
Boltepakker for / Boltpackage for / Bultpaket för		Sign. _____		
6-Kant Grå/Grønn 14-101-019	Navn	Artnr/ dimensjon	Ant	Lev
	Overflatemon- tering			
	Fundament 1x 110 stolpe for betongdekke	00-003-113K (Se egen delmontering)	6	
	Stolpe Ø110 må kappes	SFA5126/1	(6)	
	Bruk kortere bolter når nett skal monteres.	04-000-016	8	

MTK: 27-05-2021

Oppdatert sikkerhetssone. Fra 2 meter til 1,83 meter)

MTK 02-03-2022

Overflatefundamentering i tillegg