

**N****Monteringsanvisning****EN****Assembly Instructions****S****Monteringsanvisning**

Produkt nr. / Product no. / Produkt nr.

**14-101-020****Grå/Grønn**

Ord. nr. \_\_\_\_\_

Dato. \_\_\_\_\_

Sign. \_\_\_\_\_

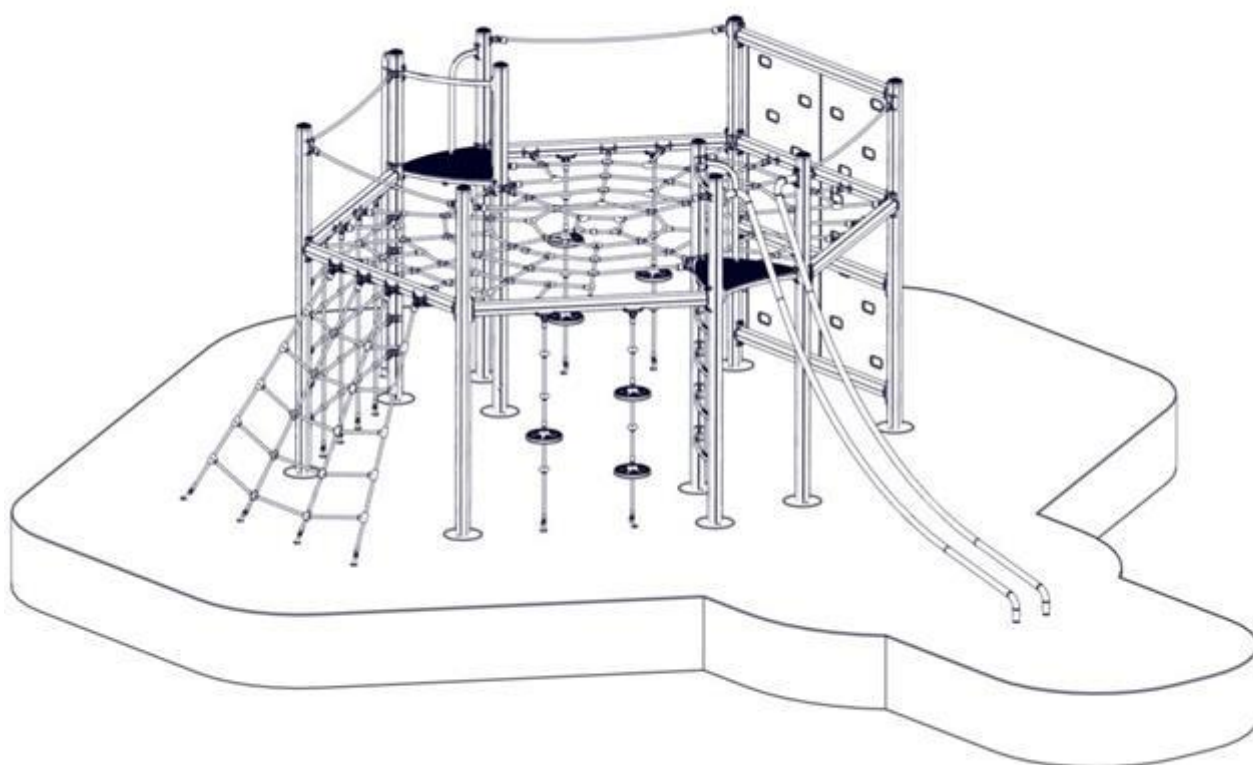
**søve**

Søve AS  
Grønnvoldveien 290  
3830 Ulefoss - Norway  
Tlf: +47 35 94 65 65  
[www.sove.no](http://www.sove.no)

**søve**

Søve AB  
EA Rosengrensgatan 32  
421 31 Västra Frölunda  
Phone: +46 (0)31 773 97 00  
[www.sove.se](http://www.sove.se)

## Monteringstips / Assembly Advice / Monteringsstips

N

- Les monteringsanvisningen nøye før montering.
- Monter elementene i rekkefølgen som vist.
- Boltene bør ikke skrues for hardt til før alt er montert, vatret og loddet. Skru så boltene til.
- NB! Ved bruk av drill, kan boltene ryke.
- På grunn av at solen kan gjøre rutsjeflaten veldig varm, bør rutsjebanens utløp vende mot nord-øst eller nord-vest.
- Er lekeutstyret plassert i naturlige ferdselstraséer må området sikres mot gjennomgang.
- Innspringningshinder bør vurderes rundt lekeapparater hvor det er stor bevegelse, f.eks. ved huskestativ.
- Det bør være fritt innsyn til lekeutstyr som er beregnet for barn under 3 år.

**NB! Under monteringsarbeidet må utstyr, som ikke er forankret forsvarlig i bakken, sikres slik at det ikke velte.**

**Området må avstenges under montering av apparatene med sperrebånd eller lignende.**

EN

- Read the instruction carefully before assembling the play unit.
- Assemble the components in the sequence shown in these instructions. Fixings must not be fully tightened during assembly. Before casting the foundations, the structure must be level and plumb, at which point all fixings are tightened. PS! If use of drill, the bolts may be wrecked.
- Avoid positioning the slide facing due south because of overheating – ideal positions are facing north-east or north-west. Secure the construction-area to prevent people from walking through it.
- Consider installing barriers around play-equipment which gives rise to a lot of activity – i.e. swings.
- Ensure that clear vision is possible across the play area so that supervision is possible from any position, particularly where children under 3 years of age will be playing.

**NB! During assembly of the equipment, ensure that all structures are securely propped, especially when left overnight. Also ensure that equipment is supported**

**Monteringstips / Assembly Advice / Monteringsstips****S**

- Läs monteringsanvisningen noga före montering.

- Montera delarna i den ordningen som anvisas
- Skruvarna bör inte skruvas för hårt tills allt är monterat, i våg och lodat.









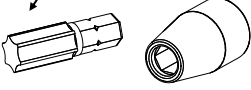

OBS! Används elektrisk skruvdragare, kan bulten gå sönder. Hårdra därför manuellt!

- Solen kan göra att rutchbanan blir väldigt varm. Banans nedfart rekommenderas att vändas i norrlig riktning
- Om lekplatsen placeras vid en gångväg mm bör området säkras mot genomfart av gående och cyklister.
- Insprängningshinder bör placeras runt lekutrustning med stor rörelse, t ex, gungställning.
- Det bör vara fri insyn till lekutrustning beräknat till barn under 3 år.

**OBS! Under monteringsarbete bör utrustningen som inte ska förankras i marken, ställs så att den inte kan välta.**

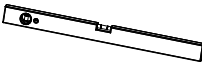
**Området måste spärras när lekutrustningen byggs upp, med avspärrningsband eller liknande.**

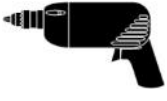
**Nødvendig verktøy / Tools required / Nödvändiga verktyg**

<p>(N)</p> <p>(EN)</p> <p>(S)</p>	<p>(A)</p> 	<p>(B)</p>  <p>Torx Nr 45 High quality</p> 	<p>(C)</p>  <p>13 + 17mm</p> 	<p>(D)</p> 	<p>(E)</p> 
		<p>Metermål Metric measure Tumstock</p> 	<p>16 V</p> 	<p>Merkebånd Mark ribbon Märkeband</p> 	<p>5 mm 6 mm</p> 

**Nødvendig antall personer / Number of persons required / Rekommenderad antal personer**





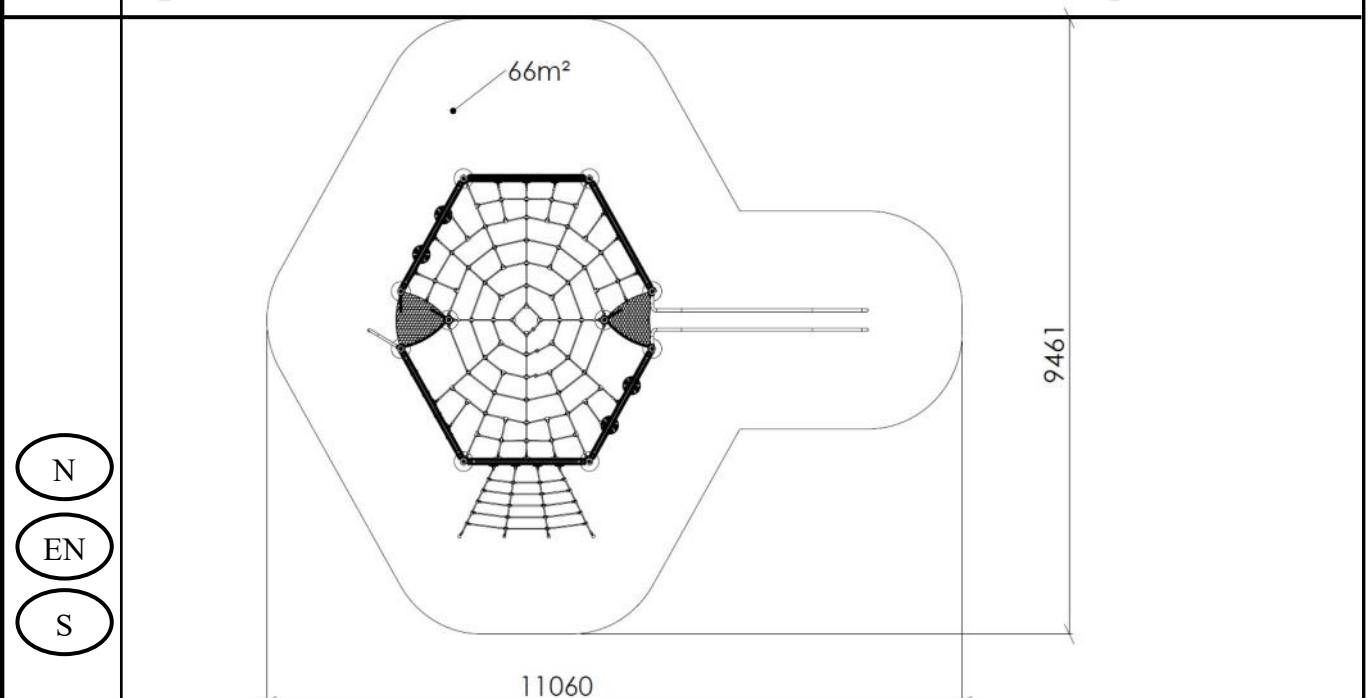

<p>(N)</p> <p>(EN)</p> <p>(S)</p>	
-----------------------------------	---



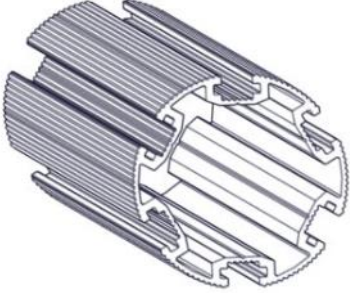



**Anbefalt arealbehov ved montering / Recommended working space / Rekommenderad arealbehov vid montering**



**Boltepakker for / Boltpackage for / Bultpaket för**

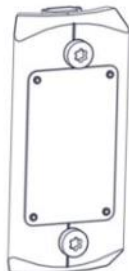



Sign. \_\_\_\_\_



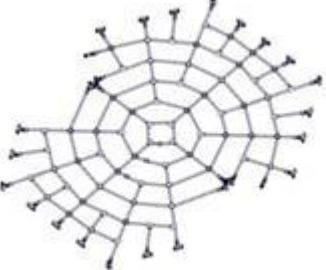

Gaustablikk 14-101-020	Navn	Artnr/dimensjon	Ant	Lev
	Stolpe Ø110 L=3450 600-2850 L= 3450 grå	SFA5126/2	10	
	Endelokk til stolpe Ø110	00-400-995	10	
	Gulv 3-kant 1 Sperrerør 1 hul horisontal CC880 Grå	07-300-104K (se egen delmontering)	1	
	Gulv 3-kant 1 konkav 1 Sperrerør 1 hul horisontal CC880 Grå	07-300-105K (se egen delmontering)	1	
	Sperrerør bøyd Lengde = 750 Uten hull Grønn	07-500-072K (se egen delmontering)	6	
	Sluse H= 790 Grønn	07-500-074K (se egen delmontering)	3	

<b>Boltepakker for / Boltpackage for / Bultpaket för</b>		Sign. _____		
<b>Gaustablikk 14-101-020</b>	<b>Navn</b>	<b>Artnr/dimensjon</b>	<b>Ant</b>	<b>Lev</b>
	Slider	07-200-010K (se egen delmontering)	1	
	Brannstang Gulv 1,9m L=3000 Grå	07-200-037K (se egen delmontering)	1	
	Produktmerke Ø110 stolpe	07-500-500 (se egen delmontering)	1	
	Drager A Grå	07-300-190K (se egen delmontering)	1	
	Drager B +3xC Grå + klatrevegg Grå	07-300-191K (se egen delmontering)	1	
	Drager D Grå + monkeyseats rød	07-300-193K (se egen delmontering)	1	

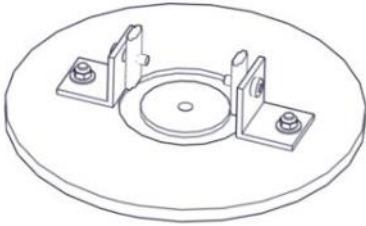

**Boltepakker for / Boltpackage for / Bultpaket för**

Sign. \_\_\_\_\_.

Gaustablikk 14-101-020	Navn	Artnr/dimensjon	Ant	Lev
	Drager E Grå + Vertikal nett sort	07-300-194K (se egen delmontering)	1	
	Drager F Grå Skrå nett sort	07-300-195K (se egen delmontering)	1	
	Drager G Grå Monkeyseats Sort	07-300-196K (se egen delmontering)	1	
	Taknett 8-kant 14-100-020 Sort/Grønn	07-500-338K (se egen delmontering)	1	
	Tau rekkverk Med beslag 0gr 30 gr	07-500-332K (se egen delmontering)	4	
	Tau rekkverk Med beslag 0 gr	07-500-331K (se egen delmontering)	1	

<b>Boltepakker for / Boltpackage for / Bultpaket för</b>		Sign. _____		
<b>Gaustablikk 14-101-020</b>	<b>Navn</b>	<b>Artnr/dimensjon</b>	<b>Ant</b>	<b>Lev</b>
	<b>Fundament Støpefrie</b>			
	Fundamentplate 1xØ110 stolpe	07-400-101K (se egen delmontering)	10	
	Sperrerør rett Lengde = 750 Uten hull Sort	07-500-075K (se egen delmontering)	5	
	<b>Fundament Betong</b>			
	Fundament Ø110 betong	00-003-111K (se egen delmontering)	10	
	Sperrerør rett Lengde = 750 Uten hull Sort	07-500-075K (se egen delmontering)	5	



<b>Boltepakker for / Boltpackage for / Bultpaket för</b>		Sign. _____.		
<b>Gaustablikk 14-101-020</b>	<b>Navn</b>	<b>Artnr/ dimensjon</b>	<b>Ant</b>	<b>Lev</b>
	<b>Overflatemon- tering</b>			
	Fundament 1xØ110 stolpe for betongdekke	00-003-113K (Se egen delmontering)	4	
	Fundament 3x110 stolpe for betongdekke	00-003-115K (Se egen delmontering)	2	
	Stolpe Ø110 må kappes Slider må kappes Brannstang må kappes	SFA5126/1 07-200-010 07-200-037	(10) (1) (1)	

**Fundamentering med betong / Foundation concrete / Förankring med betong**

- (N) Støtdempende materialer
- (EN) Impact attenuating materials
- (S) Støtdämpande material Ref NS-EN 1176-1 §4.2.8.5

- (N) Bakkenivå
- (EN) Ground level
- (S) Marknivå

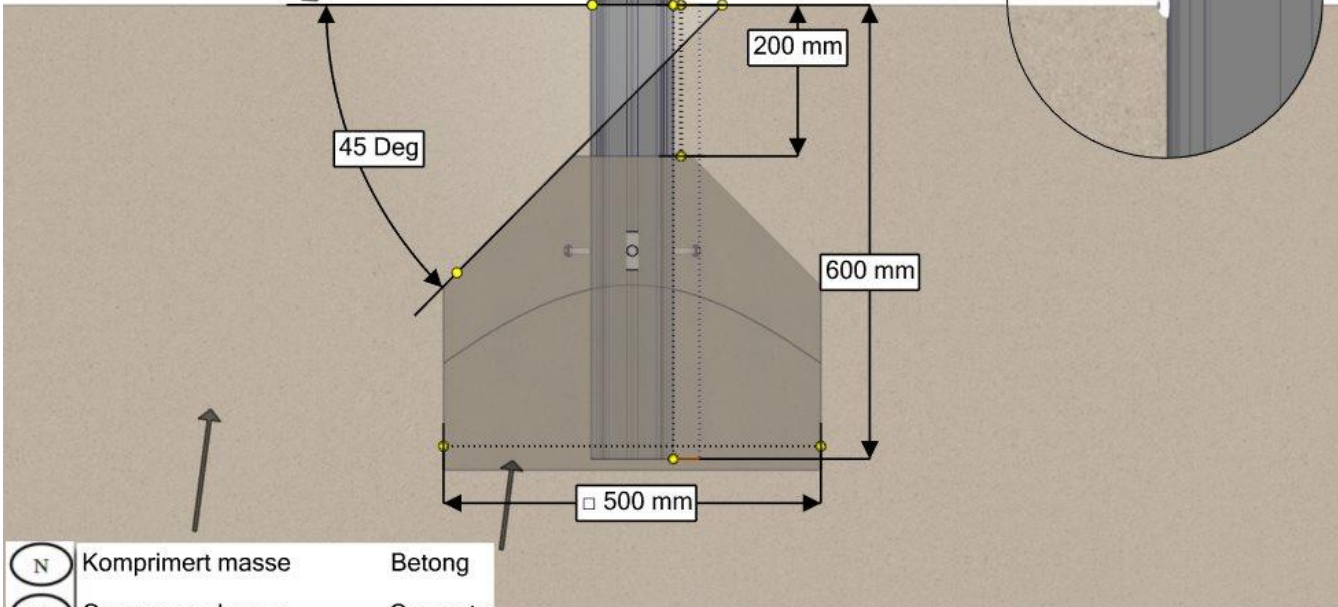
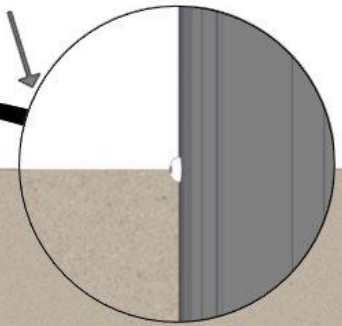

- (N) Komprimert masse Betong
- (EN) Compressed mass Concrete
- (S) Komprimerad massa Betong

**Fundamentering uten betong / Foundation without concrete / Förankring utan betong**

- (N) Støtdempende materialer Ref NS-EN 1176-1 §4.2.8.5
- (EN) Impact attenuating materials
- (S) Støtdämpande material

- (N) Bakkenivå
- (EN) Ground level
- (S) Marknivå

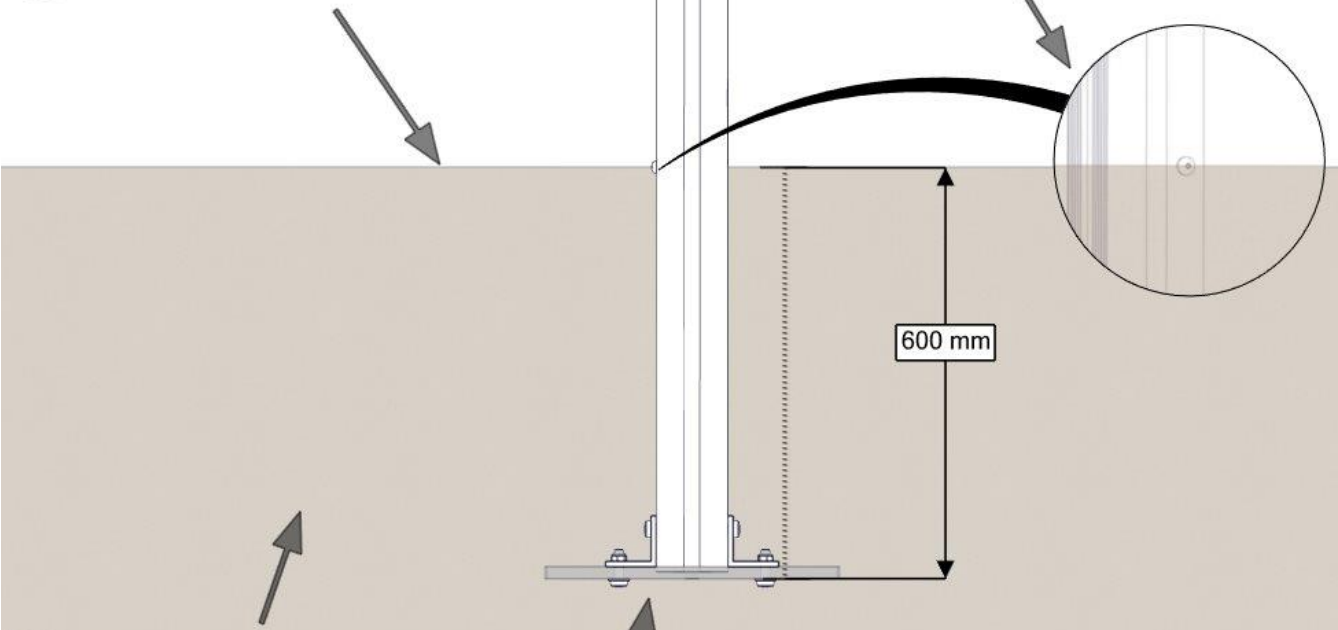

- (N) Komprimert masse Støpefri nedgraving
- (EN) Compressed mass Concrete-free anchor
- (S) Komprimerad massa Nedgravningsfundament

**Fundamentering overflate / Foundation surface / Förankring grundytan**

Ref.  
NS-EN 1176-1  
§4.2.8.5

(N) (EN) (S)  
Bakkenivå Ground level marknivå

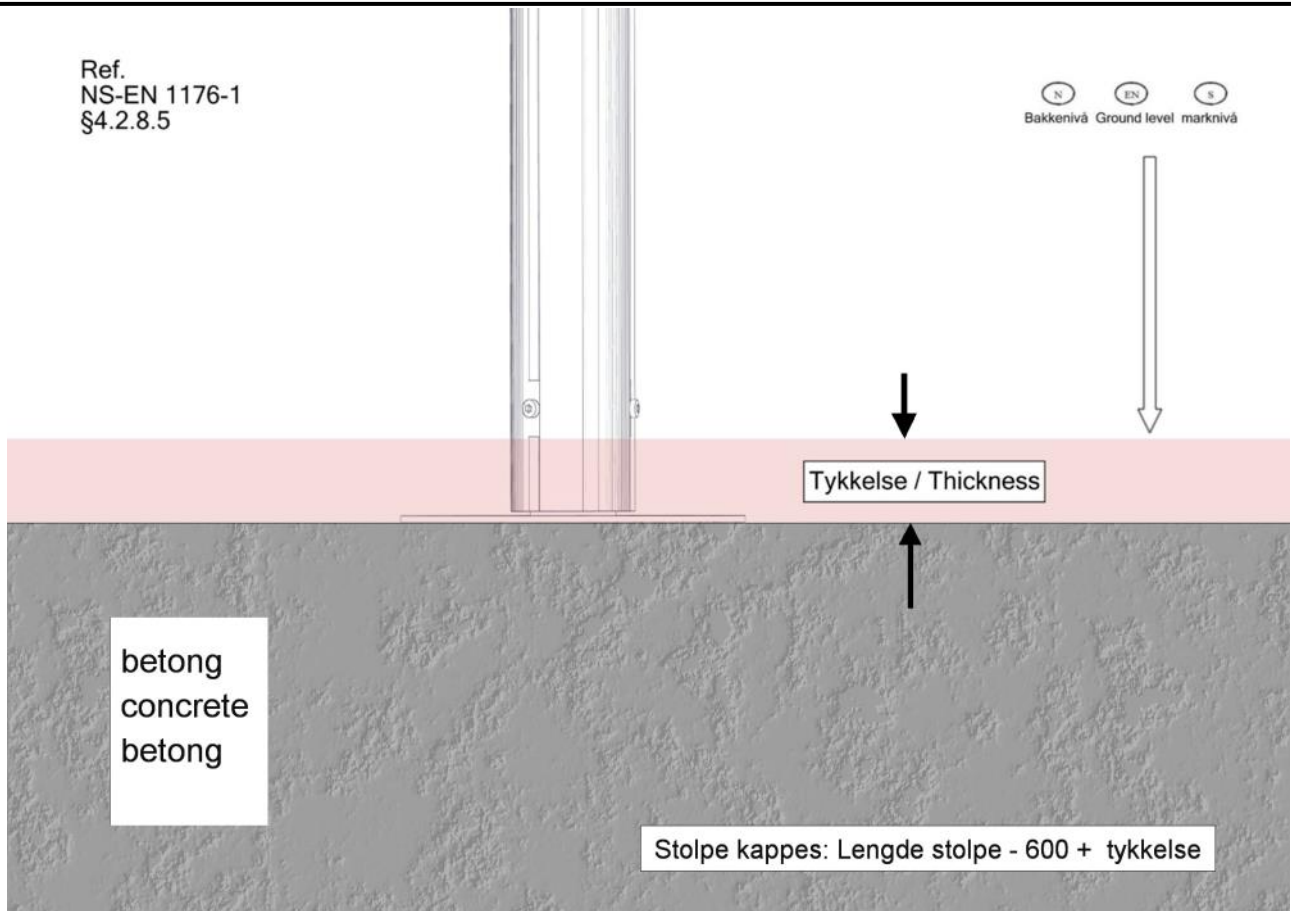

NO	Betongkvalitet	C25/30		
SE	Betongkvalitet			
EN	Concrete quality			
NO	Mengde betong		1 +0,8 for nett osv	m <sup>3</sup>
SE	Mängd betong			
EN	Amount of concrete			
NO	Fundament størrelse		0,5 x 0,5 x 0,4	m
SE	Stiftelsestorlek			
EN	Foundation size			
NO	For sikkerhet må fundamentene med sand eller myk jord være minst 50% større i areal			
SE	För säkerheten måste grunden med sand eller mjuk jord vara minst 50% större i området			
EN	For safety, the foundations with sand or soft soil must be at least 50% larger in area			
NO	Tyngste element	07-300-120	36,8	Kg
SE	Tyngsta element			
EN	Heaviest element			
NO	Største element	07-200-010	5,9x1x0,2	m
SE	Största element			
EN	Biggest element			

**N** Bolten skrues HELT igjennom aluminiumen.  
Maks dreiemoment: 30Nm

**EN** The bolt must be tightened in to the post, so that it peirces the aluminium  
Max torque: 30Nm

**S** Bulten skruvas HELT ignom aluminiumen.  
Maks vridmoment: 30Nm

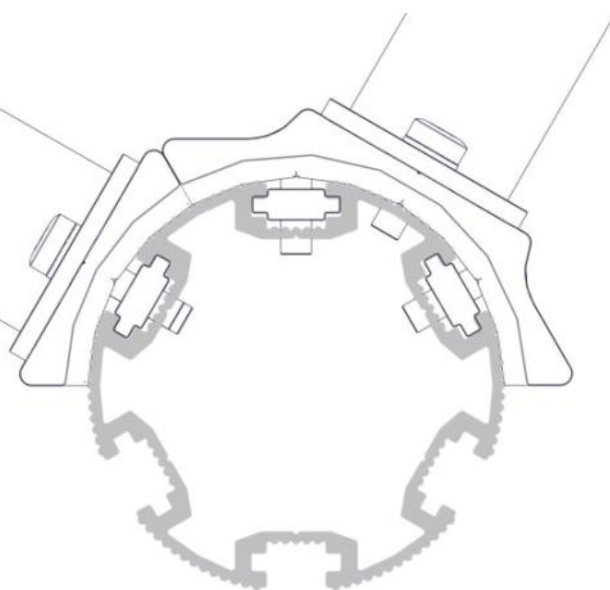

**Fallhøyder / Free height of fall / Fallhöjder**

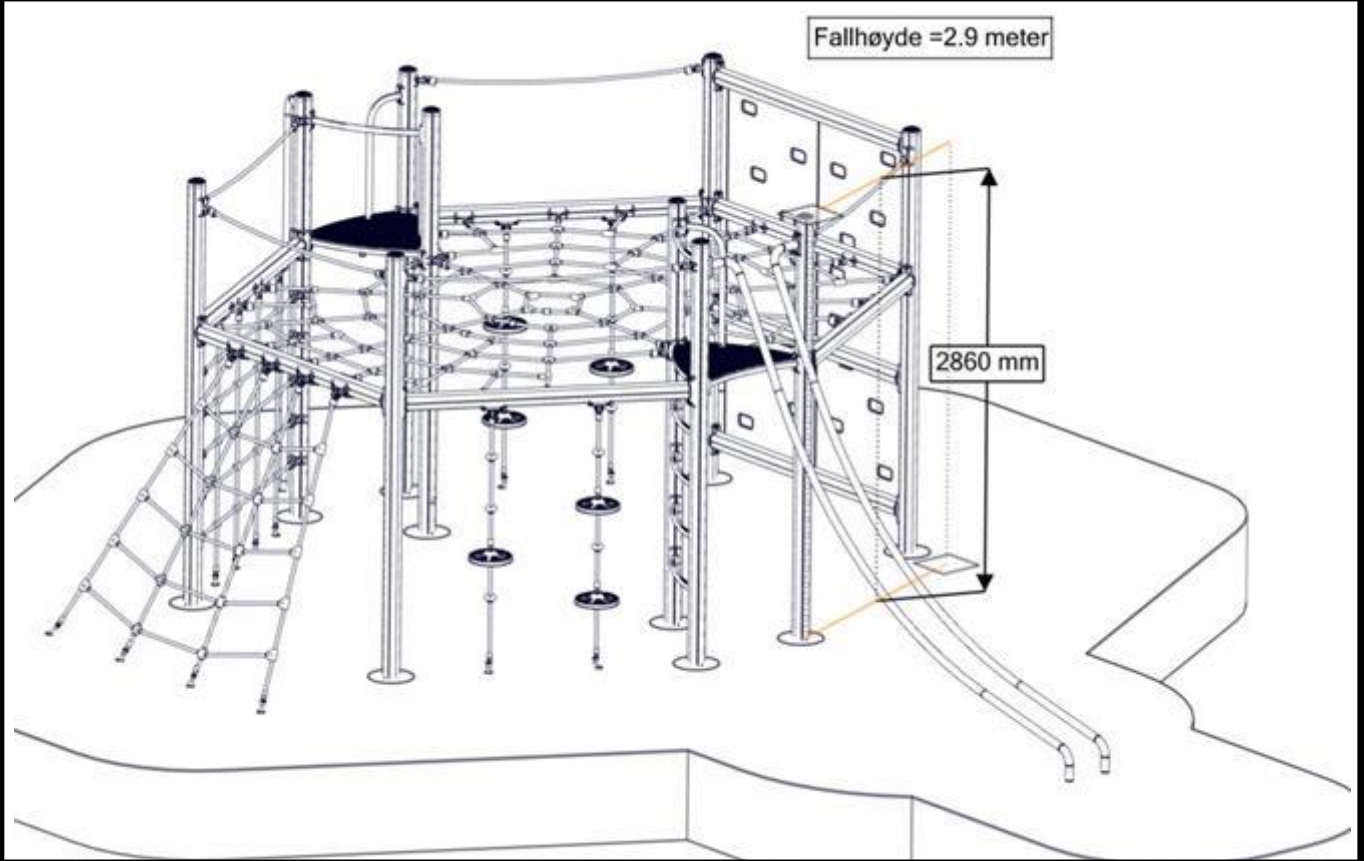

**Sikkerhetszone / Safety zone / Säkerhetszon**

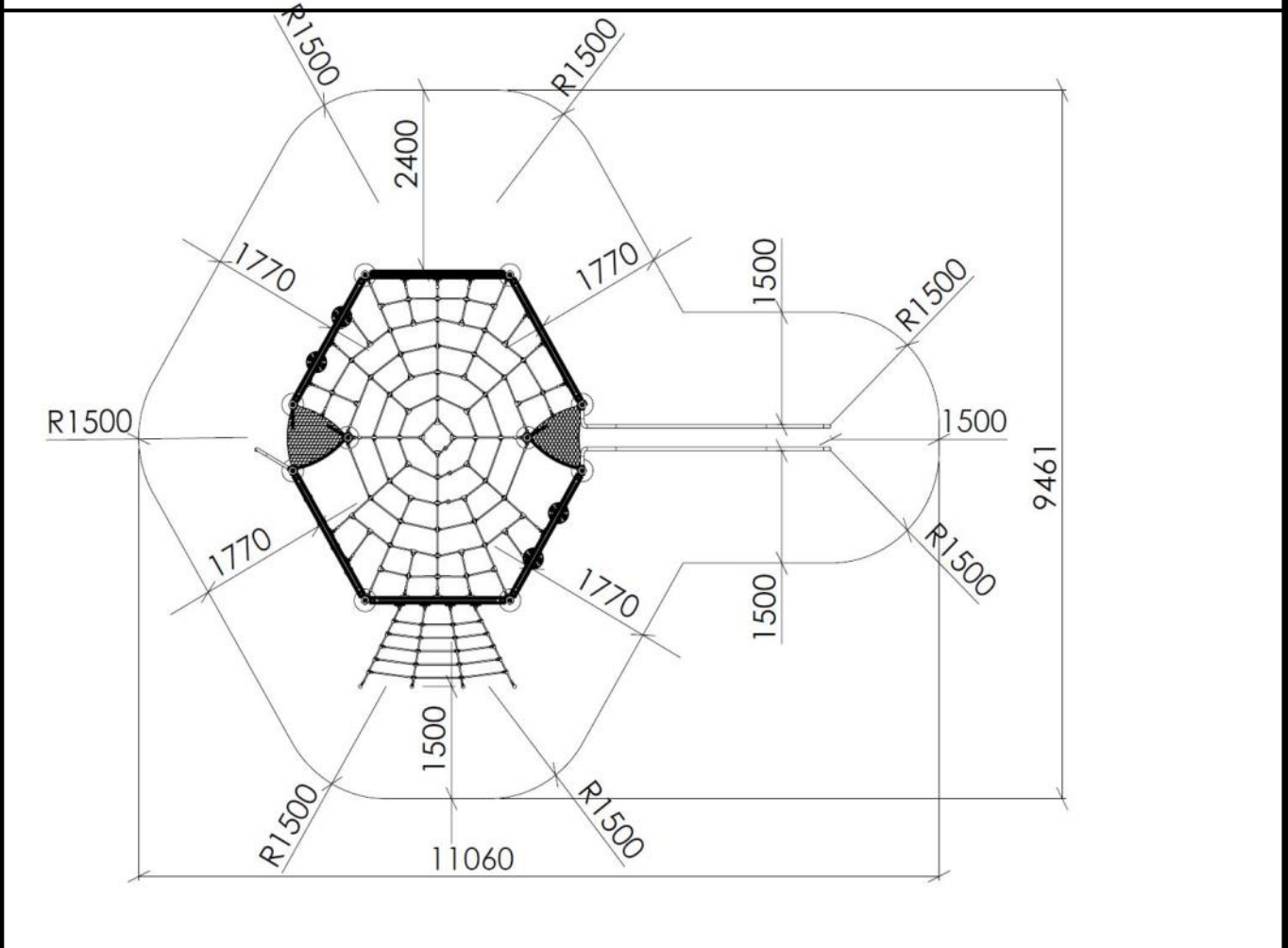

### Plassering av forankringer / Ground plan / Placering av förankringar

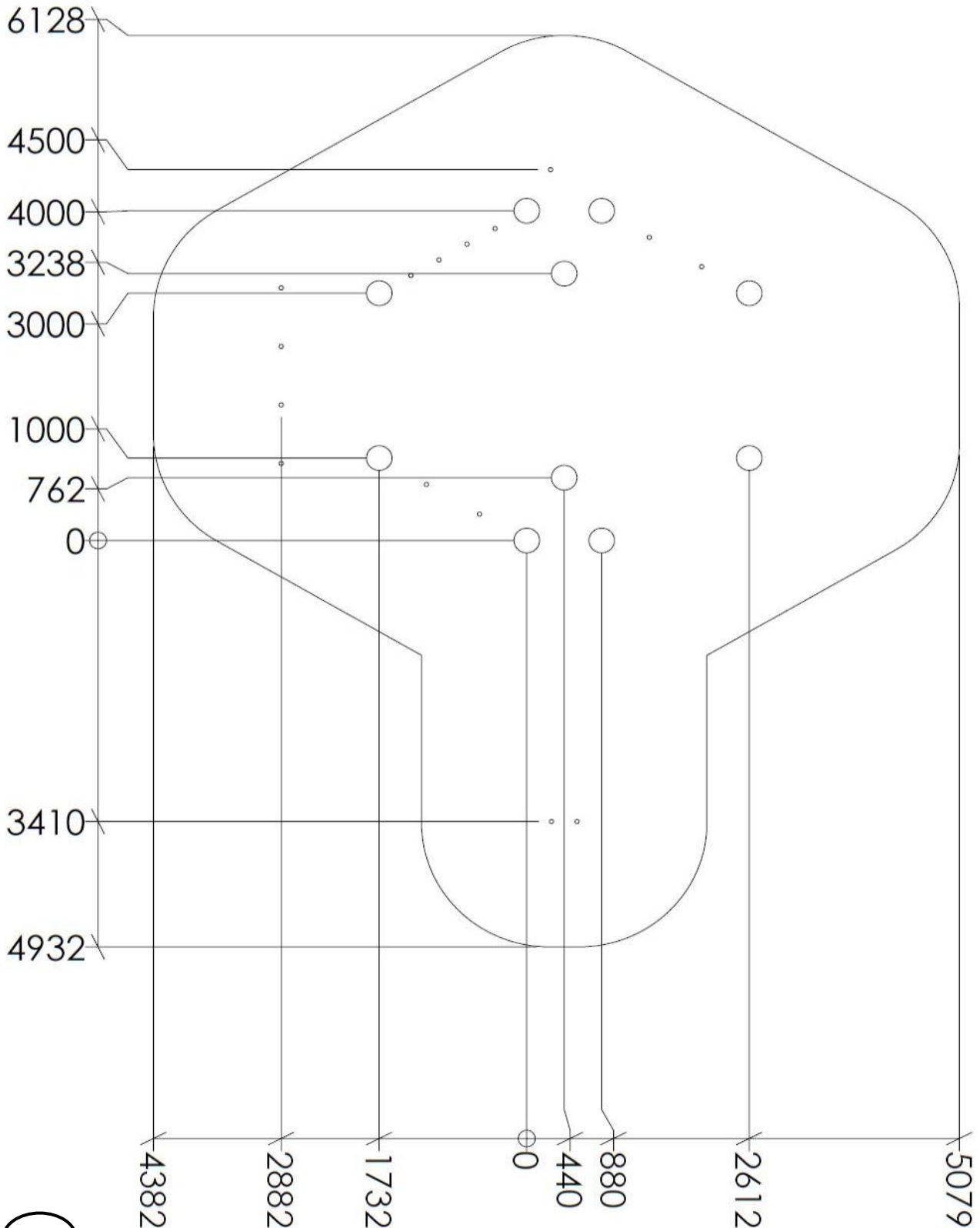

(N)

Alle mål er oppgitt i millimeter

(EN)

Scale measured in mm

(S)

Alla mått är i millimeter.

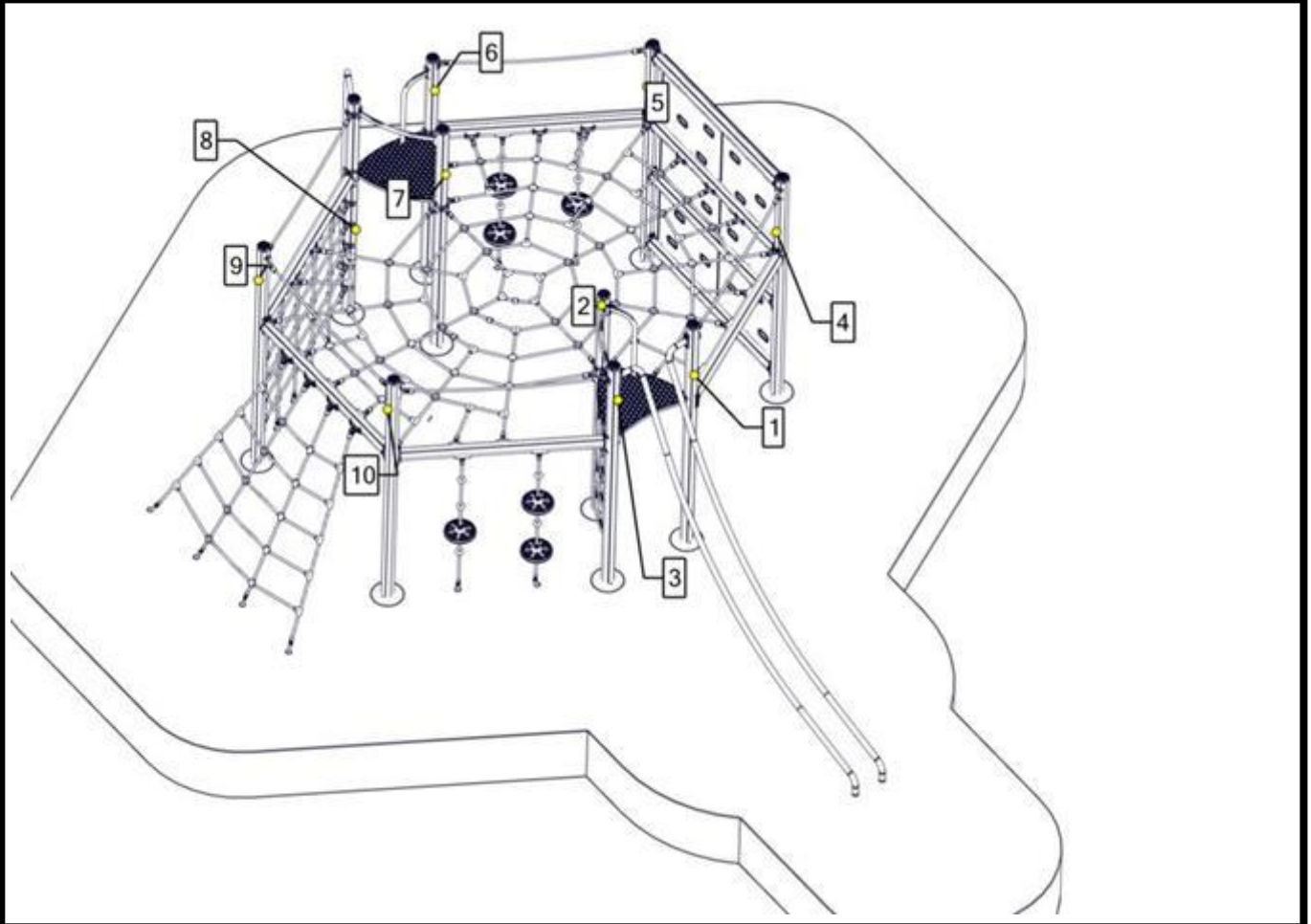
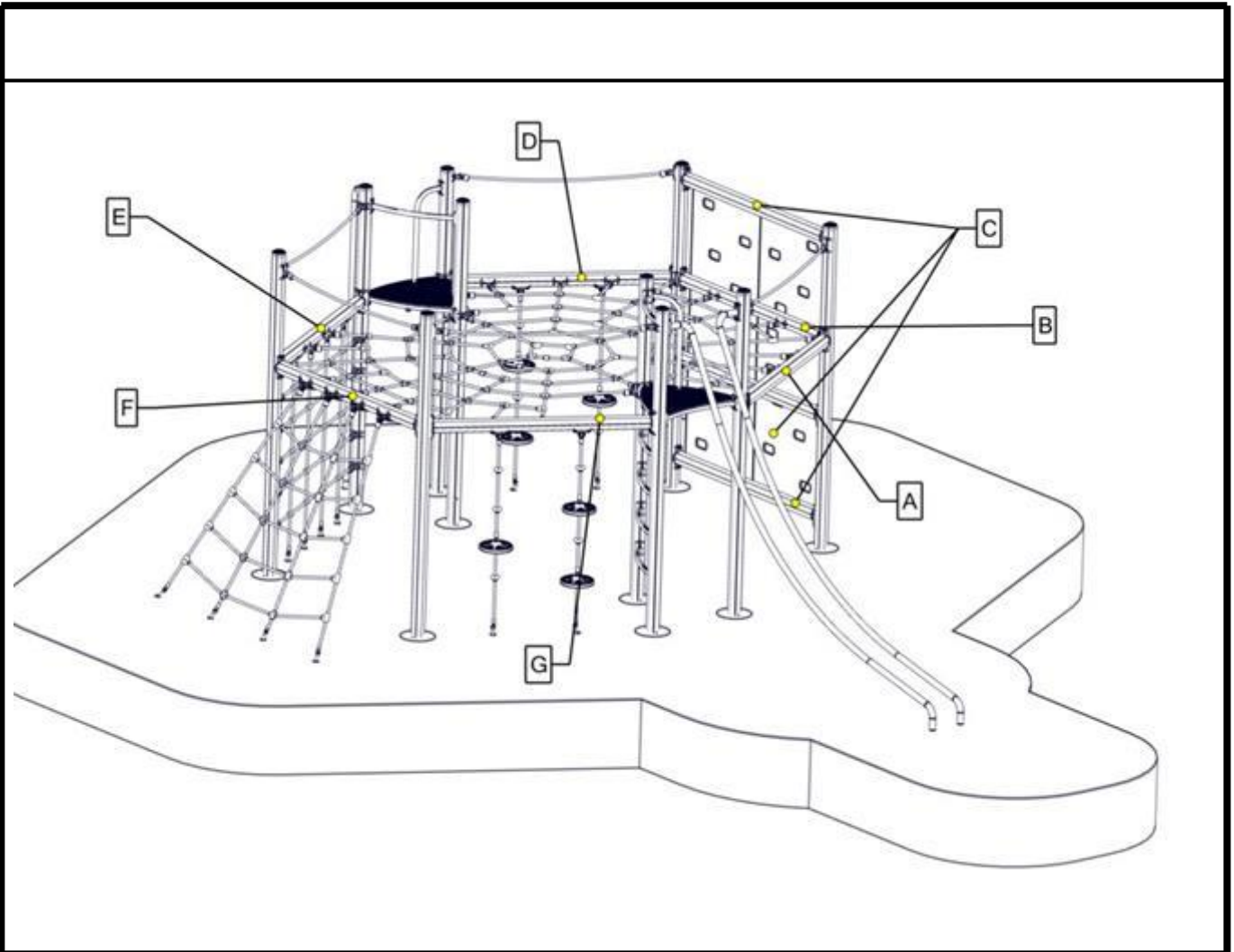

Se separat delmontering for detaljer  
See separate assembly for details  
Se separata delmontering för detaljer

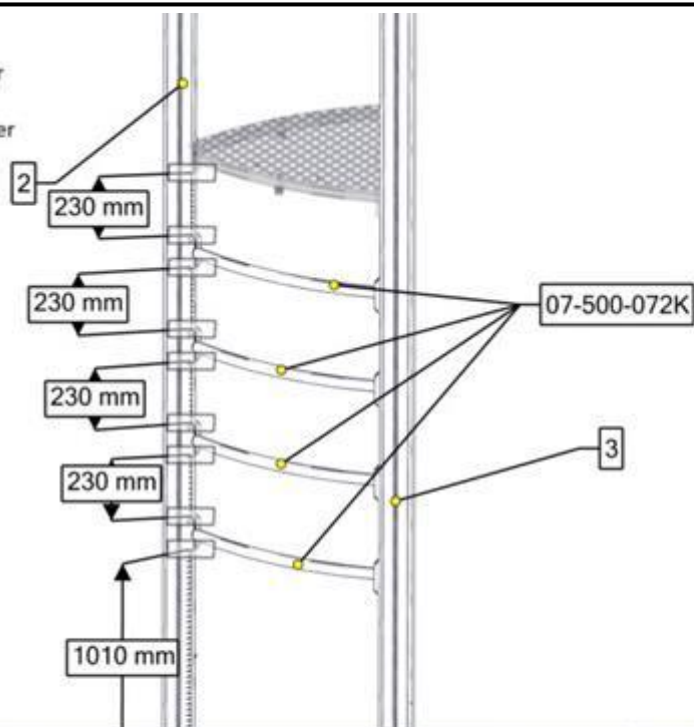

Part Name	Article nr.	Qty
Stolpe Ø110 Lengde=3450	SFA5126/2	2
Sperrerør Bøyd L=750 uten hull	07-500-072K	4

Se separat delmontering for detaljer  
See separate assembly for details  
Se separata delmontering för detaljer

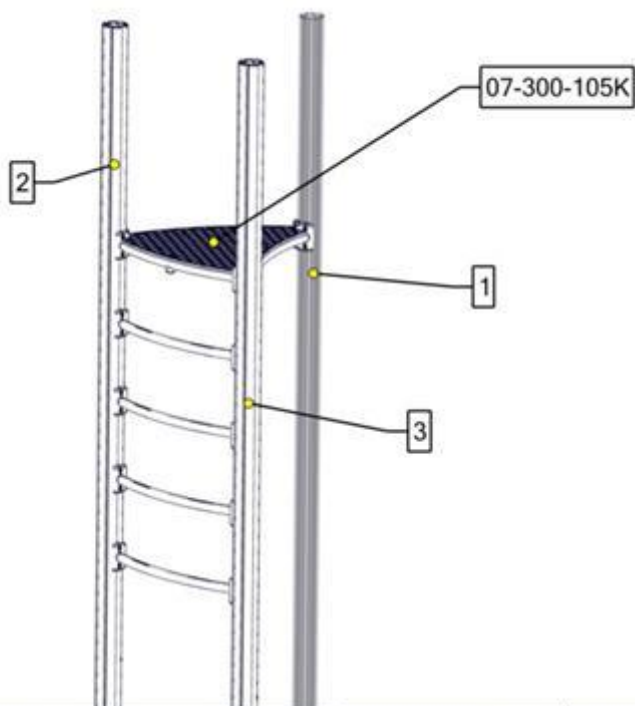

Part Name	Article nr.	Qty
Stolpe Ø110 Lengde=3450	SFA5126/2	1
Gulv 3-kant 880x880 1Konkav	07-300-105K	1



Se separat delmontering for detaljer  
 See separate assembly for details  
 Se separata delmontering för detaljer

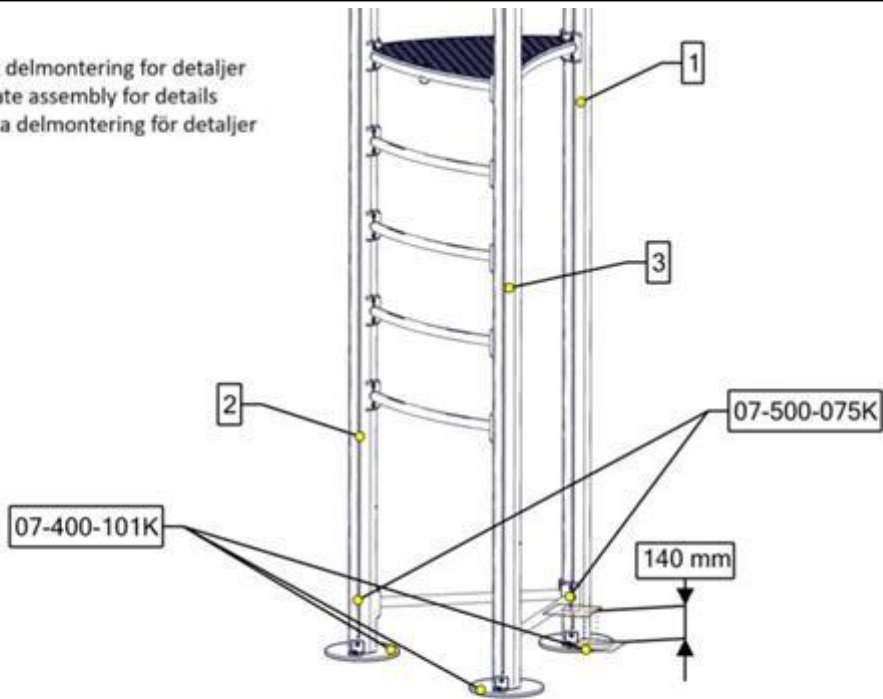

Part Name	Article nr.	Qty
Sperrerør rett L=750 uten hull	07-500-075K	2
Fundamentplate 1x110 stolpe komplett	07-400-101K	3

Se separat delmontering for detaljer  
 See separate assembly for details  
 Se separata delmontering för detaljer

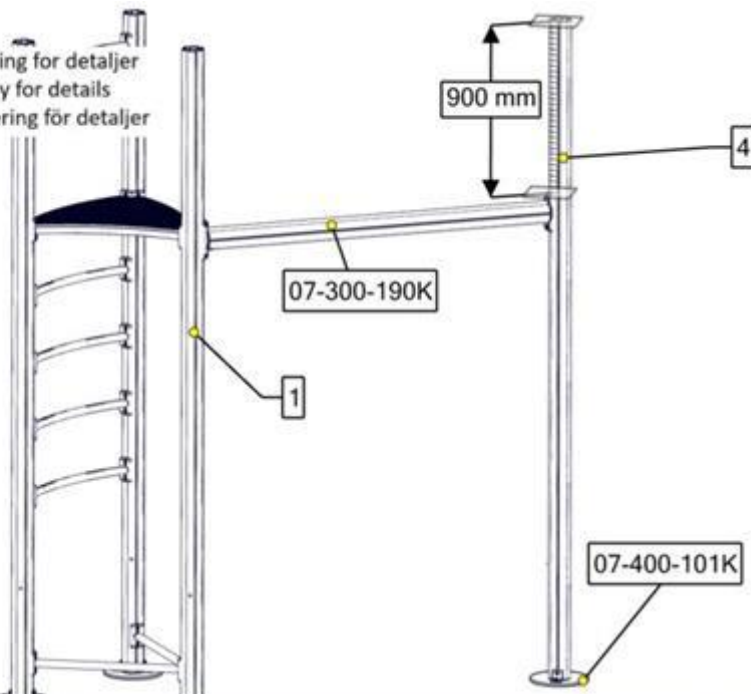

Part Name	Article nr.	Qty
Stolpe Ø110 Lengde=3450	SFA5126/2	1
Fundamentplate 1x110 stolpe komplett	07-400-101K	1
Drager A inkl beslag	07-300-190K	1

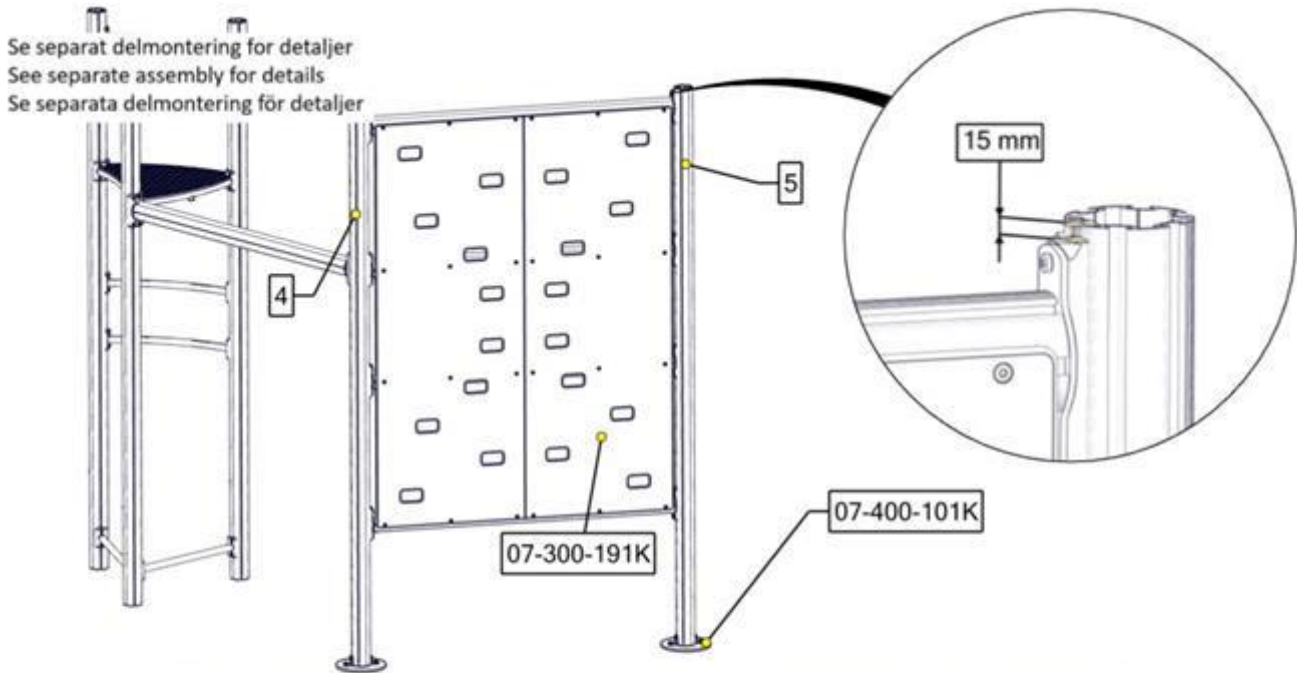

Part Name	Article nr.	Qty
Stolpe Ø110 Lengde=3450	SFA5126/2	1
Fundamentplate 1x110 stolpe komplett	07-400-101K	1
Drager B + 3xC inkl klatrevegg	07-300-191K	1

Se separat delmontering for detaljer  
See separate assembly for details  
Se separata delmontering för detaljer

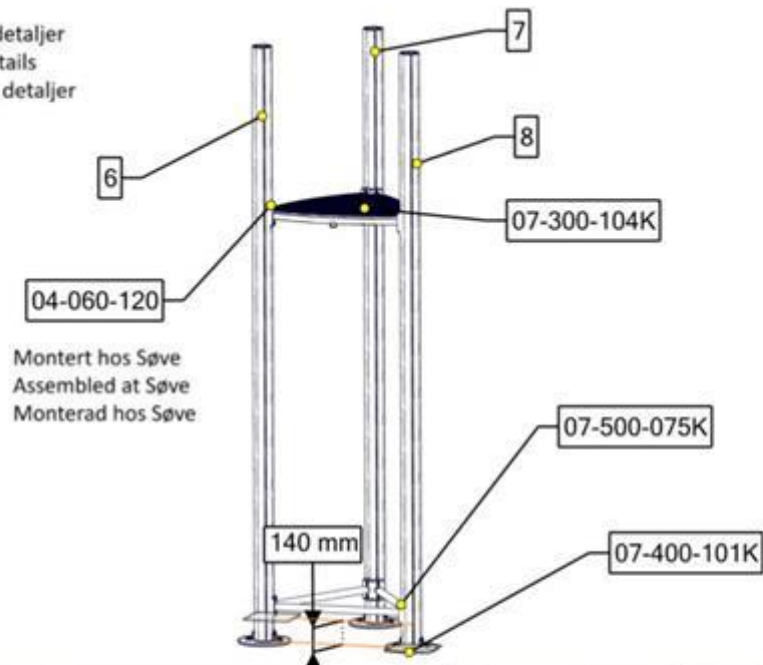

Part Name	Article nr.	Qty
Stolpe Ø110 Lengde=3450	SFA5126/2	3
Sperrerør rett L=750 uten hull	07-500-075K	3
Gulv 3-kant 880x880 Standard	07-300-104K	1

Se separat delmontering for detaljer  
 See separate assembly for details  
 Se separata delmontering för detaljer

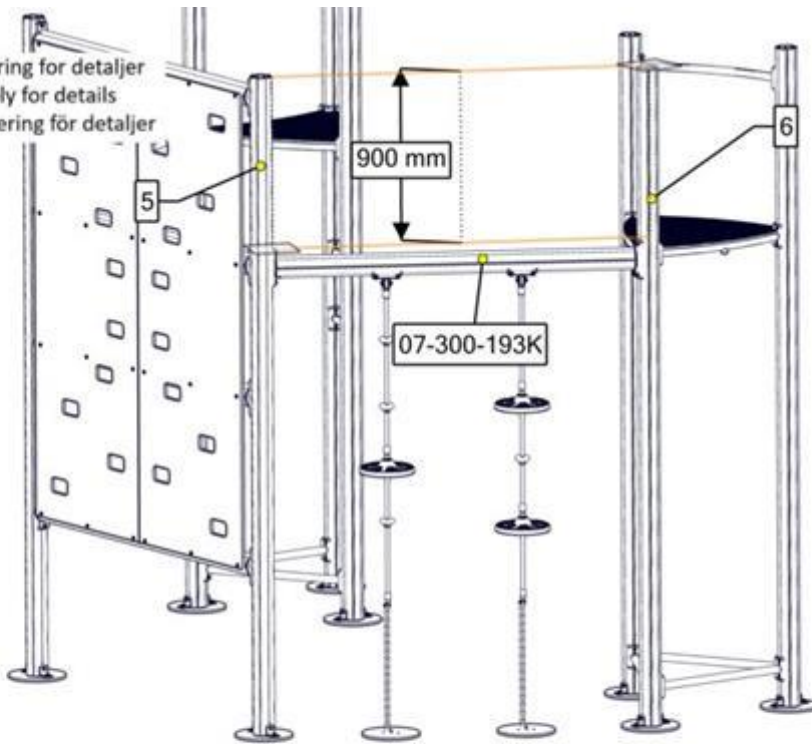

Part Name	Article nr.	Qty
Drager D inkl monkeyseats	07-300-193K	1

Se separat delmontering for detaljer  
 See separate assembly for details  
 Se separata delmontering för detaljer

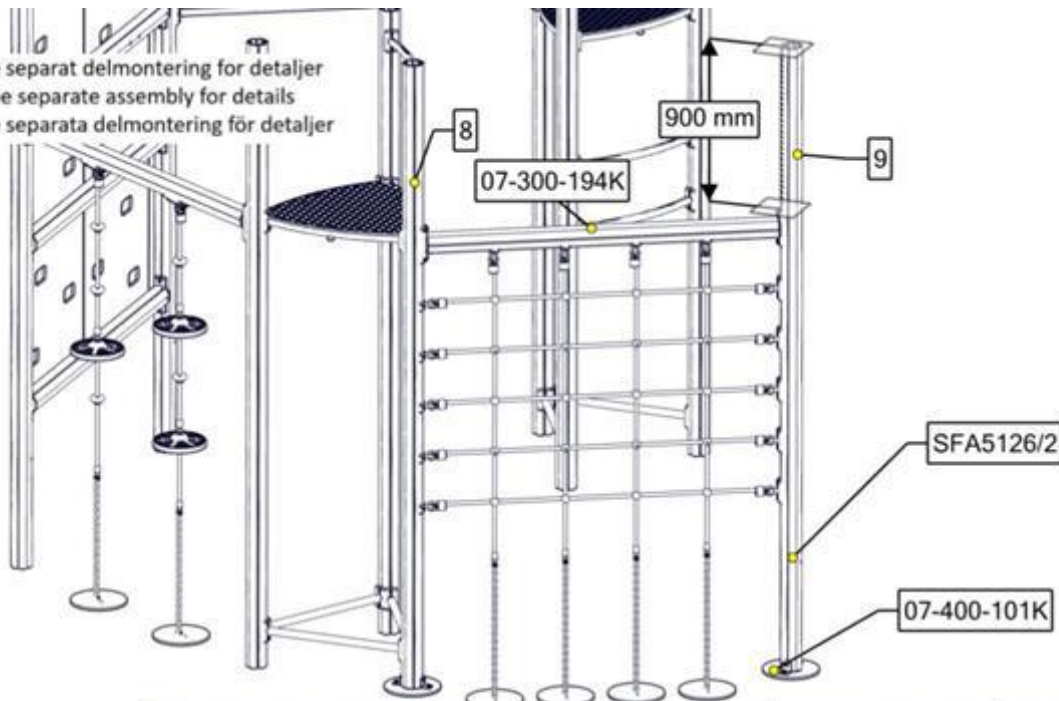

Part Name	Article nr.	Qty
Stolpe Ø110 Lengde=3450	SFA5126/2	1
Fundamentplate 1x110 stolpe komplett	07-400-101K	1
Drager E inkl vertikall nett	07-300-194K	1

Se separat delmontering for detaljer  
 See separate assembly for details  
 Se separata delmontering för detaljer

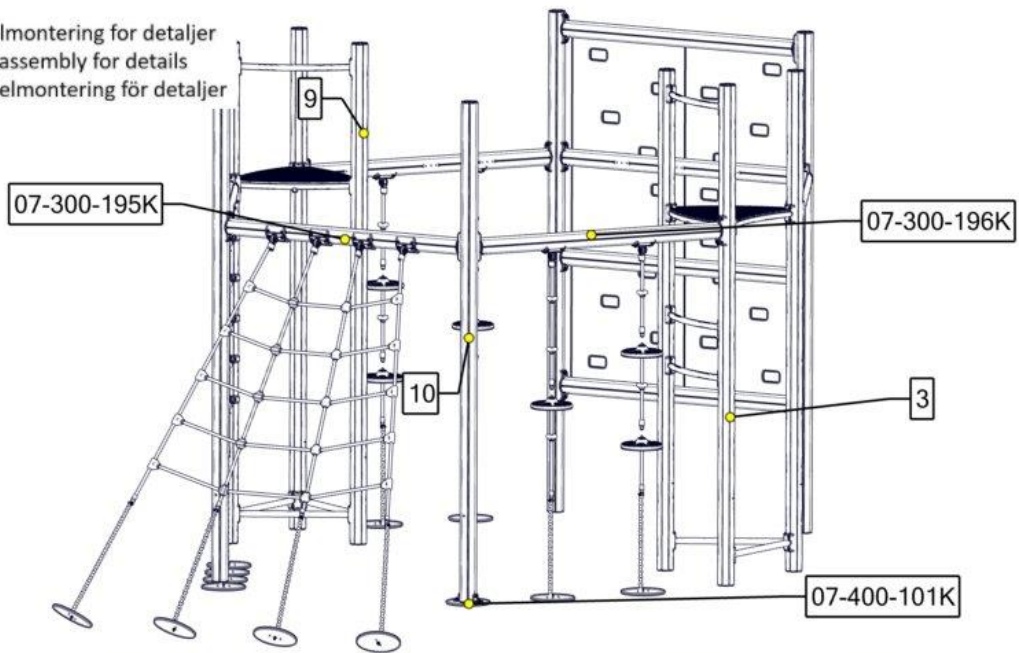

Part Name	Article nr.	Qty
Stolpe Ø110 Lengde=3450	SFA5126/2	1
Fundamentplate 1x110 stolpe komplett	07-400-101K	1
Drager G inkl monkeyseats	07-300-196K	1
Drager F inkl skrå nett	07-300-195K	1

Se separat delmontering for detaljer  
 See separate assembly for details  
 Se separata delmontering för detaljer

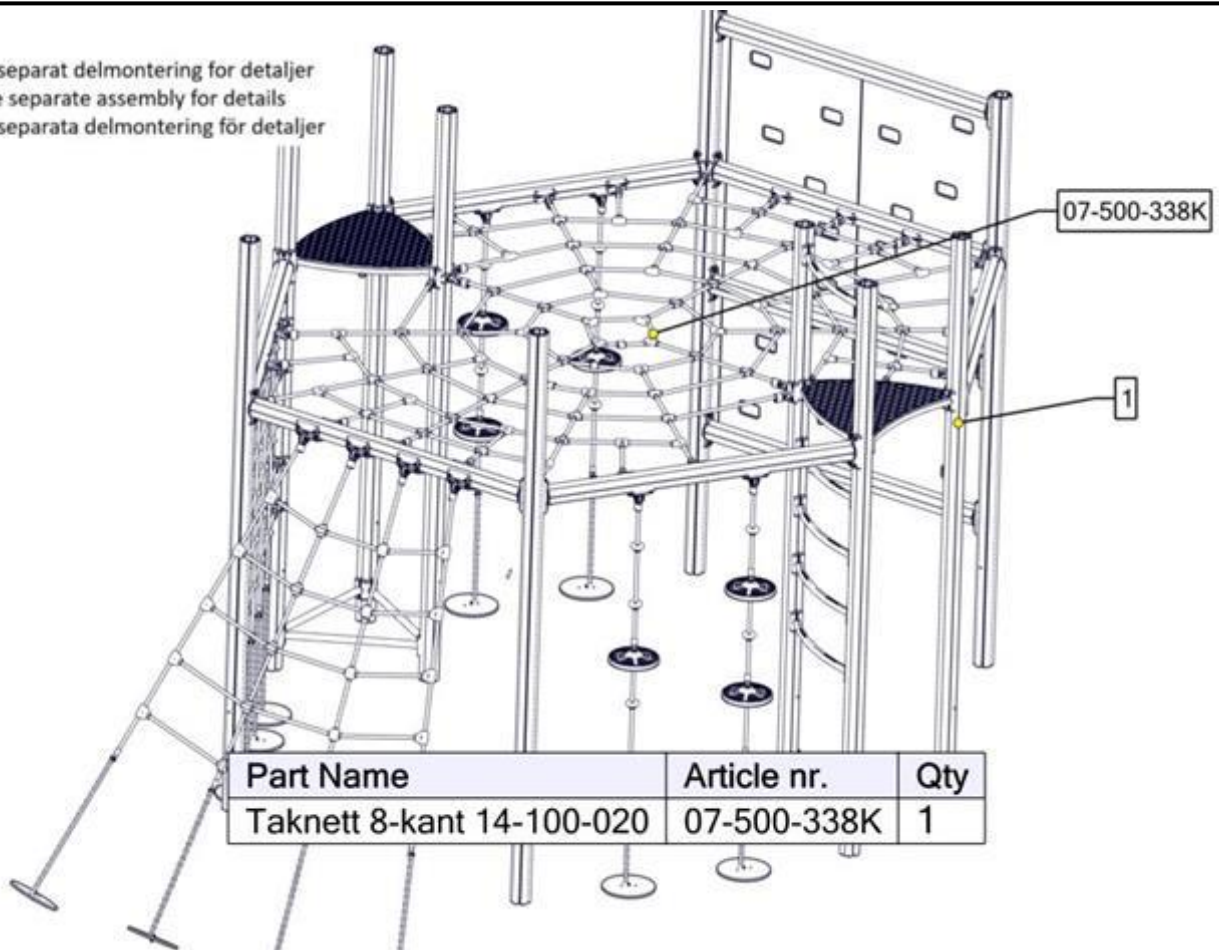

Part Name	Article nr.	Qty
Taknett 8-kant 14-100-020	07-500-338K	1

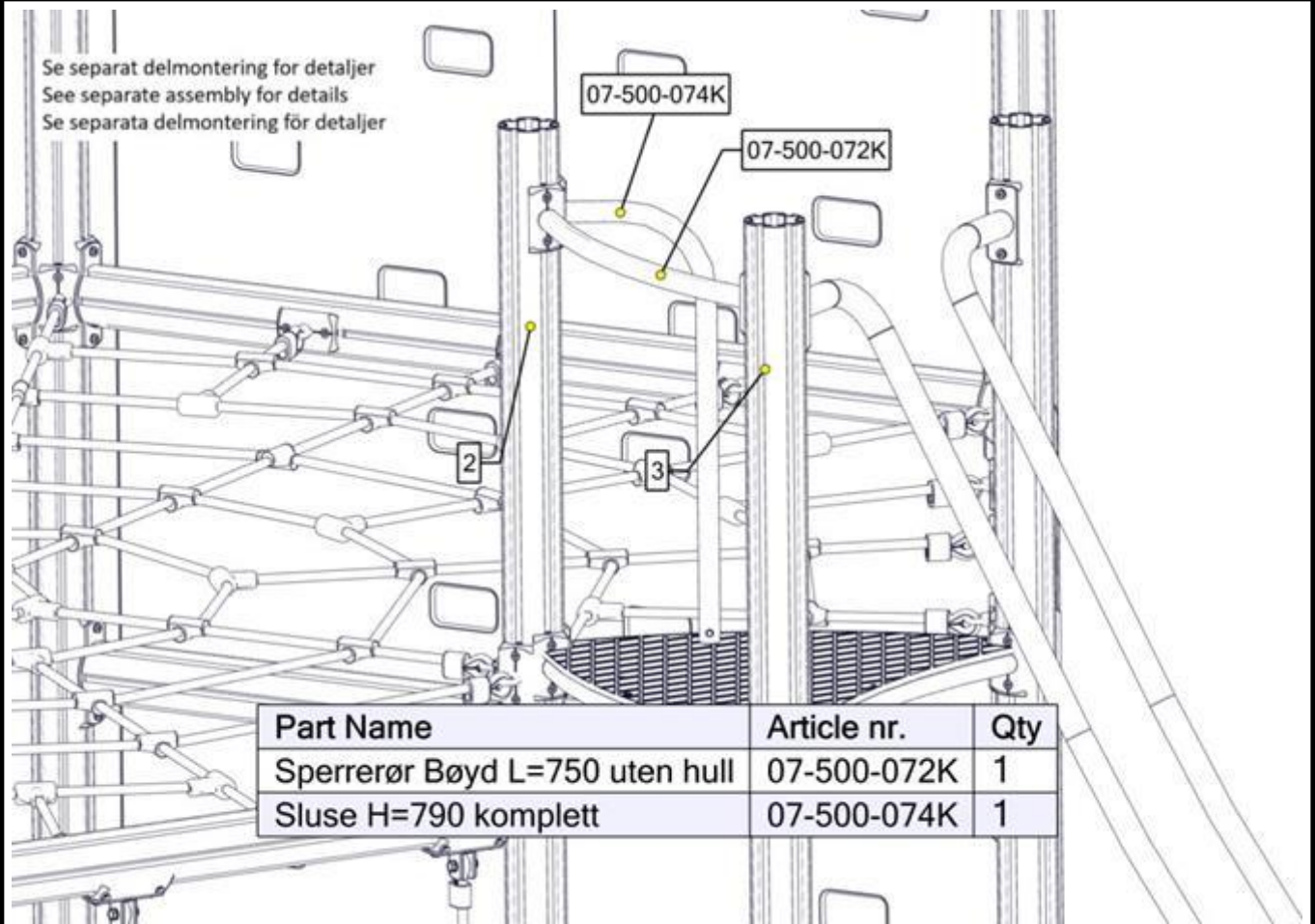
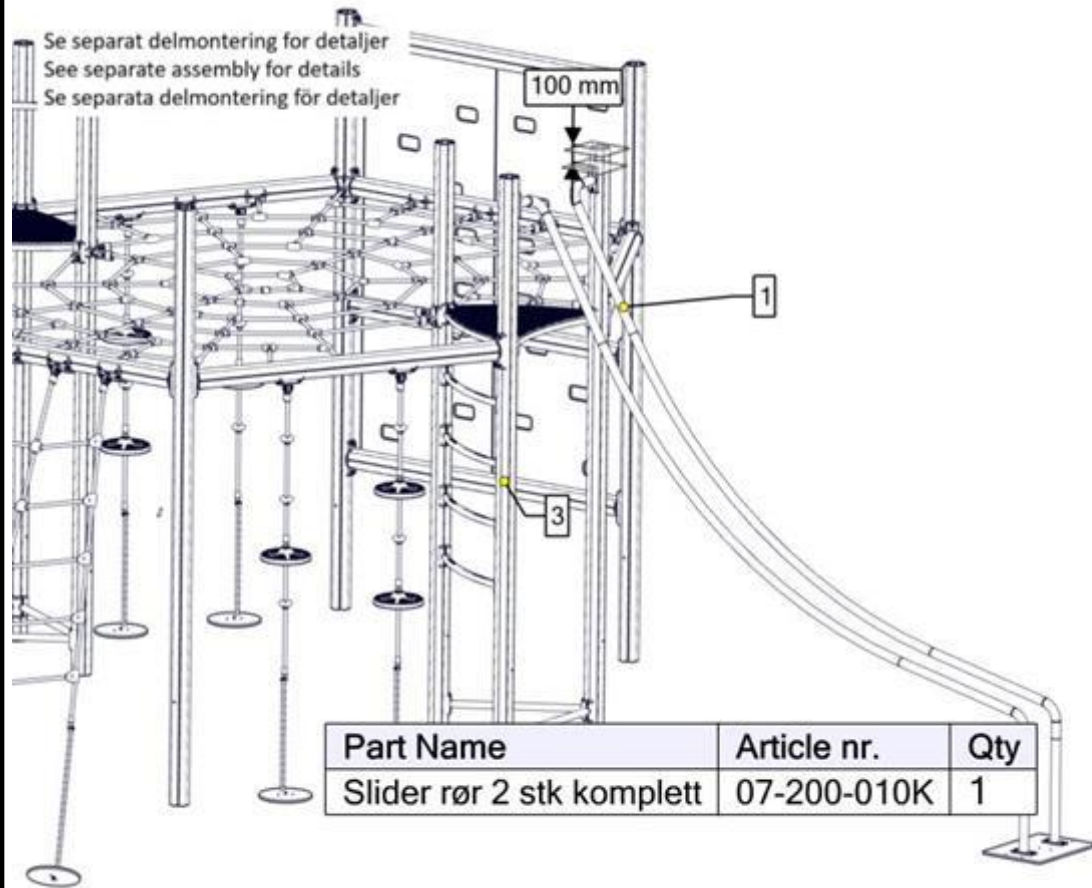

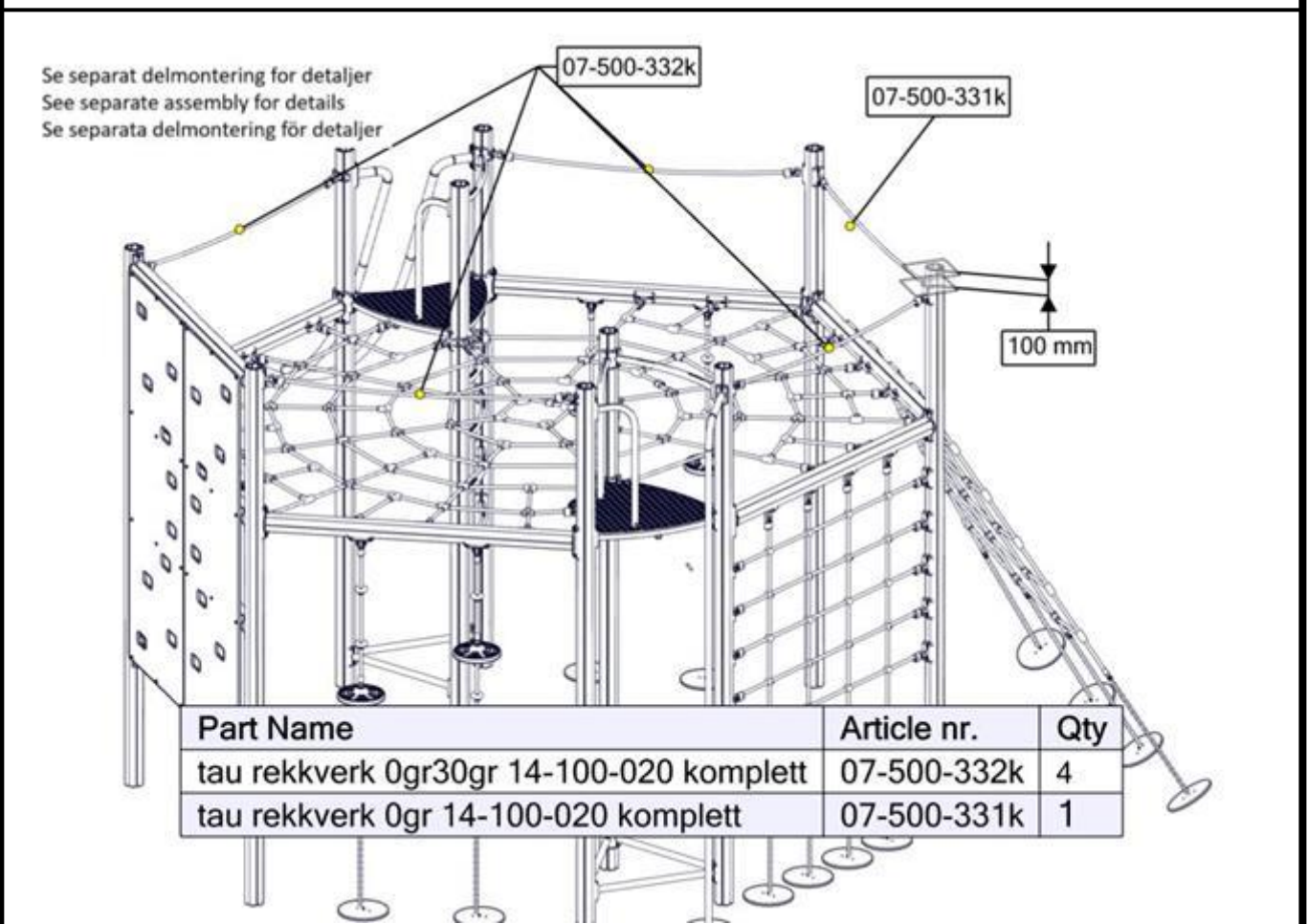
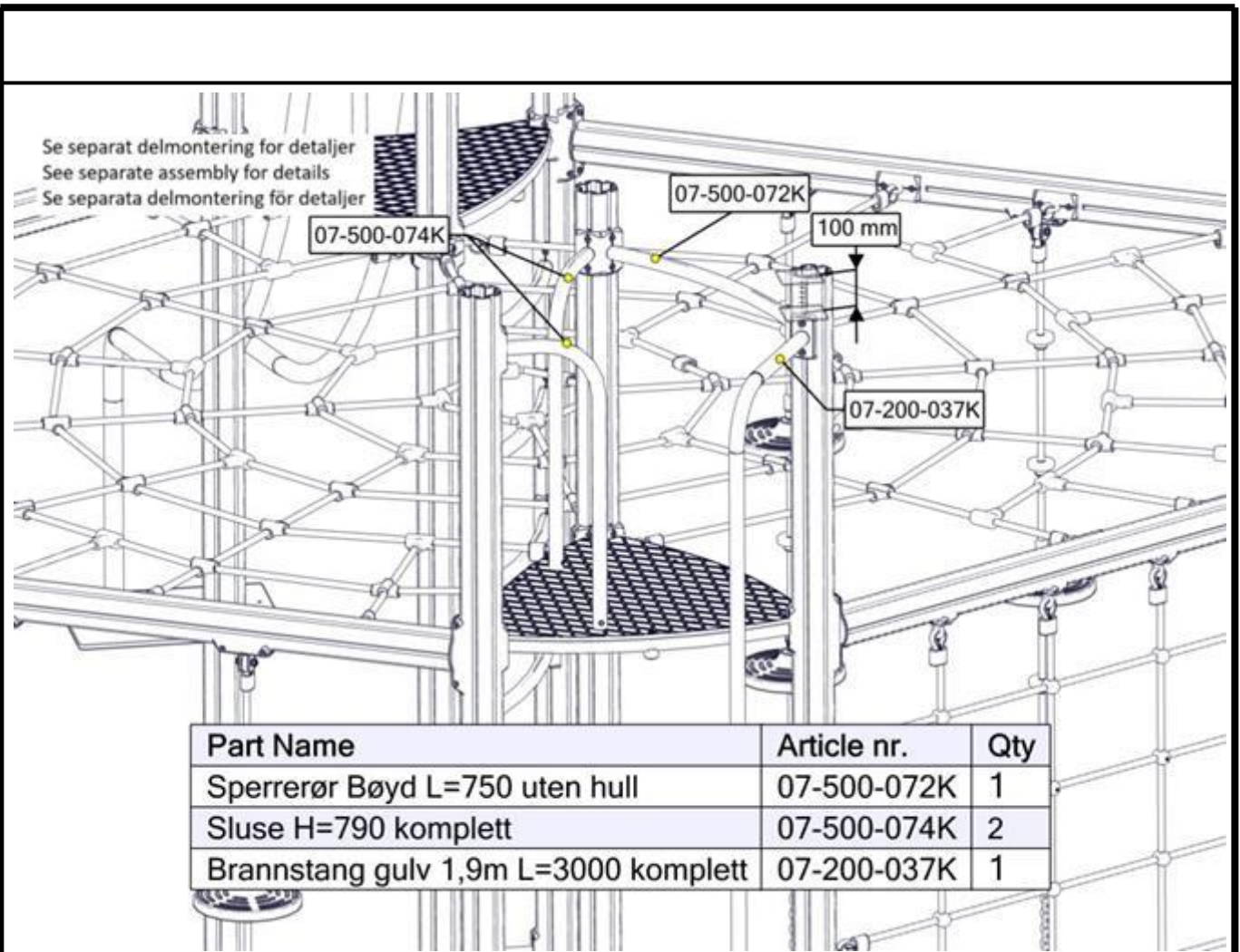

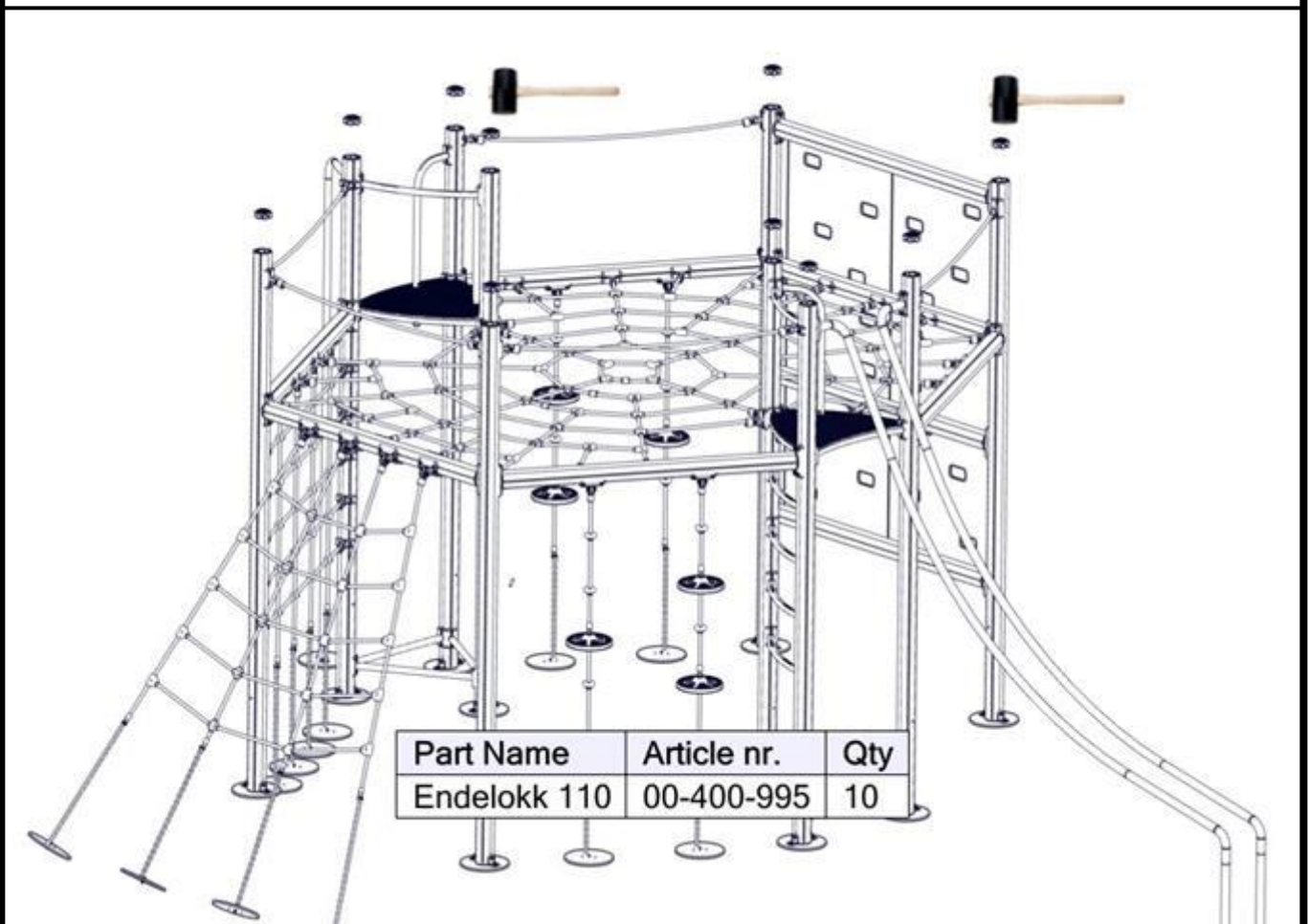
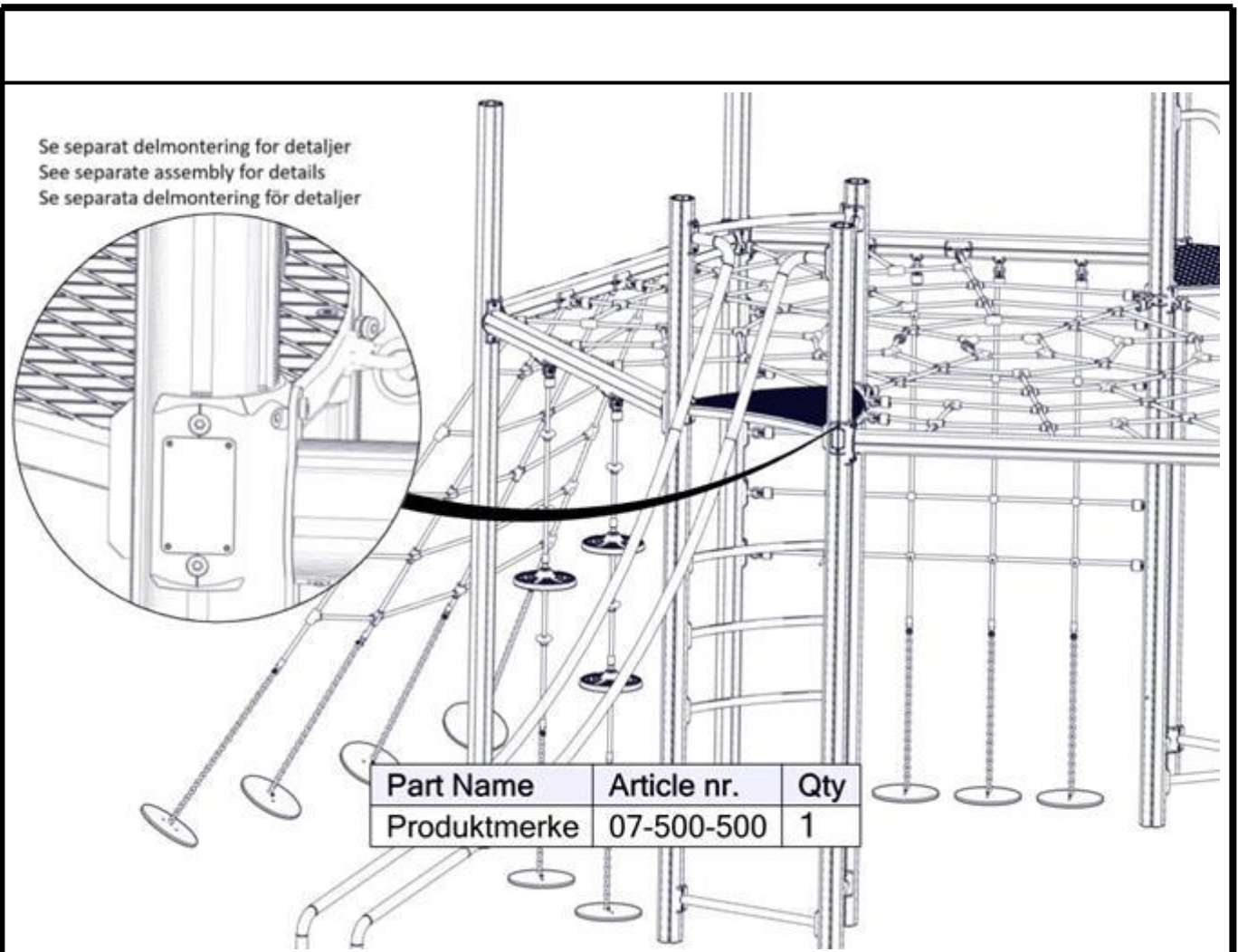







<b>Før utstyret tas i bruk / Before play begins / Innan lekredskapet tas i bruk</b>	
<b>N</b>	<ul style="list-style-type: none"> <li>● Påse at fallunderlag er utlagt i henhold til gjeldende regler eller vår anbefaling</li> <li>● Fjern alle monteringshjelpemidler ( rester av betong, planker, paller, plast, og lignende)</li> <li>● Før utstyret tas i bruk, burde man sjekke at det ikke er fare for at anorakksnorer og lignende som kan hekte seg fast noen steder på lekeapparatet. (Vedlagte snor med dobbe (kneledd) kan brukes til å sjekke at dette er i orden. Se vedlagte veiledning for bruk av denne. Dette gjøres for å oppdage eventuelle feilmonteringer.)</li> <li>● NB! Bør stå i 2-3 dager før bruk</li> </ul>
<b>EN</b>	<ul style="list-style-type: none"> <li>● Make sure the area and depth of safer surfacing are according to the current standard, or to the manufacturer's recommendation</li> <li>● Make sure all tools and surplus materials are removed before play begins</li> <li>● PS! When complete, allow 2-3 days for the concrete to set before use</li> </ul>
<b>S</b>	<ul style="list-style-type: none"> <li>● Kontrollera att fallunderlag är utlagt enligt gällande regler eller vårt rekommendation</li> <li>● Ta bort alla monteringshjälpmedel (rester av betong, plankor, pallar, plast och liknande)</li> <li>● Innan lekredskapet används, kontrollera att anoracksnoddar eller kläder/delar av kläder eller liknande inte kan fastna i några delar på redskapet. (Den bipackade "knävringen" kan man med fördel användas för denna kontroll.</li> <li>● Detta görs för att upptäcka eventuella felmonteringar.)</li> </ul>



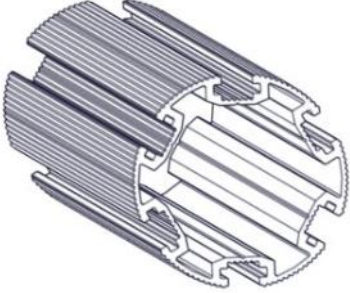







**Boltepakker for / Boltpackage for / Bultpaket för**





Sign. \_\_\_\_\_



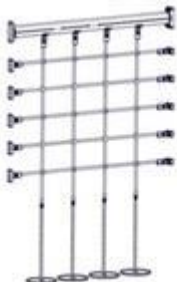

Gaustablikk 14-101-020	Navn	Artnr/dimensjon	Ant	Lev
	Stolpe Ø110 L=3450 600-2850 L= 3450 grå	SFA5126/2	10	
	Endelokk til stolpe Ø110	00-400-995	10	
	Gulv 3-kant 1 Sperrerør 1 hul horisontal CC880 Grå	07-300-104K (se egen delmontering)	1	
	Gulv 3-kant 1 konkav 1 Sperrerør 1 hul horisontal CC880 Grå	07-300-105K (se egen delmontering)	1	
	Sperrerør bøyd Lengde = 750 Uten hull Grønn	07-500-072K (se egen delmontering)	6	
	Sluse H= 790 Grønn	07-500-074K (se egen delmontering)	3	

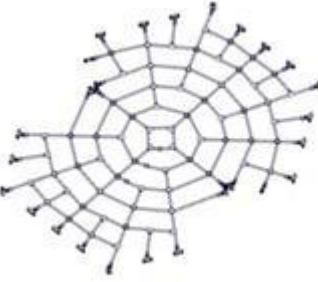

<b>Boltepakker for / Boltpackage for / Bultpaket för</b>		Sign. _____		
<b>Gaustablikk 14-101-020</b>	<b>Navn</b>	<b>Artnr/dimensjon</b>	<b>Ant</b>	<b>Lev</b>
	Slider	07-200-010K (se egen delmontering)	1	
	Brannstang Gulv 1,9m L=3000 Grå	07-200-037K (se egen delmontering)	1	
	Produktmerke Ø110 stolpe	07-500-500 (se egen delmontering)	1	
	Drager A Grå	07-300-190K (se egen delmontering)	1	
	Drager B +3xC Grå + klatrevegg Grå	07-300-191K (se egen delmontering)	1	
	Drager D Grå + monkeyseats rød	07-300-193K (se egen delmontering)	1	

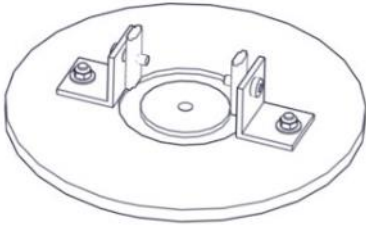
**Boltepakker for / Boltpackage for / Bultpaket för**

Sign. \_\_\_\_\_.

Gaustablikk 14-101-020	Navn	Artnr/dimensjon	Ant	Lev
	Drager E Grå + Vertikal nett sort	07-300-194K (se egen delmontering)	1	
	Drager F Grå Skrå nett sort	07-300-195K (se egen delmontering)	1	
	Drager G Grå Monkeyseats Sort	07-300-196K (se egen delmontering)	1	
	Taknett 8-kant 14-100-020 Sort/Grønn	07-500-338K (se egen delmontering)	1	
	Tau rekkverk Med beslag 0gr 30 gr	07-500-332K (se egen delmontering)	4	
	Tau rekkverk Med beslag 0 gr	07-500-331K (se egen delmontering)	1	

<b>Boltepakker for / Boltpackage for / Bultpaket för</b>		Sign. _____		
<b>Gaustablikk 14-100-020</b>	<b>Navn</b>	<b>Artnr/dimensjon</b>	<b>Ant</b>	<b>Lev</b>
	<b>Fundament Støpefrie</b>			
	Fundamentplate 1xØ110 stolpe	07-400-101K (se egen delmontering)	10	
	Sperrerør rett Lengde = 750 Uten hull Sort	07-500-075K (se egen delmontering)	5	
	<b>Fundament Betong</b>			
	Fundament Ø110 betong	00-003-111K (se egen delmontering)	10	
	Sperrerør rett Lengde = 750 Uten hull Sort	07-500-075K (se egen delmontering)	5	

<b>Boltepakker for / Boltpackage for / Bultpaket för</b>		Sign. _____.		
<b>Gaustablikk 14-101-020</b>	<b>Navn</b>	<b>Artnr/ dimensjon</b>	<b>Ant</b>	<b>Lev</b>
	<b>Overflatemon- tering</b>			
	Fundament 1xØ110 stolpe for betongdekke	00-003-113K (Se egen delmontering)	4	
	Fundament 3x110 stolpe for betongdekke	00-003-115K (Se egen delmontering)	2	
	Stolpe Ø110 må kappes Slider må kappes Brannstang må kappes	SFA5126/1 07-200-010 07-200-037	(10) (1) (1)	

23-11-2021 SV

Endret sikkerhetszone for slider