

N

Monteringsanvisning

EN

Assembly Instructions

S

Monteringsanvisning

Produkt nr. / Product no. / Produkt nr.

14-200-020**Grønn / Grå**

Ord. nr. _____

Dato. _____

Sign. _____

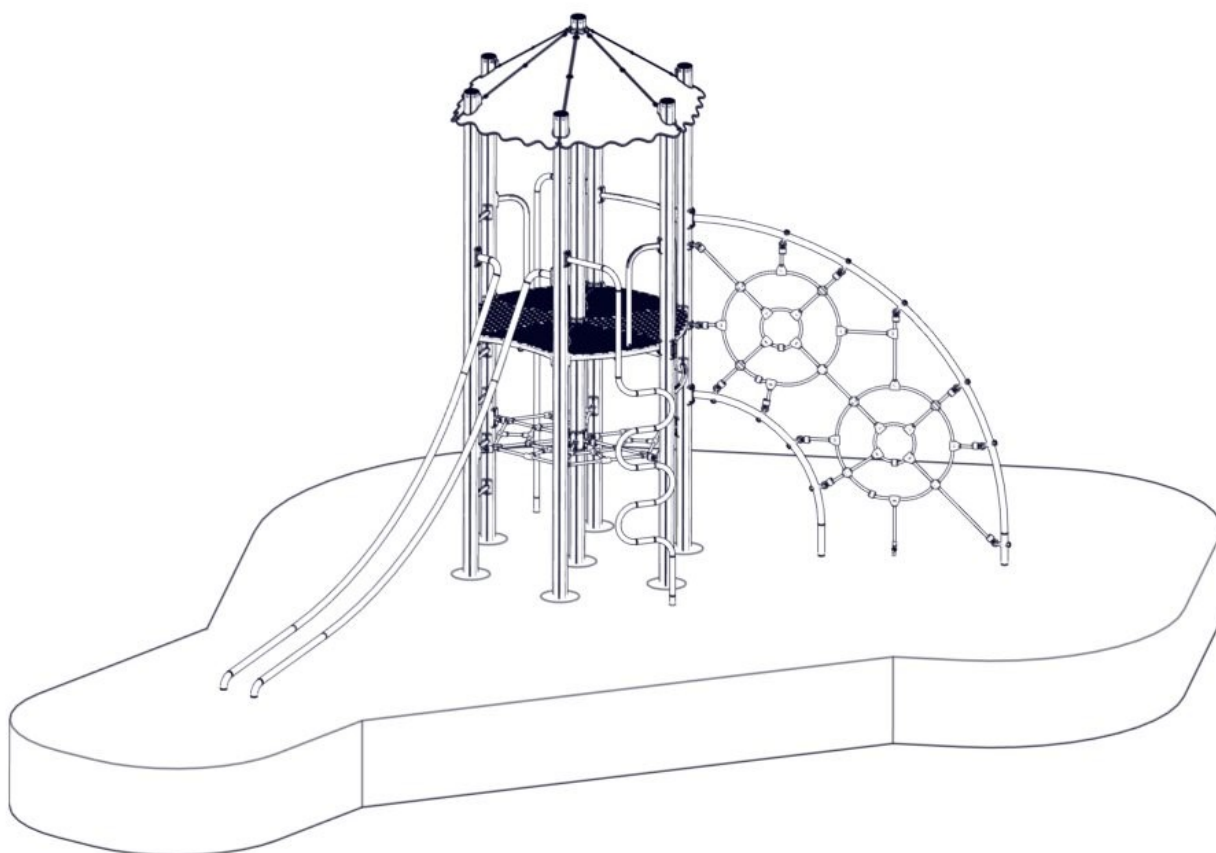
**søve**

Søve AS
Grønnvoldveien 290
3830 Ulefoss - Norway
Tlf: +47 35 94 65 65
www.sove.no



Søve AB
EA Rosengrensgatan 32
421 31 Västra Frölunda
Phone: +46 (0)31 773 97 00
www.sove.se

Monteringstips / Assembly Advice / Monteringsstips**N**

- Les monteringsanvisningen nøye før montering.
- Monter elementene i rekkefølgen som vist.
- Boltene bør ikke skrues for hardt til før alt er montert, vatret og loddet. Skru så boltene til.
- NB! Ved bruk av drill, kan boltene ryke.
- På grunn av at solen kan gjøre rutsjeflaten veldig varm, bør rutsjebanens utløp vende mot nord-øst eller nord-vest.
- Er lekeutstyret plassert i naturlige ferdselstraséer må området sikres mot gjennomgang.
- Innspringningshinder bør vurderes rundt lekeapparater hvor det er stor bevegelse, f.eks. ved huskestativ.
- Det bør være fritt innsyn til lekeutstyr som er beregnet for barn under 3 år.

NB! Under monteringsarbeidet må utstyr, som ikke er forankret forsvarlig i bakken, sikres slik at det ikke velte.

Området må avstenges under montering av apparatene med sperrebånd eller lignende.

EN

- Read the instruction carefully before assembling the play unit.
- Assemble the components in the sequence shown in these instructions. Fixings must not be fully tightened during assembly. Before casting the foundations, the structure must be level and plumb, at which point all fixings are tightened. PS! If use of drill, the bolts may be wrecked.
- Avoid positioning the slide facing due south because of overheating – ideal positions are facing north-east or north-west. Secure the construction-area to prevent people from walking through it.
- Consider installing barriers around play-equipment which gives rise to a lot of activity – i.e. swings.
- Ensure that clear vision is possible across the play area so that supervision is possible from any position, particularly where children under 3 years of age will be playing.

NB! During assembly of the equipment, ensure that all structures are securely propped, especially when left overnight. Also ensure that equipment is supported

Monteringstips / Assembly Advice / Monteringsstips**S**

- Läs monteringsanvisningen noga före montering.

- Montera delarna i den ordningen som anvisas
- Skruvarna bör inte skruvas för hårt tills allt är monterat, i våg och lodat.

OBS! Används elektrisk skruvdragare, kan bulten gå sönder. Hårdra därför manuellt!

- Solen kan göra att rutchbanan blir väldigt varm. Banans nedfart rekommenderas att vändas i norrlig riktning
- Om lekplatsen placeras vid en gångväg mm bör området säkras mot genomfart av gående och cyklister.
- Insprängningshinder bör placeras runt lekutrustning med stor rörelse, t ex, gungställning.
- Det bör vara fri insyn till lekutrustning beräknat till barn under 3 år.

OBS! Under monteringsarbete bör utrustningen som inte ska förankras i marken, ställs så att den inte kan välta.

Området måste spärras när lekutrustningen byggs upp, med avspärrningsband eller liknande.

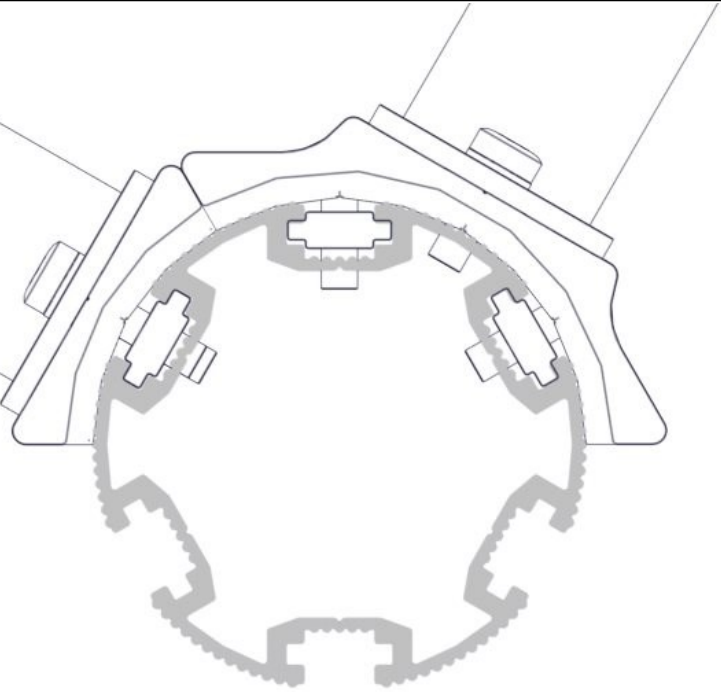









N Bolten skrues HELT igjennom aluminiumen.
Maks dreiemoment: 30Nm

EN The bolt must be tightened in to the post, so that it peirces the aluminium
Max torque: 30Nm

S Bulten skruvas HELT ignom aluminiumen.
Maks vridmoment: 30Nm

NO	Betongkvalitet	C25/30		
SE	Betongkvalitet			
EN	Concrete quality			
NO	Mengde betong		0,9	m ³
SE	Mängd betong			
EN	Amount of concrete			
NO	Fundament størrelse		0,5 x 0,5 x 0,4	m
SE	Stiftelsestorlek			
EN	Foundation size			
NO	For sikkerhet må fundamentene med sand eller myk jord være minst 50% større i areal			
SE	För säkerheten måste grunden med sand eller mjuk jord vara minst 50% större i området			
EN	For safety, the foundations with sand or soft soil must be at least 50% larger in area			
NO	Tyngste element	SFA5126/2	22	Kg
SE	Tyngsta element			
EN	Heaviest element			
NO	Største element	07-200-010 SFA5126/2	4,85x0,72x0,25 L=5,0 Ø=0,11	m
SE	Största element			
EN	Biggest element			

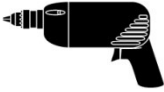
Nødvendig verktøy / Tools required / Nödvändiga verktyg





<p>(N)</p> <p>(EN)</p> <p>(S)</p>	<p>(A)</p> 	<p>(B)</p>  <p>Torx Nr 45 High quality</p>	<p>(C)</p>  <p>13 + 17mm</p>	<p>(D)</p> 	<p>(E)</p> 
		<p>Metermål</p> <p>Metric measure</p> <p>Tumstock</p> 	<p>16 V</p> 	<p>Merkebånd</p> <p>Mark ribbon</p> <p>Märkeband</p> 	<p>5 mm</p> <p>6 mm</p> 

Nødvendig antall personer / Number of persons required / Rekommenderad antal personer

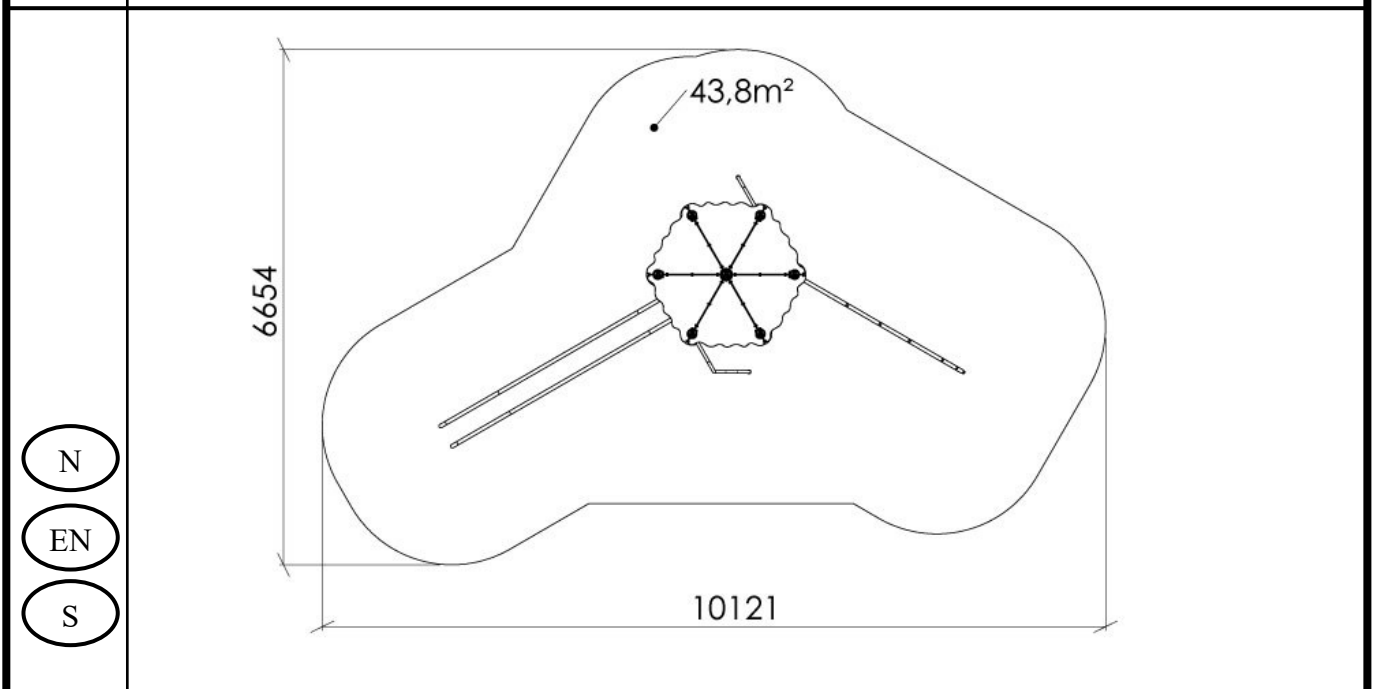

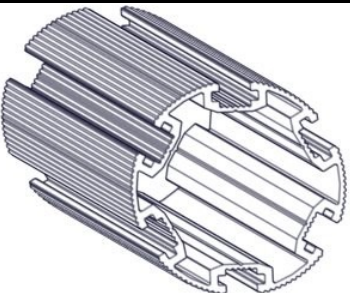

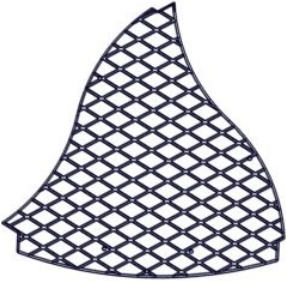
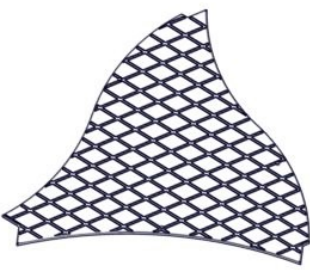
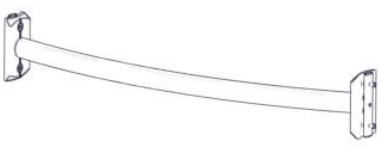
Anbefalt arealbehov ved montering / Recommended working space / Rekommenderad arealbehov vid montering





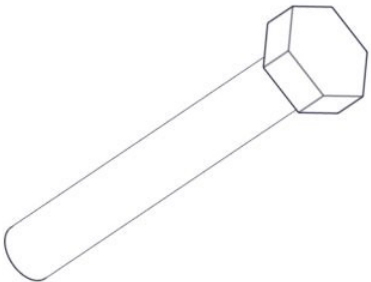

Boltepakker for / Boltpackage for / Bultpaket för		Sign. _____.		
Thorium Nøytron 14-200-020	Navn	Artnr/ dimensjon	Ant	Lev
	Stolpe Ø110 L=5000 Grå Stolpe Ø110 L=4500 Grå	SFA5126/2 SFA5126/2	1 6	
	Endelokk til stolpe Ø110	00-400-995	7	
	Gulv 6-kant Grå	07-301-120	5	
	Gulv 6-kant 1 konkav Grå	07-301-121	1	
	Sperrerør bøyd Lengde = 750 Uten hull Grønn	07-500-072K (Se egen del- montering)	8	
	Sperrerør 6-kant gulv L=750 2 Hull Sort	07-500-064K (Se egen del- montering)	6	

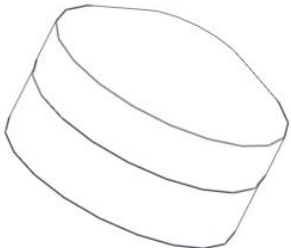
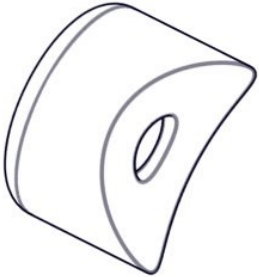
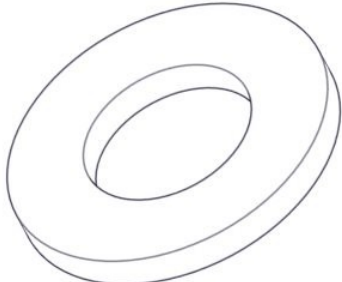
Boltepakker for / Boltpackage for / Bultpaket för

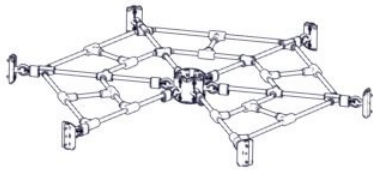

Sign. _____

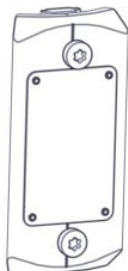

Thorium Nøytron 14-200-020	Navn	Artnr/ dimensjon	Ant	Lev
	Sperrerør bøyd med hull gulv L=750 Sort	07-500-060 (Se egen del- montering)	6	
	Sekskant M8x50	04-008-050	18	
	Møbelknapp M8x11	04-008-050	18	
	Plast rørfeste, hode	05-301-036	18	
	Plast rørfeste, kropp	05-301-036	18	
	Skive M8 stor	04-055-008	18	

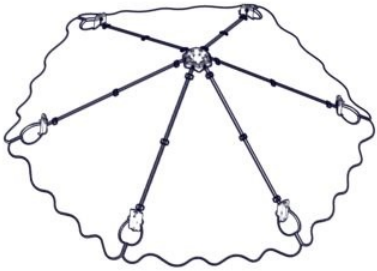

Boltepakker for / Boltpackage for / Bultpaket för		Sign. _____		
Thorium Nøytron 14-200-020	Navn	Artnr/ dimensjon	Ant	Lev
	Edderkoppnett horisontalt CC = 880 Grønn	07-500-211K (Se egen del- montering)	1	
	Slider	07-200-010K (Se egen del- montering)	1	
	Klatrestang Gulvhøyde = 1,9m Grå	07-200-038K (Se egen del- montering)	1	
	Brannstang Gulvhøyde = 1,9m Grå	07-200-037K (Se egen del- montering)	1	
	Sluse Høyde = 790 Grønn	07-500-074K (Se egen del- montering)	3	
	Produktmerke	07-500-500	1	

Boltepakker for / Boltpackage for / Bultpaket för

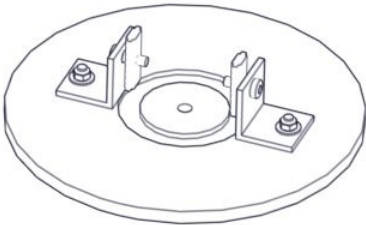
Sign. _____.

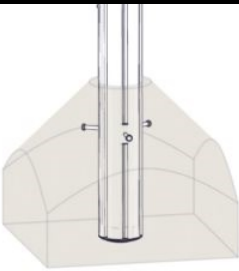
Thorium Nøytron 14-200-020	Navn	Artnr/ dimensjon	Ant	Lev
	Tak 6-kant CC = 880 Grå	07-520-600K (Se egen del- montering)	1	
	Edderkoppnett dobbel 30gr Grønn	07-500-028K (Se egen del- montering)	1	
	Plastpropp	04-090-002	10	

Boltepakker for / Boltpackage for / Bultpaket för		Sign. _____		
Thorium Nøytron 14-200-020	Navn	Artnr/ dimensjon	Ant	Lev
	Nedgravnings fundament			
	Sperrerør rett Lengde = 750 Uten hull Sort	07-500-075K (Se egen del- montering)	12	
	Fundamentplate 1xØ110 stolpe	07-400-101K (Se egen del- montering)	7	
	Støp fundament			
	Sperrerør rett Lengde = 750 Uten hull Sort	07-500-075K (Se egen del- montering)	12	
	Fundament betong Stolpe Ø110	00-003-111K (Se egen del- montering)	7	

Boltepakker for / Boltpackage for / Bultpaket för		Sign. _____.		
Thorium Nøytron 14-200-020	Navn	Artnr/ dimensjon	Ant	Lev
	Overflatemon- tering			
	Fundament 2xØ110 stolpe for betongdekke	00-003-114K (Se egen del- montering)	2	
	Fundament 3x110 stolpe for betongdekke	00-003-115K (Se egen del- montering)	1	
	Stolpe Ø110 må kappes	SFA5126/1	(7)	
	Slider må kappes	07-200-010K	(1)	
	Brannstang må kappes	07-200-037K	(1)	
	Klatrestang må kappes	07-200-038K	(1)	
	Eddekoppnett må kappes	07-500-028K	(1)	

Fundamentering med betong // Foundation concrete // Förankring med betong

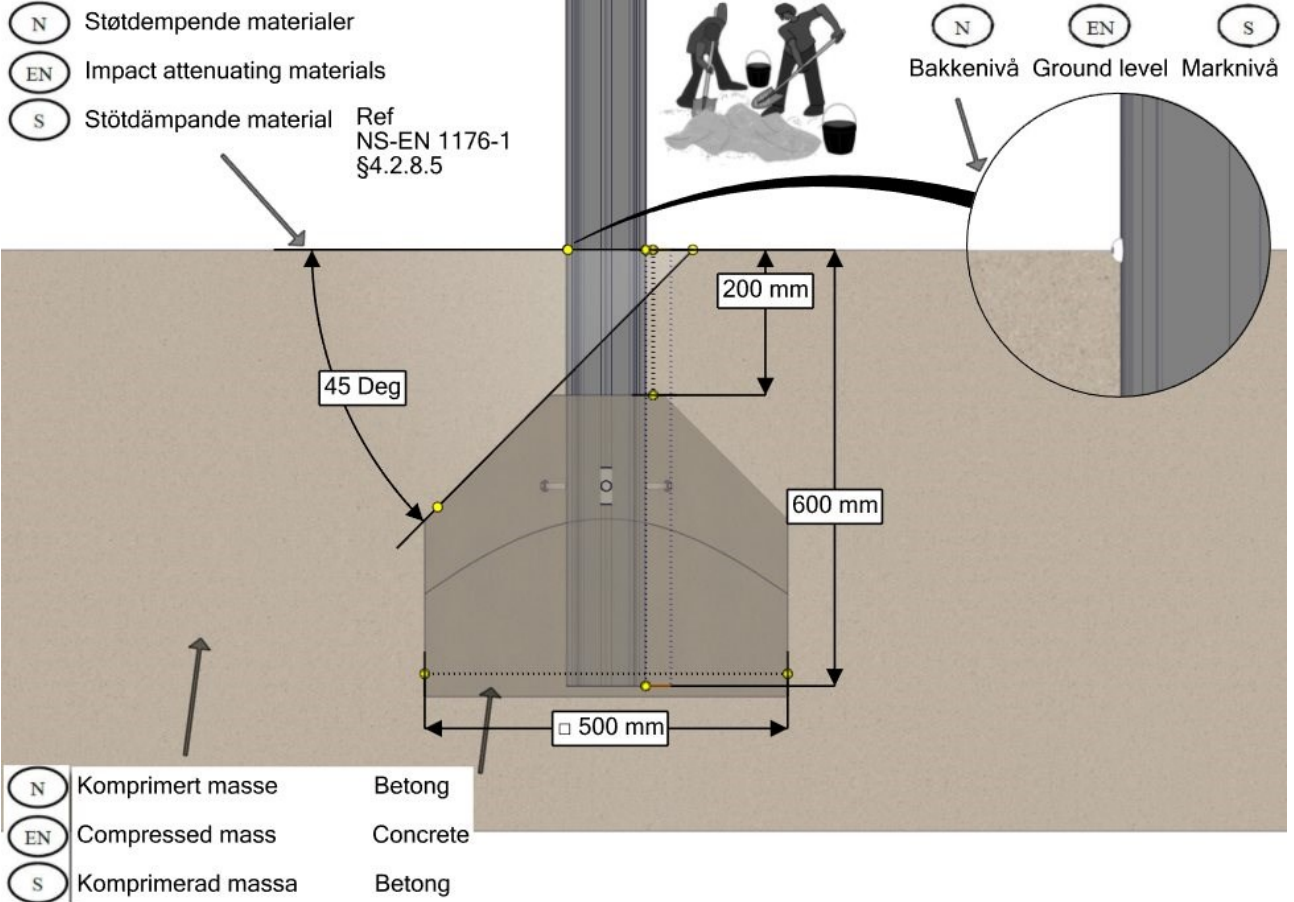

Fundamentering uten betong // Foundation without concrete // Förankring utan betong

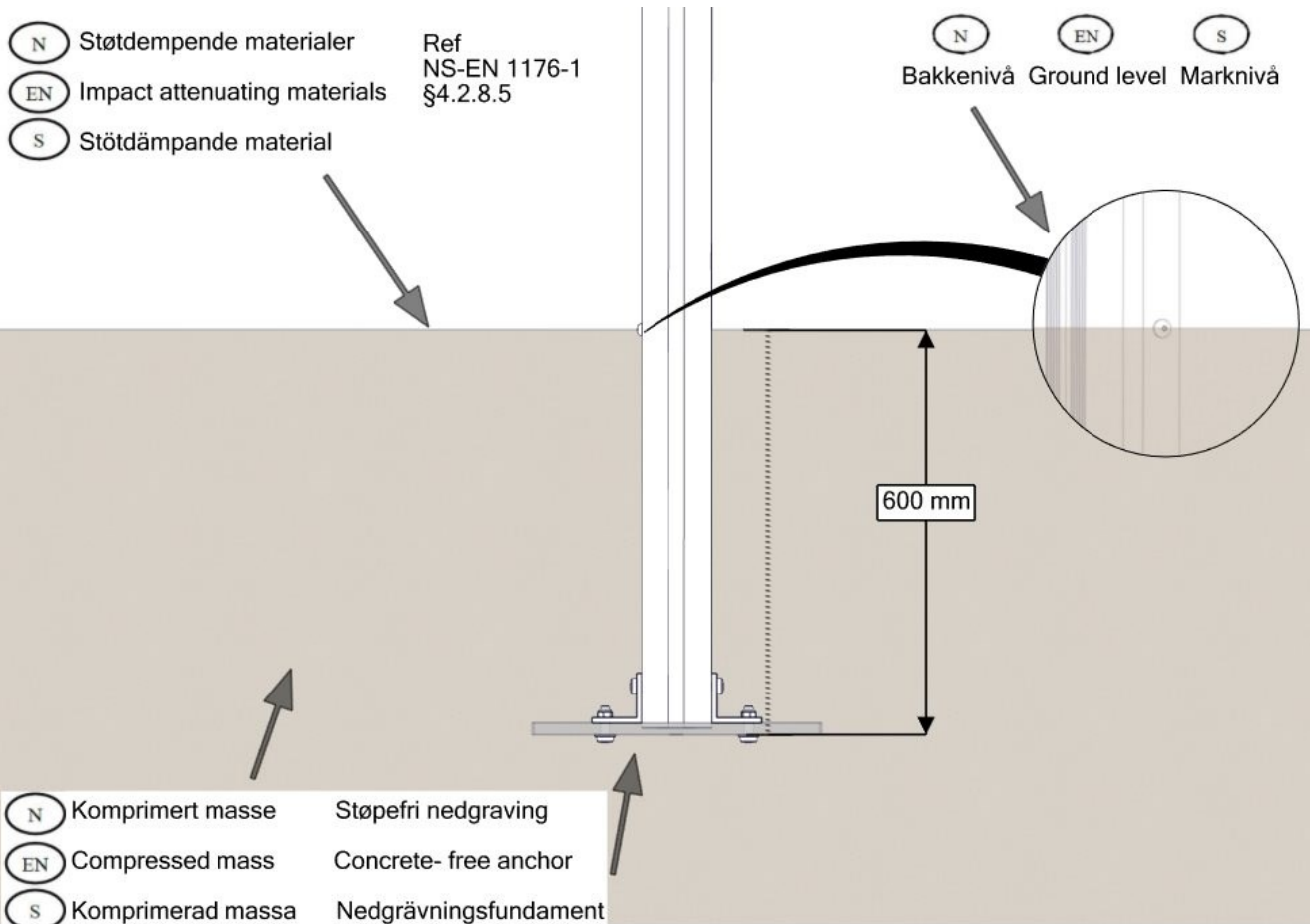

Fundamentering overflate / Foundation surface / Förankring grundytan

Ref.
NS-EN 1176-1
§4.2.8.5

(N) (EN) (S)
Bakkenivå Ground level marknivå

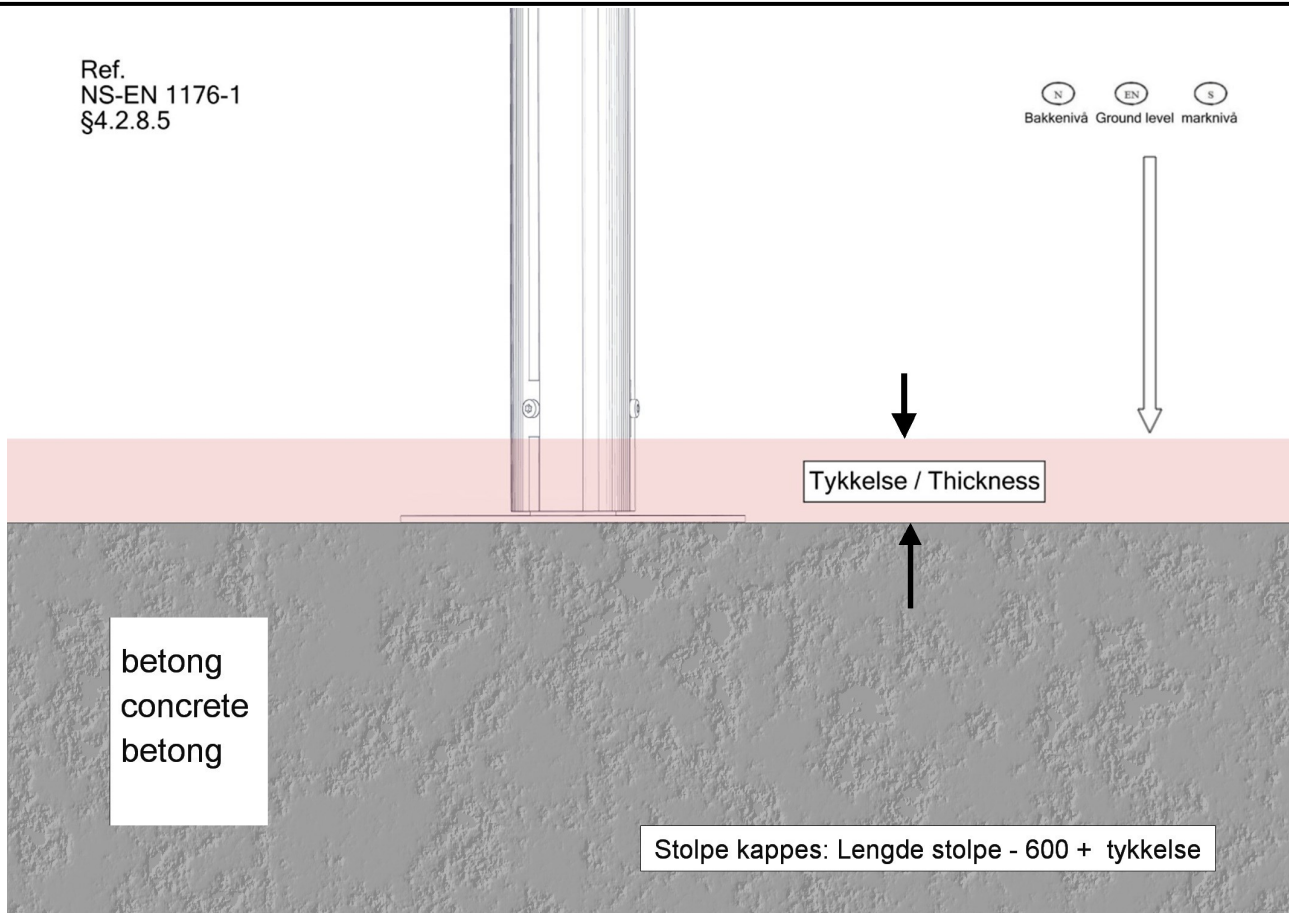

Fallhøyder / Free height of fall / Fallhöjder

Fallhøyde = 2.75m

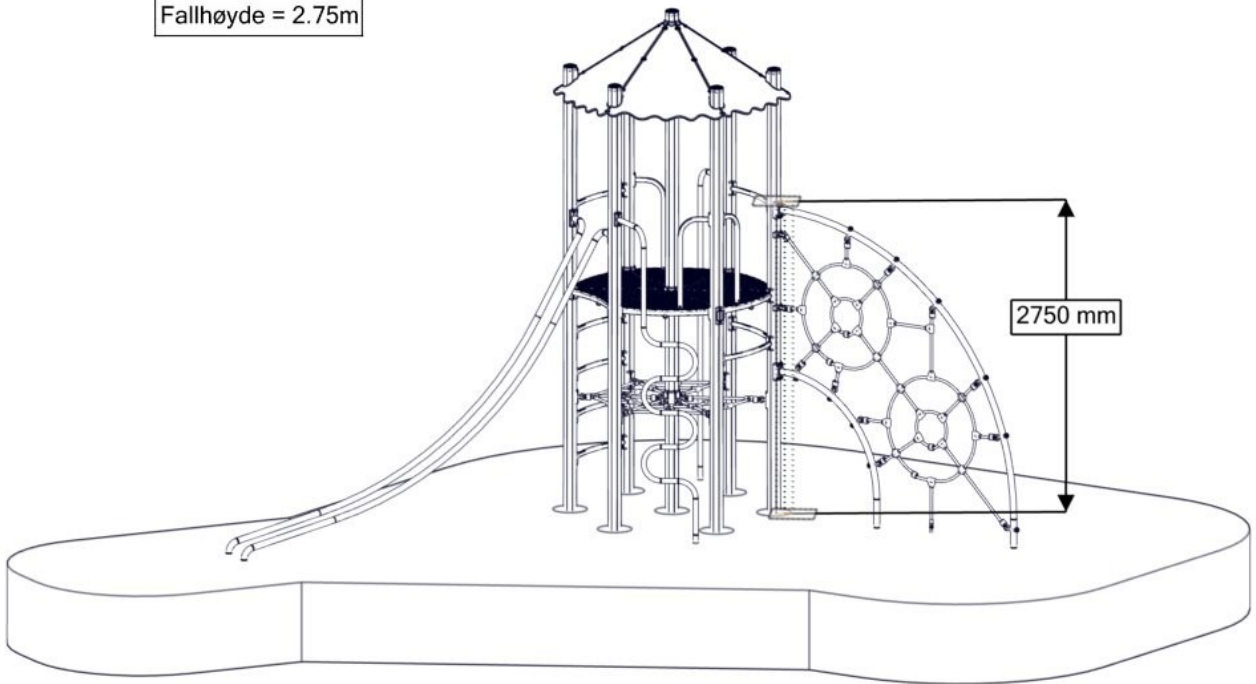

Sikkerhetszone / Safety zone / Säkerhetszon

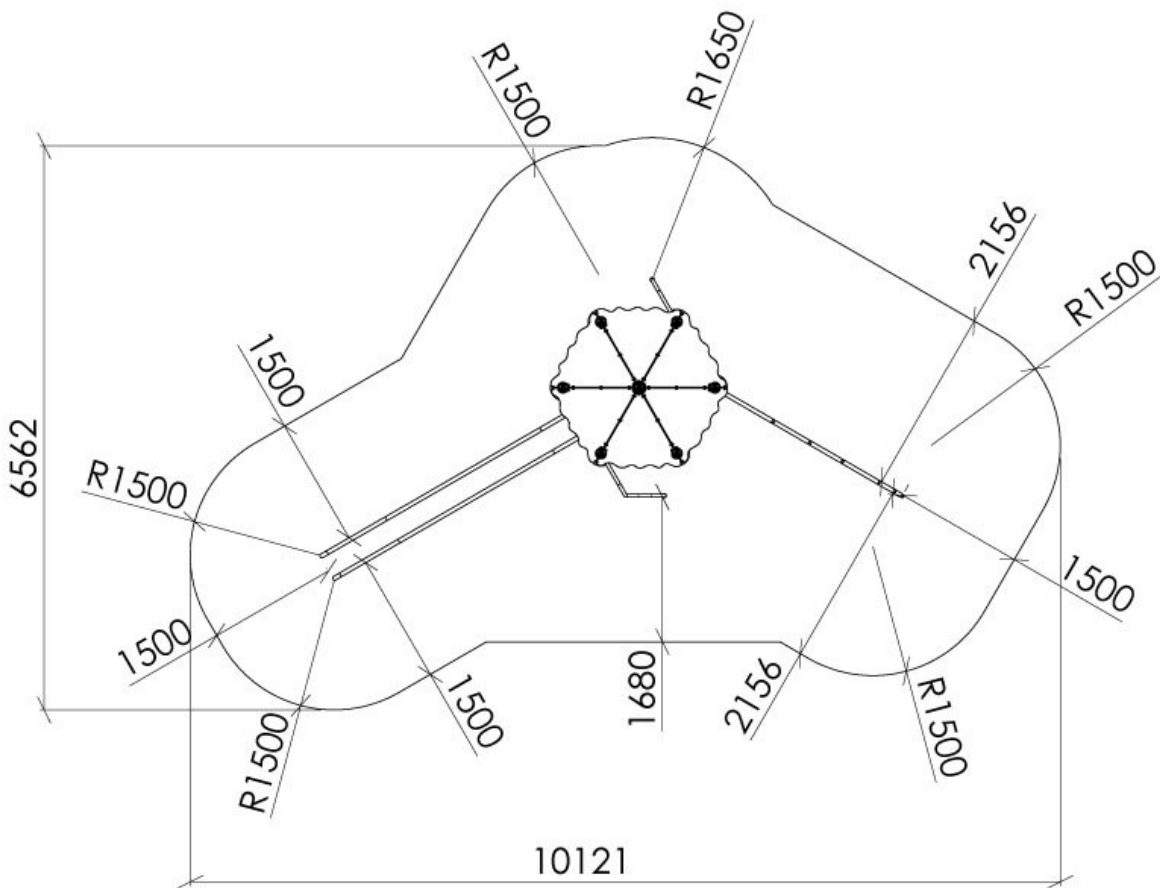

Plassering av forankringer / Ground plan / Placering av förankringar

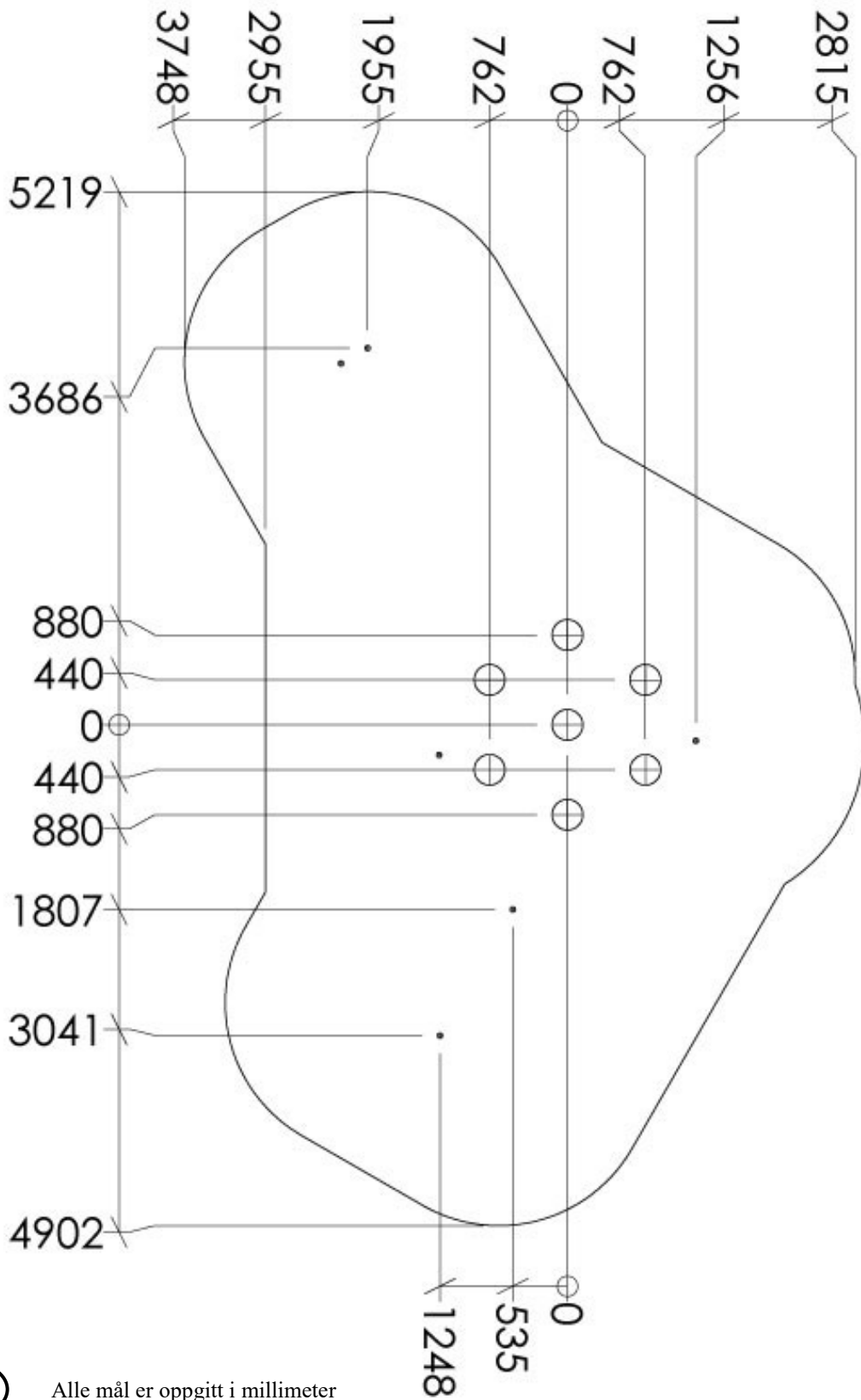

N

Alle mål er oppgitt i millimeter

EN

Scale measured in mm

S

Alla mått är i millimeter.

Montering av lekeapparatet / Assembly instructions / Montering av lekredskapet

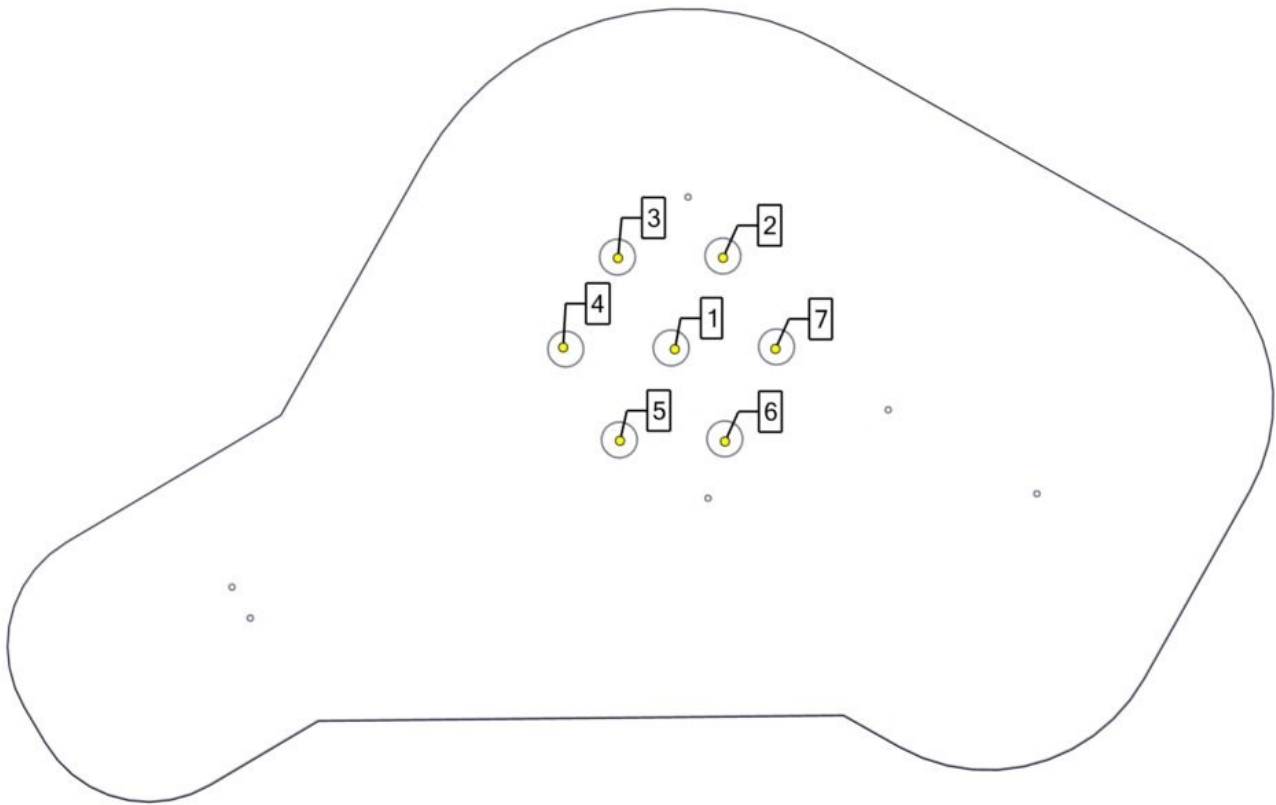

Se separat delmontering for detaljer
See separate assembly for details
Se separata delmontering för detaljer

brikke_SFA5116
Montert hos Søve
Assembled at Søve
Monterad hos Søve

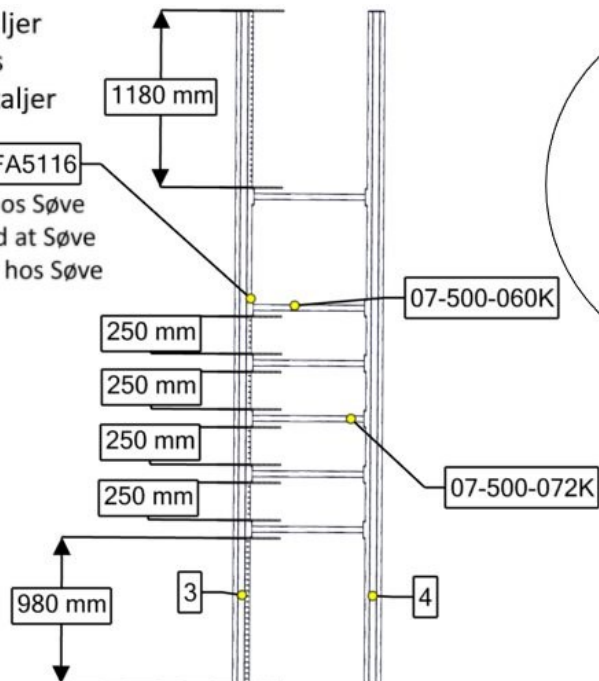

Part Name	Article nr.	Qty
Stolpe110 600-3900 L=4500	SFA5126/2	2
Sperrerør Bøyd L=750 uten hull	07-500-072K	5
Sperrerør Bøyd L=750 m hull gulv komplet	07-500-060K	1

Se separat delmontering for detaljer
 See separate assembly for details
 Se separata delmontering för detaljer

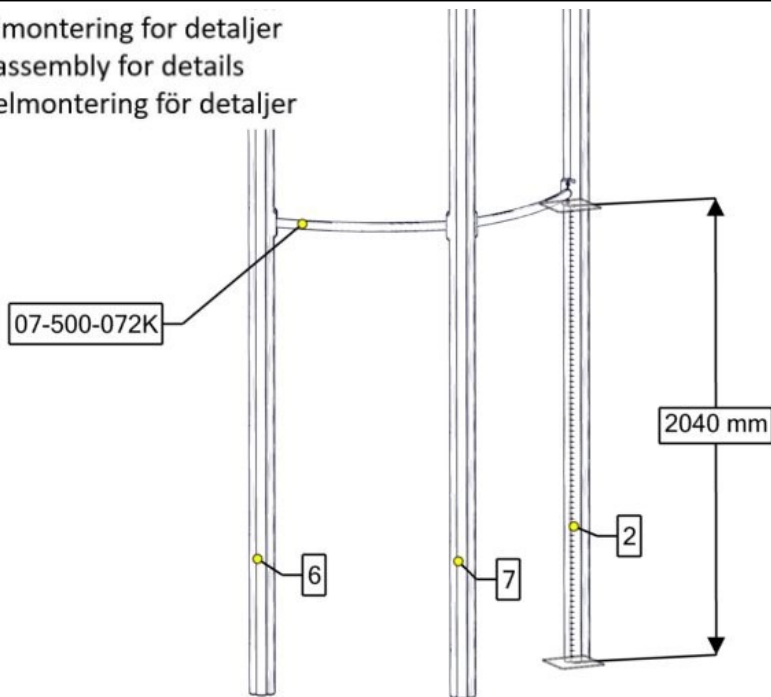

Part Name	Article nr.	Qty
Stolpe110 600-3900 L=4500	SFA5126/2	3
Sperrerør Bøyd L=750 uten hull	07-500-072K	2

Se separat delmontering for detaljer
 See separate assembly for details
 Se separata delmontering för detaljer

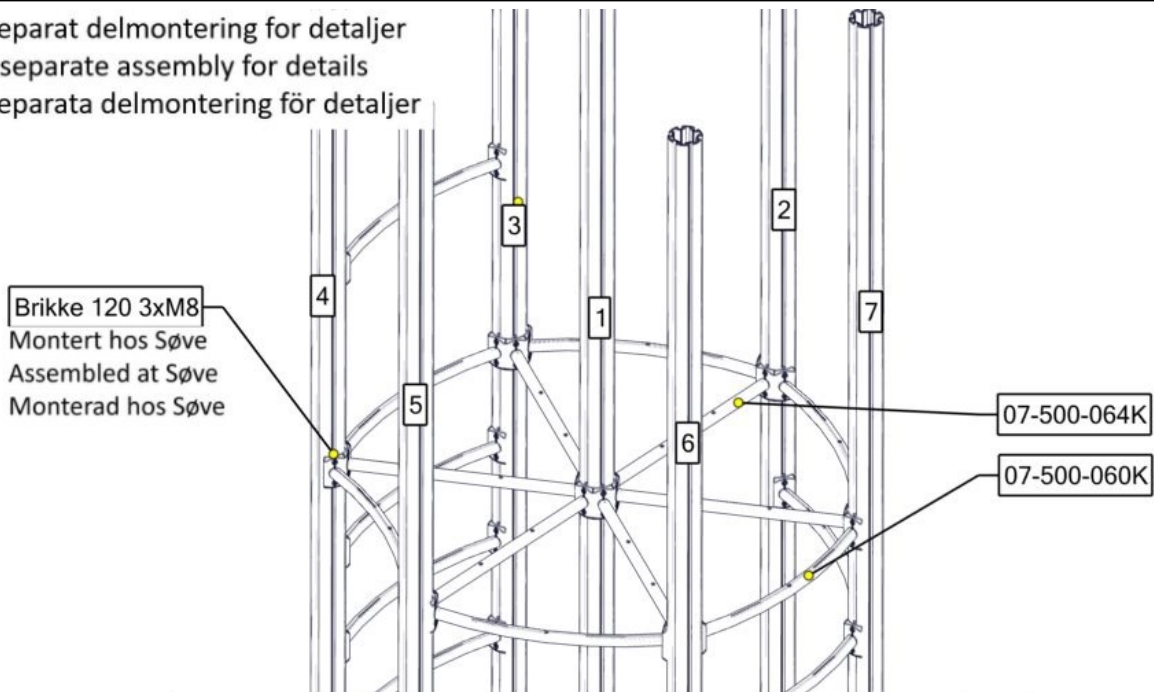

Part Name	Article nr.	Qty
Stolpe110 600-3900 L=4500	SFA5126/2	1
Stolpe110 600-4400 L = 5000	SFA5126/2	1
Sperrerør Bøyd L=750 m hull gulv komplett	07-500-060K	5
Sperrerør 6-kant gulv L=750 2 hull	07-500-064K	6

Se separat delmontering for detaljer
 See separate assembly for details
 Se separata delmontering för detaljer

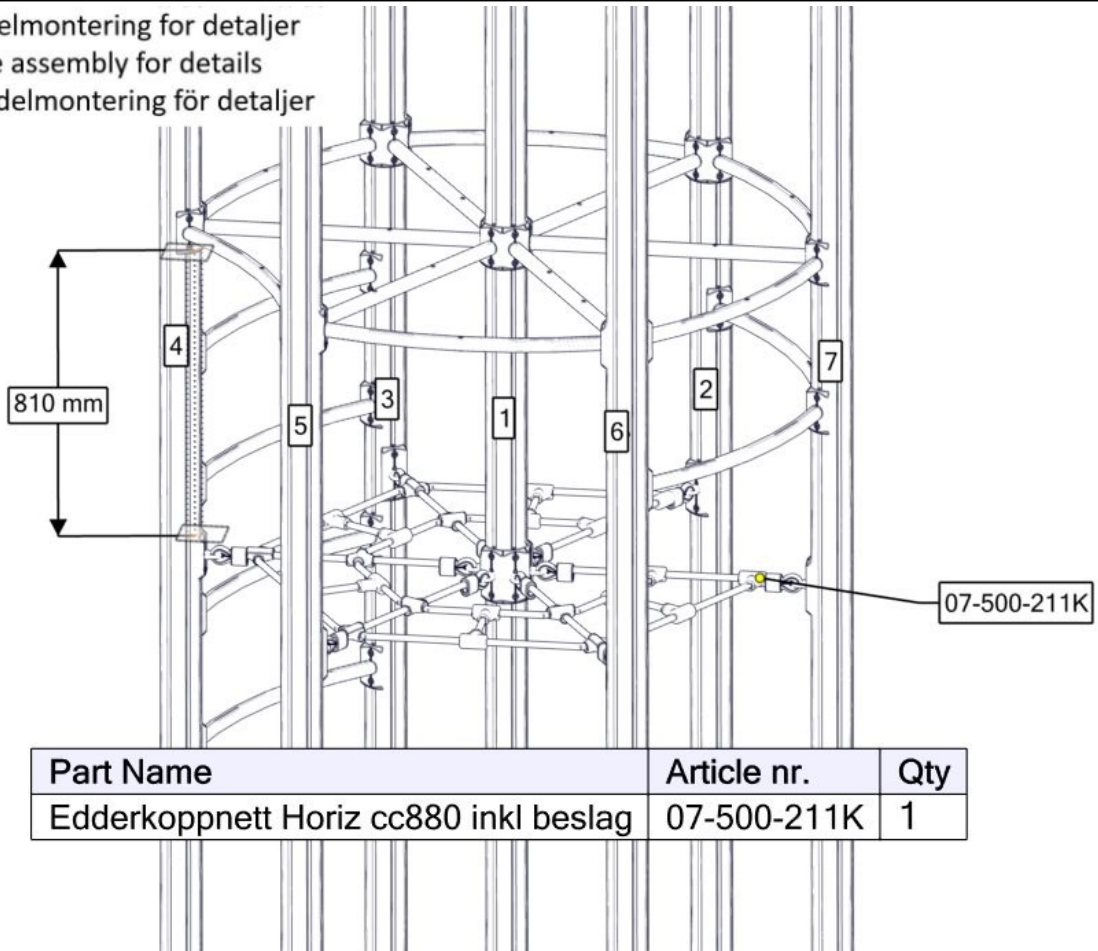

Se separat delmontering for detaljer
 See separate assembly for details
 Se separata delmontering för detaljer

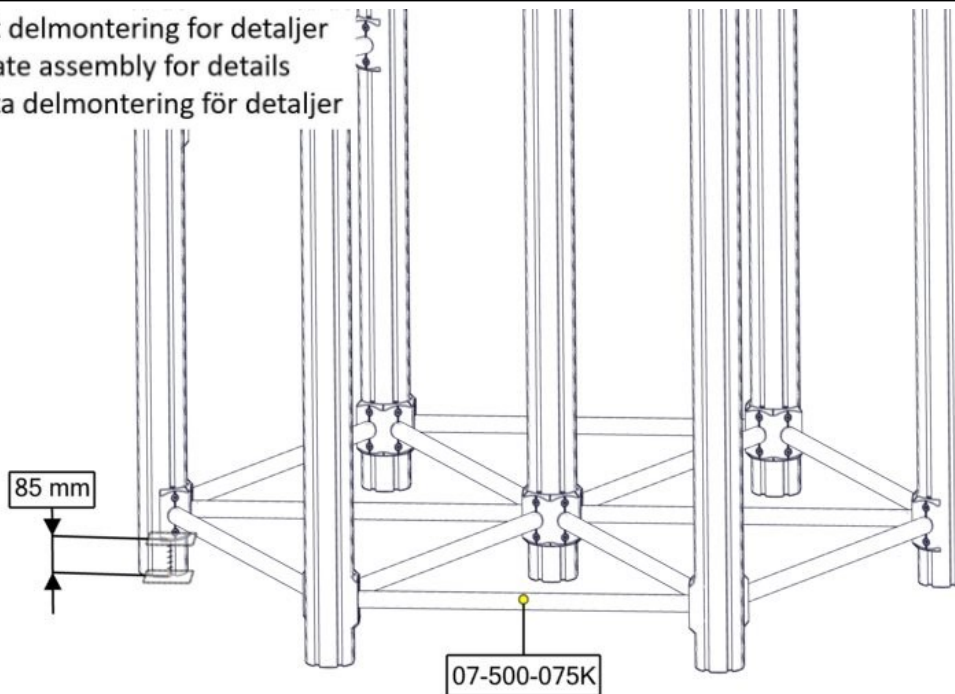

Part Name	Article nr.	Qty
Sperrerør rett L=750 uten hull	07-500-075K	12

Se separat delmontering for detaljer
 See separate assembly for details
 Se separata delmontering för detaljer

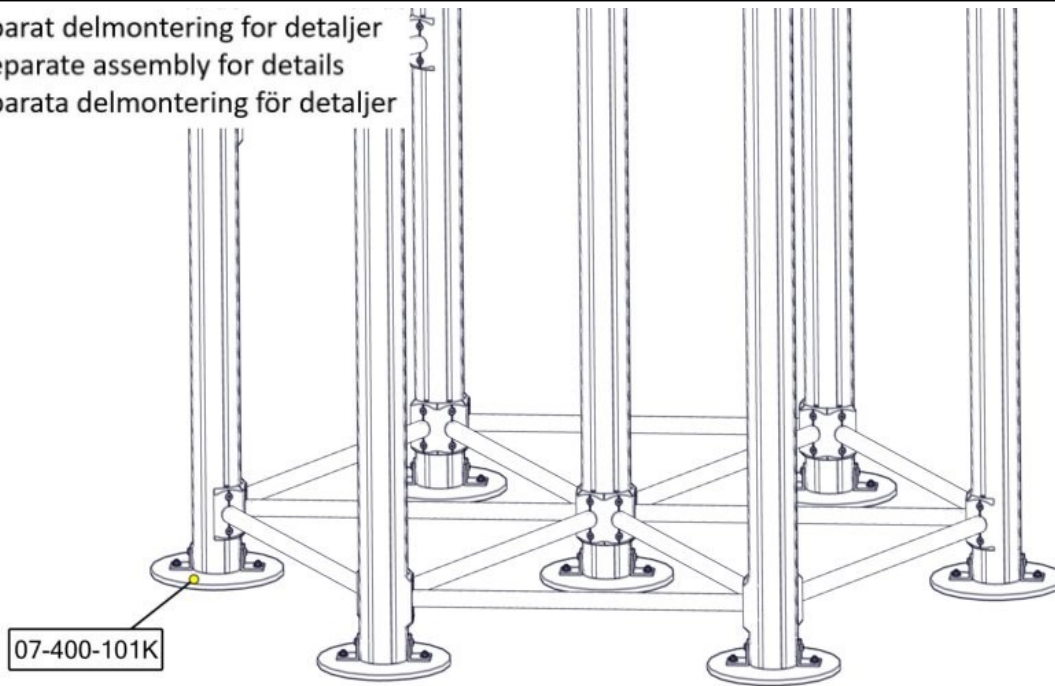

Part Name	Article nr.	Qty
Fundamentplate 1x110 stolpe komplett	07-400-101K	7

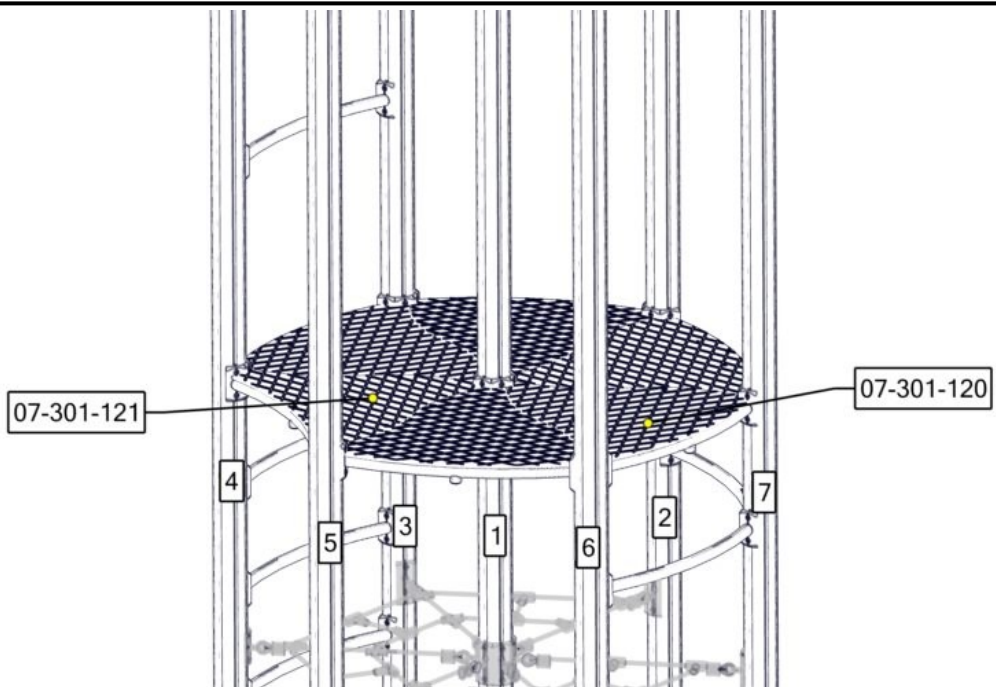

Part Name	Article nr.	Qty	Part Name	Article nr.	Qty
Gulv 6Kant STD	07-301-120	5	Plast rørfeste, kropp	05-301-036	18
Gulv 6-kant 1 konkav	07-301-121	1	Plast rørfeste, hode	05-301-036	18
Sekskant M8x50	04-008-050	18	Skive M8 stor	04-055-008	18
Møbelknapp M8x11	04-030-011	18			

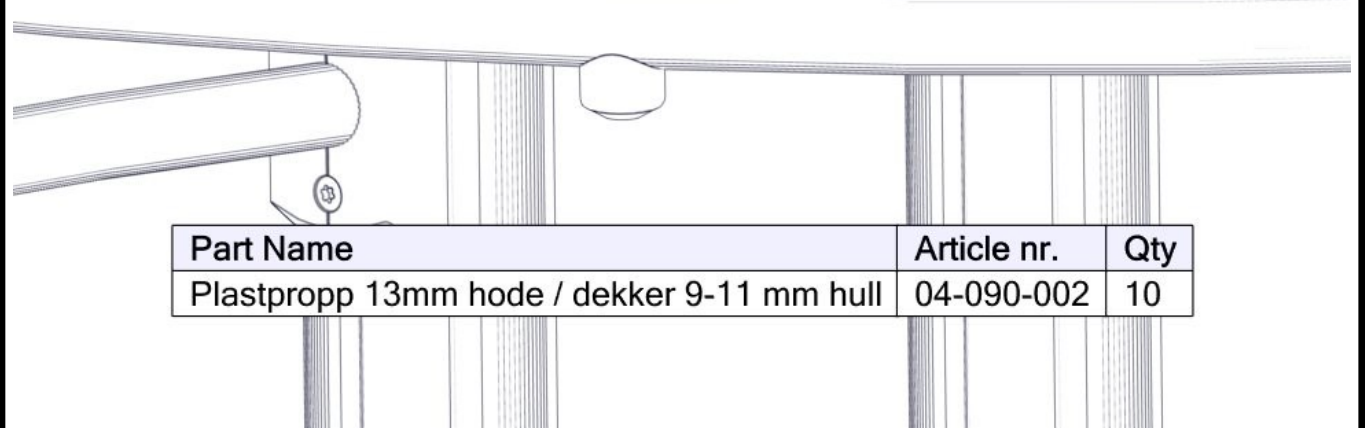
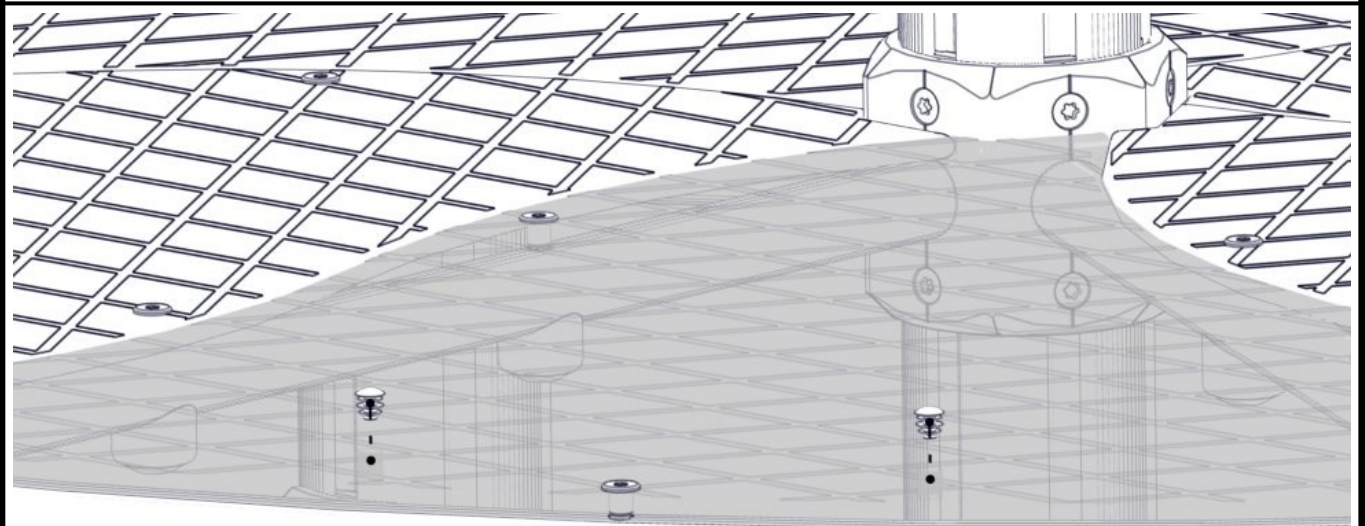
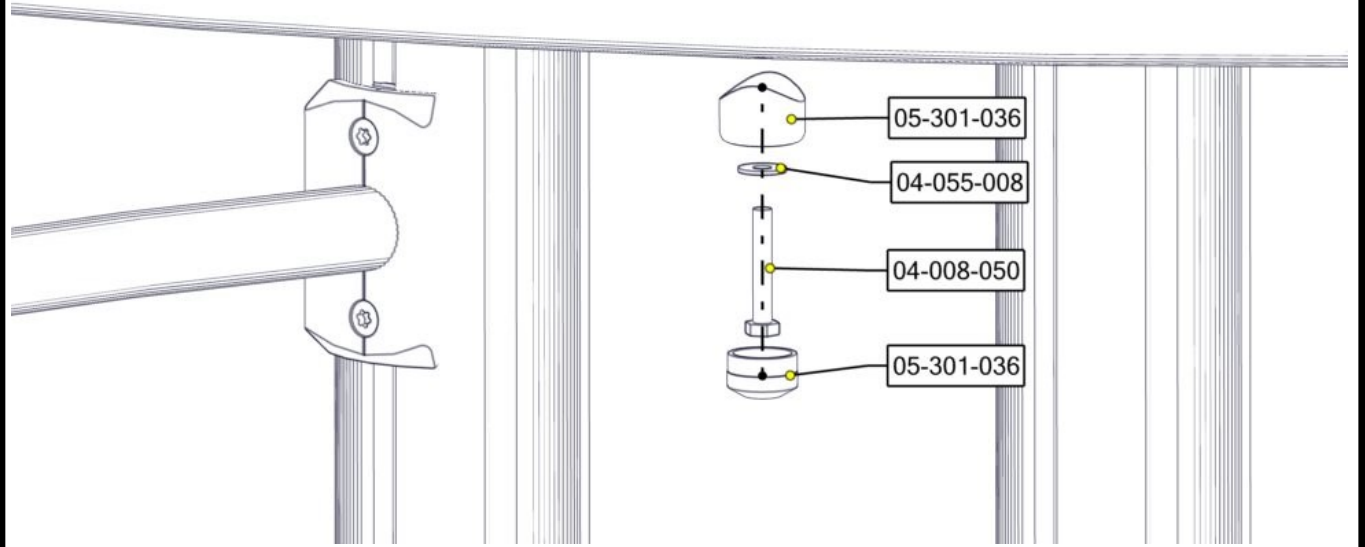
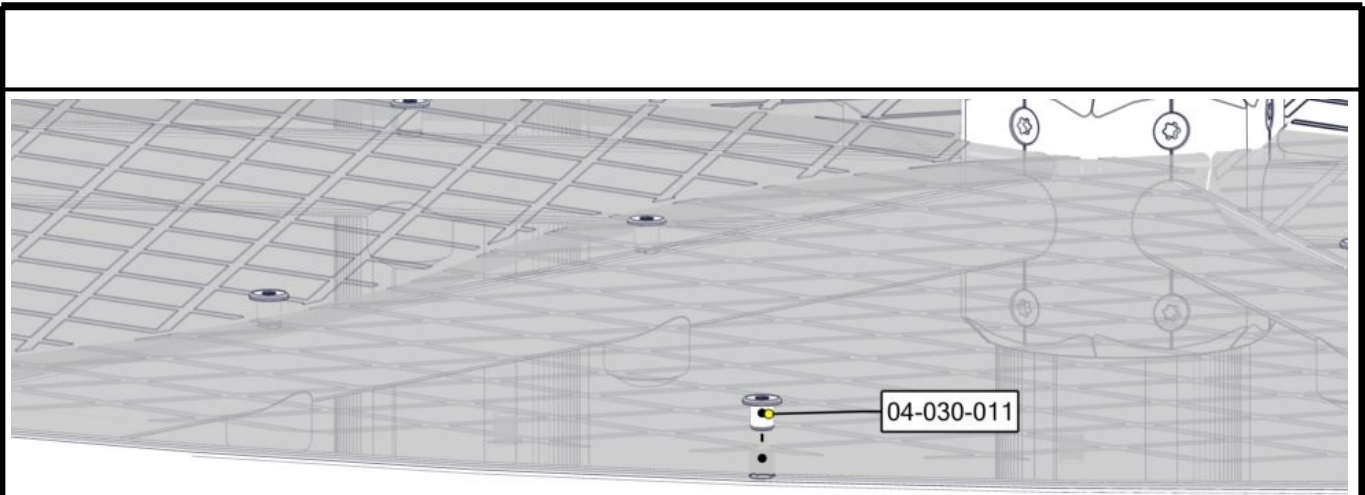

Part Name	Article nr.	Qty
Plastpropp 13mm hode / dekker 9-11 mm hull	04-090-002	10

Se separat delmontering for detaljer
 See separate assembly for details
 Se separata delmontering för detaljer

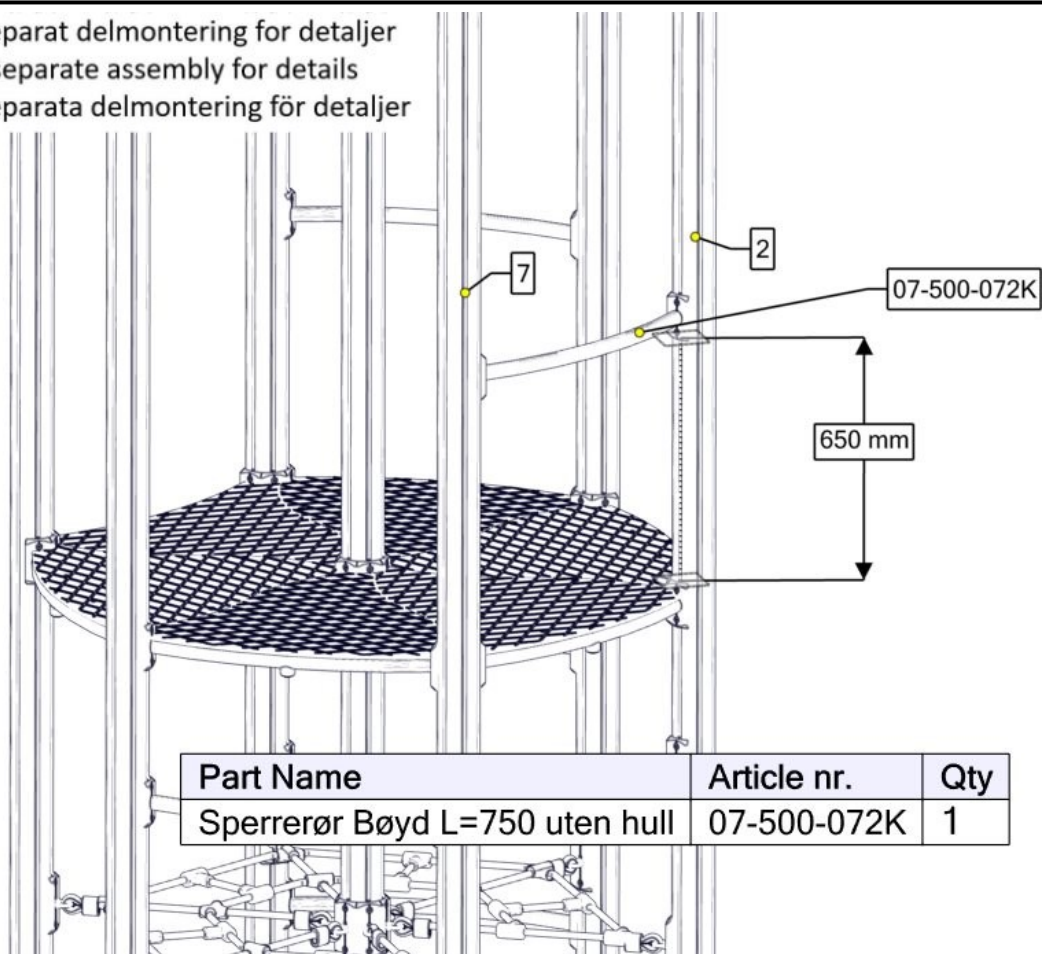

Part Name	Article nr.	Qty
Sperrerør Bøyd L=750 uten hull	07-500-072K	1

Se separat delmontering for detaljer
 See separate assembly for details
 Se separata delmontering för detaljer

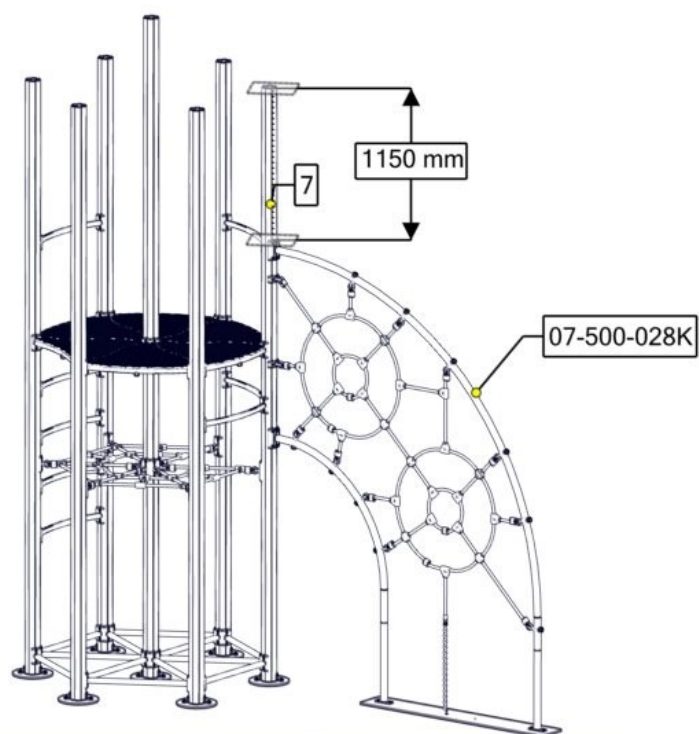

Part Name	Article nr.	Qty
Edderkoppnett dobbel 30 GR Komplet	07-500-028K	1

Se separat delmontering for detaljer
 See separate assembly for details
 Se separata delmontering för detaljer

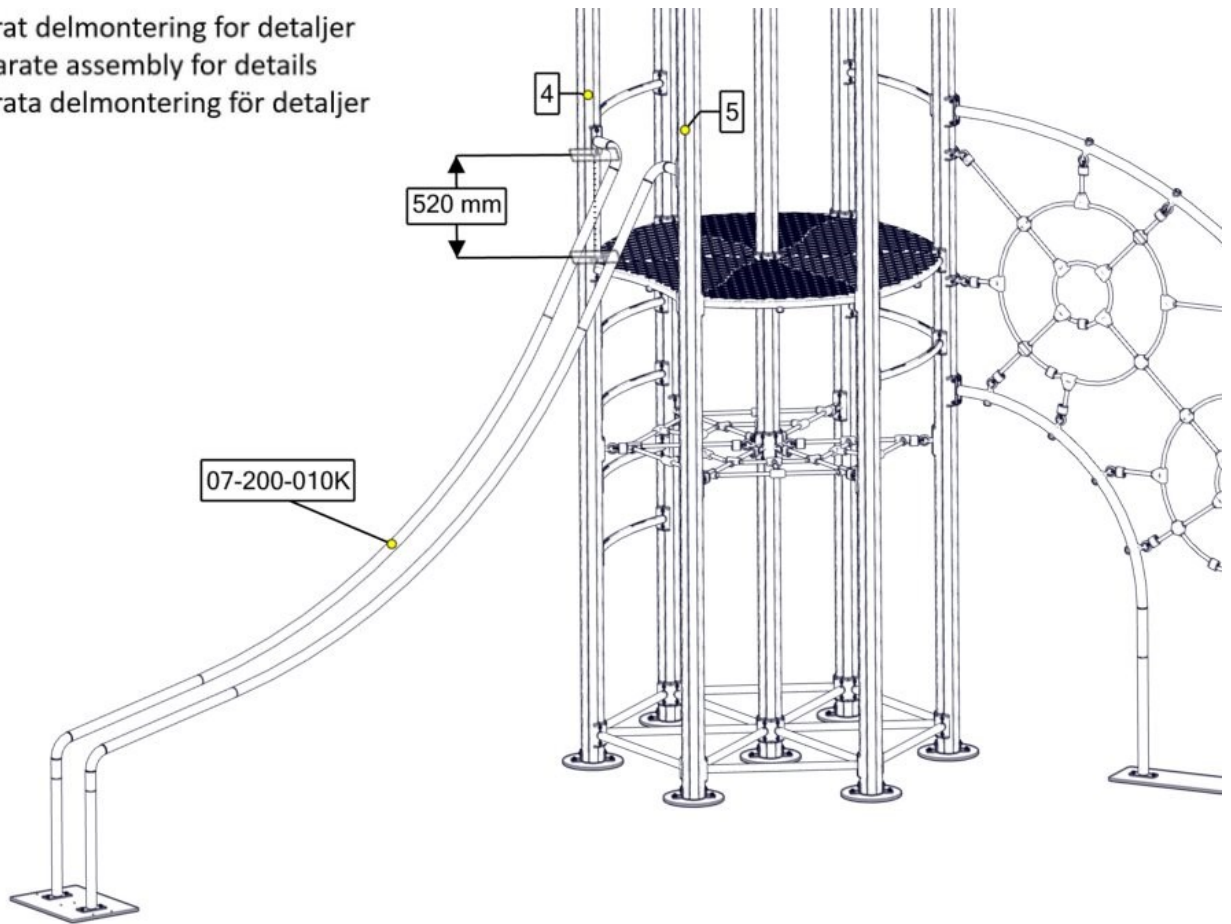

Se separat delmontering for detaljer
 See separate assembly for details
 Se separata delmontering för detaljer

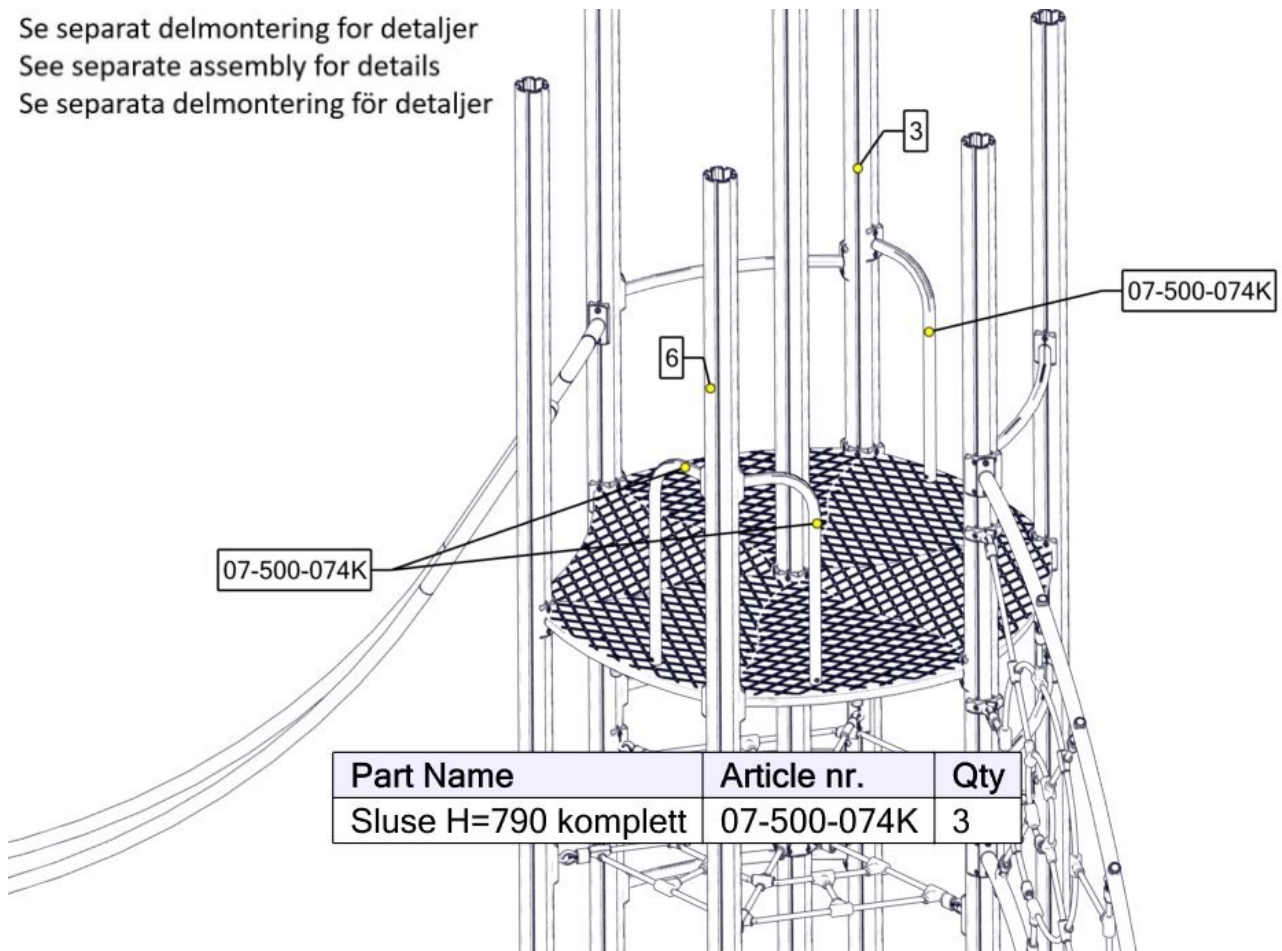

Part Name	Article nr.	Qty
Sluse H=790 komplett	07-500-074K	3

2x

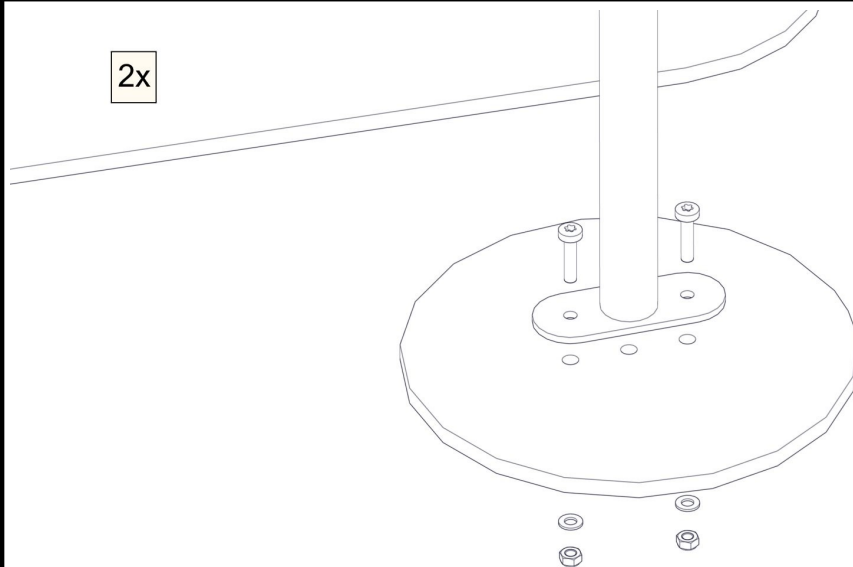

nr	PartName	Artnr	Antall
1	Fundament plate	00-003-106	1
2	Torx M8x35	04-000-035	2
3	Låsemutter M8	04-040-008	2

nr	PartName	Artnr	Antall
4	Skive M8	04-050-008	2

Se separat delmontering for detaljer
 See separate assembly for details
 Se separata delmontering för detaljer

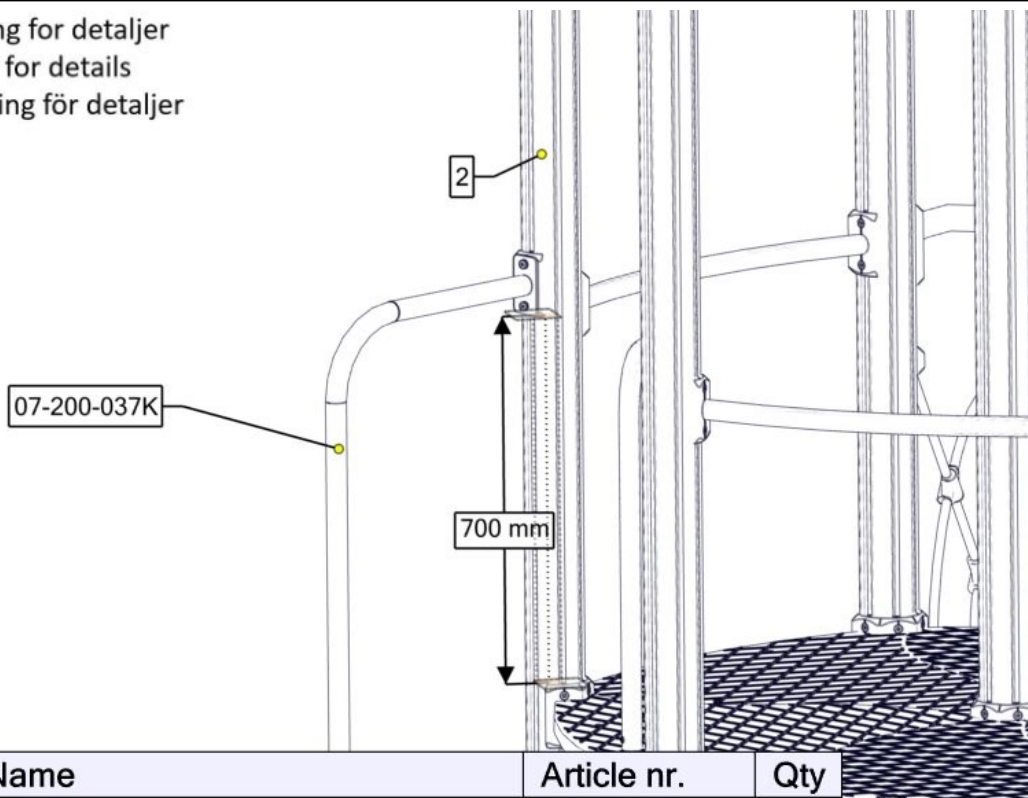

Part Name	Article nr.	Qty
Brannstang gulv 1,9m L=3000 komplett	07-200-037K	1

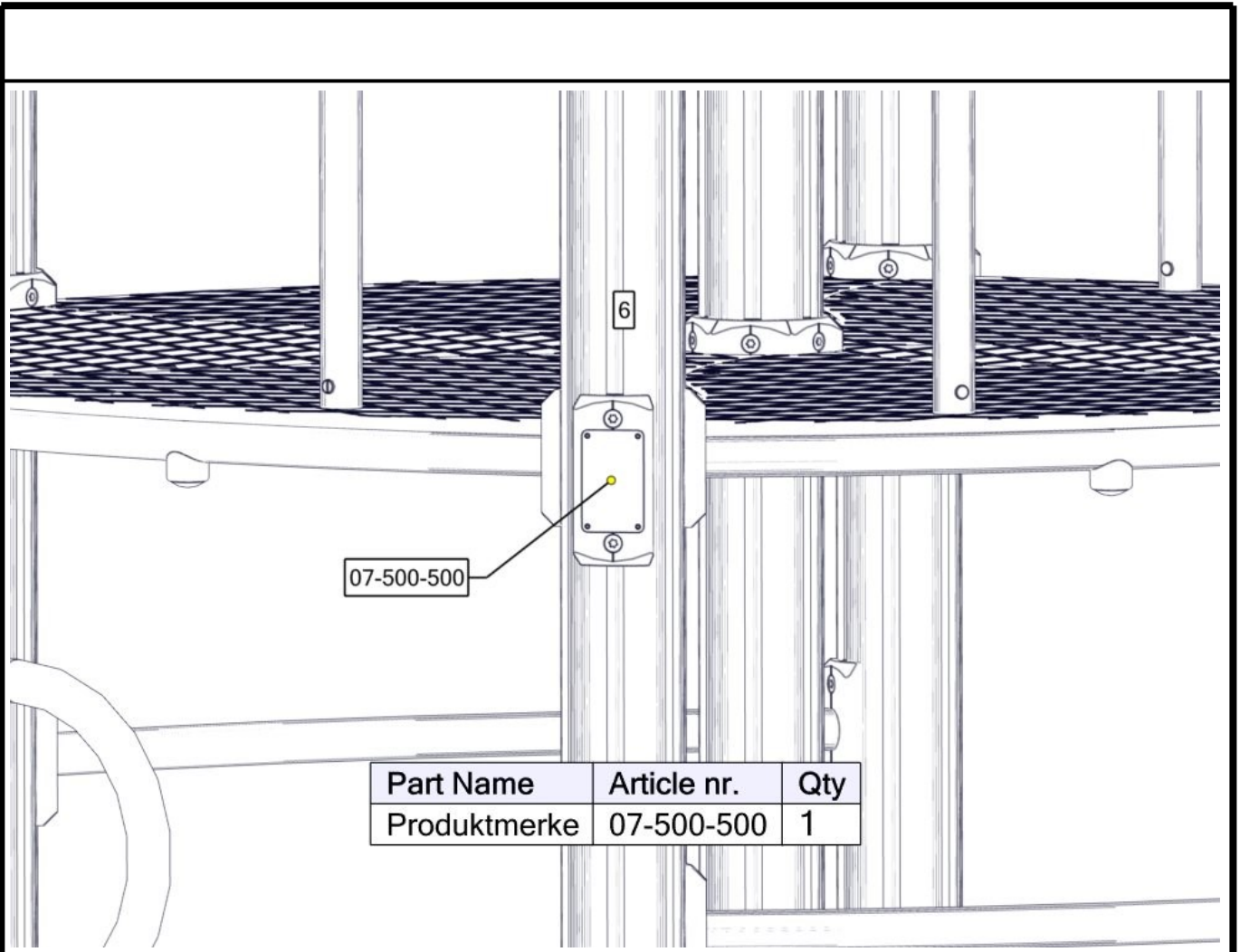

Part Name	Article nr.	Qty
Produktmerke	07-500-500	1

Se separat delmontering for detaljer
 See separate assembly for details
 Se separata delmontering för detaljer

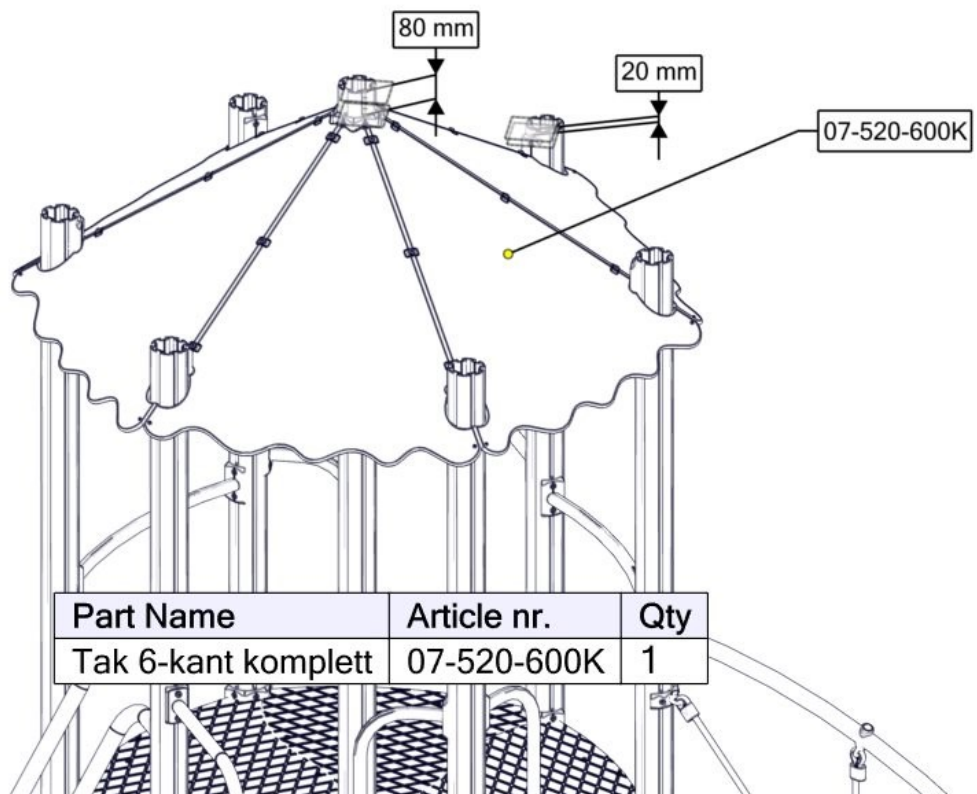





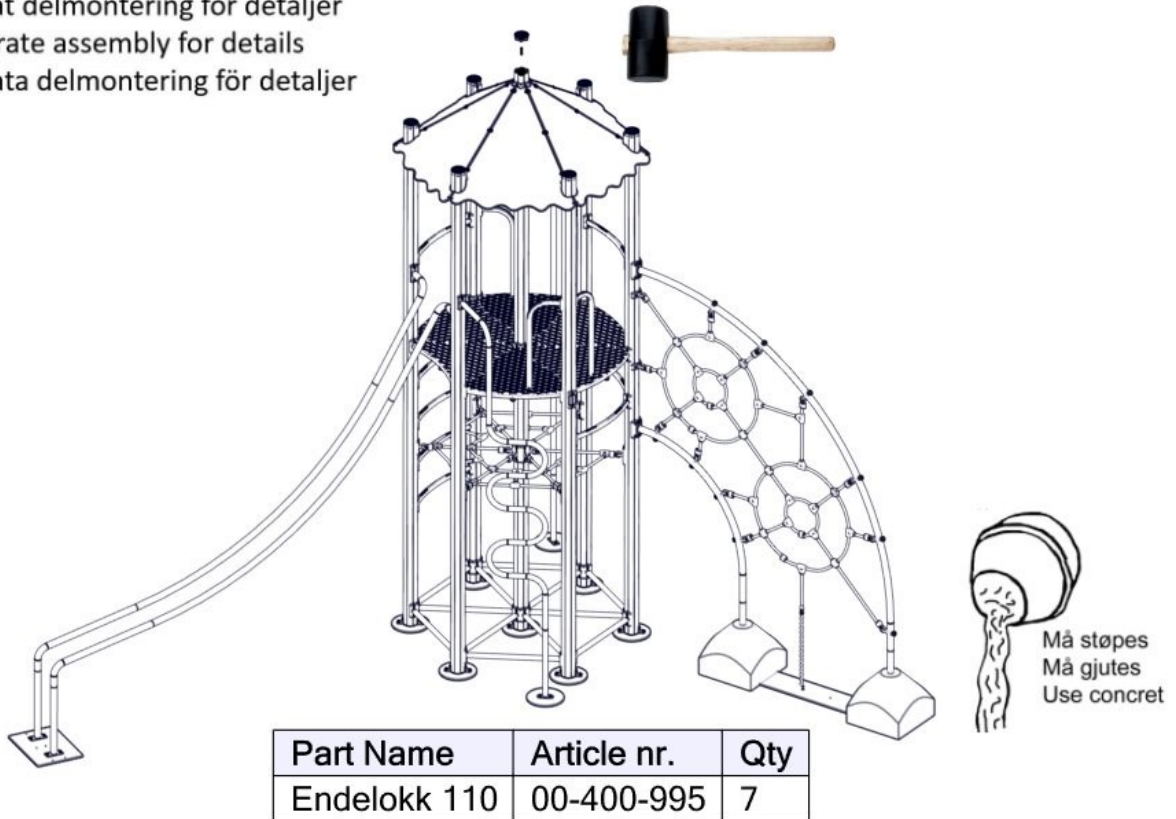

Part Name	Article nr.	Qty
Tak 6-kant komplett	07-520-600K	1

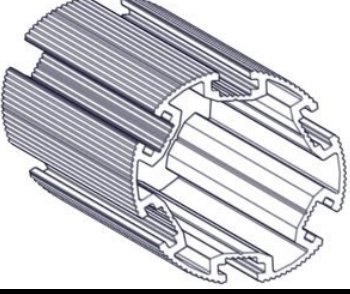

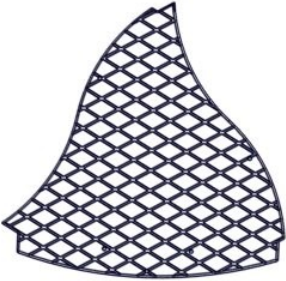
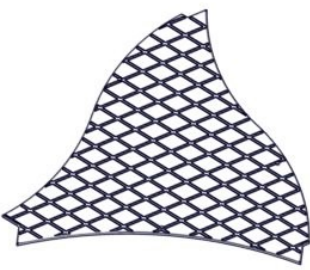
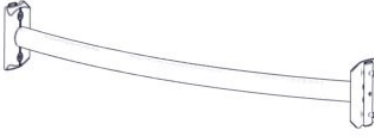

Se separat delmontering for detaljer
See separate assembly for details
Se separata delmontering för detaljer

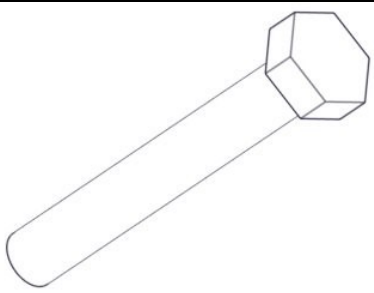

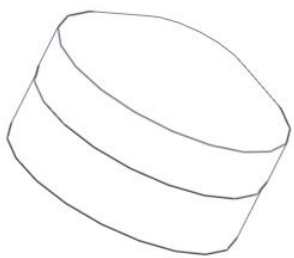
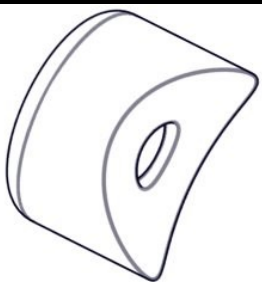
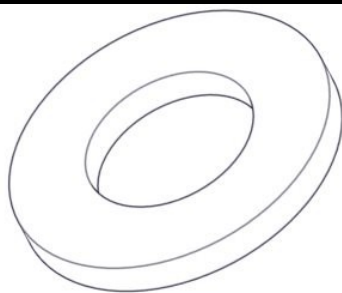
Før utstyret tas i bruk / Before play begins / Innan lekredskapet tas i bruk	
N	<ul style="list-style-type: none"> ● Påse at fallunderlag er utlagt i henhold til gjeldende regler eller vår anbefaling ● Fjern alle monteringshjelpemidler (rester av betong, planker, paller, plast, og lignende) ● Før utstyret tas i bruk, burde man sjekke at det ikke er fare for at anorakksnorer og lignende som kan hekte seg fast noen steder på lekeapparatet. (Vedlagte snor med dobbe (kneledd) kan brukes til å sjekke at dette er i orden. Se vedlagte veiledning for bruk av denne. Dette gjøres for å oppdage eventuelle feilmonteringer.) ● NB! Bør stå i 2-3 dager før bruk
EN	<ul style="list-style-type: none"> ● Make sure the area and depth of safer surfacing are according to the current standard, or to the manufacturer's recommendation ● Make sure all tools and surplus materials are removed before play begins ● PS! When complete, allow 2-3 days for the concrete to set before use
S	<ul style="list-style-type: none"> ● Kontrollera att fallunderlag är utlagt enligt gällande regler eller vårt rekommendation ● Ta bort alla monteringshjälpmedel (rester av betong, plankor, pallar, plast och liknande) ● Innan lekredskapet används, kontrollera att anoracksnoddar eller kläder/delar av kläder eller liknande inte kan fastna i några delar på redskapet. (Den bipackade "knävringen" kan man med fördel användas för denna kontroll. ● Detta görs för att upptäcka eventuella felmonteringar.)

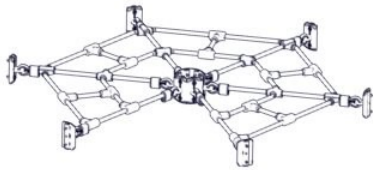

Boltepakker for / Boltpackage for / Bultpaket för		Sign. _____		
Thorium Nøytron 14-200-020	Navn	Artnr/ dimensjon	Ant	Lev
	Stolpe Ø110 L=5000 Grå Stolpe Ø110 L=4500 Grå	SFA5126/2 SFA5126/2	1 6	
	Endelokk til stolpe Ø110	00-400-995	7	
	Gulv 6-kant Grå	07-301-120	5	
	Gulv 6-kant 1 konkav Grå	07-301-121	1	
	Sperrerør bøyd Lengde = 750 Uten hull Grønn	07-500-072K (Se egen del- montering)	8	
	Sperrerør 6-kant gulv L=750 2 Hull Sort	07-500-064K (Se egen del- montering)	6	

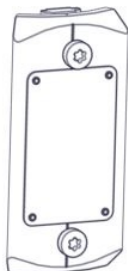

Boltepakker for / Boltpackage for / Bultpaket för		Sign. _____		
Thorium Nøytron 14-200-020	Navn	Artnr/ dimensjon	Ant	Lev
	Sperrerør bøyd med hull gulv L=750 Sort	07-500-060 (Se egen del- montering)	6	
	Sekskant M8x50	04-008-050	18	
	Møbelknapp M8x11	04-008-050	18	
	Plast rørfeste, hode	05-301-036	18	
	Plast rørfeste, kropp	05-301-036	18	
	Skive M8 stor	04-055-008	18	

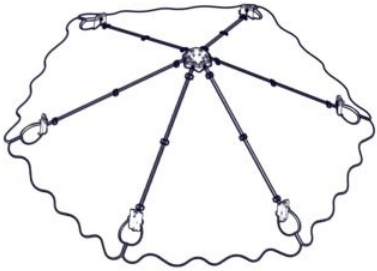

Boltepakker for / Boltpackage for / Bultpaket för		Sign. _____		
Thorium Nøytron 14-200-020	Navn	Artnr/ dimensjon	Ant	Lev
	Edderkoppnett horisontalt CC = 880 Grønn	07-500-211K (Se egen del- montering)	1	
	Slider	07-200-010K (Se egen del- montering)	1	
	Klatrestang Gulvhøyde = 1,9m Grå	07-200-038K (Se egen del- montering)	1	
	Brannstang Gulvhøyde = 1,9m Grå	07-200-037K (Se egen del- montering)	1	
	Sluse Høyde = 790 Grønn	07-500-074K (Se egen del- montering)	3	
	Produktmerke	07-500-500	1	

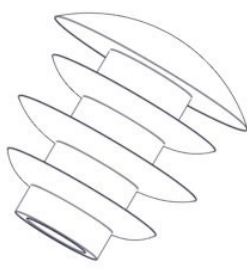
Boltepakker for / Boltpackage for / Bultpaket för

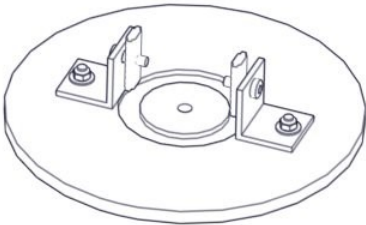
Sign. _____.

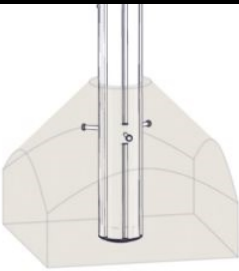
Thorium Nøytron 14-200-020	Navn	Artnr/ dimensjon	Ant	Lev
	Tak 6-kant CC = 880 Grå	07-520-600K (Se egen del- montering)	1	
	Edderkoppnett dobbel 30gr Grønn	07-500-028K (Se egen del- montering)	1	
	Plastpropp	04-090-002	10	

Boltepakker for / Boltpackage for / Bultpaket för		Sign. _____		
Thorium Nøytron 14-200-020	Navn	Artnr/ dimensjon	Ant	Lev
	Nedgravnings fundament			
	Sperrerør rett Lengde = 750 Uten hull Sort	07-500-075K (Se egen del- montering)	12	
	Fundamentplate 1xØ110 stolpe	07-400-101K (Se egen del- montering)	7	
	Støp fundament			
	Sperrerør rett Lengde = 750 Uten hull Sort	07-500-075K (Se egen del- montering)	12	
	Fundament betong Stolpe Ø110	00-003-111K (Se egen del- montering)	7	

Boltepakker for / Boltpackage for / Bultpaket för		Sign. _____.		
Thorium Nøytron 14-200-020	Navn	Artnr/ dimensjon	Ant	Lev
	Overflatemon- tering			
	Fundament 2xØ110 stolpe for betongdekke	00-003-114K (Se egen del- montering)	2	
	Fundament 3x110 stolpe for betongdekke	00-003-115K (Se egen del- montering)	1	
	Stolpe Ø110 må kappes	SFA5126/1	(7)	
	Slider må kappes	07-200-010K	(1)	
	Brannstang må kappes	07-200-037K	(1)	
	Klatrestang må kappes	07-200-038K	(1)	
	Eddekoppnett må kappes	07-500-028K	(1)	

Revisjon:

20.08.2020_MTF

Oppdatert tabell

Oppdatert plukklister for fundament

22-11-2021 SV

Endret sikkerhetsone for slider