

N

Monteringsanvisning

EN

Assembly Instructions

S

Monteringsanvisning

Produkt nr. / Product no. / Produkt nr.

14-200-120

Ord. nr. _____

Dato. _____

Sign. _____

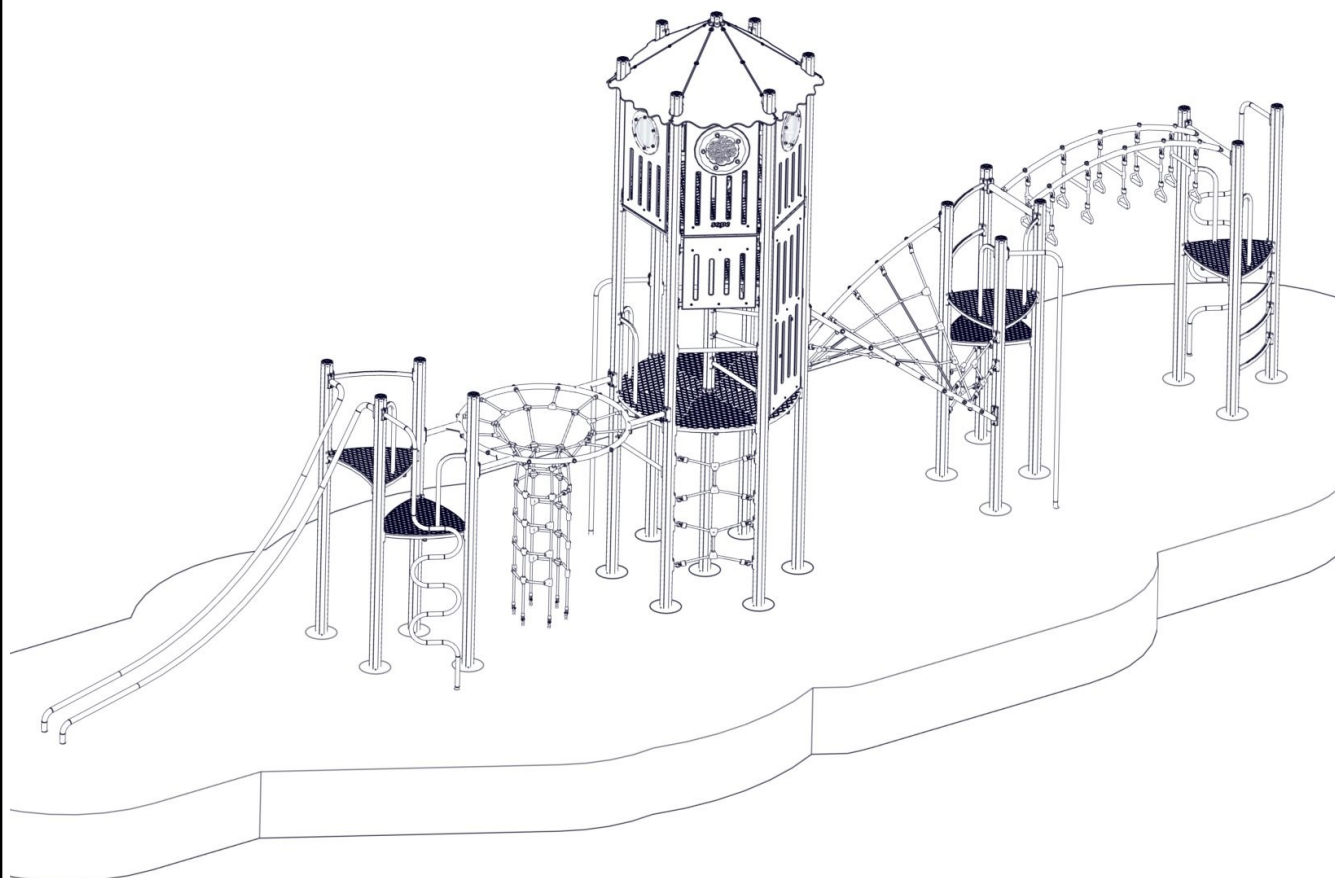
**søve**

Søve AS
Grønnvoldveien 290
3830 Ulefoss - Norway
Tlf: +47 35 94 65 65
www.sove.no

**søve**

Søve AB
EA Rosengrensgatan 32
421 31 Västra Frölunda
Phone: +46 (0)31 773 97 00
www.sove.se

Monteringstips / Assembly Advice / Monteringsstips**N**

- Les monteringsanvisningen nøye før montering.
- Monter elementene i rekkefølgen som vist.
- Boltene bør ikke skrues for hardt til før alt er montert, vatret og loddet. Skru så boltene til.
- NB! Ved bruk av drill, kan boltene ryke.
- På grunn av at solen kan gjøre rutsjeflaten veldig varm, bør rutsjebanens utløp vende mot nord-øst eller nord-vest.
- Er lekeutstyret plassert i naturlige ferdselstraséer må området sikres mot gjennomgang.
- Innspringningshinder bør vurderes rundt lekeapparater hvor det er stor bevegelse, f.eks. ved huskestativ.
- Det bør være fritt innsyn til lekeutstyr som er beregnet for barn under 3 år.

NB! Under monteringsarbeidet må utstyr, som ikke er forankret forsvarlig i bakken, sikres slik at det ikke velte.

Området må avstenges under montering av apparatene med sperrebånd eller lignende.

EN

- Read the instruction carefully before assembling the play unit.
- Assemble the components in the sequence shown in these instructions. Fixings must not be fully tightened during assembly. Before casting the foundations, the structure must be level and plumb, at which point all fixings are tightened. PS! If use of drill, the bolts may be wrecked.
- Avoid positioning the slide facing due south because of overheating – ideal positions are facing north-east or north-west. Secure the construction-area to prevent people from walking through it.
- Consider installing barriers around play-equipment which gives rise to a lot of activity – i.e. swings.
- Ensure that clear vision is possible across the play area so that supervision is possible from any position, particularly where children under 3 years of age will be playing.

NB! During assembly of the equipment, ensure that all structures are securely propped, especially when left overnight. Also ensure that equipment is supported

Monteringstips / Assembly Advice / Monteringsstips**S**

- Läs monteringsanvisningen noga före montering.

- Montera delarna i den ordningen som anvisas
- Skruvarna bör inte skruvas för hårt tills allt är monterat, i våg och lodat.









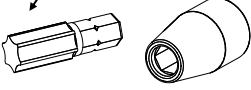

OBS! Används elektrisk skruvdragare, kan bulten gå sönder. Hårdra därför manuellt!

- Solen kan göra att rutchbanan blir väldigt varm. Banans nedfart rekommenderas att vändas i norrlig riktning
- Om lekplatsen placeras vid en gångväg mm bör området säkras mot genomfart av gående och cyklister.
- Insprängningshinder bör placeras runt lekutrustning med stor rörelse, t ex, gungställning.
- Det bör vara fri insyn till lekutrustning beräknat till barn under 3 år.

OBS! Under monteringsarbete bör utrustningen som inte ska förankras i marken, ställs så att den inte kan välta.

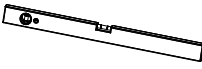
Området måste spärras när lekutrustningen byggs upp, med avspärrningsband eller liknande.

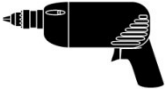
Nødvendig verktøy / Tools required / Nödvändiga verktyg





<p>(N)</p> <p>(EN)</p> <p>(S)</p>	<p>(A)</p> 	<p>(B)</p>  <p>Torx Nr 45 High quality</p> 	<p>(C)</p>  <p>13 + 17mm</p> 	<p>(D)</p> 	<p>(E)</p> 
		<p>Metermål</p> <p>Metric measure</p> <p>Tumstock</p> 	<p>16 V</p> 	<p>Merkebånd</p> <p>Mark ribbon</p> <p>Märkeband</p> 	<p>5 mm</p> <p>6 mm</p> 

Nødvendig antall personer / Number of persons required / Rekommenderad antal personer

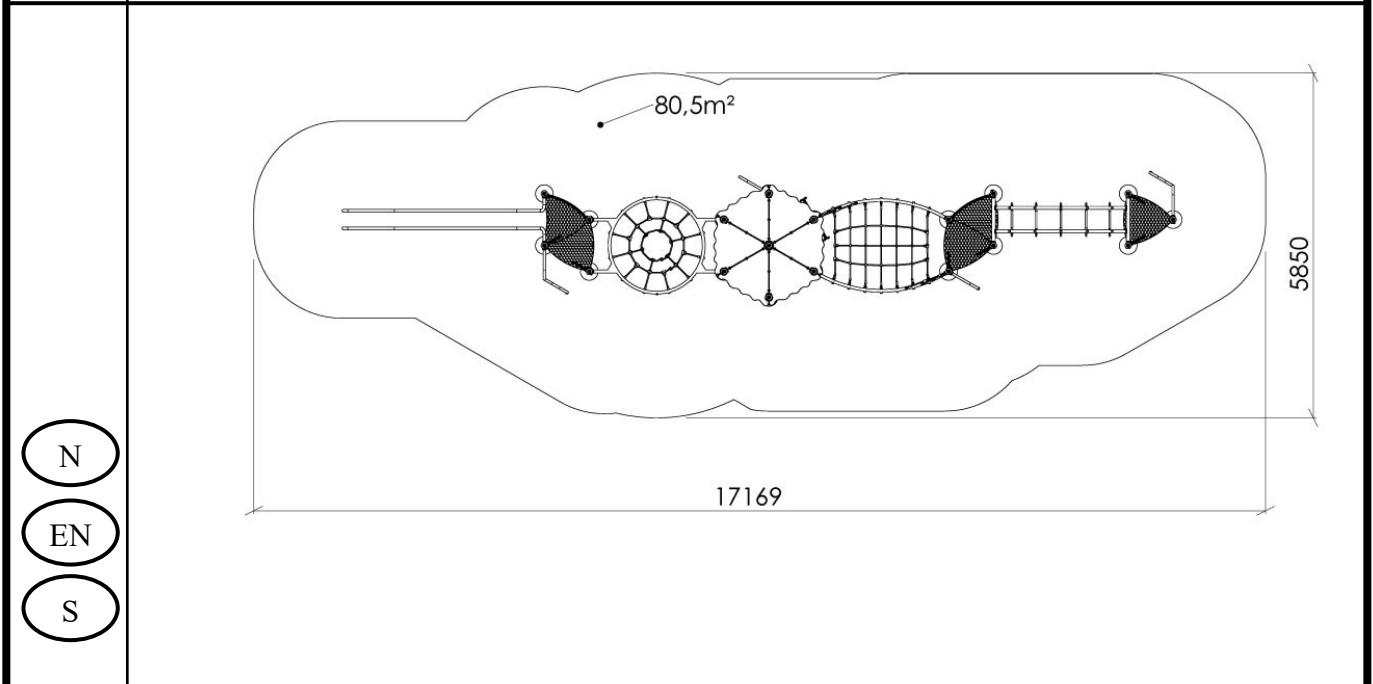

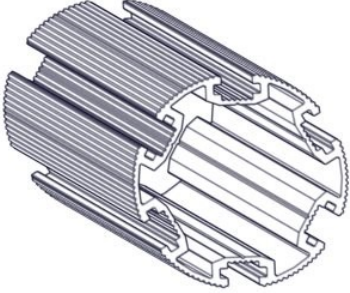



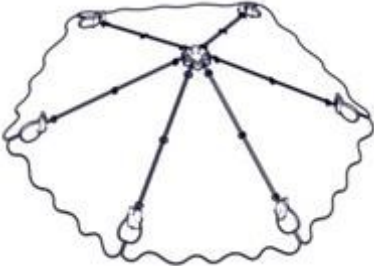
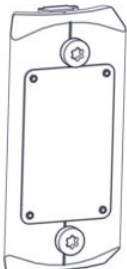

Anbefalt arealbehov ved montering / Recommended working space / Rekommenderad arealbehov vid montering



Boltepakker for / Boltpackage for / Bultpaket för		Sign. _____.		
Thorium 14-200-120	Navn	Artnr/dimensjon	Ant	Lev
	StolpeØ110 L=3450 Grå 600-2850	SFA5126/2	11	
	Endelokk til stolpe Ø110	00-400-995	18	
	Thorium Tårn-del 1	07-302-200 (se egen del- montering)	1	
	Thorium Tårn del 2_b	07-302-220 (se egen del- montering)	1	
	Sperrerør rett L=750 Uten hull Grønn	07-500-059K (se egen del- montering)	1	
	Tak 6-kant Grå	07-520-600K (se egen del- montering)	1	
	Produktmerke	07-500-500 (se egen del- montering)	1	

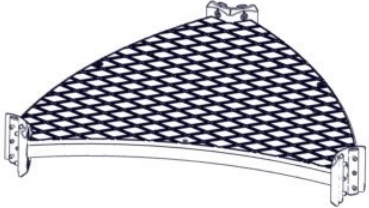

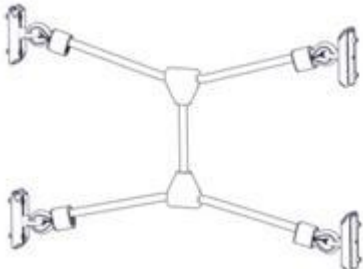
Boltepakker for / Boltpackage for / Bultpaket för



Sign. _____

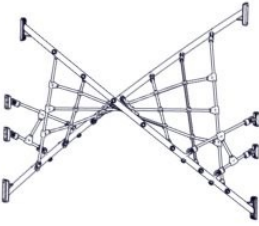
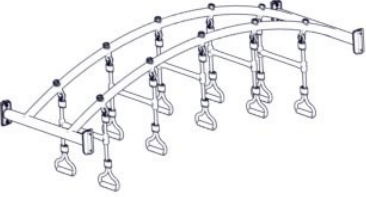

Thorium 14-200-120	Navn	Artnr/dimensjon	Ant	Lev
	Sluse H=790 Grønn	07-500-074K (se egen del- montering)	8	
	Gulv 3-kant standard CC880 Grå	07-300-104K (se egen del- montering)	4	
	Gulv 3-kant 1 Konkav CC880 Grå	07-300-105K (se egen del- montering)	1	
	Brannstang Gulv = 1,95m Grå	07-200-037K (se egen del- montering)	2	
	Spideroppgang CC880 Grønn	07-500-266K (se egen del- montering)	3	
	Bro rundgang med sjakt CC880 L=2200	07-200-260K (se egen del- montering)	1	

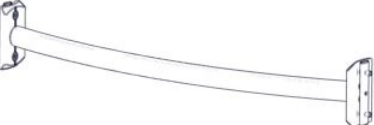
Boltepakker for / Boltpackage for / Bultpaket för

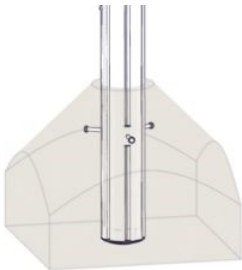
Sign. _____

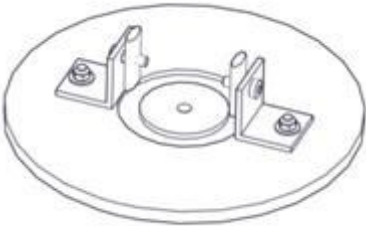
Thorium 14-200-120	Navn	Artnr/dimensjon	Ant	Lev
	Bro tordert nett Grønn	07-500-311K (se egen del- montering)	1	
	Bro med handtak polyfix CC880 Grønn	07-500-293K (se egen del- montering)	1	
	Slider rør	07-200-010K (se egen del- montering)	1	
	Klatrestang Gulv 1,9m L=2,3	07-200-038K (se egen del- montering)	2	
	Sperrerør bøyd L=750 uten hull Grønn	07-500-072K (se egen del- montering)	6	

Boltepakker for / Boltpackage for / Bultpaket för		Sign. _____		
Thorium 14-200-120	Navn	Artnr/dimensjon	Ant	Lev
	Fundament støp			
	Sperrerør L=750 Sort	07-500-075K (se egen del- montering)	13	
	Fundament betong	00-003-111K (se egen del- montering)	11	
	Fundament Nedgraving			
	Sperrerør L=750 Sort	07-500-075K (se egen del- montering)	13	
	Fundament 1x110	07-400-101K (se egen del- montering)	11	

Boltepakker for / Boltpackage for / Bultpaket för		Sign. _____.		
Thorium 14-200-120	Navn	Artnr/ dimensjon	Ant	Lev
	Overflatemon- tering			
	Fundament 2xØ110 stolpe for betongdekke	00-003-114K (Se egen del- monering)	4	
	Fundament 3xØ110 stolpe for betongdekke	00-003-115K (Se egen del- monering)	1	
	Stolpe Ø110 må kappes Slider må kappes Brannstang må kappes S-trapp må kappes	SFA5126/2 07-200-010 07-200-037 07-200-038		

Fundamentering med betong // Foundation concrete // Förankring med betong

- (N) Støtdempende materialer
- (EN) Impact attenuating materials
- (S) Støtdämpande material Ref NS-EN 1176-1 §4.2.8.5

- (N) Bakkenivå
- (EN) Ground level
- (S) Marknivå

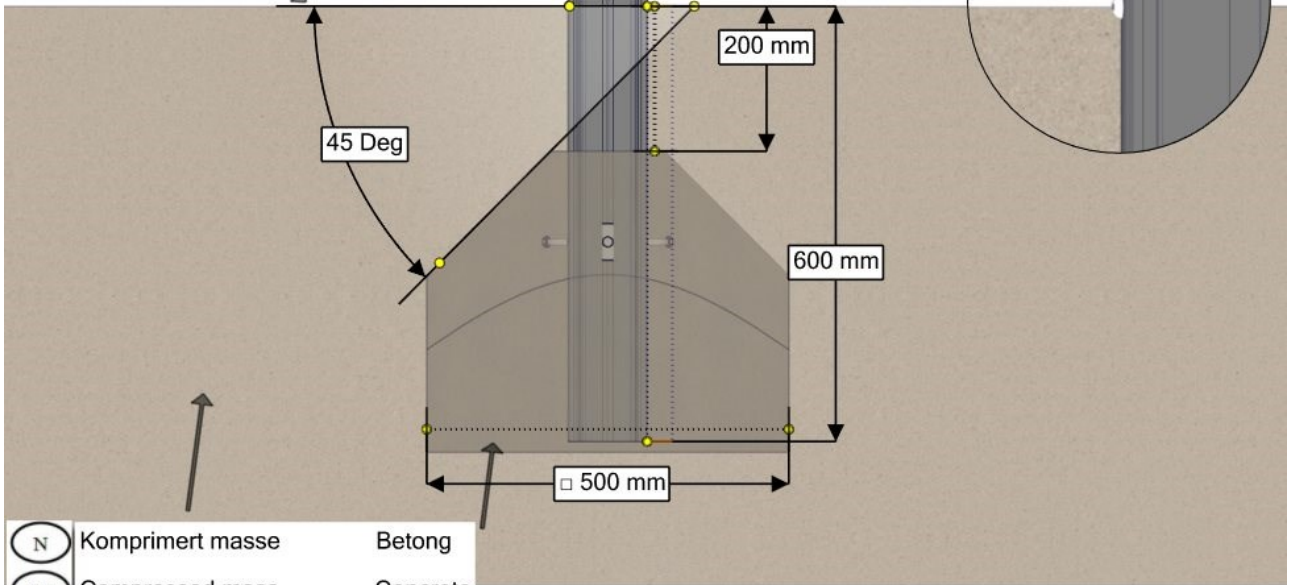

- (N) Komprimert masse Betong
- (EN) Compressed mass Concrete
- (S) Komprimerad massa Betong

Fundamentering uten betong // Foundation without concrete // Förankring utan betong

- (N) Støtdempende materialer
- (EN) Impact attenuating materials Ref NS-EN 1176-1 §4.2.8.5
- (S) Støtdämpande material

- (N) Bakkenivå
- (EN) Ground level
- (S) marknivå

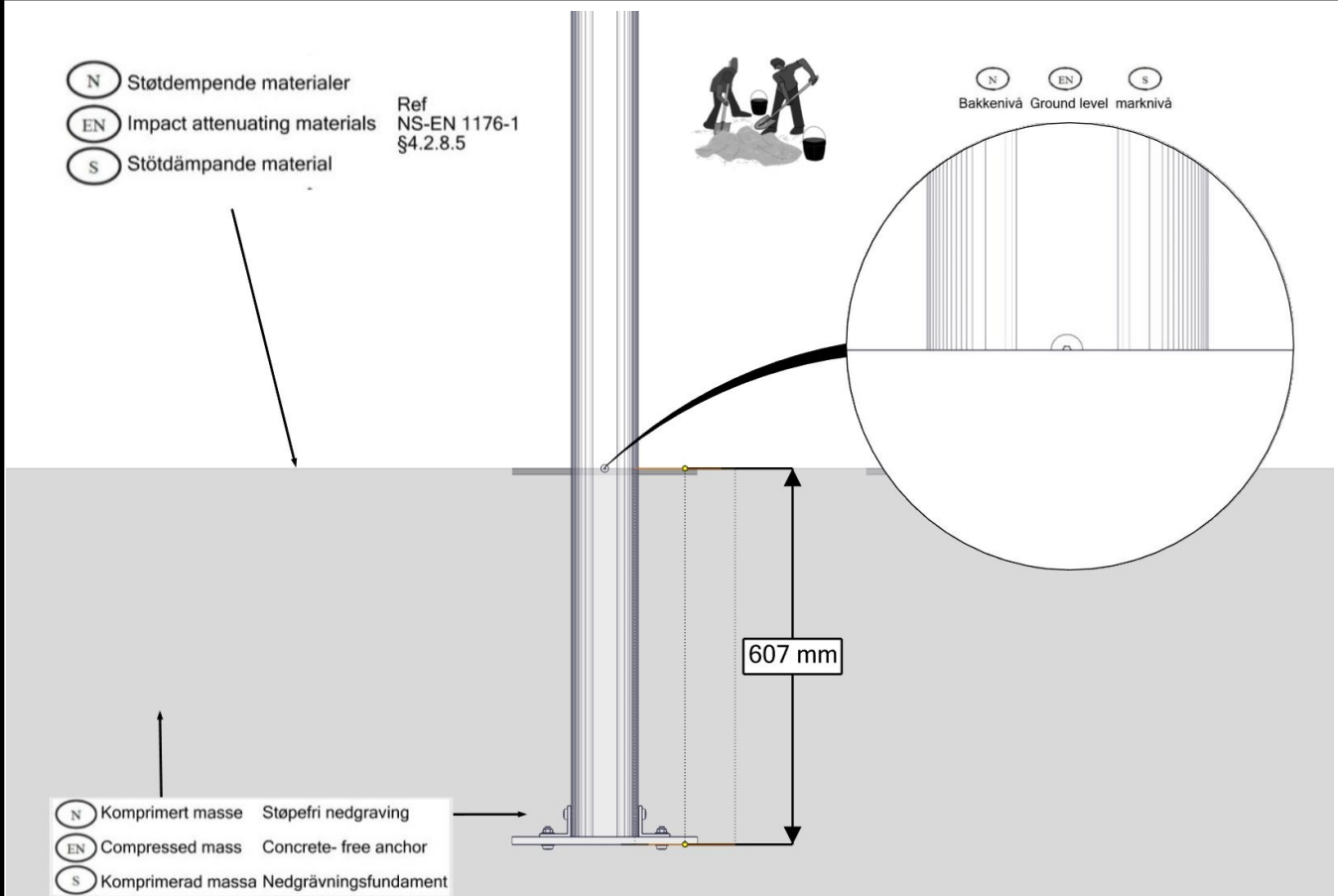

- (N) Komprimert masse Støpefri nedgraving
- (EN) Compressed mass Concrete-free anchor
- (S) Komprimerad massa Nedgravningsfundament

Fundamentering overflate / Foundation surface / Förankring grundytan

Ref
NS-EN 1176-1
§4.2.8.5

N EN S
Bakkenivå Ground level marknivå

Tykkelse/Thickness

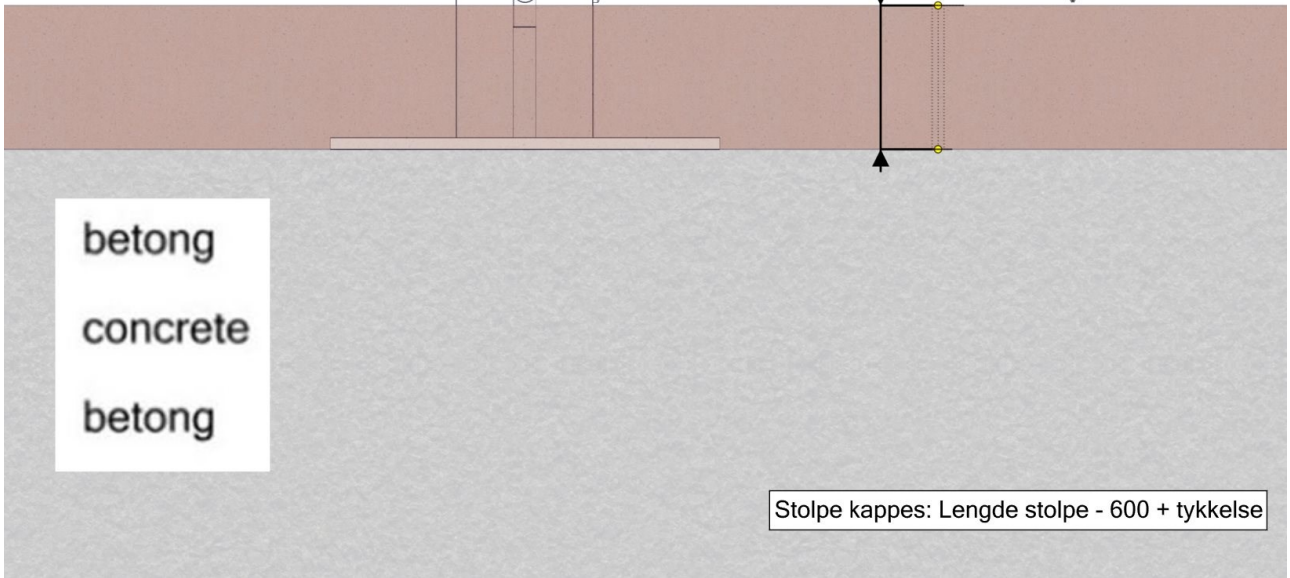

Use: 00-003-114K

Use: 00-003-115K

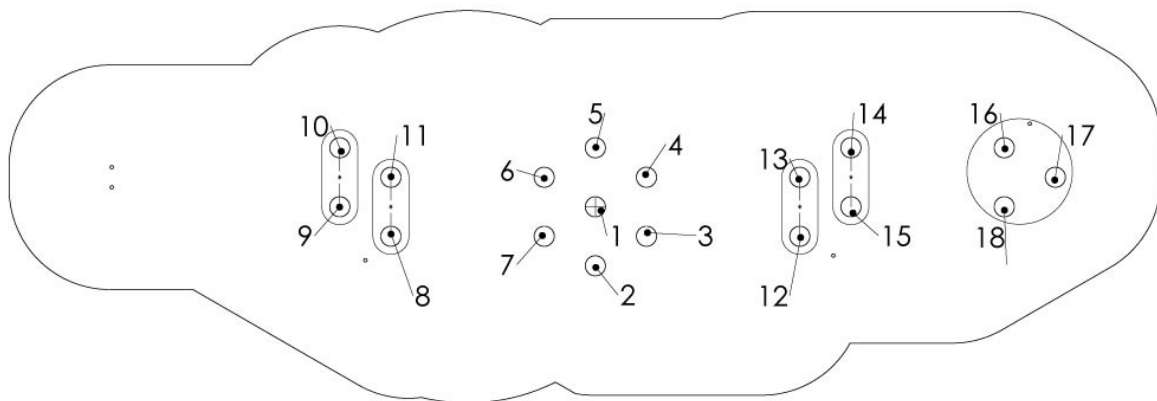

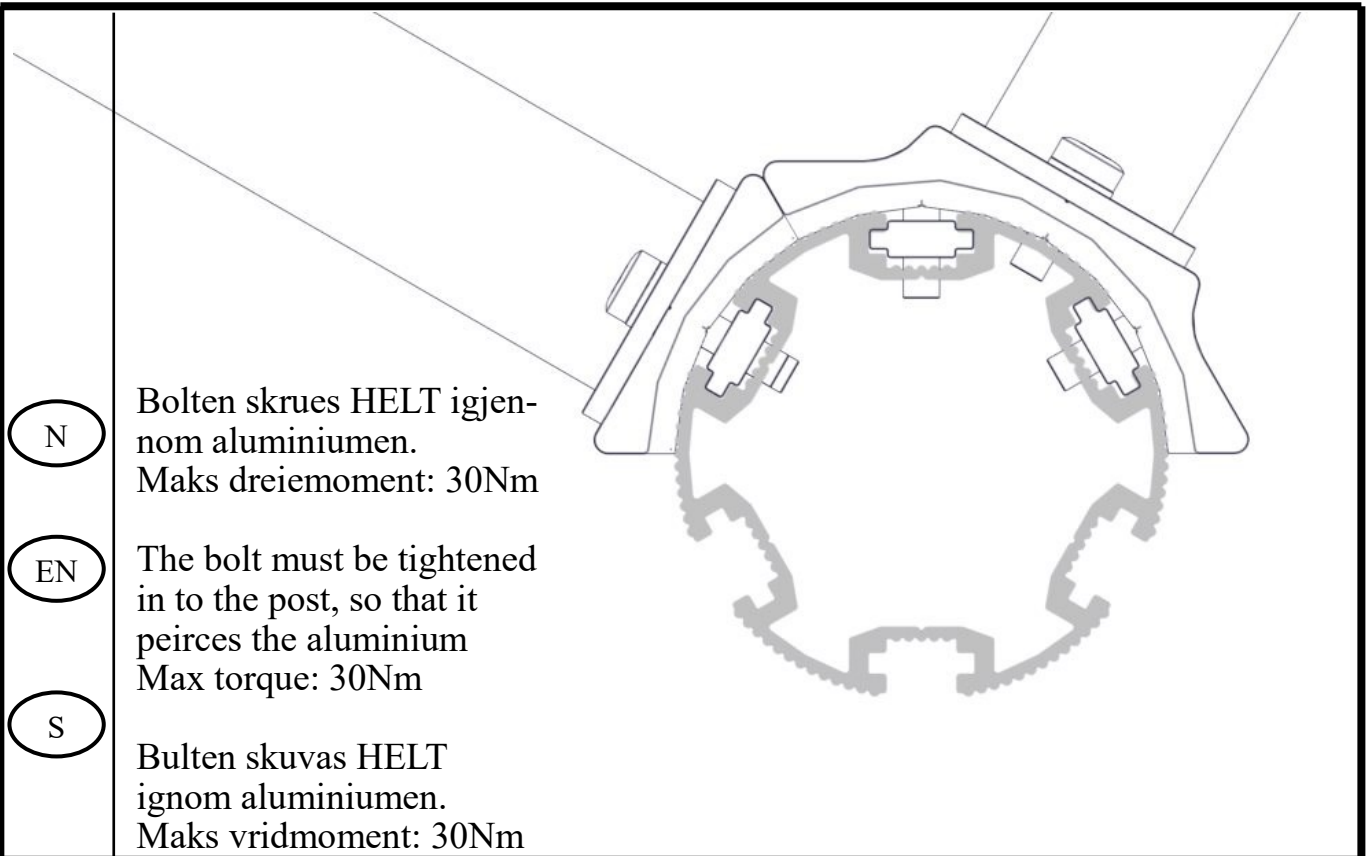

NO	Betongkvalitet	C25/30		
SE	Betongkvalitet			
EN	Concrete quality			
NO	Mengde betong		2	m ³
SE	Mängd betong			
EN	Amount of concrete			
NO	Fundament størrelse		0,5 x 0,5 x 0,4	m
SE	Stiftelsestorlek			
EN	Foundation size			
NO	For sikkerhet må fundamentene med sand eller myk jord være minst 50% større i areal			
SE	För säkerheten måste grunden med sand eller mjuk jord vara minst 50% större i området			
EN	For safety, the foundations with sand or soft soil must be at least 50% larger in area			
NO	Tyngste element	07-500-294	22,5	Kg
SE	Tyngsta element			
EN	Heaviest element			
NO	Største element	07-500-294 SFA5126/2	0,75x2,23x0,4 L=6,45 Ø=0,11	m
SE	Största element			
EN	Biggest element			

Fallhøyder / Free height of fall / Fallhöjder

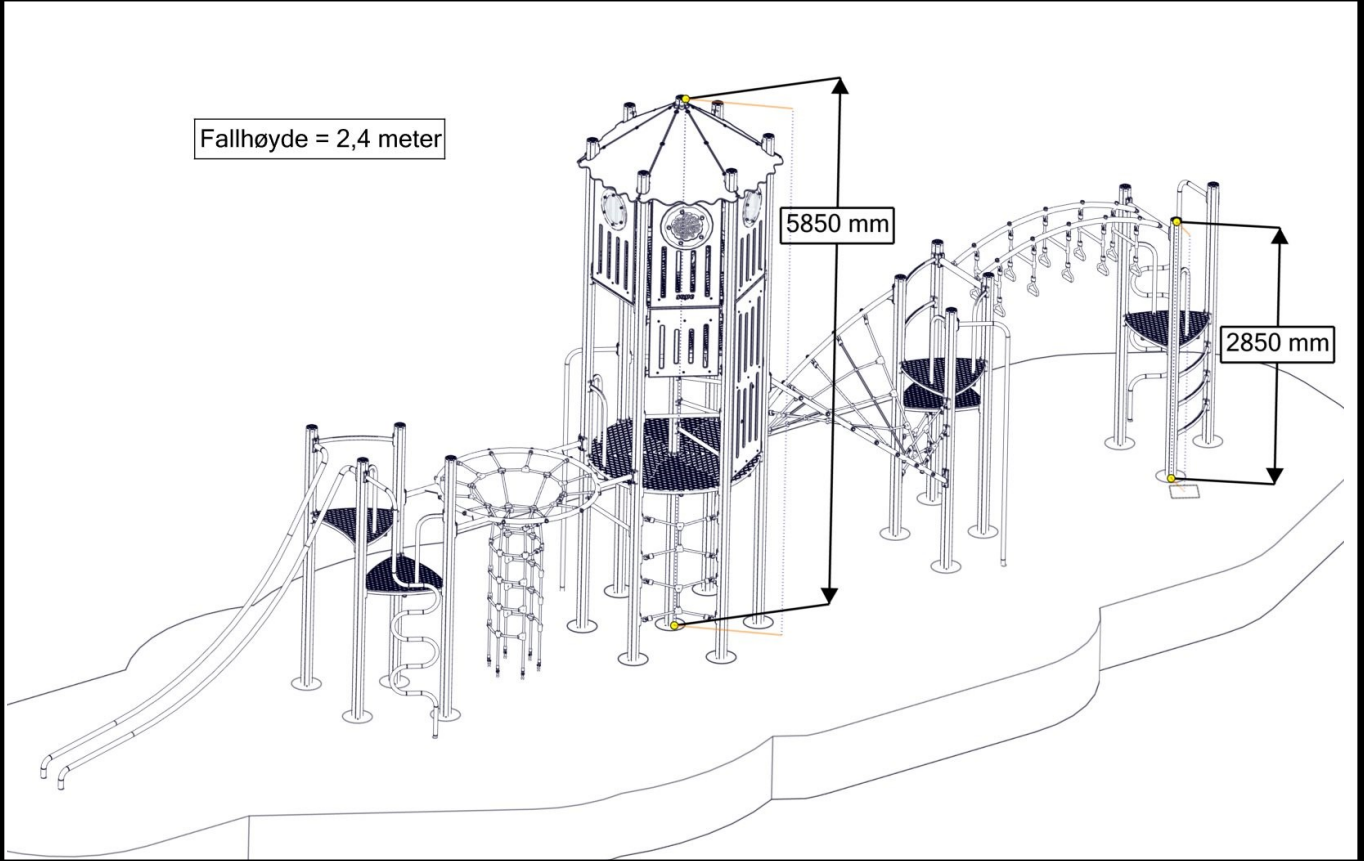

Sikkerhetszone / Safety zone / Säkerhetszon

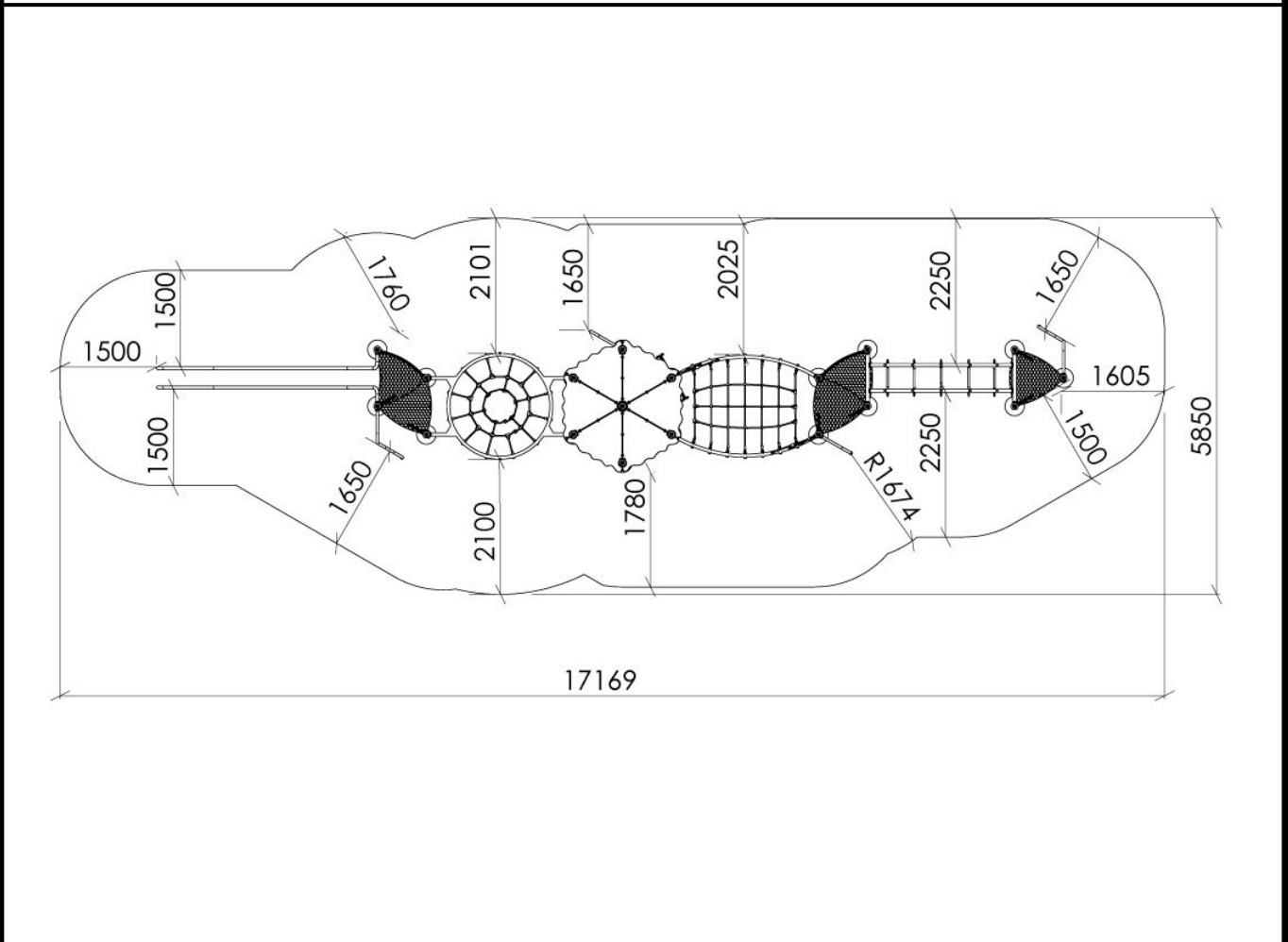

Plassering av forankringer / Ground plan / Placering av förankringar

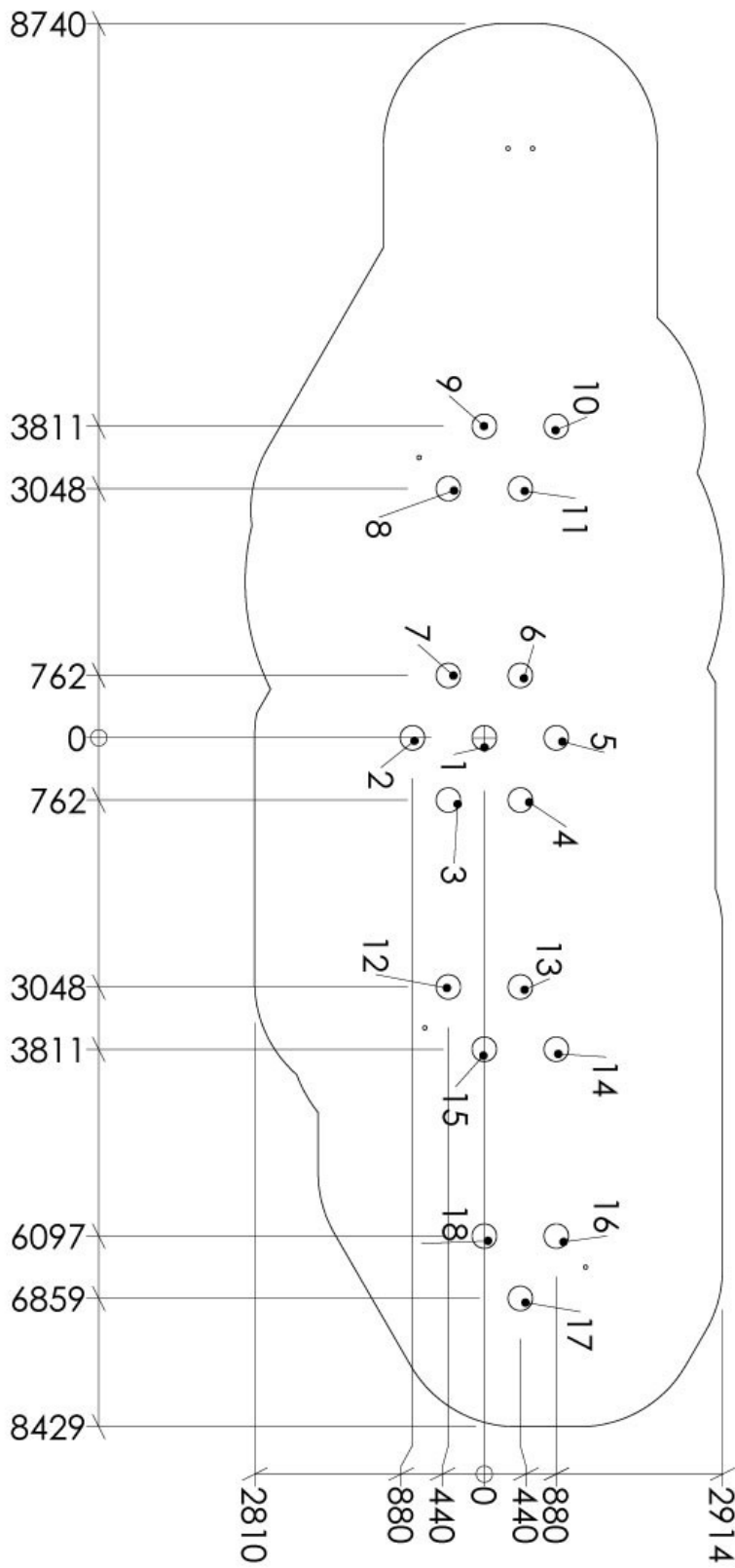

N

Alle mål er oppgitt i millimeter

EN

Scale measured in mm

S

Alla mått är i millimeter.

Se separat delmontering for detaljer
See separate assembly for details
Se separata delmontering för detaljer

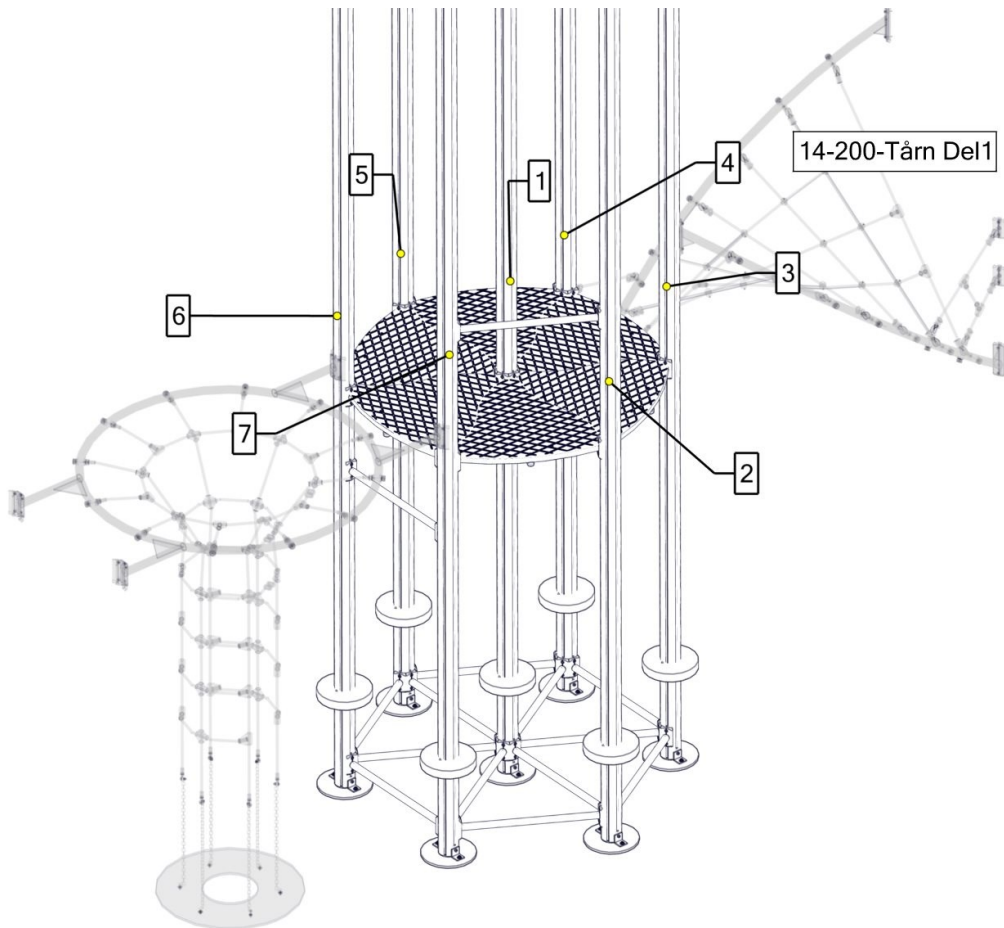
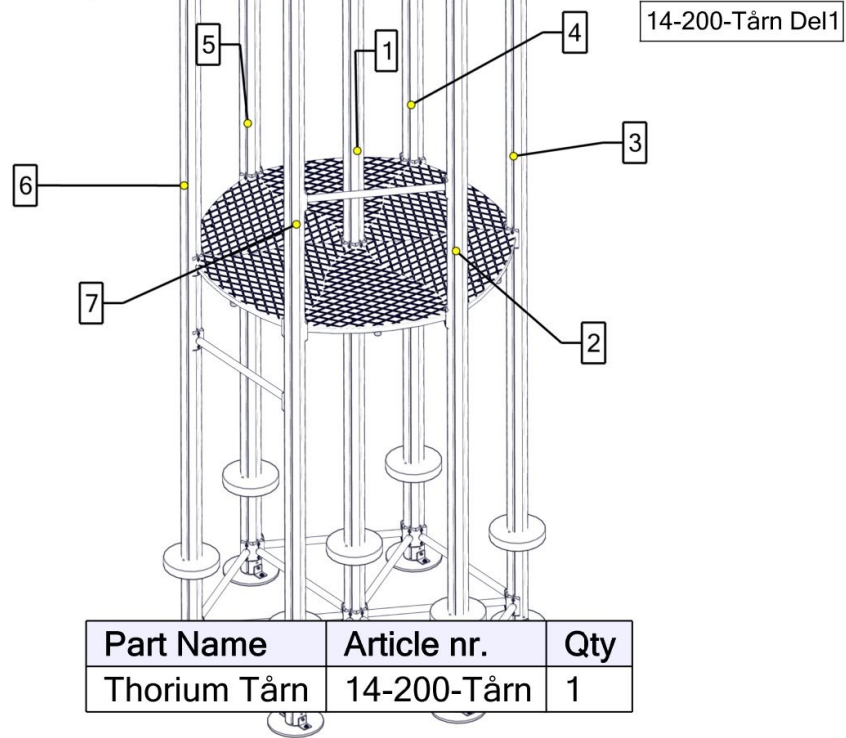

Se separat delmontering for detaljer
 See separate assembly for details
 Se separata delmontering för detaljer

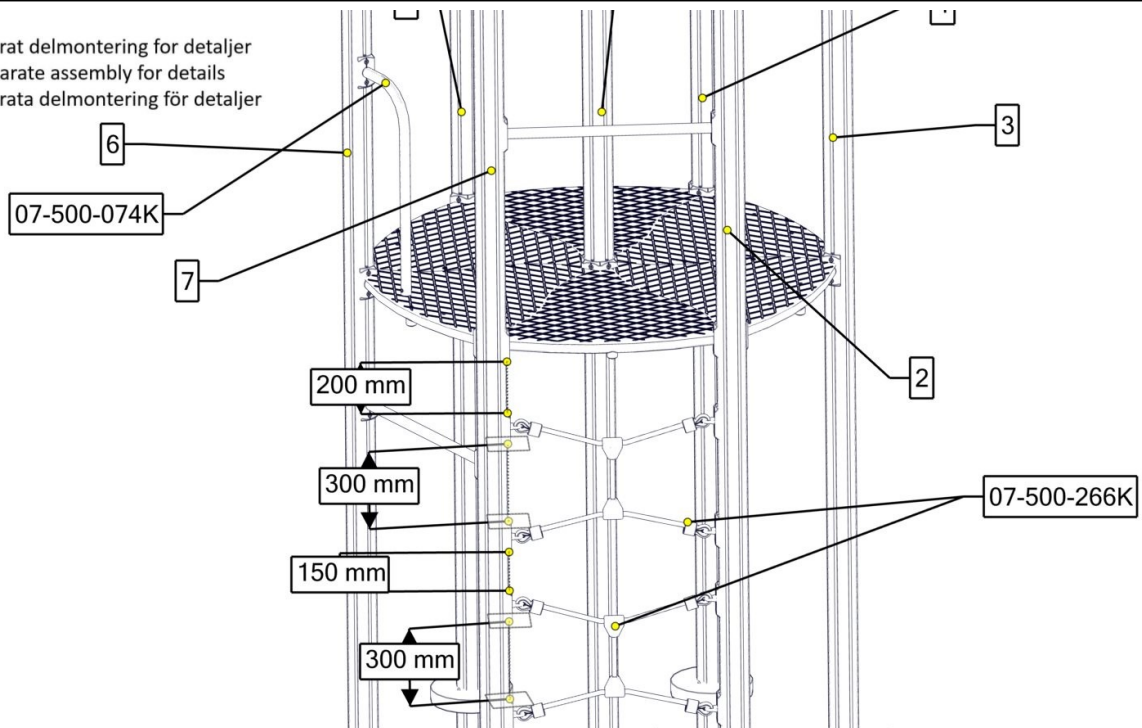

Part Name	Article nr.	Qty
Sluse H=790 komplett	07-500-074K	1
Spideroppgang komplett cc880	07-500-266K	2

Se separat delmontering for detaljer
 See separate assembly for details
 Se separata delmontering för detaljer

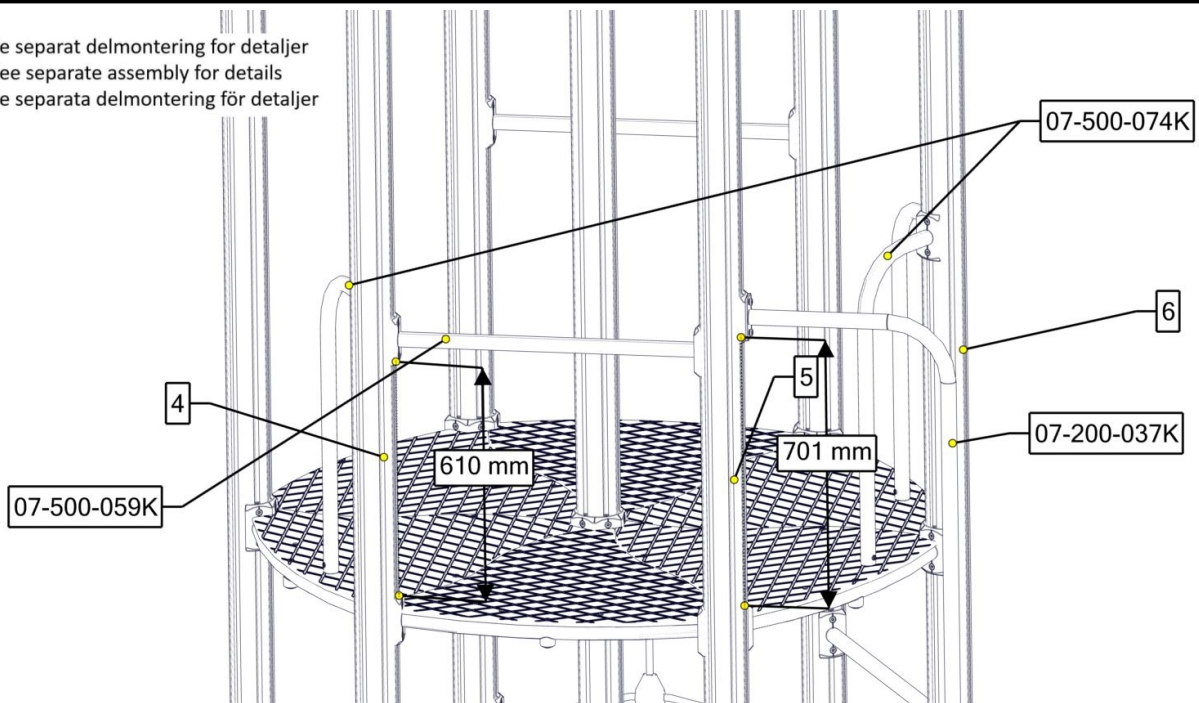

Part Name	Article nr.	Qty
Brannstang gulv 1,9m L=3000 komplett	07-200-037K	1
Sperrerør rett L=750 uten hull	07-500-059K	1
Sluse H=790 komplett	07-500-074K	2

Se separat delmontering for detaljer
 See separate assembly for details
 Se separata delmontering för detaljer

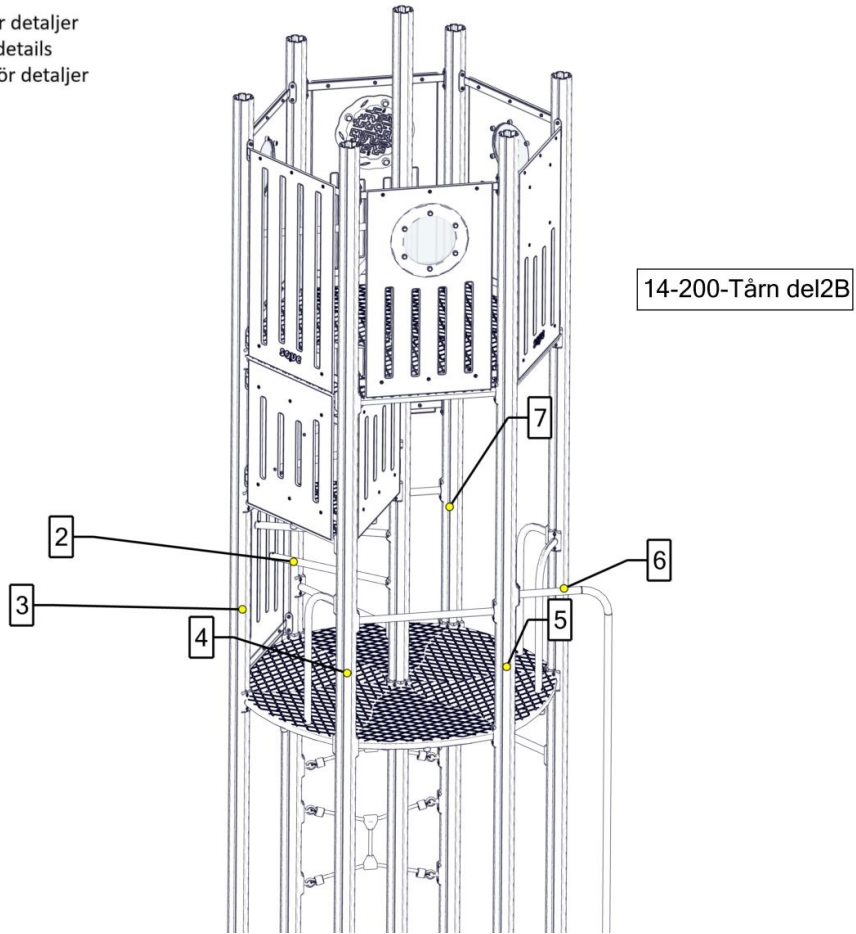

Se separat delmontering for detaljer
 See separate assembly for details
 Se separata delmontering för detaljer

Montert hos Søve
 Assembled at Søve
 Monterad hos Søve

04-060-120

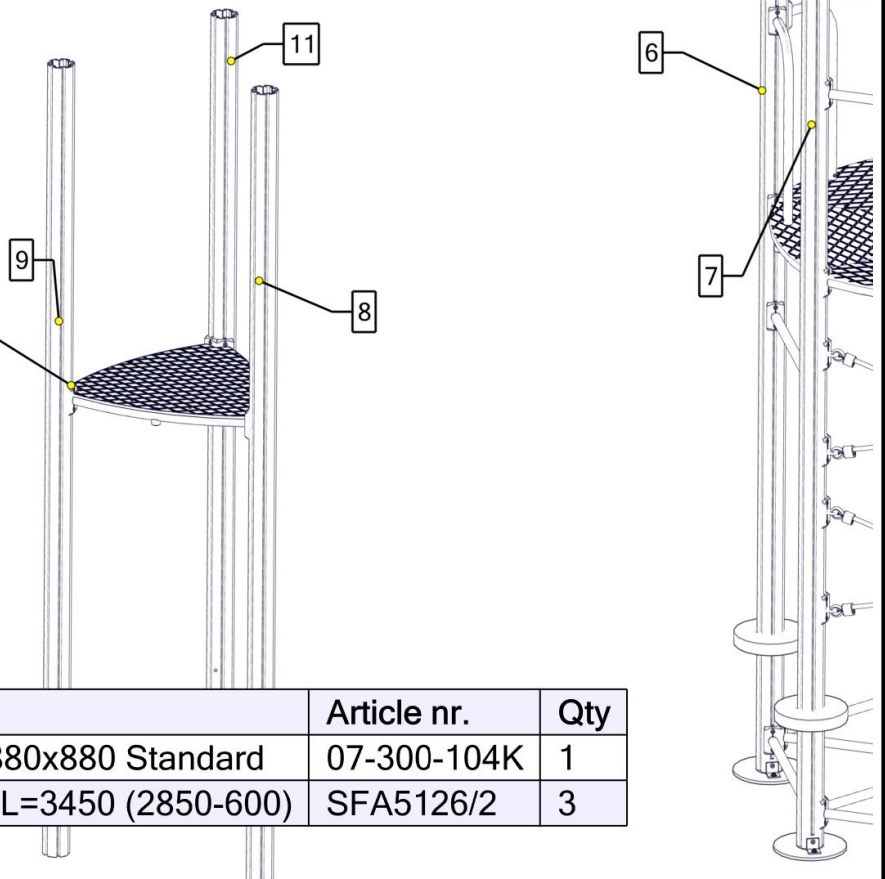

Part Name	Article nr.	Qty
Gulv 3-kant 880x880 Standard	07-300-104K	1
Stolpe Ø110 L=3450 (2850-600)	SFA5126/2	3

Se separat delmontering for detaljer
 See separate assembly for details
 Se separata delmontering för detaljer

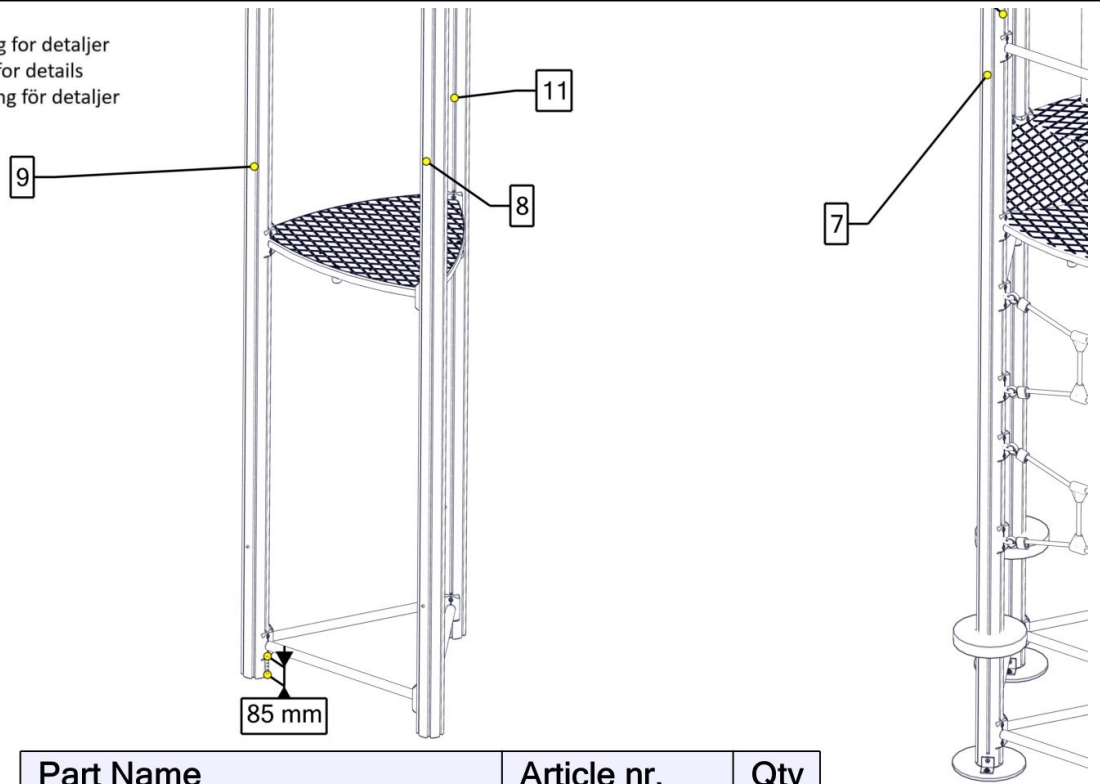

Part Name	Article nr.	Qty
Sperrerør rett L=750 uten hull	07-500-075K	3

Se separat delmontering for detaljer
 See separate assembly for details
 Se separata delmontering för detaljer

04-060-120
 Montert hos Søve
 Assembled at Søve
 Monterad hos Søve

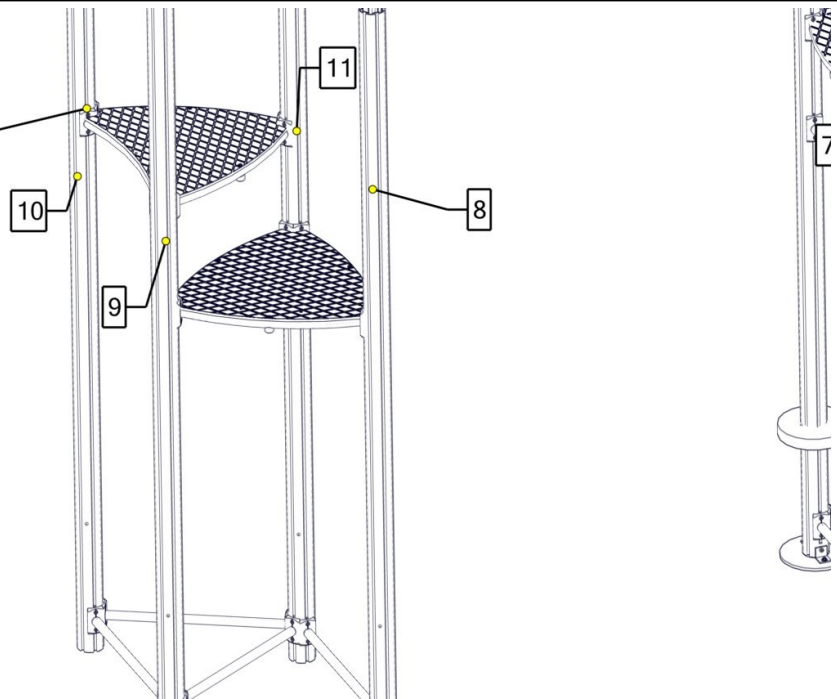

Part Name	Article nr.	Qty
Gulv 3-kant 880x880 1Konkav	07-300-105K	1
Sperrerør rett L=750 uten hull	07-500-075K	2
Stolpe Ø110 L=3450 (2850-600)	SFA5126/2	1

Se separat delmontering for detaljer
 See separate assembly for details
 Se separata delmontering för detaljer

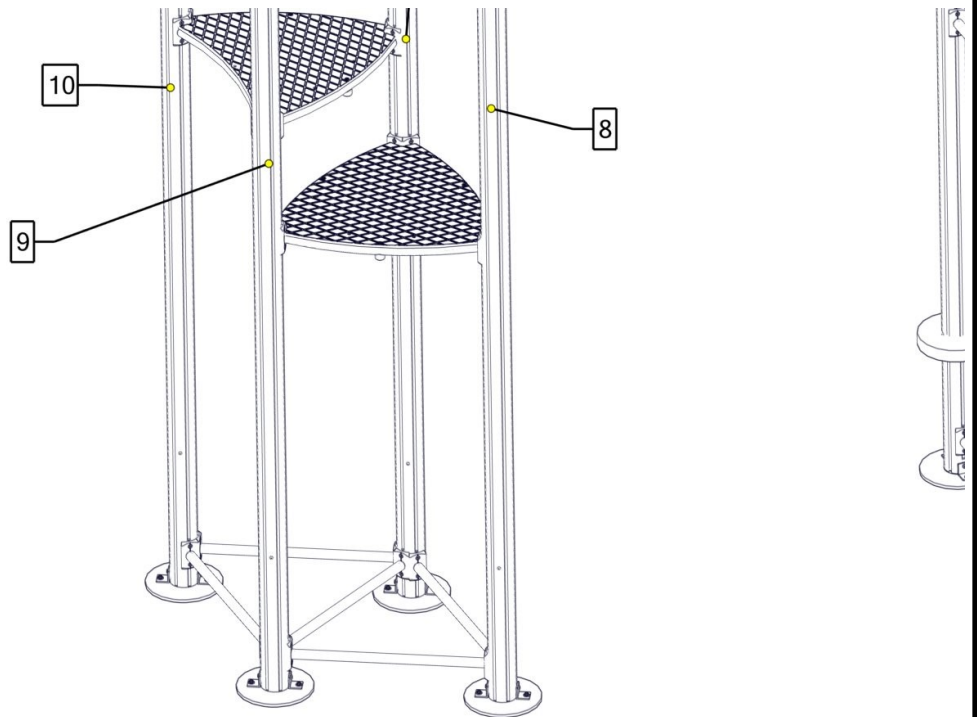

Part Name	Article nr.	Qty
Fundamentplate 1x110 stolpe komplett	07-400-101K	4

Se separat delmontering for detaljer
 See separate assembly for details
 Se separata delmontering för detaljer

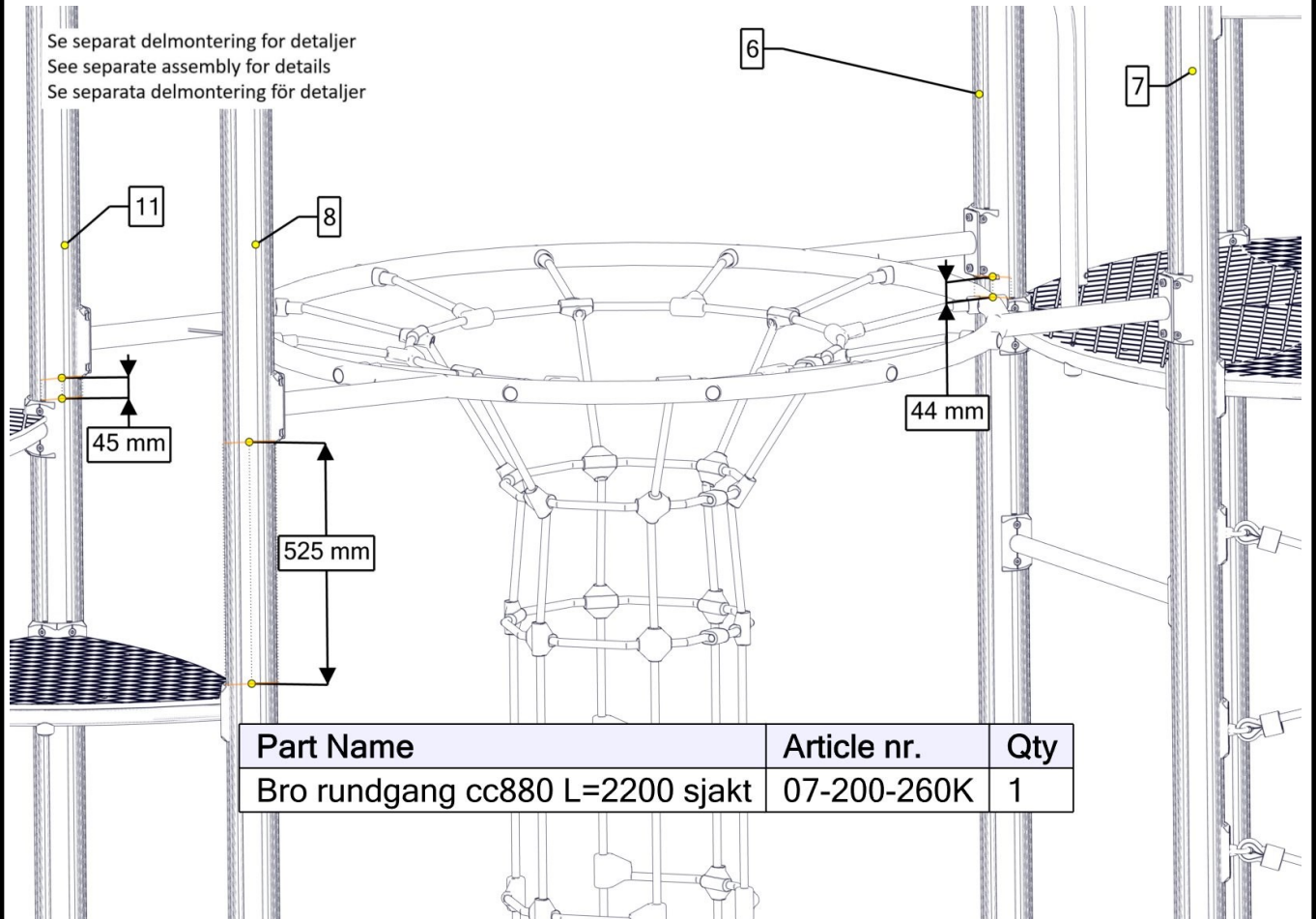

Part Name	Article nr.	Qty
Bro rundgang cc880 L=2200 sjakt	07-200-260K	1

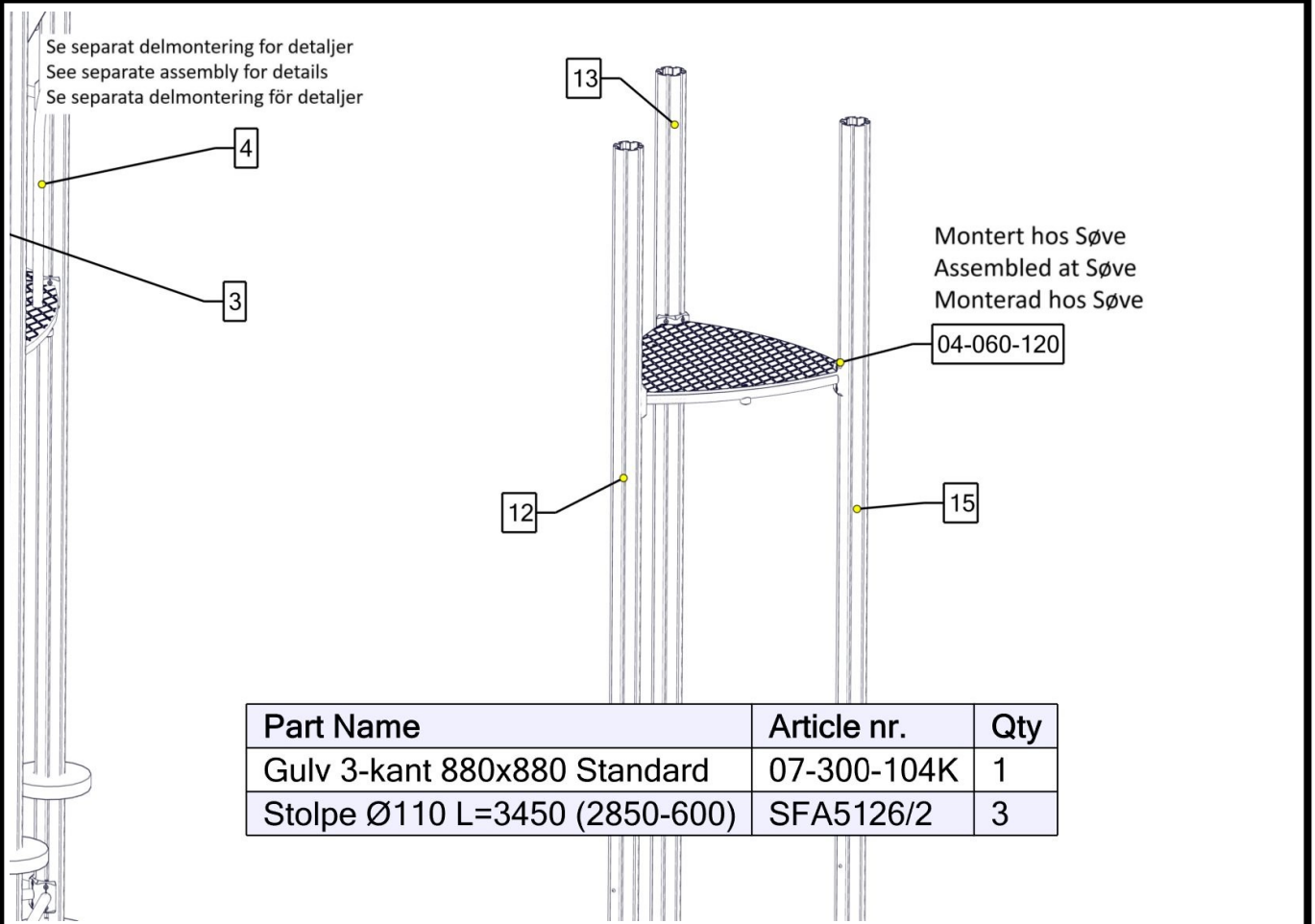
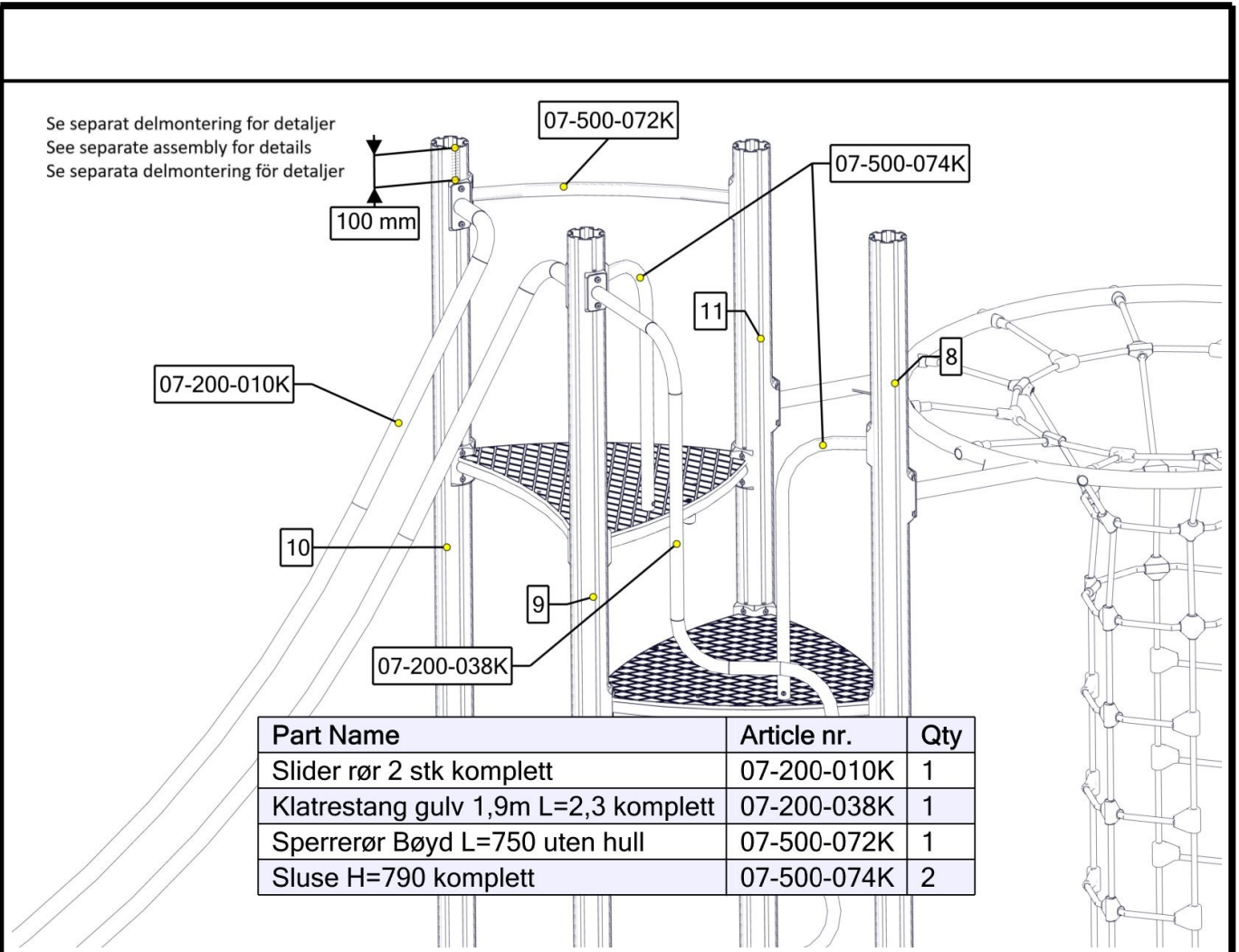

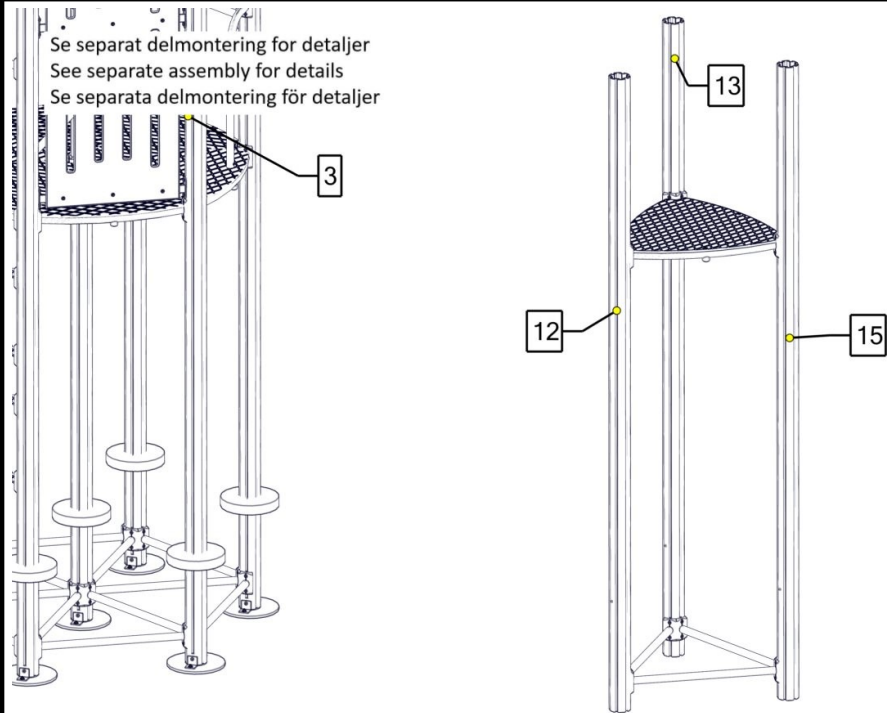

Part Name	Article nr.	Qty
Sperrerør rett L=750 uten hull	07-500-075K	3

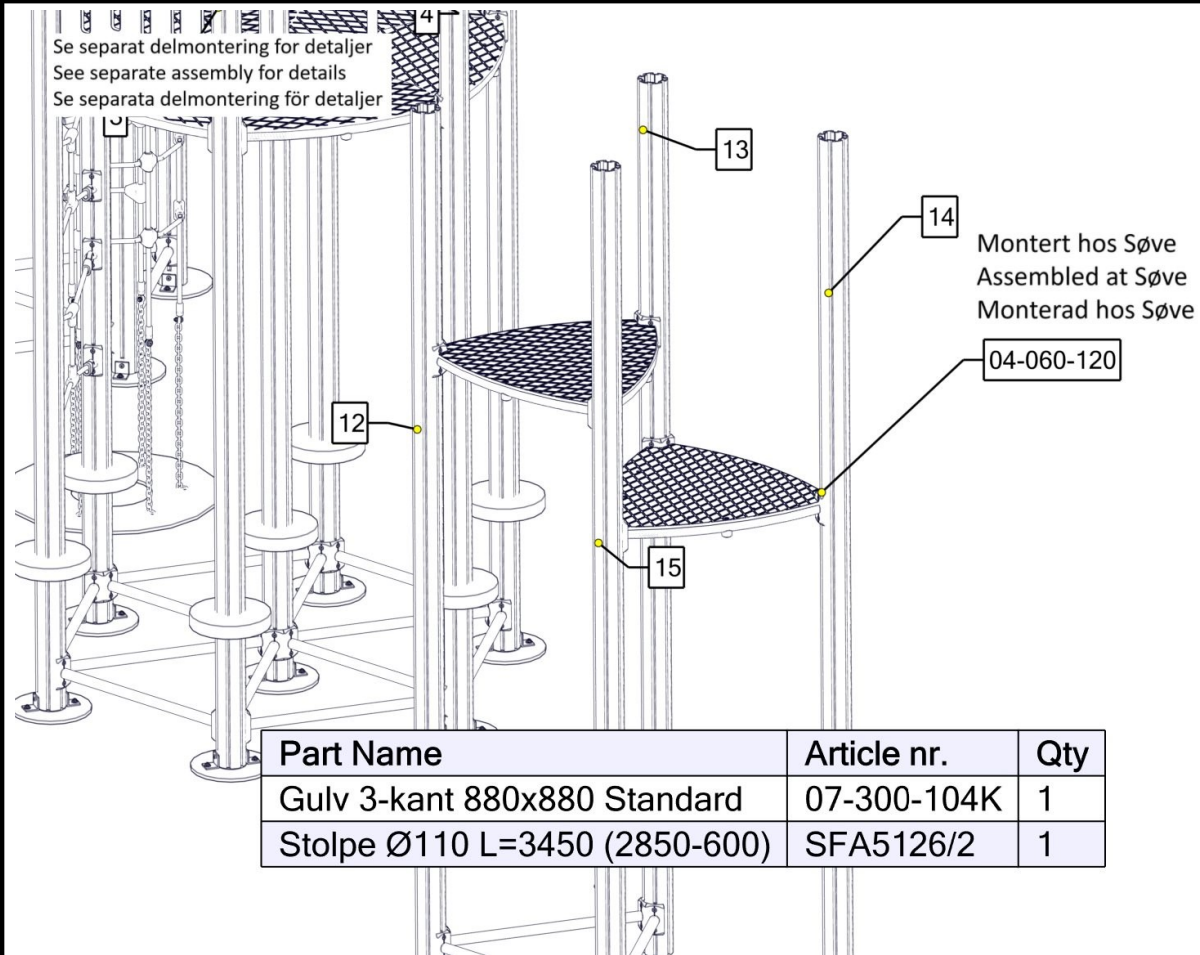

Part Name	Article nr.	Qty
Gulv 3-kant 880x880 Standard	07-300-104K	1
Stolpe Ø110 L=3450 (2850-600)	SFA5126/2	1

Se separat delmontering for detaljer
 See separate assembly for details
 Se separata delmontering för detaljer

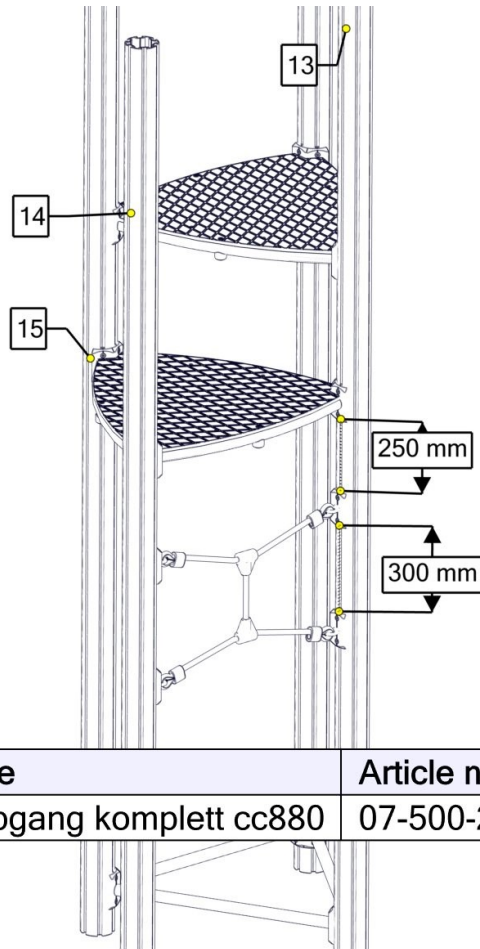

Part Name	Article nr.	Qty
Spideroppgang komplett cc880	07-500-266K	1

Se separat delmontering for detaljer
 See separate assembly for details
 Se separata delmontering för detaljer

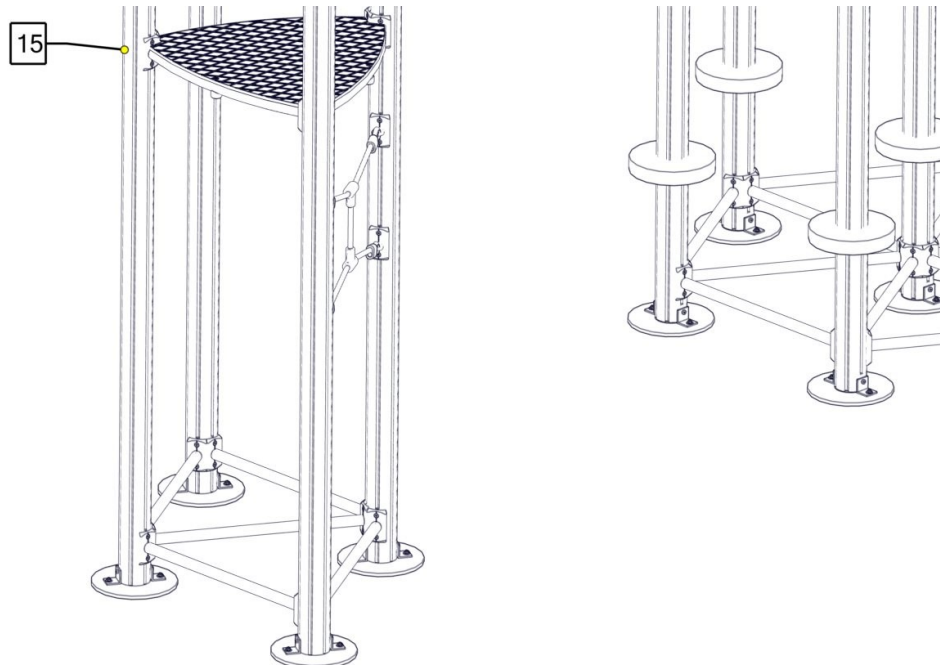

Part Name	Article nr.	Qty
Fundamentplate 1x110 stolpe komplett	07-400-101K	4
Sperrerør rett L=750 uten hull	07-500-075K	2

Se separat delmontering for detaljer
 See separate assembly for details
 Se separata delmontering för detaljer

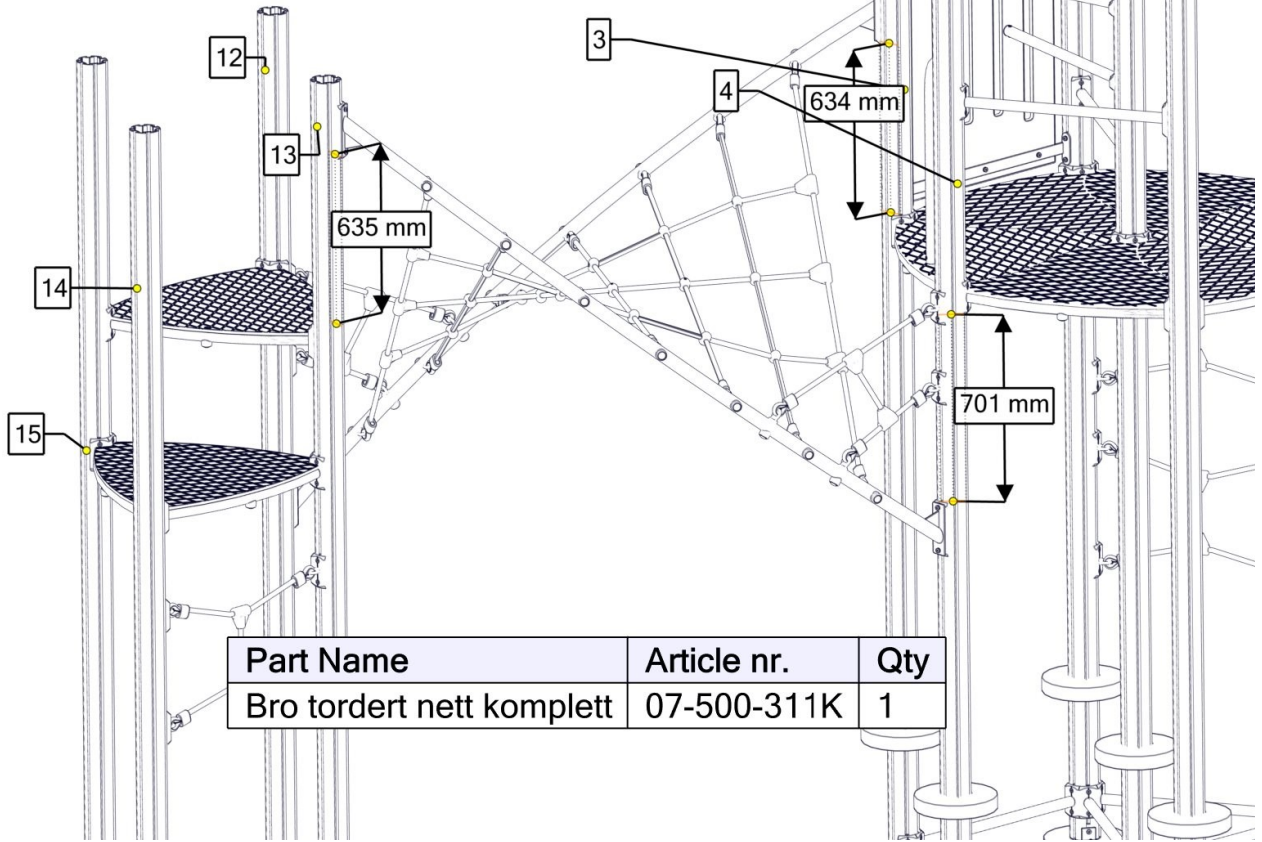

Part Name	Article nr.	Qty
Bro tordert nett komplett	07-500-311K	1

Se separat delmontering for detaljer
 See separate assembly for details
 Se separata delmontering för detaljer

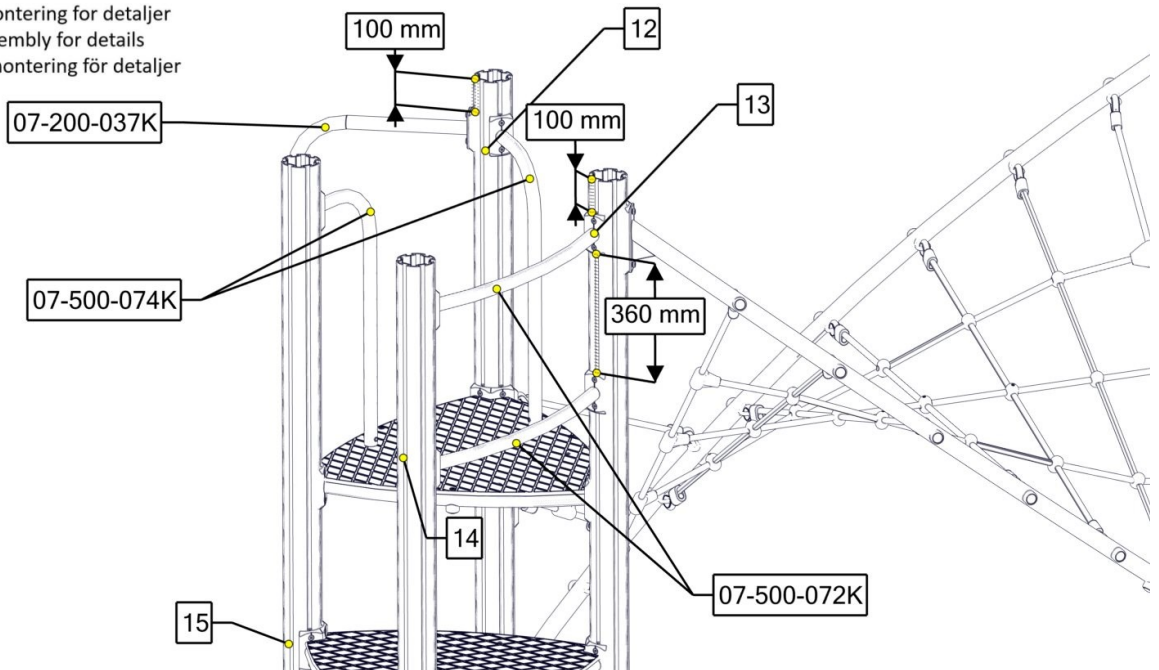

Part Name	Article nr.	Qty
Brannstang gulv 1,9m L=3000 komplett	07-200-037K	1
Sperrerør Bøyd L=750 uten hull	07-500-072K	2
Sluse H=790 komplett	07-500-074K	2

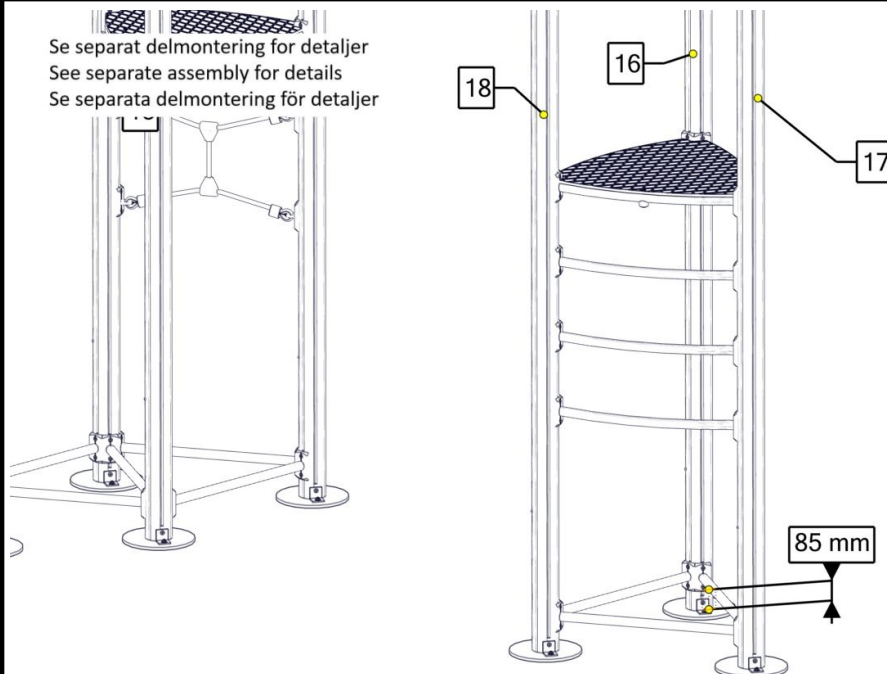
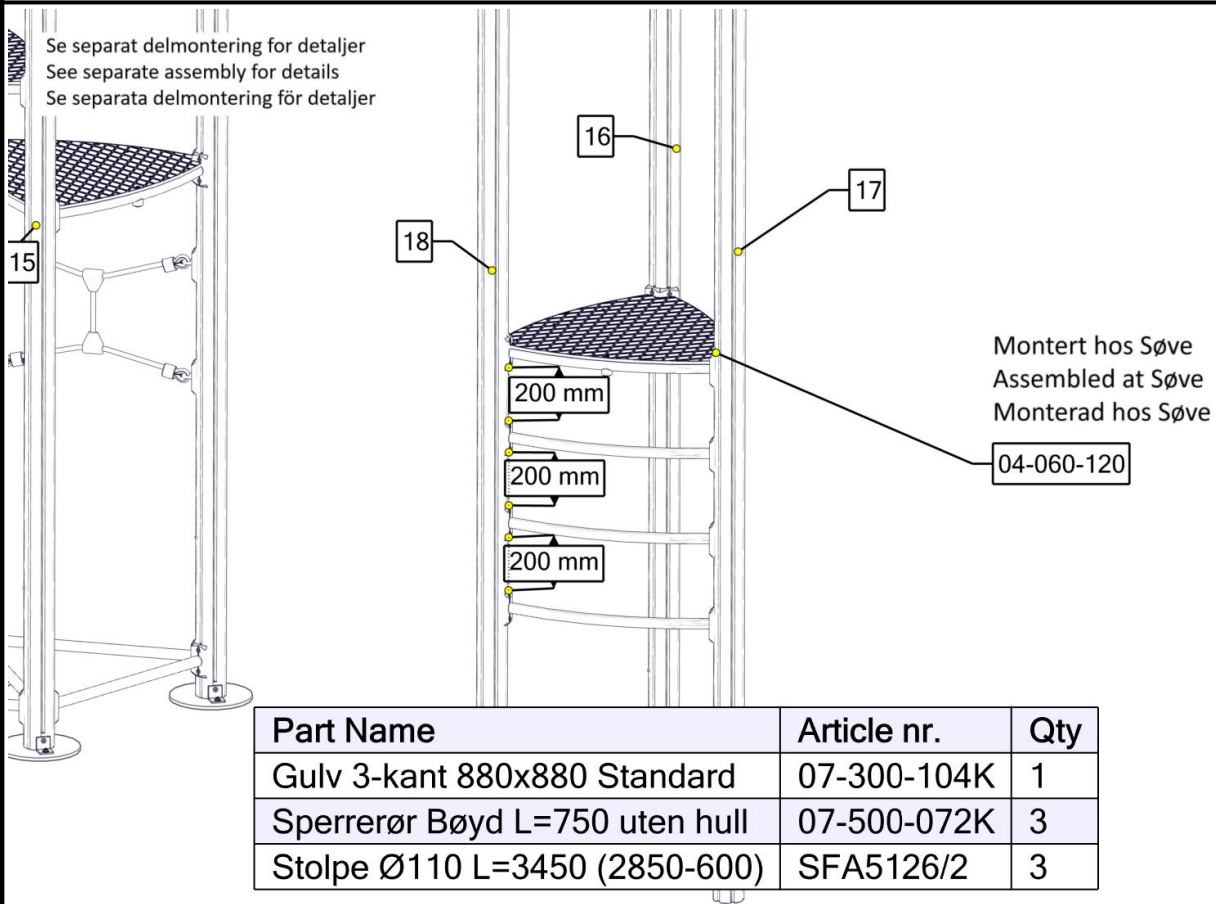

Part Name	Article nr.	Qty
Fundamentplate 1x110 stolpe komplett	07-400-101K	3
Sperrerør rett L=750 uten hull	07-500-075K	3

Se separat delmontering for detaljer
 See separate assembly for details
 Se separata delmontering för detaljer

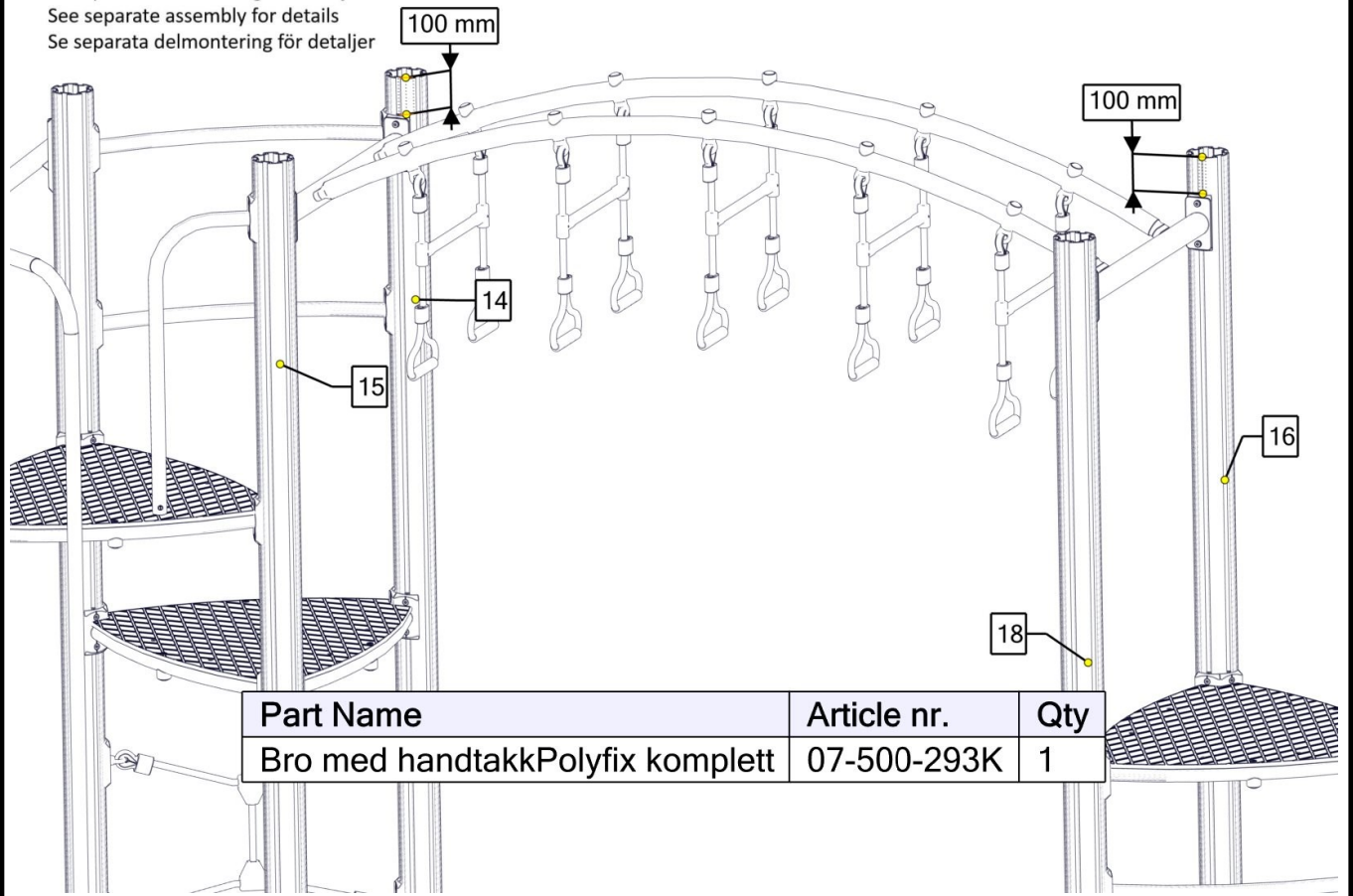

Part Name	Article nr.	Qty
Bro med handtak Polyfix komplett	07-500-293K	1

Se separat delmontering for detaljer
 See separate assembly for details
 Se separata delmontering för detaljer

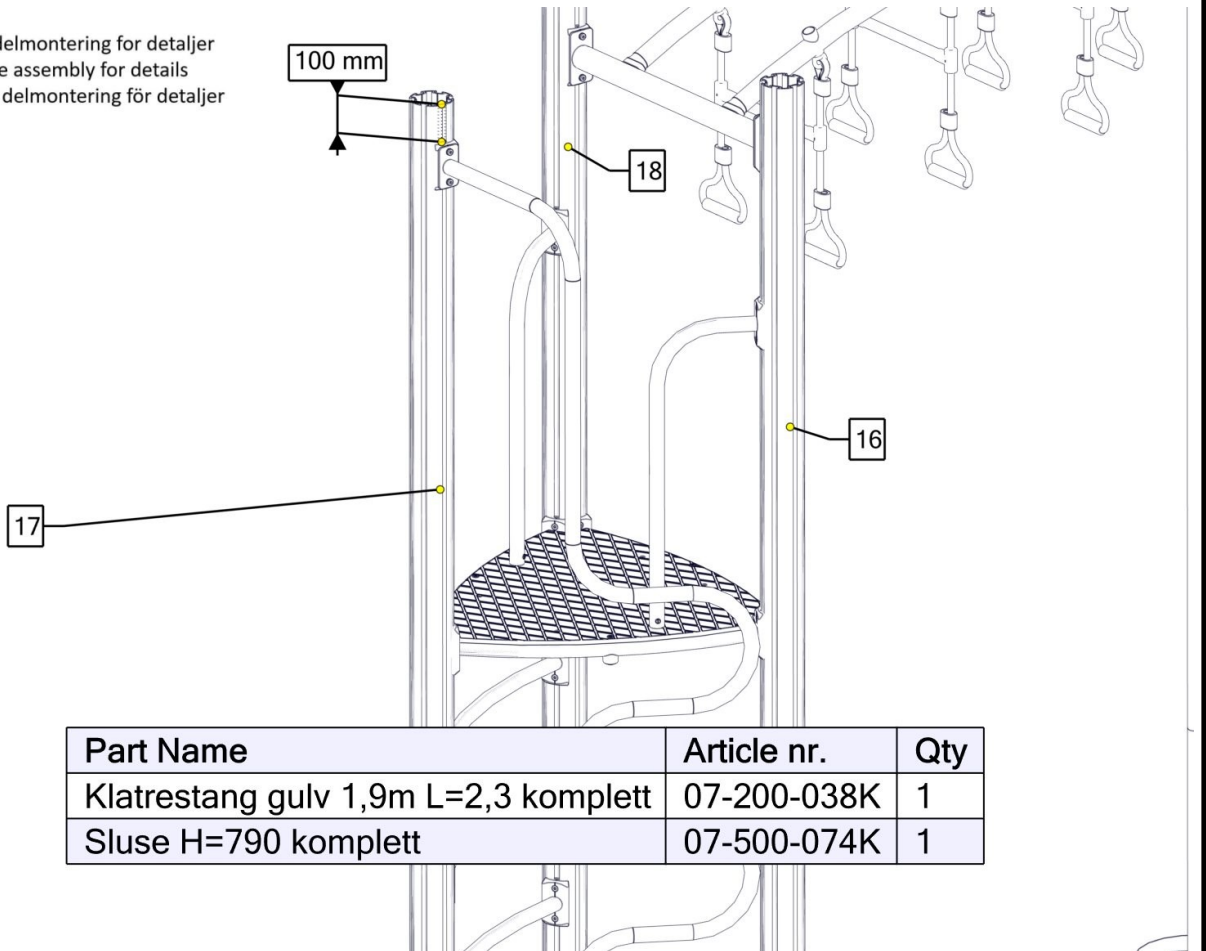

Part Name	Article nr.	Qty
Klatrestang gulv 1,9m L=2,3 komplett	07-200-038K	1
Sluse H=790 komplett	07-500-074K	1

Se separat delmontering for detaljer
 See separate assembly for details
 Se separata delmontering för detaljer

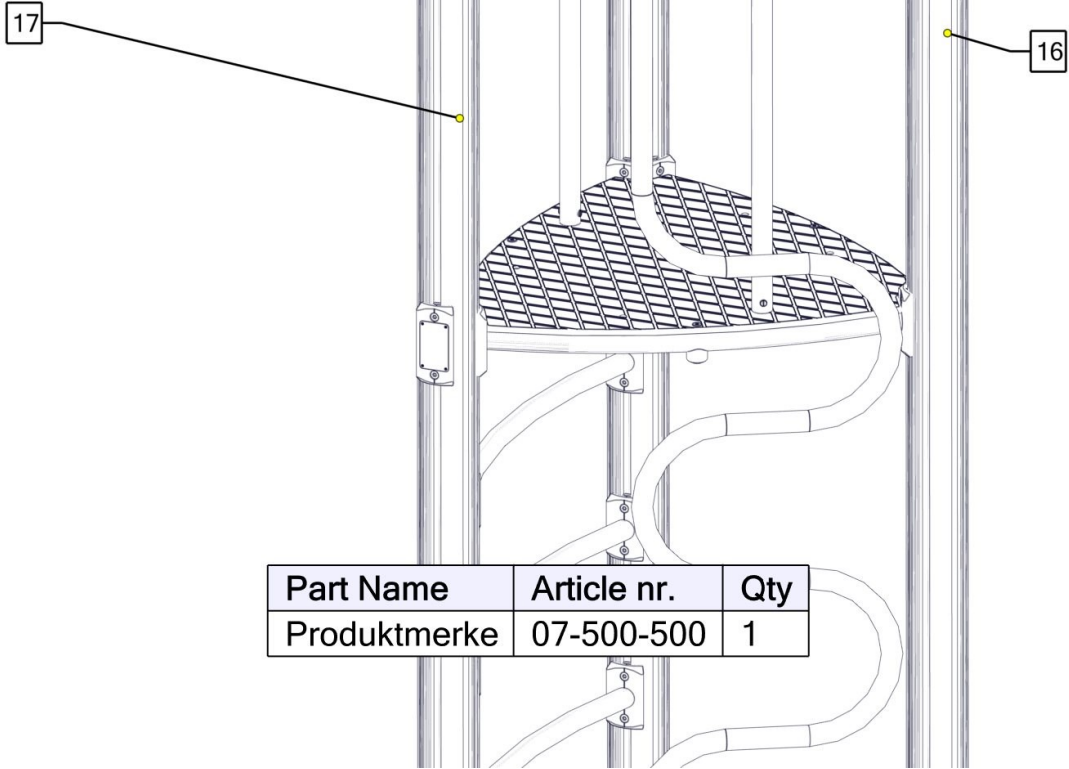



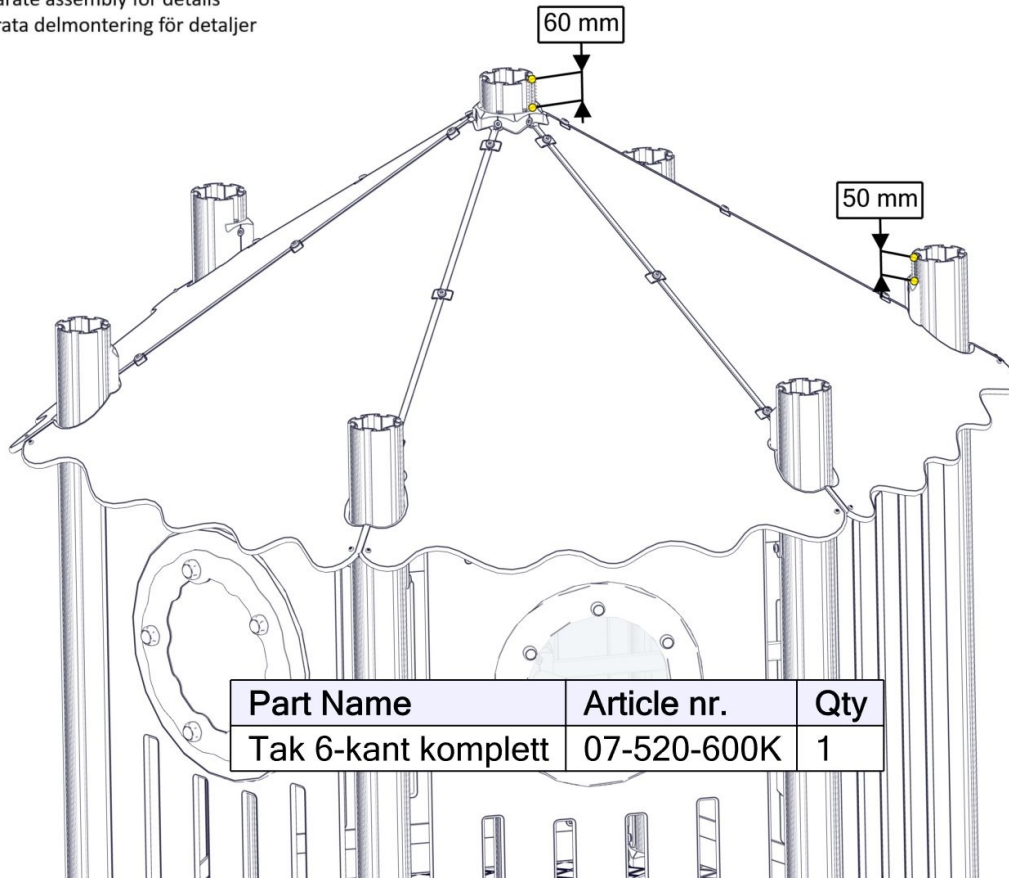

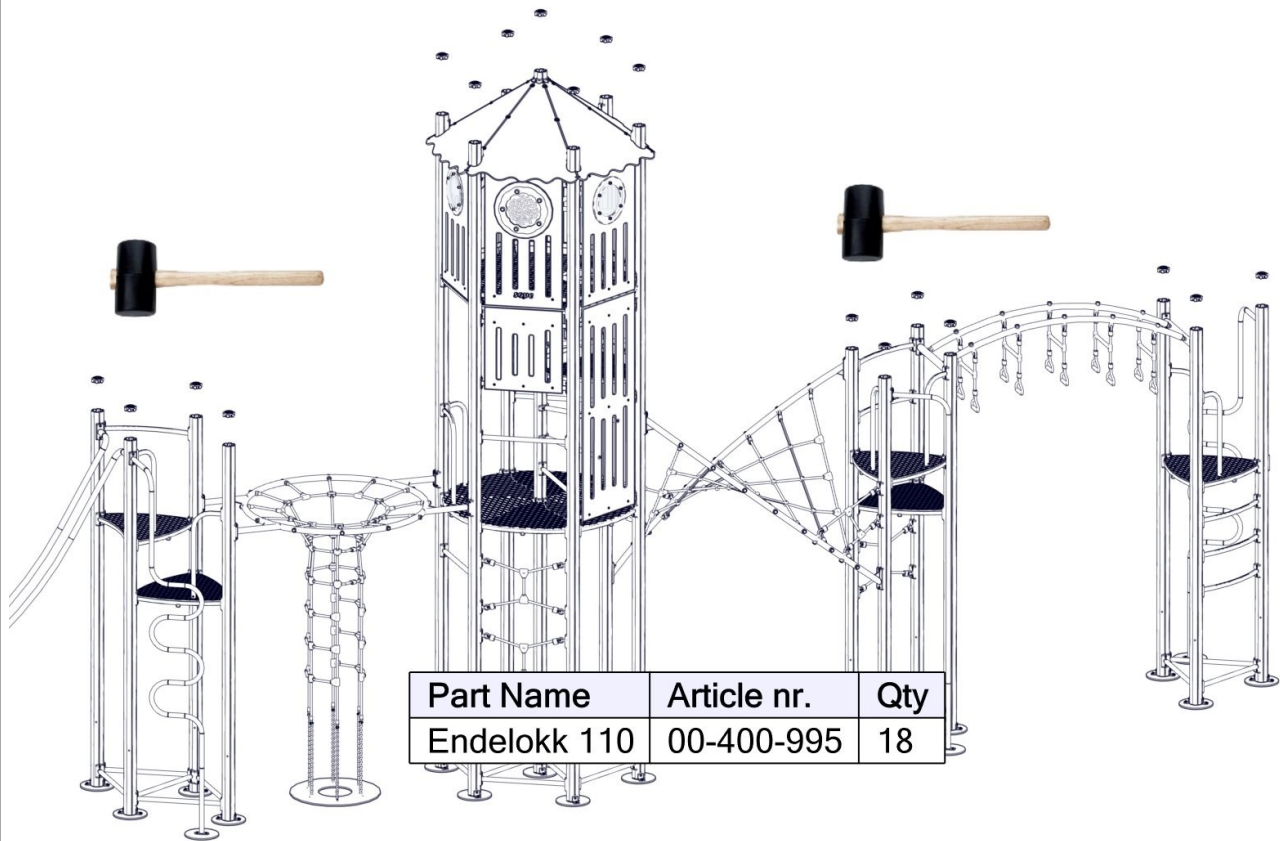
Se separat delmontering for detaljer
 See separate assembly for details
 Se separata delmontering för detaljer



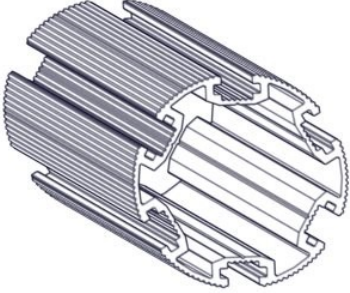



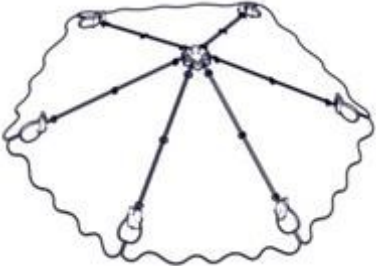
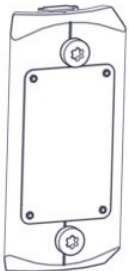



Før utstyret tas i bruk / Before play begins / Innan lekredskapet tas i bruk	
N	<ul style="list-style-type: none"> ● Påse at fallunderlag er utlagt i henhold til gjeldende regler eller vår anbefaling ● Fjern alle monteringshjelpemidler (rester av betong, planker, paller, plast, og lignende) ● Før utstyret tas i bruk, burde man sjekke at det ikke er fare for at anorakksnorer og lignende som kan hekte seg fast noen steder på lekeapparatet. (Vedlagte snor med dobbe (kneledd) kan brukes til å sjekke at dette er i orden. Se vedlagte veiledning for bruk av denne. Dette gjøres for å oppdage eventuelle feilmonteringer.? ● NB! Bør stå i 2-3 dager før bruk
EN	<ul style="list-style-type: none"> ● Make sure the area and depth of safer surfacing are according to the current standard, or to the manufacturer's recommendation ● Make sure all tools and surplus materials are removed before play begins ● PS! When complete, allow 2-3 days for the concrete to set before use
S	<ul style="list-style-type: none"> ● Kontrollera att fallunderlag är utlagt enligt gällande regler eller vårt rekommendation ● Ta bort alla monteringshjälpmedel (rester av betong, plankor, pallar, plast och liknande) ● Innan lekredskapet används, kontrollera att anoracksnoddar eller kläder/delar av kläder eller liknande inte kan fastna i några delar på redskapet. (Den bipackade "knävringen" kan man med fördel användas för denna kontroll. ● Detta görs för att upptäcka eventuella felmonteringar.)

Boltepakker for / Boltpackage for / Bultpaket för		Sign. _____.		
Thorium 14-200-120	Navn	Artnr/dimensjon	Ant	Lev
	StolpeØ110 L=3450 Grå 600-2850	SFA5126/2	11	
	Endelokk til stolpe Ø110	00-400-995	18	
	Thorium Tårn-del 1	07-302-200 (se egen del- montering)	1	
	Thorium Tårn del 2_b	07-302-220 (se egen del- montering)	1	
	Sperrerør rett L=750 Uten hull Grønn	07-500-059K (se egen del- montering)	1	
	Tak 6-kant Grå	07-520-600K (se egen del- montering)	1	
	Produktmerke	07-500-500 (se egen del- montering)	1	

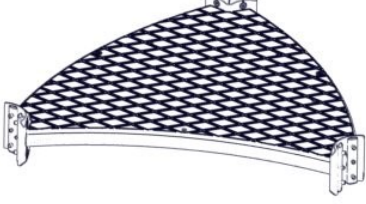

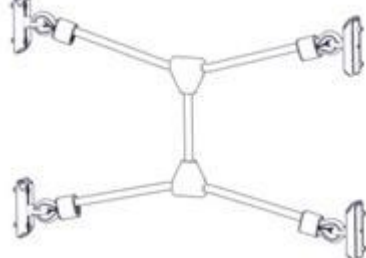
Boltepakker for / Boltpackage for / Bultpaket för



Sign. _____

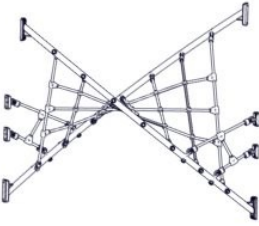
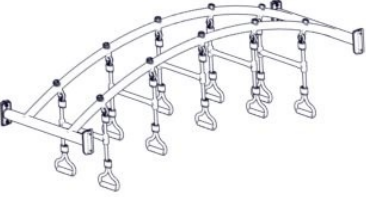

Thorium 14-200-120	Navn	Artnr/dimensjon	Ant	Lev
	Sluse H=790 Grønn	07-500-074K (se egen del- montering)	8	
	Gulv 3-kant standard CC880 Grå	07-300-104K (se egen del- montering)	4	
	Gulv 3-kant 1 Konkav CC880 Grå	07-300-105K (se egen del- montering)	1	
	Brannstang Gulv = 1,95m Grå	07-200-037K (se egen del- montering)	2	
	Spideroppgang CC880 Grønn	07-500-266K (se egen del- montering)	3	
	Bro rundgang med sjakt CC880 L=2200	07-200-260K (se egen del- montering)	1	

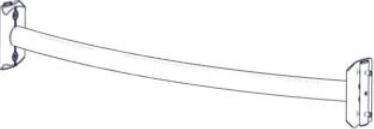
Boltepakker for / Boltpackage for / Bultpaket för

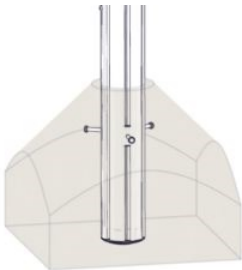
Sign. _____.

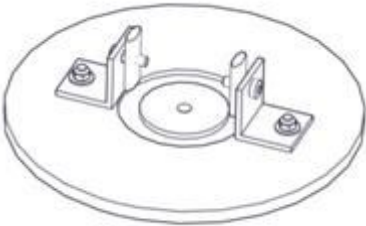
Thorium 14-200-120	Navn	Artnr/dimensjon	Ant	Lev
	Bro tordert nett Grønn	07-500-311K (se egen del- montering)	1	
	Bro med handtak polyfix CC880 Grønn	07-500-293K (se egen del- montering)	1	
	Slider rør	07-200-010K (se egen del- montering)	1	
	Klatrestang Gulv 1,9m L=2,3	07-200-038K (se egen del- montering)	2	
	Sperrerør bøyd L=750 uten hull Grønn	07-500-072K (se egen del- montering)	6	

Boltepakker for / Boltpackage for / Bultpaket för		Sign. _____		
Thorium 14-200-120	Navn	Artnr/dimensjon	Ant	Lev
	Fundament støp			
	Sperrerør L=750 Sort	07-500-075K (se egen del- montering)	13	
	Fundament betong	00-003-111K (se egen del- montering)	11	
	Fundament Nedgraving			
	Sperrerør L=750 Sort	07-500-075K (se egen del- montering)	13	
	Fundament 1x110	07-400-101K (se egen del- montering)	11	

Boltepakker for / Boltpackage for / Bultpaket för		Sign. _____.		
Thorium 14-200-120	Navn	Artnr/ dimensjon	Ant	Lev
	Overflatemon- tering			
	Fundament 2xØ110 stolpe for betongdekke	00-003-114K (Se egen del- monering)	4	
	Fundament 3xØ110 stolpe for betongdekke	00-003-115K (Se egen del- monering)	1	
	Stolpe Ø110 må kappes Slider må kappes Brannstang må kappes S-trapp må kappes	SFA5126/2 07-200-010 07-200-037 07-200-038		