

N

Monteringsanvisning

EN

Assembly Instructions

S

Monteringsanvisning

Produkt nr. / Product no. / Produkt nr.

14-200-Tårn**Del 1**

Ord. nr. _____

Dato. _____

Sign. _____



Mount tower on his side.
 Befor mounting the roof., place all
 the nessesary sliding nuts.

**søve**





Søve AS
 Grønnvoldveien 290
 3830 Ulefoss - Norway
 Tlf: +47 35 94 65 65
 www.sove.no

**søve**

Søve AB
 EA Rosengrensgatan 32
 421 31 Västra Frölunda
 Phone: +46 (0)31 773 97 00
 www.sove.se

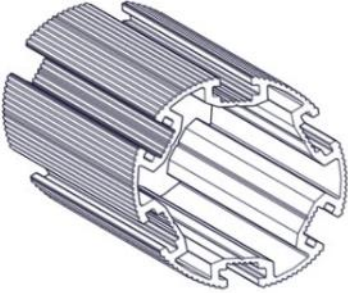

Boltepakker for / Boltpackage for / Bultpaket för

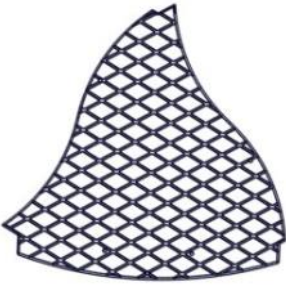

Sign. _____

Thorium Tårn-dell 14-200-Tårn1	Navn	Artnr/dimensjon	Ant	Lev
	Stolpe Ø110 L=6450 Grå	SFA5126/2	1	
	Stolpe Ø110 L=6000 Grå	SFA5126/2	6	
	Sperrerør 6-kant gulv Rett L=750 2 hull Sort	07-500-064K (se egen delmontering)	6	
	Sperrerør 6-kant gulv Bøyd L=750 1 hull Sort	07-500-060K (se egen delmontering)	6	
	Sperrerør Rett L=750 Uten hull Grønn	07-500-059K (se egen delmontering)	2	
	Gulv 6-kant Standard Grå	07-301-120	6	

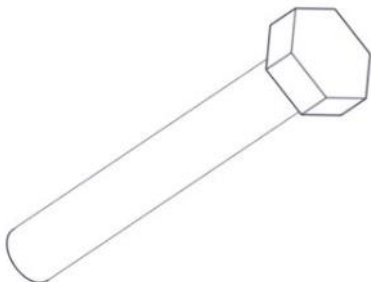
Boltepakker for / Boltpackage for / Bultpaket för

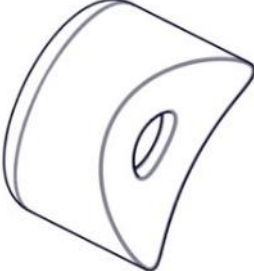
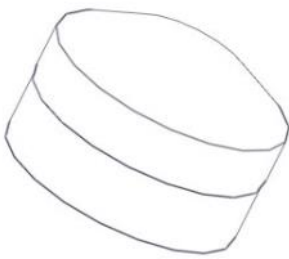
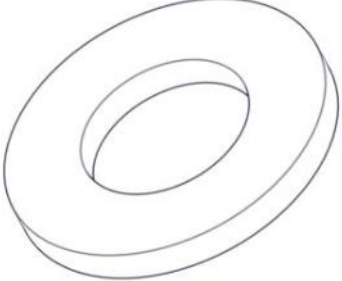

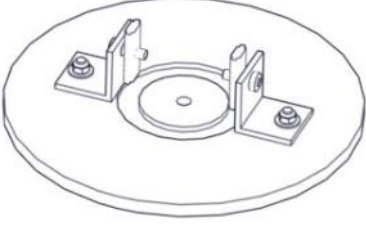
Sign. _____

Thorium Tårn-dell 14-200-Tårn1	Navn	Artnr/dimensjon	Ant	Lev
	Sekskant skrue M8x50	04-008-050	18	
	Møbelknapp M8x11	04-030-011	18	
	Plast rørfeste	05-301-036	18	
	Plast rørfeste endelokk	05-301-036	18	
	Skive M8 stor	04-055-008	18	

Boltepakker for / Boltpackage for / Bultpaket för		Sign. _____		
Thorium Tårn-dell 14-200-Tårn1	Navn	Artnr/dimensjon	Ant	Lev
	Fundament Støpefrie			
	Sperrerør Rett L=750 Uten hull Sort	07-500-075K (se egen delmontering)	12	
	Fundament plate 1xØ110 stolpe	07-400-101K (se egen delmontering)	7	
	Fundament Støp			
	Sperrerør Rett L=750 Uten hull Sort	07-500-075K (se egen delmontering)	12	
	Fundament støp	00-003-111K (se egen delmontering)	7	

Boltepakker for / Boltpackage for / Bultpaket för

Sign. _____

Thorium Tårn-dell 14-200-Tårn1	Navn	Artnr/dimensjon	Ant	Lev
	Fundament Overflatemon- tering			
	Fundament 1x 110 stolpe for betongdekk	00-003-113K (se egen delmontering)	1	
	Fundament 2x110 stolpe for betongdekke	00-003-114K (se egen delmontering)	3	

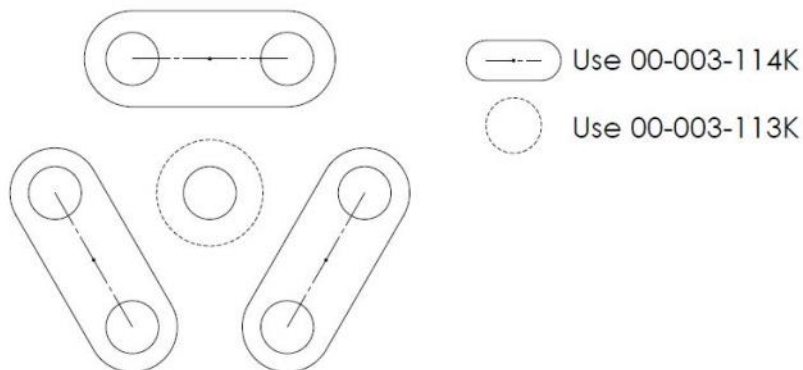

Montering av lekeapparatet / Assembly instructions / Montering av lekredskapet

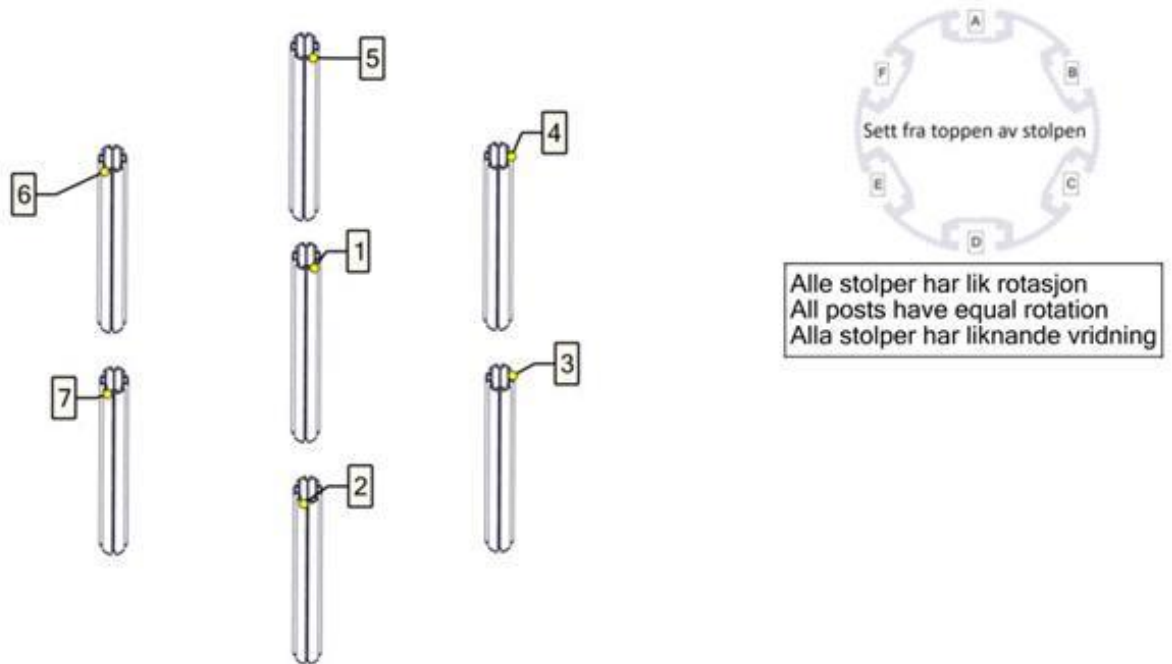

Part Name	Article nr.	Qty
Stolpe Ø110 Lengde=6450	SFA5126/2	1
Stolpe Ø110 Lengde=6000	SFA5126/2	6

Se separat delmontering for detaljer
See separate assembly for details
Se separata delmontering för detaljer

Brikke 120 3xM8
Montert hos Søve
Assembled at Søve
Monterad hos Søve

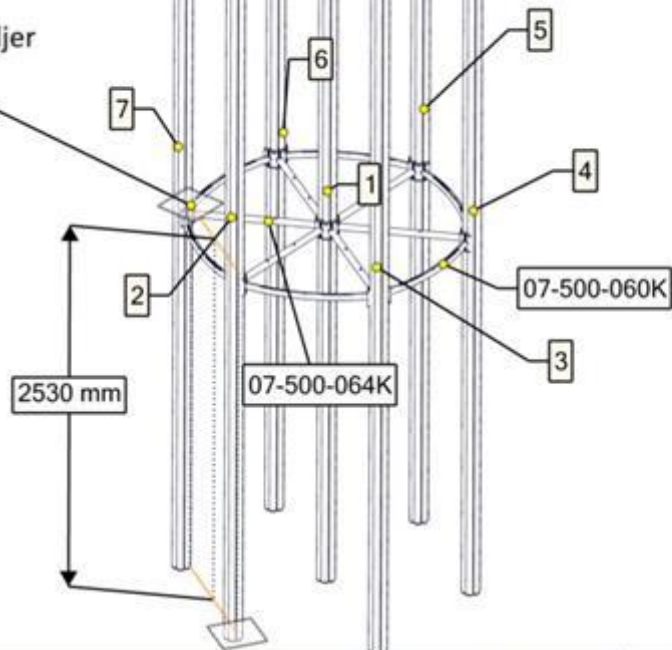

Part Name	Article nr.	Qty
Sperrerør Bøyd L=750 m hull gulv komplet	07-500-060K	6
Sperrerør 6-kant gulv L=750 2 hull	07-500-064K	6

Montering av lekeapparatet / Assembly instructions / Montering av lekredskapet

Se separat delmontering for detaljer
 See separate assembly for details
 Se separata delmontering för detaljer

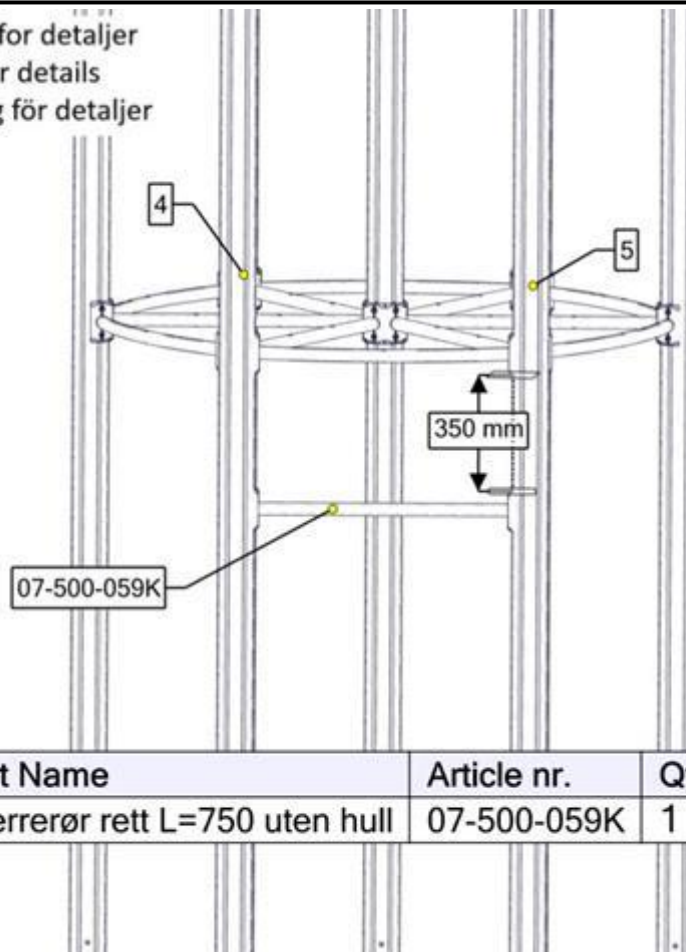

Se separat delmontering for detaljer
 See separate assembly for details
 Se separata delmontering för detaljer

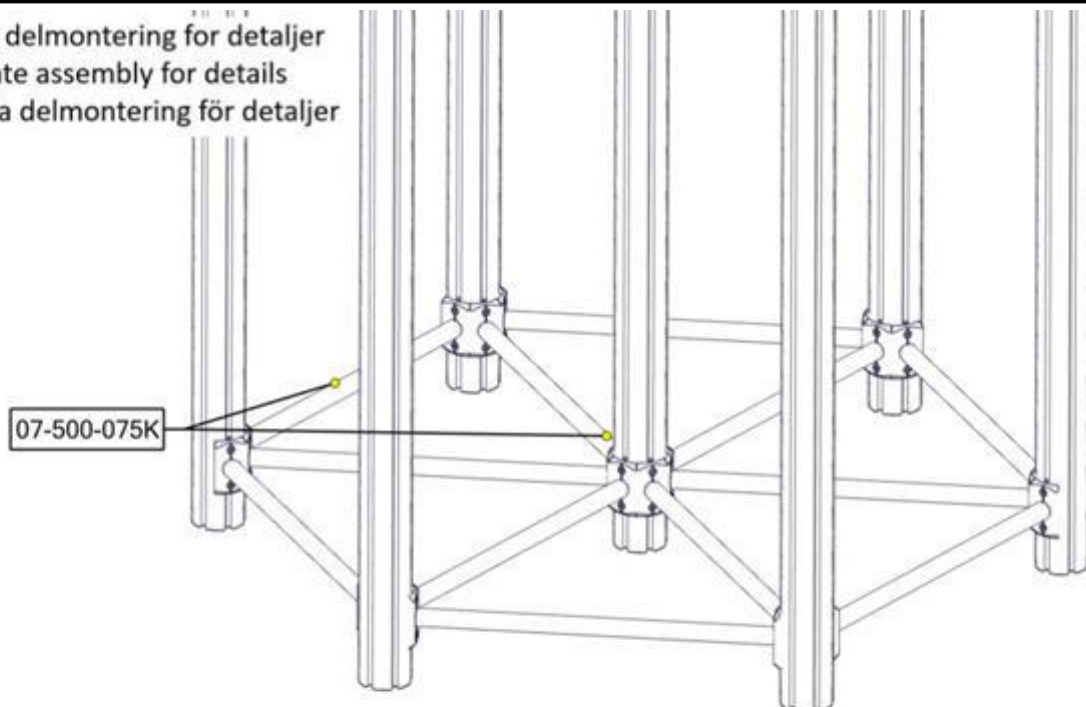

Part Name	Article nr.	Qty
Sperrerør rett L=750 uten hull	07-500-075K	12

Se separat delmontering for detaljer
 See separate assembly for details
 Se separata delmontering för detaljer

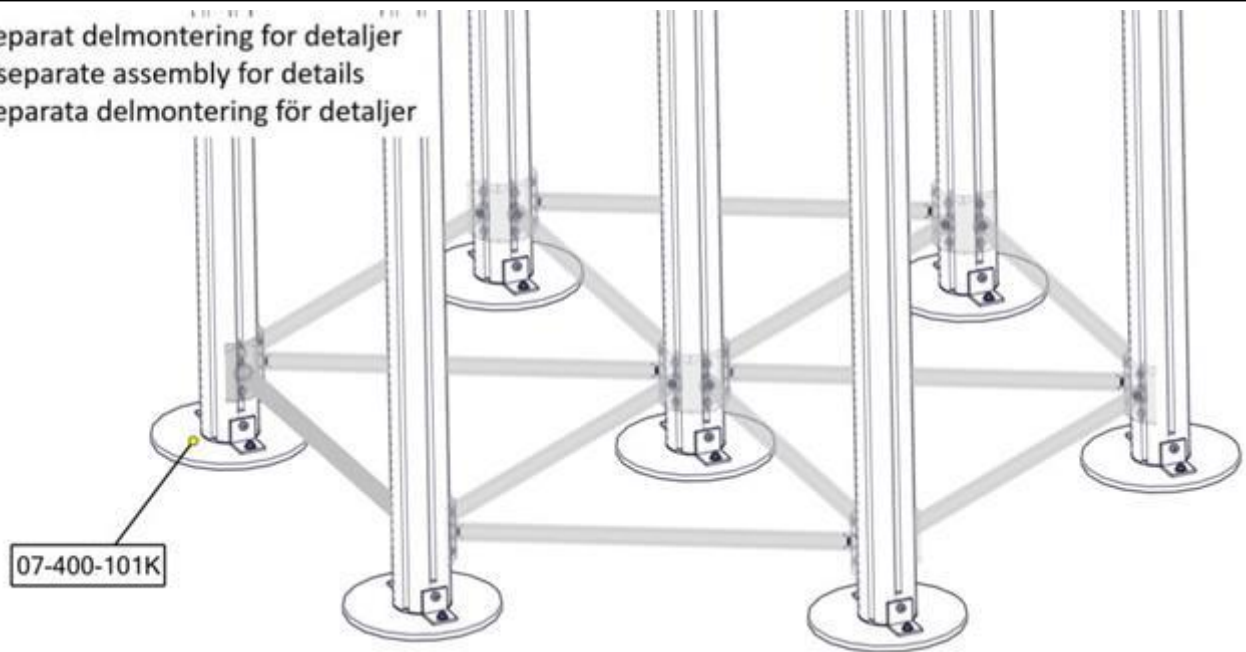

Part Name	Article nr.	Qty
Fundamentplate 1x110 stolpe komplett	07-400-101K	7

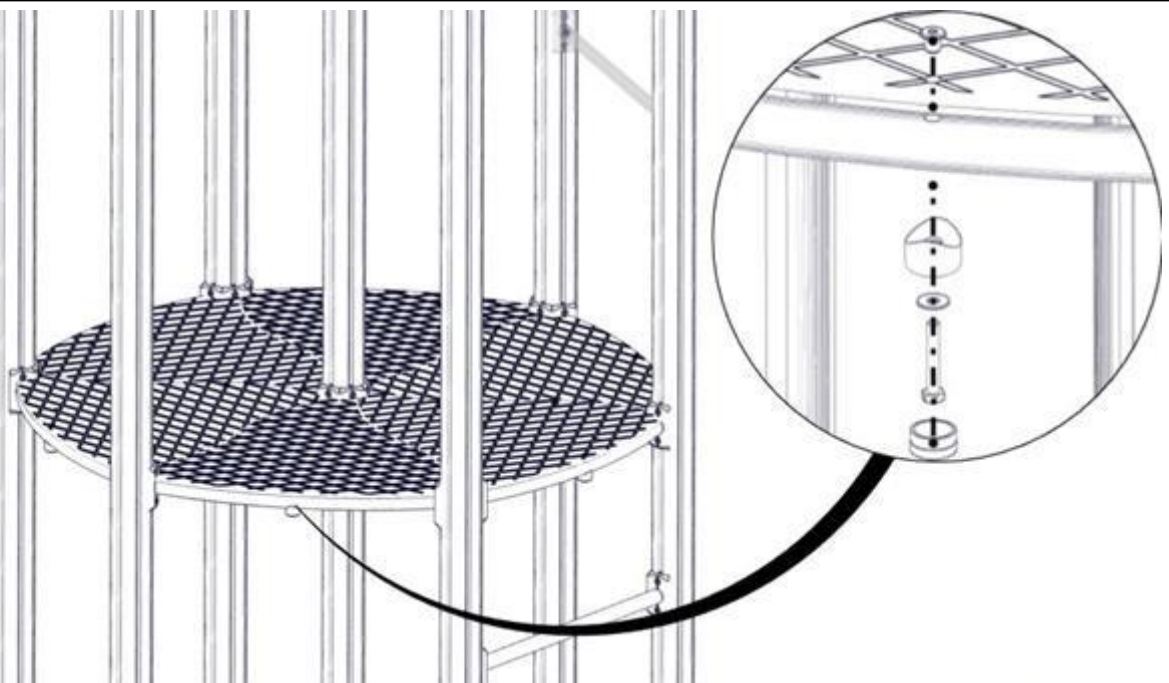

Part Name	Article nr.	Qty
Gulv 6Kant STD	07-301-120	6
Sekskant M8x50	04-008-050	18
Møbelknapp M8x11	04-030-011	18
Plast rørfeste, kropp	05-301-036	18



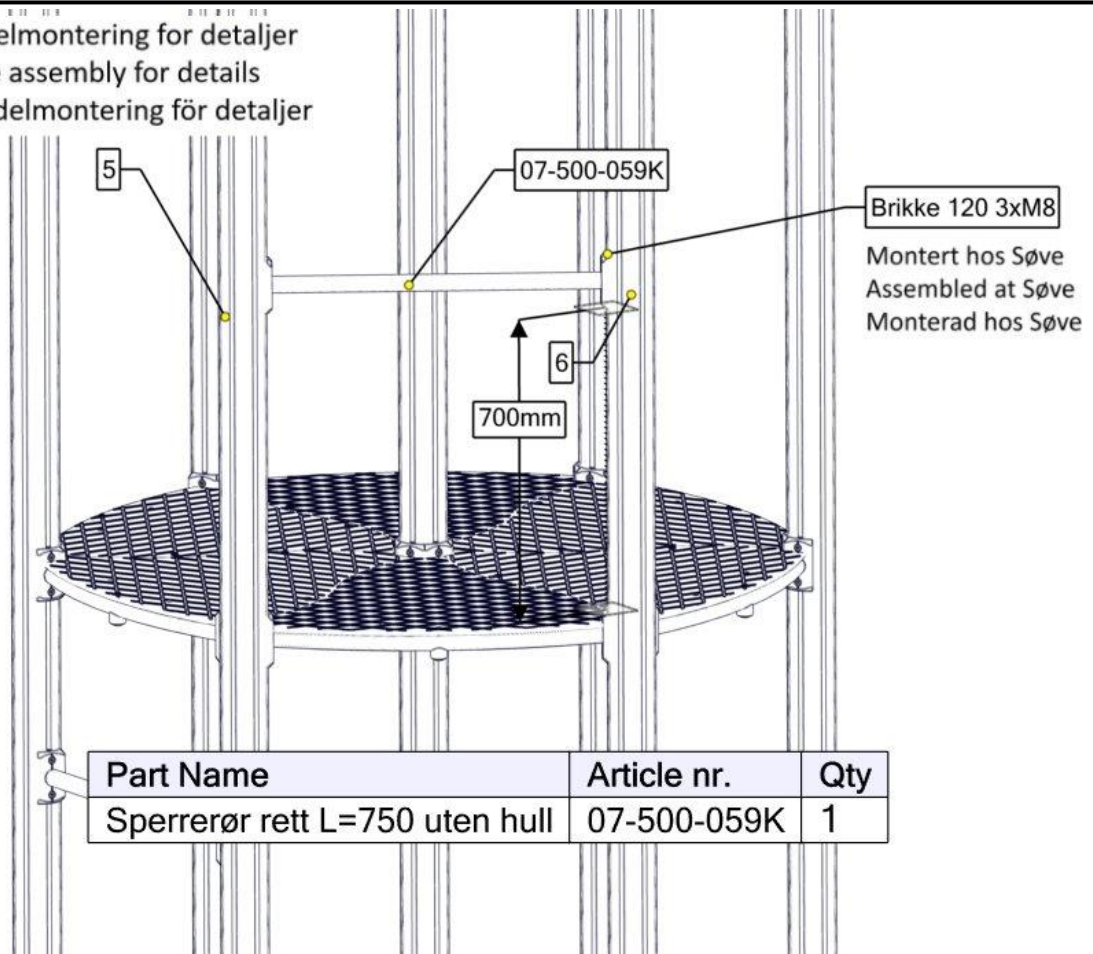

Part Name	Article nr.	Qty
Plast rørfeste, hode	05-301-036	18
Skive M8 stor	04-055-008	18

Se separat delmontering for detaljer
 See separate assembly for details
 Se separata delmontering för detaljer



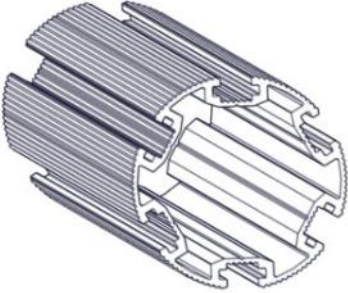

Boltepakker for / Boltpackage for / Bultpaket för

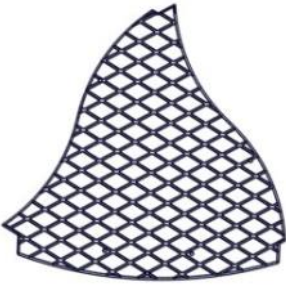

Sign. _____.

Thorium Tårn-dell 14-200-Tårn1	Navn	Artnr/dimensjon	Ant	Lev
	Stolpe Ø110 L=6450 Grå	SFA5126/2	1	
	Stolpe Ø110 L=6000 Grå	SFA5126/2	6	
	Sperrerør 6-kant gulv Rett L=750 2 hull Sort	07-500-064K (se egen delmontering)	6	
	Sperrerør 6-kant gulv Bøyd L=750 1 hull Sort	07-500-060K (se egen delmontering)	6	
	Sperrerør Rett L=750 Uten hull Grønn	07-500-059K (se egen delmontering)	2	
	Gulv 6-kant Standard Grå	07-301-120	6	

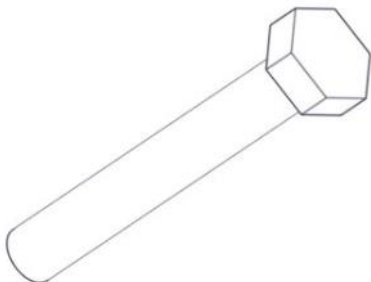
Boltepakker for / Boltpackage for / Bultpaket för

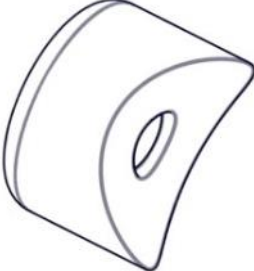
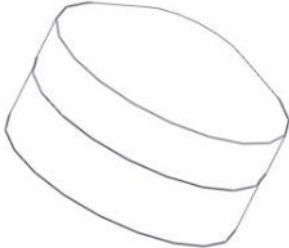
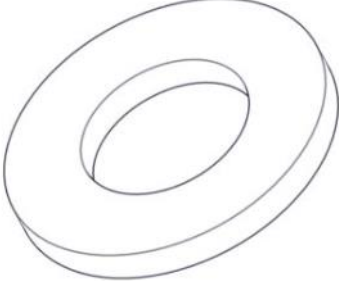

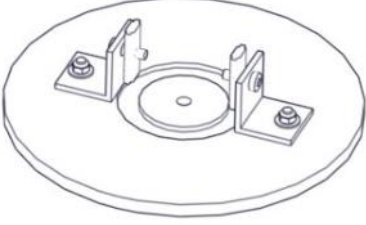
Sign. _____

Thorium Tårn-dell 14-200-Tårn1	Navn	Artnr/dimensjon	Ant	Lev
	Sekskant skrue M8x50	04-008-050	18	
	Møbelknapp M8x11	04-030-011	18	
	Plast rørfeste	05-301-036	18	
	Plast rørfeste endelokk	05-301-036	18	
	Skive M8 stor	04-055-008	18	

Boltepakker for / Boltpackage for / Bultpaket för		Sign. _____		
Thorium Tårn-dell 14-200-Tårn1	Navn	Artnr/dimensjon	Ant	Lev
	Fundament Støpefrie			
	Sperrerør Rett L=750 Uten hull Sort	07-500-075K (se egen delmontering)	12	
	Fundament plate 1xØ110 stolpe	07-400-101K (se egen delmontering)	7	
	Fundament Støp			
	Sperrerør Rett L=750 Uten hull Sort	07-500-075K (se egen delmontering)	12	
	Fundament støp	00-003-111K (se egen delmontering)	7	

Boltepakker for / Boltpackage for / Bultpaket för

Sign. _____

Thorium Tårn-dell 14-200-Tårn1	Navn	Artnr/dimensjon	Ant	Lev
	Fundament Overflatemon- tering			
	Fundament 1x 110 stolpe for betongdekk	00-003-113K (se egen delmontering)	1	
	Fundament 2x110 stolpe for betongdekke	00-003-114K (se egen delmontering)	3	

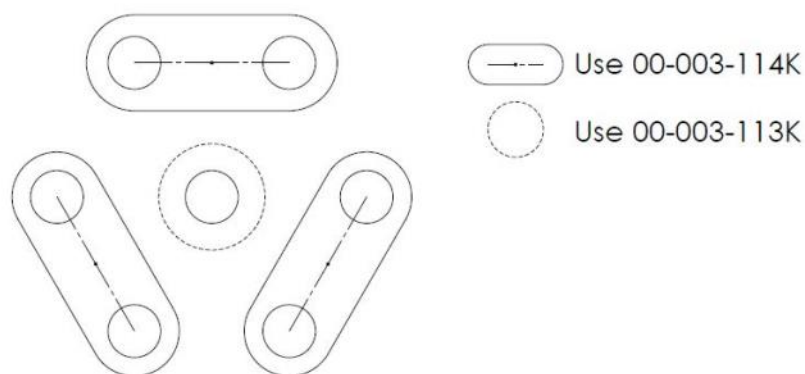

14-01-2020.

Fundament sperreør i sort

Endring bilder med alt som er montert

15-11-2021 SV

Lagt til støp og overflate montering i plukklister