

N

Monteringsanvisning

EN

Assembly Instructions

S

Monteringsanvisning

Produkt nr. / Product no. / Produkt nr.

14-200-Tårn**Del2 m / tunell**

Ord. nr. _____

Dato. _____



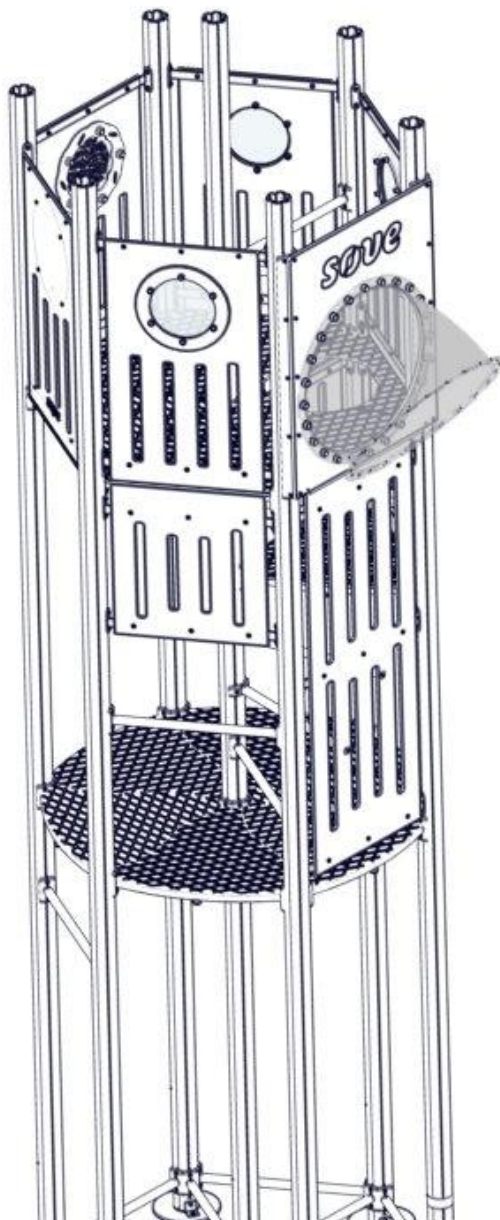

Sign. _____

**søve**



Søve AS
Grønnvoldveien 290
3830 Ulefoss - Norway
Tlf: +47 35 94 65 65
www.sove.no



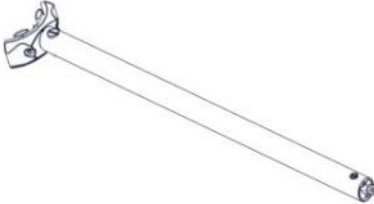
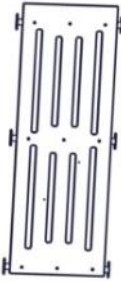

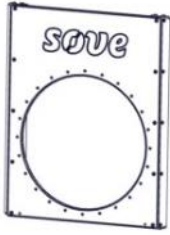
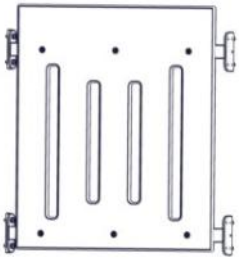
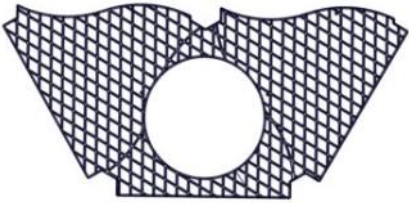
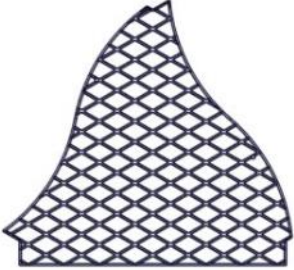
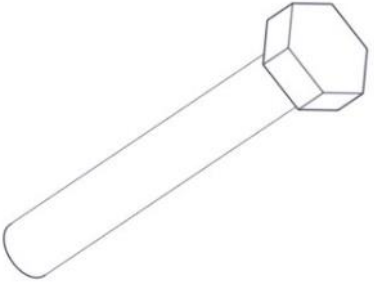
**søve**

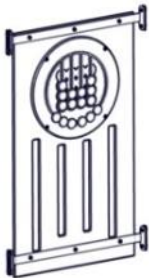
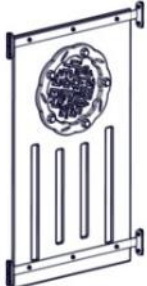
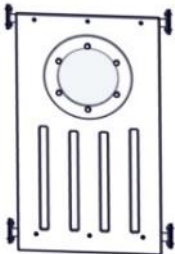
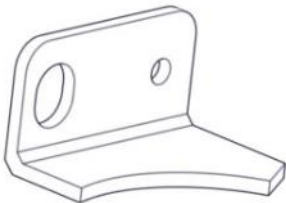
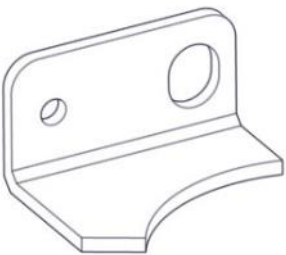
Søve AB
EA Rosengrensgatan 32
421 31 Västra Frölunda
Phone: +46 (0)31 773 97 00
www.sove.se

Boltepakker for / Boltpackage for / Bultpaket för		Sign. _____		
Thorium Tårn-del2 m/tunell 14-200-Tårn2 m /tunell	Navn	Artnr/dimensjon	Ant	Lev
	Sperrerør 6-kant gulv Rett L=750 2 hull Sort	07-500-064K (se egen del- montering)	4	
	Sperrerør 6-kant gulv Bøyd L=750 1 hull Sort	07-500-060K (se egen del- montering)	2	
	Sperrerør Rett L=750 Uten hull Sort	07-500-075K (se egen del- montering)	6	
	Sperrerør Rett L=750 Uten hull Grønn	07-500-059K (se egen del- montering)	3	
	Sperrerør Tårn trapp Grønn	07-520-612K (se egen del- montering)	4	
	Rekkverk Tårn Med hull til spiraltrapp 700x1960 Grønn	07-302-107K (se egen del- montering)	1	

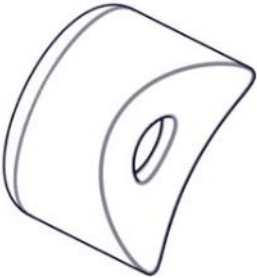
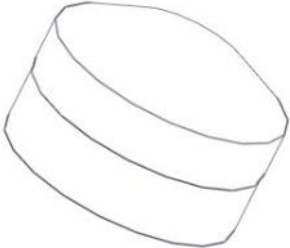
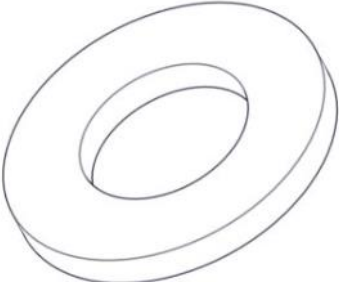
Boltepakker for / Boltpackage for / Bultpaket för		Sign. _____		
Thorium Tårn-del2 m/tunell 14-200-Tårn2 m /tunell	Navn	Artnr/dimensjon	Ant	Lev
	Rekkverk Tårn 700x765 Grønn	07-302-108K (se egen del- montering)	1	
	Rekkverk Tårn tunell 940x1220 Grønn	07-302-150K (se egen del- montering)	1	
	Rekkverk Tårn 700x765 Grønn	07-302-112K (se egen del- montering)	2	
	Gulv 6-kant Stor m/hull og for tunell Grå	07-301-128	1	
	Gulv 6-kant Tårn Grå	07-301-126	3	
	Sekskant skrue M8x50	04-008-050	10	

Boltepakker for / Boltpackage for / Bultpaket för		Sign. _____.		
Thorium Tårn-del2 m/tunell 14-200-Tårn2 m /tunell	Navn	Artnr/dimensjon	Ant	Lev
	Rekkverk Tårn 700x1220 med 3 på råd Grønn	07-302-141K (se egen del- montering)	1	
	Rekkverk Tårn 700x1220 med Maze/ labyrint Grønn	07-302-143K (se egen del- montering)	1	
	Rekkverk Tårn 700x1220 med Dome Grønn	07-302-115K (se egen del- montering)	3	
	Tetting gulv Thorium venstre	07-302-153	1	
	Tetting gulv Thorium høyre	07-302-154	1	
	Torx M8x35	04-000-035	2	

Boltepakker for / Boltpackage for / Bultpaket för		Sign. _____.		
Thorium Tårn-del2 m/tunell 14-200-Tårn2 m /tunell	Navn	Artnr/dimensjon	Ant	Lev
	Plast rørfeste	05-301-036	10	
	Plast rørfeste endelokk	05-301-036	10	
	Skive M8 stor	04-055-008	10	
	Skive M8	04-050-008	2	
	Møbelknapp M8x11	04-030-011	10	
	Låsemutter M8	04-040-008	2	
	Gulv 3-kant 2 Rett CC880 Grå	07-300-108K (se egen del- montering)	1	

Se separat delmontering for detaljer
 See separate assembly for details
 Se separata delmontering för detaljer

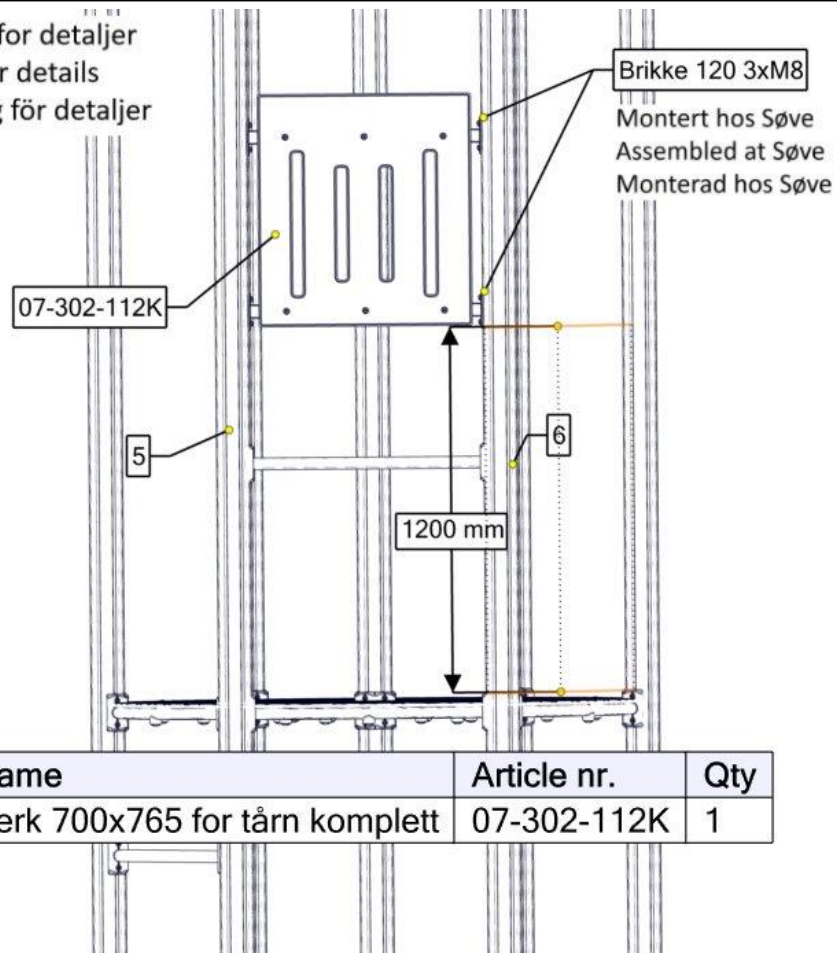

Part Name	Article nr.	Qty
Rekkverk 700x765 for tårn komplett	07-302-112K	1

Se separat delmontering for detaljer
 See separate assembly for details
 Se separata delmontering för detaljer

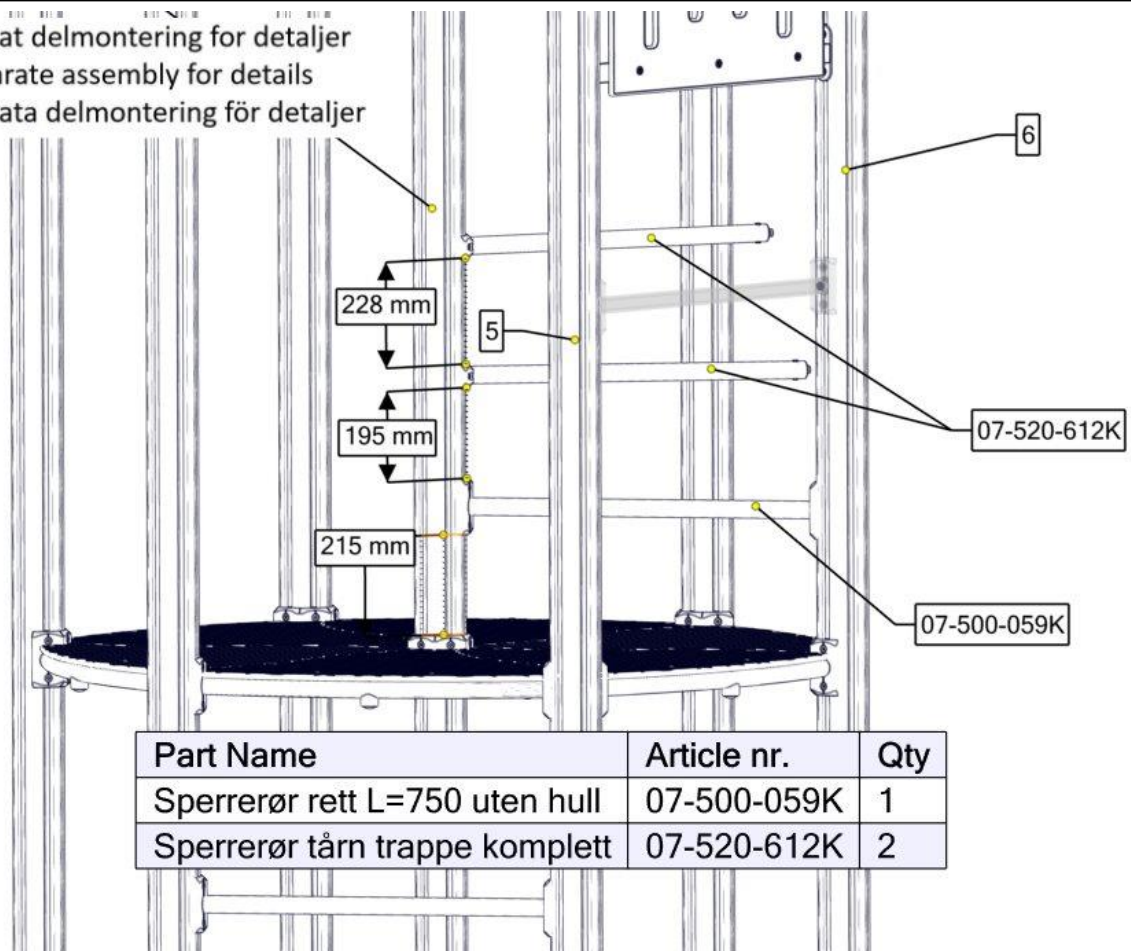

Part Name	Article nr.	Qty
Sperrerør rett L=750 uten hull	07-500-059K	1
Sperrerør tårn trappe komplett	07-520-612K	2

Se separat delmontering for detaljer
 See separate assembly for details
 Se separata delmontering för detaljer

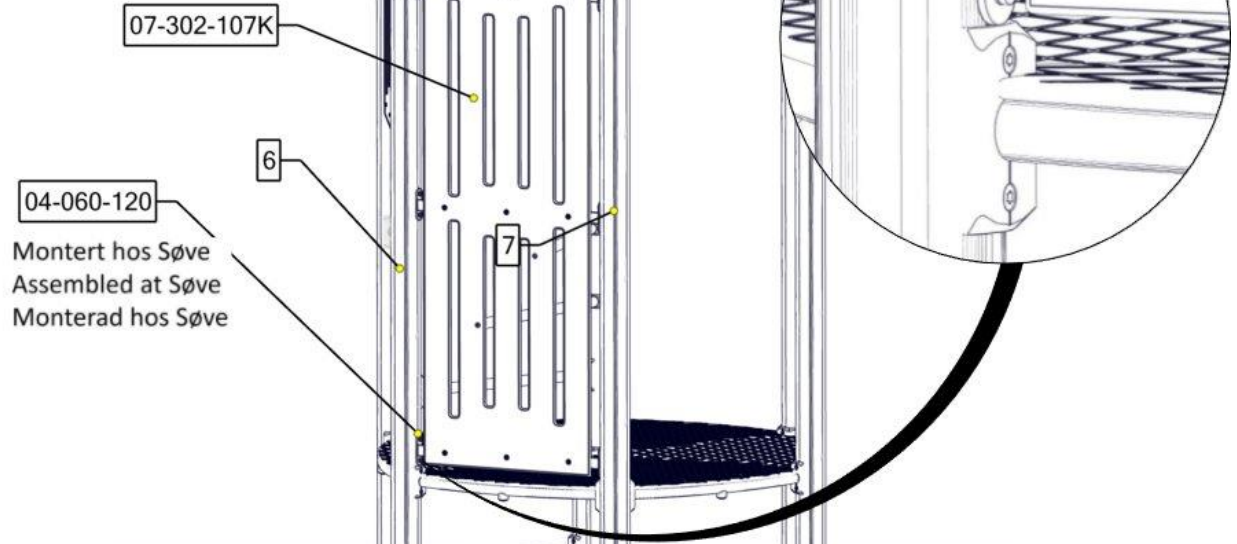

Part Name	Article nr.	Qty
Rekkverk 700x1960 for tårn komplett	07-302-107K	1

Se separat delmontering for detaljer
 See separate assembly for details
 Se separata delmontering för detaljer

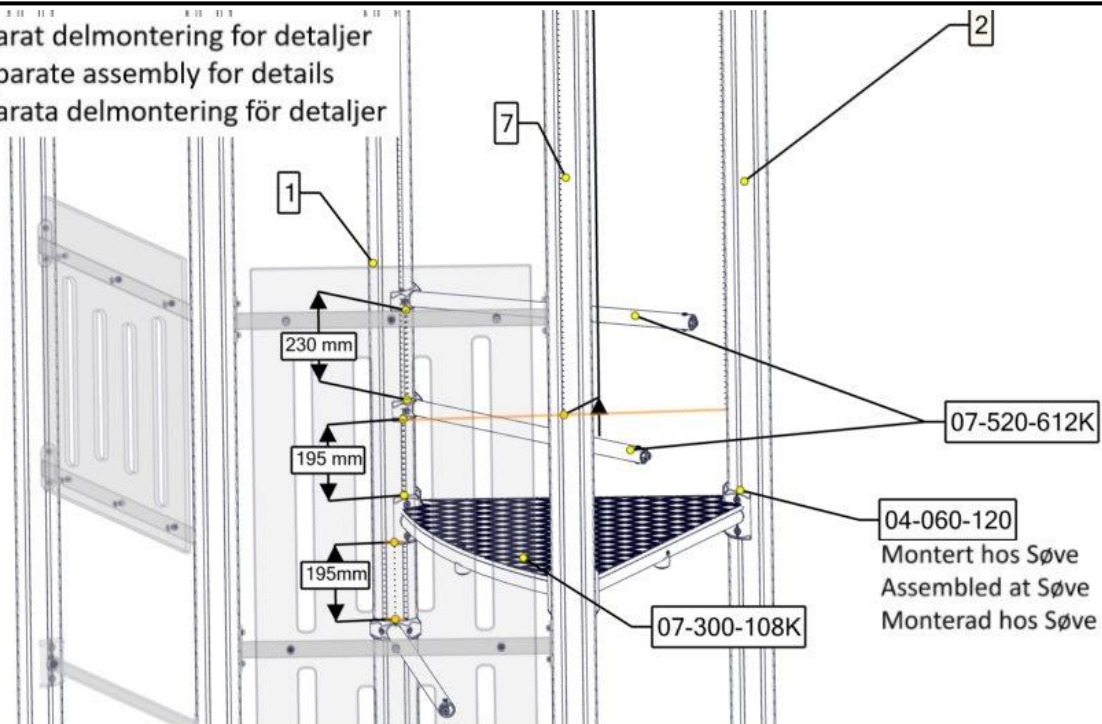

Part Name	Article nr.	Qty
Gulv 3-kant 880x880 2Rett	07-300-108K	1
Sperrerør tårn trappe komplett	07-520-612K	2

Se separat delmontering for detaljer
 See separate assembly for details
 Se separata delmontering för detaljer

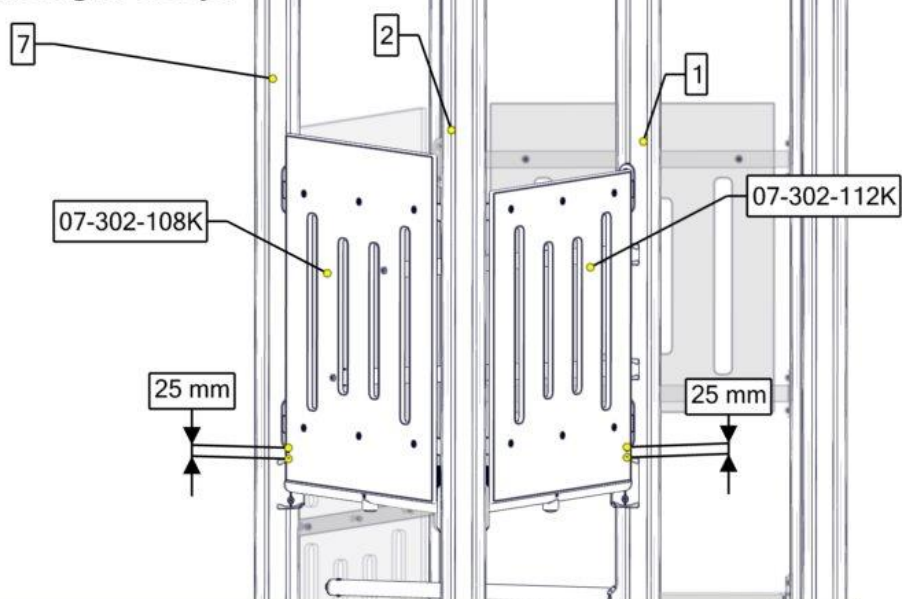

Part Name	Article nr.	Qty
Rekkverk 700x765 for tårn komplett	07-302-112K	1
Rekkverk 700x851 for tårn	07-302-108K	1

Se separat delmontering for detaljer
 See separate assembly for details
 Se separata delmontering för detaljer

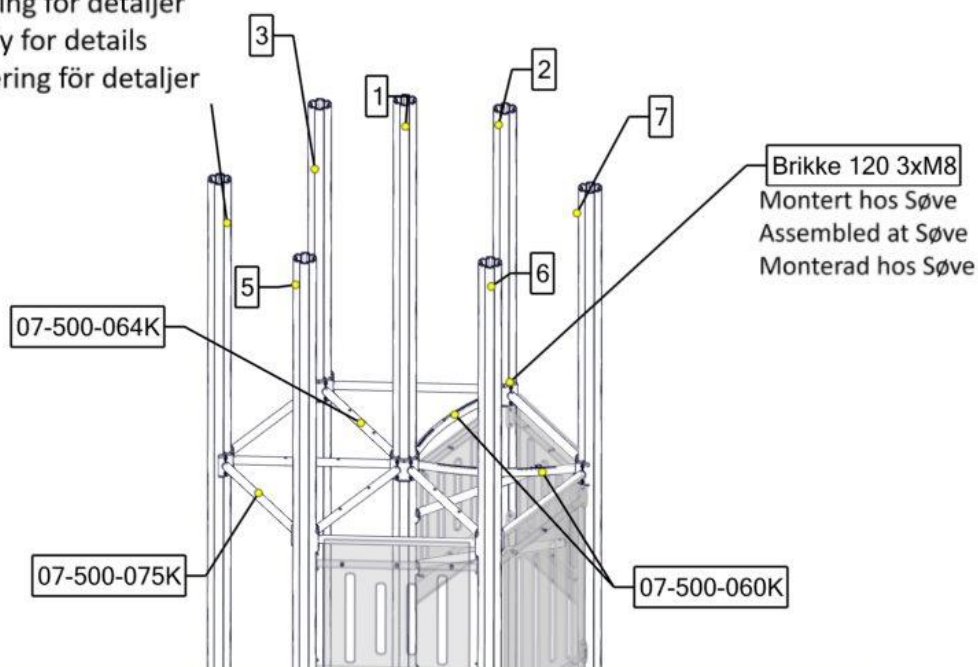

Part Name	Article nr.	Qty
Sperrerør Bøyd L=750 m hull gulv komplet	07-500-060K	2
Sperrerør 6-kant gulv L=750 2 hull	07-500-064K	4
Sperrerør rett L=750 uten hull	07-500-075K	6

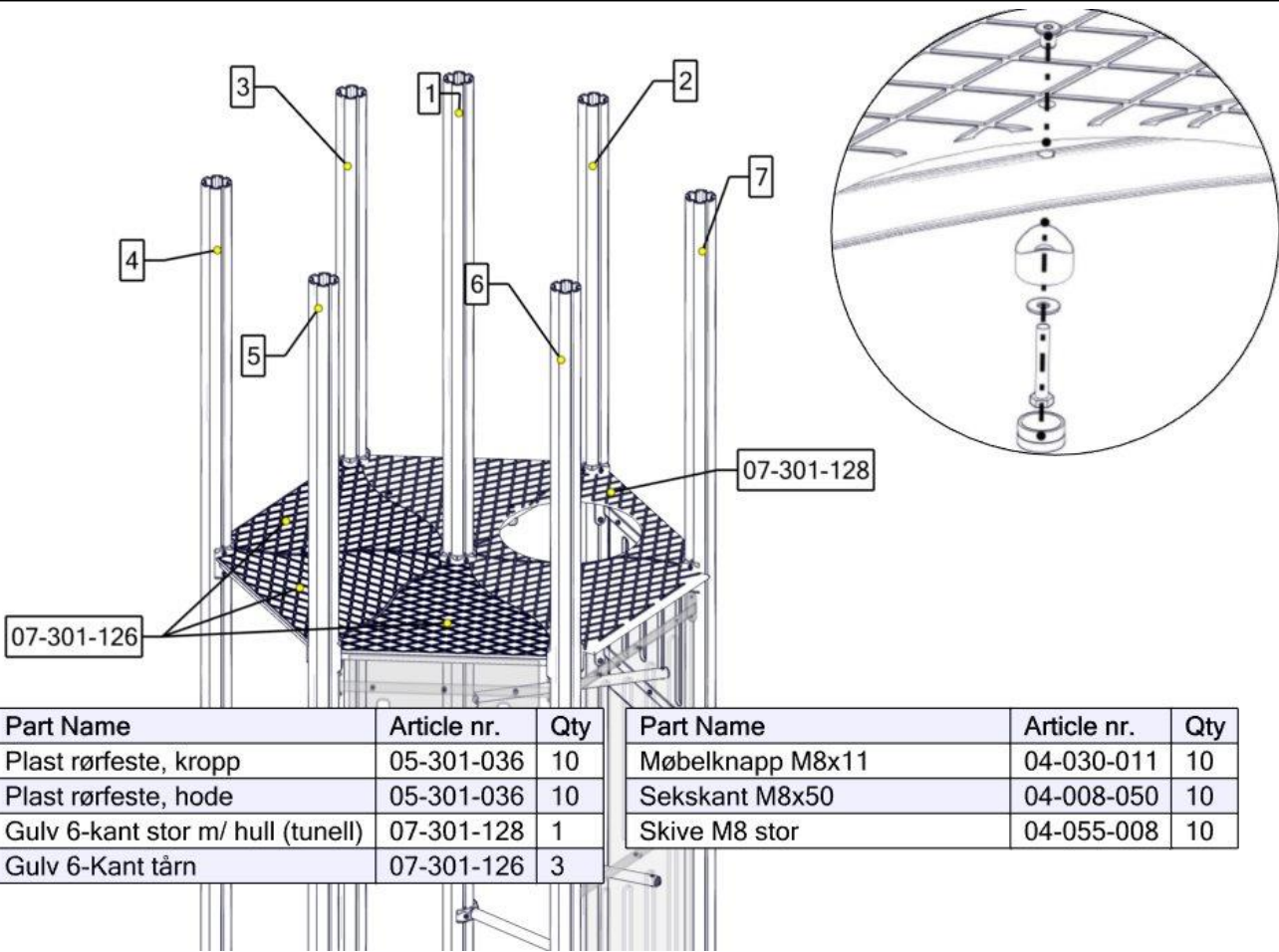

Part Name	Article nr.	Qty
Plast rørfeste, kropp	05-301-036	10
Plast rørfeste, hode	05-301-036	10
Gulv 6-kant stor m/ hull (tunell)	07-301-128	1
Gulv 6-Kant tårn	07-301-126	3

Part Name	Article nr.	Qty
Møbelknapp M8x11	04-030-011	10
Sekskant M8x50	04-008-050	10
Skive M8 stor	04-055-008	10

Se separat delmontering for detaljer
 See separate assembly for details
 Se separata delmontering för detaljer

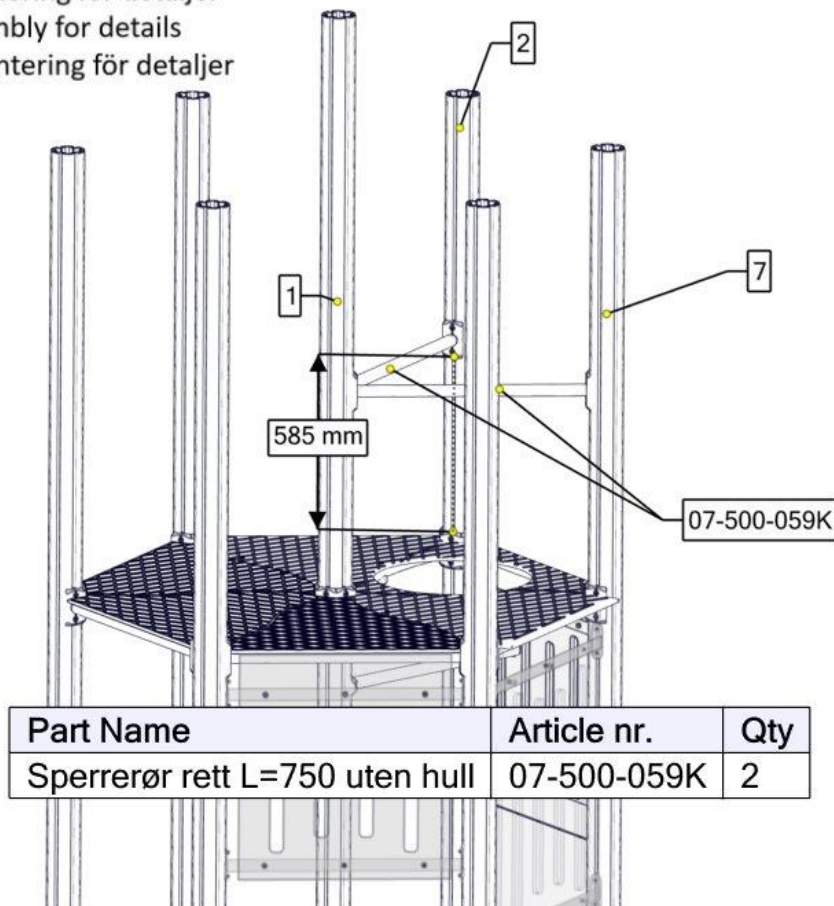

Part Name	Article nr.	Qty
Sperrerør rett L=750 uten hull	07-500-059K	2

Se separat delmontering for detaljer
 See separate assembly for details
 Se separata delmontering för detaljer

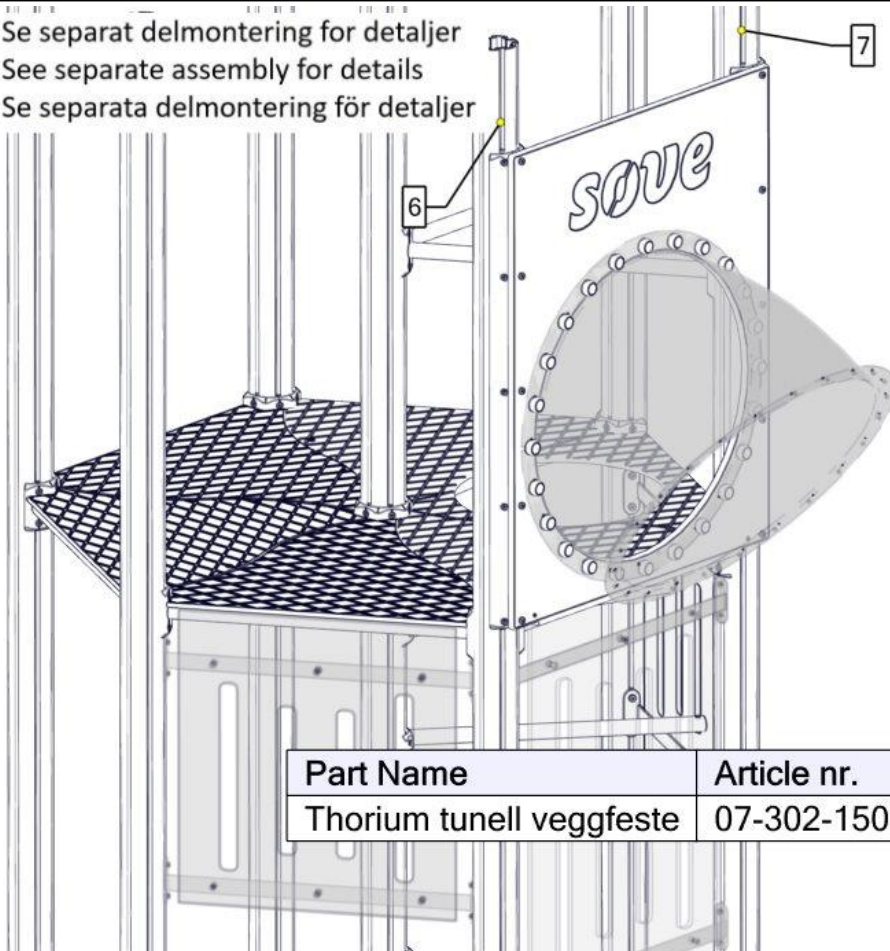

Part Name	Article nr.	Qty
Thorium tunell veggfeste	07-302-150K	1

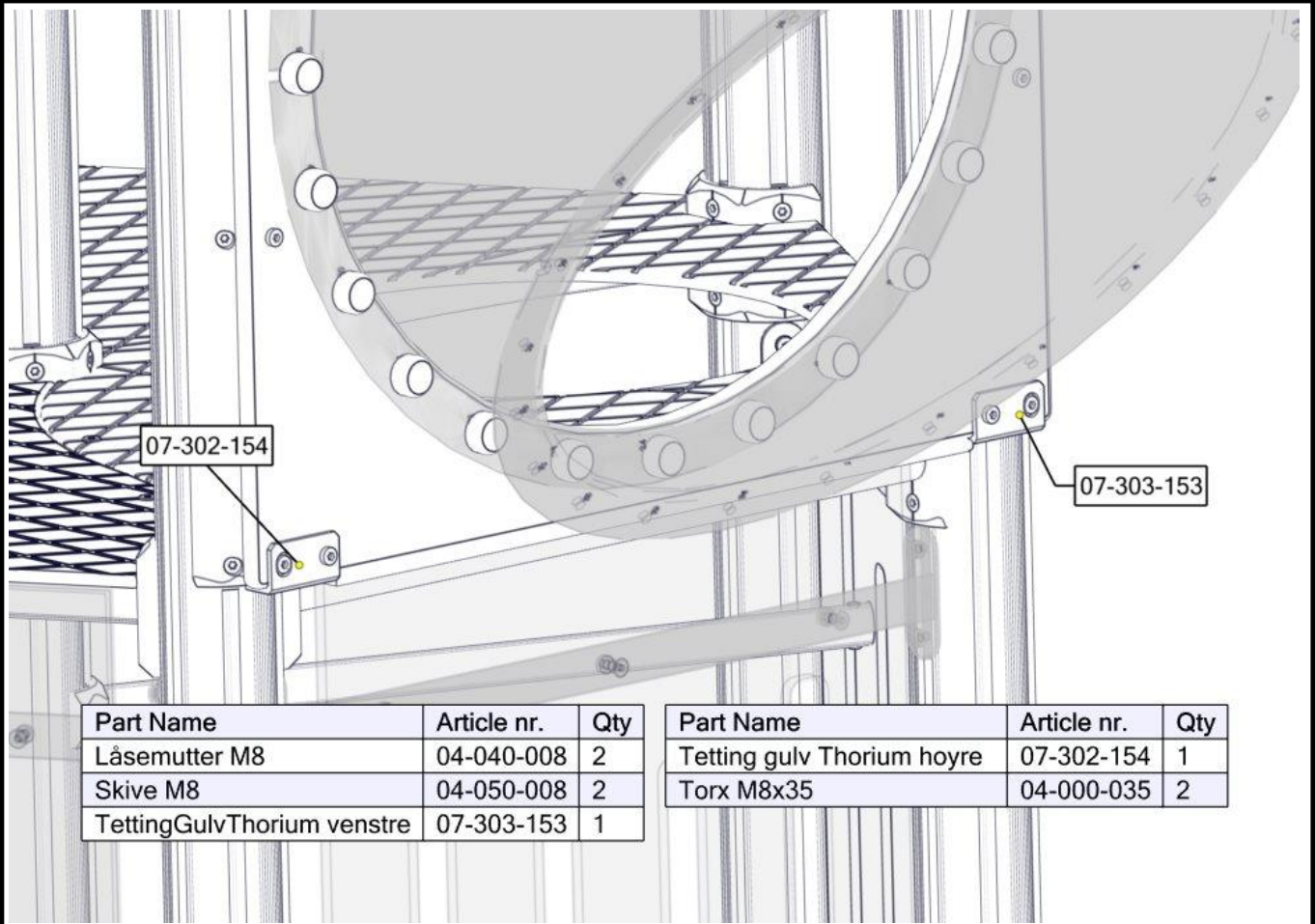

Part Name	Article nr.	Qty
Låsemutter M8	04-040-008	2
Skive M8	04-050-008	2
TettingGulvThorium venstre	07-303-153	1



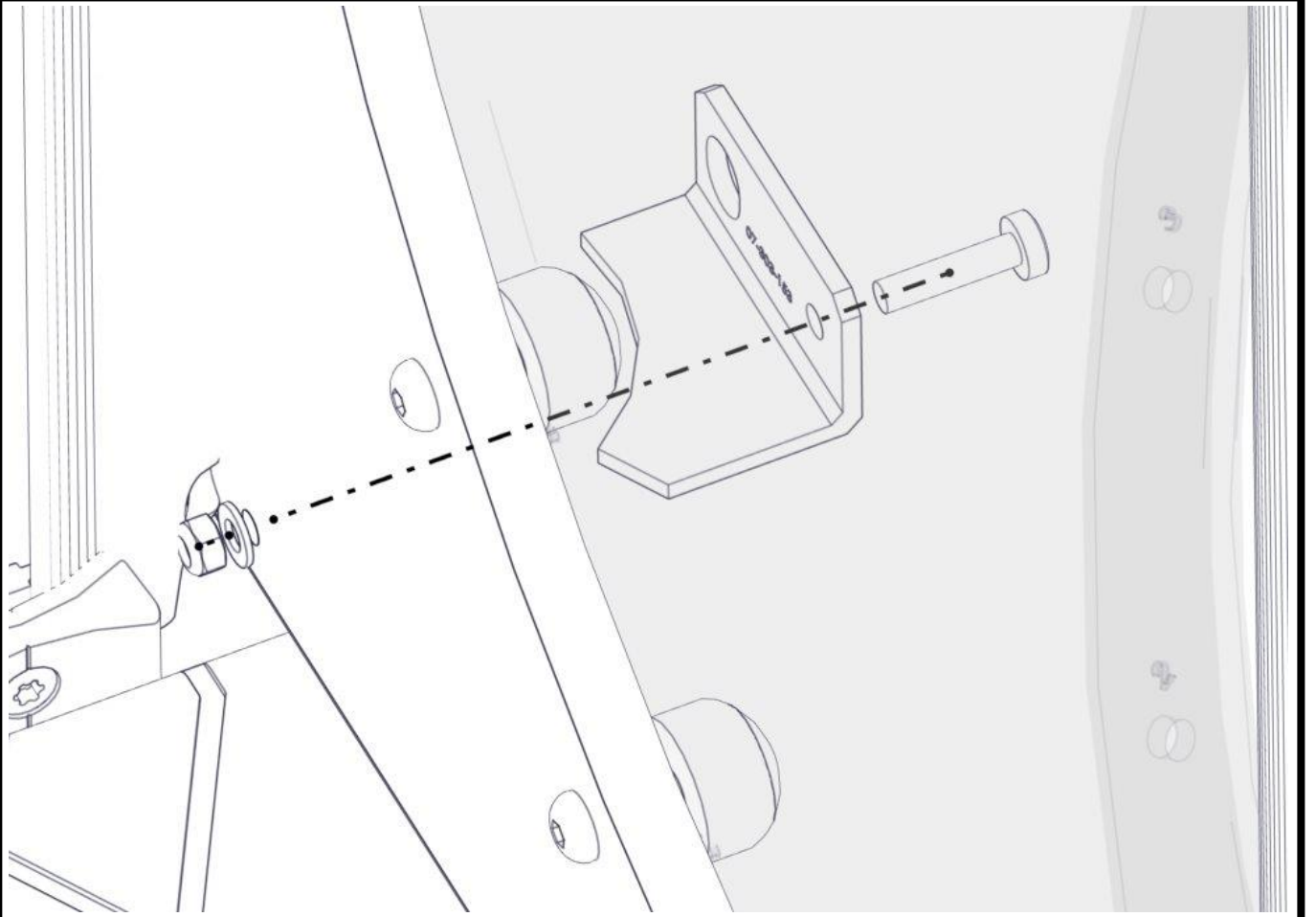

Part Name	Article nr.	Qty
Tetting gulv Thorium hoyre	07-302-154	1
Torx M8x35	04-000-035	2

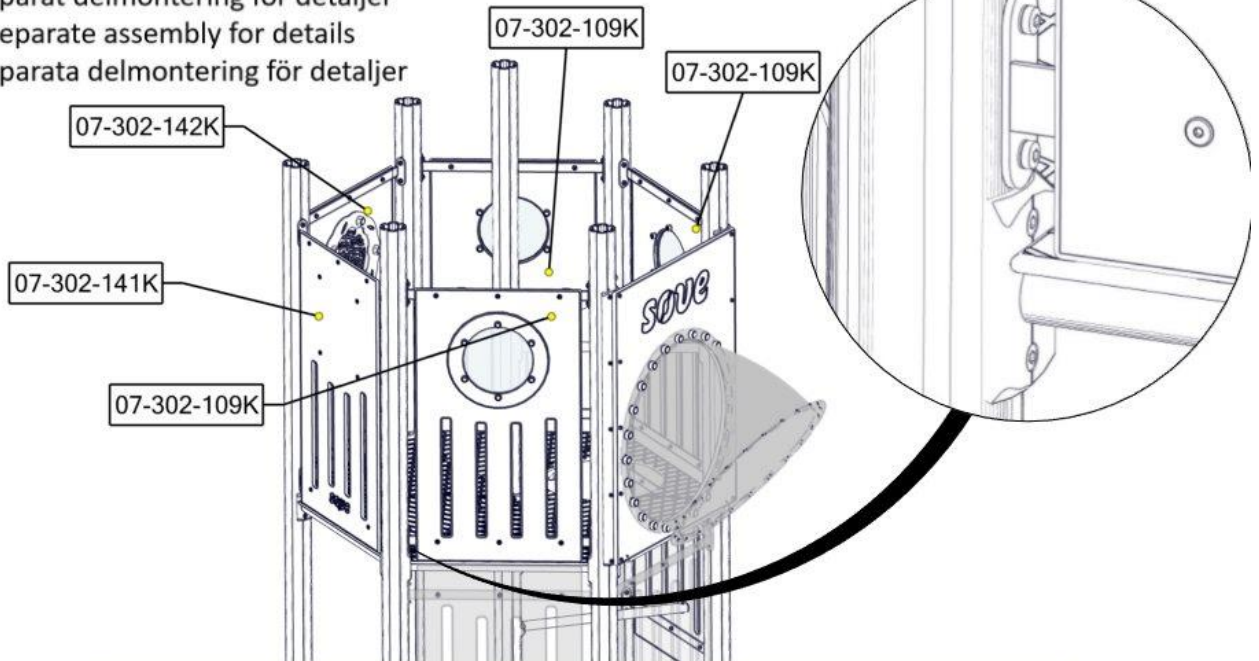



Se separat delmontering for detaljer
 See separate assembly for details
 Se separata delmontering för detaljer



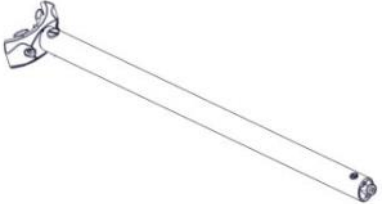
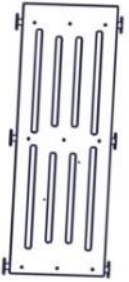

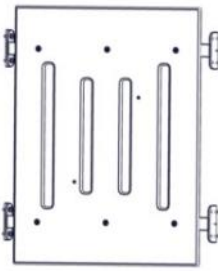
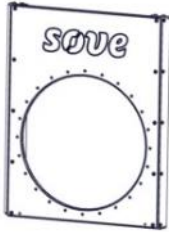
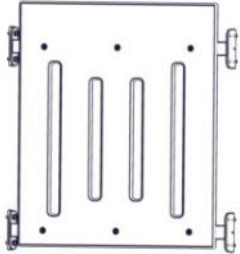
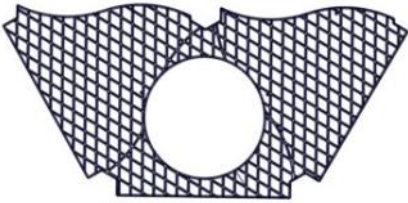
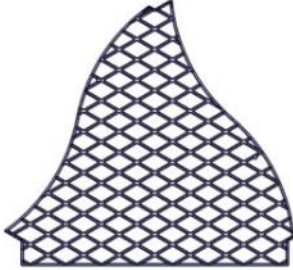
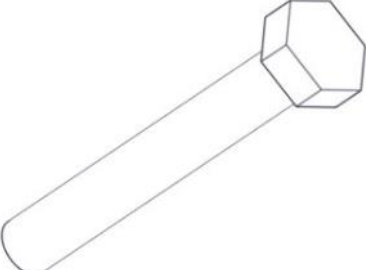

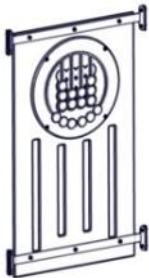
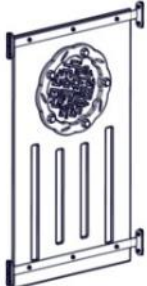
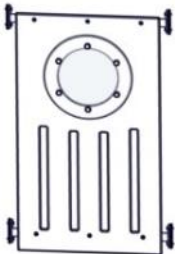
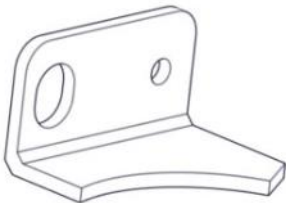
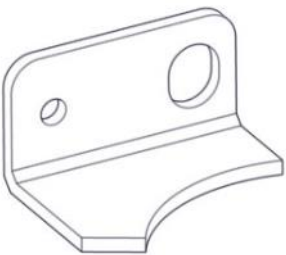
Part Name	Article nr.	Qty
Rekkverk 700x1220 for tårn komplett	07-302-109K	3
Rekkverk 700x1220 for tårn med 3 på rad	07-302-141K	1
Rekkverk 700x1220 for tårn komplett	07-302-142K	1

Boltepakker for / Boltpackage for / Bultpaket för		Sign. _____		
Thorium Tårn-del2 m/tunell 14-200-Tårn2 m /tunell	Navn	Artnr/dimensjon	Ant	Lev
	Sperrerør 6-kant gulv Rett L=750 2 hull Sort	07-500-064K (se egen del- montering)	4	
	Sperrerør 6-kant gulv Bøyd L=750 1 hull Sort	07-500-060K (se egen del- montering)	2	
	Sperrerør Rett L=750 Uten hull Sort	07-500-075K (se egen del- montering)	6	
	Sperrerør Rett L=750 Uten hull Grønn	07-500-059K (se egen del- montering)	3	
	Sperrerør Tårn trapp Grønn	07-520-612K (se egen del- montering)	4	
	Rekkverk Tårn Med hull til spiraltrapp 700x1960 Grønn	07-302-107K (se egen del- montering)	1	

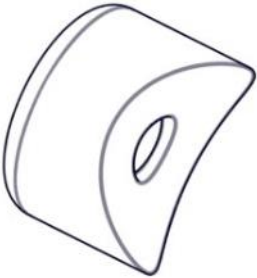
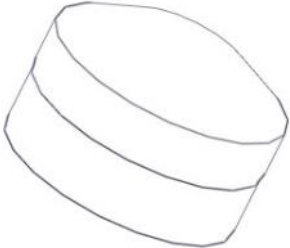
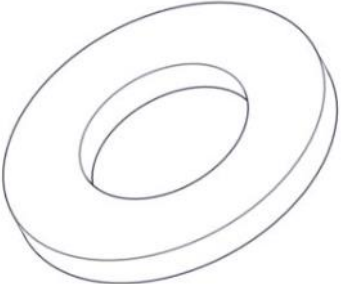
Boltepakker for / Boltpackage for / Bultpaket för		Sign. _____		
Thorium Tårn-del2 m/tunell 14-200-Tårn2 m /tunell	Navn	Artnr/dimensjon	Ant	Lev
	Rekkverk Tårn 700x765 Grønn	07-302-108K (se egen del- montering)	1	
	Rekkverk Tårn tunell 940x1220 Grønn	07-302-150K (se egen del- montering)	1	
	Rekkverk Tårn 700x765 Grønn	07-302-112K (se egen del- montering)	2	
	Gulv 6-kant Stor m/hull og for tunell Grå	07-301-128	1	
	Gulv 6-kant Tårn Grå	07-301-126	3	
	Sekskant skrue M8x50	04-008-050	10	

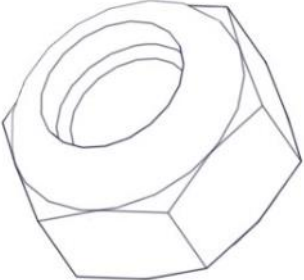
Boltepakker for / Boltpackage for / Bultpaket för		Sign. _____.		
Thorium Tårn-del2 m/tunell 14-200-Tårn2 m /tunell	Navn	Artnr/dimensjon	Ant	Lev
	Rekkverk Tårn 700x1220 med 3 på råd Grønn	07-302-141K (se egen del- montering)	1	
	Rekkverk Tårn 700x1220 med Maze/ labyrint Grønn	07-302-143K (se egen del- montering)	1	
	Rekkverk Tårn 700x1220 med Dome Grønn	07-302-115K (se egen del- montering)	3	
	Tetting gulv Thorium venstre	07-302-153	1	
	Tetting gulv Thorium høyre	07-302-154	1	
	Torx M8x35	04-000-035	2	

Boltepakker for / Boltpackage for / Bultpaket för		Sign. _____.		
Thorium Tårn-del2 m/tunell 14-200-Tårn2 m /tunell	Navn	Artnr/dimensjon	Ant	Lev
	Plast rørfeste	05-301-036	10	
	Plast rørfeste endelokk	05-301-036	10	
	Skive M8 stor	04-055-008	10	
	Skive M8	04-050-008	2	
	Møbelknapp M8x11	04-030-011	10	
	Låsemutter M8	04-040-008	2	
	Gulv 3-kant 2 Rett CC880 Grå	07-300-108K (se egen del- montering)	1	