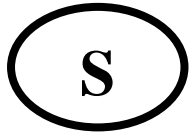

**Monteringsanvisning****Assembly Instructions****Monteringsanvisning**

Produkt nr. / Product no. / Produkt nr.

16-100-135

Ord.. nr. _____

Dato. _____

Sign. _____

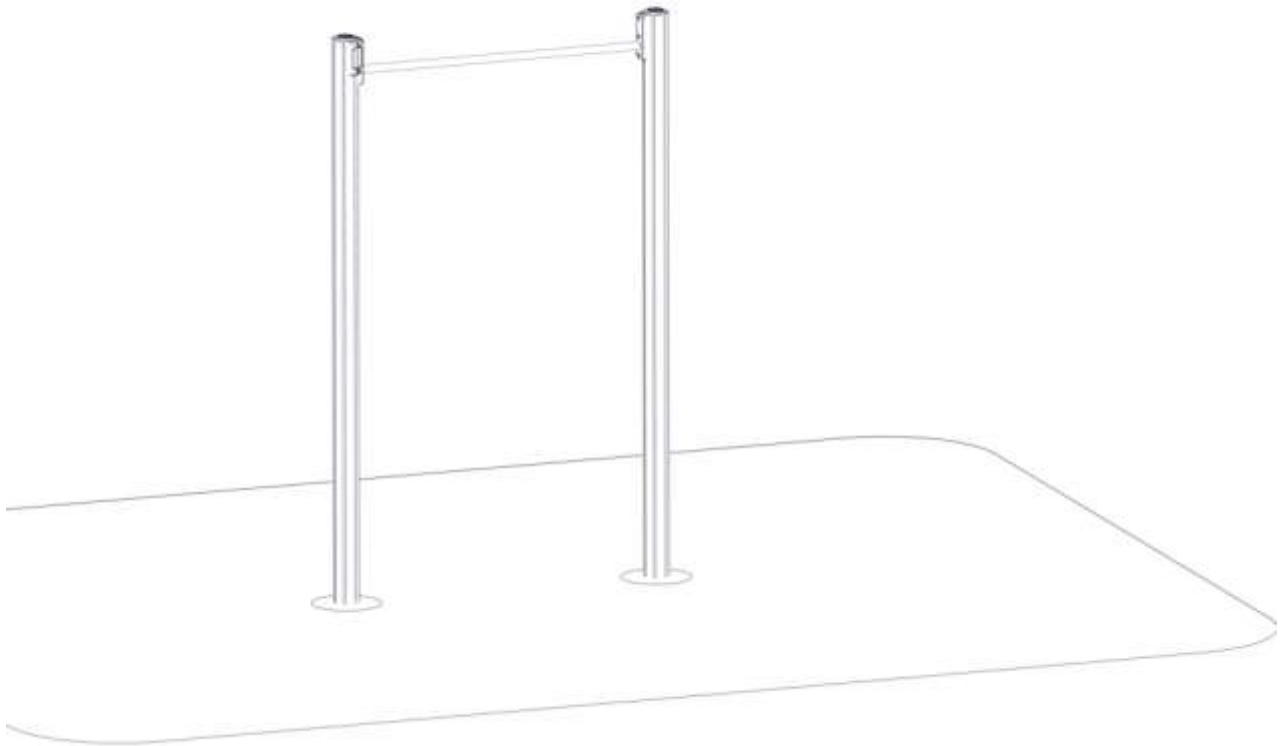
**sove**

Søve AS
3830 Ulefoss - Norway
Tlf: +47 35 94 65 65
www.sove.no



Søve AB
EA Rosengrensgatan 32
421 31 Västra Frölunda
Phone: +46 (0)31 773 97 00
www.sove.se

Monteringstips / Assembly Advice / Monteringsstips

N

- Les monteringsanvisningen nøye før montering.
- Monter elementene i rekkefølgen som vist.
- Boltene bør ikke skrues for hardt til før alt er montert, vatret og loddet. Skru så boltene til.
- NB! Ved bruk av drill, kan boltene ryke.
- Er lekeutstyret plassert i naturlige ferdselstraséer må området sikres mot gjennomgang.
- Innspringningshinder bør vurderes rundt lekeapparater hvor det er stor bevegelse, f.eks. ved huskestativ.
- Det bør være fritt innsyn til lekeutstyr som er beregnet for barn under 3 år.

NB! Under monteringsarbeidet må utstyr, som ikke er forankret forsvarlig i bakken, sikres slik at det ikke velte.

Området må avstenges under montering av apparatene med sperrebånd eller lignende.

EN

- Read the instruction carefully before assembling the play unit..
- Assemble the components in the sequence shown in these instructions.
- Fixings must not be fully tightened during assembly. Before casting the foundations, the structure must be level and plumb, at which point all fixings are tightened.
- PS! If use of drill, the bolts may be wrecked.
- Secure the construction-area to prevent people from walking through it.
- Consider installing barriers around play-equipment which gives rise to a lot of activity – i.e.swings.
- Ensure that clear vision is possible across the play area so that supervision is possible from any position, particularly where children under 3 years of age will be playing.

NB! During assembly of the equipment, ensure that all structures are securely propped, especially when left overnight. Also ensure that equipment is supported whilst concrete foundations are setting and enclose the area securely to prevent access.

Monteringstips / Assembly Advice / Monteringsstips

S

- Läs monteringsanvisningen noga före montering.
- Montera delarna i den ordningen som anvisas
- Skruvarna bör inte skruvas för hårt tills allt är monterat, i våg och lodat.









OBS! Används elektrisk skruvdragare, kan bulten gå sönder. Härddra därför manuellt!

- Om lekplatsen placeras vid en gångväg mm bör området säkras mot genomfart av gående och cyklister.
- Inspringningshinder bör placeras runt lekutrustning med stor rörelse, t ex, gungställning.
- Det bör vara fri insyn till lekutrustning beräknat till barn under 3 år.

OBS! Under monteringsarbete bör utrustningen som inte ska förankras i marken, ställs så att den inte kan välta.

Området måste spärras när lekutrustningen byggs upp, med avspärrningsband eller liknande.

Nødvendig verktøy / Tools required / Nödvändiga verktyg

| | | | | | |
|-----------------------------------|--|---|---|--|--|
| <p>(N)</p> <p>(EN)</p> <p>(S)</p> | <p>(A)</p>  | <p>(B)</p>  <p>Torx Nr 45 High quality</p> | <p>(C)</p> | <p>(D)</p>  | <p>(E)</p>  |
| |  | <p>Metermål</p> <p>Metric measure</p> <p>Tumstock</p>  | <p>16 V</p>  | <p>Merkebånd</p> <p>Mark ribbon</p> <p>Märkeband</p>  | |

Nødvendig antall personer / Number of persons required / Rekommenderad antal personer

| | |
|-----------------------------------|---|
| <p>(N)</p> <p>(EN)</p> <p>(S)</p> |  |
|-----------------------------------|---|

Anbefalt arealbehov ved montering / Recommended working space / Rekommenderad arealbehov vid montering

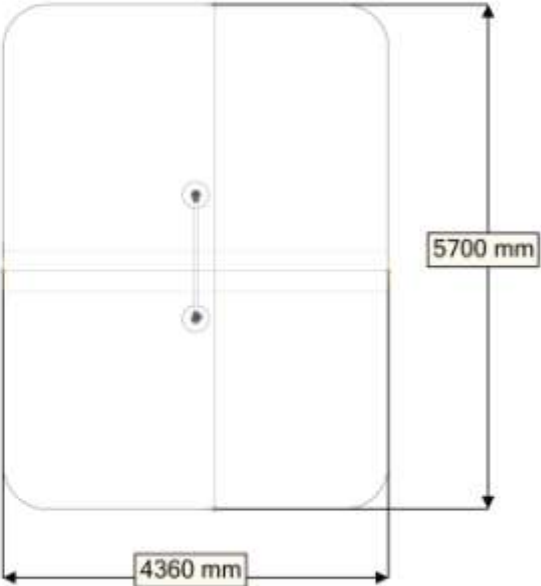
| | |
|-----------------------------------|--|
| <p>(N)</p> <p>(EN)</p> <p>(S)</p> |  |
|-----------------------------------|--|

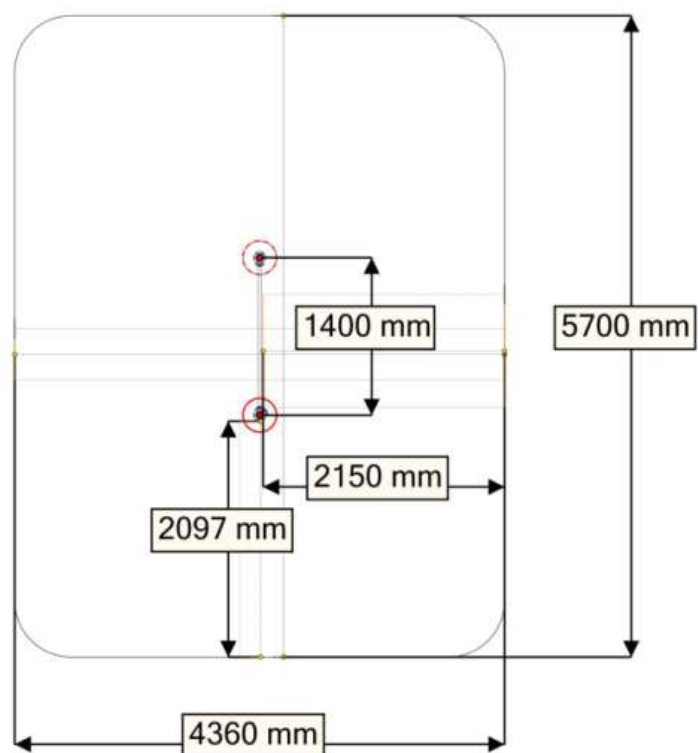
Fallhøyder / Free height of fall / Fallhöjder**Sikkerhetszone / Safety zone / Säkerhetszon**

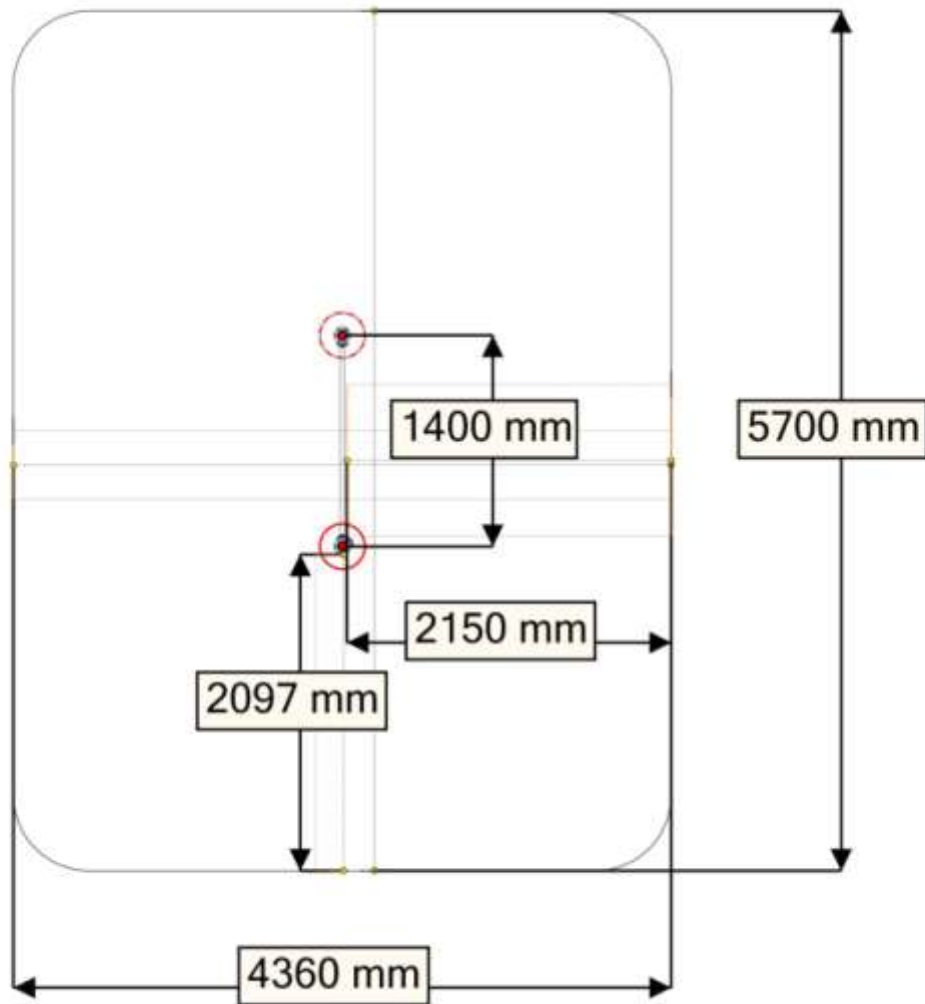
Plassering av forankringer / Ground plan / Placering av förankringar

N

Alle mål er oppgitt i millimeter

EN

Scale measured in mm

S

Alla mått är i millimeter.

Fundamentering med betong / Foundation concrete / Förankring med betong

(N)

Støtsand



(N)

Bakkenivå

(UK)

Ground level

(S)

Marknivå

(EN)

Safer surface

(S)

Stridsan

Ref NS-EN 177

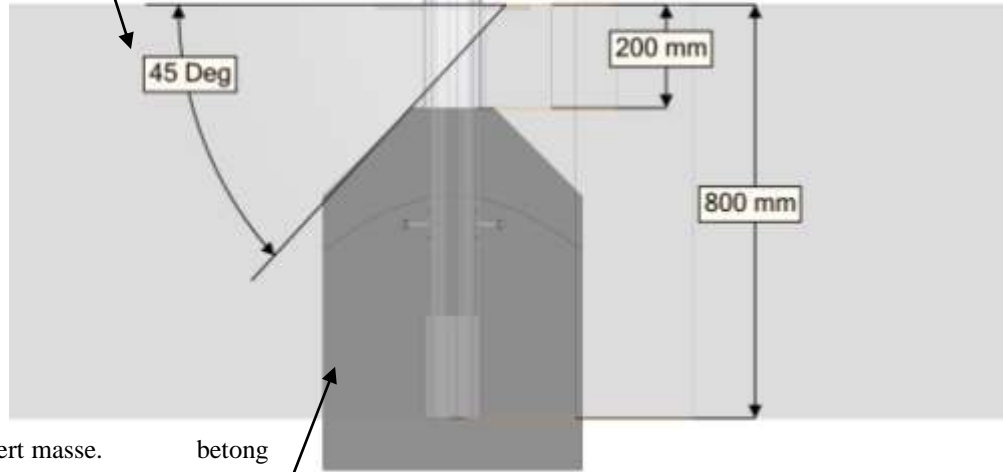

(N)

Komprimert masse.

betong

(EN)

Compressed mass.

concrete

(S)

Komprimerad massa.

betong

(N)

Bolten skrues HELT igjennom aluminiumen.

(EN)

The bolt must be tightened in to the post, so that it peirces the aluminium





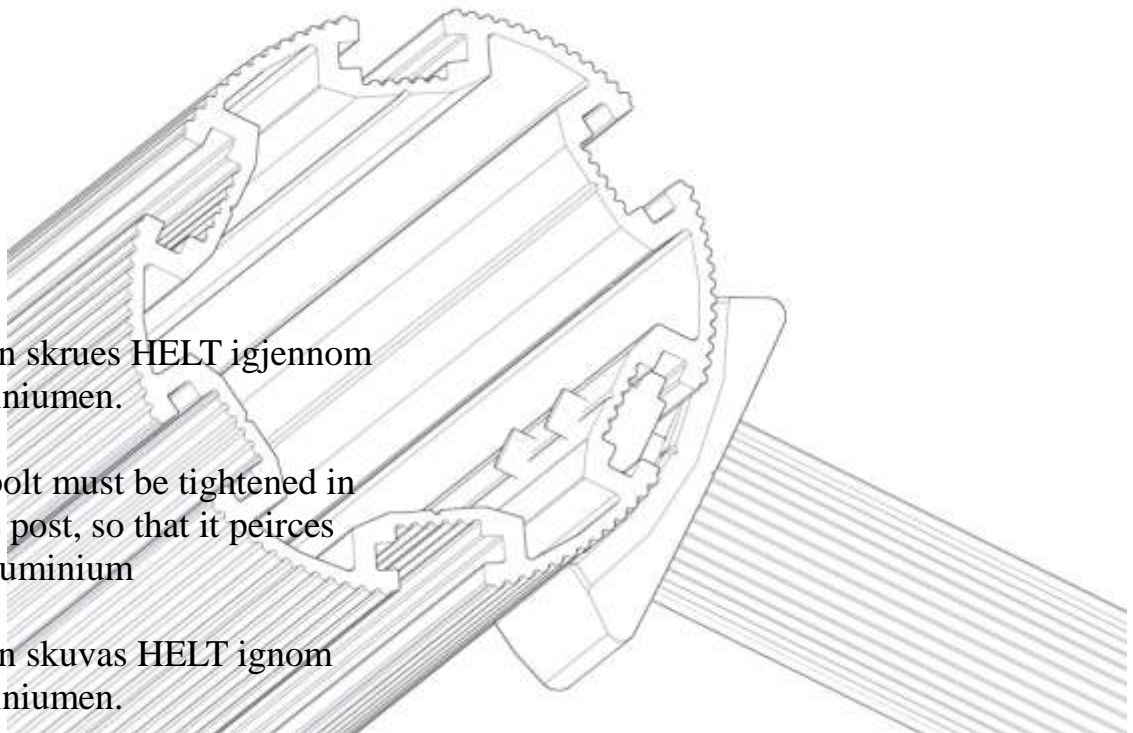

(S)

Bulten skuvras HELT ignom aluminiumen.









Boltepakker for / Boltpackage for / Bultpaket för

Sign. _____.

| Stolpe 110 | Ant= 2 | Navn | Artnr/dimensjon | Ant | Lev |
|---|---|---|-----------------|-----|-----|
|  | | Stolpe 110 L=3250 800-2450 (1) | 07-100-333 | 2 | |
| Stolpende | Ant= 4 | Navn | Artnr/dimensjon | Ant | Lev |
|  | | Endelokk (1) | 00-400-995 | 2 | |
| | | Endelokk med hull | 00-400-996 | 2 | |
| Workout L=1270 cc1400 | Ant= 1 | Navn | Artnr/dimensjon | Ant | Lev |
|  |  | Stål rør Workout L=1270 CC1400 3HULL!! | 07-500-460 | 1 | |
| |  | Brikke 200_3xM8 (2) | 04-060-201 | 2 | |
| |  | Torx M8x35 (6) | 04-000-035 | 6 | |
| |  | OG 200_3H(2) | 07-150-028 | 2 | |

Boltepakker for / Boltpackage for / Bultpaket för

Sign. _____.

| Produktmerke | Ant= 1 | Navn | Artnr/dimensjon | Ant | Lev |
|---|---|---------------------------------|-----------------|-----|-----|
|  |  | 0gr 150_2H (1) Med Produktmerke | 07-500-500 | 1 | |
| |  | Brikke 150_2T(1) | 04-060-151 | 1 | |
| |  | Torx M8x35 (2) | 04-000-035 | 2 | |
| Forankring | Ant= 2 | Navn | Artnr/dimensjon | Ant | Lev |
| |  | Sekskant M8x70 | 04-008-070 | 6 | |
| |  | Brikke 50_1T(1) | 04-060-050 | 6 | |

Montering av lekeapparatet / Assembly instructions / Montering av lekredskapet

2x

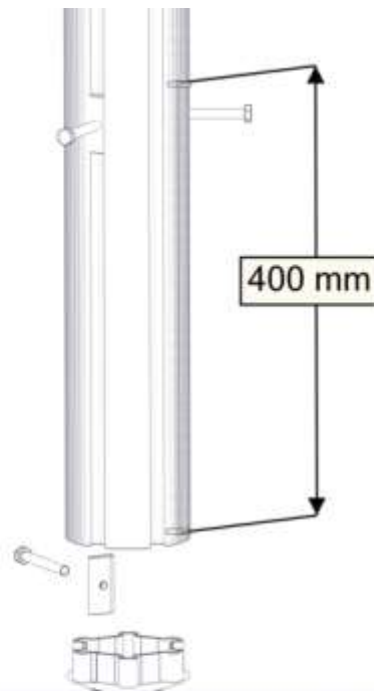

| nr | PartName | Artnr | Antall |
|----|-----------------------|------------|--------|
| 4 | | 07-100-333 | 1 |
| 3 | Brikke50 1XM8 | 04-060-050 | 3 |
| 1 | Sekskant M8x70 | 04-008-070 | 3 |
| 2 | Endelokk 110 med hull | 00-400-996 | 1 |

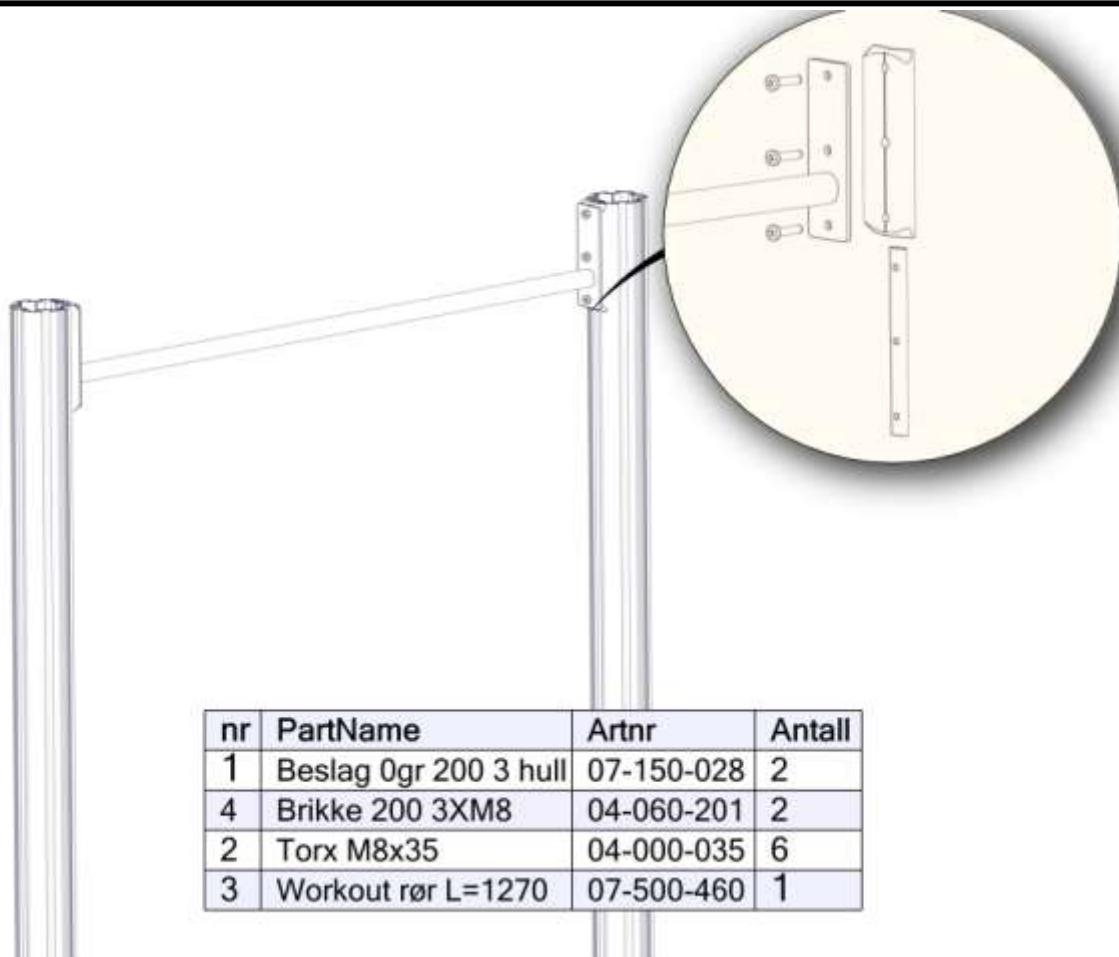

| nr | PartName | Artnr | Antall |
|----|-----------------------|------------|--------|
| 1 | Beslag 0gr 200 3 hull | 07-150-028 | 2 |
| 4 | Brikke 200 3XM8 | 04-060-201 | 2 |
| 2 | Torx M8x35 | 04-000-035 | 6 |
| 3 | Workout rør L=1270 | 07-500-460 | 1 |

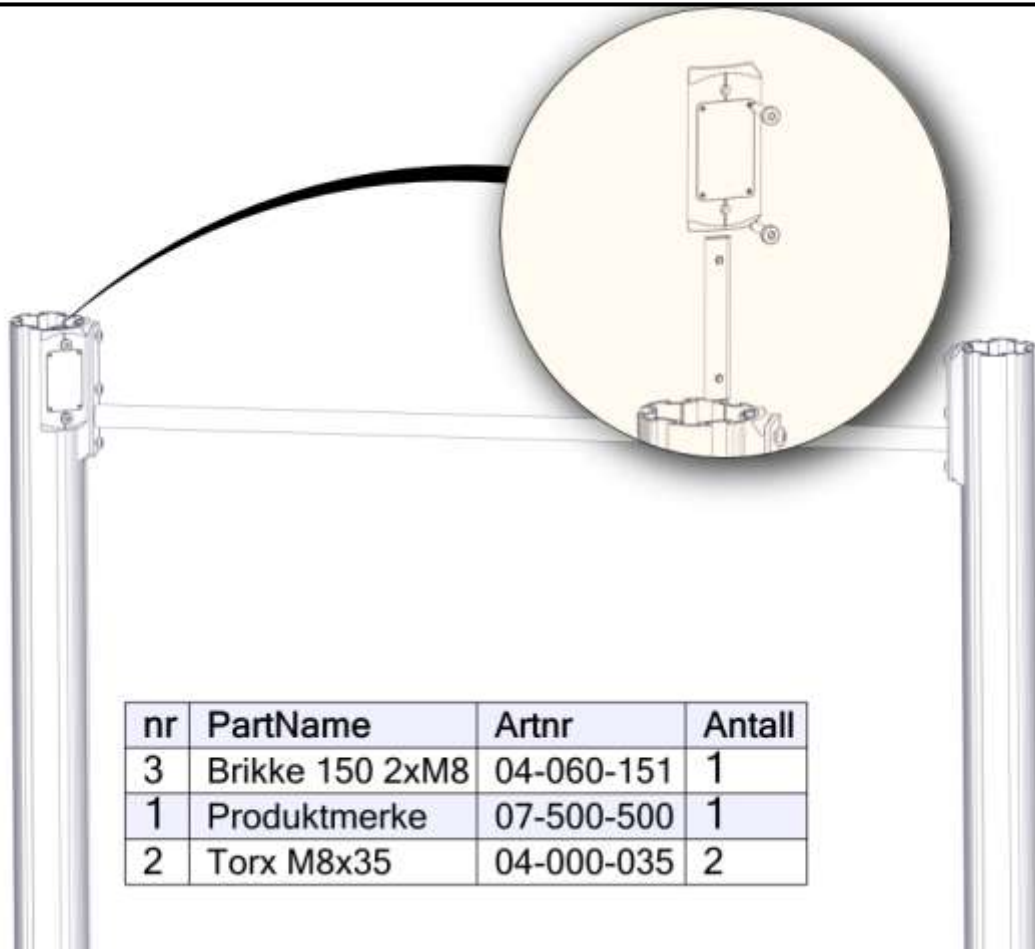









| nr | PartName | Artnr | Antall |
|----|-----------------|------------|--------|
| 3 | Brikke 150 2xM8 | 04-060-151 | 1 |
| 1 | Produktmerke | 07-500-500 | 1 |
| 2 | Torx M8x35 | 04-000-035 | 2 |



| nr | PartName | Artnr | Antall |
|----|--------------|------------|--------|
| 1 | Endelokk 110 | 00-400-995 | 2 |



| Før utstyret tas i bruk / Before play begins / Innan lekredskapet tas i bruk | |
|---|--|
| N | <ul style="list-style-type: none"> ● Påse at fallunderlag er utlagt i henhold til gjeldende regler eller vår anbefaling ● Fjern alle monteringshjelpemidler (rester av betong, planker, paller, plast, og lignende) ● Før utstyret tas i bruk, burde man sjekke at det ikke er fare for at anorakksnorer og lignende som kan hekte seg fast noen steder på lekeapparatet. (Vedlagte snor med dobbe (kneledd) kan brukes til å sjekke at dette er i orden. Se vedlagte veiledning for bruk av denne. Dette gjøres for å oppdage eventuelle feilmonteringer.?) ● NB! Bor stå i 2-3 dager før bruk |
| EN | <ul style="list-style-type: none"> ● Make sure the area and depth of safer surfacing are according to the current standard, or to the manufacturer's recommendation ● Make sure all tools and surplus materials are removed before play begins ● PS! When complete, allow 2-3 days for the concrete to set before use |
| S | <ul style="list-style-type: none"> ● Kontrollera att fallunderlag är utlagt enligt gällande regler eller vårt rekommendation ● Ta bort alla monteringshjälpmedel (rester av betong, plankor, pallar, plast och liknande) ● Innan lekredskapet används, kontrollera att anoracksnoddar eller kläder/delar av kläder eller liknande inte kan fastna i några delar på redskapet. (Den bipackade "knävringen" kan man med fördel användas för denna kontroll. ● Detta görs för att upptäcka eventuella felmonteringar.) |

| komponenter | | Sign. _____ |
|--|--|-------------|
|  <p>Torx M8x35 8 04-000-035</p> |  <p>Brikke 50-1T 6 04-060-050</p> <p>Brikke 200-3xM8 2 04-060-200</p> <p>Brikke 150-2T 1 04-060-151</p> | |
| |  <p>Workout rør 1 L=cc1400 3HULL!! 07-500-460</p> | |
| |  <p>Beslag 0gr 2 200_3H 07-150-028</p> | |
|  <p>Stolpe 110 2 800-2450 L=3250 07-100-333</p> |  <p>Endelokk 2 00-400-995</p> <p>Endelokk med hull 2 00-400-996</p> | |
|  <p>Produktmerke 1 07-500-500</p> |  <p>Sekskant M8x70 6</p> | |
| | | |
| | | |