

N

Monteringsanvisning

EN

Assembly Instructions

S

Monteringsanvisning

Produkt nr. / Product no. / Produkt nr.

16-102-370**Grønn / Grå**

Ord. nr. _____

Dato. _____

Sign. _____

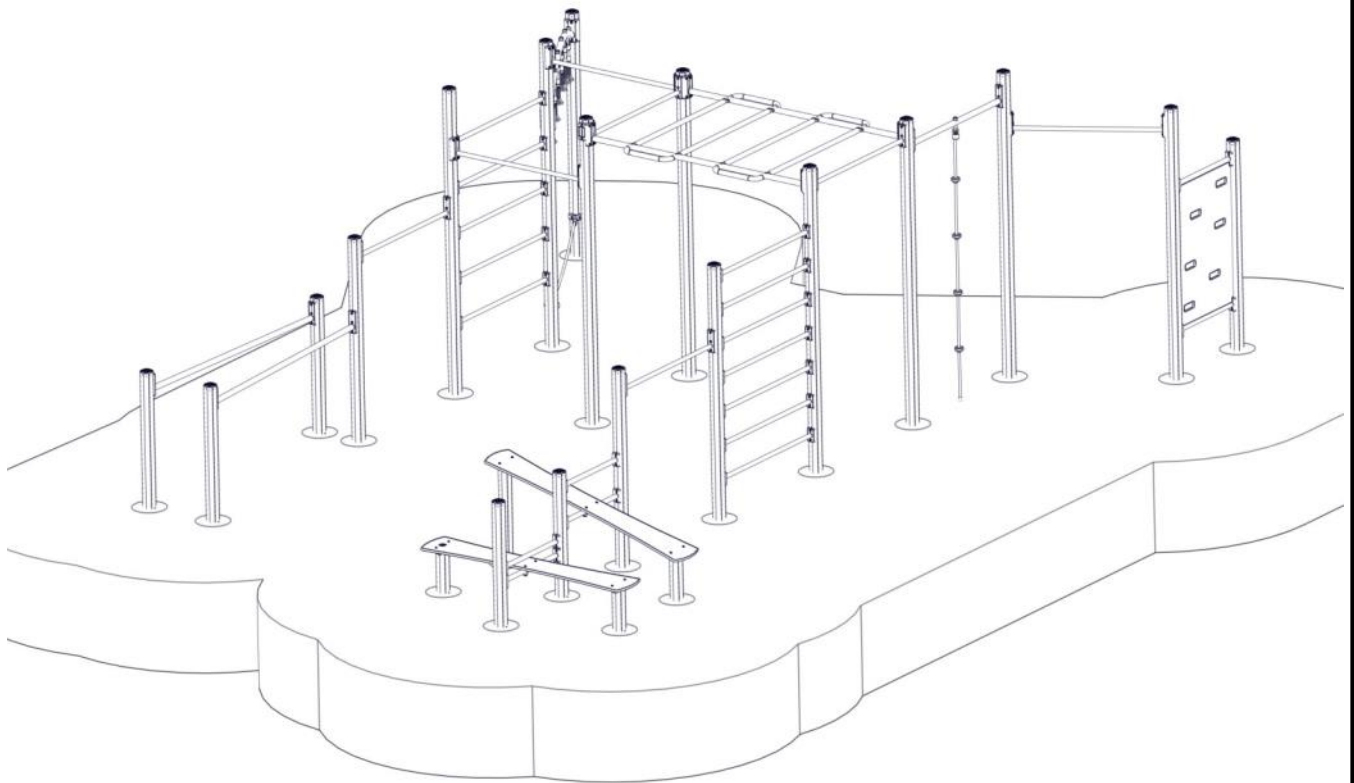
**søve**

Søve AS
Grønnvoldveien 290
3830 Ulefoss - Norway
Tlf: +47 35 94 65 65
www.sove.no



Søve AB
EA Rosengrensgatan 32
421 31 Västra Frölunda
Phone: +46 (0)31 773 97 00
www.sove.se

Monteringstips / Assembly Advice / Monteringsstips

N

- Les monteringsanvisningen nøye før montering.
- Monter elementene i rekkefølgen som vist.
- Boltene bør ikke skrues for hardt til før alt er montert, vatret og loddet. Skru så boltene til.
- NB! Ved bruk av drill, kan boltene ryke.
- På grunn av at solen kan gjøre rutsjeflaten veldig varm, bør rutsjebanens utløp vende mot nord-øst eller nord-vest.
- Er lekeutstyret plassert i naturlige ferdselstraséer må området sikres mot gjennomgang.
- Innspringningshinder bør vurderes rundt lekeapparater hvor det er stor bevegelse, f.eks. ved huskestativ.
- Det bør være fritt innsyn til lekeutstyr som er beregnet for barn under 3 år.

NB! Under monteringsarbeidet må utstyr, som ikke er forankret forsvarlig i bakken, sikres slik at det ikke velte.

Området må avstenges under montering av apparatene med sperrebånd eller lignende.

EN

- Read the instruction carefully before assembling the play unit.
- Assemble the components in the sequence shown in these instructions. Fixings must not be fully tightened during assembly. Before casting the foundations, the structure must be level and plumb, at which point all fixings are tightened. PS! If use of drill, the bolts may be wrecked.
- Avoid positioning the slide facing due south because of overheating – ideal positions are facing north-east or north-west. Secure the construction-area to prevent people from walking through it.
- Consider installing barriers around play-equipment which gives rise to a lot of activity – i.e. swings.
- Ensure that clear vision is possible across the play area so that supervision is possible from any position, particularly where children under 3 years of age will be playing.

NB! During assembly of the equipment, ensure that all structures are securely propped, especially when left overnight. Also ensure that equipment is supported

Monteringstips / Assembly Advice / Monteringsstips**S**

- Läs monteringsanvisningen noga före montering.

- Montera delarna i den ordningen som anvisas
- Skruvarna bör inte skruvas för hårt tills allt är monterat, i våg och lodat.









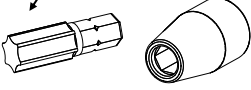

OBS! Används elektrisk skruvdragare, kan bulten gå sönder. Hårdra därför manuellt!

- Solen kan göra att rutchbanan blir väldigt varm. Banans nedfart rekommenderas att vändas i norrlig riktning
- Om lekplatsen placeras vid en gångväg mm bör området säkras mot genomfart av gående och cyklister.
- Insprängningshinder bör placeras runt lekutrustning med stor rörelse, t ex, gungställning.
- Det bör vara fri insyn till lekutrustning beräknat till barn under 3 år.

OBS! Under monteringsarbete bör utrustningen som inte ska förankras i marken, ställs så att den inte kan välta.

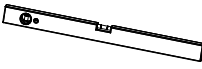
Området måste spärras när lekutrustningen byggs upp, med avspärrningsband eller liknande.

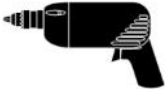
Nødvendig verktøy / Tools required / Nödvändiga verktyg



<p>(N)</p> <p>(EN)</p> <p>(S)</p>	<p>(A)</p> 	<p>(B)</p>  <p>Torx Nr 45 High quality</p> 	<p>(C)</p>  <p>13 + 17mm</p> 	<p>(D)</p> 	<p>(E)</p> 
		<p>Metermål Metric measure Tumstock</p> 	<p>16 V</p> 	<p>Merkebånd Mark ribbon Märkeband</p> 	<p>5 mm 6 mm</p> 

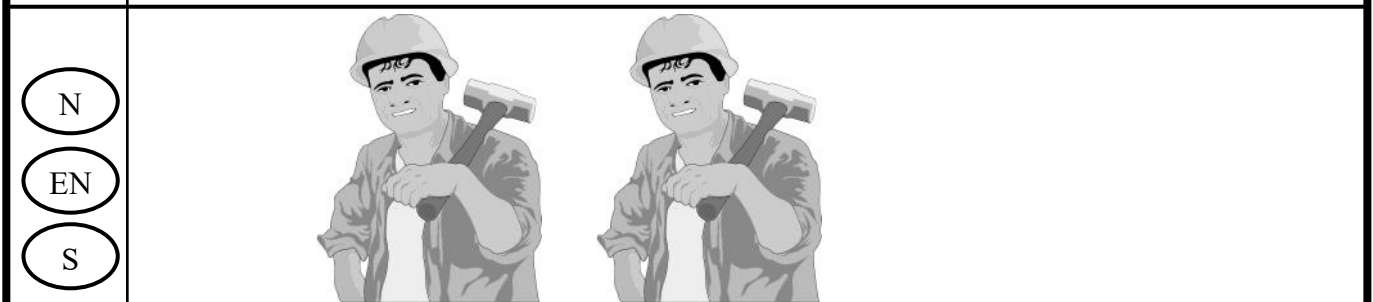



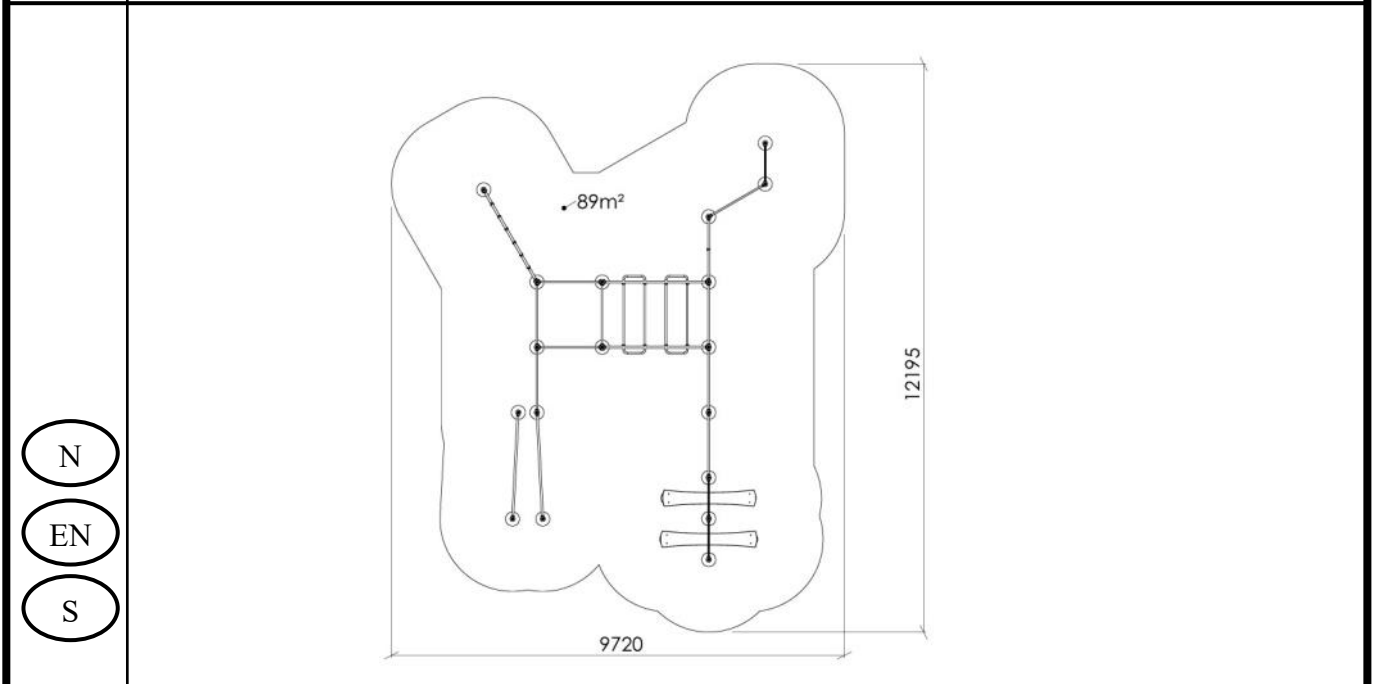

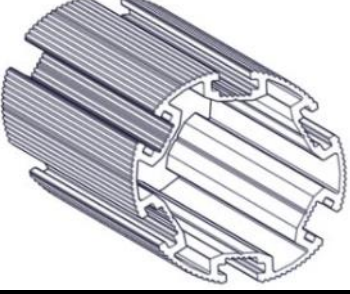
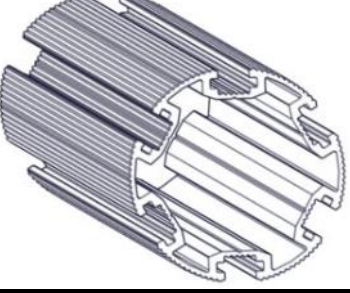
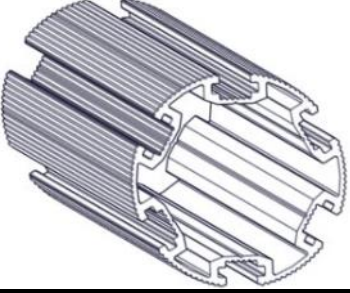
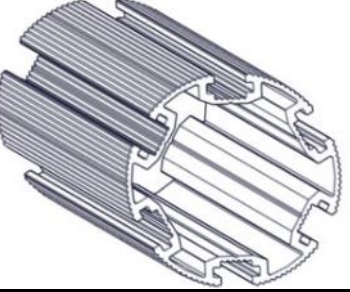
Nødvendig antall personer / Number of persons required / Rekommenderad antal personer



Anbefalt arealbehov ved montering / Recommended working space / Rekommenderad arealbehov vid montering







Boltepakker for / Boltpackage for / Bultpaket för		Sign. _____		
Grønn-Grå 16-102-370	Navn	Artnr/ dimensjon	Ant	Lev
	Stolpe Ø110 L=3300 (2700-600)	SFA5126/2	7	
	Stolpe Ø110 L=2850 (2250-600)	SFA5126/2	1	
	Stolpe Ø110 L=2400 (1800-600) Grå	SFA5126/2	1	
	Stolpe Ø110 L=2350 (1750-600)	SFA5126/2	1	
	Stolpe Ø110 L=1800 (1200-600)	SFA5126/2	3	
	Stolpe Ø110 L=1700 (1100-600) Grå	SFA5126/2	2	
	Stolpe Ø110 L=1508 skrå (908-600)	07-100-361	1	
	Stolpe Ø110 L=1040 skrå (440-600)	07-100-363	1	
	Stolpe Ø110 L=1000 (400-600) Grå	SFA5126/2	2	
	Stolpe Ø110 L=2750 (2150-600)	SFA5126/2	1	
	Stolpe Ø110 L=3000 (2700-600)	SFA5126/2	1	
	Stolpe Ø110 L=2450 (1850-600)	SFA5126/2	1	
	Workout rør cc1400 0gr Grønn	07-200-162K (Se egen del- montering)	12	
	Workout rør L=1270mm 30gr 200 Beslag Grønn	07-200-174K (Se egen del- montering)	2	

Boltepakker for / Boltpackage for / Bultpaket för		Sign. _____		
Grønn-Grå 16-102-370	Navn	Artnr/ dimensjon	Ant	Lev
	Workout rør Ø33 L=1270 0gr Grønn	07-200-169K (Se egen del- montering)	5	
	Sperrerør rett workout 30gr beslag cc650 Sort	07-500-081K (Se egen del- montering)	1	
	Sperrerør rett workout 30gr beslag cc400 Sort	07-500-082K (Se egen del- montering)	1	
	Workout rør 0gr Ø44,5 L=2160 CC400-650 Venstre Grønn	07-200-189K (Se egen del- montering)	1	
	Workout rør 0gr Ø44,5 L=2160 CC400-650 Høyre Grønn	07-200-188K (Se egen del- montering)	1	
	Sperrerør 0gr sittebrett L=750 Grønn	07-200-127K (Se egen del- montering)	1	



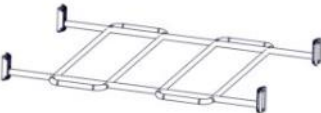

Boltepakker for / Boltpackage for / Bultpaket för



Sign. _____

Grønn-Grå 16-102-370	Navn	Artnr/ dimensjon	Ant	Lev
	Sperrerør med 15gr beslag, sittebrett L=750 Grønn	07-200-126K (Se egen del- montering)	1	
	Situp Brett 0gr komplett Grå	07-200-122K (Se egen del- montering)	2	
	Sperrerør rett uten hull Komplett L=750 Grønn	07-500-059K (Se egen del- montering)	2	
	Produktmerke	07-500-500	1	
	Endelokk til stolpe Ø110	00-400-995	18	
	Workoutbro inkl 30gr beslag Grønn	07-200-176K (Se egen del- montering)	1	

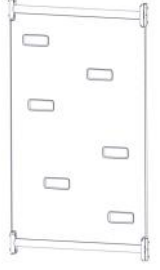
Boltepakker for / Boltpackage for / Bultpaket för

Sign. _____

Grønn-Grå 16-102-370	Navn	Artnr/ dimensjon	Ant	Lev
	Balansetau inkl 30gr beslag L=2,156 meter	07-500-029K (Se egen del- montering)	1	
	Armgang med Polifix hantak inkl 30gr beslag Grønn	07-500-454K (Se egen del- montering)	1	
	Workoutrør 44mm L=1400 0gr Med hull Grønn	07-200-155K (Se egen del- montering)	1	
	Buldervegg 1250x795 Grønn	07-500-402K (Se egen del- montering)	1	
	Workout klatretau Svart	07-200-159K (Se egen del- montering)	1	

Boltepakker for / Boltpackage for / Bultpaket för		Sign. _____		
Grønn-Grå 16-102-370	Navn	Artnr/ dimensjon	Ant	Lev
	Støp fundament			
	Fundament betong Ø110	00-003-111K (Se egen del- montering)	22	
	Overflate montering			
	Fundament 1xØ110 for Betongdekk Ekstra	00-003-137K (se egen del- montering)	22	
	Stolpe kappes	SFA5126/1	(22)	
	Korte bolter Torx M8x25	04-000-025	16	

Fundamentering med betong / Foundation concrete / Förankring med betong

- (N) Støtdempende materialer
- (EN) Impact attenuating materials
- (S) Støtdämpande material Ref NS-EN 1176-1 §4.2.8.5



- (N) Bakkenivå
- (EN) Ground level
- (S) Marknivå

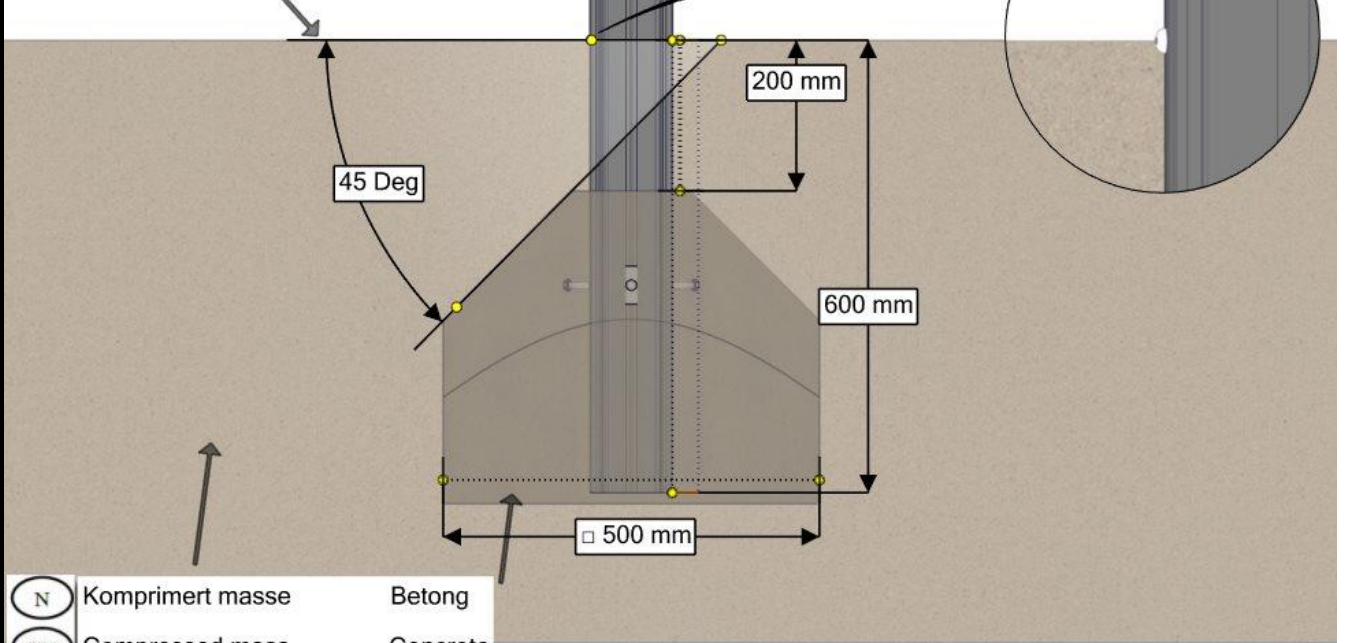

- (N) Komprimert masse Betong
- (EN) Compressed mass Concrete
- (S) Komprimerad massa Betong

Overflatemontering / Surface mounting / Ytmontering

Når du har overflatemonteringsfundamenter bruk korte skruer på nedeste festepunkter

If you are using 0-level anchors use short bolts for mounting lower parts

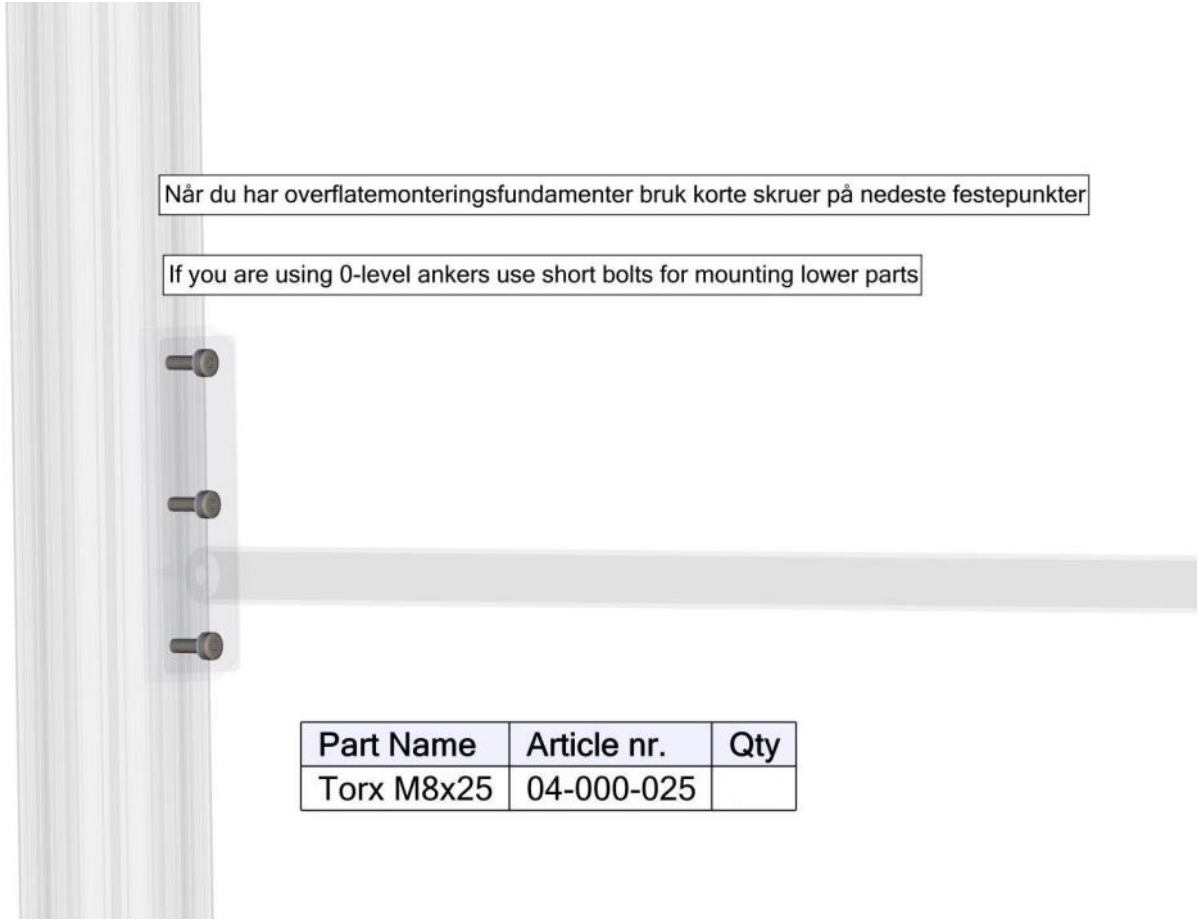

Part Name	Article nr.	Qty
Torx M8x25	04-000-025	

Ref
NS-EN 1176-1
§4.2.8.5

(N) (EN) (S)
Bakkenivå Ground level marknivå

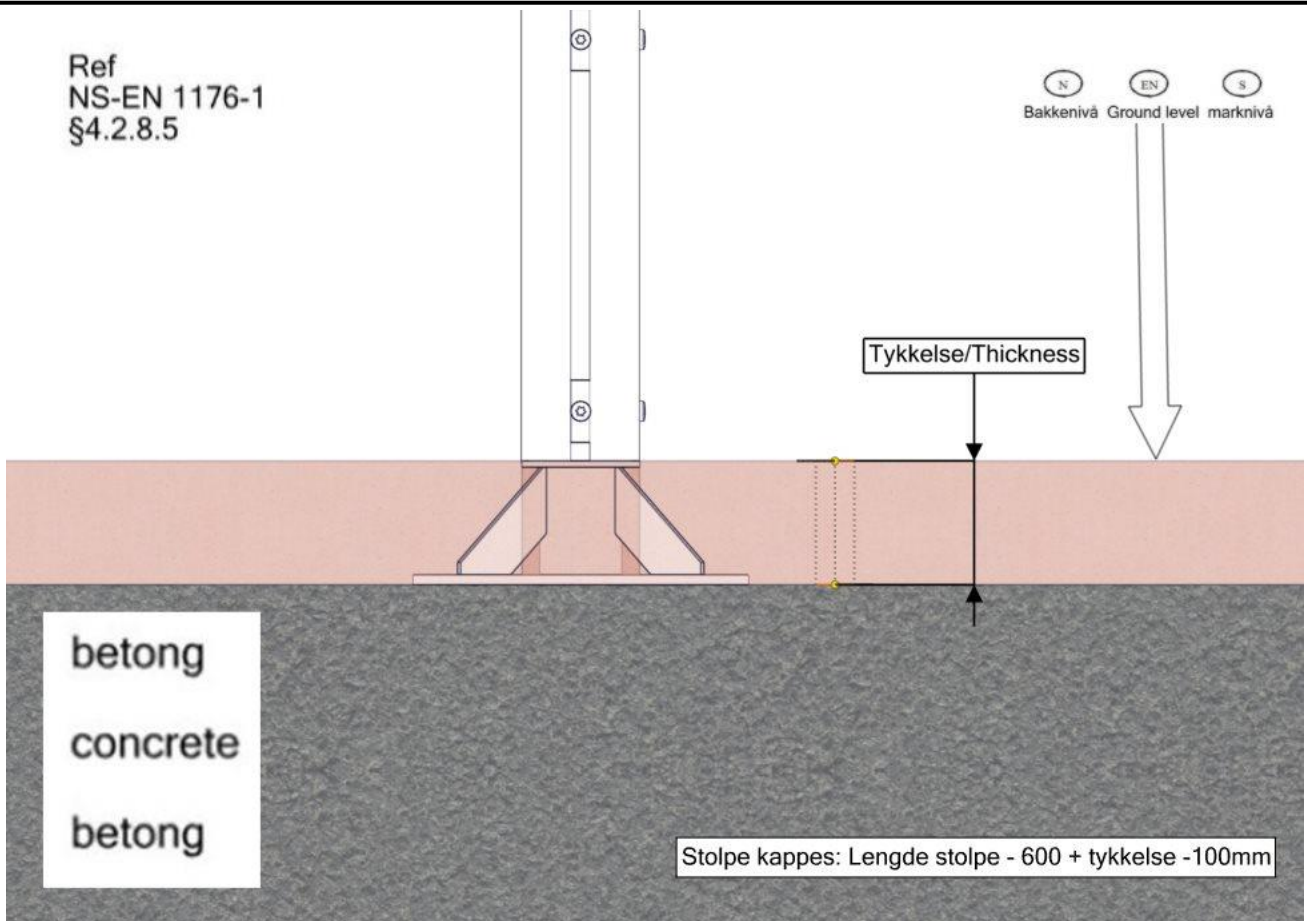

betong
concrete
betong

Stolpe kappes: Lengde stolpe - 600 + tykkelse - 100mm

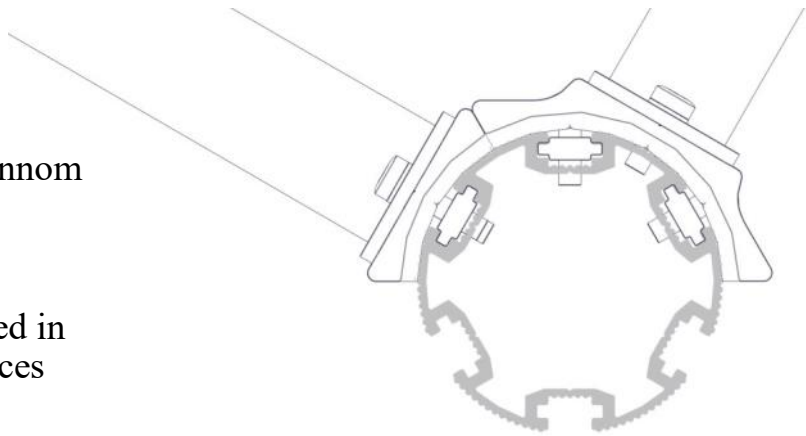
N	<p>Bolten skrues HELT igjennom aluminiumen. Maks moment: 30Nm</p>			
EN	<p>The bolt must be tightened in to the post, so that it peirces the aluminium Max torque: 30Nm</p>			
S	<p>Bulten skuvas HELT genom aluminiumen. Maks vridmoment: 30Nm</p>			
				
NO	Betongkvalitet	C25/30		
SE	Betongkvalitet			
EN	Concrete quality			
NO	Mengde betong		2,7	m ³
SE	Mängd betong			
EN	Amount of concrete			
NO	Fundament størrelse		0,5 x 0,5 x 0,6	m
SE	Stiftelsestorlek			
EN	Foundation size			
NO	For sikkerhet må fundamentene med sand eller myk jord være minst 50% større i areal			
SE	För säkerheten måste grunden med sand eller mjuk jord vara minst 50% större i området			
EN	For safety, the foundations with sand or soft soil must be at least 50% larger in area			
NO	Tyngste element	07-200-176	23	Kg
SE	Tyngsta element			
EN	Heaviest element			
NO	Største element	SFA5126/2 07-200-176	3,3x Ø 0,11 2,17x1,68x0,19	m
SE	Största element			
EN	Biggest element			

Fallhøyder / Free height of fall / Fallhöjder

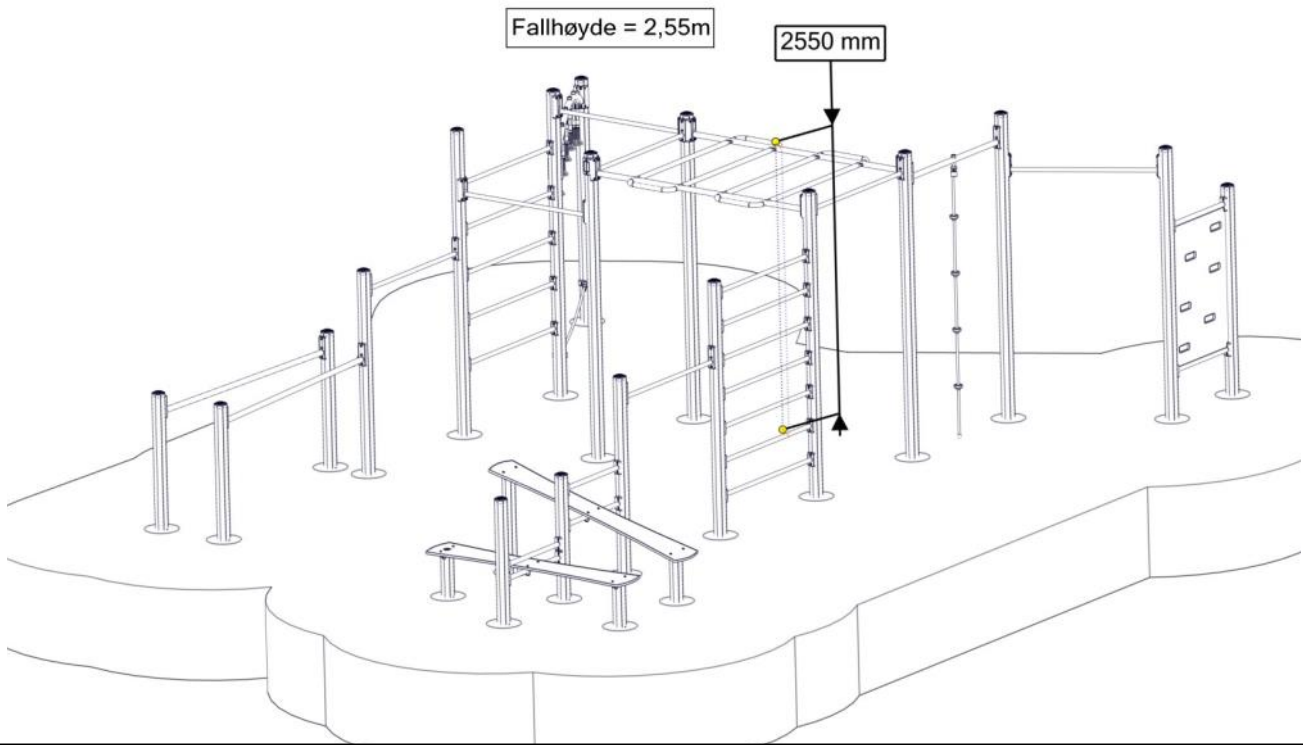

Sikkerhetszone / Safety zone / Säkerhetszon

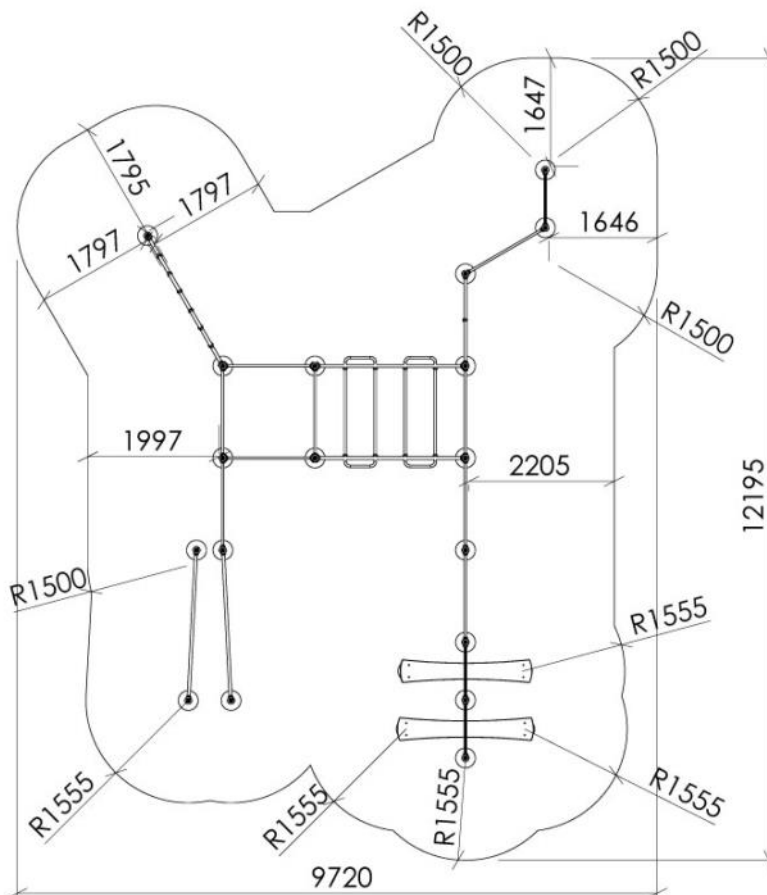

Plassering av forankringer / Ground plan / Placering av förankringar

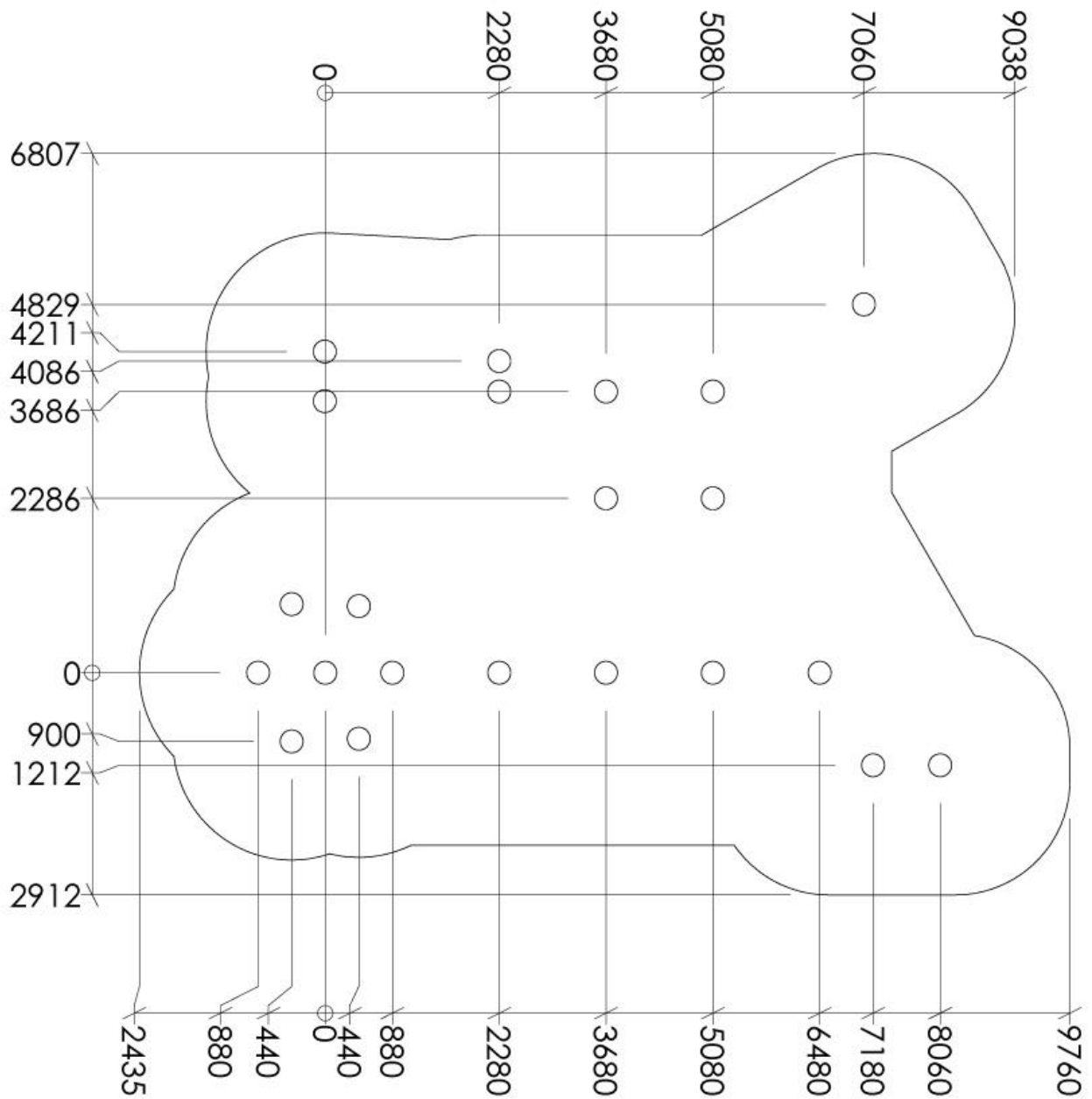

N

Alle mål er oppgitt i millimeter

EN

Scale measured in mm

S

Alla mått är i millimeter.

Montering av lekeapparatet / Assembly instructions / Montering av lekredskapet

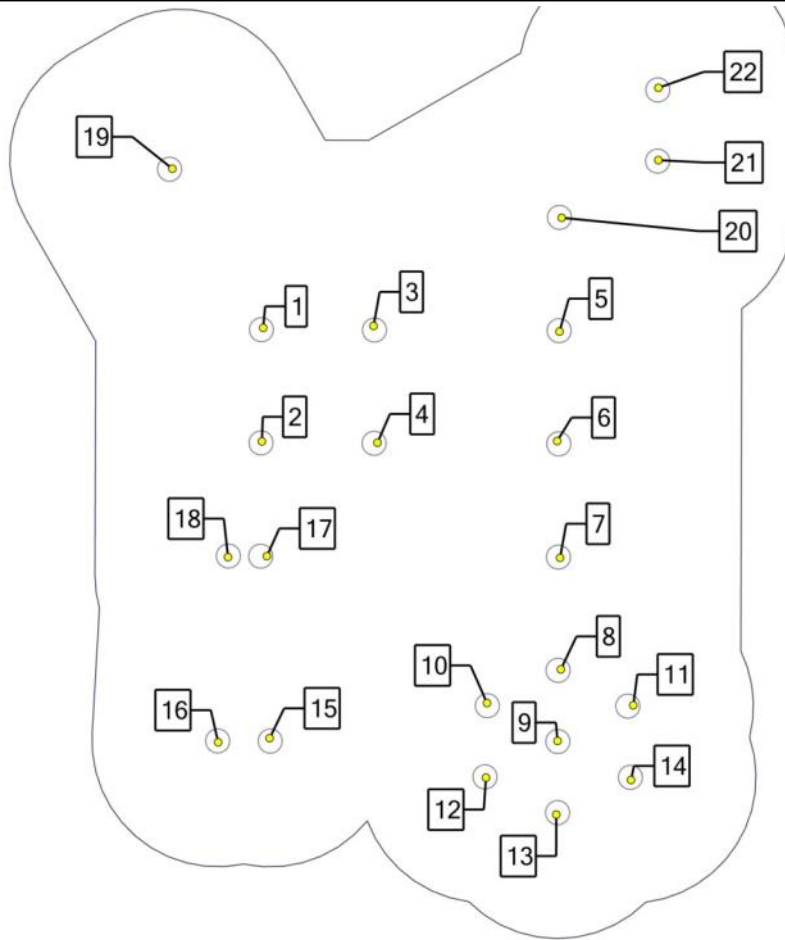

Se separat delmontering for detaljer
 See separate assembly for details
 Se separata delmontering för detaljer

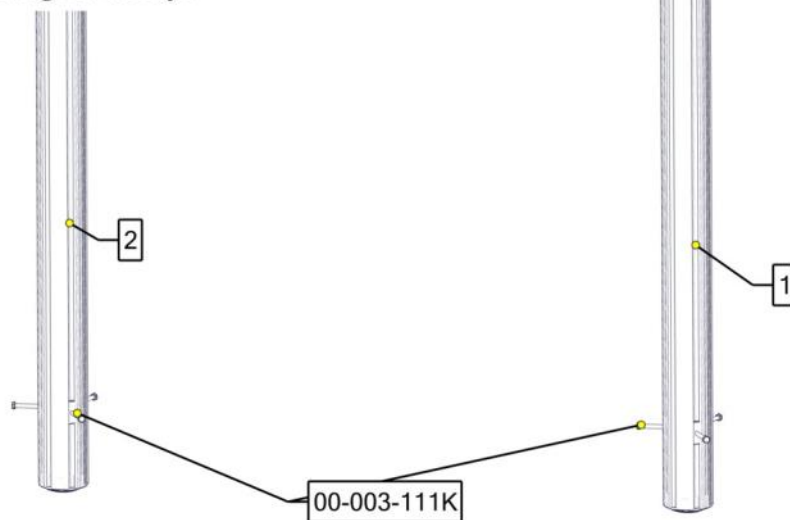

Part Name	Article nr.	Qty
Støpe fundament Ø 110	00-003-111K	2
Stolpe Ø110 L= 3300 (2700-600)	SFA5126/2	2

Se separat delmontering for detaljer
 See separate assembly for details
 Se separata delmontering för detaljer

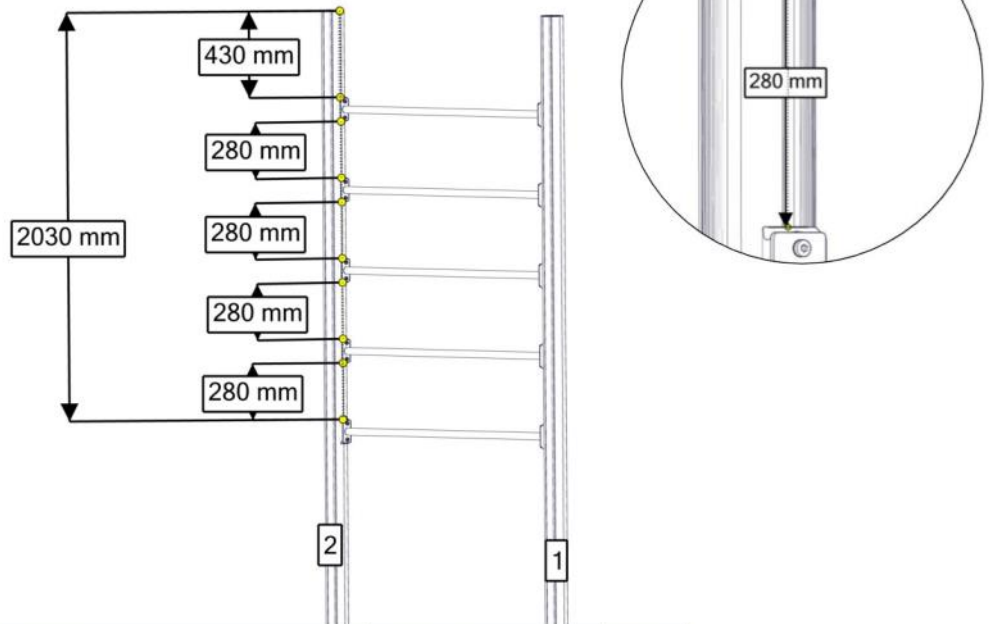

Part Name	Article nr.	Qty
Workout rør CC1400 0gr	07-200-162K	5

Se separat delmontering for detaljer
 See separate assembly for details
 Se separata delmontering för detaljer

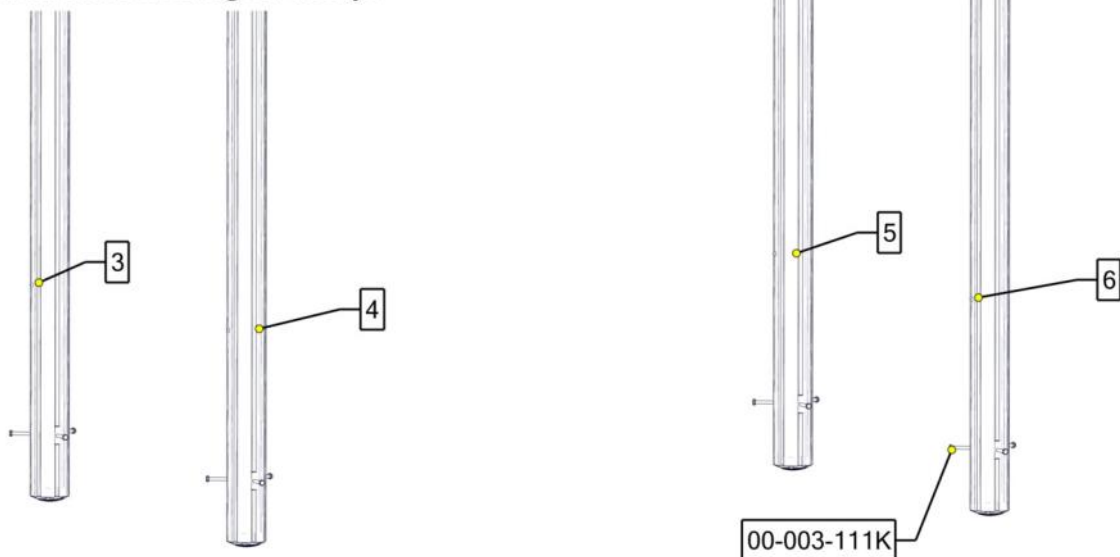

Part Name	Article nr.	Qty
Støpe fundament Ø 110	00-003-111K	4
Stolpe Ø110 L= 3300 (2700-600)	SFA5126/2	4

Se separat delmontering for detaljer
 See separate assembly for details
 Se separata delmontering för detaljer

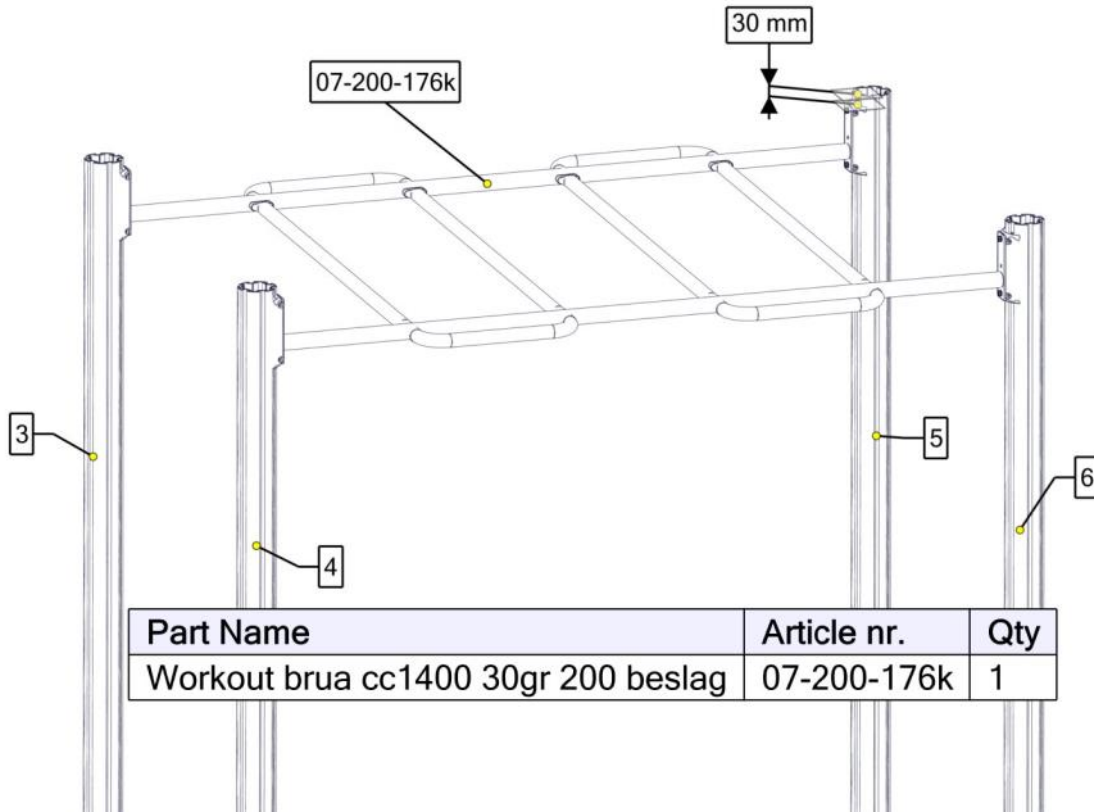

Part Name	Article nr.	Qty
Workout brua cc1400 30gr 200 beslag	07-200-176k	1

Se separat delmontering for detaljer
 See separate assembly for details
 Se separata delmontering för detaljer

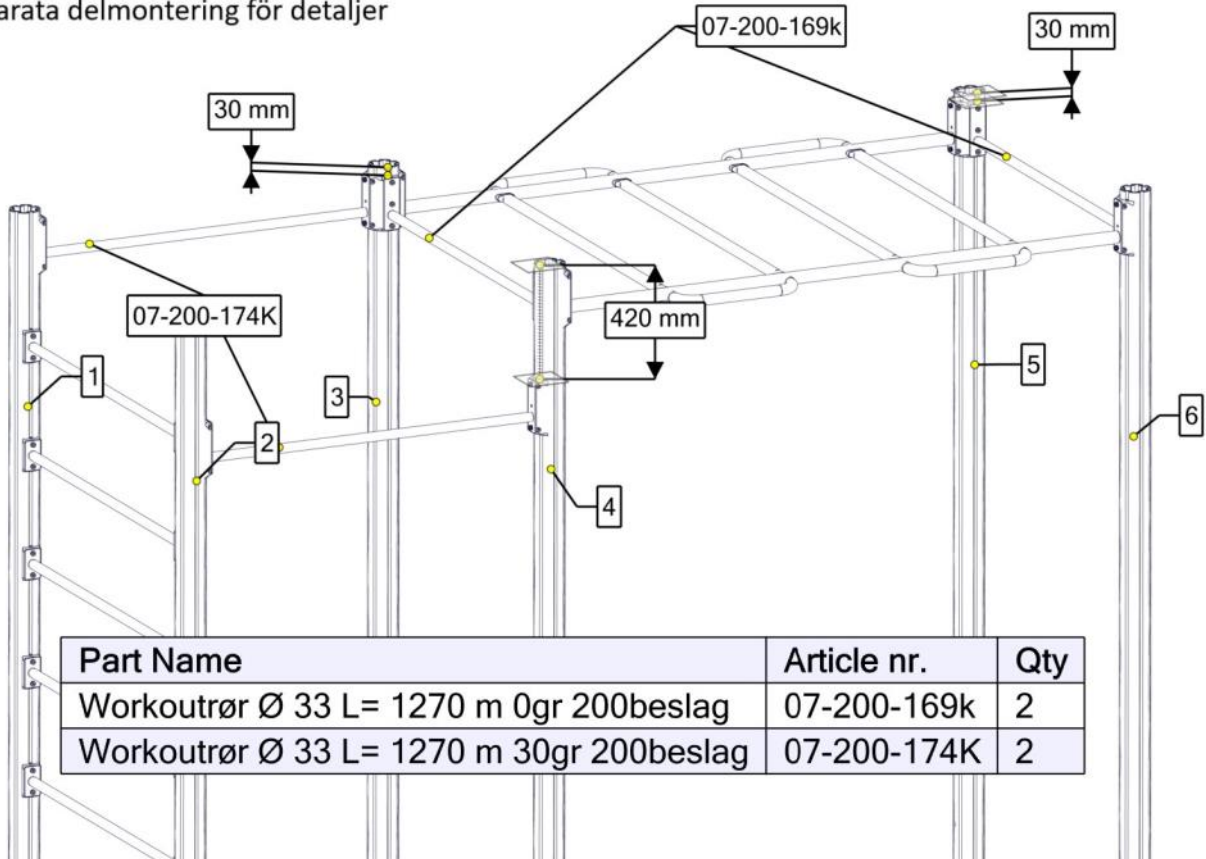

Part Name	Article nr.	Qty
Workoutrør Ø 33 L= 1270 m 0gr 200beslag	07-200-169k	2
Workoutrør Ø 33 L= 1270 m 30gr 200beslag	07-200-174K	2

Se separat delmontering for detaljer
 See separate assembly for details
 Se separata delmontering för detaljer

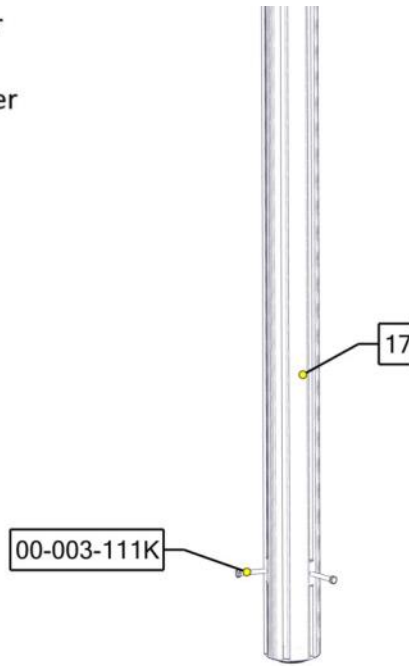

Part Name	Article nr.	Qty
Støpe fundament Ø 110	00-003-111K	1
Stolpe Ø110 Lengde=2400	SFA5126/2	1

Se separat delmontering for detaljer
 See separate assembly for details
 Se separata delmontering för detaljer

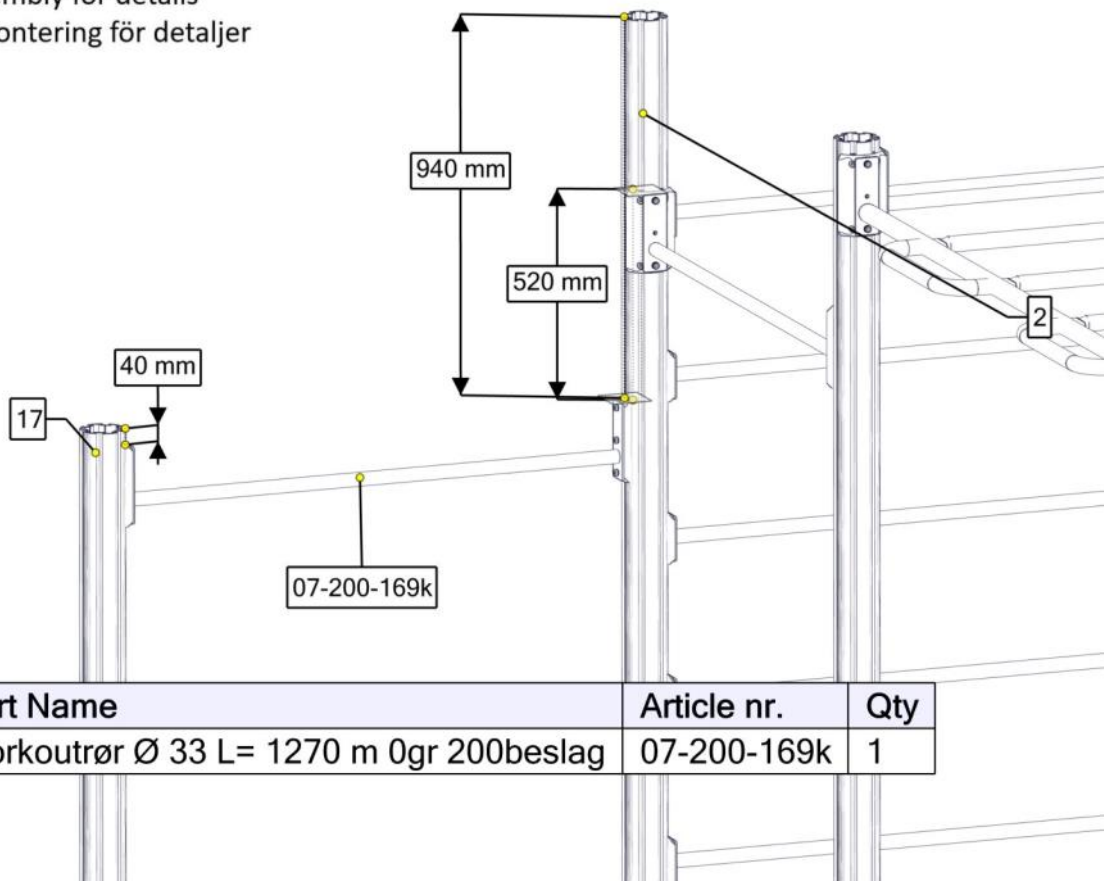

Part Name	Article nr.	Qty
Workoutrør Ø 33 L= 1270 m Ogr 200beslag	07-200-169k	1

Se separat delmontering for detaljer
 See separate assembly for details
 Se separata delmontering för detaljer

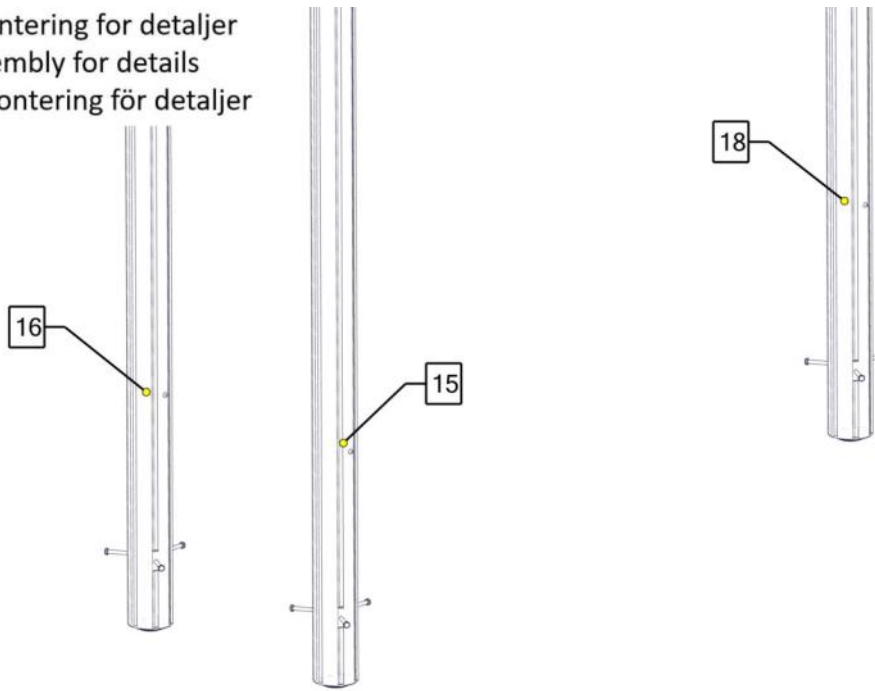

Part Name	Article nr.	Qty
Støpe fundament Ø 110	00-003-111K	3
Stolpe Ø110 L=1200-600	SFA5126/2	3

Se separat delmontering for detaljer
 See separate assembly for details
 Se separata delmontering för detaljer

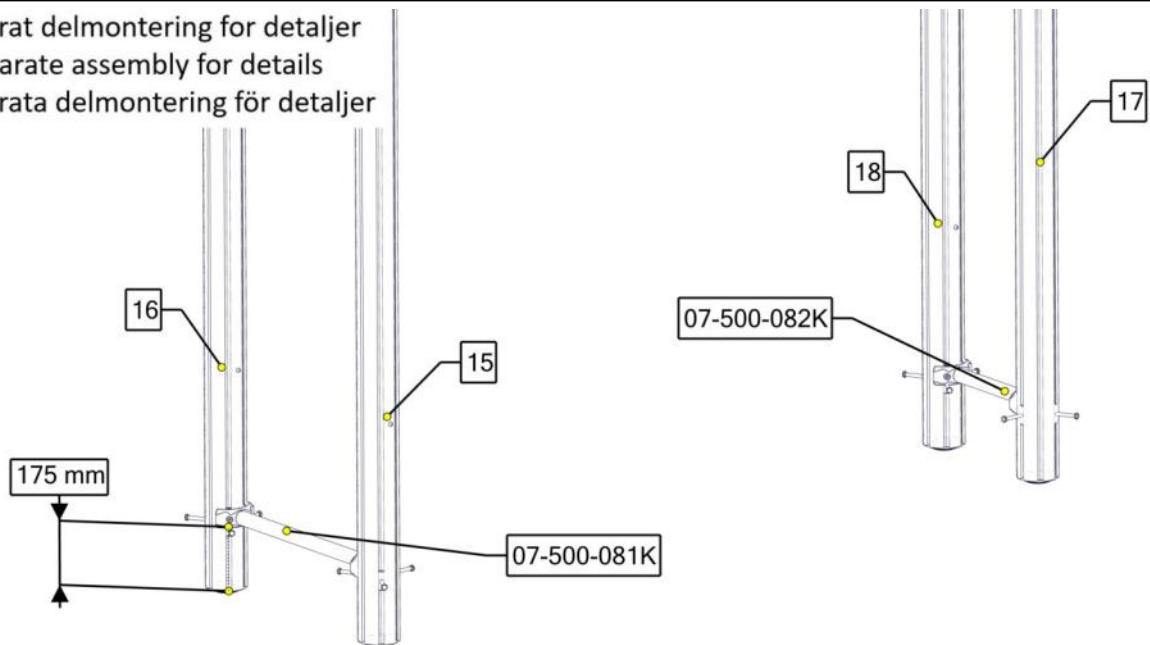

Part Name	Article nr.	Qty
sperreror_Rett_workout 30gr cc400	07-500-082K	1
sperreror_Rett_workout 30gr cc650	07-500-081K	1

Se separat delmontering for detaljer
 See separate assembly for details
 Se separata delmontering för detaljer

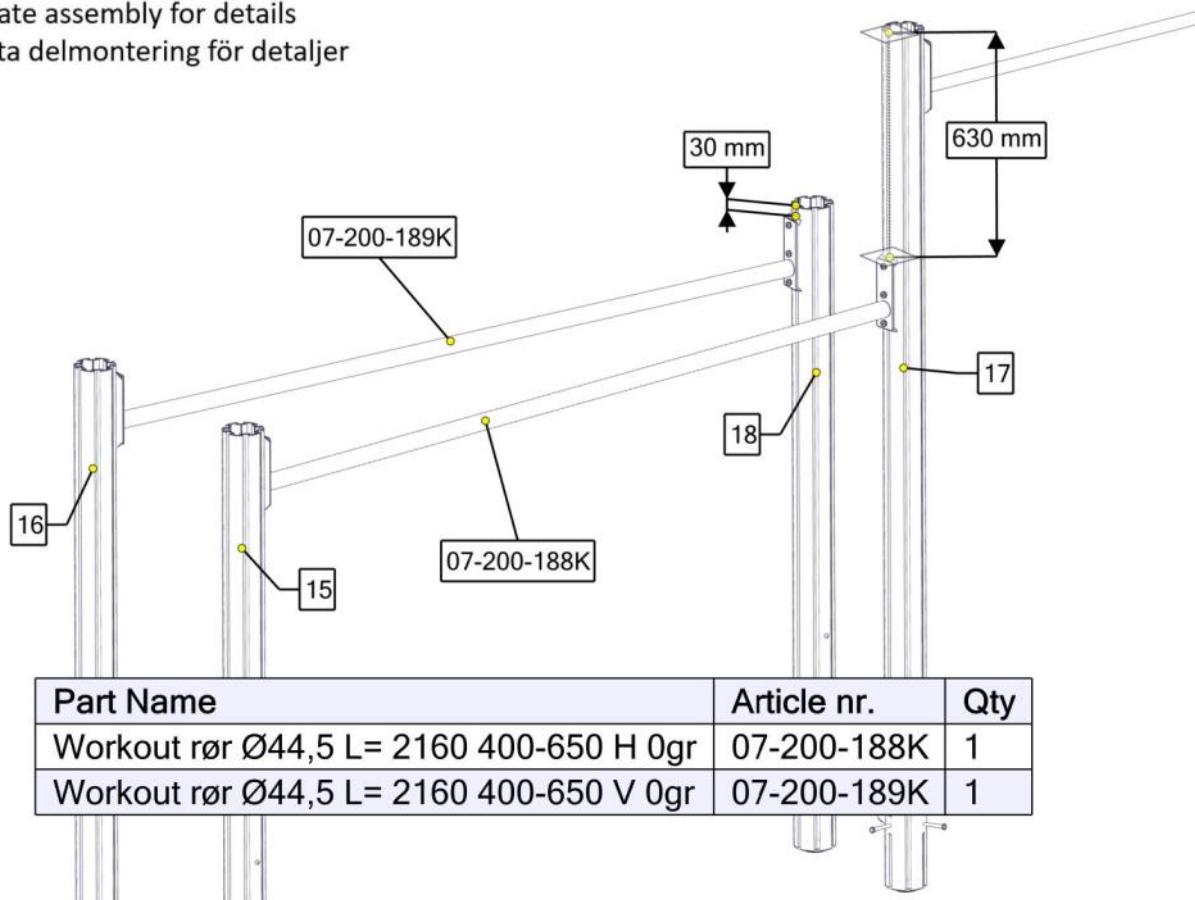

Part Name	Article nr.	Qty
Workout rør Ø44,5 L= 2160 400-650 H 0gr	07-200-188K	1
Workout rør Ø44,5 L= 2160 400-650 V 0gr	07-200-189K	1

Se separat delmontering for detaljer
 See separate assembly for details
 Se separata delmontering för detaljer

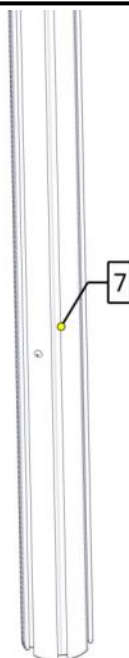

Part Name	Article nr.	Qty
Stolpe L=2850 (2250-600)	SFA5126/2	1

Se separat delmontering for detaljer
 See separate assembly for details
 Se separata delmontering för detaljer

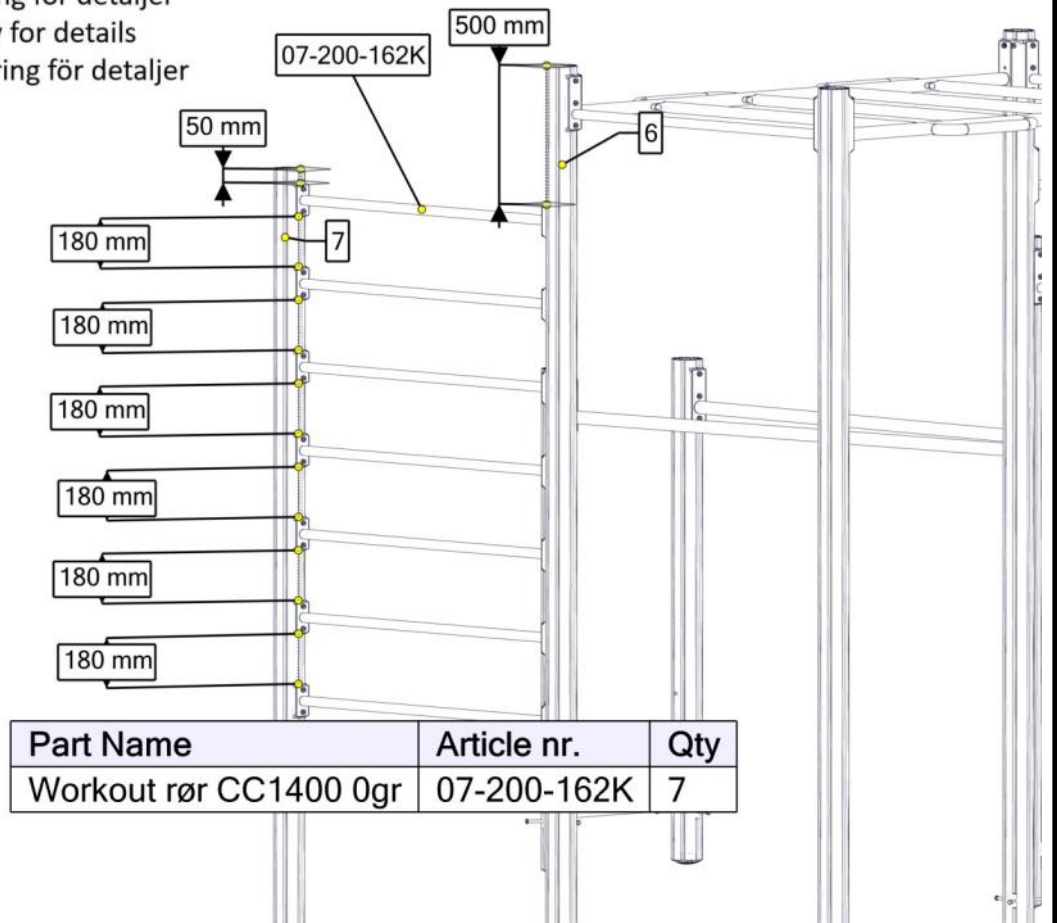

Se separat delmontering for detaljer
 See separate assembly for details
 Se separata delmontering för detaljer

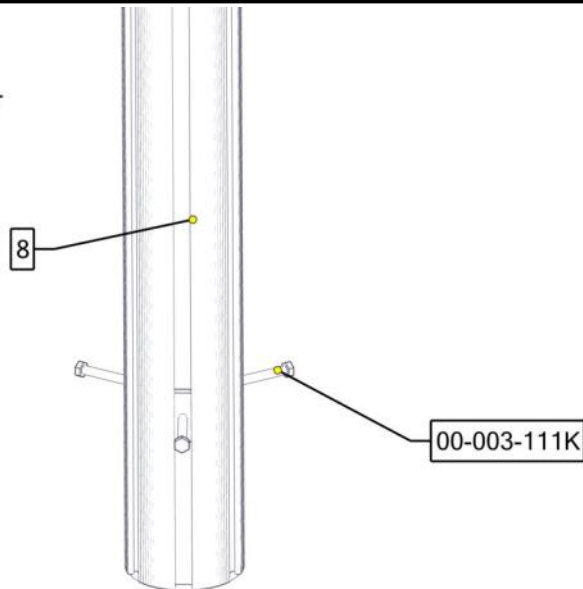

Part Name	Article nr.	Qty
Støpe fundament Ø 110	00-003-111K	1
Stolpe Ø110 L=2350 (600-1750)	SFA5126/2	1

Se separat delmontering for detaljer
 See separate assembly for details
 Se separata delmontering för detaljer

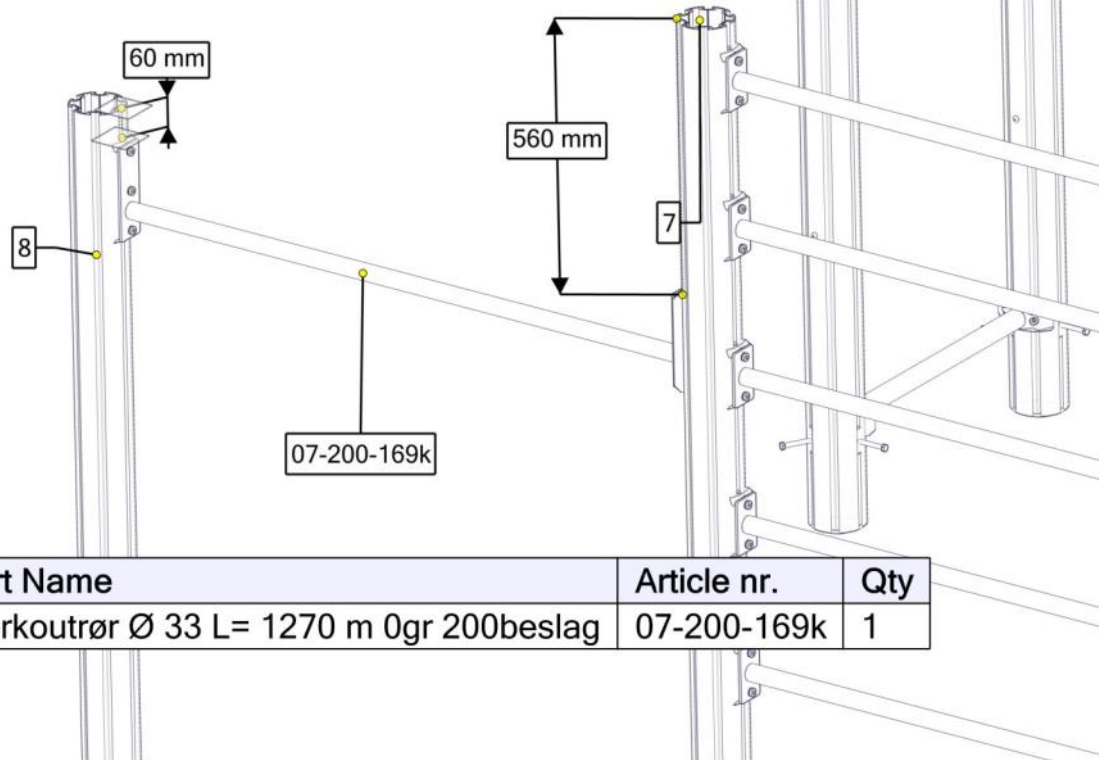

Part Name	Article nr.	Qty
Workoutrør Ø 33 L= 1270 m 0gr 200beslag	07-200-169k	1

Se separat delmontering for detaljer
 See separate assembly for details
 Se separata delmontering för detaljer

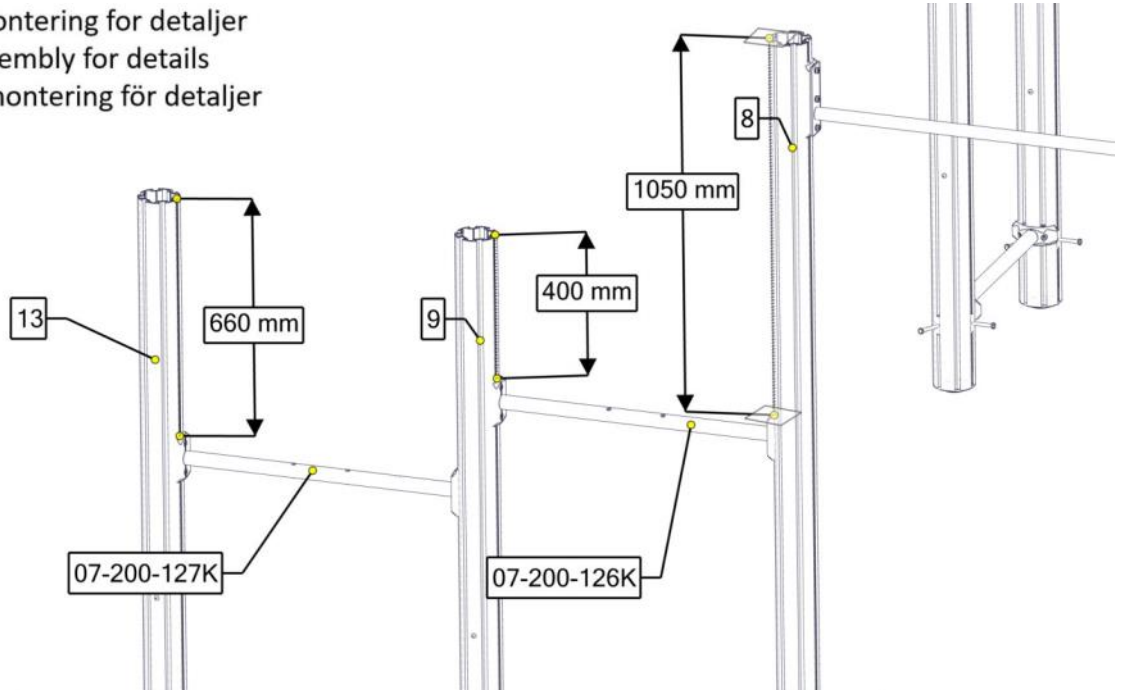

Part Name	Article nr.	Qty
Stolpe Ø110 L= 1700 (1100-600)	SFA5126/2	2
Sperrerør L=750 m 0gr sittebrett	07-200-127K	1
Sperrerør L=750 m 15gr sittebrett	07-200-126K	1

Se separat delmontering for detaljer
 See separate assembly for details
 Se separata delmontering för detaljer

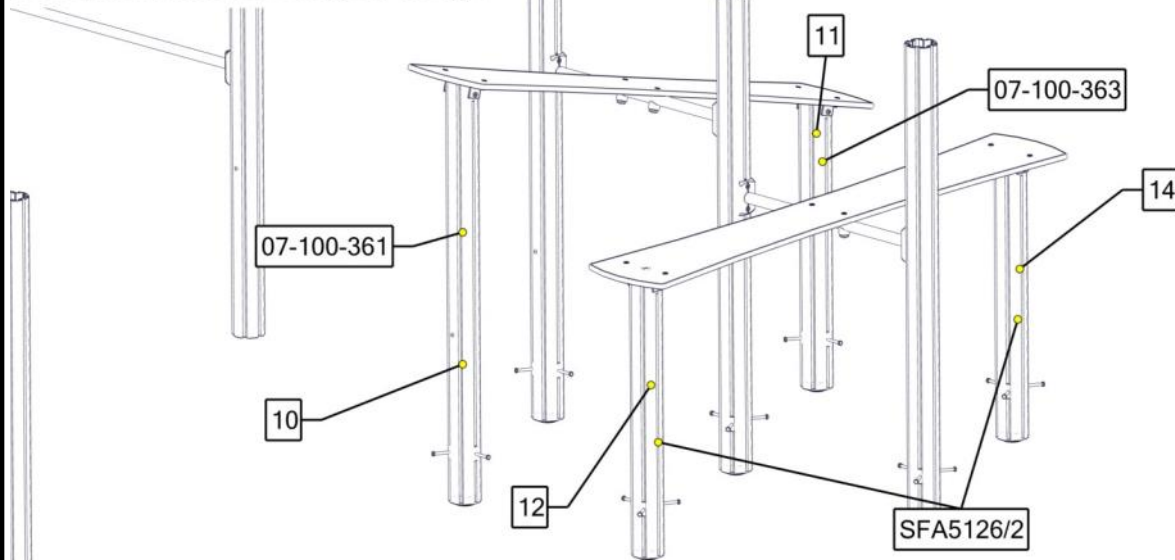

Part Name	Article nr.	Qty
Støpe fundament Ø 110	00-003-111K	4
Stolpe Ø110 Lengde = 1000 (400-600)	SFA5126/2	2
Stolpe 110 skrå 15gr 600-908 L=1508 grey	07-100-361	1
Stolpe 110 skrå 15gr 600-440L=1040 Grey	07-100-363	1
Sittup Brett 0gr komplett	07-200-122K	2

Se separat delmontering for detaljer
 See separate assembly for details
 Se separata delmontering för detaljer

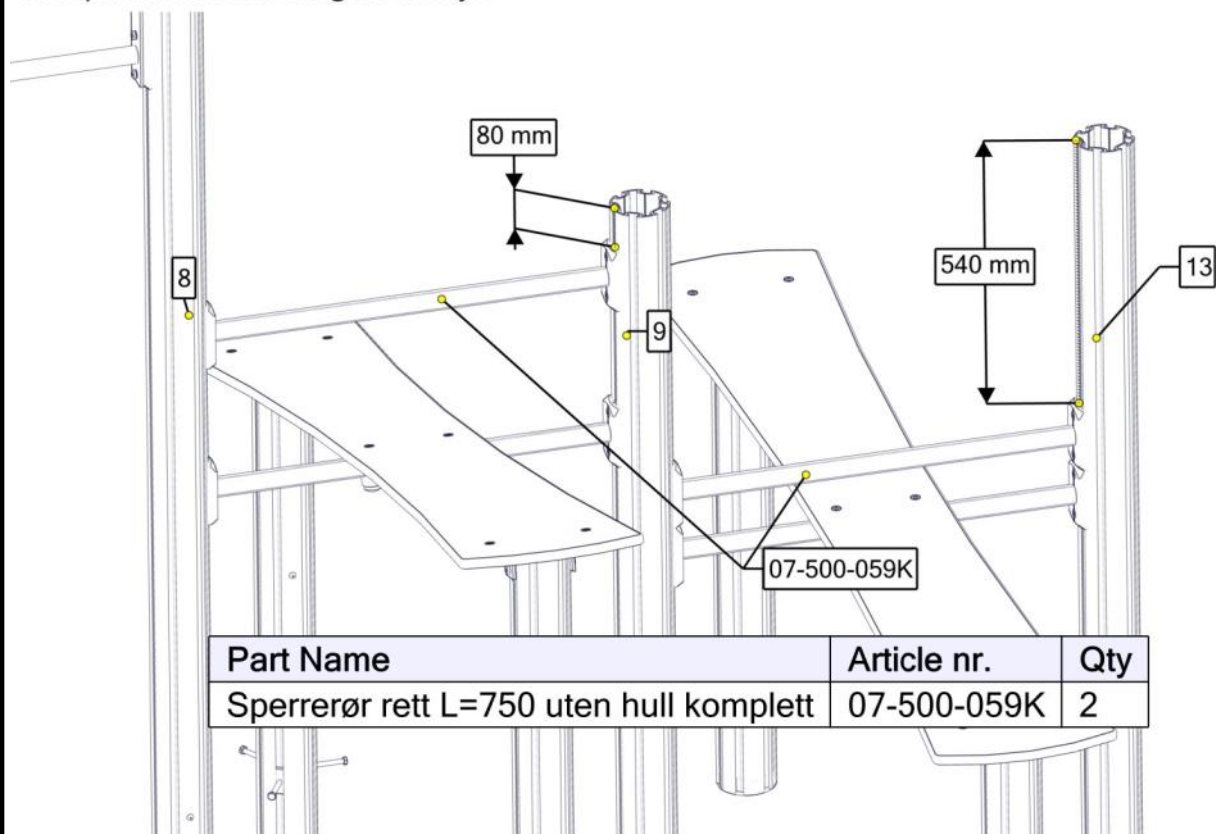

Part Name	Article nr.	Qty
Sperrerør rett L=750 uten hull komplett	07-500-059K	2

Se separat delmontering for detaljer
 See separate assembly for details
 Se separata delmontering för detaljer

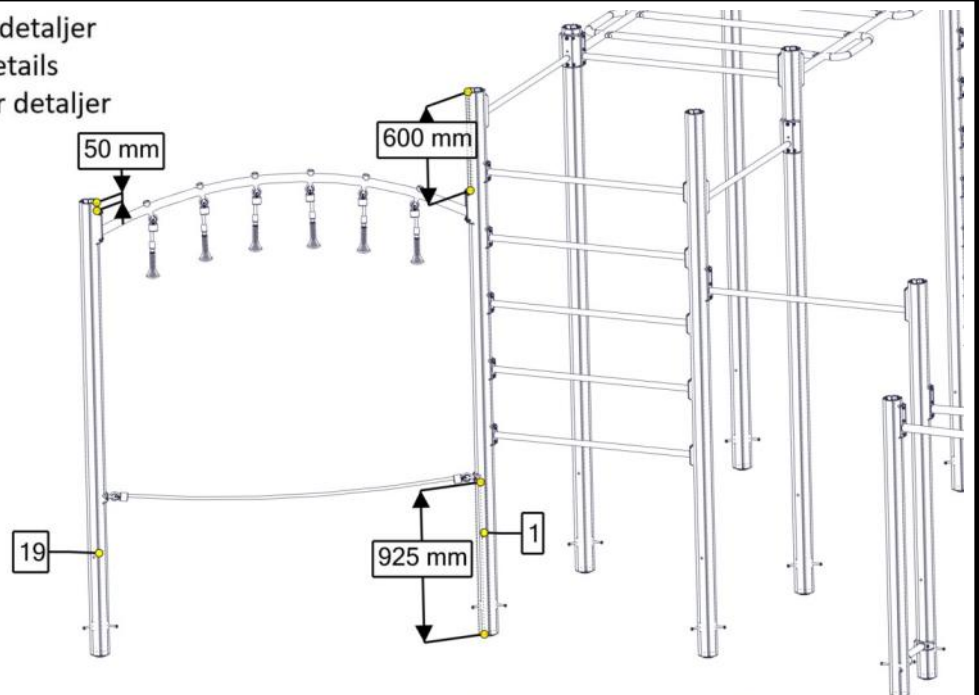

Part Name	Article nr.	Qty
Støpe fundament Ø 110	00-003-111K	1
Balansetau L=2156 inkl 30gr beslag	07-500-029K	1
Armgang med polifix handtak inkl 30gr beslag	07-500-454K	1
Stolpe Ø110 L=2750 (2150-600)	SFA5126/2	1

Se separat delmontering for detaljer
 See separate assembly for details
 Se separata delmontering för detaljer

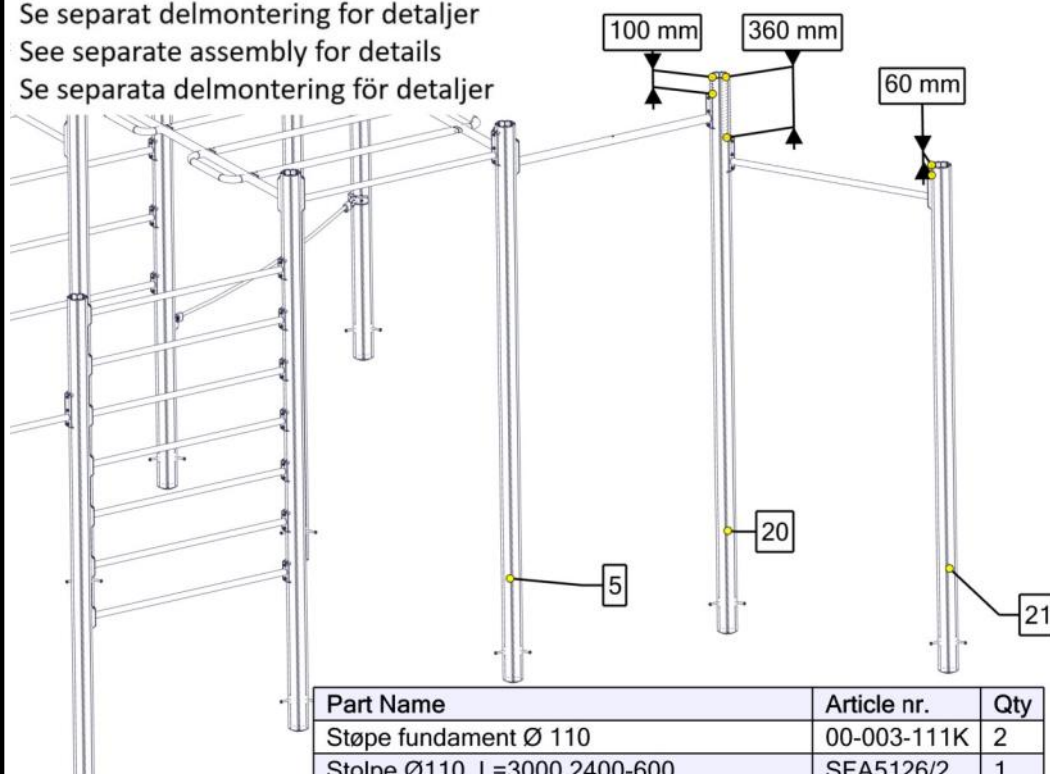

Part Name	Article nr.	Qty
Støpe fundament Ø 110	00-003-111K	2
Stolpe Ø110 L=3000 2400-600	SFA5126/2	1
Workout_ror44 L=1400 inkl 0gr beslag	07-200-155k	1
Workoutrør Ø 33 L= 1270 m 0gr 200beslag	07-200-169k	1
Stolpe Ø110 L= 3300 (2700-600)	SFA5126/2	1

Se separat delmontering for detaljer
 See separate assembly for details
 Se separata delmontering för detaljer

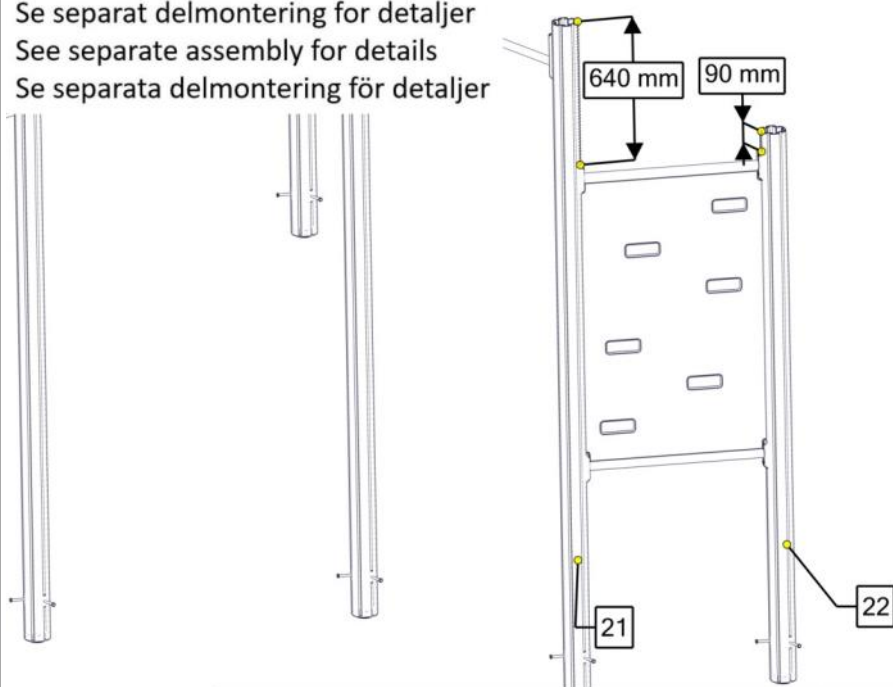

Part Name	Article nr.	Qty
Støpe fundament Ø 110	00-003-111K	1
Buldervegg 1250x795 med grønne rør	07-500-402K	1
Stolpe Ø110 L=2450 600-1850	SFA5126/2	1

Se separat delmontering for detaljer
 See separate assembly for details
 Se separata delmontering för detaljer

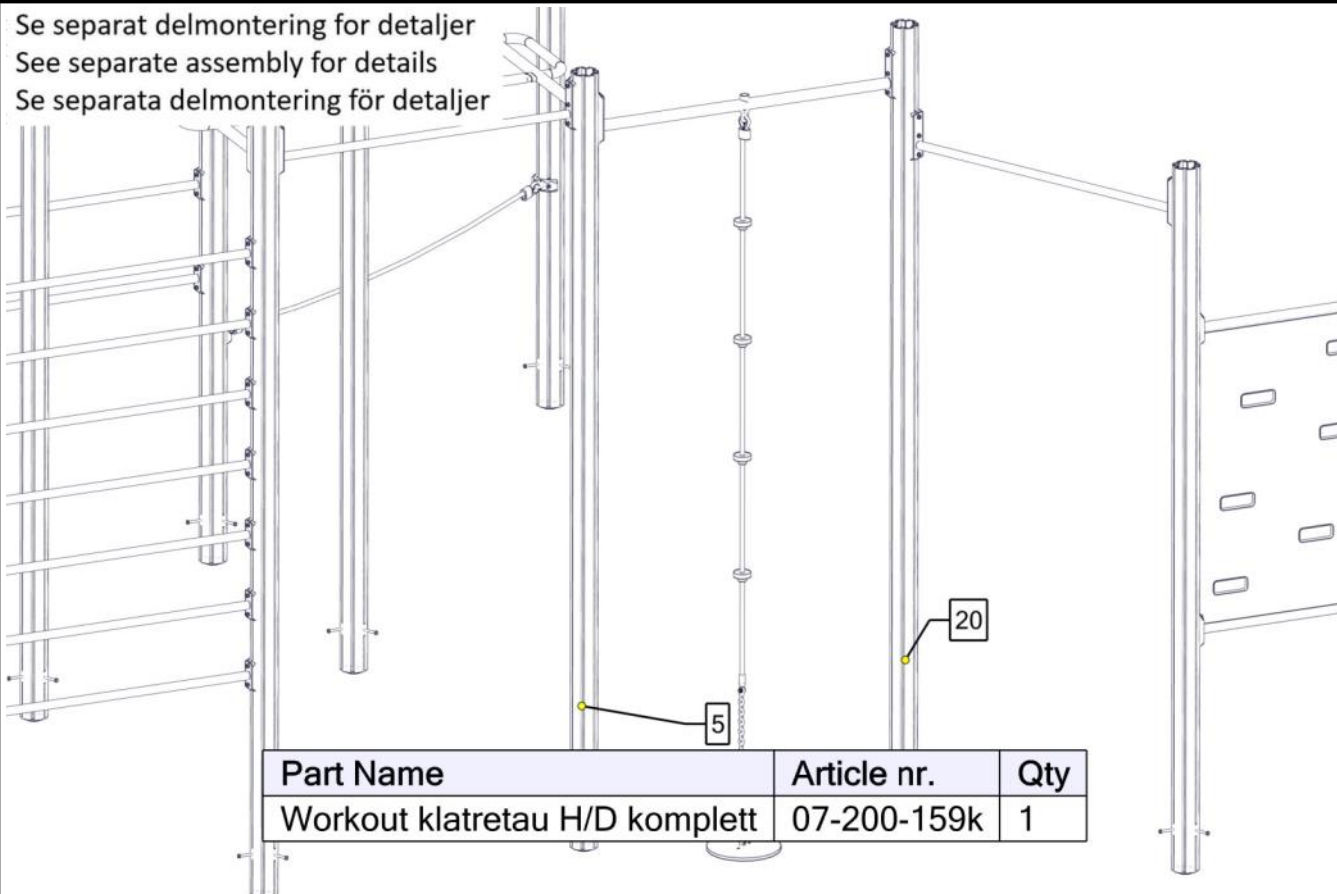



Part Name	Article nr.	Qty
Workout klatretau H/D komplett	07-200-159k	1

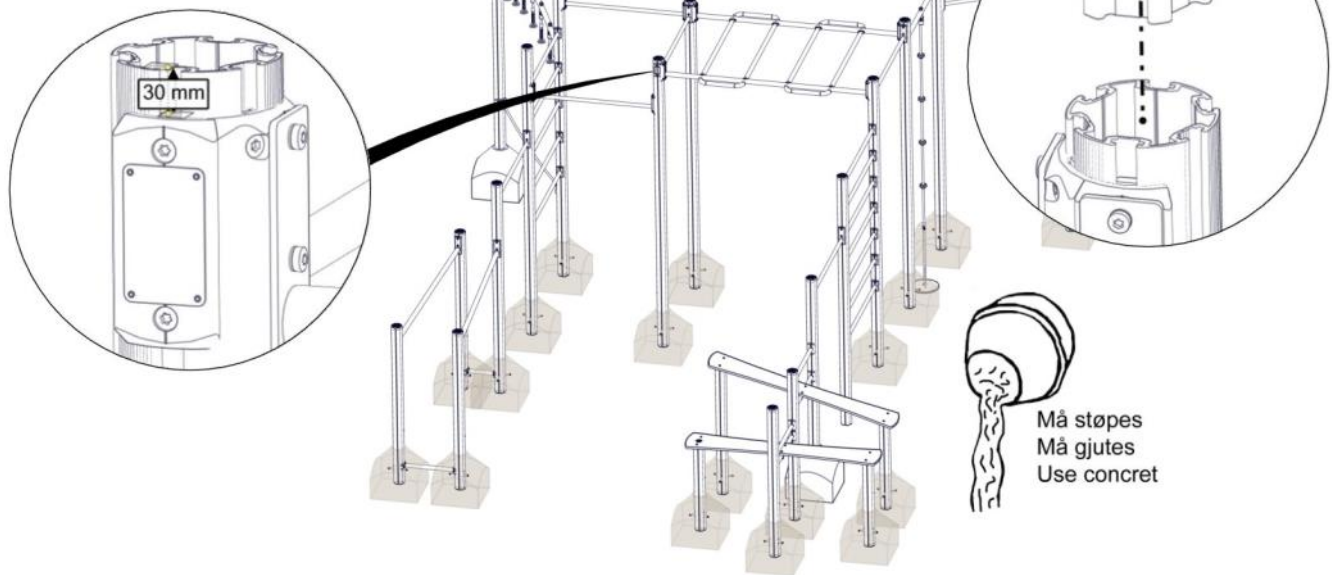



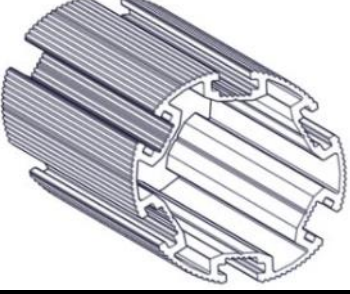
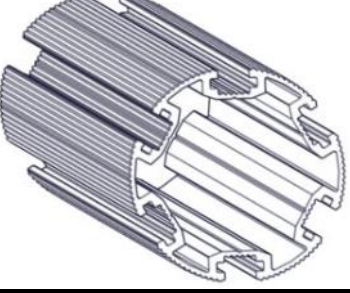
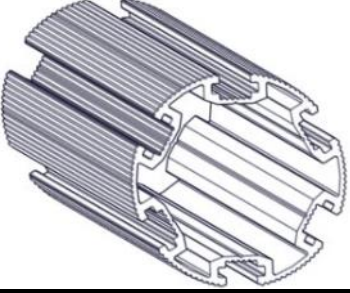
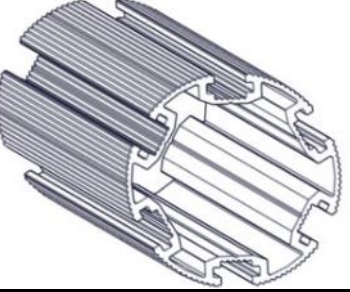

Se separat delmontering for detaljer
 See separate assembly for details
 Se separata delmontering för detaljer











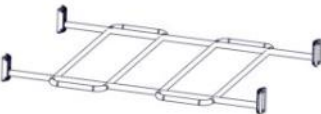

Part Name	Article nr.	Qty
Endelokk 110	00-400-995	18
Produktmerke	07-500-500	1

Før utstyret tas i bruk / Before play begins / Innan lekredskapet tas i bruk	
N	<ul style="list-style-type: none"> ● Påse at fallunderlag er utlagt i henhold til gjeldende regler eller vår anbefaling ● Fjern alle monteringshjelpemidler (rester av betong, planker, paller, plast, og lignende) ● Før utstyret tas i bruk, burde man sjekke at det ikke er fare for at anorakksnorer og lignende som kan hekte seg fast noen steder på lekeapparatet. (Vedlagte snor med dobbe (kneledd) kan brukes til å sjekke at dette er i orden. Se vedlagte veiledning for bruk av denne. Dette gjøres for å oppdage eventuelle feilmonteringer.?) ● NB! Bør stå i 2-3 dager før bruk
EN	<ul style="list-style-type: none"> ● Make sure the area and depth of safer surfacing are according to the current standard, or to the manufacturer's recommendation ● Make sure all tools and surplus materials are removed before play begins ● PS! When complete, allow 2-3 days for the concrete to set before use
S	<ul style="list-style-type: none"> ● Kontrollera att fallunderlag är utlagt enligt gällande regler eller vårt rekommendation ● Ta bort alla monteringshjälpmedel (rester av betong, plankor, pallar, plast och liknande) ● Innan lekredskapet används, kontrollera att anoracksnoddar eller kläder/delar av kläder eller liknande inte kan fastna i några delar på redskapet. (Den bipackade "knävringen" kan man med fördel användas för denna kontroll. ● Detta görs för att upptäcka eventuella felmonteringar.)

Boltepakker for / Boltpackage for / Bultpaket för		Sign. _____		
Grønn-Grå 16-102-370	Navn	Artnr/ dimensjon	Ant	Lev
	Stolpe Ø110 L=3300 (2700-600)	SFA5126/2	7	
	Stolpe Ø110 L=2850 (2250-600)	SFA5126/2	1	
	Stolpe Ø110 L=2400 (1800-600) Grå	SFA5126/2	1	
	Stolpe Ø110 L=2350 (1750-600)	SFA5126/2	1	
	Stolpe Ø110 L=1800 (1200-600)	SFA5126/2	3	
	Stolpe Ø110 L=1700 (1100-600) Grå	SFA5126/2	2	
	Stolpe Ø110 L=1508 skrå (908-600)	07-100-361	1	
	Stolpe Ø110 L=1040 skrå (440-600)	07-100-363	1	
	Stolpe Ø110 L=1000 (400-600) Grå	SFA5126/2	2	
	Stolpe Ø110 L=2750 (2150-600)	SFA5126/2	1	
	Stolpe Ø110 L=3000 (2700-600)	SFA5126/2	1	
	Stolpe Ø110 L=2450 (1850-600)	SFA5126/2	1	
	Workout rør cc1400 0gr Grønn	07-200-162K (Se egen del- montering)	12	
	Workout rør L=1270mm 30gr 200 Beslag Grønn	07-200-174K (Se egen del- montering)	2	

Boltepakker for / Boltpackage for / Bultpaket för		Sign. _____		
Grønn-Grå 16-102-370	Navn	Artnr/ dimensjon	Ant	Lev
	Workout rør Ø33 L=1270 0gr Grønn	07-200-169K (Se egen del- montering)	5	
	Sperrerør rett workout 30gr beslag cc650 Sort	07-500-081K (Se egen del- montering)	1	
	Sperrerør rett workout 30gr beslag cc400 Sort	07-500-082K (Se egen del- montering)	1	
	Workout rør 0gr Ø44,5 L=2160 CC400-650 Venstre Grønn	07-200-189K (Se egen del- montering)	1	
	Workout rør 0gr Ø44,5 L=2160 CC400-650 Høyre Grønn	07-200-188K (Se egen del- montering)	1	
	Sperrerør 0gr sittebrett L=750 Grønn	07-200-127K (Se egen del- montering)	1	

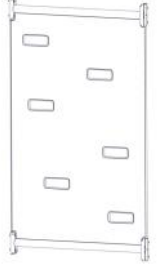
Boltepakker for / Boltpackage for / Bultpaket för		Sign. _____		
Grønn-Grå 16-102-370	Navn	Artnr/ dimensjon	Ant	Lev
	Sperrerør med 15gr beslag, sittebrett L=750 Grønn	07-200-126K (Se egen del- montering)	1	
	Situp Brett 0gr komplett Grå	07-200-122K (Se egen del- montering)	2	
	Sperrerør rett uten hull Komplett L=750 Grønn	07-500-059K (Se egen del- montering)	2	
	Produktmerke	07-500-500	1	
	Endelokk til stolpe Ø110	00-400-995	18	
	Workoutbro inkl 30gr beslag Grønn	07-200-176K (Se egen del- montering)	1	

Boltepakker for / Boltpackage for / Bultpaket för		Sign. _____.		
Grønn-Grå 16-102-370	Navn	Artnr/ dimensjon	Ant	Lev
	Balansetau inkl 30gr beslag L=2,156 meter	07-500-029K (Se egen del- montering)	1	
	Armgang med Polifix hantak inkl 30gr beslag Grønn	07-500-454K (Se egen del- montering)	1	
	Workoutrør 44mm L=1400 0gr Med hull Grønn	07-200-155K (Se egen del- montering)	1	
	Buldervegg 1250x795 Grønn	07-500-402K (Se egen del- montering)	1	
	Workout klatretau Svart	07-200-159K (Se egen del- montering)	1	

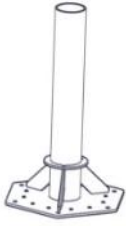
Boltepakker for / Boltpackage for / Bultpaket för		Sign. _____		
Grønn-Grå 16-102-370	Navn	Artnr/ dimensjon	Ant	Lev
	Støp fundament			
	Fundament betong Ø110	00-003-111K (Se egen del- montering)	22	
	Overflate montering			
	Fundament 1xØ110 for Betongdekk Ekstra	00-003-137K (se egen del- montering)	22	
	Stolpe kappes	SFA5126/2	(22)	
	Korte bolter Torx M8x25	04-000-025	16	

10.04.2024. Overflatemontering
MNO

MTK 26-06-2024
Feil stolpeplasseings tegning