

N

Monteringsanvisning

EN

Assembly Instructions

S

Monteringsanvisning

Produkt nr. / Product no. / Produkt nr.

16-501-014**Grønn / Grå**

Ord. nr. _____

Dato. _____

Sign. _____

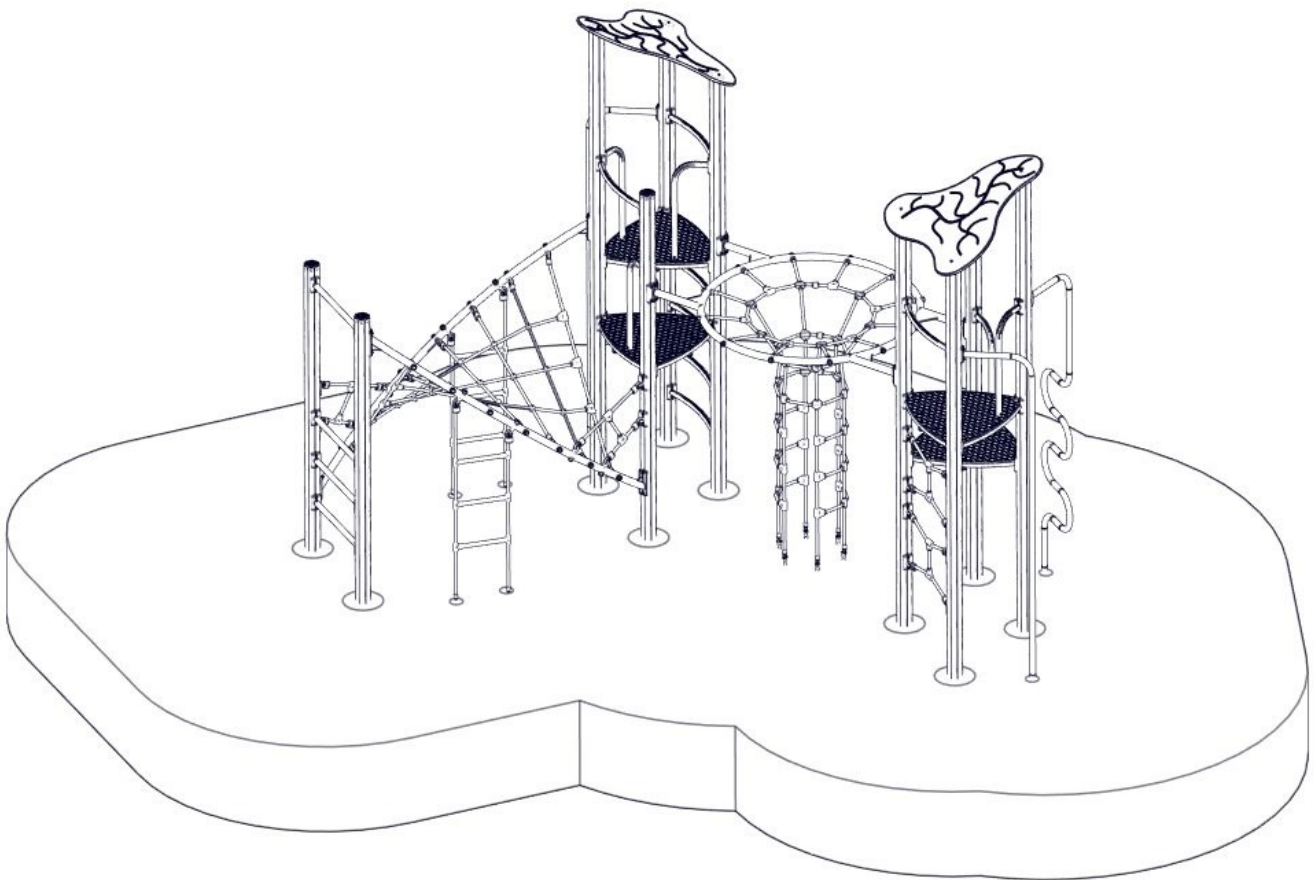
**søve**

Søve AS
Grønnvoldveien 290
3830 Ulefoss - Norway
Tlf: +47 35 94 65 65
www.sove.no

**søve**

Søve AB
EA Rosengrensgatan 32
421 31 Västra Frölunda
Phone: +46 (0)31 773 97 00
www.sove.se

Monteringstips / Assembly Advice / Monteringsstips**N**

- Les monteringsanvisningen nøye før montering.
- Monter elementene i rekkefølgen som vist.
- Boltene bør ikke skrues for hardt til før alt er montert, vatret og loddet. Skru så boltene til.
- NB! Ved bruk av drill, kan boltene ryke.
- På grunn av at solen kan gjøre rutsjeplaten veldig varm, bør rutsjebanens utløp vende mot nord-øst eller nord-vest.
- Er lekeutstyret plassert i naturlige ferdselstraséer må området sikres mot gjennomgang.
- Innspringningshinder bør vurderes rundt lekeapparater hvor det er stor bevegelse, f.eks. ved huskestativ.
- Det bør være fritt innsyn til lekeutstyr som er beregnet for barn under 3 år.

NB! Under monteringsarbeidet må utstyr, som ikke er forankret forsvarlig i bakken, sikres slik at det ikke velte.

Området må avstenges under montering av apparatene med sperrebånd eller lignende.

EN

- Read the instruction carefully before assembling the play unit.
- Assemble the components in the sequence shown in these instructions. Fixings must not be fully tightened during assembly. Before casting the foundations, the structure must be level and plumb, at which point all fixings are tightened. PSI If use of drill, the bolts may be wrecked.
- Avoid positioning the slide facing due south because of overheating – ideal positions are facing north-east or north-west. Secure the construction-area to prevent people from walking through it.
- Consider installing barriers around play-equipment which gives rise to a lot of activity – i.e. swings.
- Ensure that clear vision is possible across the play area so that supervision is possible from any position, particularly where children under 3 years of age will be playing.

NB! During assembly of the equipment, ensure that all structures are securely propped, especially when left overnight. Also ensure that equipment is supported

Monteringstips / Assembly Advice / Monteringsstips**S**

- Läs monteringsanvisningen noga före montering.

- Montera delarna i den ordningen som anvisas
- Skruvarna bör inte skruvas för hårt tills allt är monterat, i våg och lodat.

OBS! Används elektrisk skruvdragare, kan bulten gå sönder. Hårdra därför manuellt!









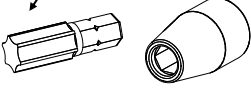

- Solen kan göra att rutchbanan blir väldigt varm. Banans nedfart rekommenderas att vändas i norrlig riktning
- Om lekplatsen placeras vid en gångväg mm bör området säkras mot genomfart av gående och cyklister.
- Insprängningshinder bör placeras runt lekutrustning med stor rörelse, t ex, gungställning.
- Det bör vara fri insyn till lekutrustning beräknat till barn under 3 år.

OBS! Under monteringsarbete bör utrustningen som inte ska förankras i marken, ställs så att den inte kan välta.

Området måste spärras när lekutrustningen byggs upp, med avspärrningsband eller liknande.

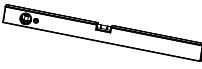
NO	Betongkvalitet	C25/30		
SE	Betongkvalitet			
EN	Concrete quality			
NO	Mengde betong		1	m ³
SE	Mängd betong			
EN	Amount of concrete			
NO	Fundament størrelse		0,5x0,5x0,4	m
SE	Stiftelsestorlek			
EN	Foundation size			
NO	For sikkerhet må fundamentene med sand eller myk jord være minst 50% større i areal			
SE	För säkerheten måste grunden med sand eller mjuk jord vara minst 50% större i området			
EN	For safety, the foundations with sand or soft soil must be at least 50% larger in area			
NO	Tyngste element	07-200-027	25,5	Kg
SE	Tyngsta element			
EN	Heaviest element			
NO	Største element	07-100-353 07-200-027	L=4,405 Ø=110 2,16x1,65x0,14	m
SE	Största element			
EN	Biggest element			

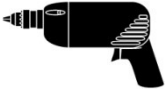
Nødvendig verktøy / Tools required / Nödvändiga verktyg







<p>(N)</p> <p>(EN)</p> <p>(S)</p>	<p>(A)</p> 	<p>(B)</p>  <p>Torx Nr 45 High quality</p> 	<p>(C)</p>  <p>13 + 17mm</p> 	<p>(D)</p> 	<p>(E)</p> 
		<p>Metermål</p> <p>Metric measure</p> <p>Tumstock</p> 	<p>16 V</p> 	<p>Merkebånd</p> <p>Mark ribbon</p> <p>Märkeband</p> 	<p>5 mm</p> <p>6 mm</p> 

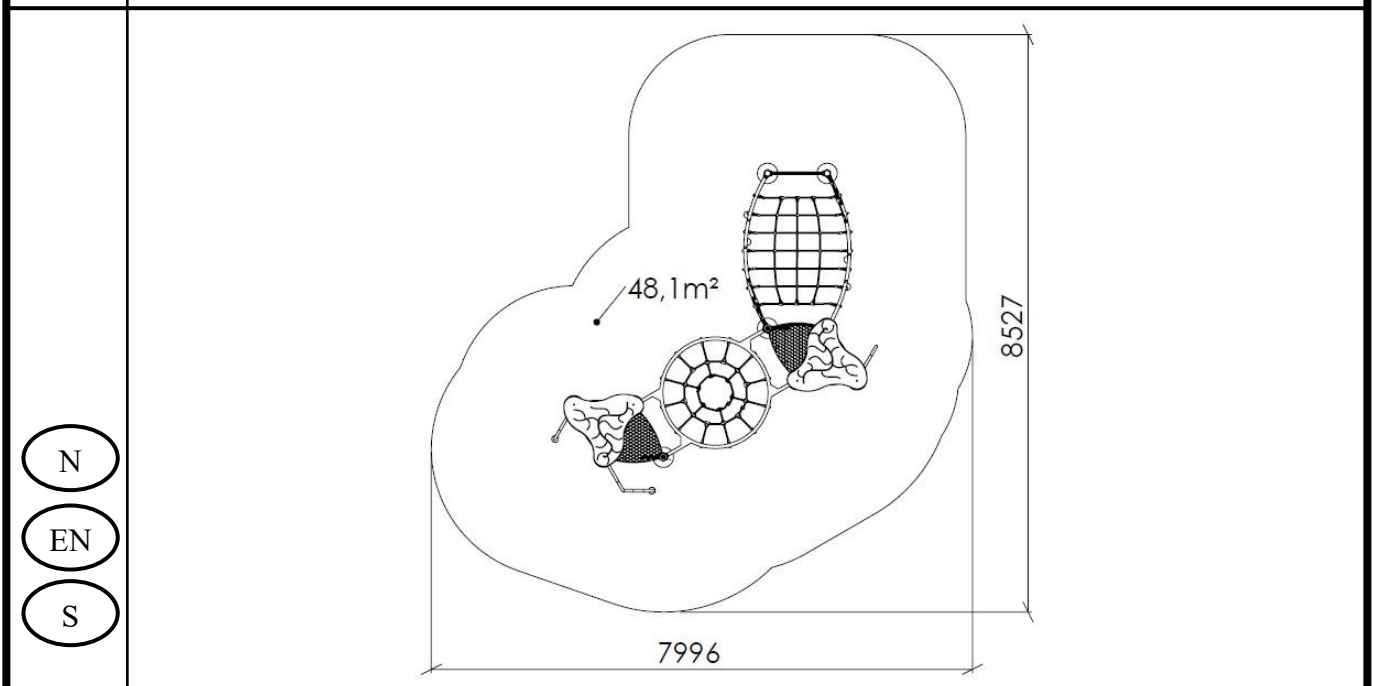

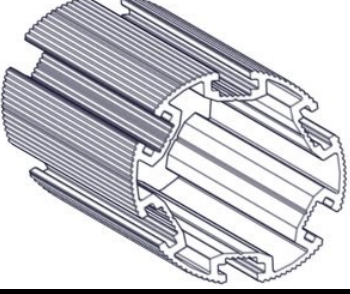

Nødvendig antall personer / Number of persons required / Rekommenderad antal personer



Anbefalt arealbehov ved montering / Recommended working space / Rekommenderad arealbehov vid montering

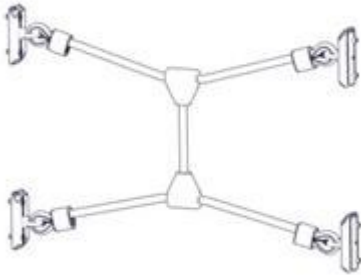





Boltepakker for / Boltpackage for / Bultpaket för		Sign. _____.		
Adventure Varden 16-501-014	Navn	Artnr/ dimensjon	Ant	Lev
	Stolpe Ø110 L=4050 skrå, Grå	07-100-352	4	
	Stolpe Ø110 L=4405 skrå, Grå	07-100-353	2	
	Stolpe Ø110 L=3450, Grå	SFA5126/2	2	
	Stolpe Ø110 L=2950, Grå	SFA5126/2	2	
	Endelokk til stolpe Ø110	00-400-995	4	
	Gulv 3-kant Standard CC880 Grå	07-300-104K (se egen delmontering)	4	
	Sperrerør Bøyd Lengde = 750 Uten hull Grønn	07-500-072K (se egen delmontering)	7	
	Sluse H=790 Grønn	07-500-074K (se egen delmontering)	5	
	Bro rundgang med sjakt CC880, L=2200 Grønn	07-200-260K (se egen delmontering)	1	

Boltepakker for / Boltpackage for / Bultpaket för		Sign. _____.		
Adventure Varden 16-501-014	Navn	Artnr/ dimensjon	Ant	Lev
	Spideroppgang Komplett CC880 Grønn	07-500-266K (Se egen delmontering)	2	
	Sperrerør rett uten hull L=750 Grønn	07-500-059K (Se egen delmontering)	4	
	Bro tordert ned med 2x stige Grønn	07-500-314K (Se egen delmontering)	1	
	Brannstang Gulv H=1,9m Grå	07-200-037K (Se egen delmontering)	2	
	Klatrestang gulv H=1,9m Grå	07-200-038K (Se egen delmontering)	1	

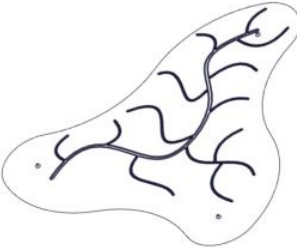
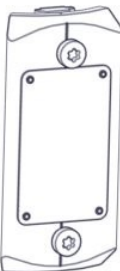
Boltepakker for / Boltpackage for / Bultpaket för

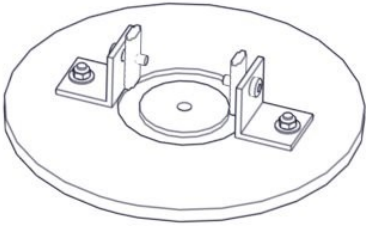
Sign. _____.

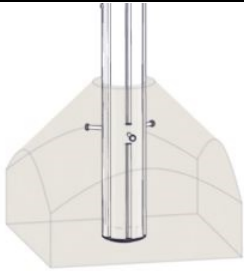
Adventure Varden 16-501-014	Navn	Artnr/ dimensjon	Ant	Lev
	Tak trekant CC880 Grå	07-302-120K (se egen delmontering)	2	
	Produktmerke	07-500-500 (se egen delmontering)	1	

Boltepakker for / Boltpackage for / Bultpaket för		Sign. _____		
Adventure Varden 16-501-014	Navn	Artnr/ dimensjon	Ant	Lev
	Fundament Nedgraving			
	Fundamentplate 1 x Ø110 stolpe	07-400-101K (se egen delmontering)	10	
	Sperrerør rett Lengde = 750 Uten hull Sort	07-500-075K (se egen delmontering)	9	
	Fundament Støp			
	Støpefundament Ø110 stolpe	00-003-111K (Se egen delmontering)	10	
	Sperrerør rett Lengde = 750 Uten hull Sort	07-500-075K (se egen delmontering)	9	

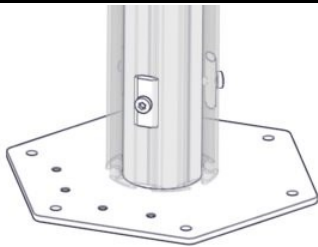
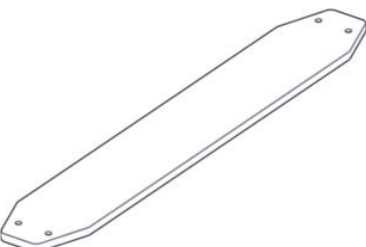
Boltepakker for / Boltpackage for / Bultpaket för		Sign. _____.		
Adventure Varden 16-501-014	Navn	Artnr/ dimensjon	Ant	Lev
	Overflate montering			
	Fundament 3xØ110 for Betongdekke	00-003-115K (se egen delemontering)	2	
	Fundament 1xØ110 for Betongdekke	00-003-113K (se egen delemontering)	4	
	Fundament sprosse til Betongdekke	00-003-131K (se egen delemontering)	4	
	Klatrestang kappes	07-200-038K	1	
	Brannstang kappes	07-200-037K	2	
	Stolpe kappes	SFA5126/1	10	

Fundamentering uten betong / Foundation without concrete / Förankring utan betong

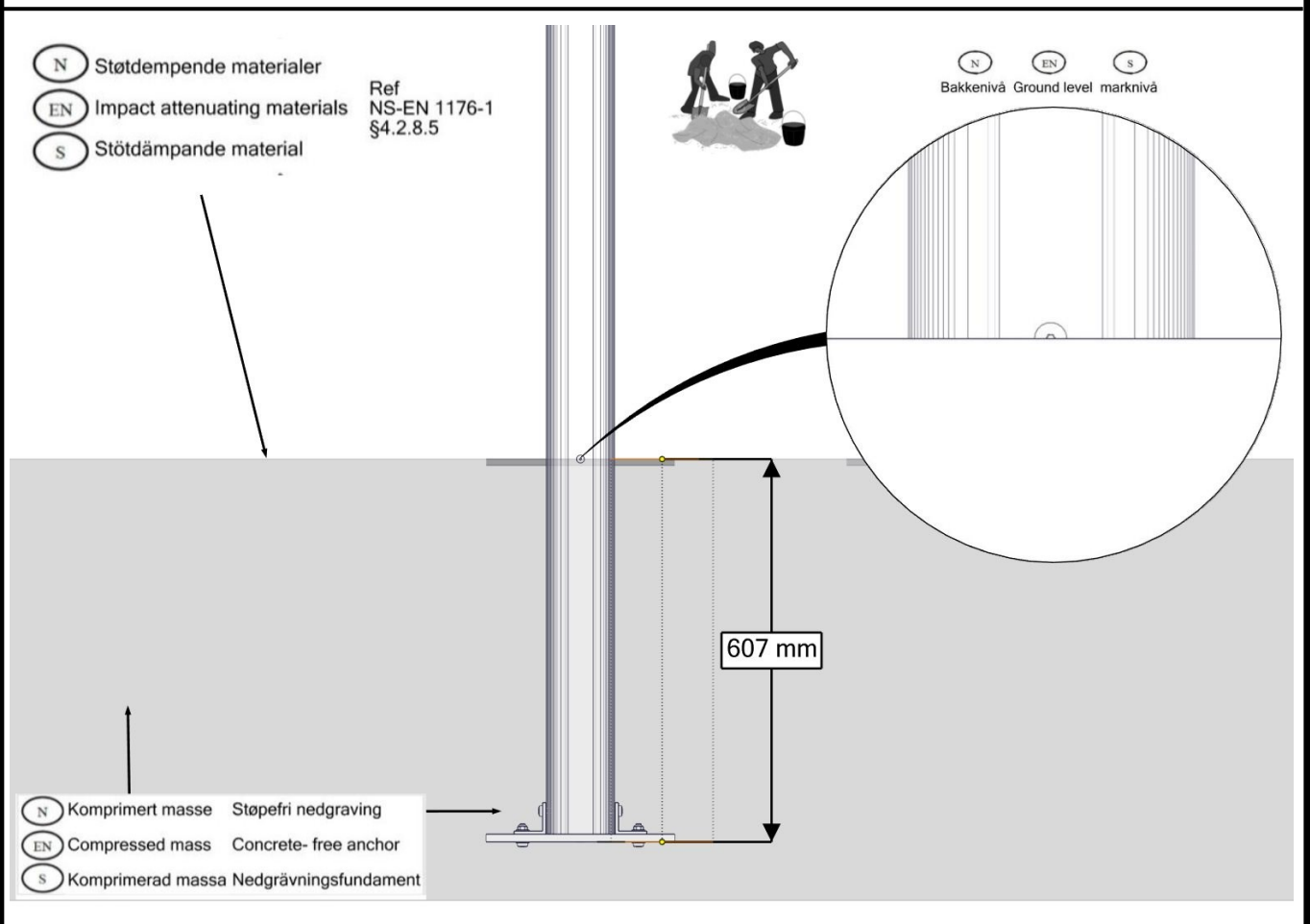

Fundamentering med betong / Foundation concrete / Förankring med betong

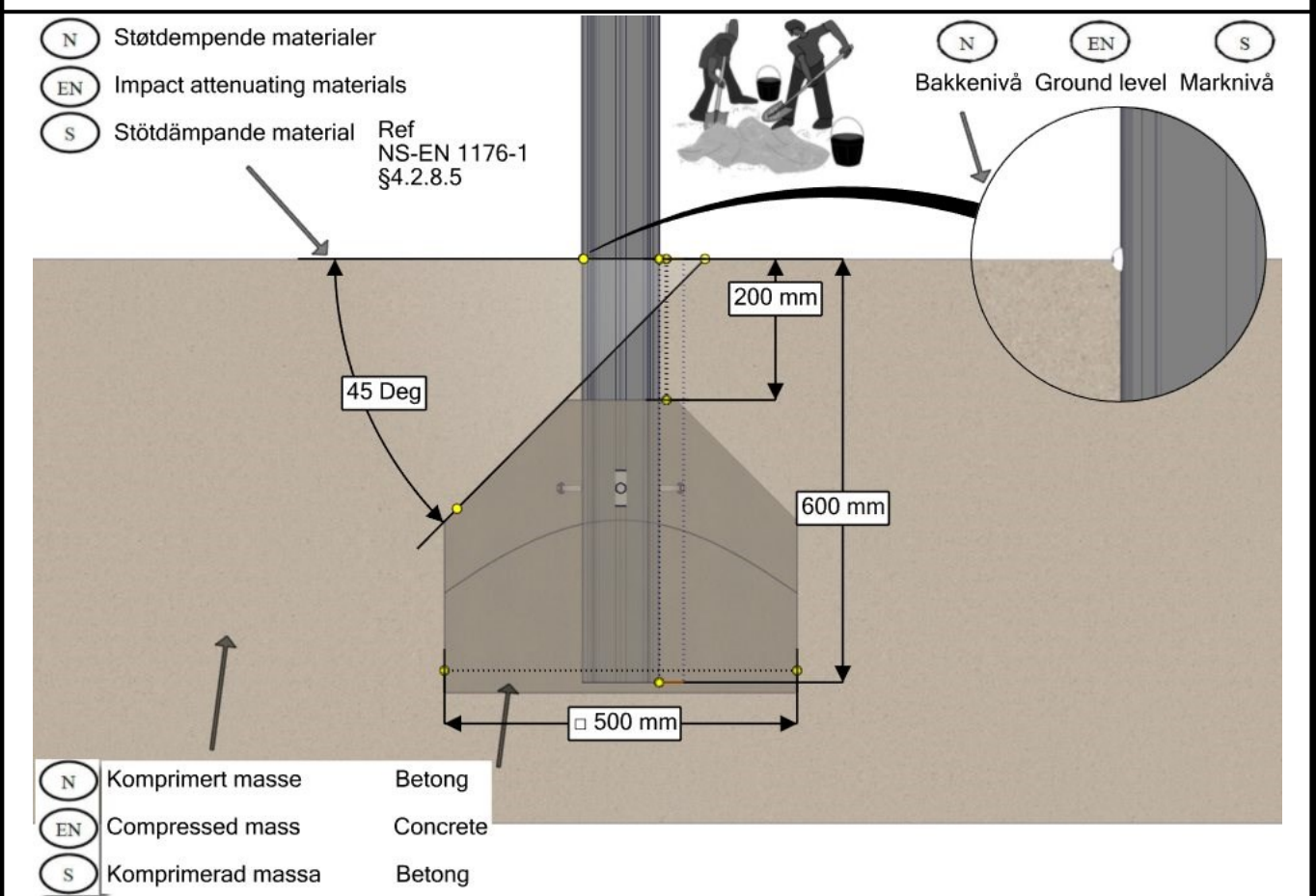

Fundamentering overflate / Foundation surface / Förankring grundytan

Ref
NS-EN 1176-1
§4.2.8.5

N EN S
Bakkenivå Ground level Marknivå

Tykkelse / Thickness

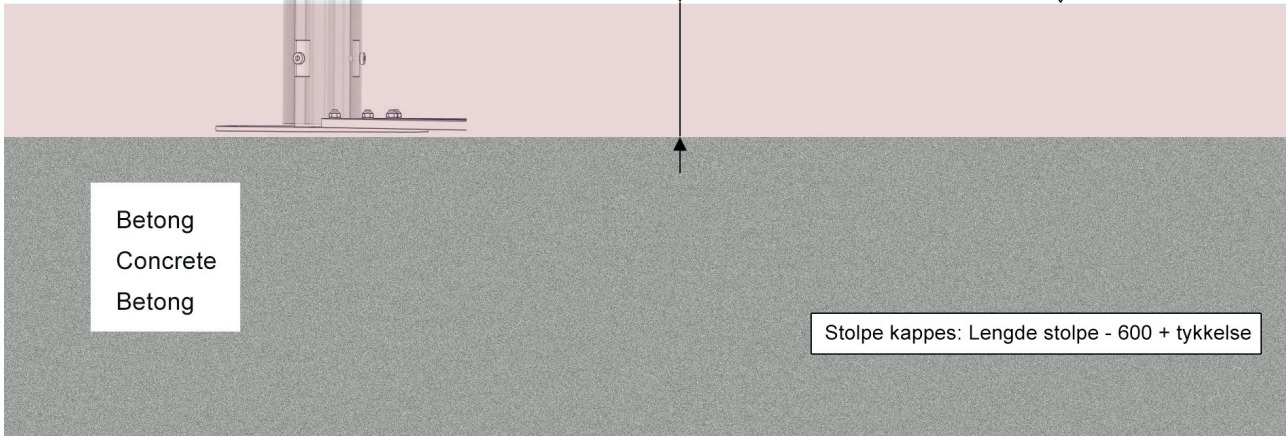

Betong
Concrete
Betong

Stolpe kappes: Lengde stolpe - 600 + tykkelse

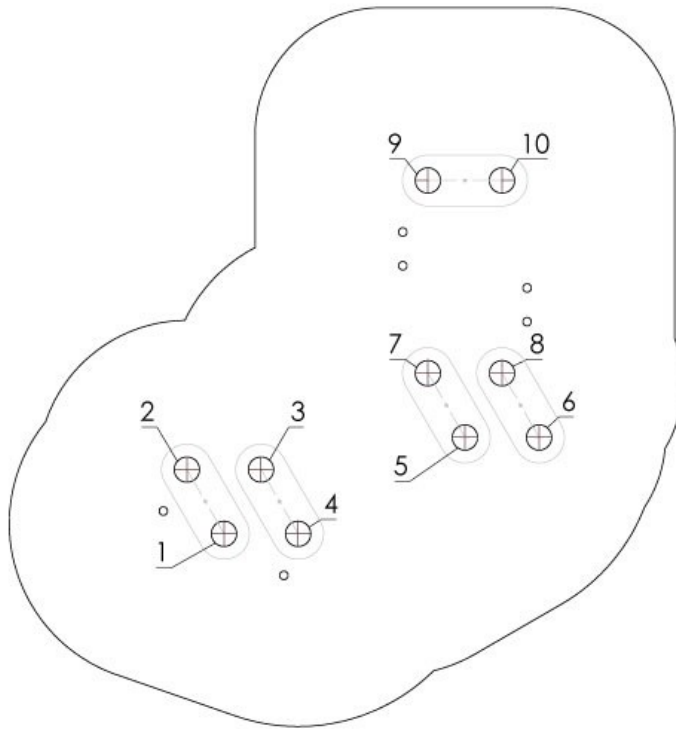

Use: 00-003-114K

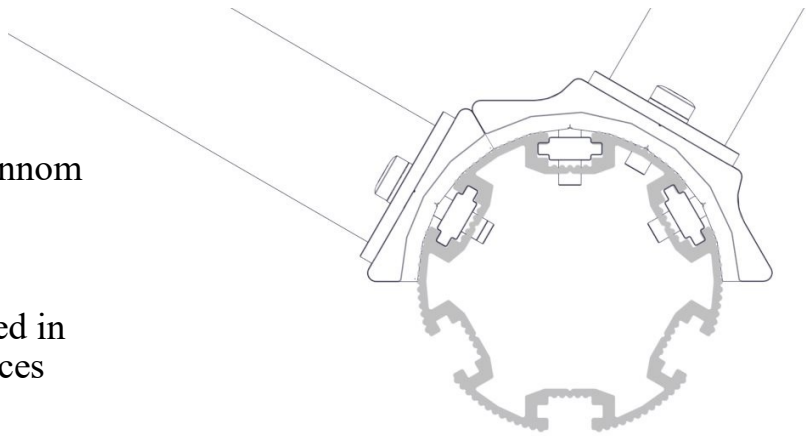

<p>(N)</p> <p>(EN)</p> <p>(S)</p>	<p>Bolten skrues HELT igjennom aluminiumen. Maks moment: 30Nm</p> <p>The bolt must be tightened in to the post, so that it pierces the aluminium Max torque: 30Nm</p> <p>Bulten skuvas HELT genom aluminiumen. Maks vridmoment: 30Nm</p> 

Fallhøyder / Free height of fall / Fallhöjder

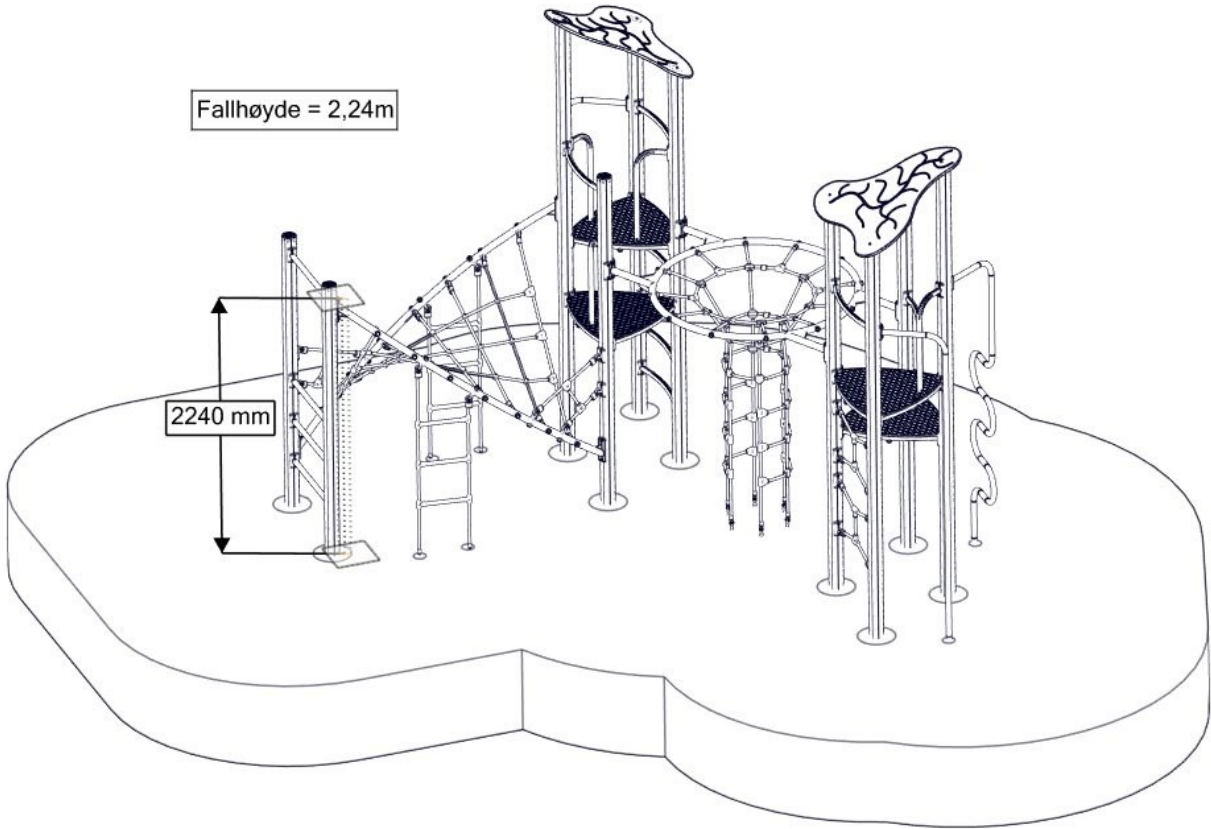

Sikkerhetszone / Safety zone / Säkerhetszon

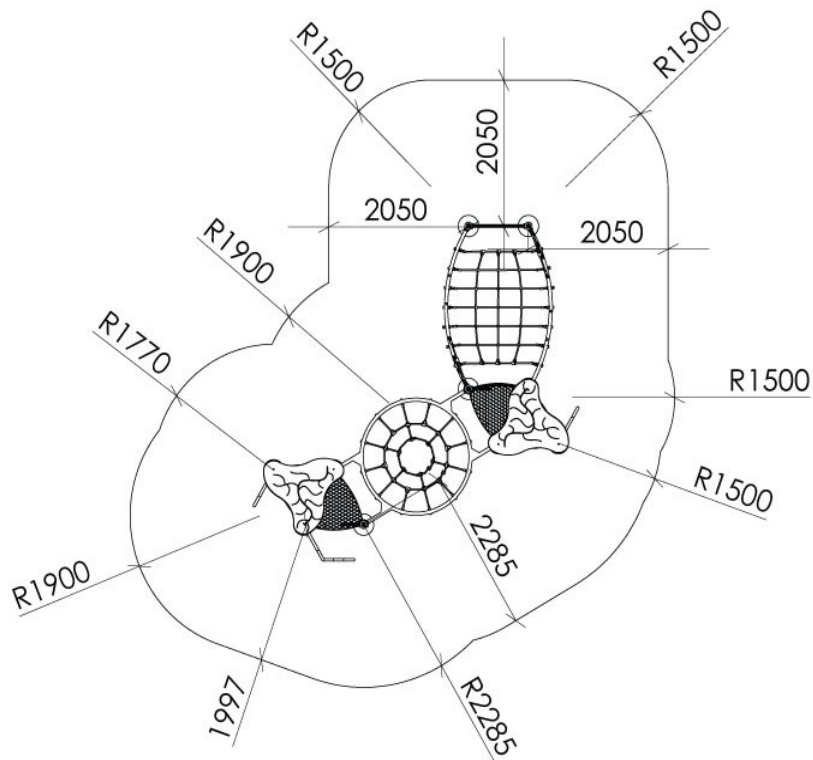

Plassering av forankringer / Ground plan / Placering av förankringar

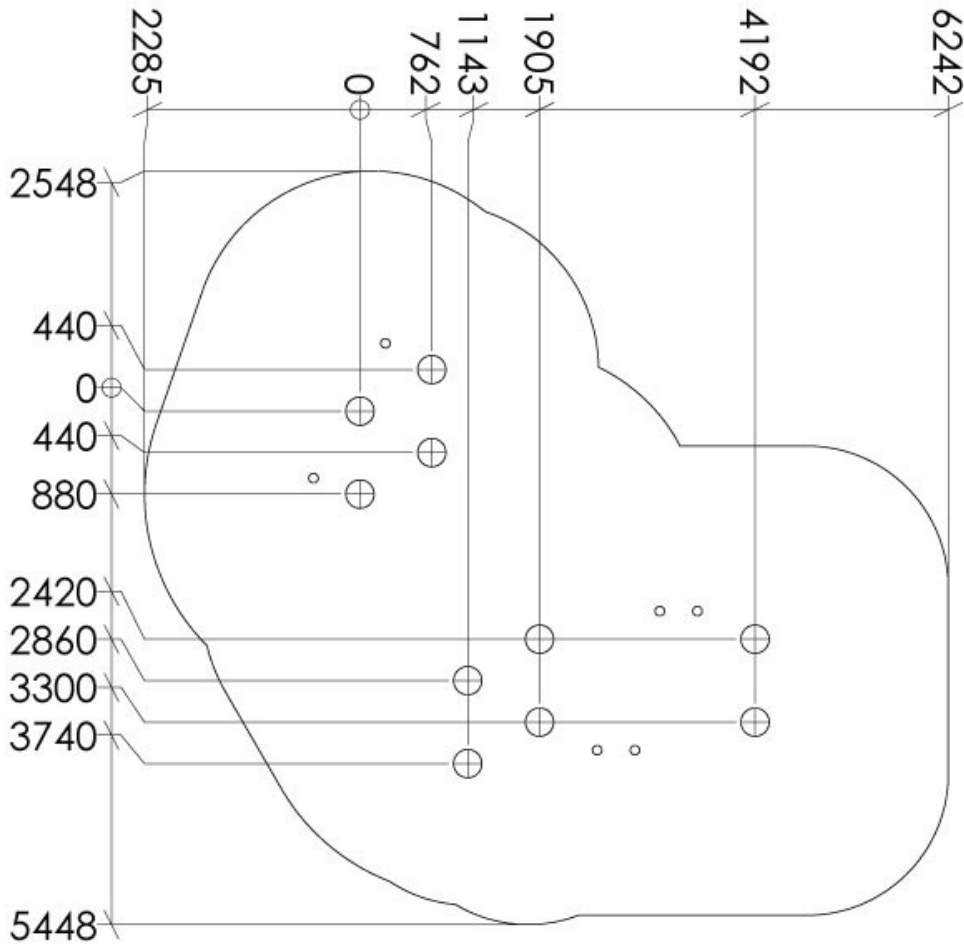

N

Alle mål er oppgitt i millimeter

EN

Scale measured in mm

S

Alla mått är i millimeter.

Montering av lekeapparatet / Assembly instructions / Montering av lekredskapet

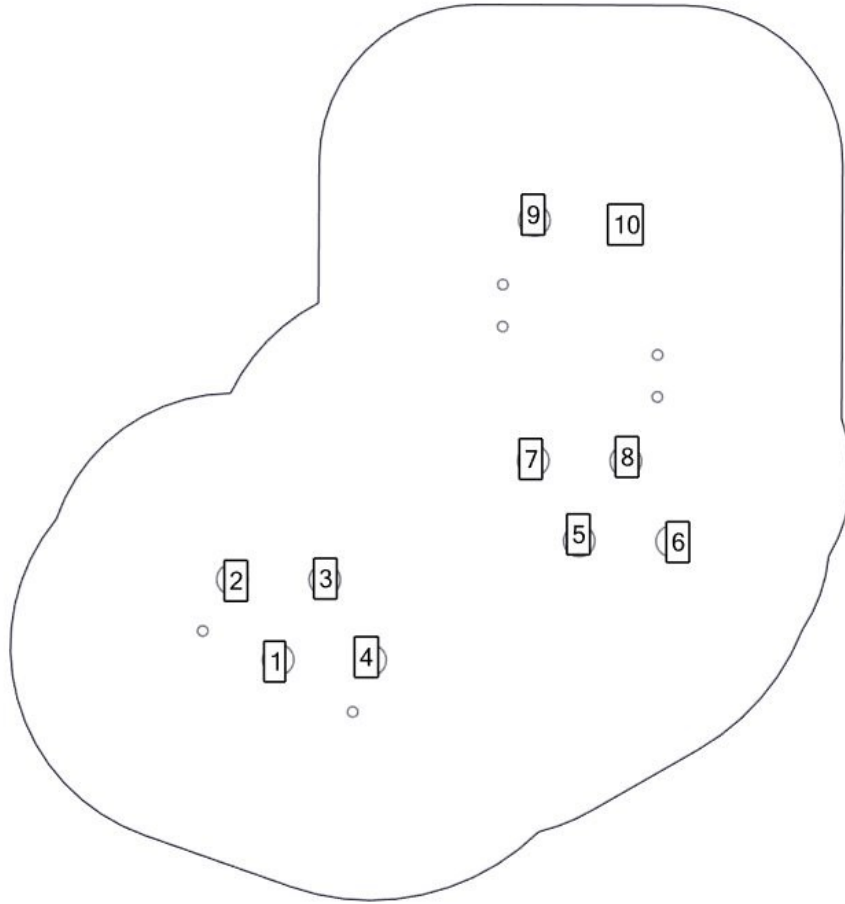

Se separat delmontering for detaljer
 See separate assembly for details
 Se separata delmontering för detaljer

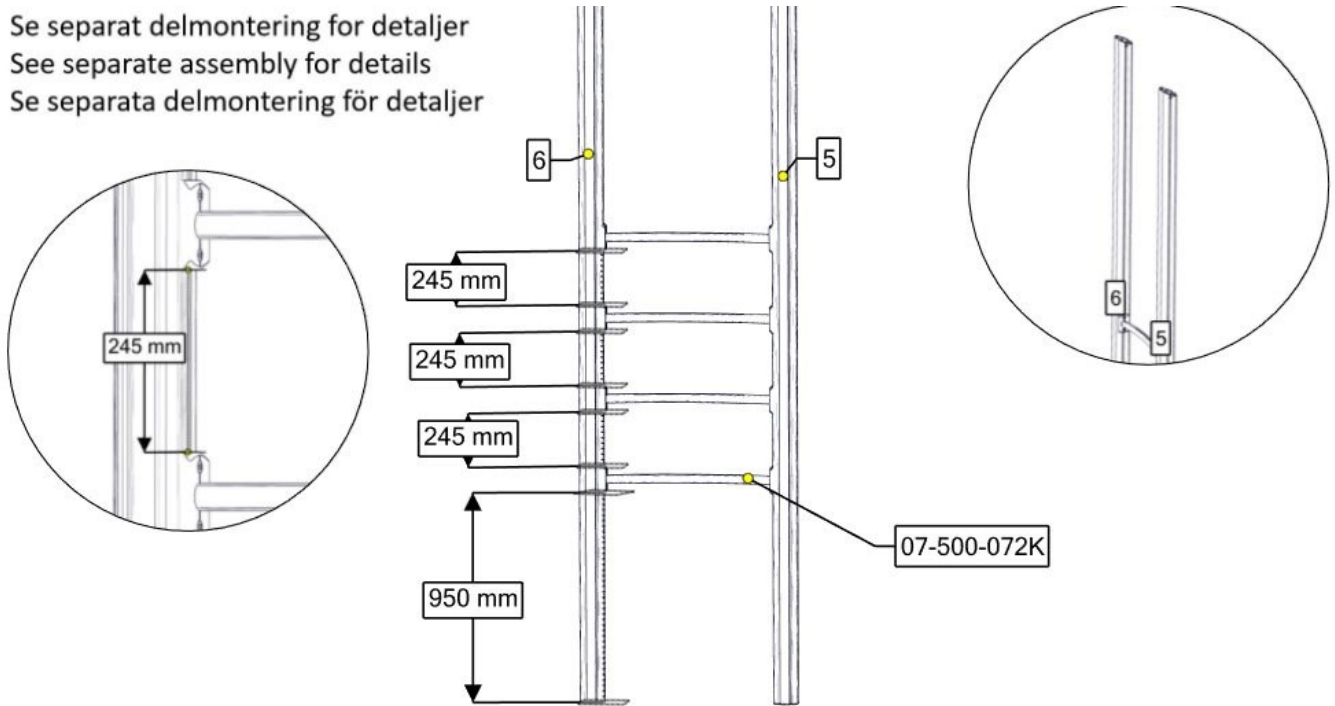

Part Name	Article nr.	Qty
Stolpe Ø110 Lengde=4050 Skrå	07-100-352	2
Sperrerør Bøyd L=750 uten hull	07-500-072K	4

Montering av lekeapparatet / Assembly instructions / Montering av lekredskapet

Se separat delmontering for detaljer
 See separate assembly for details
 Se separata delmontering för detaljer

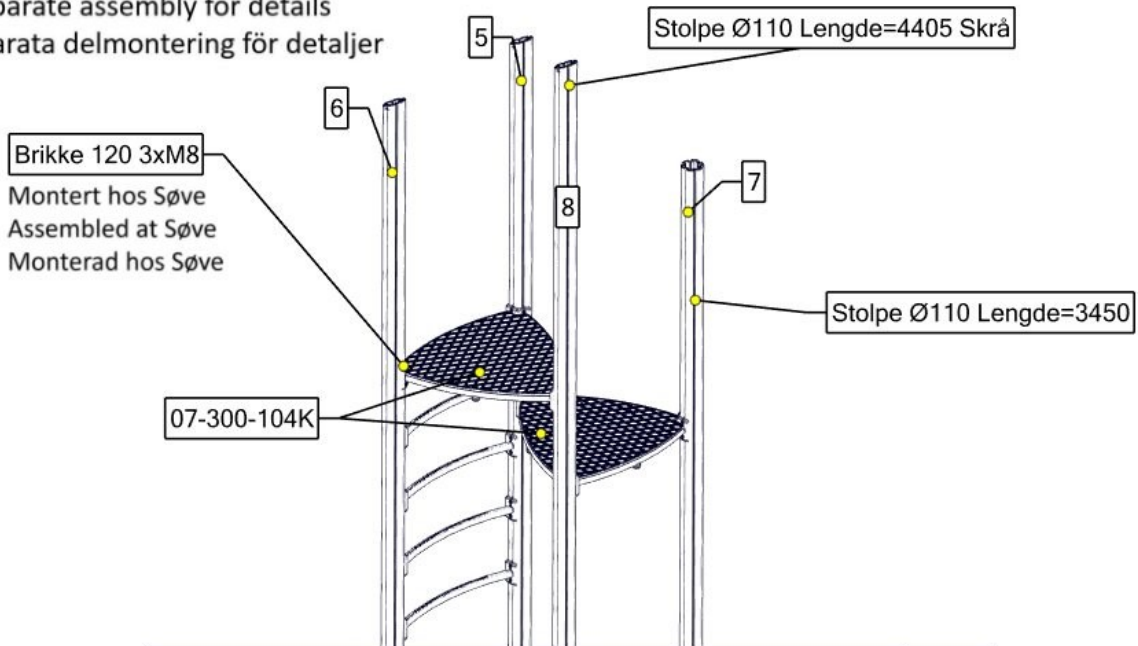

Part Name	Article nr.	Qty
Stolpe Ø110 Lengde=3450	SFA5126/2	1
Stolpe Ø110 Lengde=4405 Skrå	07-100-353	1
Gulv 3-kant 880x880 Standard	07-300-104K	2

Se separat delmontering for detaljer
 See separate assembly for details
 Se separata delmontering för detaljer

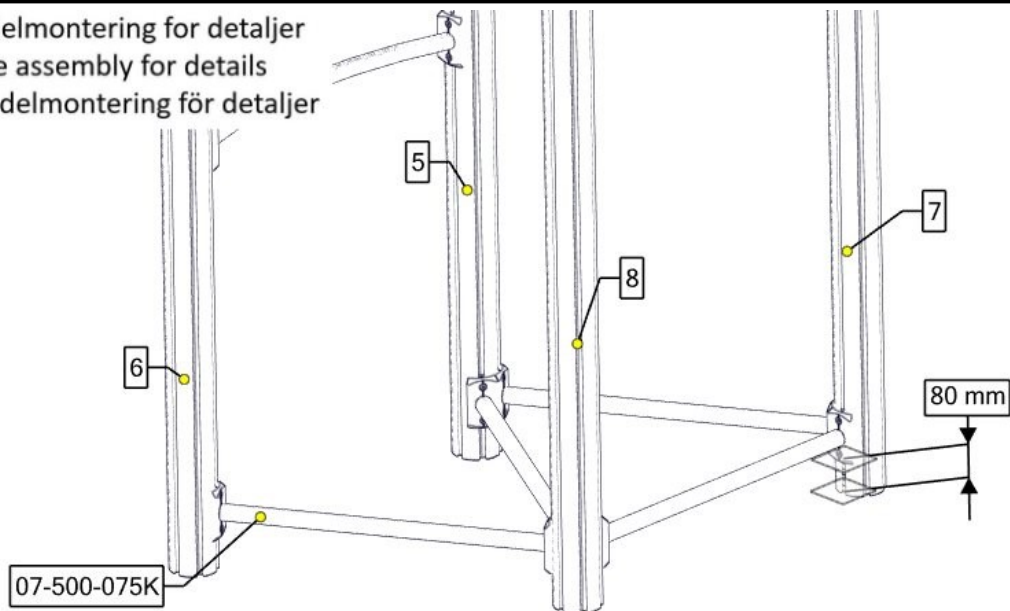

Part Name	Article nr.	Qty
Sperrerør rett L=750 uten hull	07-500-075K	4

Montering av lekeapparatet / Assembly instructions / Montering av lekredskapet

Se separat delmontering for detaljer
 See separate assembly for details
 Se separata delmontering för detaljer

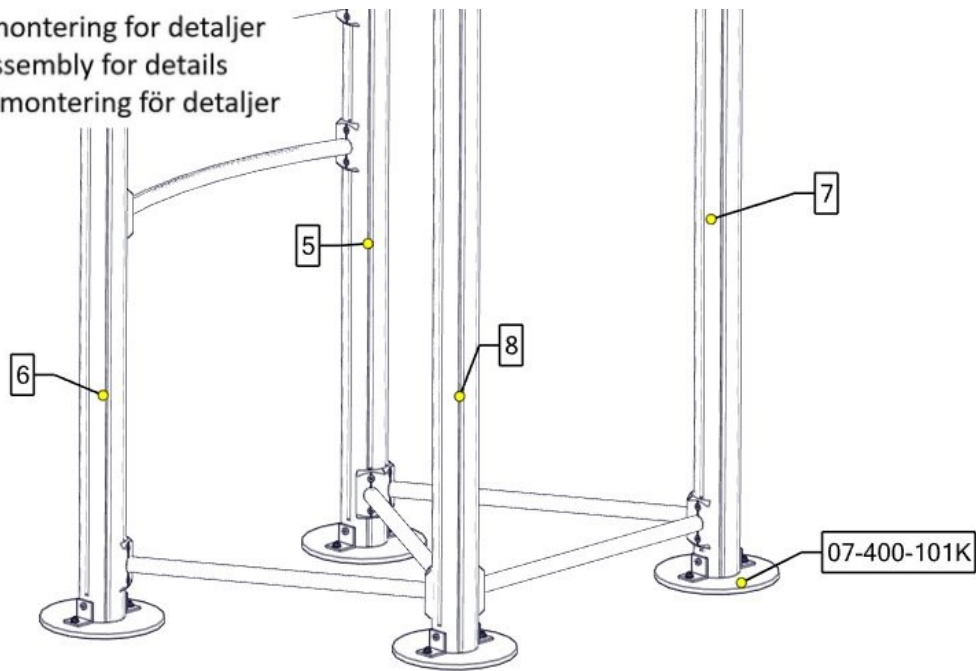

Part Name	Article nr.	Qty
Fundamentplate 1x110 stolpe komplett	07-400-101K	4

Se separat delmontering for detaljer
 See separate assembly for details
 Se separata delmontering för detaljer

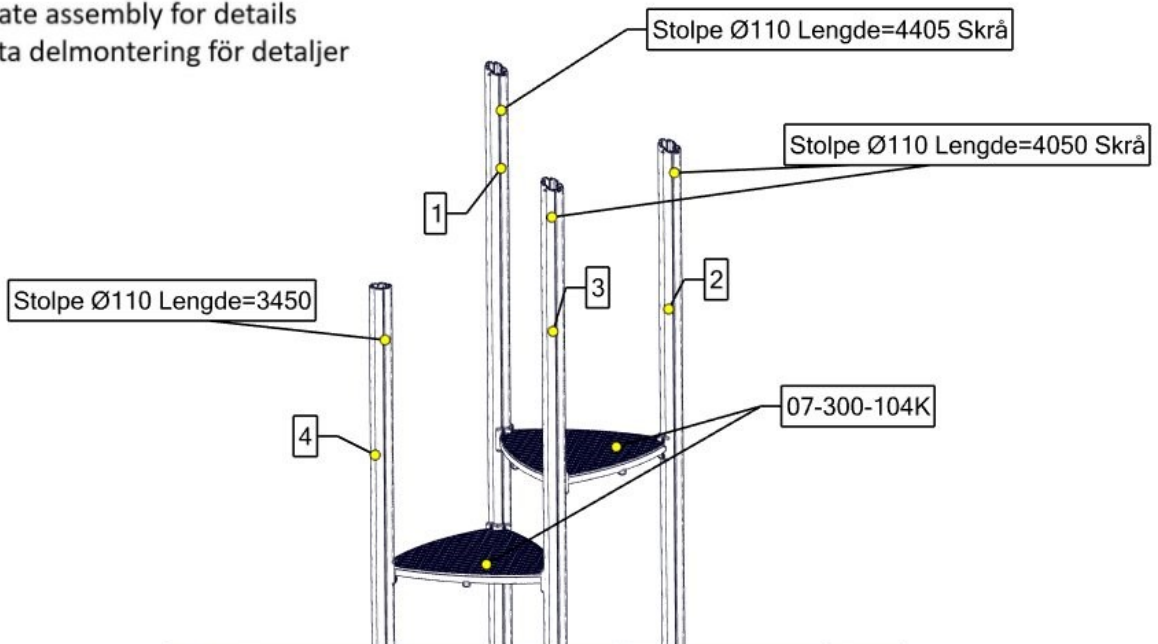

Part Name	Article nr.	Qty
Stolpe Ø110 Lengde=3450	SFA5126/2	1
Stolpe Ø110 Lengde=4405 Skrå	07-100-353	1
Stolpe Ø110 Lengde=4050 Skrå	07-100-352	2
Gulv 3-kant 880x880 Standard	07-300-104K	2

Montering av lekeapparatet / Assembly instructions / Montering av lekredskapet

Se separat delmontering for detaljer
 See separate assembly for details
 Se separata delmontering för detaljer

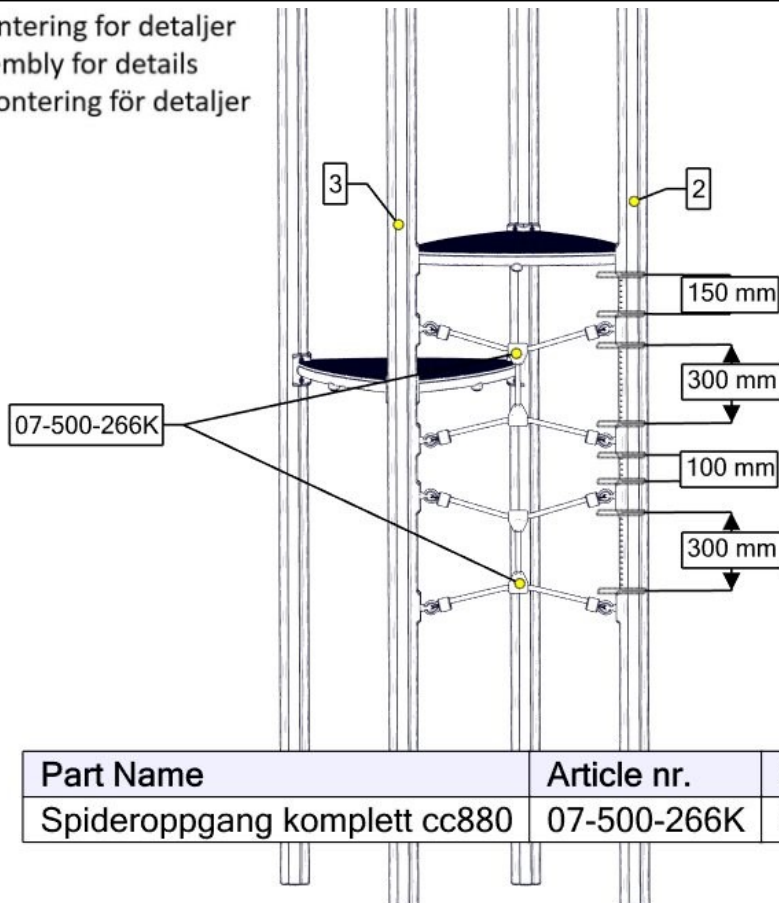

Part Name	Article nr.	Qty
Spideroppgang komplett cc880	07-500-266K	2

Se separat delmontering for detaljer
 See separate assembly for details
 Se separata delmontering för detaljer

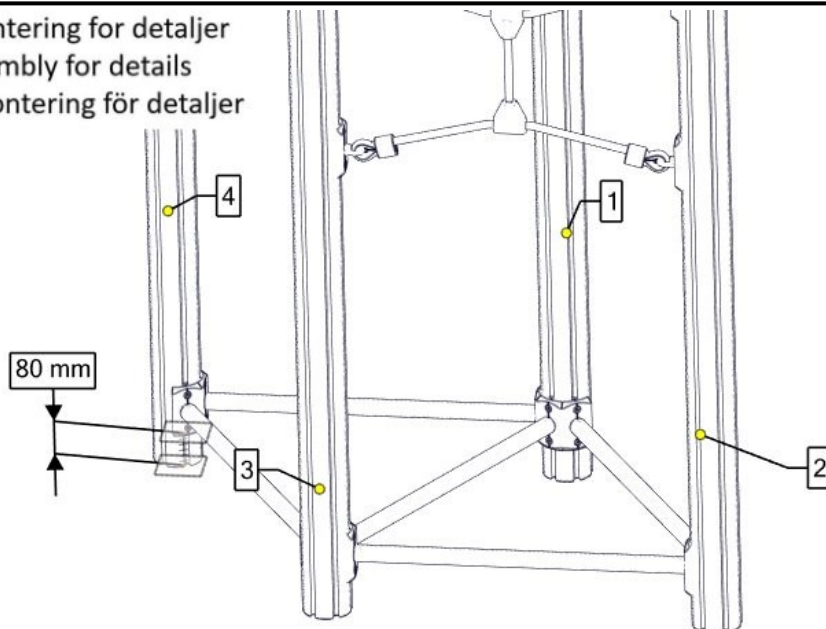

Part Name	Article nr.	Qty
Sperrerør rett L=750 uten hull	07-500-075K	5

Montering av lekeapparatet / Assembly instructions / Montering av lekredskapet

Se separat delmontering for detaljer
 See separate assembly for details
 Se separata delmontering för detaljer

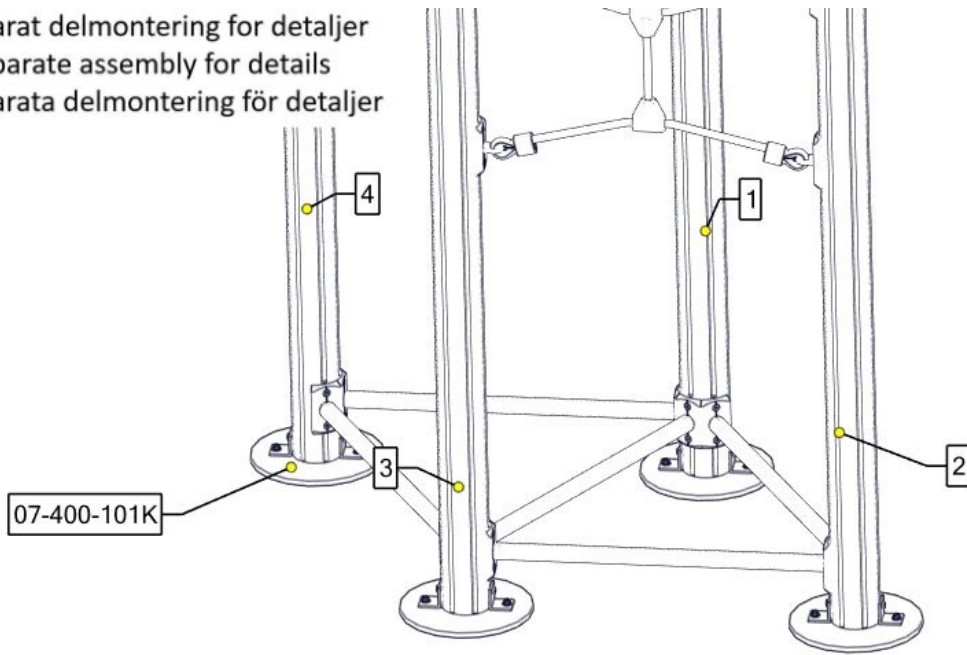

Part Name	Article nr.	Qty
Fundamentplate 1x110 stolpe komplett	07-400-101K	4

Se separat delmontering for detaljer
 See separate assembly for details
 Se separata delmontering för detaljer

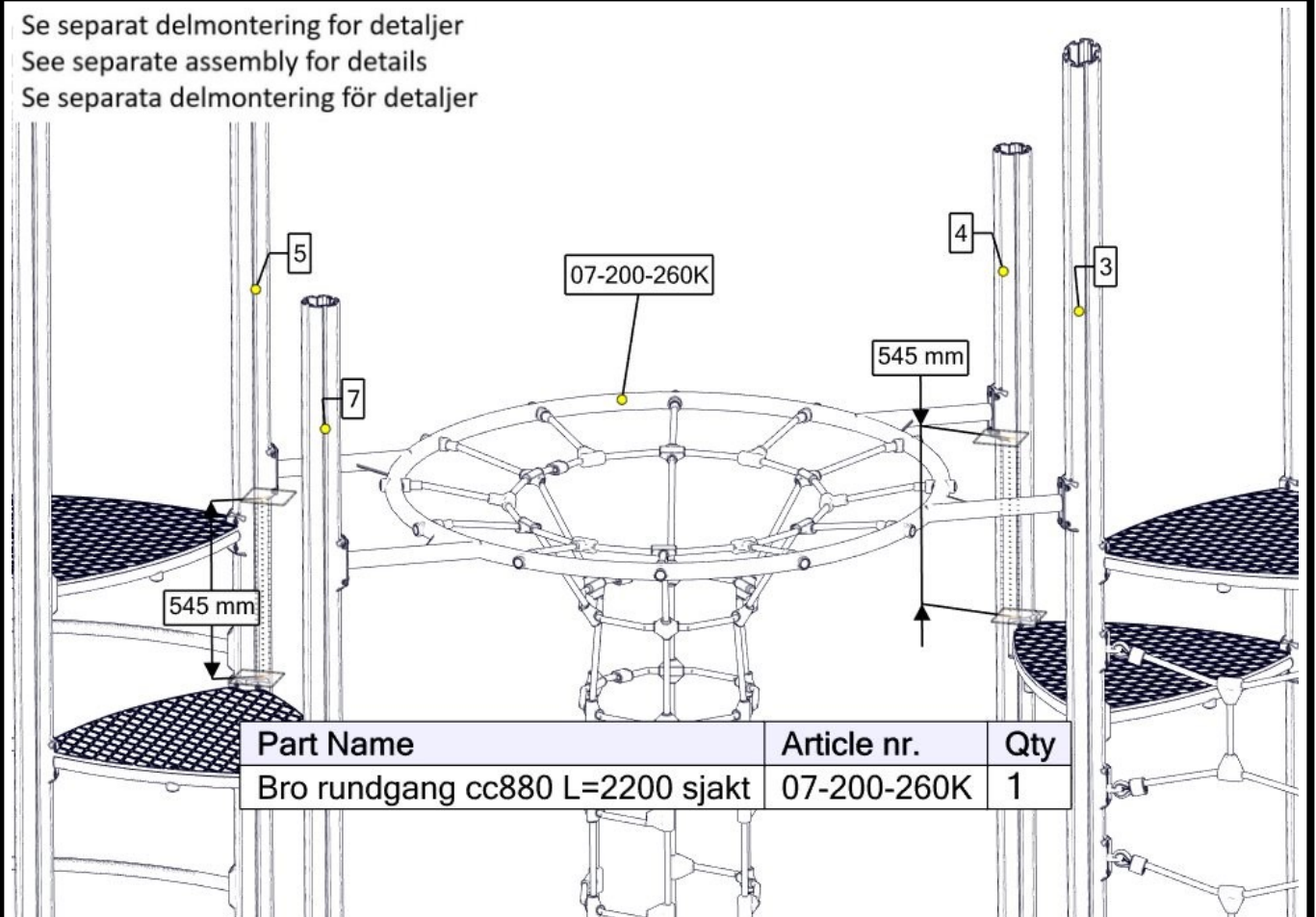

Part Name	Article nr.	Qty
Bro rundgang cc880 L=2200 sjakt	07-200-260K	1

Montering av lekeapparatet // Assembly instructions // Montering av lekredskapet

Se separat delmontering for detaljer
 See separate assembly for details
 Se separata delmontering för detaljer

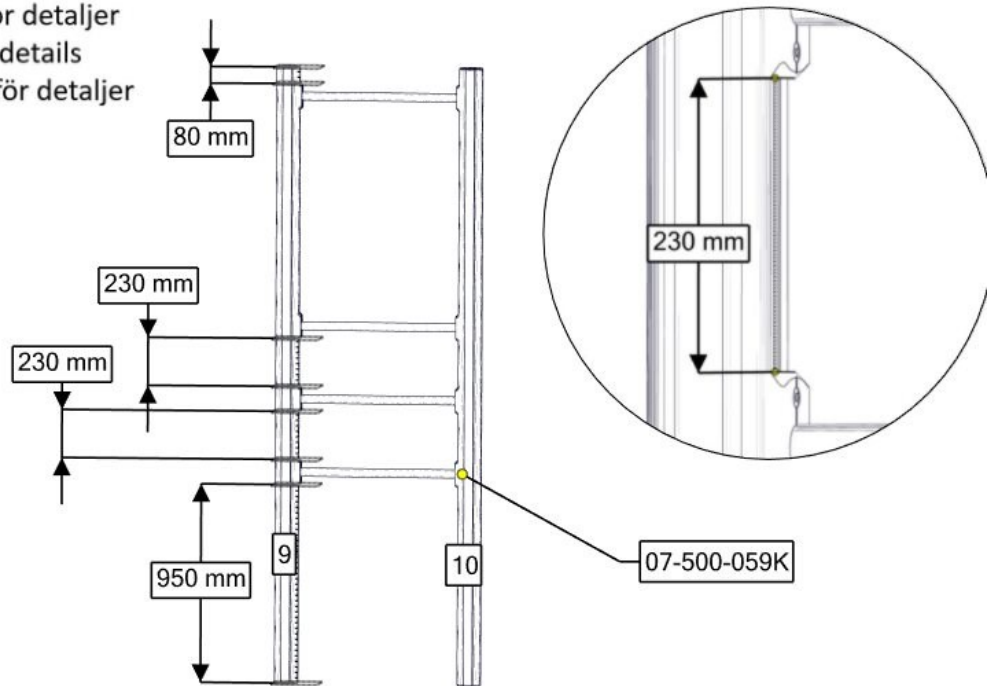

Part Name	Article nr.	Qty
Stolpe L=2950 (2350-600)	SFA5126	2
Sperrerør rett L=750 uten hull	07-500-059K	4

Se separat delmontering for detaljer
 See separate assembly for details
 Se separata delmontering för detaljer

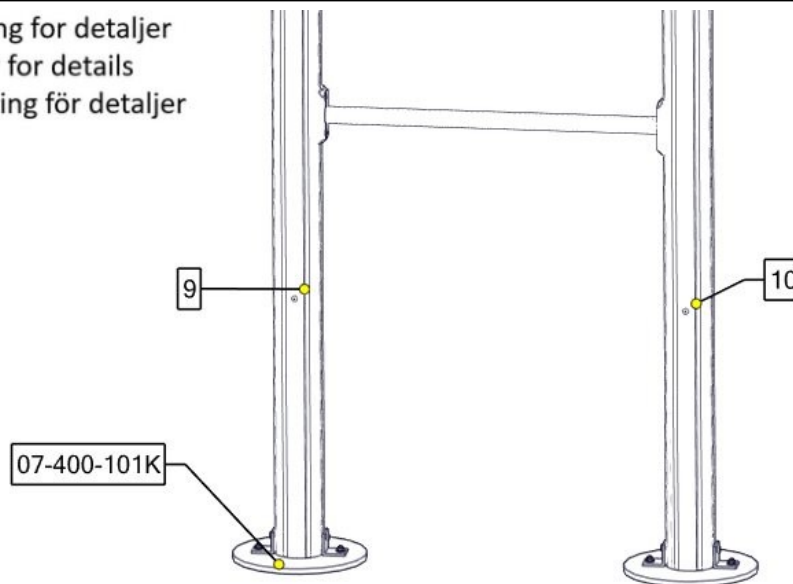

Part Name	Article nr.	Qty
Fundamentplate 1x110 stolpe komplett	07-400-101K	2

Montering av lekeapparatet / Assembly instructions / Montering av lekredskapet

Se separat delmontering for detaljer
 See separate assembly for details
 Se separata delmontering för detaljer

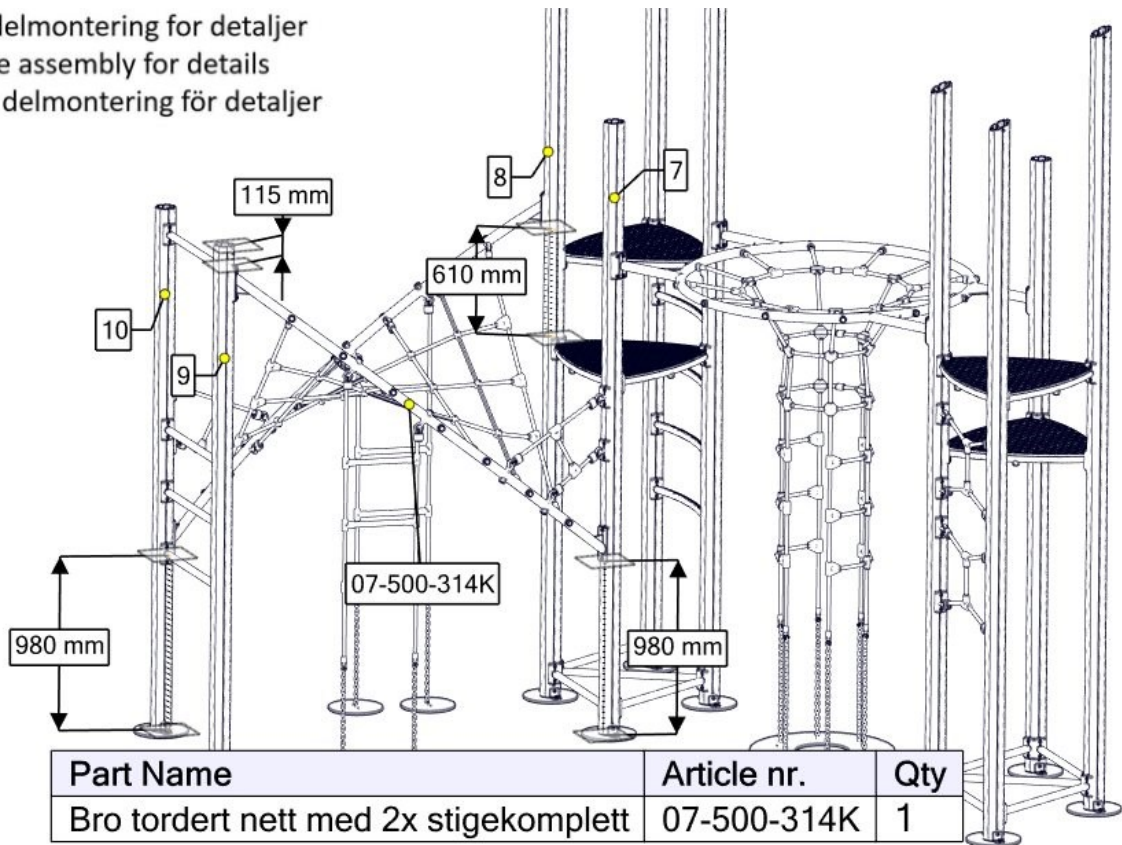

Se separat delmontering for detaljer
 See separate assembly for details
 Se separata delmontering för detaljer

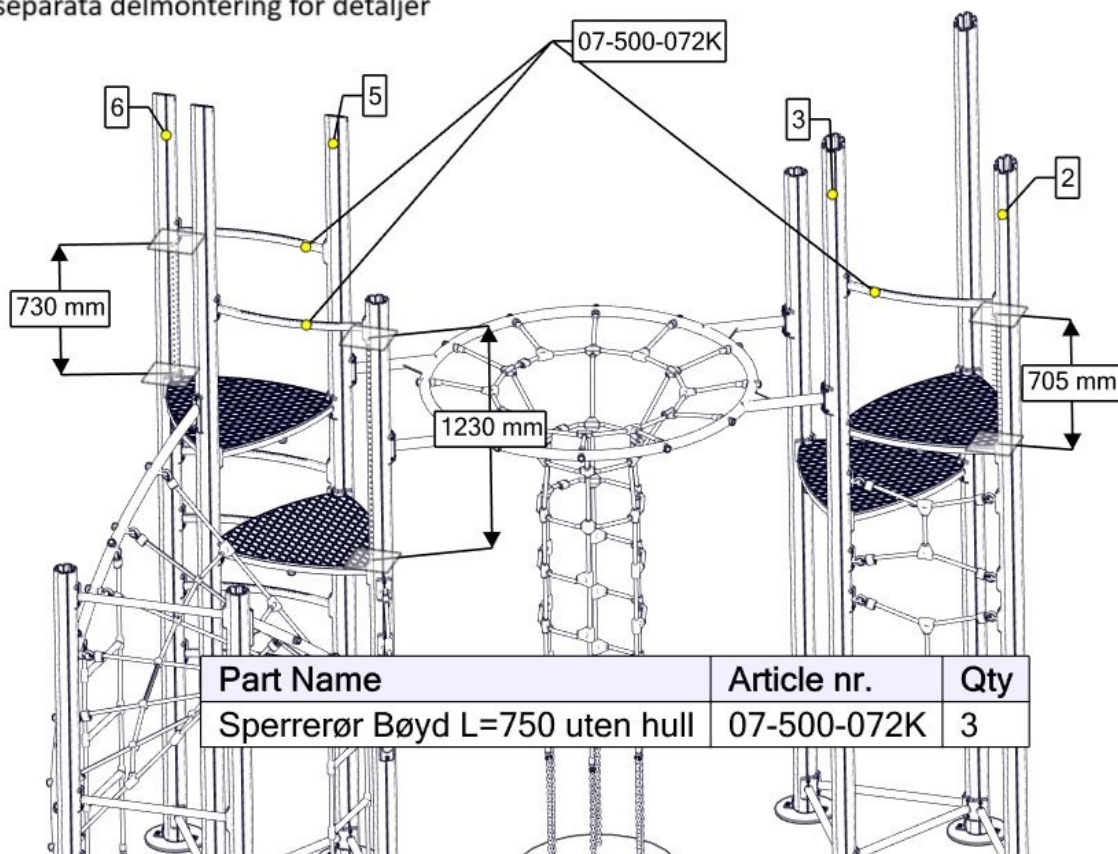

Montering av lekeapparatet / Assembly instructions / Montering av lekredskapet

Se separat delmontering for detaljer
 See separate assembly for details
 Se separata delmontering för detaljer

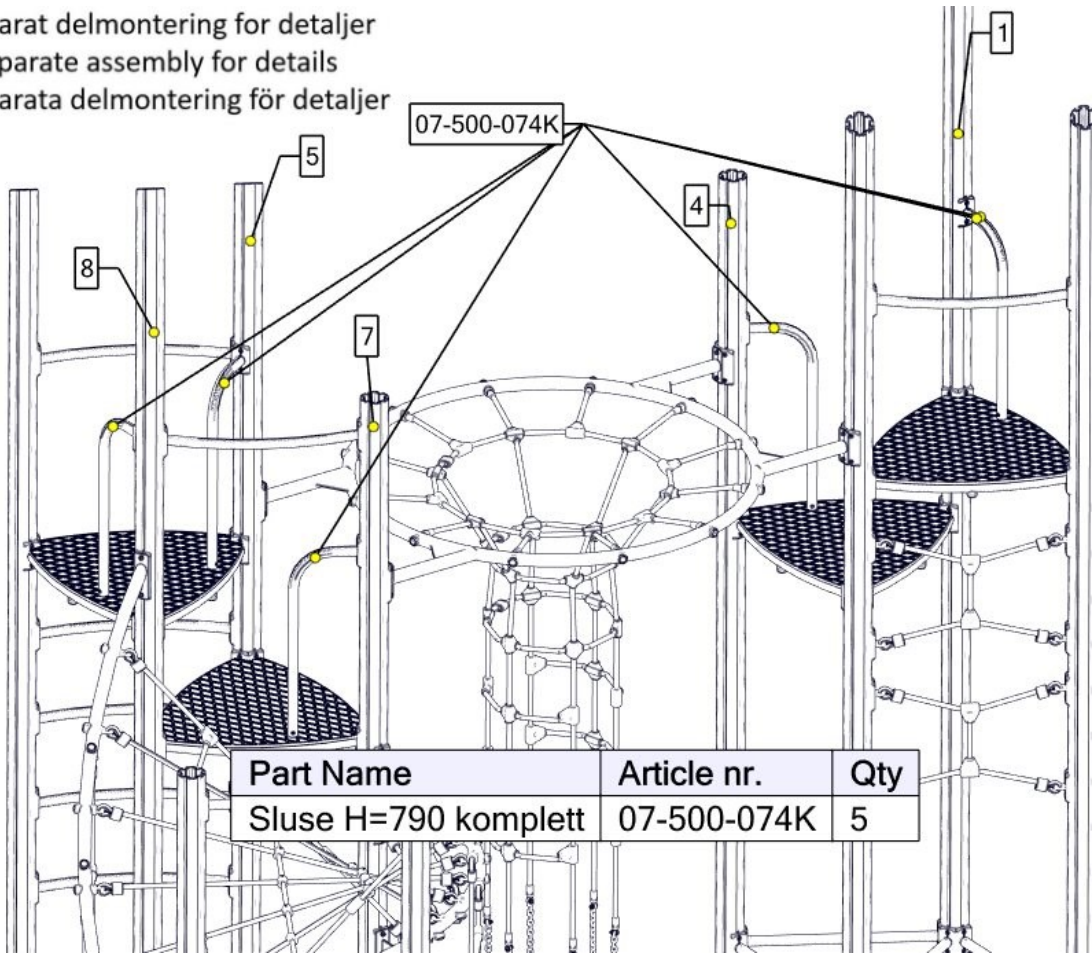

Part Name	Article nr.	Qty
Sluse H=790 komplett	07-500-074K	5

Se separat delmontering for detaljer
 See separate assembly for details
 Se separata delmontering för detaljer

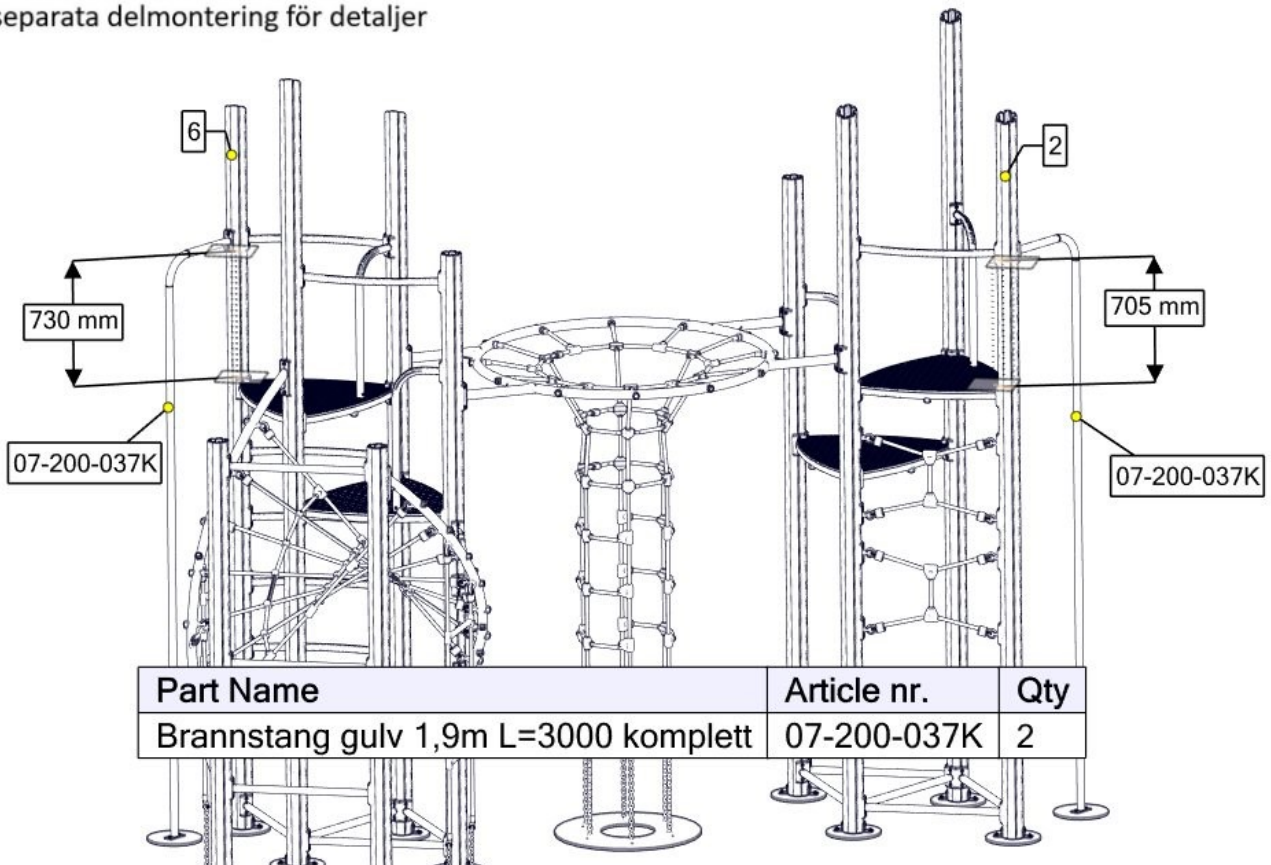

Part Name	Article nr.	Qty
Brannstang gulv 1,9m L=3000 komplett	07-200-037K	2

Montering av lekeapparatet / Assembly instructions / Montering av lekredskapet

Se separat delmontering for detaljer
 See separate assembly for details
 Se separata delmontering för detaljer

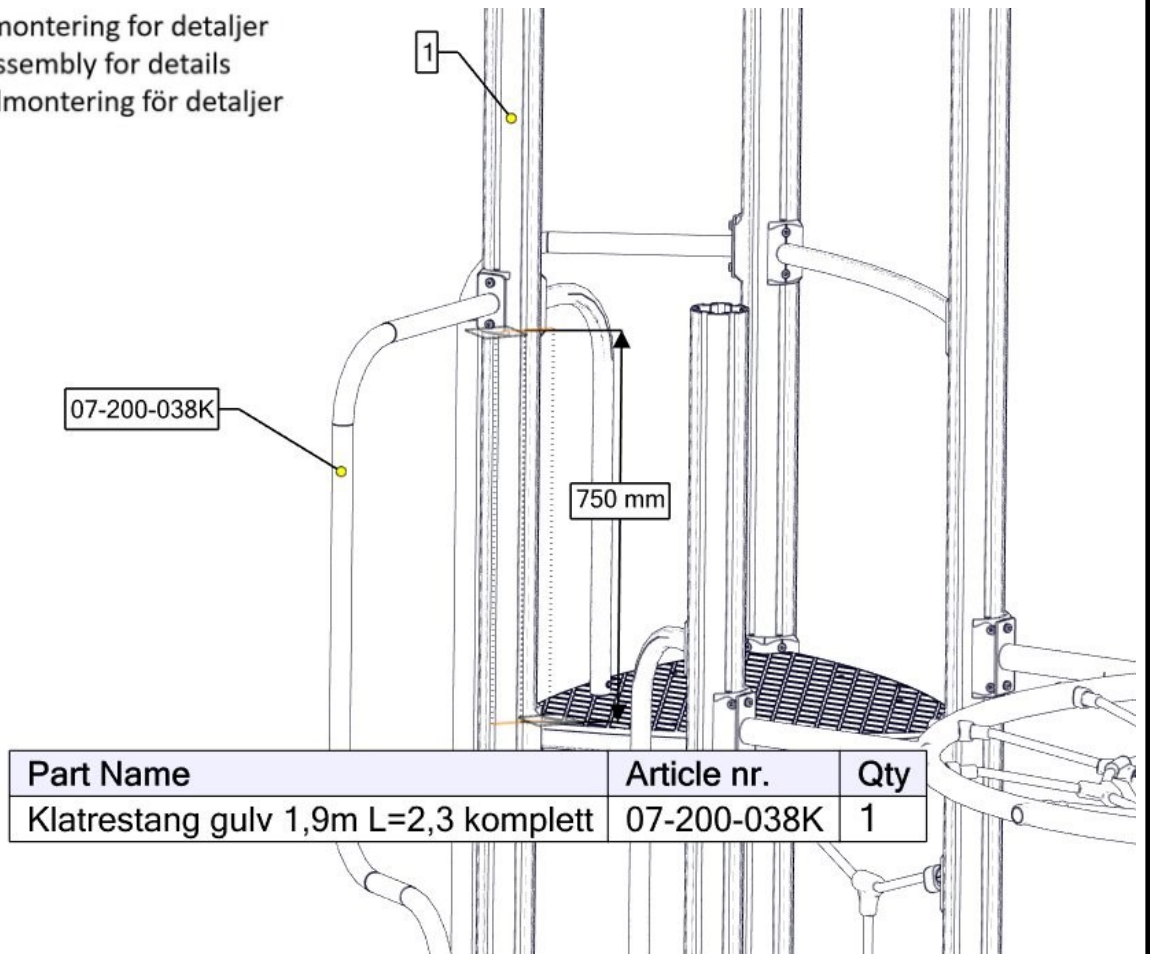

Se separat delmontering for detaljer
 See separate assembly for details
 Se separata delmontering för detaljer

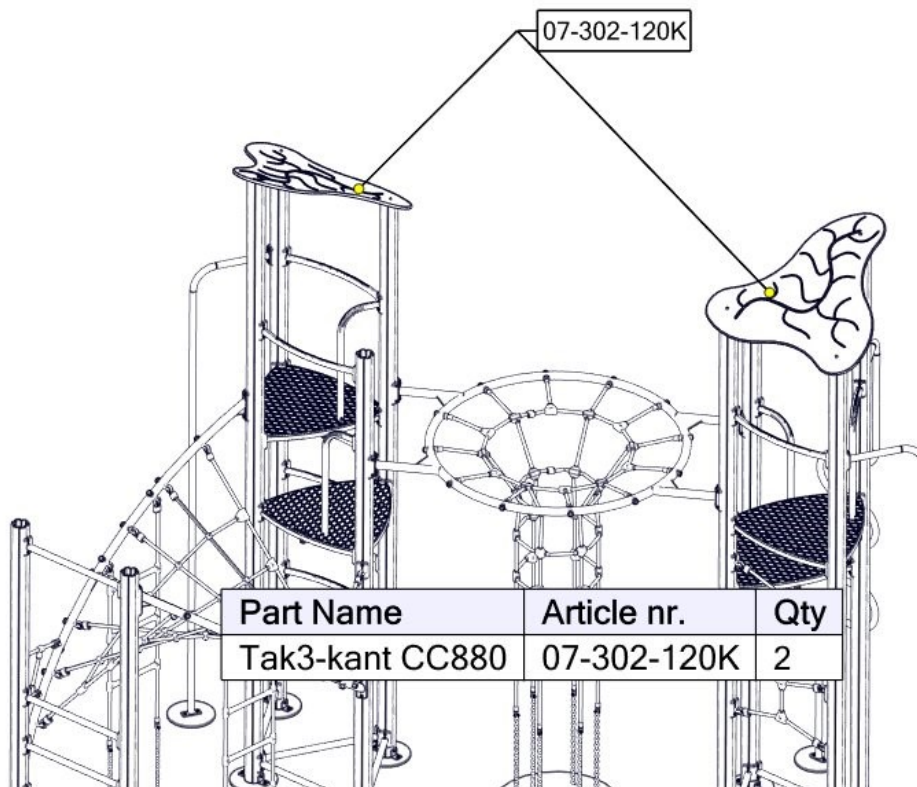





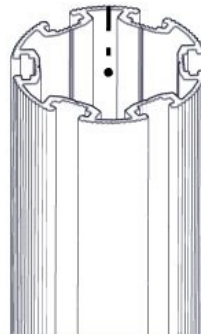
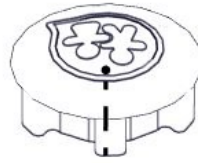

Montering av lekeapparatet / Assembly instructions / Montering av lekredskapet



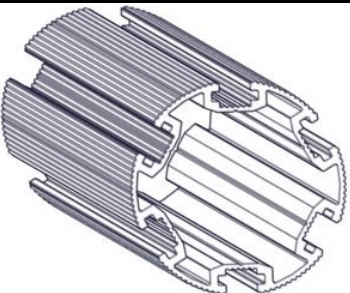

Se separat delmontering for detaljer
See separate assembly for details
Se separata delmontering för detaljer

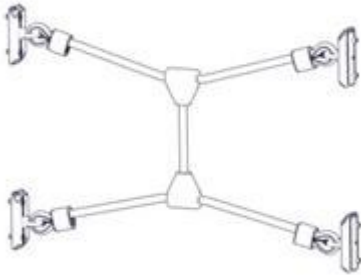

Part Name	Article nr.	Qty
Endelokk 110	00-400-995	4

Før utstyret tas i bruk / Before play begins / Innan lekredskapet tas i bruk	
N	<ul style="list-style-type: none"> ● Påse at fallunderlag er utlagt i henhold til gjeldende regler eller vår anbefaling ● Fjern alle monteringshjelpemidler (rester av betong, planker, paller, plast, og lignende) ● Før utstyret tas i bruk, burde man sjekke at det ikke er fare for at anorakksnorer og lignende som kan hekte seg fast noen steder på lekeapparatet. (Vedlagte snor med dobbe (kneledd) kan brukes til å sjekke at dette er i orden. Se vedlagte veiledning for bruk av denne. Dette gjøres for å oppdage eventuelle feilmonteringer.?) ● NB! Bør stå i 2-3 dager før bruk
EN	<ul style="list-style-type: none"> ● Make sure the area and depth of safer surfacing are according to the current standard, or to the manufacturer's recommendation ● Make sure all tools and surplus materials are removed before play begins ● PS! When complete, allow 2-3 days for the concrete to set before use
S	<ul style="list-style-type: none"> ● Kontrollera att fallunderlag är utlagt enligt gällande regler eller vårt rekommendation ● Ta bort alla monteringshjälpmedel (rester av betong, plankor, pallar, plast och liknande) ● Innan lekredskapet används, kontrollera att anoracksnoddar eller kläder/delar av kläder eller liknande inte kan fastna i några delar på redskapet. (Den bipackade "knävringen" kan man med fördel användas för denna kontroll. ● Detta görs för att upptäcka eventuella felmonteringar.)





Boltepakker for / Boltpackage for / Bultpaket för		Sign. _____		
Adventure Varden 16-501-014	Navn	Artnr/ dimensjon	Ant	Lev
	Stolpe Ø110 L=4050 skrå, Grå	07-100-352	4	
	Stolpe Ø110 L=4405 skrå, Grå	07-100-353	2	
	Stolpe Ø110 L=3450, Grå	SFA5126//2	2	
	Stolpe Ø110 L=2950, Grå	SFA5126/2	2	
	Endelokk til stolpe Ø110	00-400-995	4	
	Gulv 3-kant Standard CC880 Grå	07-300-104K (se egen delmontering)	4	
	Sperrerør Bøyd Lengde = 750 Uten hull Grønn	07-500-072K (se egen delmontering)	7	
	Sluse H=790 Grønn	07-500-074K (se egen delmontering)	5	
	Bro rundgang med sjakt CC880, L=2200 Grønn	07-200-260K (se egen delmontering)	1	

Boltepakker for / Boltpackage for / Bultpaket för		Sign. _____		
Adventure Varden 16-501-014	Navn	Artnr/ dimensjon	Ant	Lev
	Spideroppgang Komplett CC880 Grønn	07-500-266K (Se egen delmontering)	2	
	Sperrerør rett uten hull L=750 Grønn	07-500-059K (Se egen delmontering)	4	
	Bro tordert ned med 2x stige Grønn	07-500-314K (Se egen delmontering)	1	
	Brannstang Gulv H=1,9m Grå	07-200-037K (Se egen delmontering)	2	
	Klatrestang gulv H=1,9m Grå	07-200-038K (Se egen delmontering)	1	

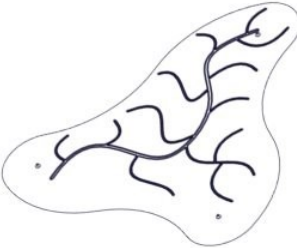
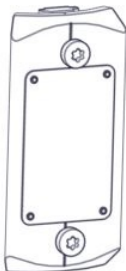
Boltepakker for / Boltpackage for / Bultpaket för

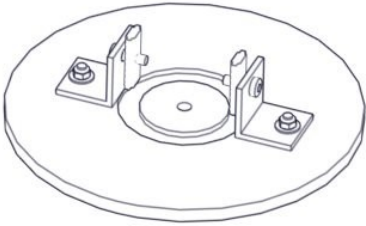
Sign. _____.

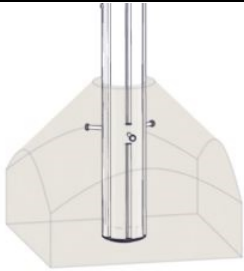
Adventure Varden 16-501-014	Navn	Artnr/ dimensjon	Ant	Lev
	Tak trekant CC880 Grå	07-302-120K (se egen delmontering)	2	
	Produktmerke	07-500-500 (se egen delmontering)	1	

Boltepakker for / Boltpackage for / Bultpaket för		Sign. _____		
Adventure Varden 16-501-014	Navn	Artnr/ dimensjon	Ant	Lev
	Fundament Nedgraving			
	Fundamentplate 1 x Ø110 stolpe	07-400-101K (se egen delmontering)	10	
	Sperrerør rett Lengde = 750 Uten hull Sort	07-500-075K (se egen delmontering)	9	
	Fundament Støp			
	Støpefundament Ø110 stolpe	00-003-111K (Se egen delmontering)	10	
	Sperrerør rett Lengde = 750 Uten hull Sort	07-500-075K (se egen delmontering)	9	

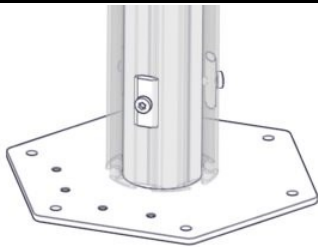
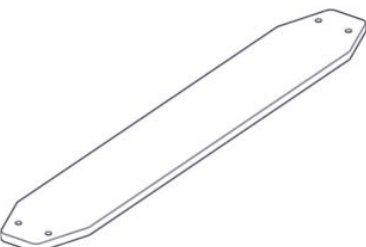
Boltepakker for / Boltpackage for / Bultpaket för		Sign. _____.		
Adventure Varden 16-501-014	Navn	Artnr/ dimensjon	Ant	Lev
	Overflate montering			
	Fundament 3xØ110 for Betongdekke	00-003-115K (se egen delemontering)	2	
	Fundament 1xØ110 for Betongdekke	00-003-113K (se egen delemontering)	4	
	Fundament sprosse til Betongdekke	00-003-131K (se egen delemontering)	4	
	Klatrestang kappes	07-200-038K	1	
	Brannstang kappes	07-200-037K	2	
	Stolpe kappes	SFA5126/1	10	

Revisjon:

04.09.2020 MTF

Lagt til tabell med mål, betong og vekt

Oppdatert fundamentbilder

Oppdatert side for fundament

Oppdatert bilde for «bolting»

Oppdatert div view

Oppdatert/endret bilder for sikkerhetssone, areal og stolpeplassering

Oppdatert SFA-Nr for stolper i plukkliste

MTK: 07-07-2022

Fundament sperrerø til fundamentside i plukklsit

MTK: 09-08-2023

Lagt inn overflatemontering