

N**Monteringsanvisning****EN****Assembly Instructions****S****Monteringsanvisning**

Produkt nr. / Product no. / Produkt nr.

16-600-130

Ord. nr. _____

Dato. _____

Sign. _____

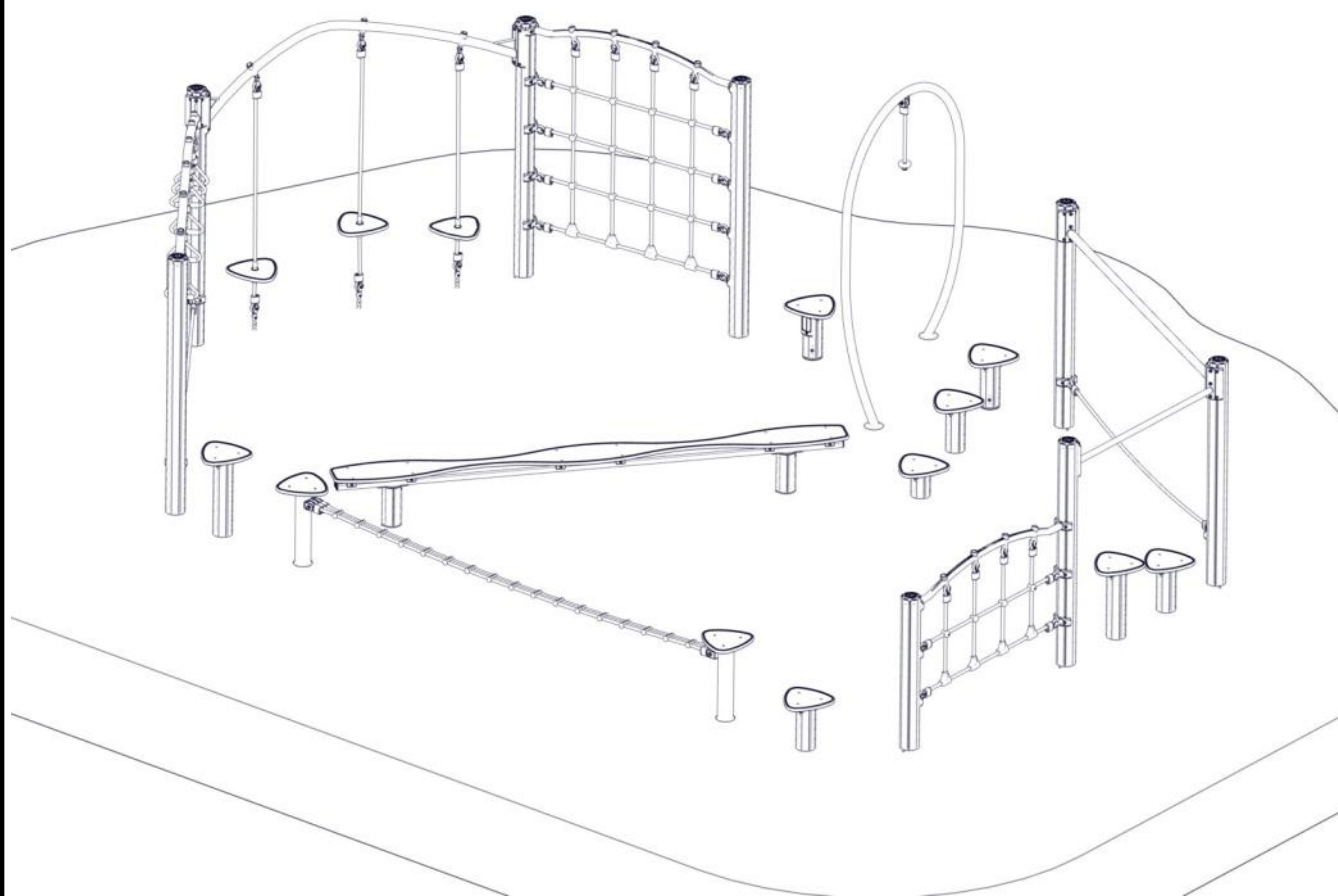
**søve**

Søve AS
Grønnvoldveien 290
3830 Ulefoss - Norway
Tlf: +47 35 94 65 65
www.sove.no



Søve AB
EA Rosengrensgatan 32
421 31 Västra Frölunda
Phone: +46 (0)31 773 97 00
www.sove.se

Monteringstips / Assembly Advice / Monteringsstips

N

- Les monteringsanvisningen nøye før montering.

- Monter elementene i rekkefølgen som vist.
- Boltene bør ikke skrues for hardt til før alt er montert, vatret og loddet. Skru så boltene til.
- NB! Ved bruk av drill, kan boltene ryke.
- På grunn av at solen kan gjøre rutsjeflaten veldig varm, bør rutsjebanens utløp vende mot nord-øst eller nord-vest.
- Er lekeutstyret plassert i naturlige ferdselstraséer må området sikres mot gjennomgang.
- Innspringningshinder bør vurderes rundt lekeapparater hvor det er stor bevegelse, f.eks. ved huskestativ.
- Det bør være fritt innsyn til lekeutstyr som er beregnet for barn under 3 år.

NB! Under monteringsarbeidet må utstyr, som ikke er forankret forsvarlig i bakken, sikres slik at det ikke velte.

Området må avstenges under montering av apparatene med sperrebånd eller lignende.

EN

- Read the instruction carefully before assembling the play unit.

- Assemble the components in the sequence shown in these instructions. Fixings must not be fully tightened during assembly. Before casting the foundations, the structure must be level and plumb, at which point all fixings are tightened. PS! If use of drill, the bolts may be wrecked.
- Avoid positioning the slide facing due south because of overheating – ideal positions are facing north-east or north-west. Secure the construction-area to prevent people from walking through it.
- Consider installing barriers around play-equipment which gives rise to a lot of activity – i.e. swings.
- Ensure that clear vision is possible across the play area so that supervision is possible from any position, particularly where children under 3 years of age will be playing.

NB! During assembly of the equipment, ensure that all structures are securely propped, especially when left overnight. Also ensure that equipment is supported

Monteringstips / Assembly Advice / Monteringsstips**S**

- Läs monteringsanvisningen noga före montering.

- Montera delarna i den ordningen som anvisas
- Skruvarna bör inte skruvas för hårt tills allt är monterat, i våg och lodat.









OBS! Används elektrisk skruvdragare, kan bulten gå sönder. Hårdra därför manuellt!

- Solen kan göra att rutchbanan blir väldigt varm. Banans nedfart rekommenderas att vändas i norrlig riktning
- Om lekplatsen placeras vid en gångväg mm bör området säkras mot genomfart av gående och cyklister.
- Insprängningshinder bör placeras runt lekutrustning med stor rörelse, t ex, gungställning.
- Det bör vara fri insyn till lekutrustning beräknat till barn under 3 år.

OBS! Under monteringsarbete bör utrustningen som inte ska förankras i marken, ställs så att den inte kan välta.

Området måste spärras när lekutrustningen byggs upp, med avspärrningsband eller liknande.

Nødvendig verktøy / Tools required / Nödvändiga verktyg



<p>(N)</p> <p>(EN)</p> <p>(S)</p>	<p>(A)</p> 	<p>(B)</p>  <p>Torx Nr 45</p>	<p>(C)</p> <p>5 mm 6 mm</p> 	<p>(D)</p> 	<p>(E)</p>
		<p>Metermål Metric measure Tumstock</p> 	<p>Ø11mm Bor Ø11mm Drill Ø11mm Borr</p> 	<p>Merkebånd Mark ribbon Märkeband</p> 	<p>13 + 17mm</p> 



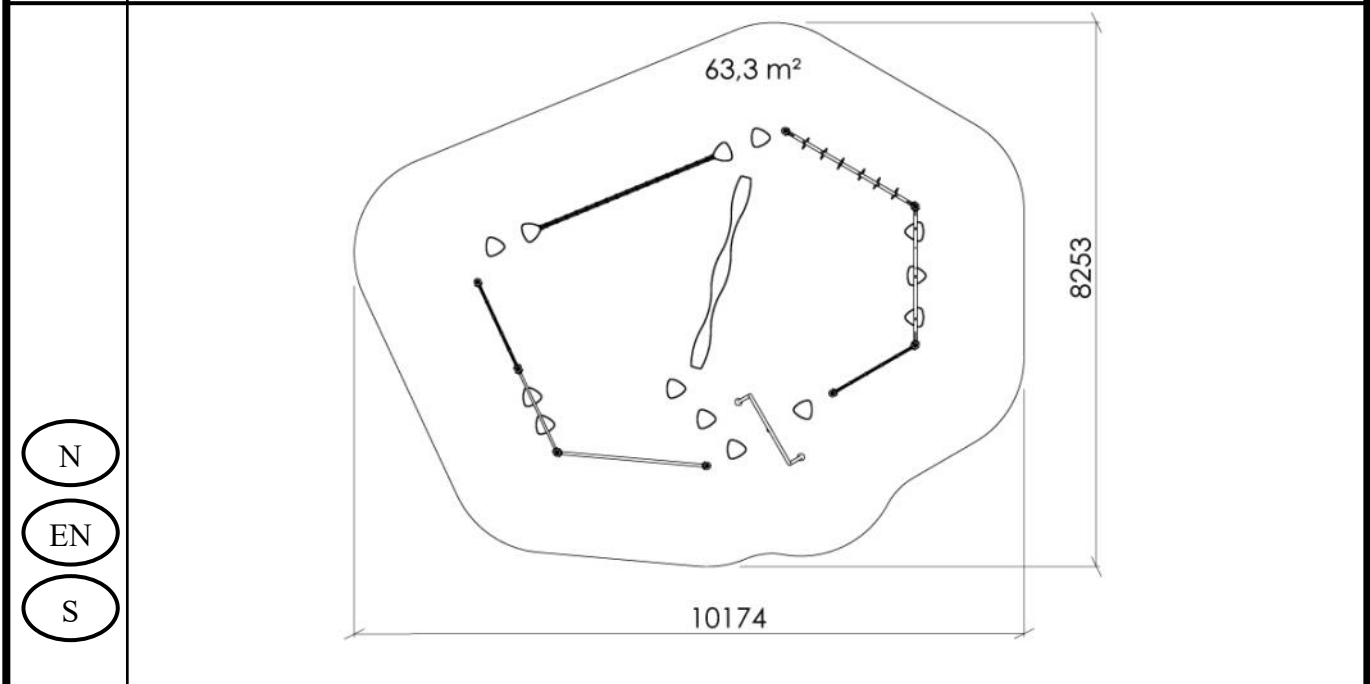

Nødvendig antall personer / Number of persons required / Rekommenderad antal personer

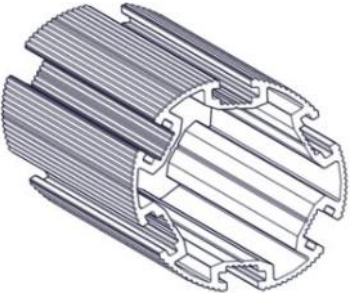

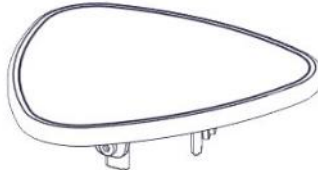
Anbefalt arealbehov ved montering / Recommended working space / Rekommenderad arealbehov ved montering

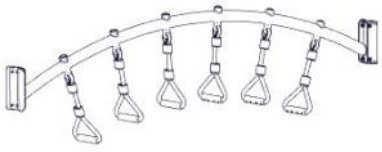

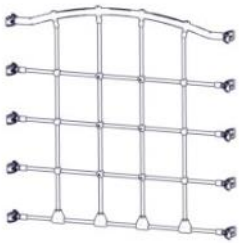
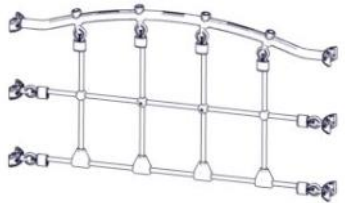



Boltepakker for / Boltpackage for / Bultpaket för		Sign. _____.		
16-600-130 Grønn - grå	Navn	Artnr/ dimensjon	Ant	Lev
	Stolpe Ø110 L=2200 (1600-600)	SFA5126/2	4	
	Stolpe Ø110 L=2000 (1400-600)		3	
	Stolpe Ø110 L=1550 (950-600)		1	
	Stolpe Ø110 L=1100 (500-600)		1	
	Stolpe Ø110 L=1050 (450-600)		1	
	Stolpe Ø110 L=900 (300-600)		3	
	Stolpe Ø110 L=780 (180-600)		1	
	Rør 3X Monkeyseat Saturn inkl 30gr beslag Grønn	07-300-407K (Se egen delmontering)	1	
	Monkeyseat 3kant HPL med tau			
	Mini del 1	07-500-485K	1	
	Mini del 2	07-500-486K	1	
	Mini del 3	07-500-487K	1	
	3 kant steppern	06-100-117K (se egen delmontering)	6	

Boltepakker for / Boltpackage for / Bultpaket för		Sign. _____		
16-600-130 Grønn - grå	Navn	Artnr/ dimensjon	Ant	Lev
	Armgang L=2156 Polyfix 3-kant 30gr komp Grønn	07-500-458K (se egen delmontering)	1	
	Balansetau L=2156 inkl 30gr beslag	07-500-029K (se egen delmontering)	2	
	Nett vertikal mini med 30 grader beslag og rør Grønn rør / sort nett	07-510-199K (se egen delmontering)	1	
	Nett vertikal mini med 30 grader beslag Grønn	07-510-230K (Se egen delmontering)	1	
	Workout rør Ø33mm L=170 med 30 grader beslag Grønn	07-200-174K (Se egen delmontering)	1	
	Workout rør Ø44mm L=2286, 30 grader beslag Grønn	07-200-151K (Se egen delmontering)	1	

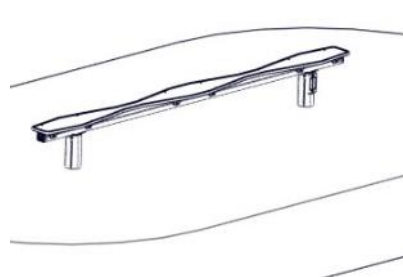
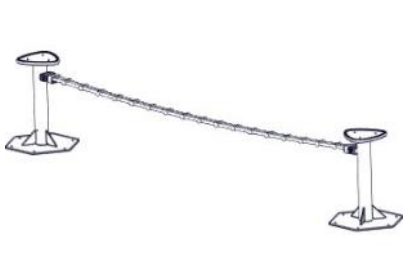
Boltepakker for / Boltpackage for / Bultpaket för

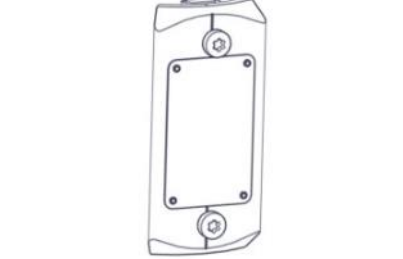
Sign. _____

16-600-130 Grønn - grå	Navn	Artnr/ dimensjon	Ant	Lev
	Mini Jungeltauet	16-610-010 (se egen montering)	1	
	Balansebom bølge	30-180-060 (se egen montering)	1	
	Taustien	30-180-040 (se egen montering)	1	
	Endelokk stolpe Ø110	00-400-995	8	
	Produktmerke	07-500-500 (Se egen delmontering)	1	

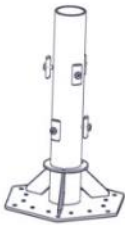
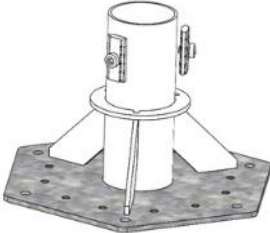
Boltepakker for / Boltpackage for / Bultpaket för		Sign. _____		
16-600-130 Grønn - grå	Navn	Artnr/ dimensjon	Ant	Lev
	Fundament Støp			
	Støpefundament Stolpe Ø110	00-003-111K (se egen delmontering)	14	
	Overflate montering			
	Fundament 1x 110 stolpe for betongdekk Ekstra	00-003-137K (se egen delmontering)	9	
	Fundament 1x 110 stolpe for betongdekk Ekstra og Kort	00-003-151K (se egen delmontering)	5	
	Pass på 30-180-060			

Fundamentering med betong / Foundation concrete / Förankring med betong

- (N) Støtdempende materialer
- (EN) Impact attenuating materials
- (S) Støtdämpande material Ref NS-EN 1176-1 §4.2.8.5

- (N) Bakkenivå
- (EN) Ground level
- (S) Marknivå

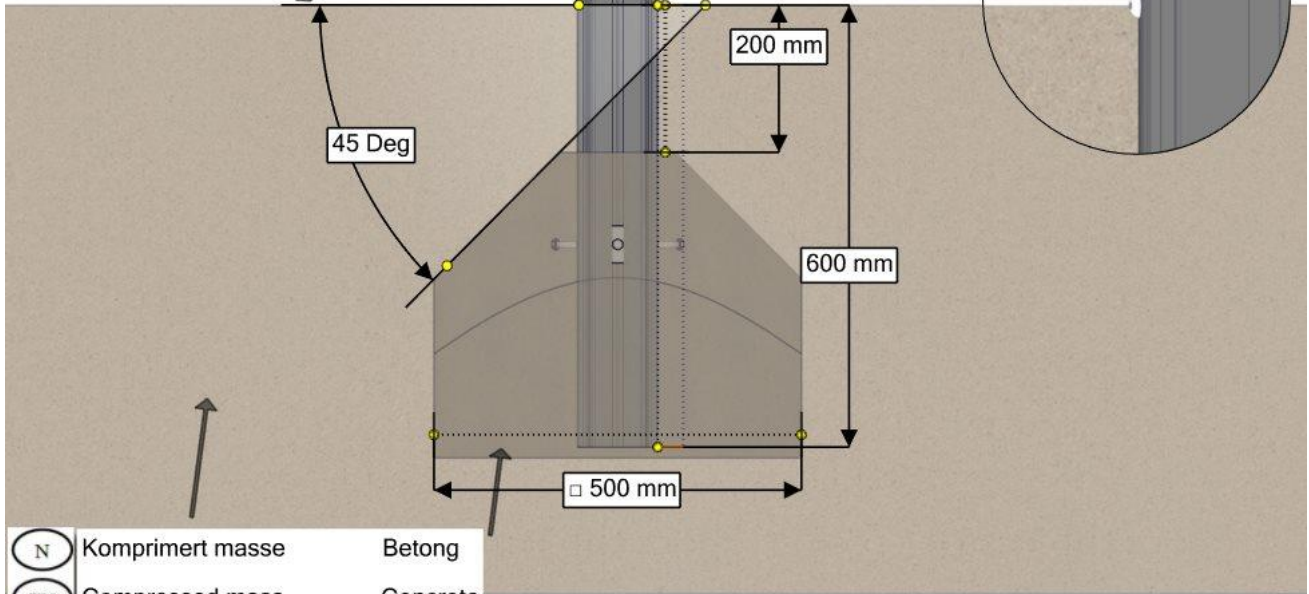
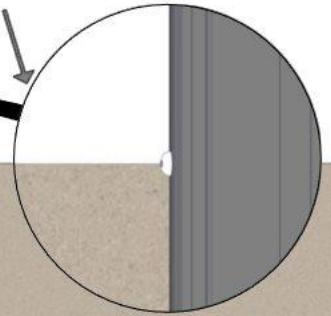

- (N) Komprimert masse Betong
- (EN) Compressed mass Concrete
- (S) Komprimerad massa Betong

Overflatemontering / Surface mounting / Ytmontering -

Ref NS-EN 1176-1 §4.2.8.5

- (N) Bakkenivå
- (EN) Ground level
- (S) marknivå

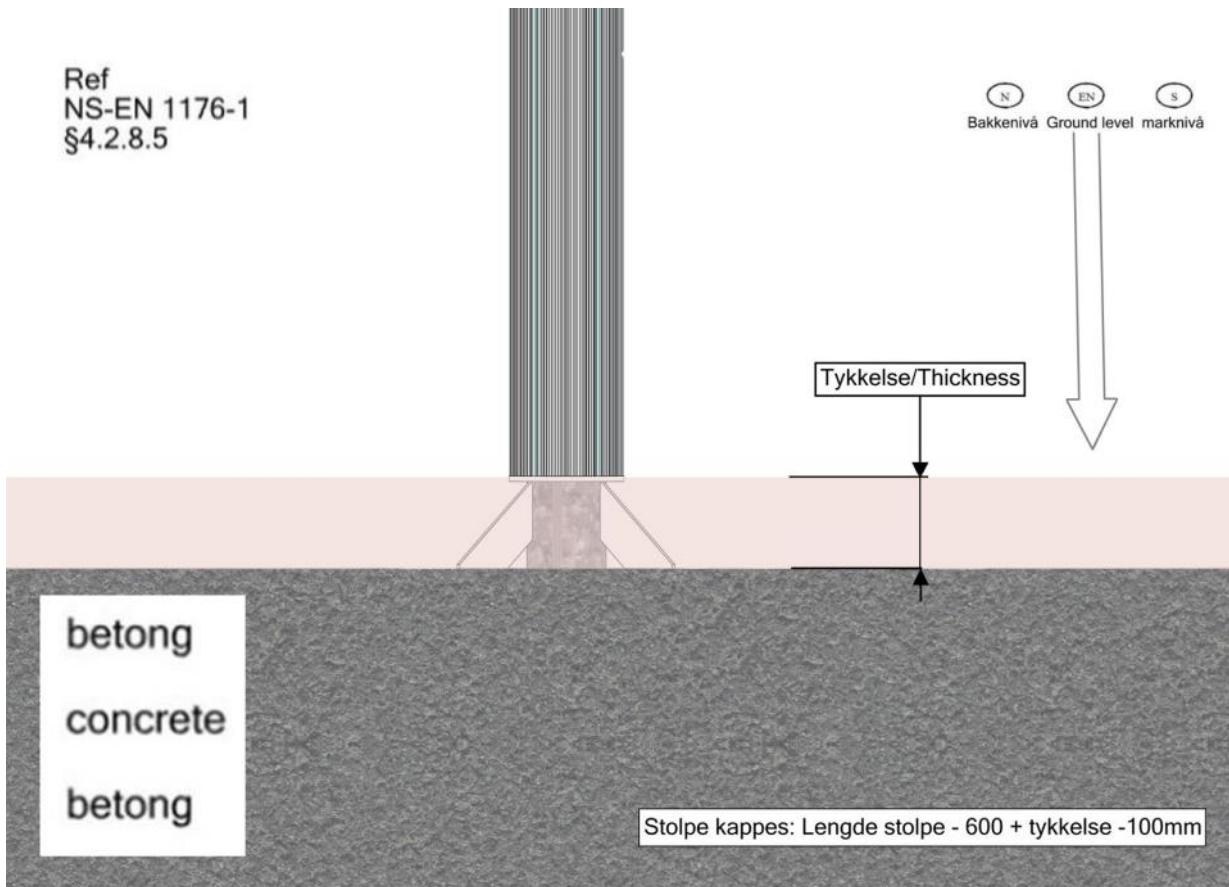

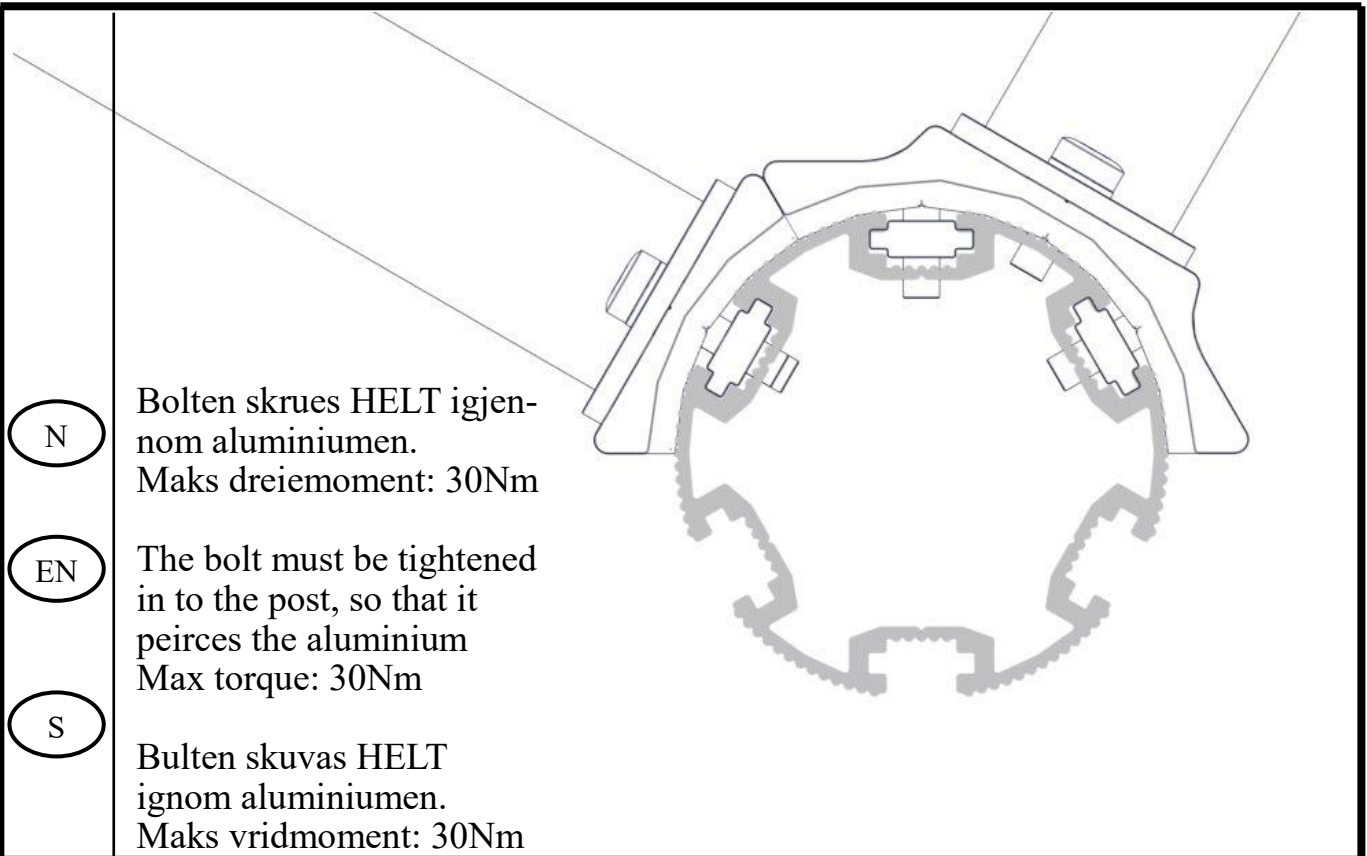

NO	Betongkvalitet	C25/30		
SE	Betongkvalitet			
EN	Concrete quality			
NO	Mengde betong	16-610-010 30-180-040 Stolper (16)	1,3 1,0 1,6 3,9	m ³
SE	Mängd betong			
EN	Amount of concrete			
NO	Fundament størrelse	0,5 x 0,5 x 0,4		m
SE	Stiftelsestorlek			
EN	Foundation size			
NO	For sikkerhet må fundamentene med sand eller myk jord være minst 50% større i areal			
SE	För säkerheten måste grunden med sand eller mjuk jord vara minst 50% större i området			
EN	For safety, the foundations with sand or soft soil must be at least 50% larger in area			
NO	Tyngste element	07-303-321	14,7	Kg
SE	Tyngsta element			
EN	Heaviest element			
NO	Største element	07-303-321 06-100-113	1,2x0,6x1,9 3x0,2x0,1	m
SE	Största element			
EN	Biggest element			

Fallhøyder / Free height of fall / Fallhöjder

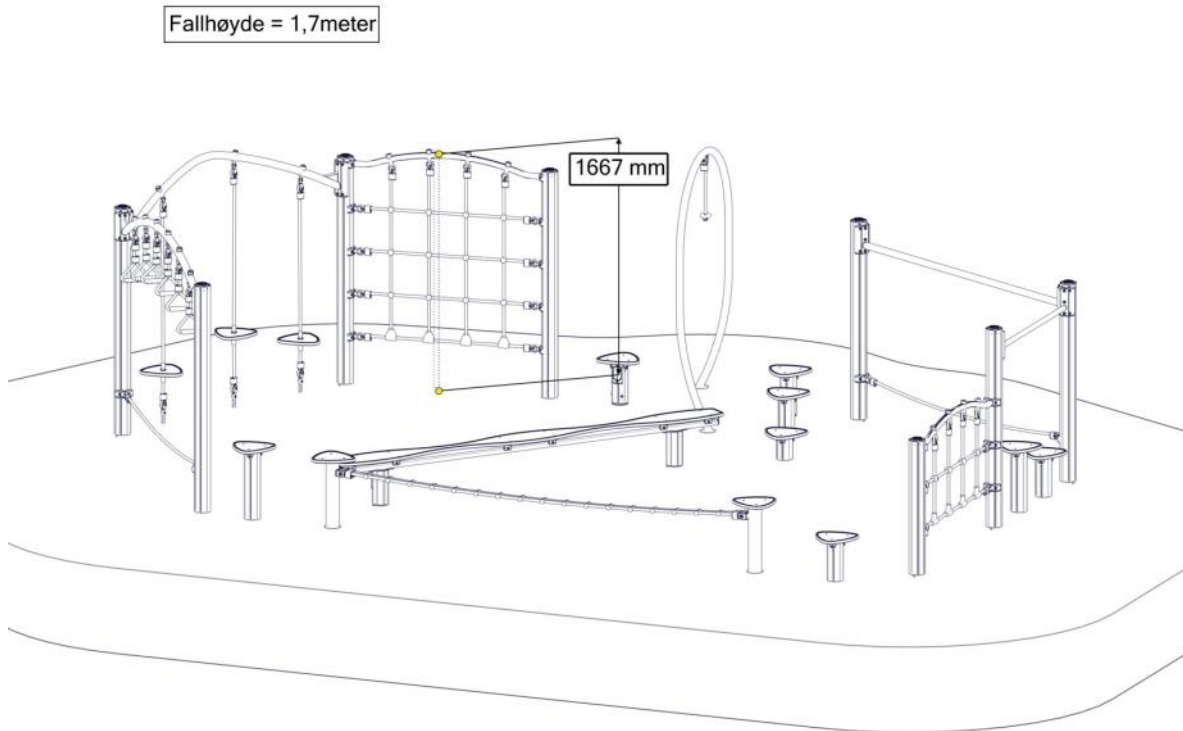

Sikkerhetssone / Safety zone / Säkerhetszon

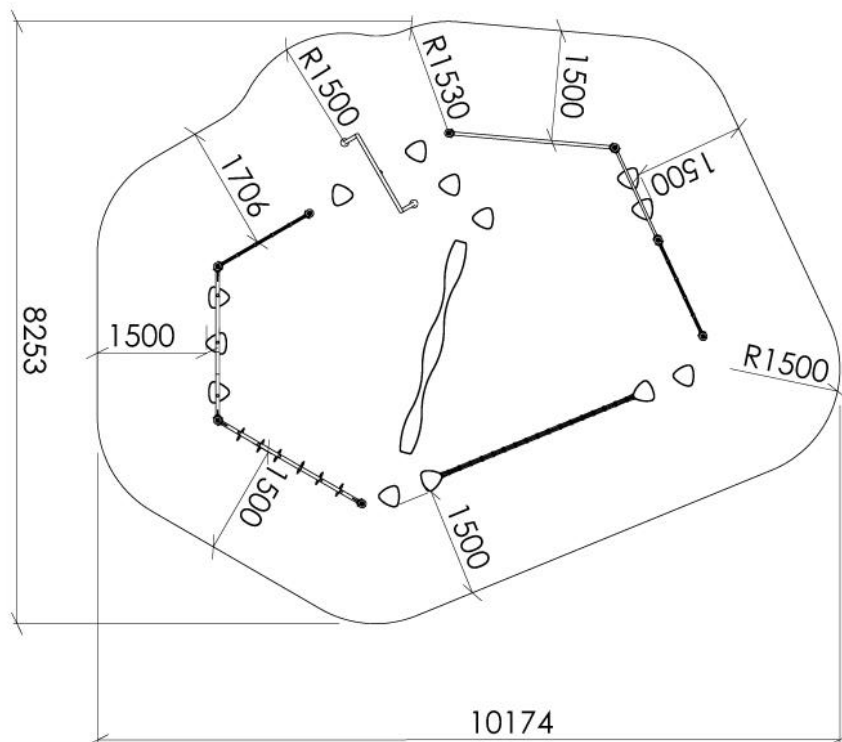

Plassering av forankringer / Ground plan / Placering av förankringar

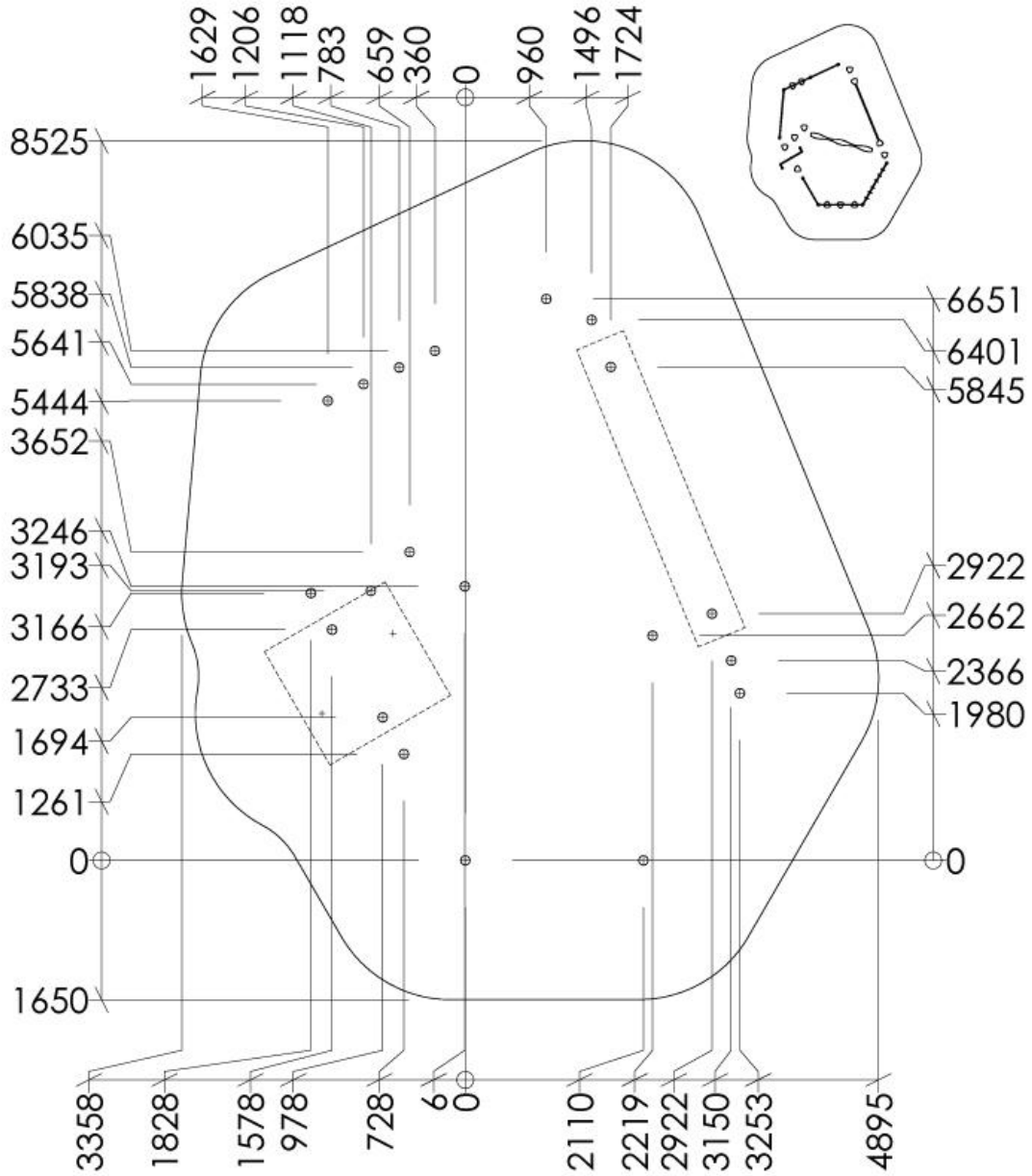

N

Alle mål er oppgitt i millimeter

EN

Scale measured in mm

S

Alla mått är i millimeter.

Montering av lekeapparatet / Assembly instructions / Montering av lekredskapet

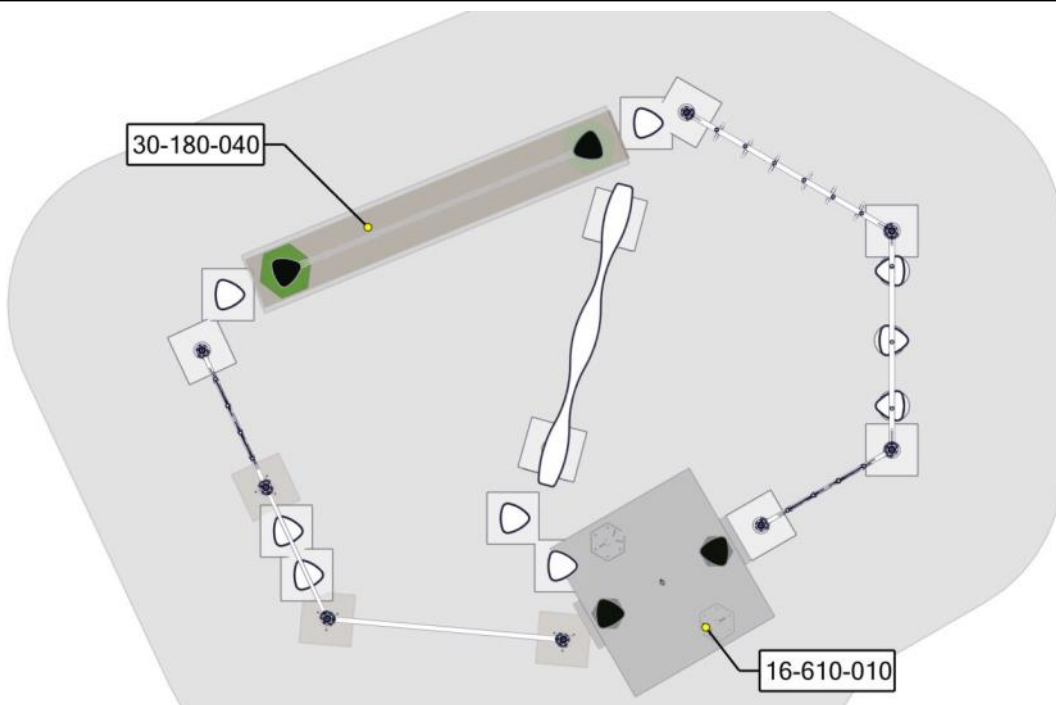
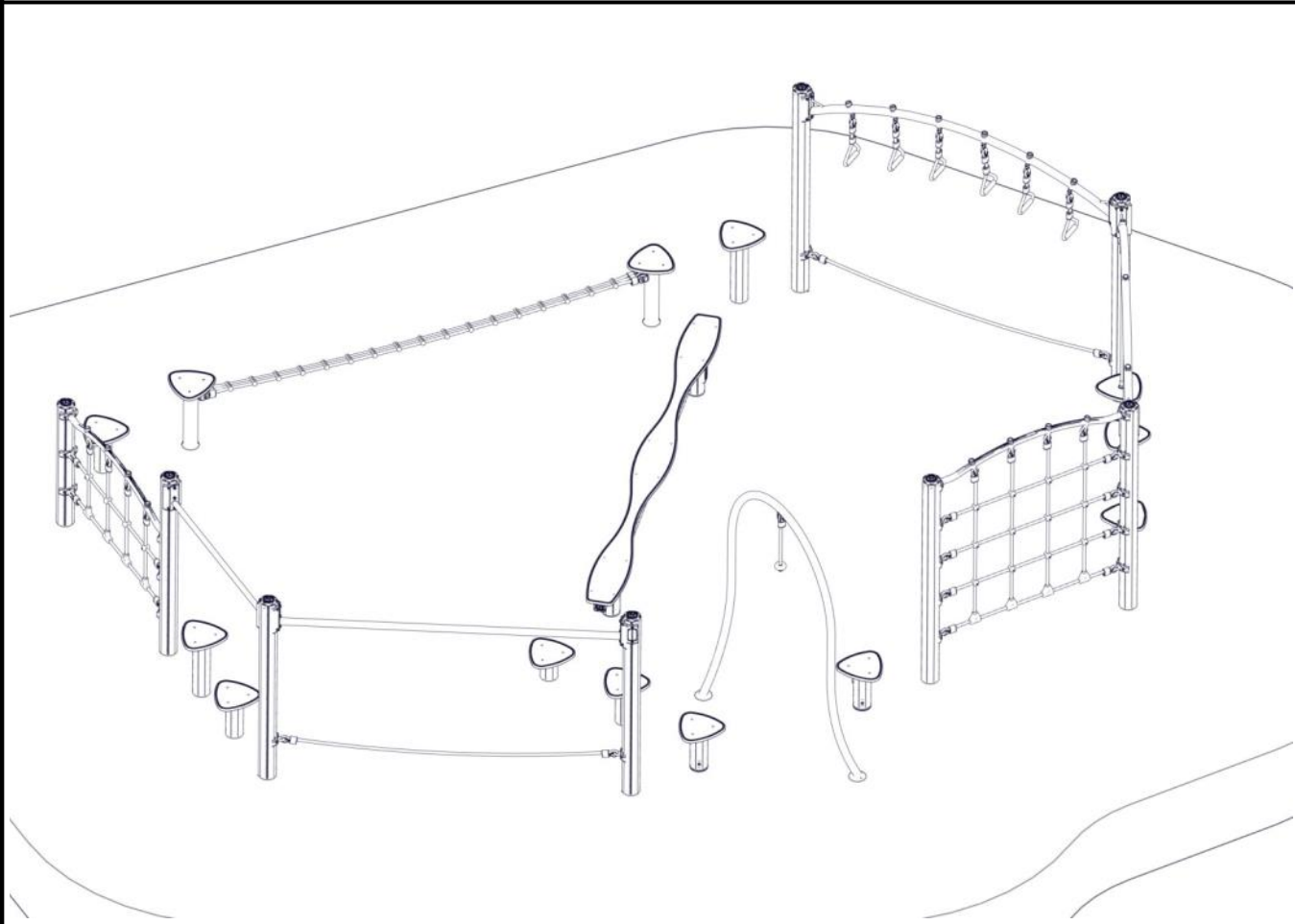

PartName	Artnr	Antall
Mini Jungeltauet	16-610-010	1
TauStien	30-180-040	1

Montering av lekeapparatet / Assembly instructions / Montering av lekredskapet

Se separat delmontering for detaljer
 See separate assembly for details
 Se separata delmontering för detaljer

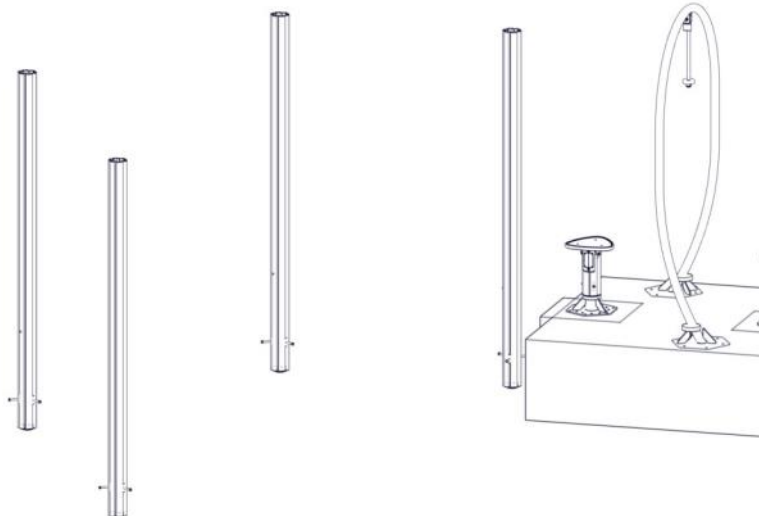

PartName	Artnr	Antall
Støpe fundament Ø 110	00-003-111K	4
Stolpe Ø110 Lengde=2200	SFA5126/2	4

Se separat delmontering for detaljer
 See separate assembly for details
 Se separata delmontering för detaljer

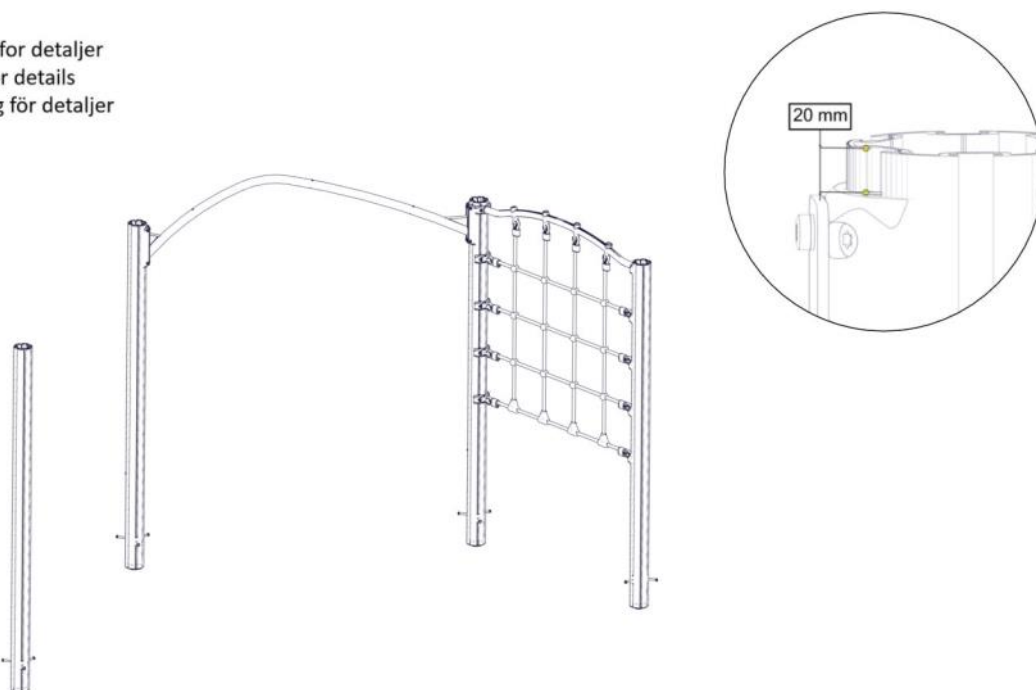

PartName	Artnr	Antall
Rør Monkeyseat Saturn inkl 30gr beslag	07-300-407K	1
Nett_vert_26serieKomplettmedRor	07-510-199K	1

Montering av lekeapparatet / Assembly instructions / Montering av lekredskapet

Se separat delmontering for detaljer
 See separate assembly for details
 Se separata delmontering för detaljer

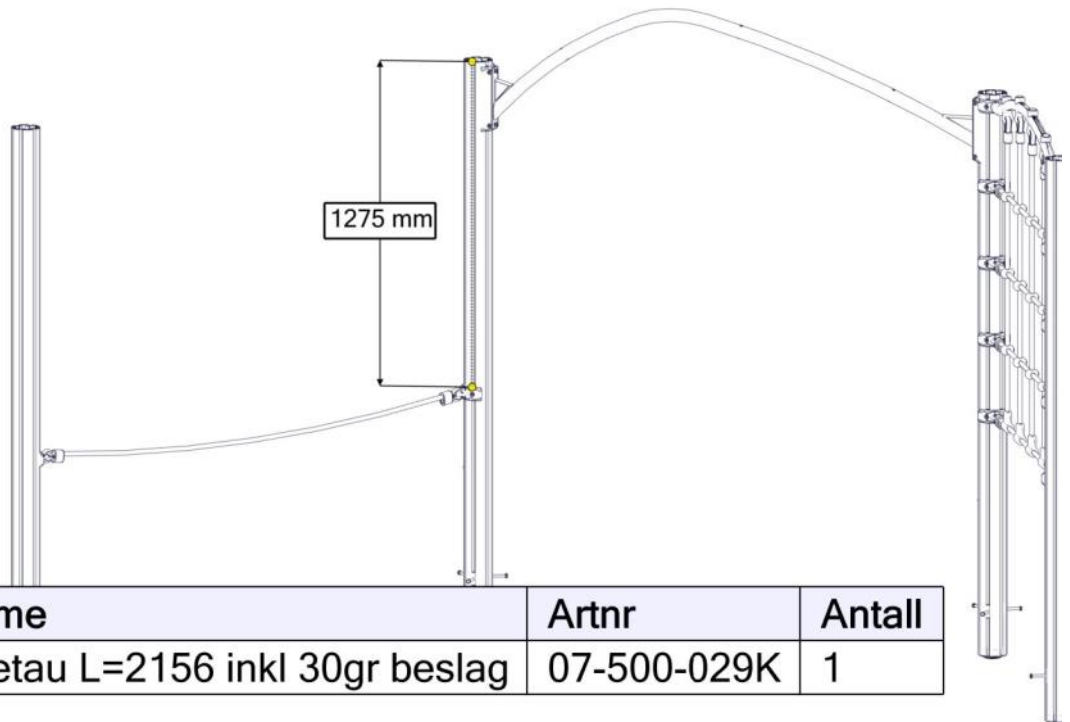

PartName	Artnr	Antall
Balansetau L=2156 inkl 30gr beslag	07-500-029K	1

Se separat delmontering for detaljer
 See separate assembly for details
 Se separata delmontering för detaljer

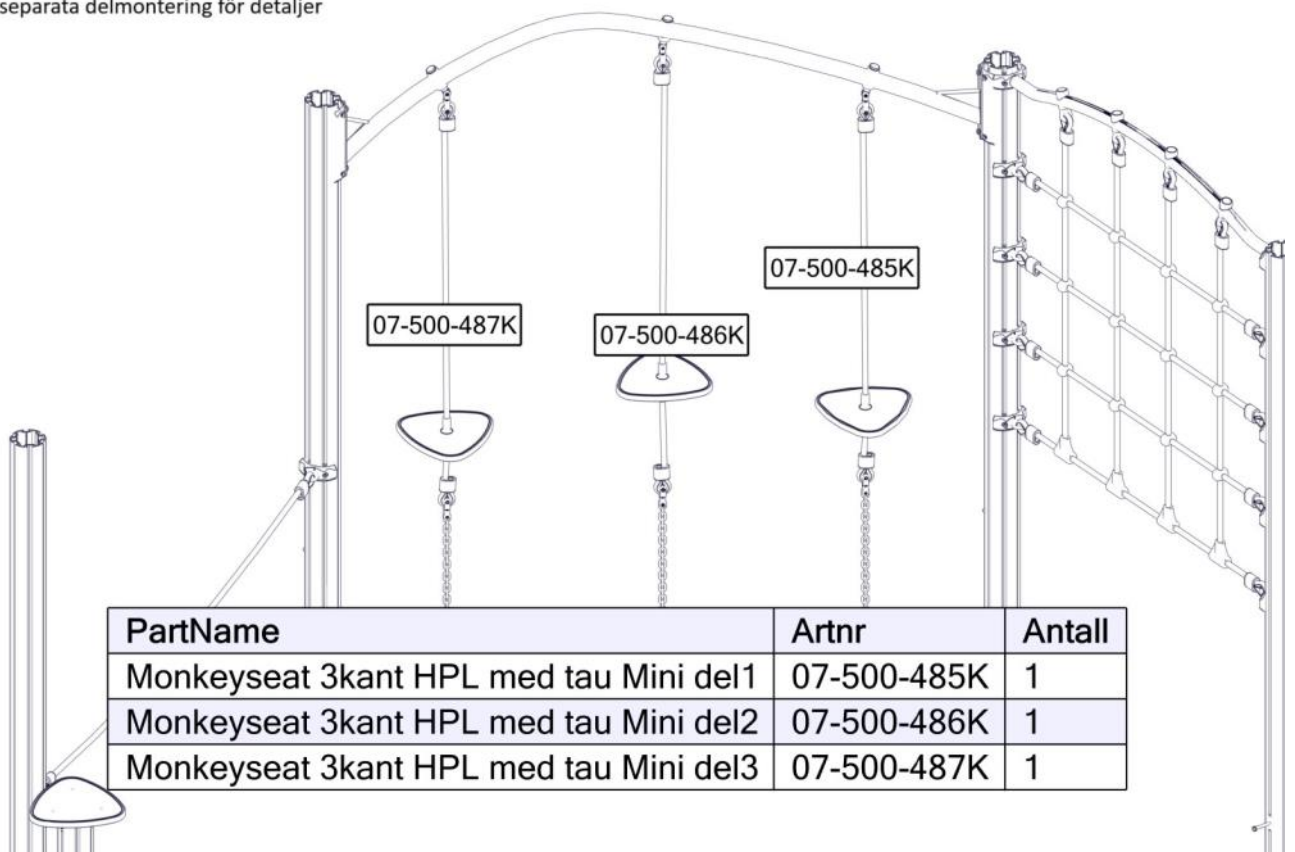

PartName	Artnr	Antall
Monkeyseat 3kant HPL med tau Mini del1	07-500-485K	1
Monkeyseat 3kant HPL med tau Mini del2	07-500-486K	1
Monkeyseat 3kant HPL med tau Mini del3	07-500-487K	1

Montering av lekeapparatet / Assembly instructions / Montering av lekredskapet

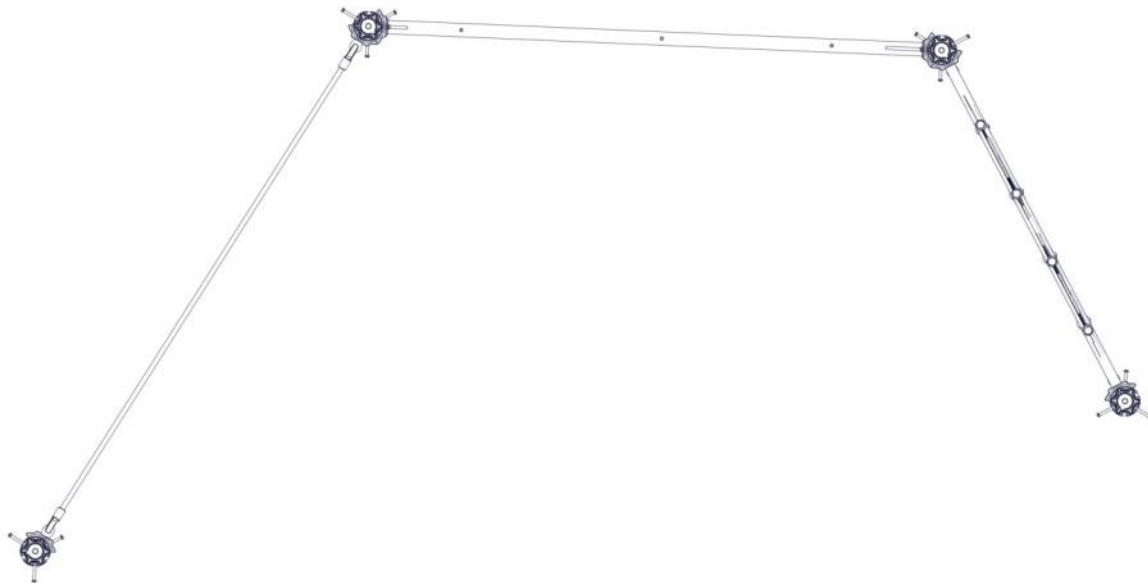

Se separat delmontering for detaljer
 See separate assembly for details
 Se separata delmontering för detaljer

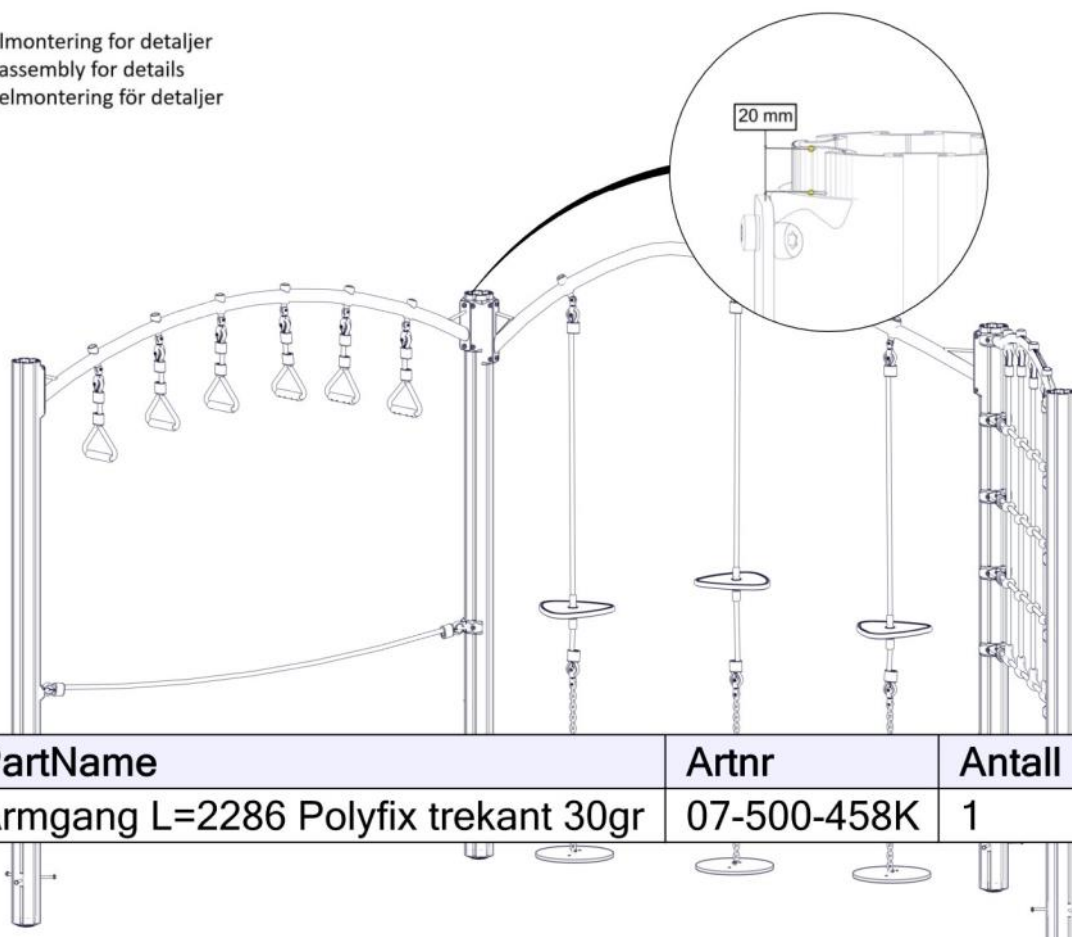

PartName	Artnr	Antall
Armgang L=2286 Polyfix trekant 30gr	07-500-458K	1

Montering av lekeapparatet / Assembly instructions / Montering av lekredskapet

Se separat delmontering for detaljer
See separate assembly for details
Se separata delmontering för detaljer

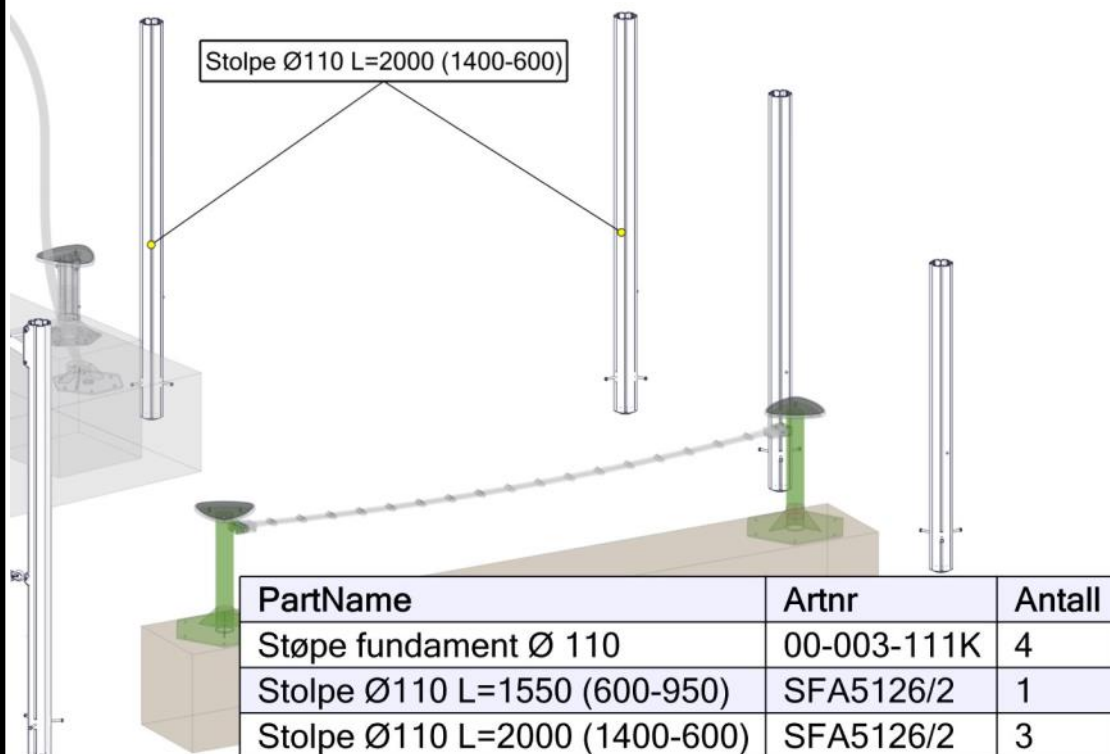

Se separat delmontering for detaljer
See separate assembly for details
Se separata delmontering för detaljer

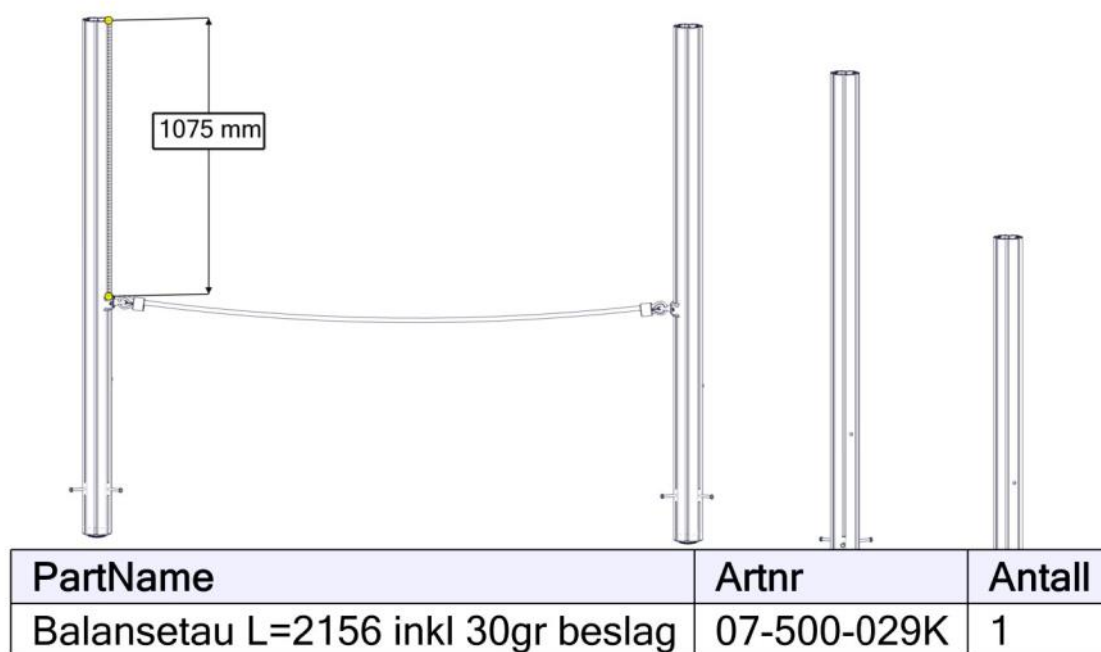

Montering av lekeapparatet / Assembly instructions / Montering av lekredskapet

Se separat delmontering for detaljer
 See separate assembly for details
 Se separata delmontering för detaljer

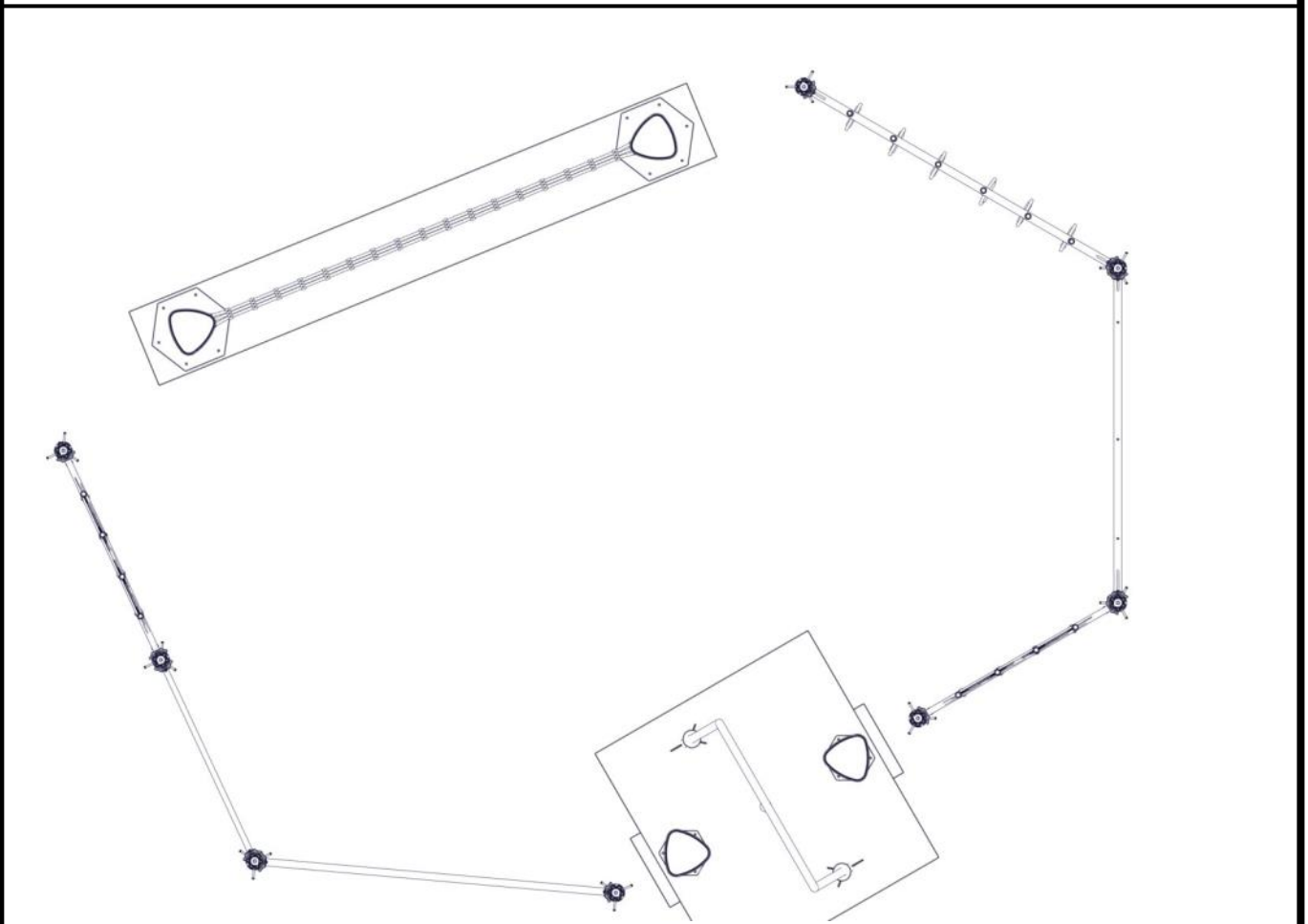
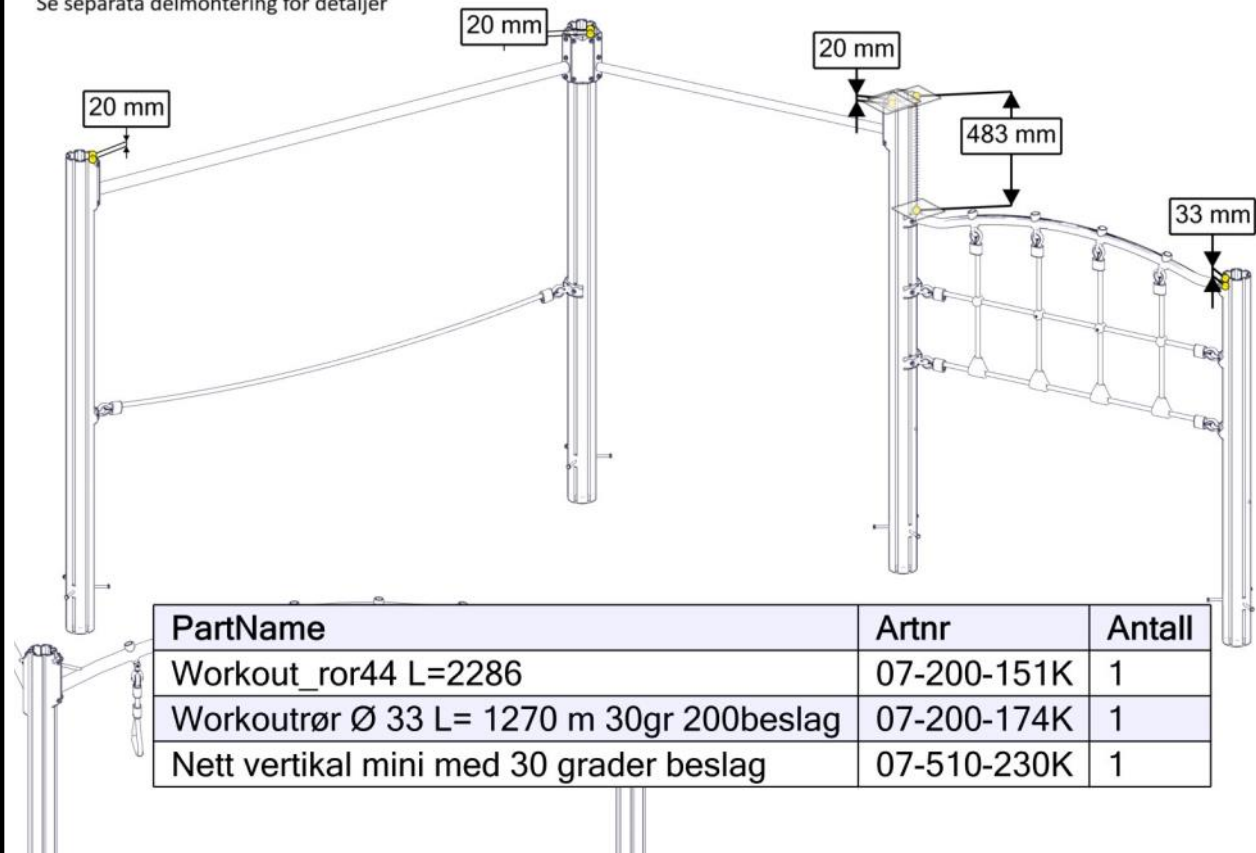

Montering av lekeapparatet / Assembly instructions / Montering av lekredskapet

Se separat delmontering for detaljer
 See separate assembly for details
 Se separata delmontering för detaljer

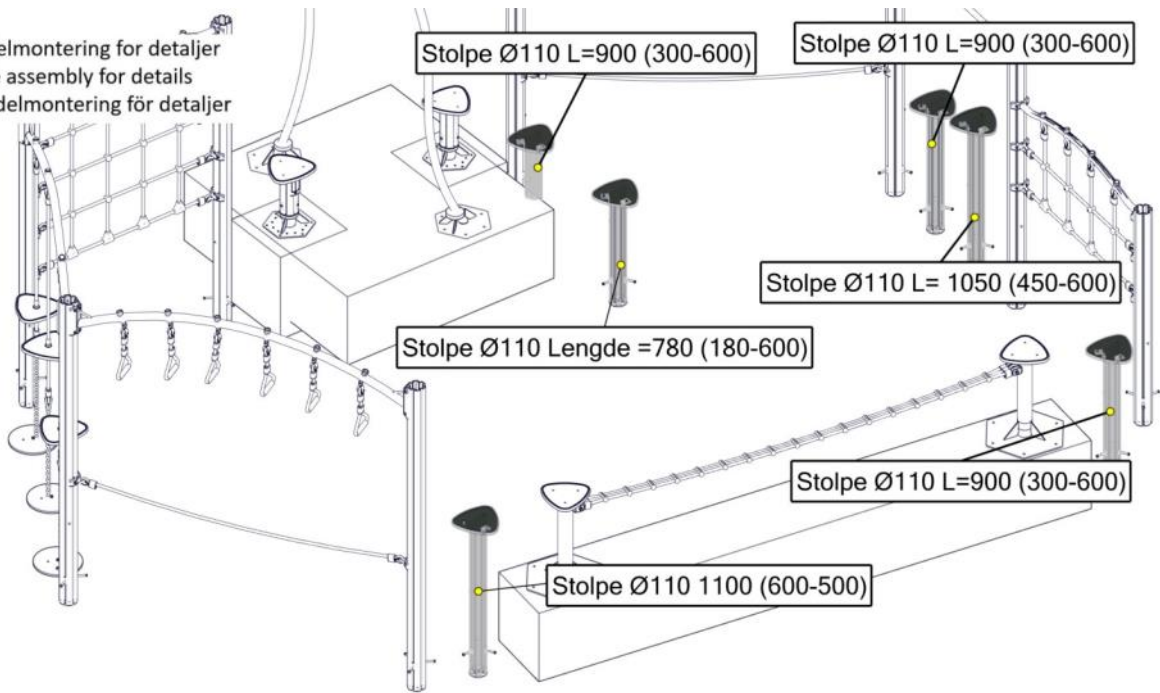

PartName	Artnr	Antall
Støpe fundament Ø 110	00-003-111K	6
3 kant Stepp	06-100-117K	6
Stolpe Ø110 1100 (600-500)	SFA5126/2	1
Stolpe Ø110 Lengde =780 (180-600)	SFA5126/2	1

PartName	Artnr	Antall
Stolpe Ø110 L= 1050 (450-600)	SFA5126/2	1
Stolpe Ø110 L=900 (300-600)	SFA5126/2	3

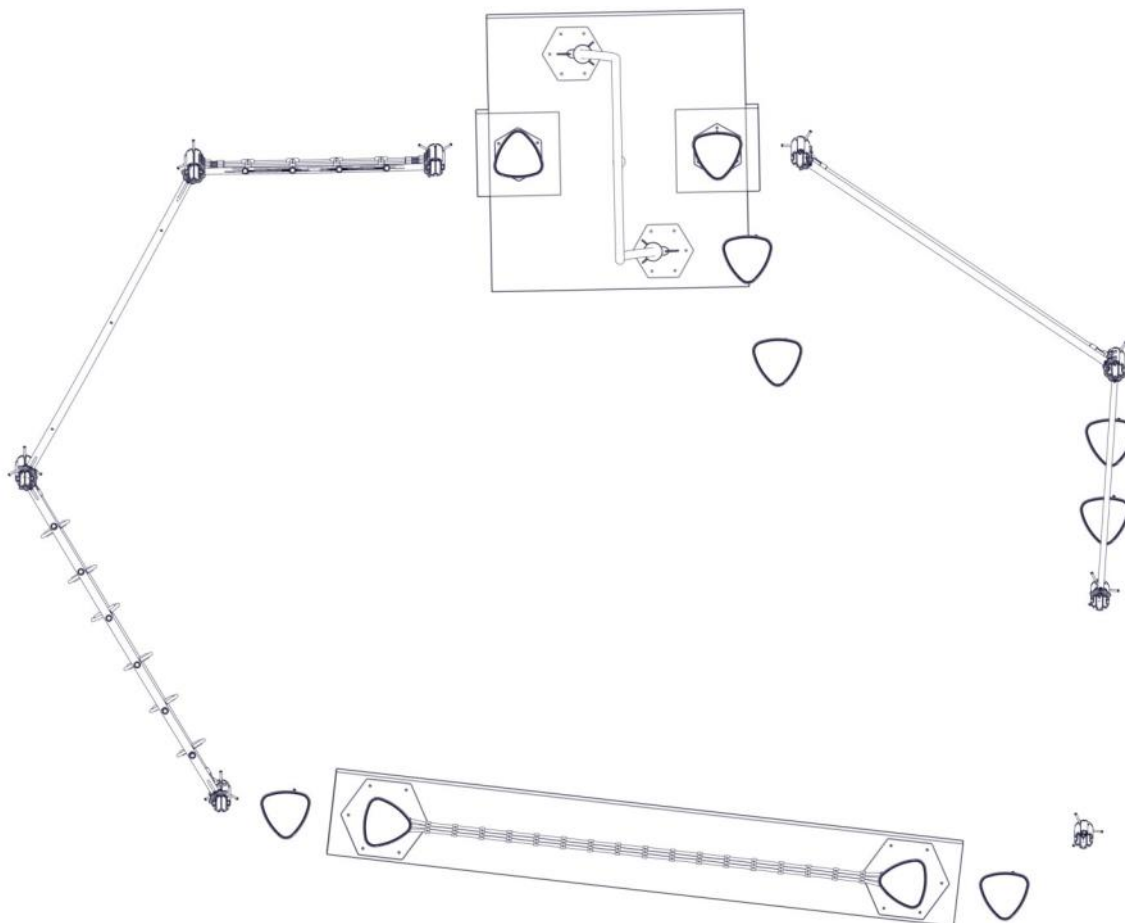

Montering av lekeapparatet / Assembly instructions / Montering av lekredskapet

Se separat delmontering for detaljer
 See separate assembly for details
 Se separata delmontering för detaljer

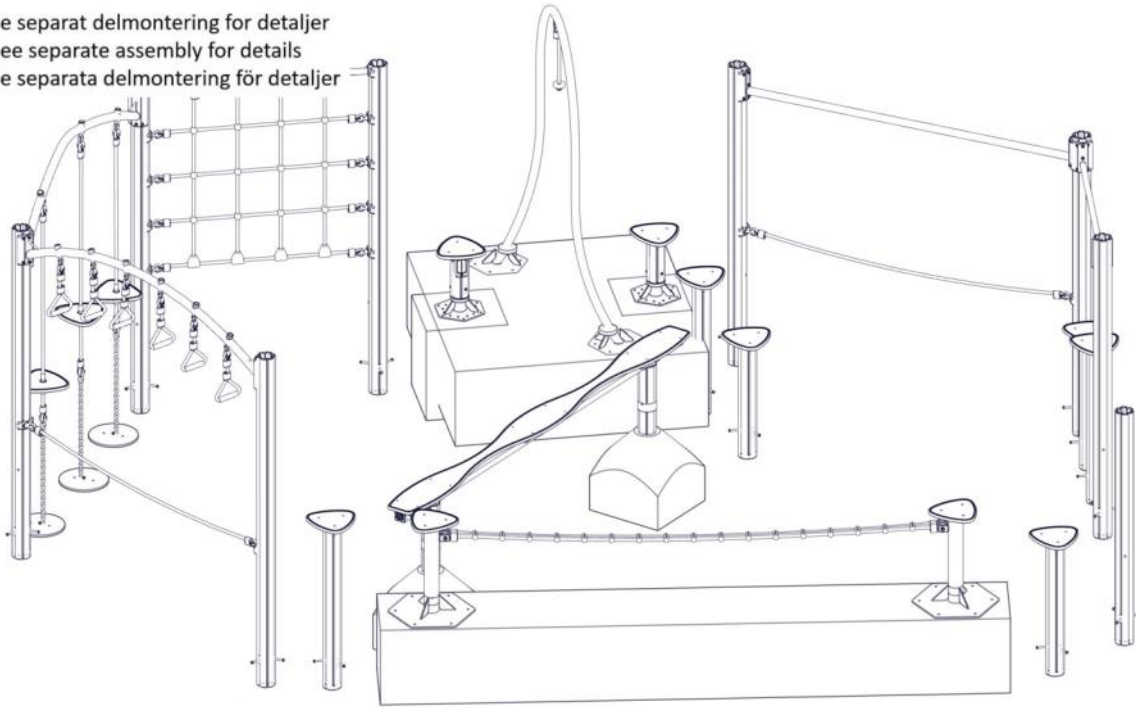

PartName	Artnr	Antall
Balansebom - bølge	30-180-060	1

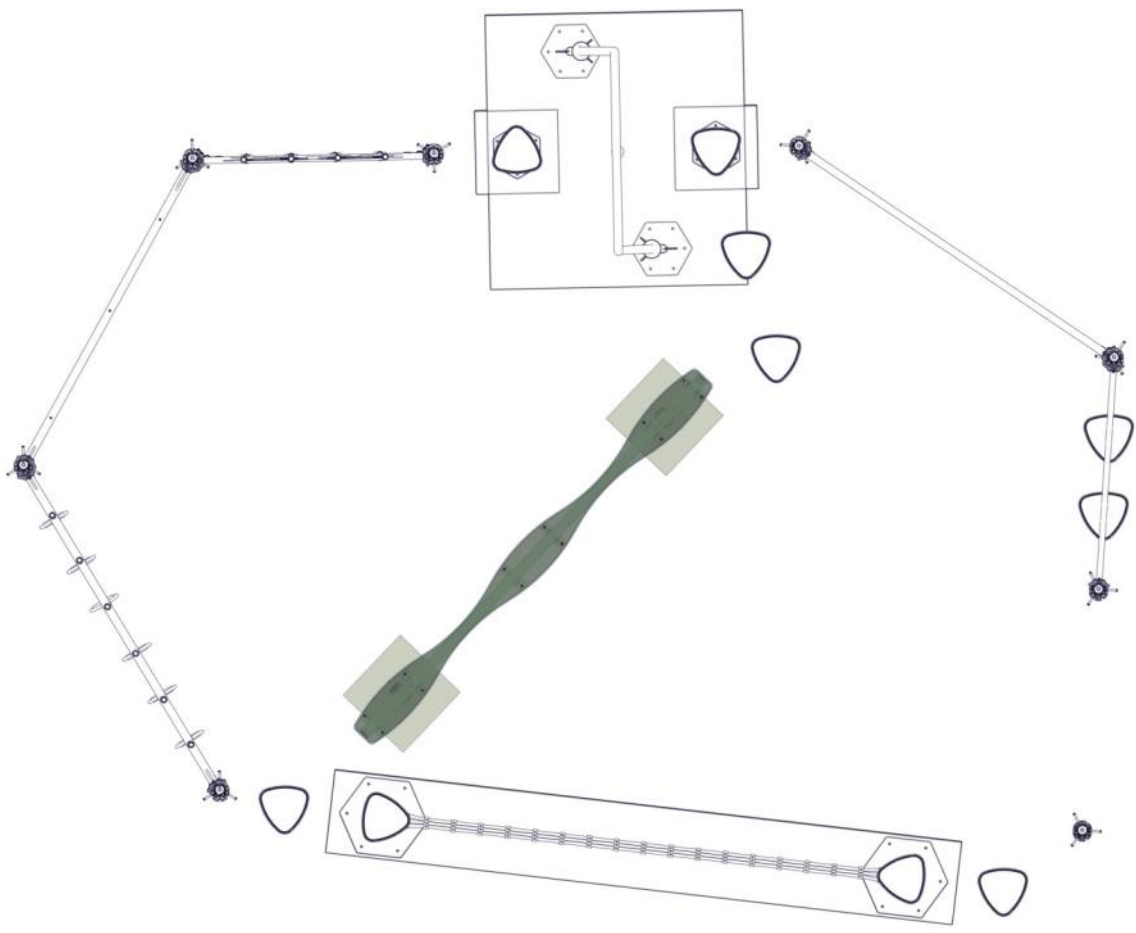



Montering av lekeapparatet / Assembly instructions / Montering av lekredskapet



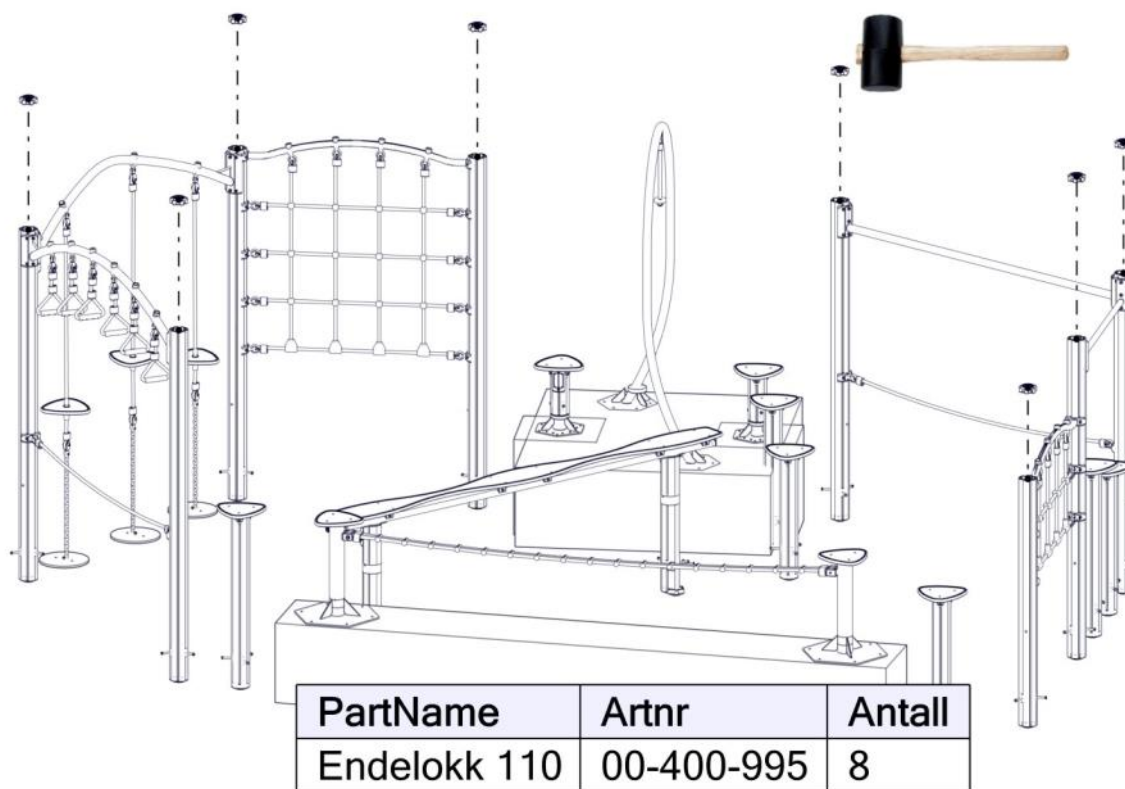

Se separat delmontering for detaljer
 See separate assembly for details
 Se separata delmontering för detaljer

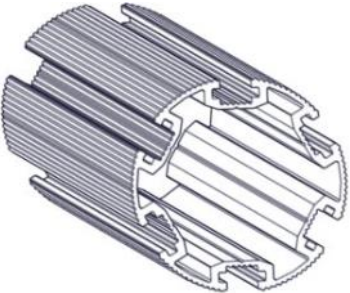

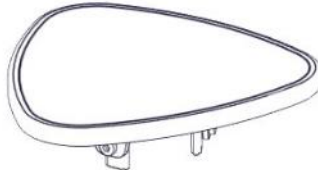
PartName	Artnr	Antall
Produktmerke	07-500-500	1

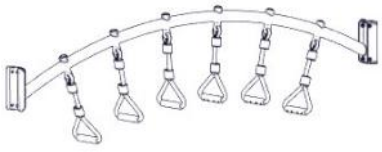

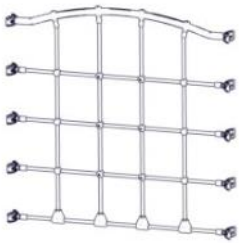
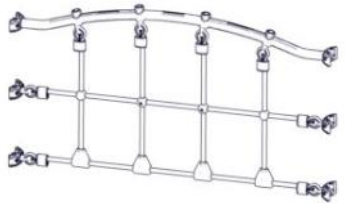
Før utstyret tas i bruk / Before play begins / Innan lekredskapet tas i bruk	
N	<ul style="list-style-type: none"> ● Påse at fallunderlag er utlagt i henhold til gjeldende regler eller vår anbefaling ● Fjern alle monteringshjelpemidler (rester av betong, planker, paller, plast, og lignende) ● Før utstyret tas i bruk, burde man sjekke at det ikke er fare for at anorakksnorer og lignende som kan hekte seg fast noen steder på lekeapparatet. (Vedlagte snor med dobbe (kneledd) kan brukes til å sjekke at dette er i orden. Se vedlagte veiledning for bruk av denne. Dette gjøres for å oppdage eventuelle feilmonteringer.?) ● NB! Bør stå i 2-3 dager før bruk
EN	<ul style="list-style-type: none"> ● Make sure the area and depth of safer surfacing are according to the current standard, or to the manufacturer's recommendation ● Make sure all tools and surplus materials are removed before play begins ● PS! When complete, allow 2-3 days for the concrete to set before use
S	<ul style="list-style-type: none"> ● Kontrollera att fallunderlag är utlagt enligt gällande regler eller vårt rekommendation ● Ta bort alla monteringshjälpmedel (rester av betong, plankor, pallar, plast och liknande) ● Innan lekredskapet används, kontrollera att anoracksnoddar eller kläder/delar av kläder eller liknande inte kan fastna i några delar på redskapet. (Den bipackade "knävringen" kan man med fördel användas för denna kontroll. ● Detta görs för att upptäcka eventuella felmonteringar.)

Boltepakker for / Boltpackage for / Bultpaket för		Sign. _____.		
16-600-130 Grønn - grå	Navn	Artnr/ dimensjon	Ant	Lev
	Stolpe Ø110 L=2200 (1600-600)	SFA5126/2	4	
	Stolpe Ø110 L=2000 (1400-600)		3	
	Stolpe Ø110 L=1550 (950-600)		1	
	Stolpe Ø110 L=1100 (500-600)		1	
	Stolpe Ø110 L=1050 (450-600)		1	
	Stolpe Ø110 L=900 (300-600)		3	
	Stolpe Ø110 L=780 (180-600)		1	
	Rør 3X Monkeyseat Saturn inkl 30gr beslag Grønn	07-300-407K (Se egen delmontering)	1	
	Monkeyseat 3kant HPL med tau			
	Mini del 1	07-500-485K	1	
	Mini del 2	07-500-486K	1	
	Mini del 3	07-500-487K	1	
	3 kant steppern	06-100-117K (se egen delmontering)	6	

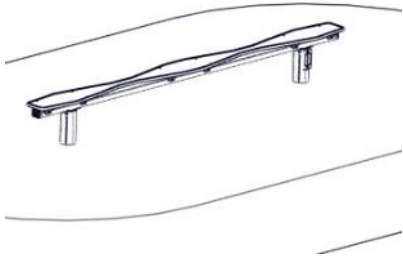
Boltepakker for / Boltpackage for / Bultpaket för		Sign. _____		
16-600-130 Grønn - grå	Navn	Artnr/ dimensjon	Ant	Lev
	Armgang L=2156 Polyfix 3-kant 30gr komp Grønn	07-500-458K (se egen delmontering)	1	
	Balansetau L=2156 inkl 30gr beslag	07-500-029K (se egen delmontering)	2	
	Nett vertikal mini med 30 grader beslag og rør Grønn rør / sort nett	07-510-199K (se egen delmontering)	1	
	Nett vertikal mini med 30 grader beslag Grønn	07-510-230K (Se egen delmontering)	1	
	Workout rør Ø33mm L=170 med 30 grader beslag Grønn	07-200-174K (Se egen delmontering)	1	
	Workout rør Ø44mm L=2286, 30 grader beslag Grønn	07-200-151K (Se egen delmontering)	1	

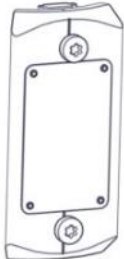
Boltepakker for / Boltpackage for / Bultpaket för		Sign. _____.		
16-600-130 Grønn - grå	Navn	Artnr/ dimensjon	Ant	Lev
	Mini Jungeltauet	16-610-010 (se egen montering)	1	
	Balansebom bølge	30-180-060 (se egen montering)	1	
	Taufstien	30-180-040 (se egen montering)	1	
	Endelokk stolpe Ø110	00-400-995	8	
	Produktmerke	07-500-500 (Se egen delmontering)	1	

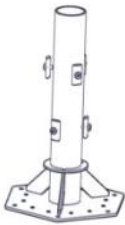
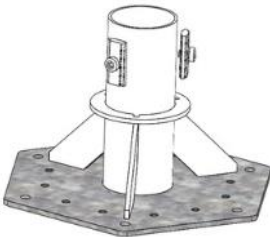
Boltepakker for / Boltpackage for / Bultpaket för		Sign. _____.		
16-600-130 Grønn - grå	Navn	Artnr/ dimensjon	Ant	Lev
	Fundament Støp			
	Støpefundament Stolpe Ø110	00-003-111K (se egen delmontering)	14	
	Overflate montering			
	Fundament 1x 110 stolpe for betongdekk Ekstra	00-003-137K (se egen delmontering)	9	
	Fundament 1x 110 stolpe for betongdekk Ekstra og Kort	00-003-151K (se egen delmontering)	5	
	Pass på 30-180-060			