

N

Monteringsanvisning

EN

Assembly Instructions

S

Monteringsanvisning

Produkt nr. / Product no. / Produkt nr.

17-100-001

Ord. nr. _____

Dato. _____

Sign. _____

Skriv ut i farge.

Skriv ut i färg.

Print in color.

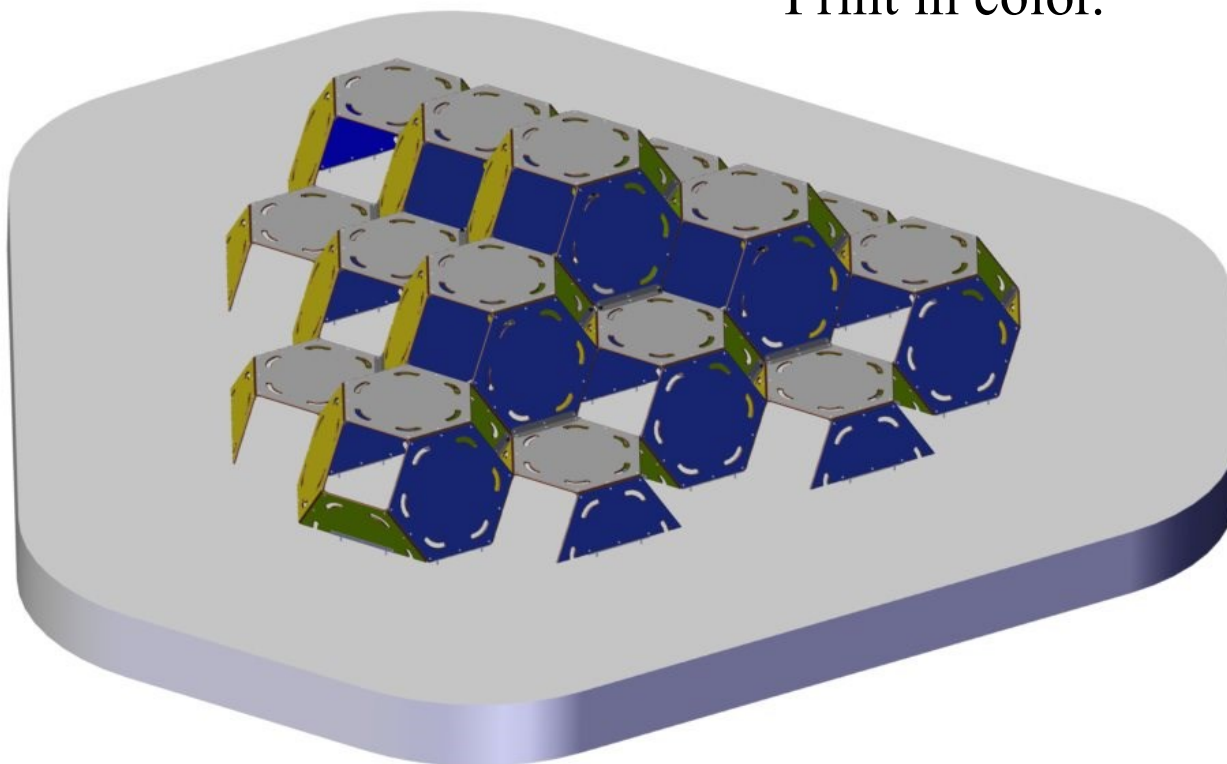
**søve**

Søve AS
Grønnvoldveien 290
3830 Ulefoss - Norway
Tlf: +47 35 94 65 65
www.sove.no

**søve**

Søve AB
EA Rosengrensgatan 32
421 31 Västra Frölunda
Phone: +46 (0)31 773 97 00
www.sove.se

Monteringstips / Assembly Advice / Monteringsstips**N**

- Les monteringsanvisningen nøye før montering.
- Monter elementene i rekkefølgen som vist.
- Boltene bør ikke skrues for hardt til før alt er montert, vatret og loddet. Skru så boltene til.
- NB! Ved bruk av drill, kan boltene ryke.
- På grunn av at solen kan gjøre rutsjeflaten veldig varm, bør rutsjebanens utløp vende mot nord-øst eller nord-vest.
- Er lekeutstyret plassert i naturlige ferdselstraséer må området sikres mot gjennomgang.
- Innspringningshinder bør vurderes rundt lekeapparater hvor det er stor bevegelse, f.eks. ved huskestativ.
- Det bør være fritt innsyn til lekeutstyr som er beregnet for barn under 3 år.

NB! Under monteringsarbeidet må utstyr, som ikke er forankret forsvarlig i bakken, sikres slik at det ikke velte.

Området må avstenges under montering av apparatene med sperrebånd eller lignende.

EN

- Read the instruction carefully before assembling the play unit.
- Assemble the components in the sequence shown in these instructions. Fixings must not be fully tightened during assembly. Before casting the foundations, the structure must be level and plumb, at which point all fixings are tightened. PS! If use of drill, the bolts may be wrecked.
- Avoid positioning the slide facing due south because of overheating – ideal positions are facing north-east or north-west. Secure the construction-area to prevent people from walking through it.
- Consider installing barriers around play-equipment which gives rise to a lot of activity – i.e. swings.
- Ensure that clear vision is possible across the play area so that supervision is possible from any position, particularly where children under 3 years of age will be playing.

NB! During assembly of the equipment, ensure that all structures are securely propped, especially when left overnight. Also ensure that equipment is supported

Monteringstips / Assembly Advice / Monteringsstips

S

- Läs monteringsanvisningen noga före montering.

- Montera delarna i den ordningen som anvisas
- Skruvarna bör inte skruvas för hårt tills allt är monterat, i våg och lodat.

OBS! Används elektrisk skruvdragare, kan bulten gå sönder. Hårdra därför manuellt!

- Solen kan göra att rutchbanan blir väldigt varm. Banans nedfart rekommenderas att vändas i norrlig riktning
- Om lekplatsen placeras vid en gångväg mm bör området säkras mot genomfart av gående och cyklister.
- Insprängningshinder bör placeras runt lekutrustning med stor rörelse, t ex, gungställning.
- Det bör vara fri insyn till lekutrustning beräknat till barn under 3 år.

OBS! Under monteringsarbete bör utrustningen som inte ska förankras i marken, ställs så att den inte kan välta.

Området måste spärras när lekutrustningen byggs upp, med avspärrningsband eller liknande.

* Begynn med montering av vinkel med bare mideste boltene først. etter montering av alle platene sett inn alle øvrige boltene.









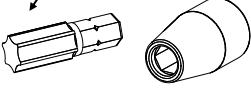

* Begin by mounting the angle with only the middle bolts first. after installing all plates insert all other bolts.

* Börja med att montera vinkeln först med endast de mellersta bultarna efter installation av alla plattor, sätt in alla andra bultar.

Part Name	Article nr.	Qty
Møbelknapp M8x11	04-030-011	2
Unbrako skrue M8x16 forsenket hode	04-034-016	2
Vinkel 50x50x5 109gr grå	07-303-004	1

NO	Betongkvalitet	C25/30		
SE	Betongkvalitet			
EN	Concrete quality			
NO	Mengde betong		N/A	m ³
SE	Mängd betong			
EN	Amount of concrete			
NO	Fundament størrelse		0,5x0,5x0,4	m
SE	Stiftelsestorlek			
EN	Foundation size			
NO	For sikkerhet må fundamentene med sand eller myk jord være minst 50% større i areal			
SE	För säkerheten måste grunden med sand eller mjuk jord vara minst 50% större i området			
EN	For safety, the foundations with sand or soft soil must be at least 50% larger in area			
NO	Tyngste element	07-303-073 07-303-076	15,1 15,1	Kg
SE	Tyngsta element			
EN	Heaviest element			
NO	Største element	07-303-073 07-303-076	1,5x1,3x0,012 1,5x1,3x0,012	m
SE	Största element			
EN	Biggest element			

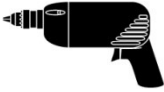
Nødvendig verktøy / Tools required / Nödvändiga verktyg





<p>(N)</p> <p>(EN)</p> <p>(S)</p>	<p>(A)</p> 	<p>(B)</p>  <p>Torx Nr 45 High quality</p> 	<p>(C)</p>  <p>13 + 17mm</p> 	<p>(D)</p> 	<p>(E)</p> 
		<p>Metermål</p> <p>Metric measure</p> <p>Tumstock</p> 	<p>18 V</p> 	<p>Merkebånd</p> <p>Mark ribbon</p> <p>Märkeband</p> 	<p>5 mm</p> <p>6 mm</p> 



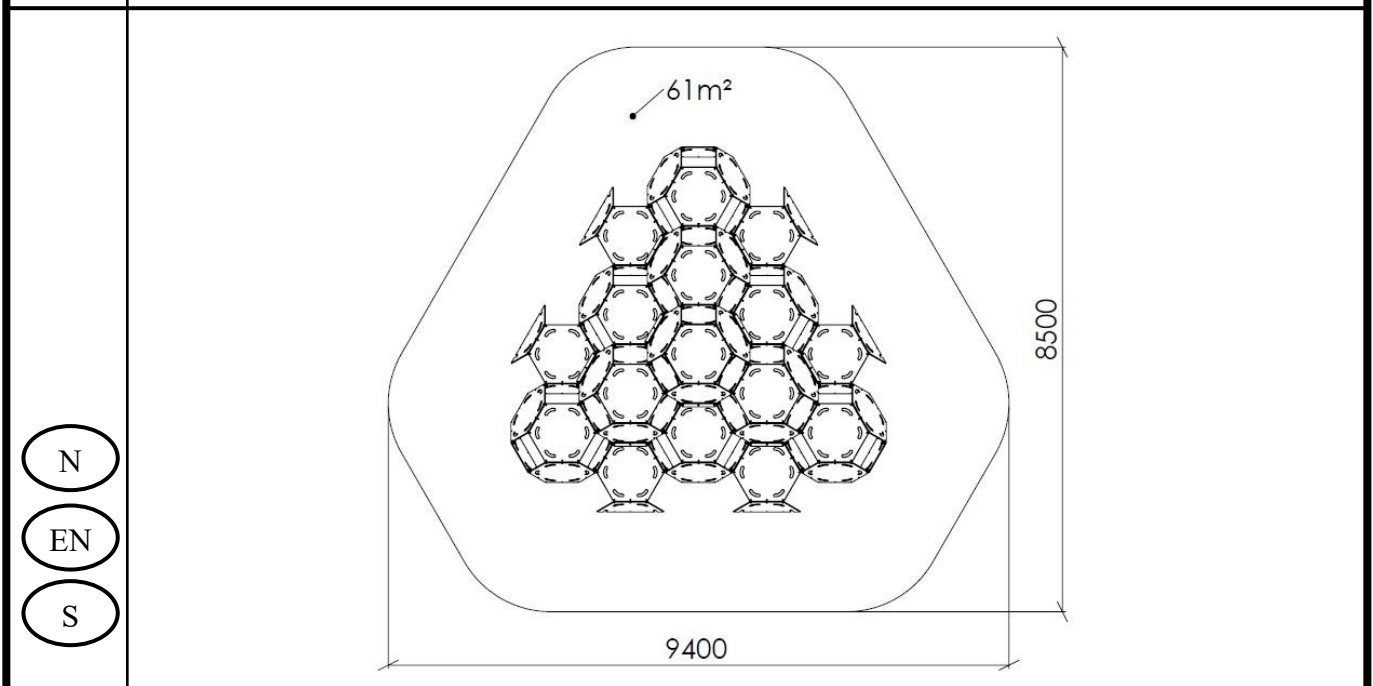

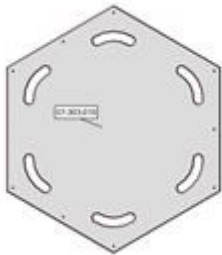
Nødvendig antall personer / Number of persons required / Rekommenderad antal personer

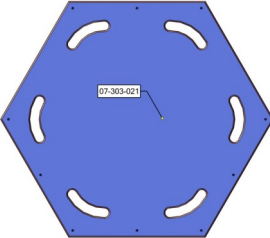
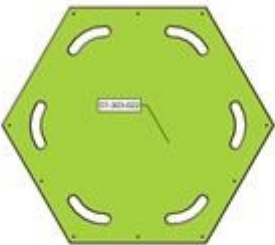

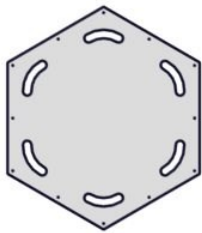
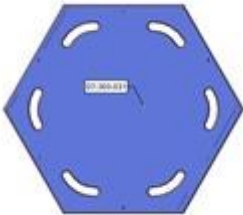
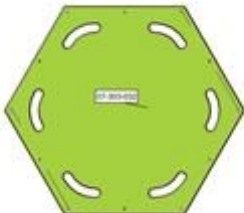

Anbefalt arealbehov ved montering / Recommended working space / Rekommenderad arealbehov vid montering





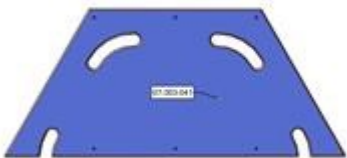
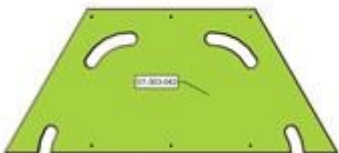
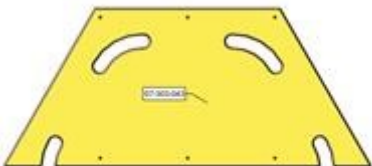
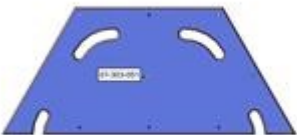

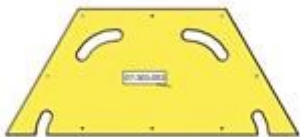



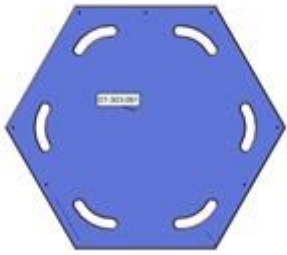
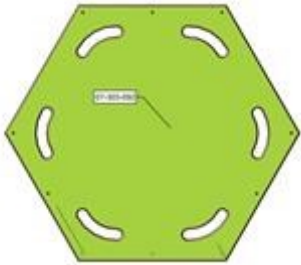
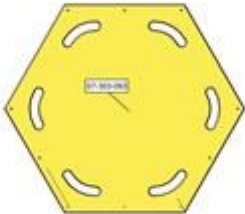

Boltepakker for / Boltpackage for / Bultpaket för		Sign. _____.		
	Navn	Artnr/dimensjon	Ant	Lev
	Okta 3hull grå	07-303-010	7	
	Okta 4hull grå Type1	07-303-020	9	
	Okta 4hull blå Type1	07-303-021	2	
	Okta 4hull grønn Type1	07-303-022	2	
	Okta 4hull gul Type1	07-303-023	2	
	Merkeskilt Montert hos Søve	00-100-400	0	





Boltepakker for / Boltpackage for / Bultpaket för		Sign. _____.		
	Navn	Artnr/dimensjon	Ant	Lev
	Okta 6hull grå Type1	07-303-030	1	
	Okta 6hull blå Type1	07-303-031	1	
	Okta 6hull grønn Type1	07-303-032	1	
	Okta 6hull gul Type1	07-303-033	1	
	Møbelknapp M8 16x11	04-030-011	692	
	QR merke Montert hos Søve	00-100-406	0	

Boltepakker for / Boltpackage for / Bultpaket för		Sign. _____.		
	Navn	Artnr/dimensjon	Ant	Lev
	Okta H-fun-H-opp blå	07-303-041	2	
	Okta H-fun-H-opp grønn	07-303-042	2	
	Okta H-fun-H-opp gul	07-303-043	2	
	Okta H-fun-H-opp H- VogH blå	07-303-051	4	
	Okta H-fun-H-opp H- VogH grønn	07-303-052	4	
	Okta H-fun-H-opp H- VogH gul	07-303-053	4	

Boltepakker for / Boltpackage for / Bultpaket för		Sign. _____.		
	Navn	Artnr/dimensjon	Ant	Lev
	Okta H-fun-H-VogH blå	07-303-061	1	
	Okta H-fun-H-VogH grønn	07-303-062	1	
	Okta H-fun-H-VogH gul	07-303-063	1	
	Okta 6 hull blå Type 2	07-303-081	3	
	Okta 6 hull grønn Type 2	07-303-082	3	
	Okta 6 hull gul Type 2	07-303-083	3	

Boltepakker for / Boltpackage for / Bultpaket för		Sign. _____.		
	Navn	Artnr/dimensjon	Ant	Lev
	Okta 4 hull blå Type2	07-303-091	4	
	Okta 4 hull grønn Type2	07-303-092	4	
	Okta 4 hull gul Type2	07-303-093	4	
	Okta vinkel grå	07-303-004	87	
	Okta kappet vinkel grå	07-303-005	36	
	Okta fundamentforankring	07-303-070	42	

Boltepakker for / Boltpackage for / Bultpaket för		Sign. _____.		
	Navn	Artnr/dimensjon	Ant	Lev
	Okta fundament kobling	07-303-071	21	
	Okta fundament type1	07-303-072	3	
	Okta fundament type2	07-303-073	6	
	Okta fundament type3	07-303-074	3	
	Okta fundament type4	07-303-075	3	
	Okta fundament type5	07-303-076	1	

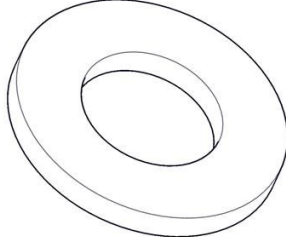
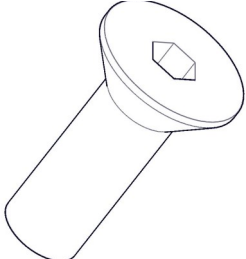
Boltepakker for / Boltpackage for / Bultpaket för		Sign. _____		
	Navn	Artnr/dimensjon	Ant	Lev
	Torx M8x20 Torx M8x30	04-000-020 04-000-030	168 84	
	Sikkerhetshette 20mm M8 Sort	05-301-033	102	
	Sikkerhetshette kropp 32mm M8 Sort	05-301-033	102	
	Låsemutter M8	04-040-08	102	
	Skive M8	04-050-008	168	
	Unbrako Skrue M8x16 For- senket hode Unbrako Skrue M8x40 For- senket hode	04-034-016 04-034-040	516 102	

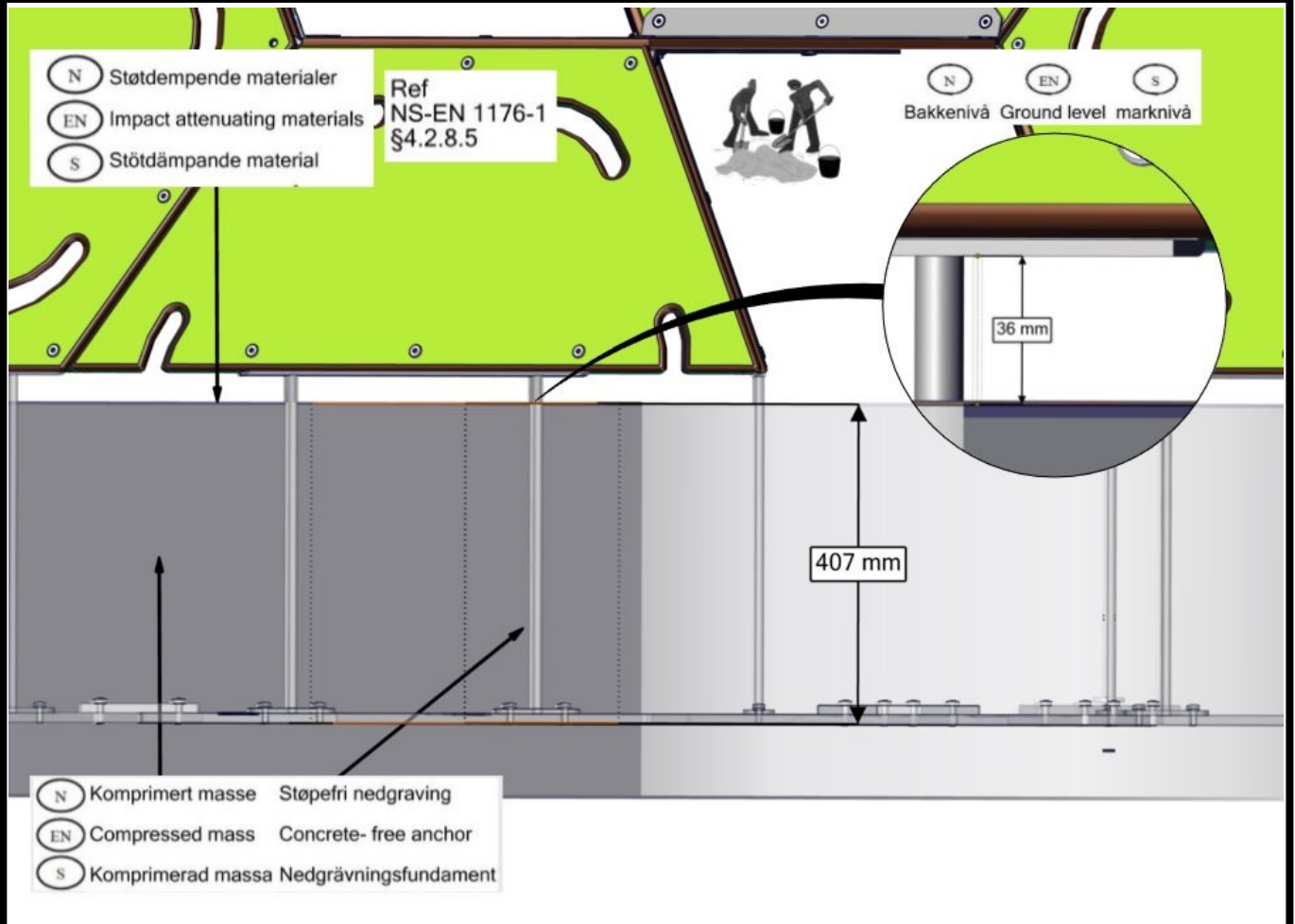
Fundamentering uten betong / Foundation without concrete / Förankring utan betong

- (N) Alle mål er oppgitt i millimeter
- (EN) Scale measured in mm
- (S) Alla mått är i millimeter.

Fallhøyder / Free height of fall / Fallhöjder

Fallhøyde < 1 meter

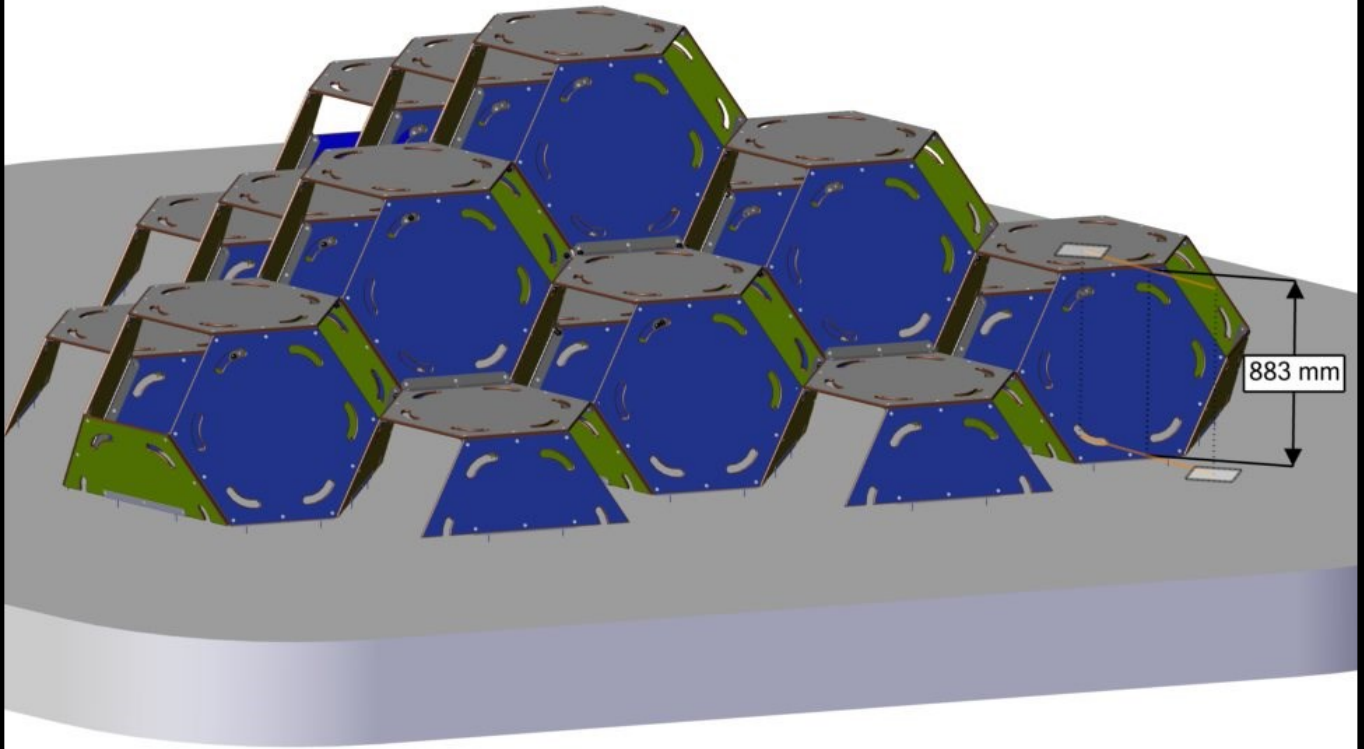

Sikkerhetszone / Safety zone / Säkerhetszon

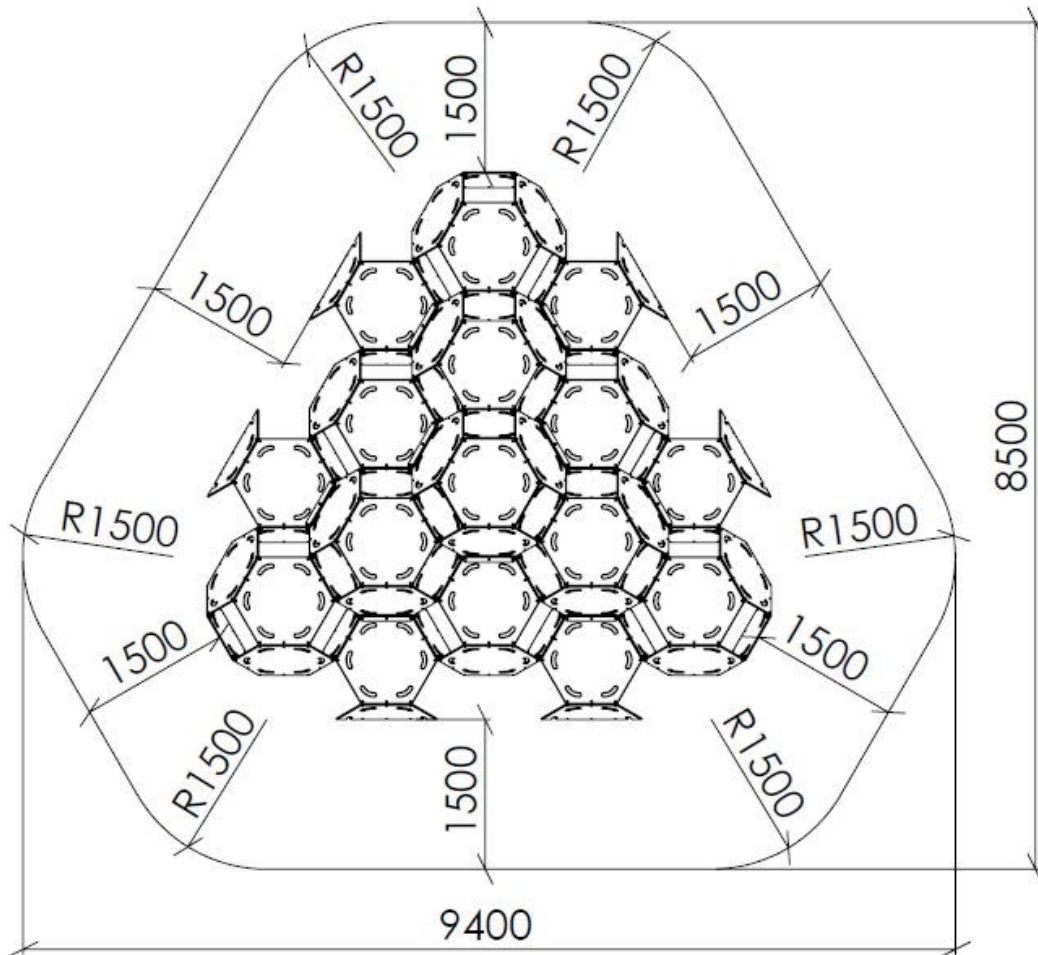

Plassering av forankringer / Ground plan / Placering av förankringar

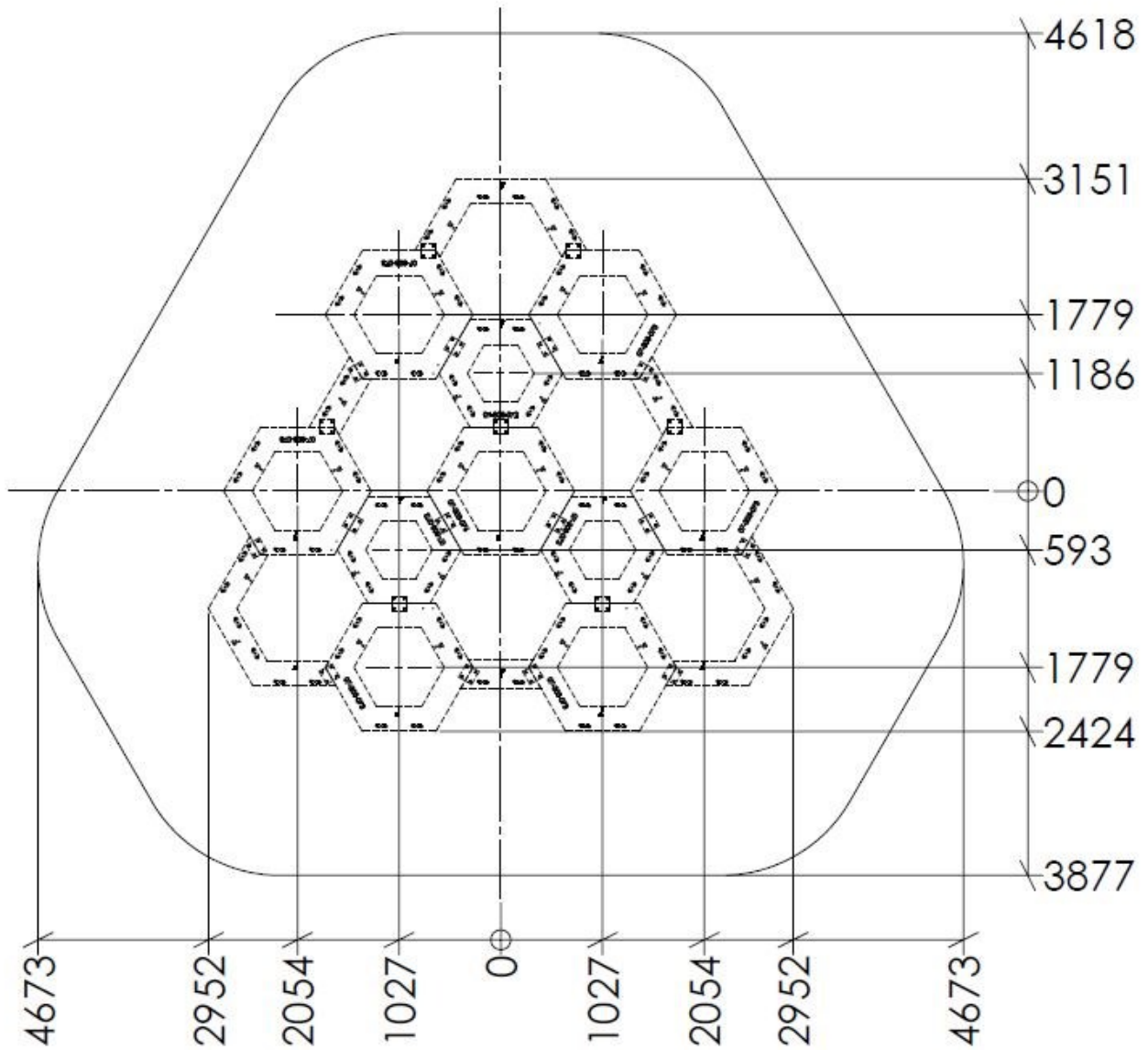

N

Alle mål er oppgitt i millimeter

EN

Scale measured in mm

S

Alla mått är i millimeter.

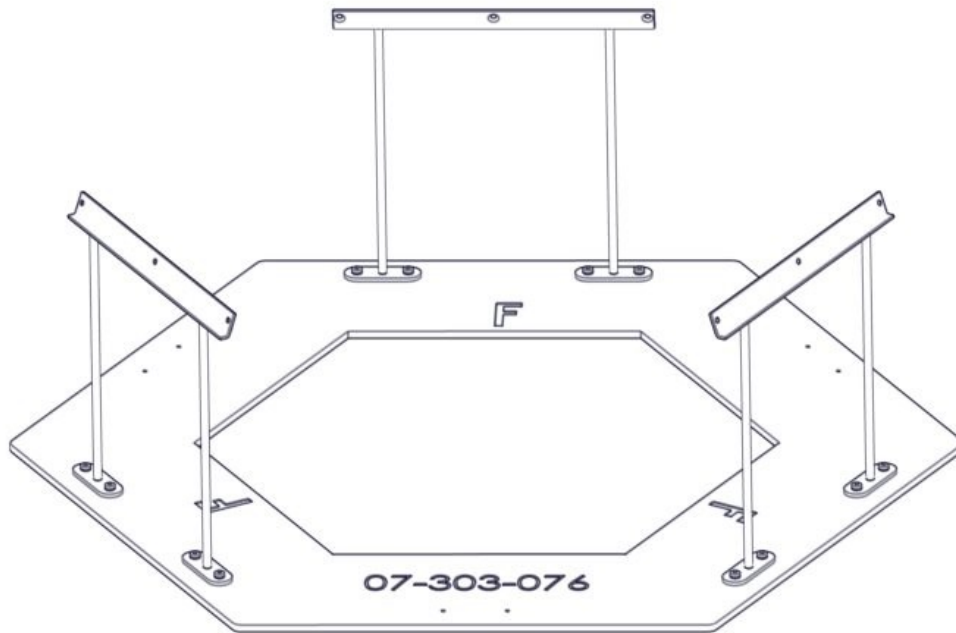

Part Name	Article nr.	Qty
Torx M8x20	04-000-020	12
Skive M8	04-050-008	12
Okta fundamentforankring	07-303-070	3
Okta_Fundament type 5	07-303-076	1

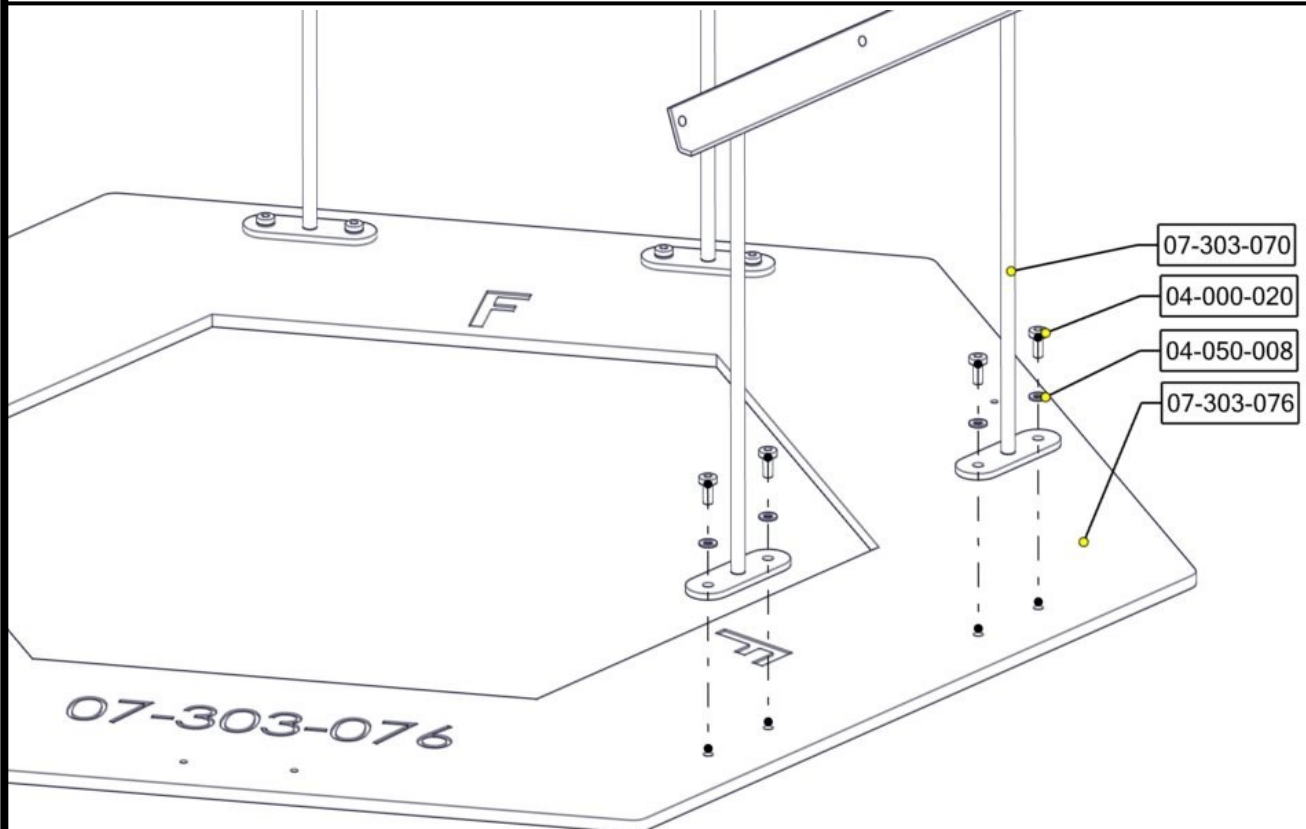

3x

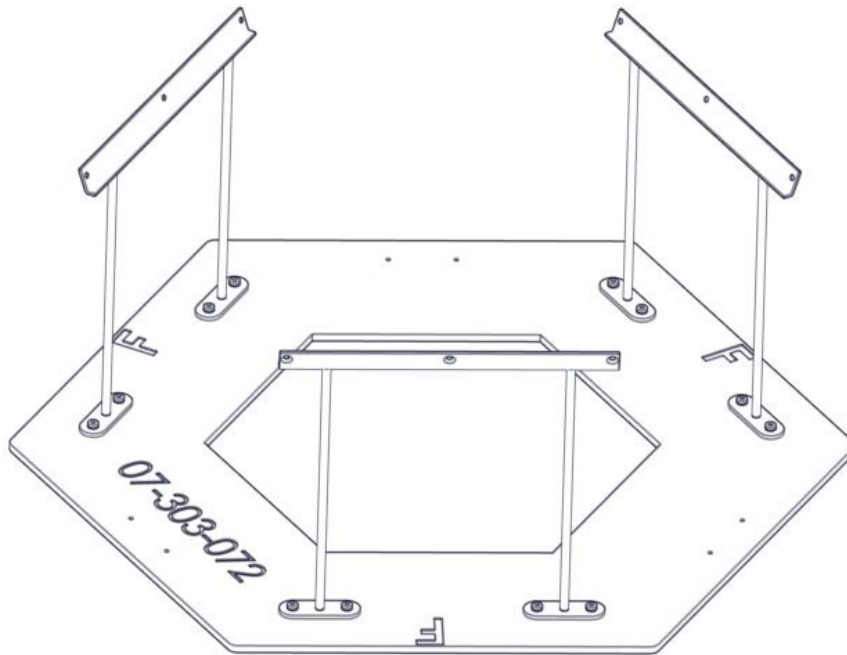

Part Name	Article nr.	Qty
Torx M8x20	04-000-020	12
Skive M8	04-050-008	12
Okta fundamentforankring	07-303-070	3
Okta_Fundament type1	07-303-072	1

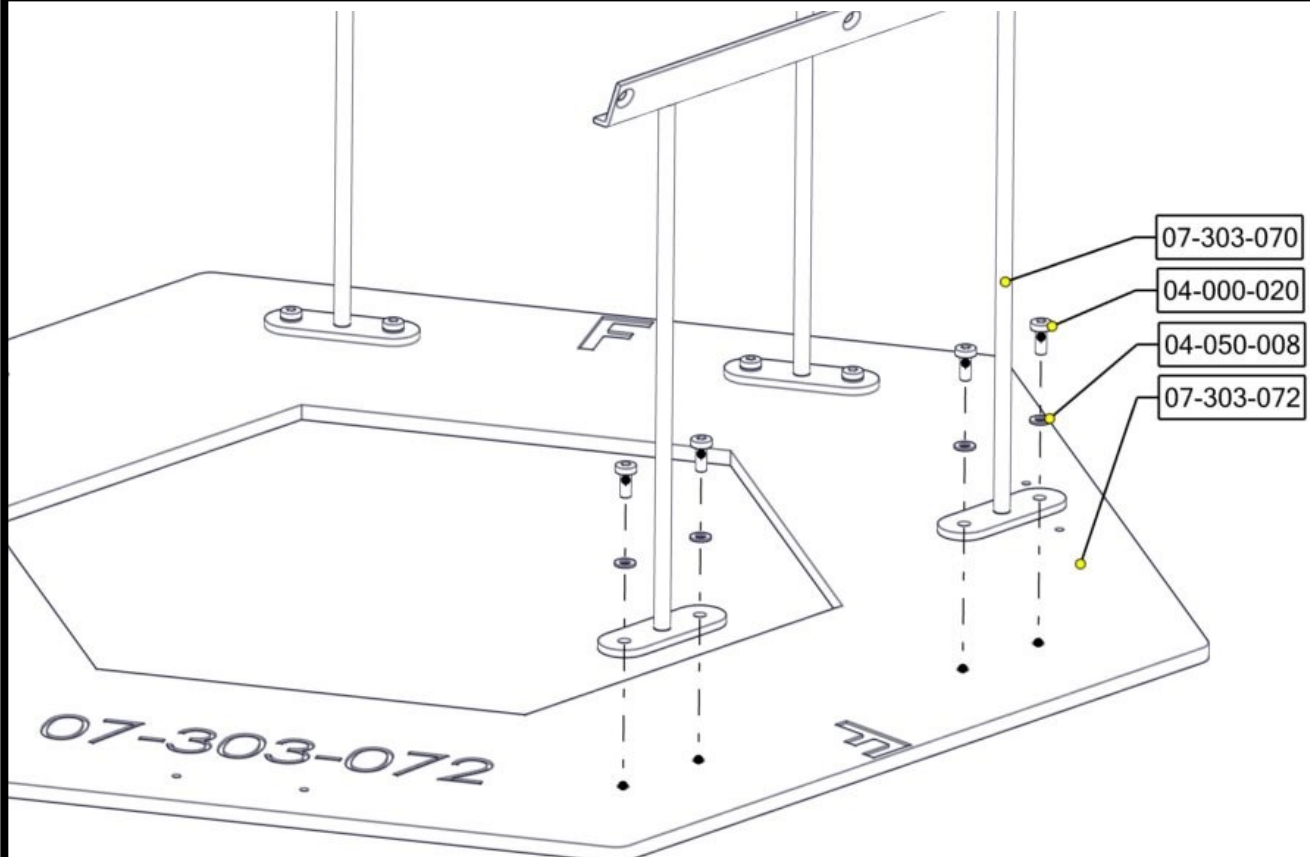

3x

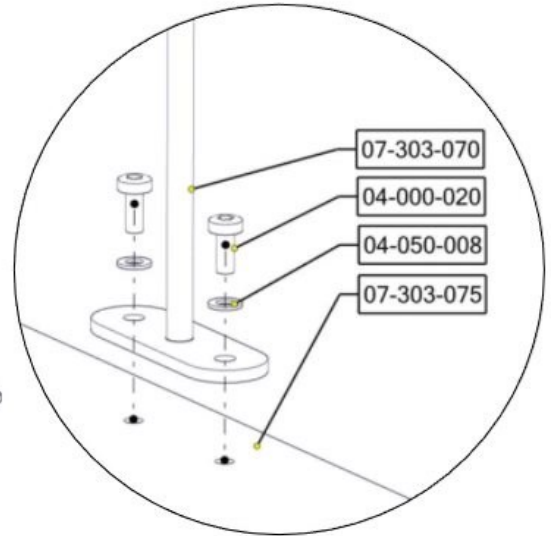
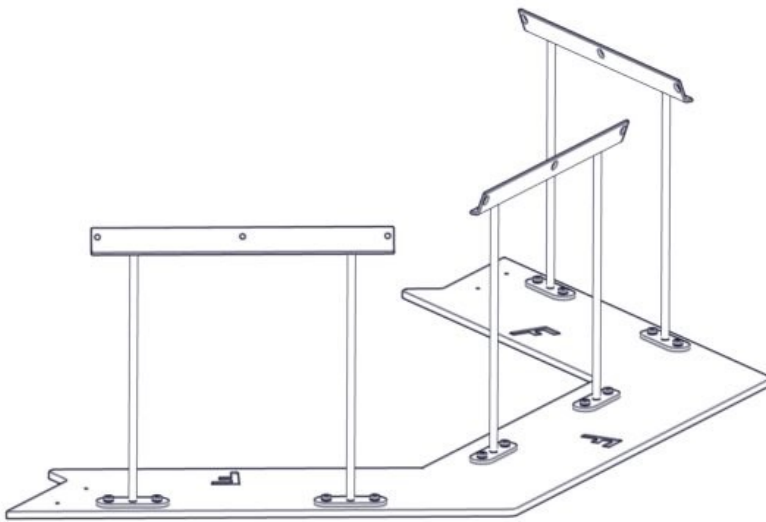

Part Name	Article nr.	Qty
Torx M8x20	04-000-020	12
Skive M8	04-050-008	12
Okta fundamentforankring	07-303-070	3
Okta_Fundament Type4	07-303-075	1

3x

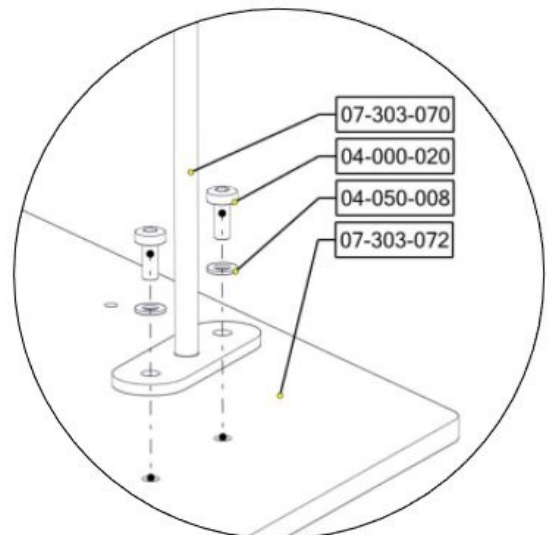
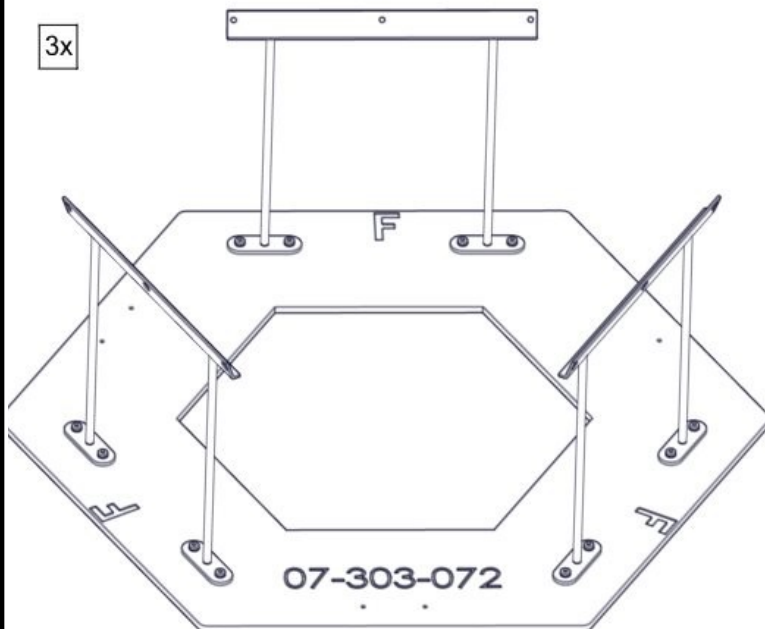

Part Name	Article nr.	Qty
Torx M8x20	04-000-020	12
Skive M8	04-050-008	12
Okta fundamentforankring	07-303-070	3
Okta_Fundament type1	07-303-072	1

3x

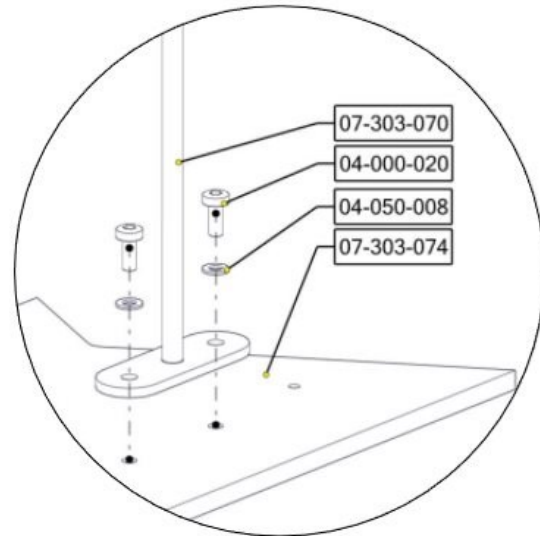
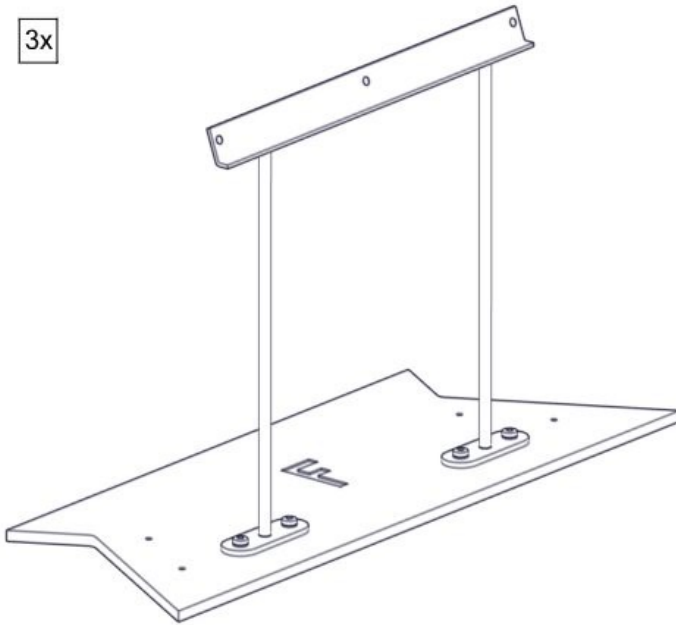

Part Name	Article nr.	Qty
Torx M8x20	04-000-020	4
Skive M8	04-050-008	4
Okta fundamentforankring	07-303-070	1
Okta_Fundament_1-3 Type 3	07-303-074	1

6x

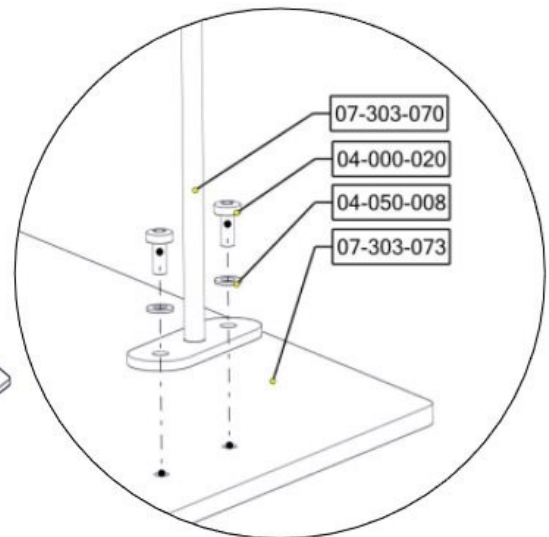
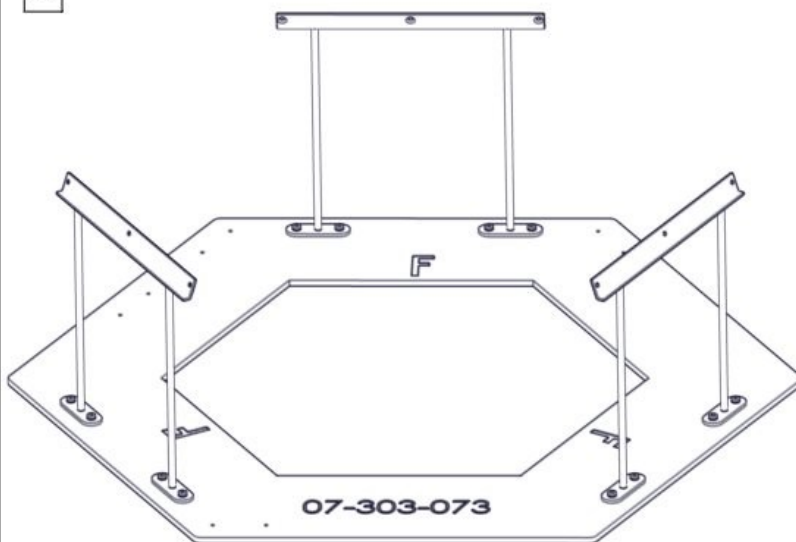

Part Name	Article nr.	Qty
Torx M8x20	04-000-020	12
Skive M8	04-050-008	12
Okta fundamentforankring	07-303-070	3
Okta_Fundament Type2	07-303-073	1

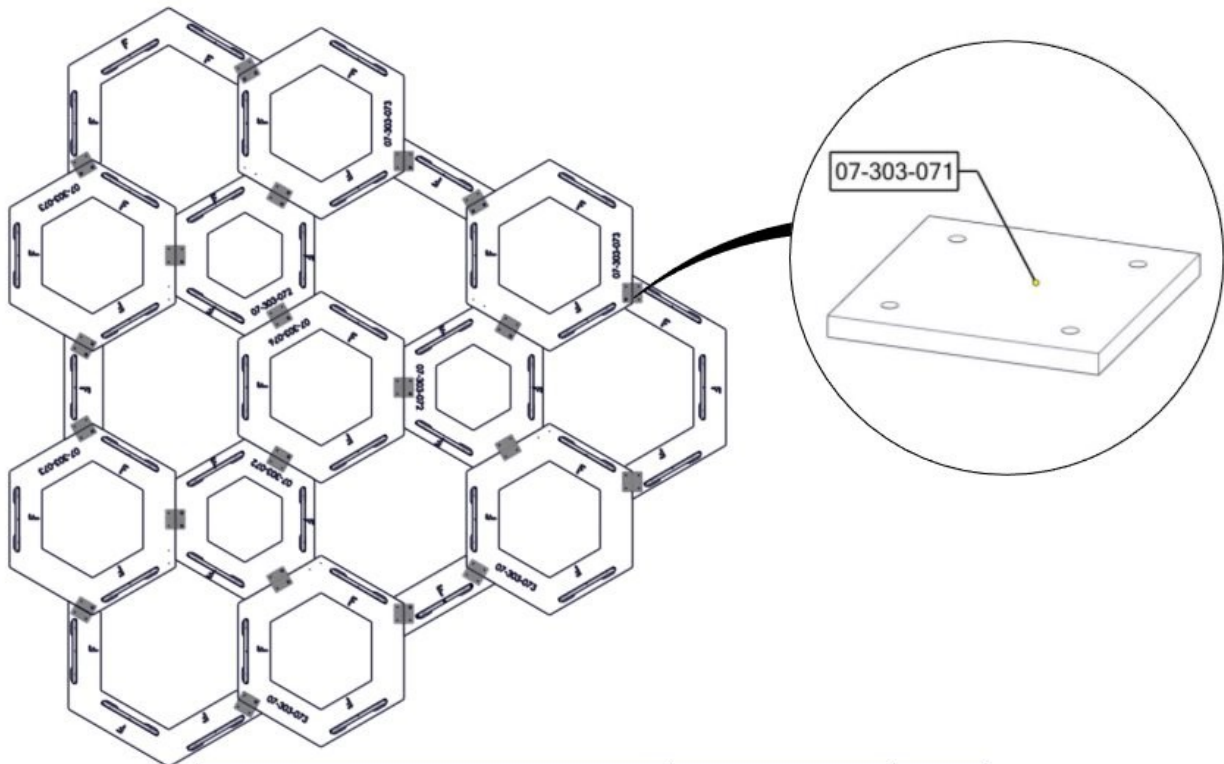
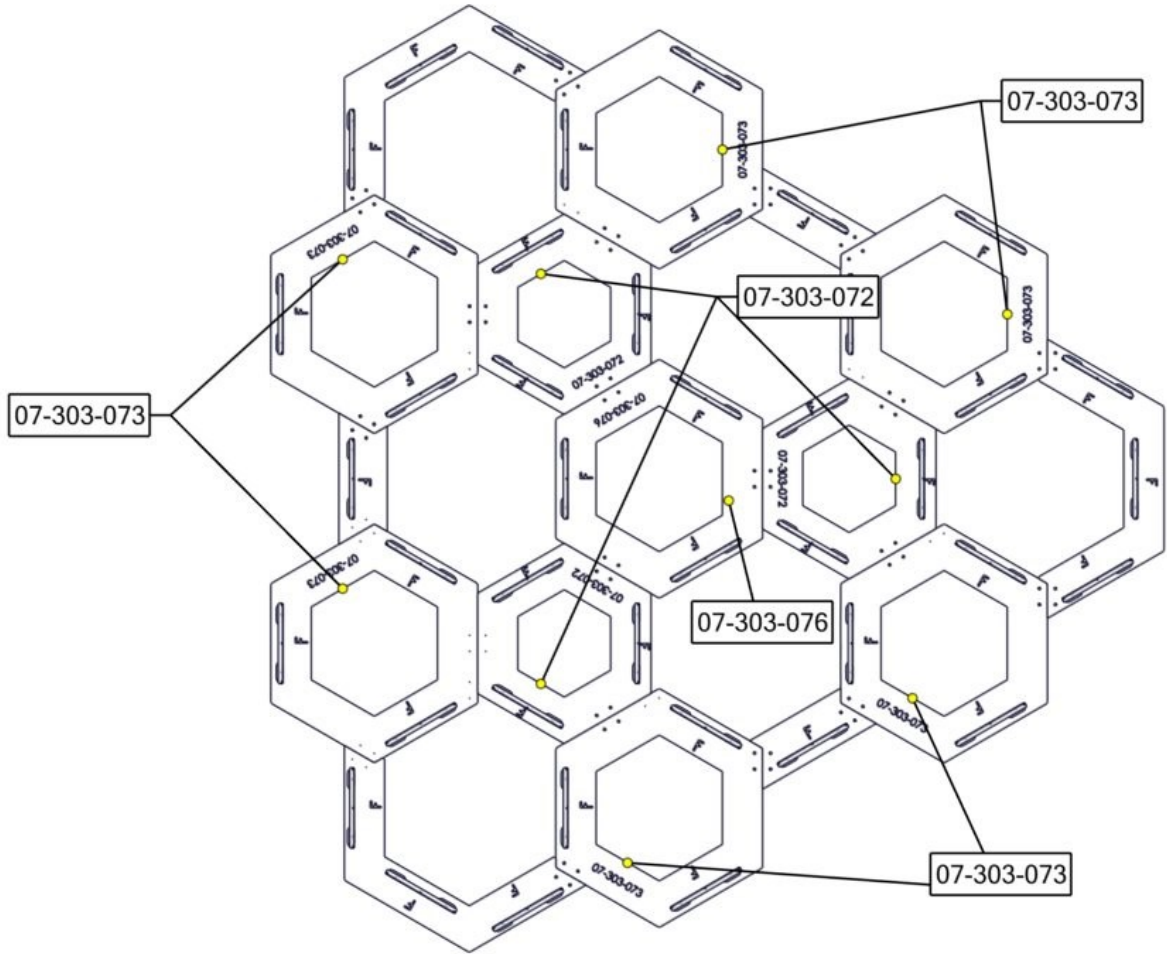

Part Name	Article nr.	Qty
Okta_KoblingFundamenter	07-303-071	21
Torx M8x25	04-000-025	84

21x

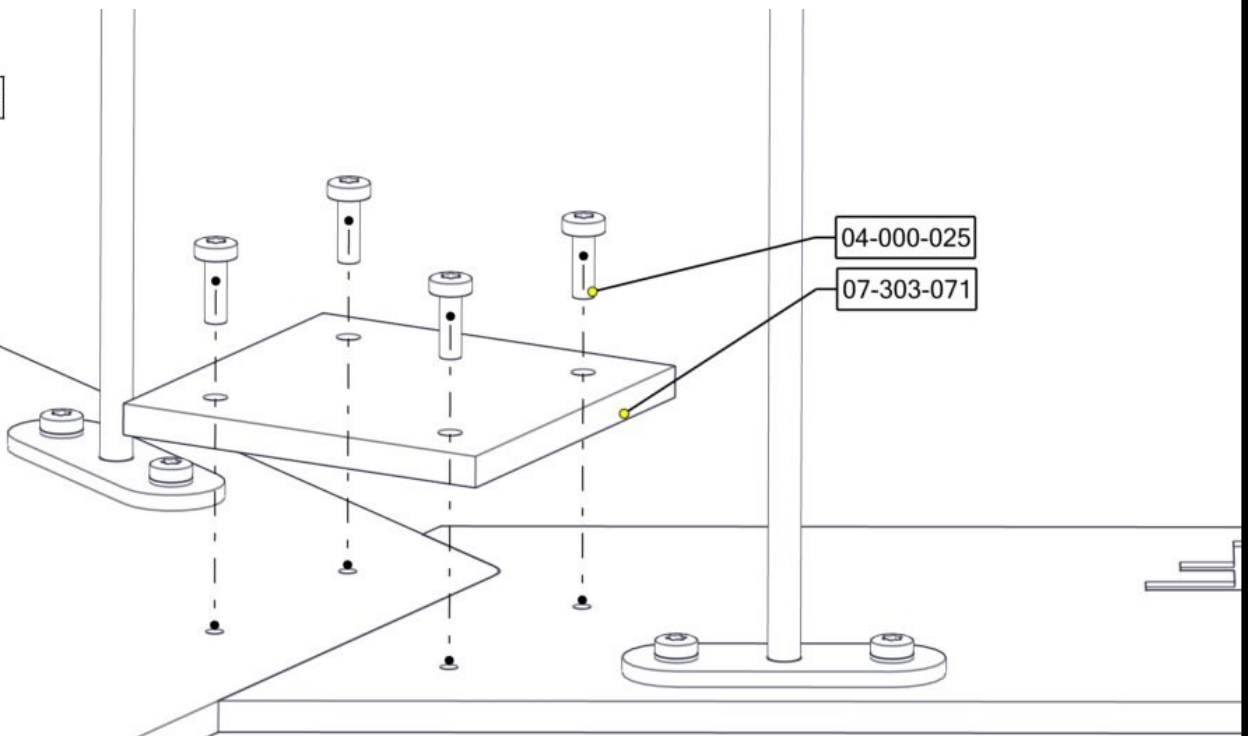

Part Name	Article nr.	Qty
Torx M8x25	04-000-025	4

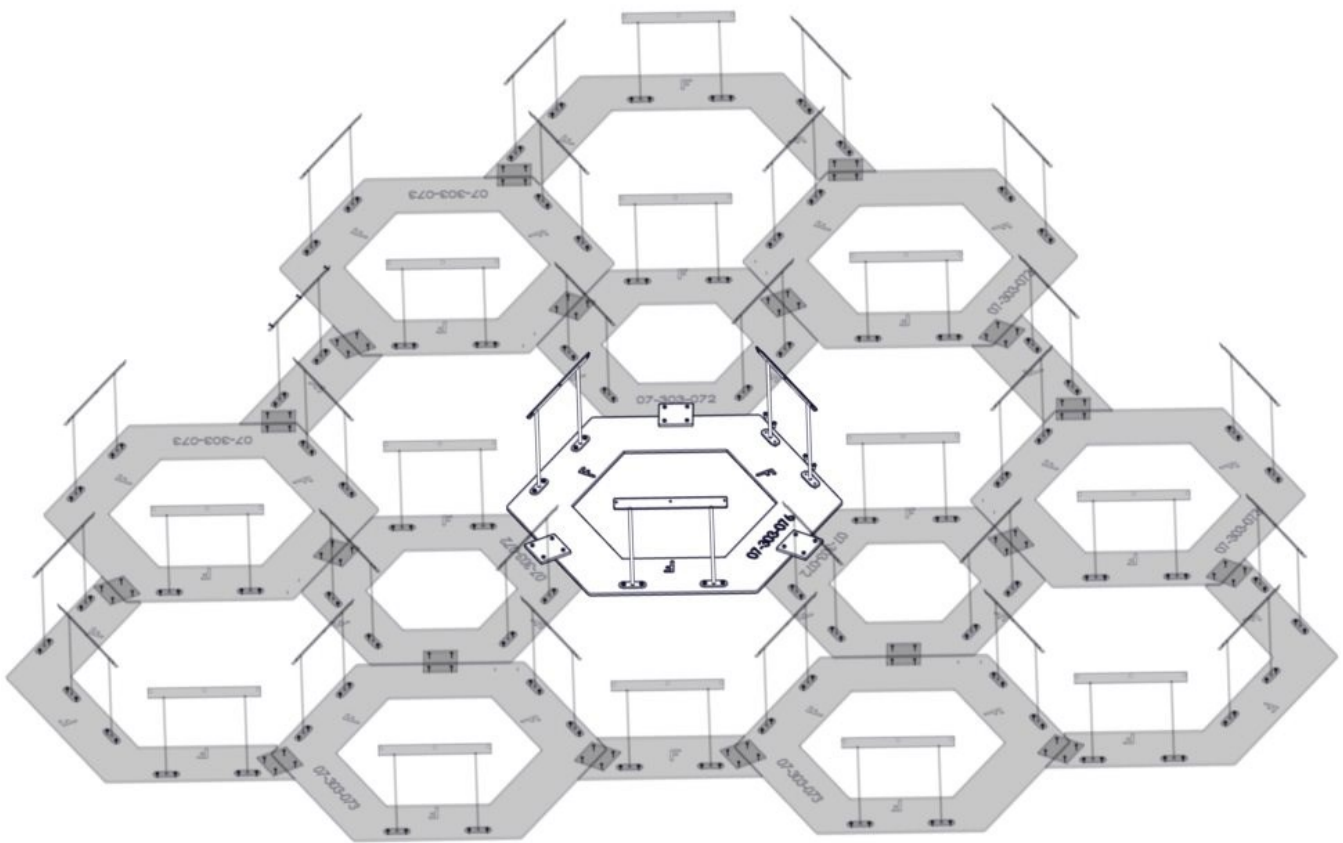

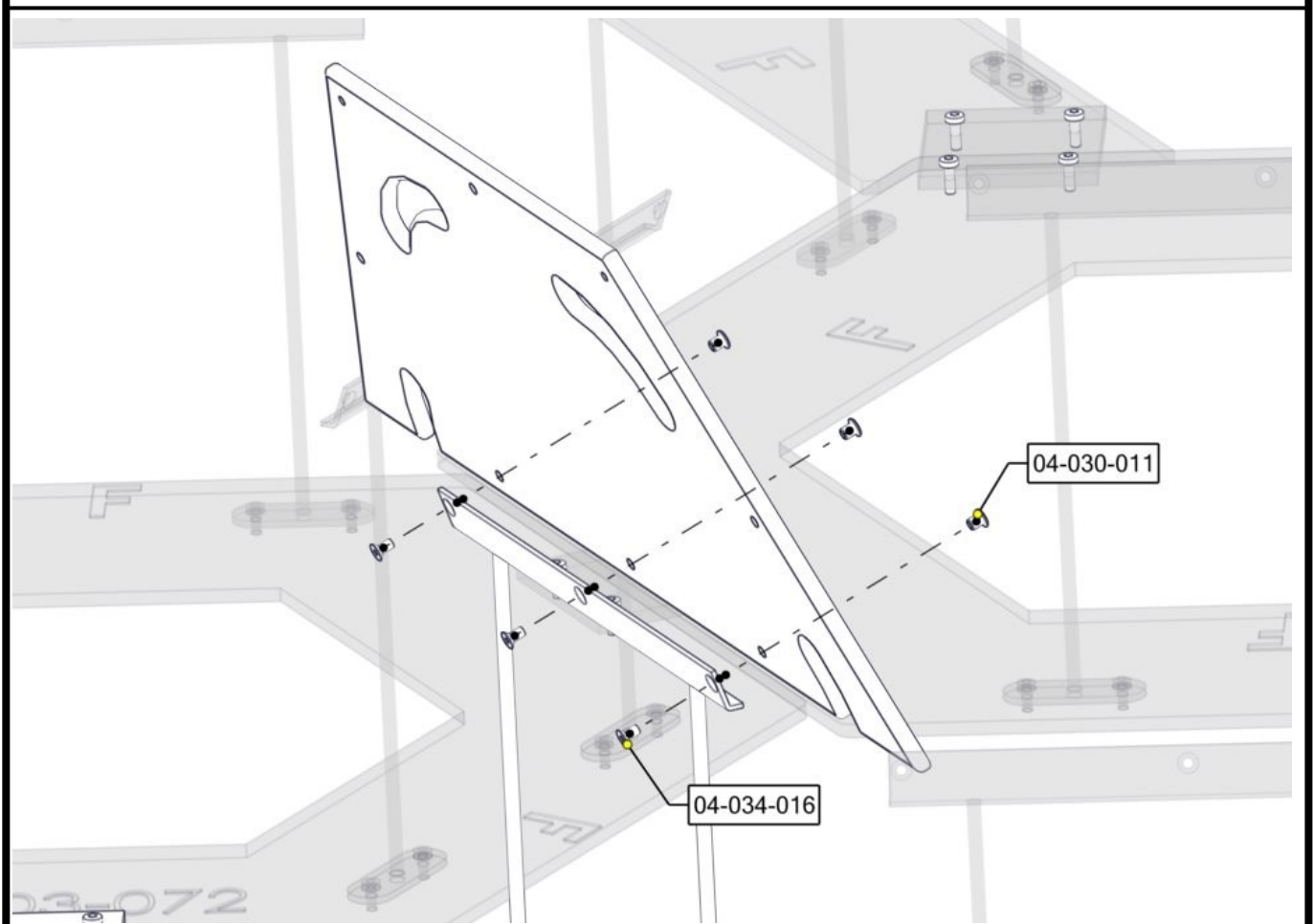
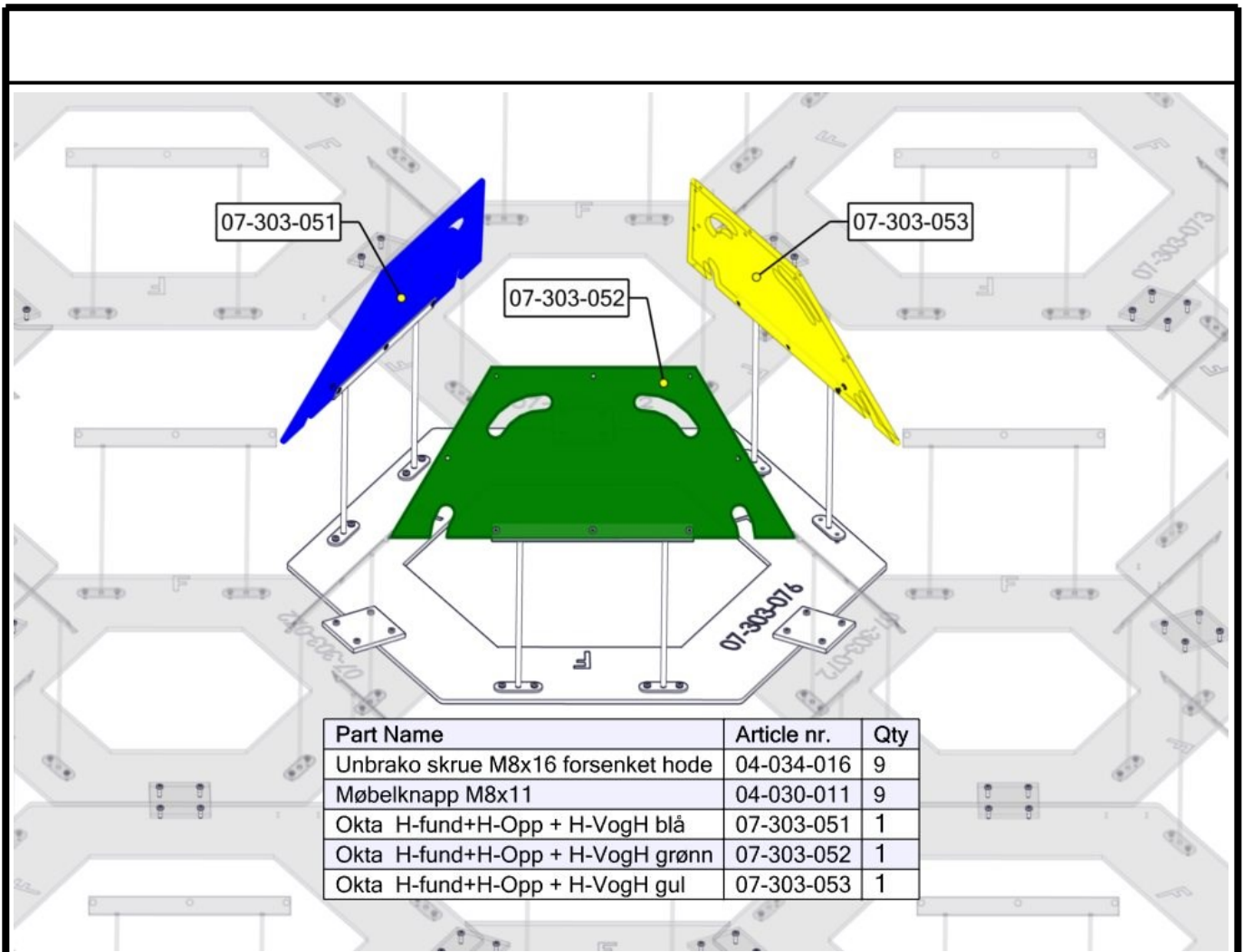

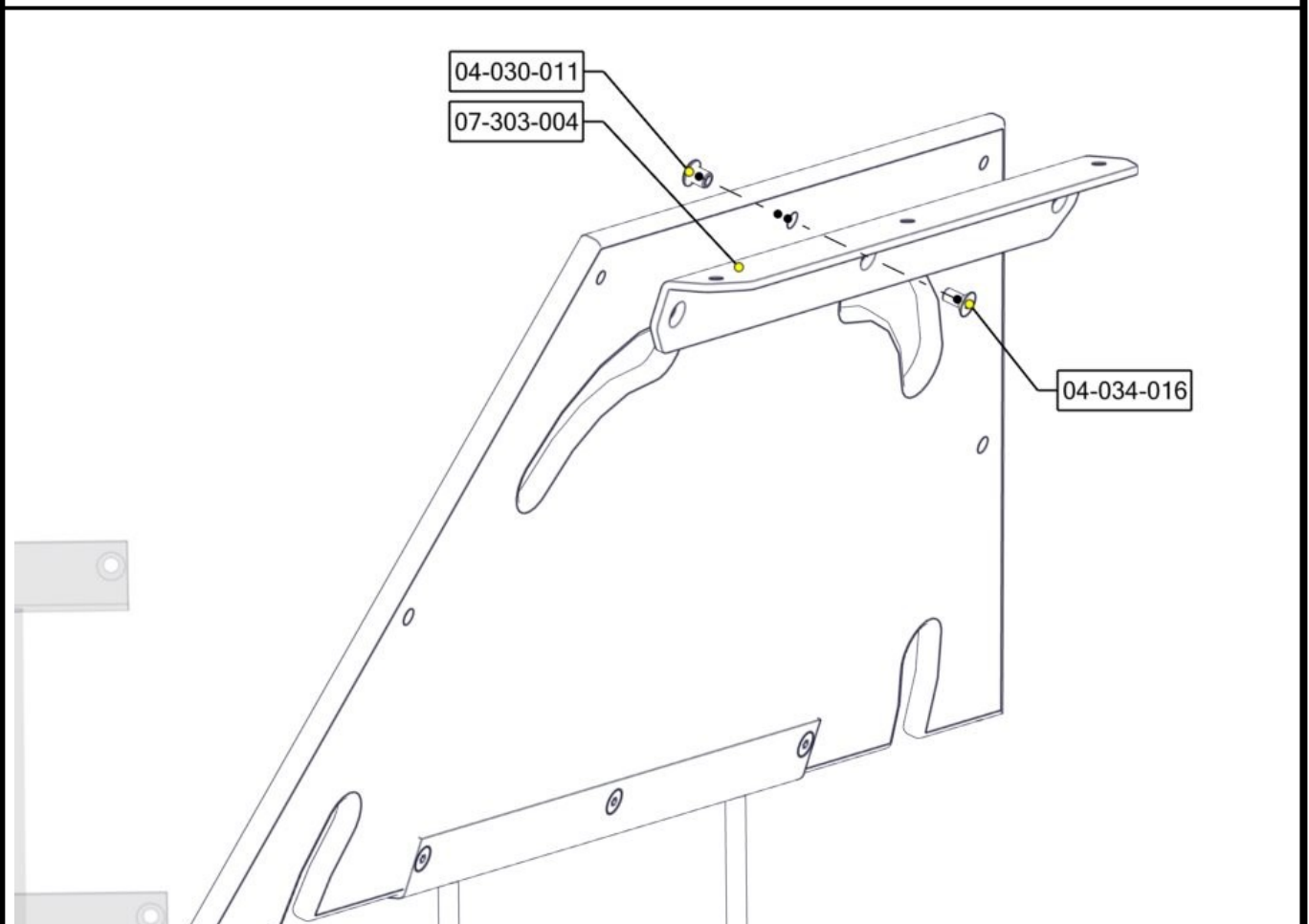
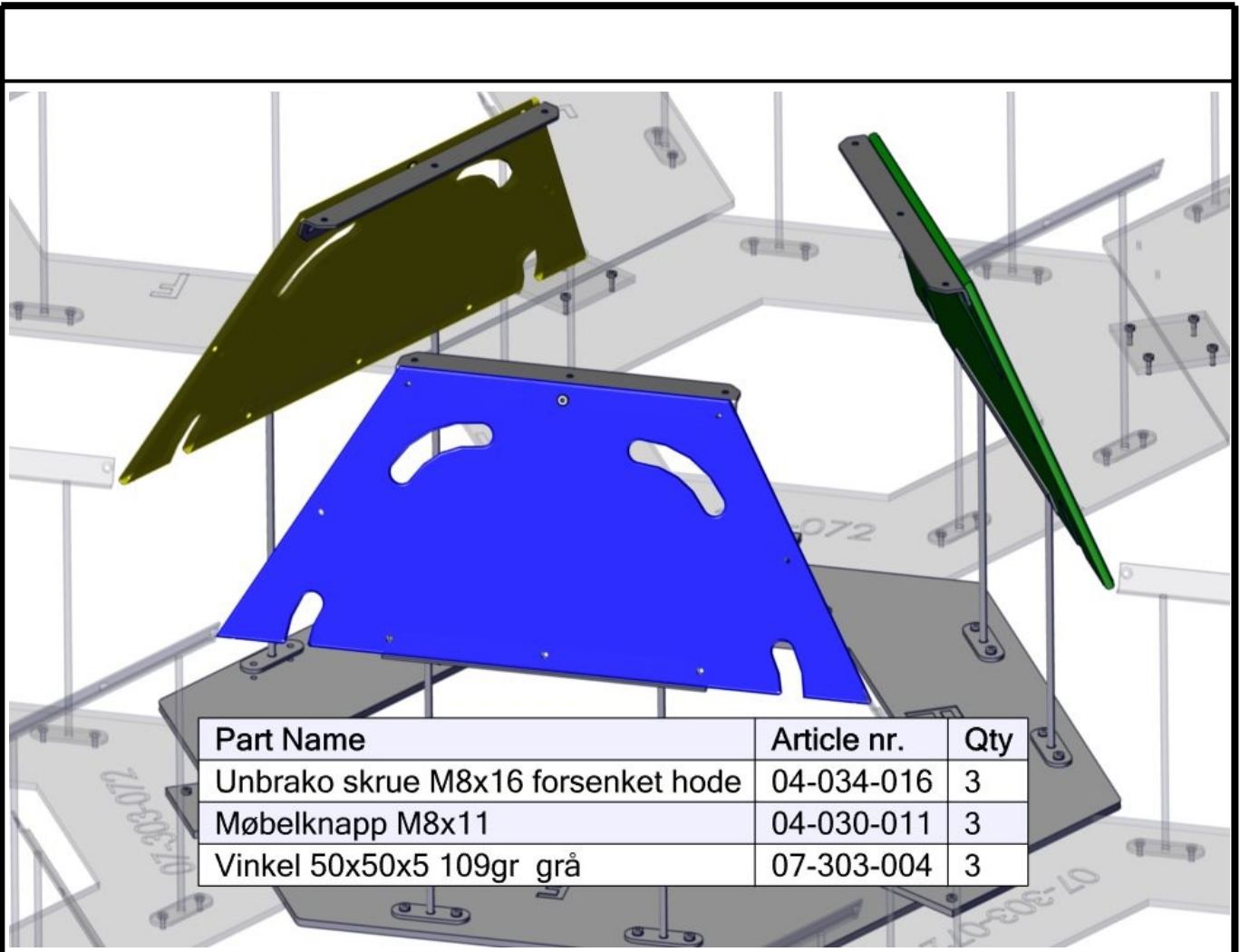

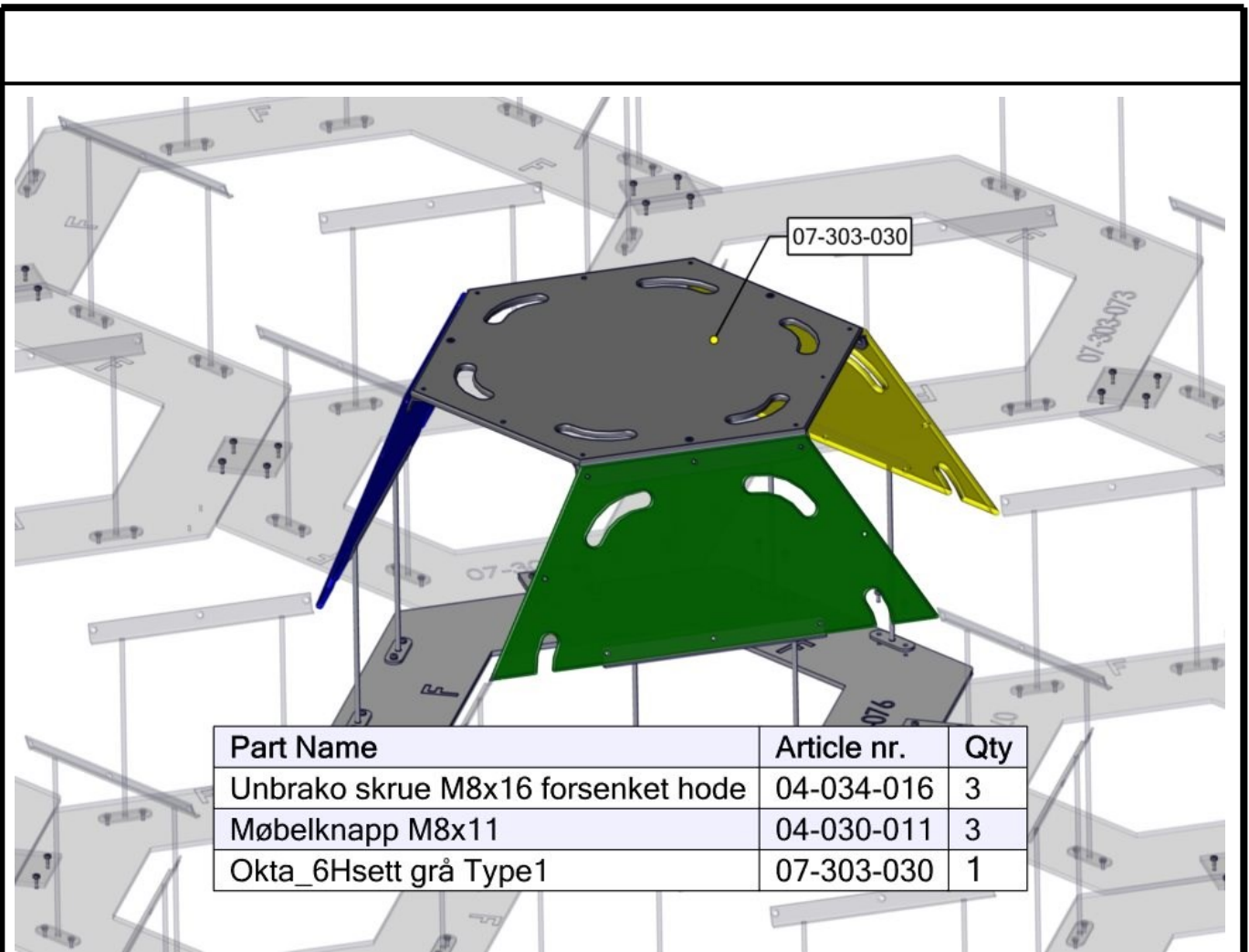

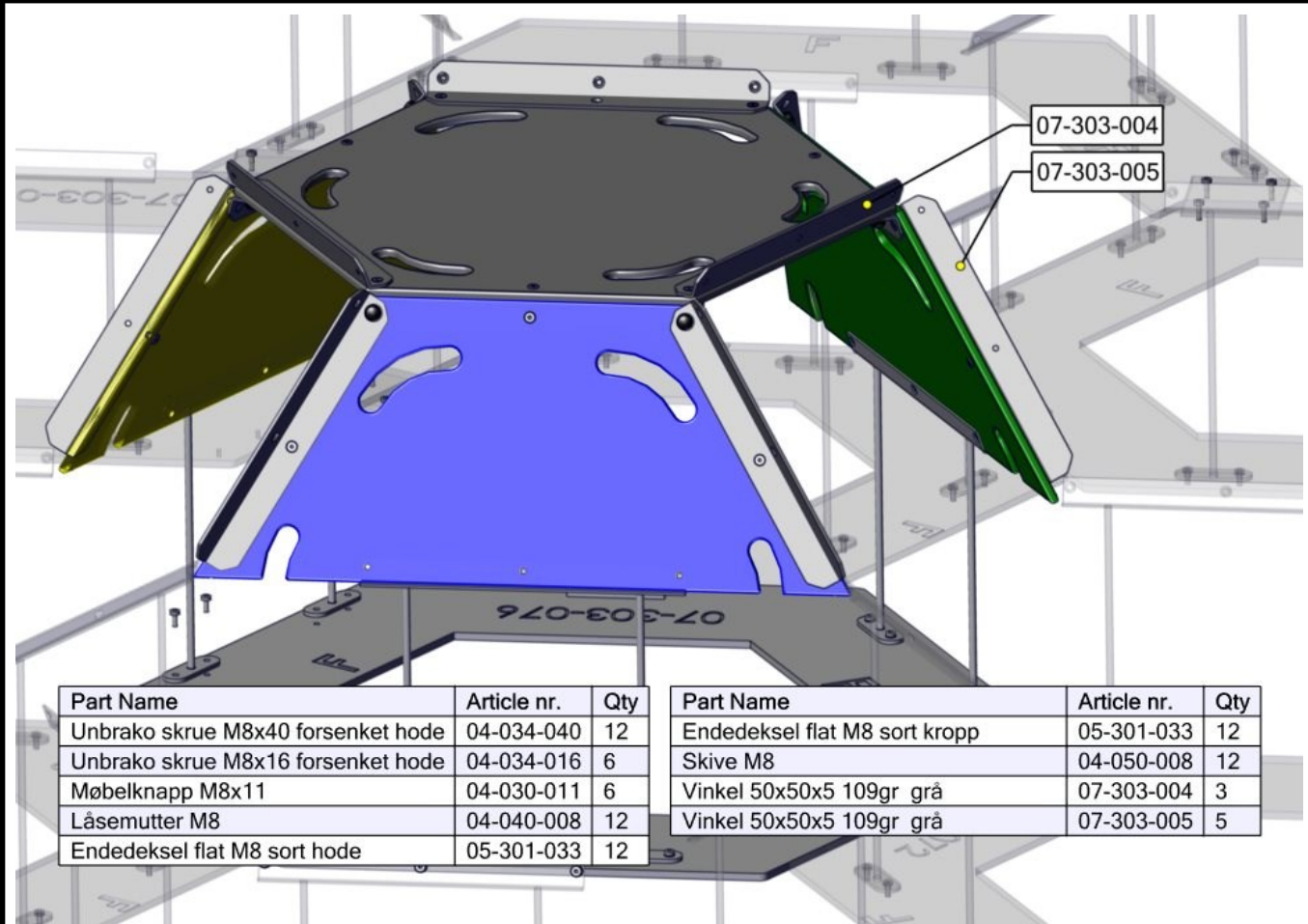
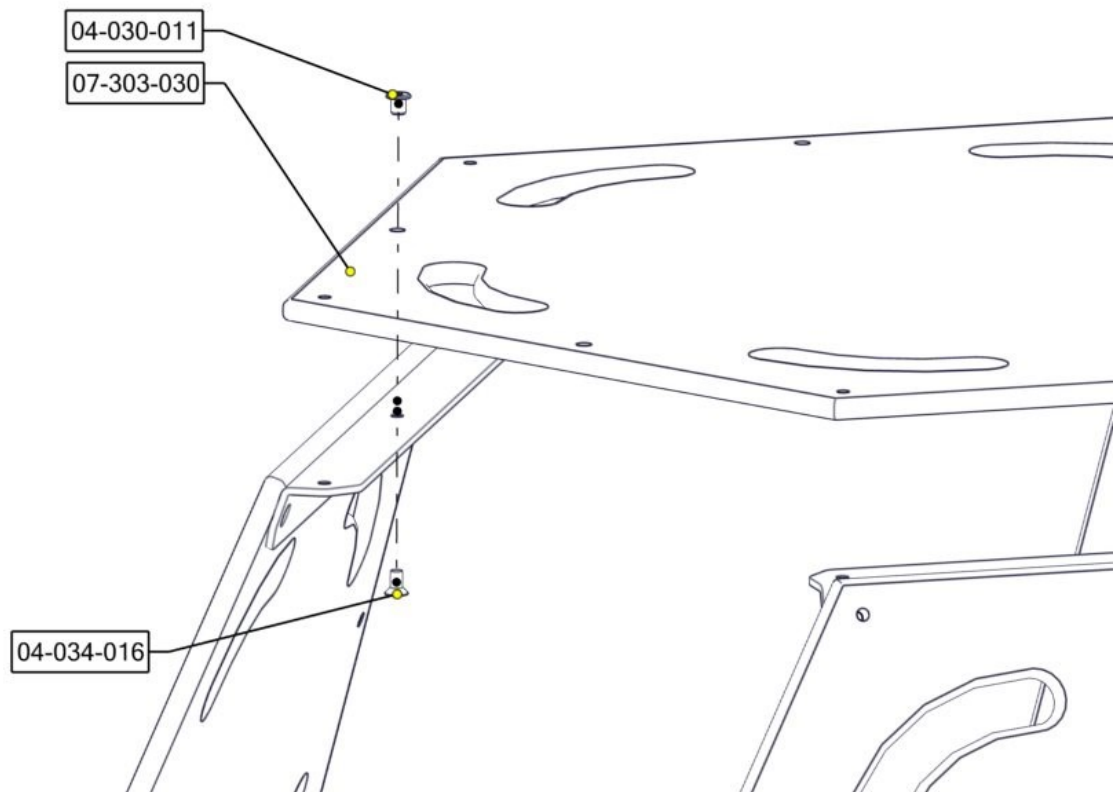

Part Name	Article nr.	Qty
Unbrako skrue M8x40 forsenket hode	04-034-040	12
Unbrako skrue M8x16 forsenket hode	04-034-016	6
Møbelknapp M8x11	04-030-011	6
Låsemutter M8	04-040-008	12
Endedeksel flat M8 sort hode	05-301-033	12

Part Name	Article nr.	Qty
Endedeksel flat M8 sort kropp	05-301-033	12
Skive M8	04-050-008	12
Vinkel 50x50x5 109gr grå	07-303-004	3
Vinkel 50x50x5 109gr grå	07-303-005	5

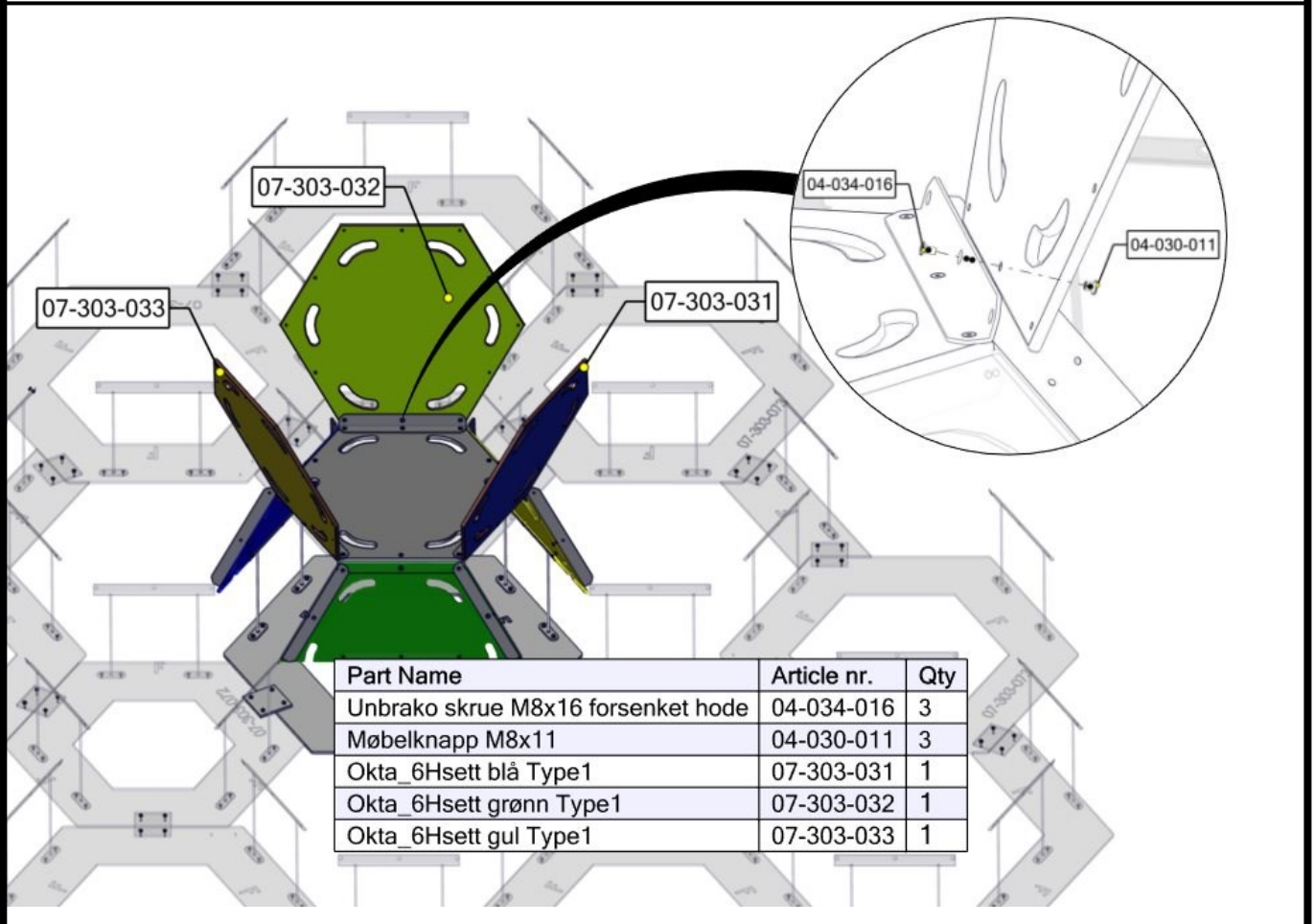
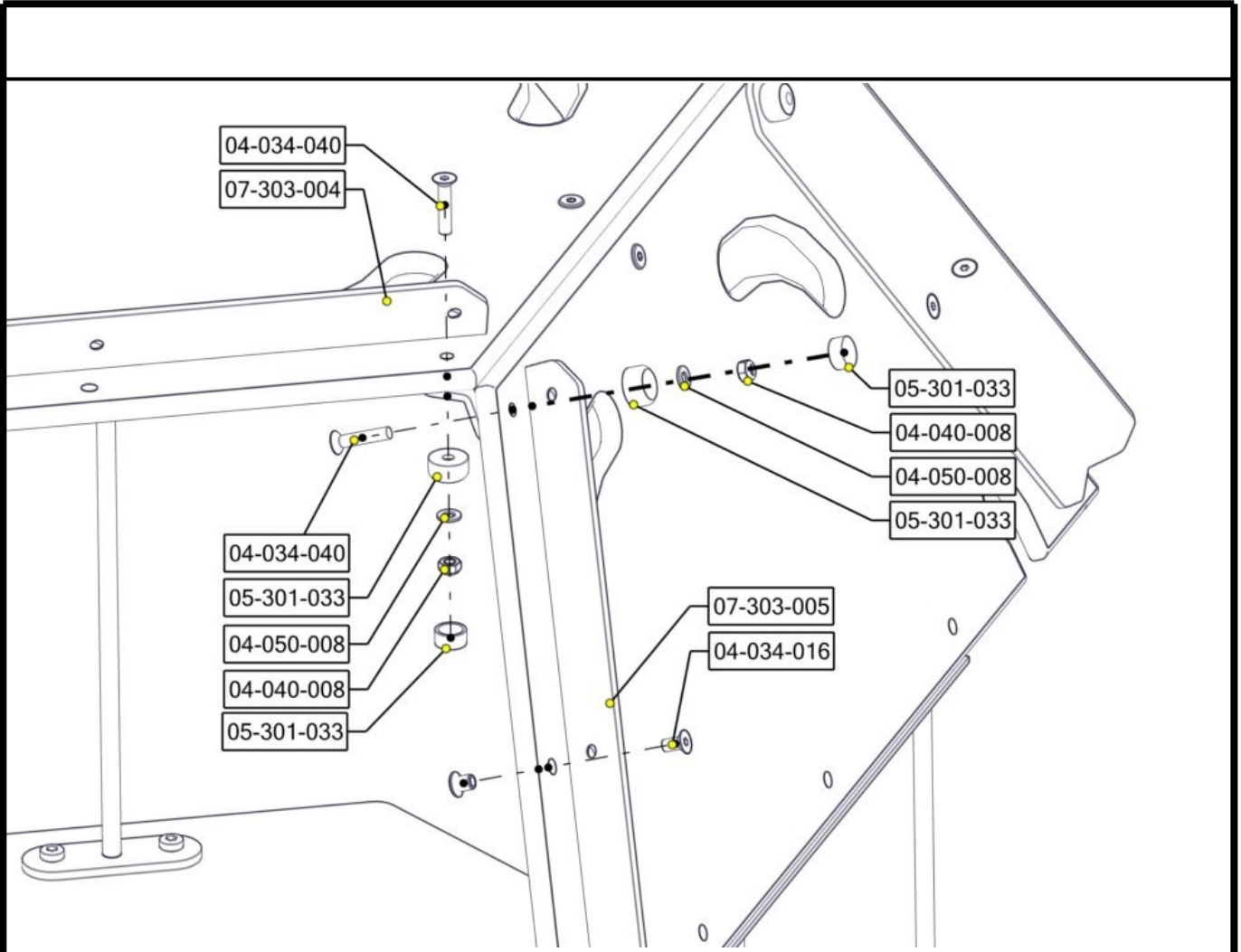

Part Name	Article nr.	Qty
Unbrako skrue M8x16 forsenket hode	04-034-016	30
Unbrako skrue M8x40 forsenket hode	04-034-040	12
Møbelknapp M8x11	04-030-011	30
Låsemutter M8	04-040-008	12
Okta_6Hsett blå Type2	07-303-081	2
Okta_6Hsett grønn Type2	07-303-082	2

Part Name	Article nr.	Qty
Okta_6Hsett gul Type2	07-303-083	2
Endedeksel flat M8 sort hode	05-301-033	12
Endedeksel flat M8 sort kropp	05-301-033	12
Skive M8	04-050-008	12
Vinkel 50x50x5 109gr grå	07-303-004	6

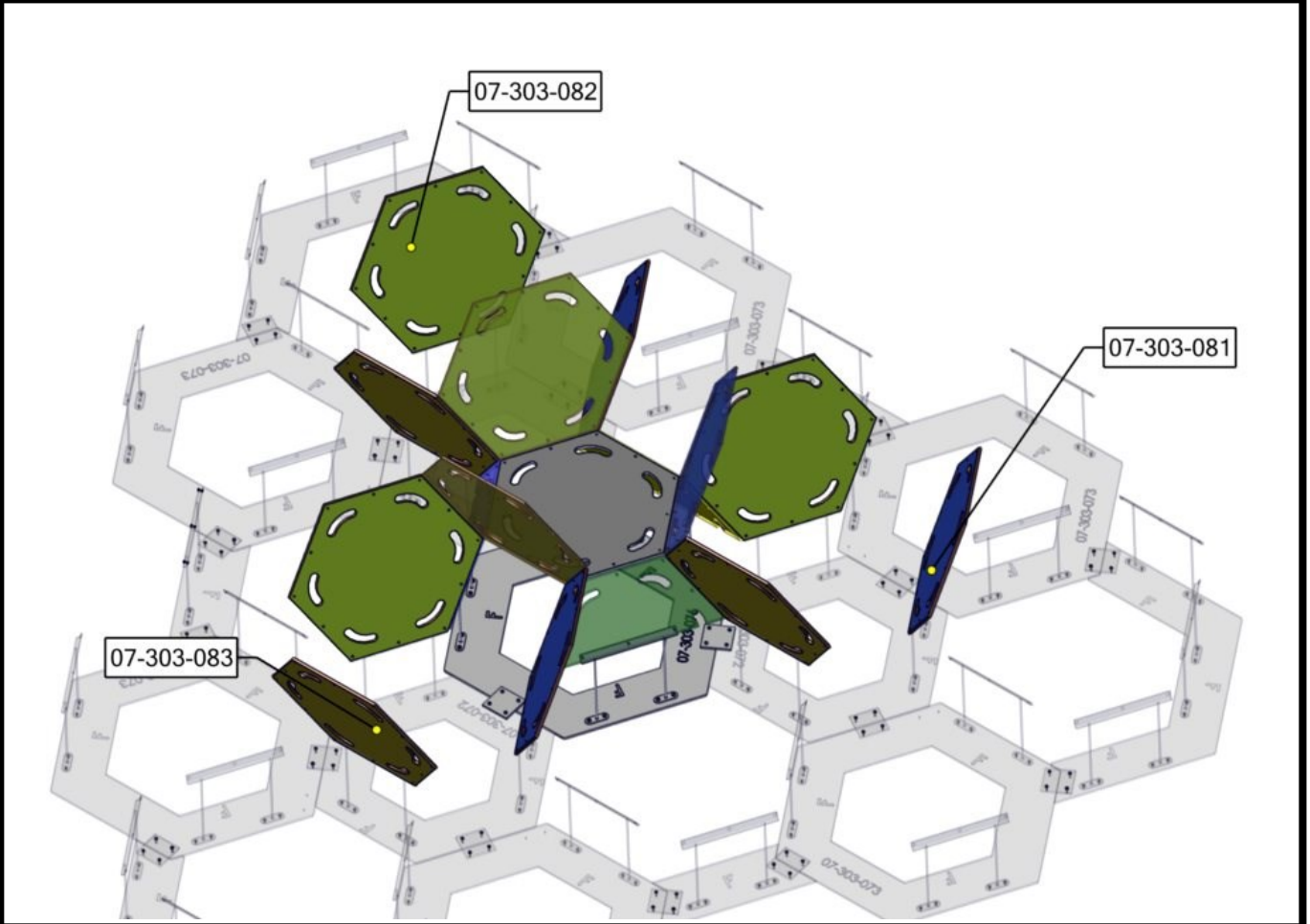

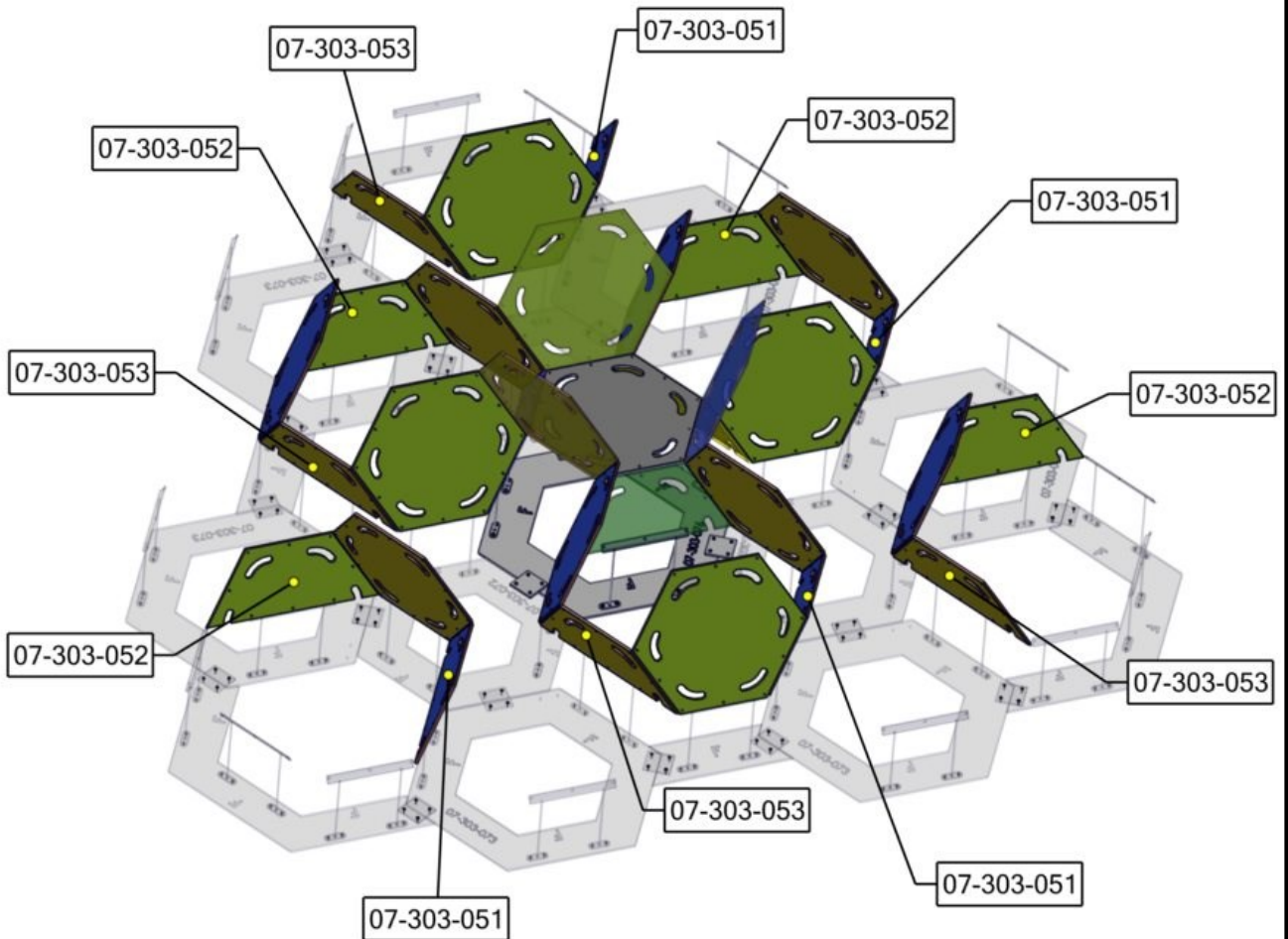
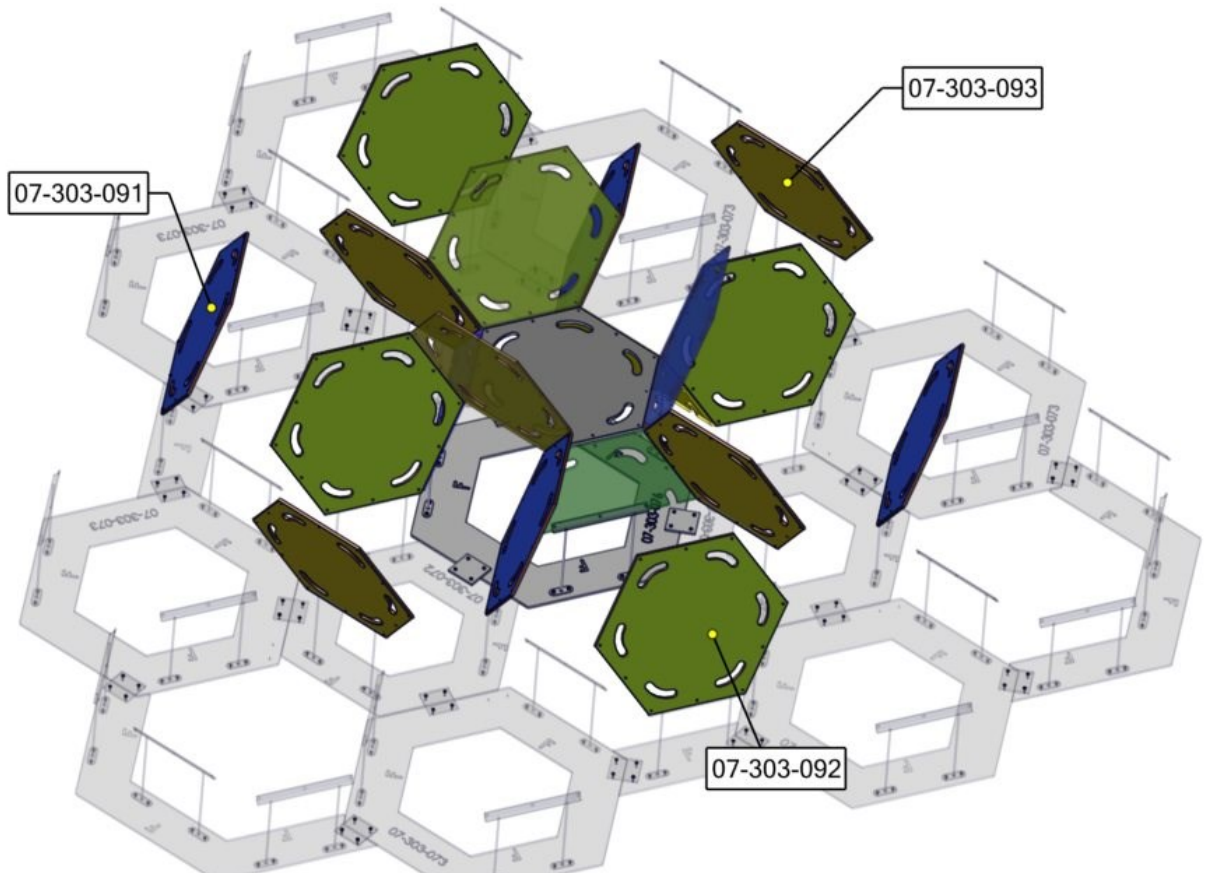

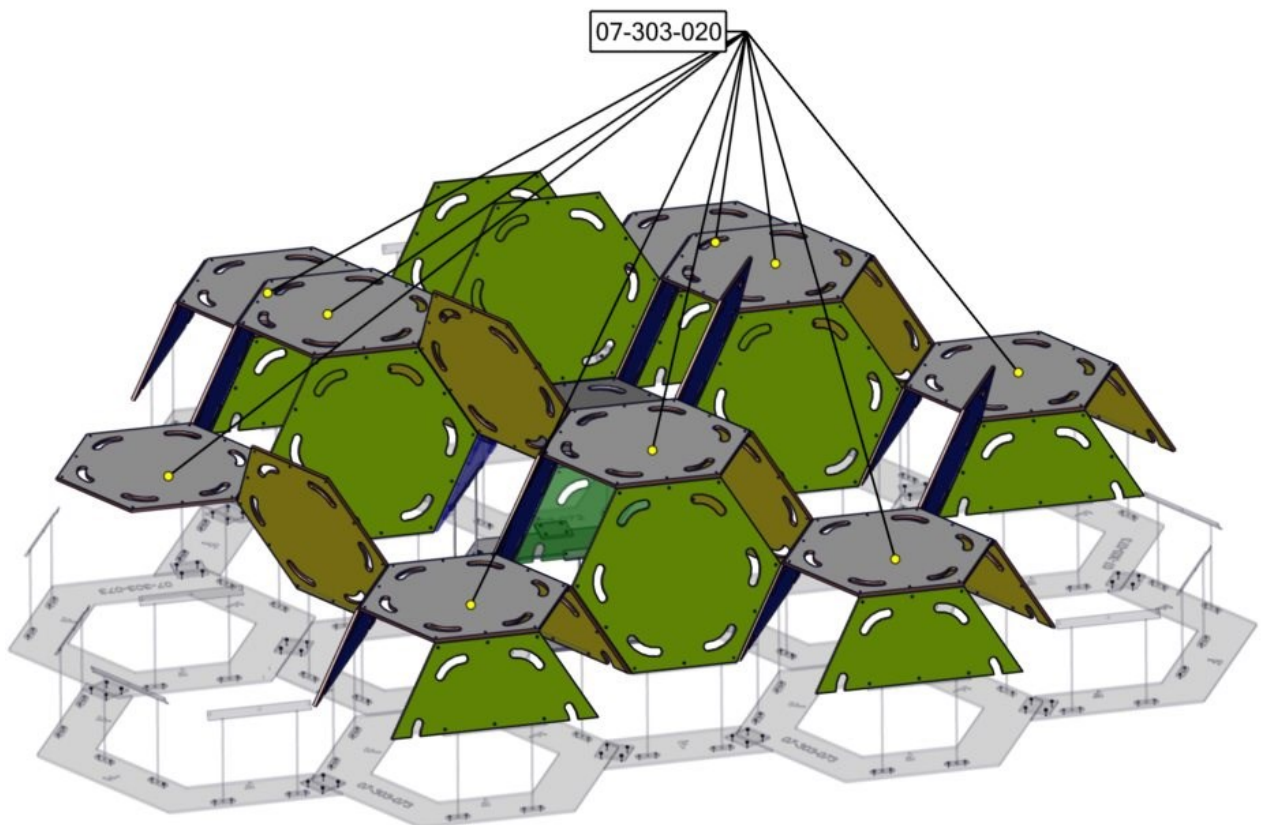
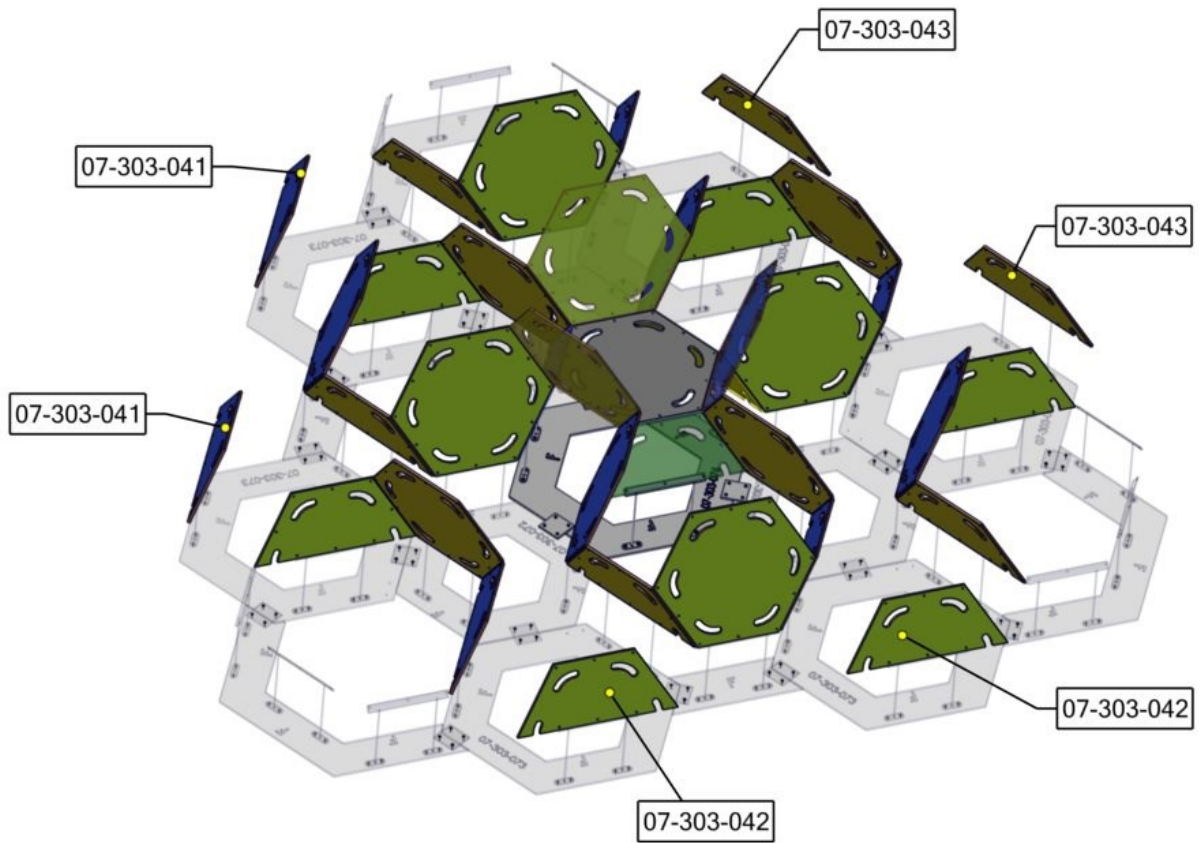

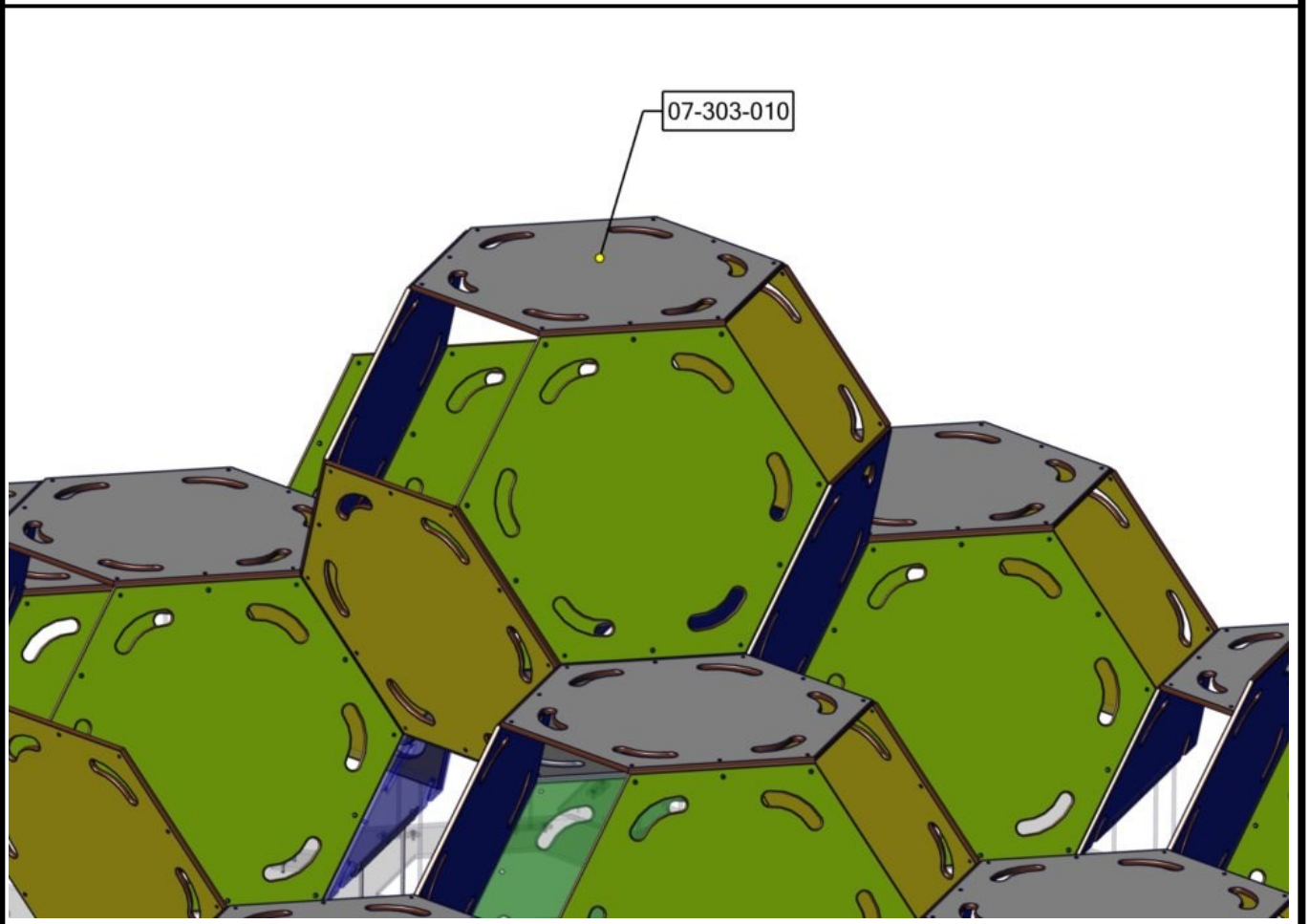
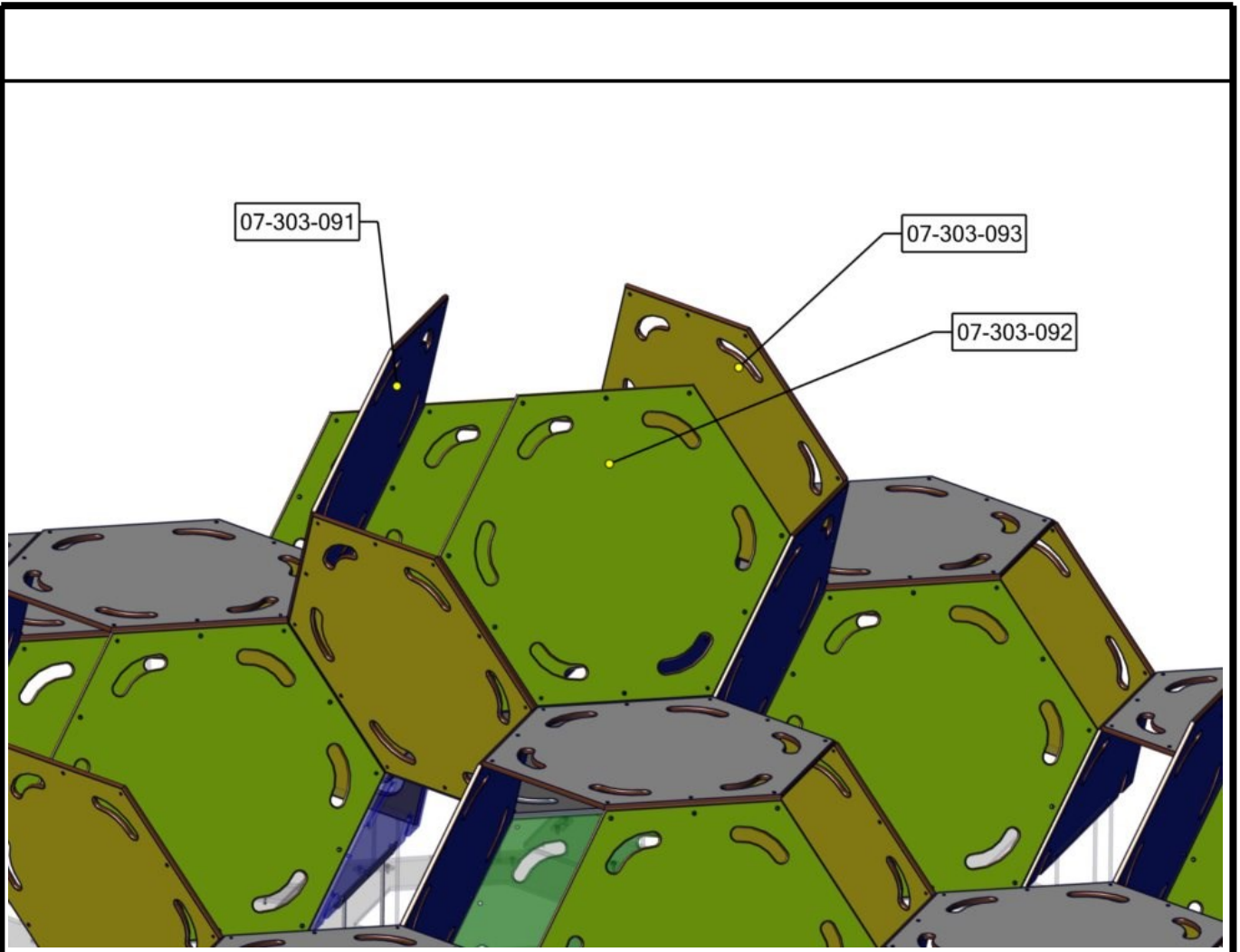

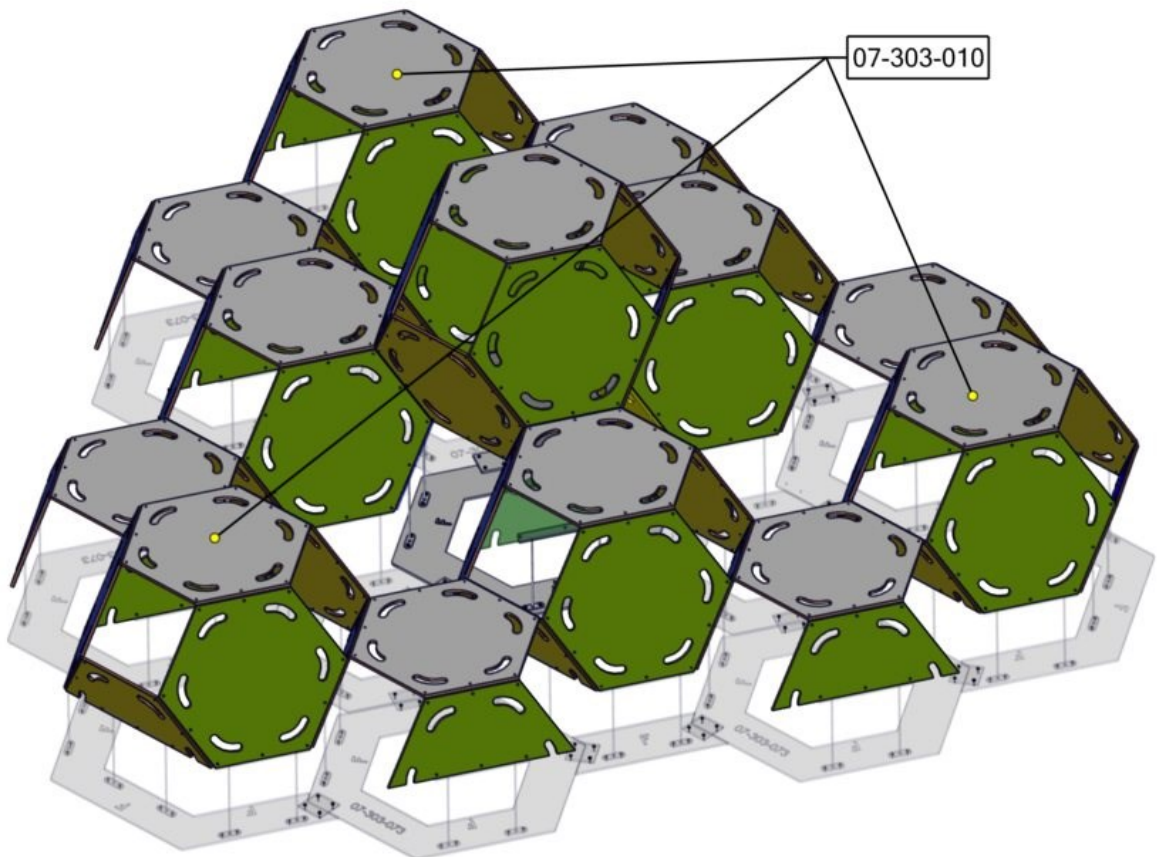
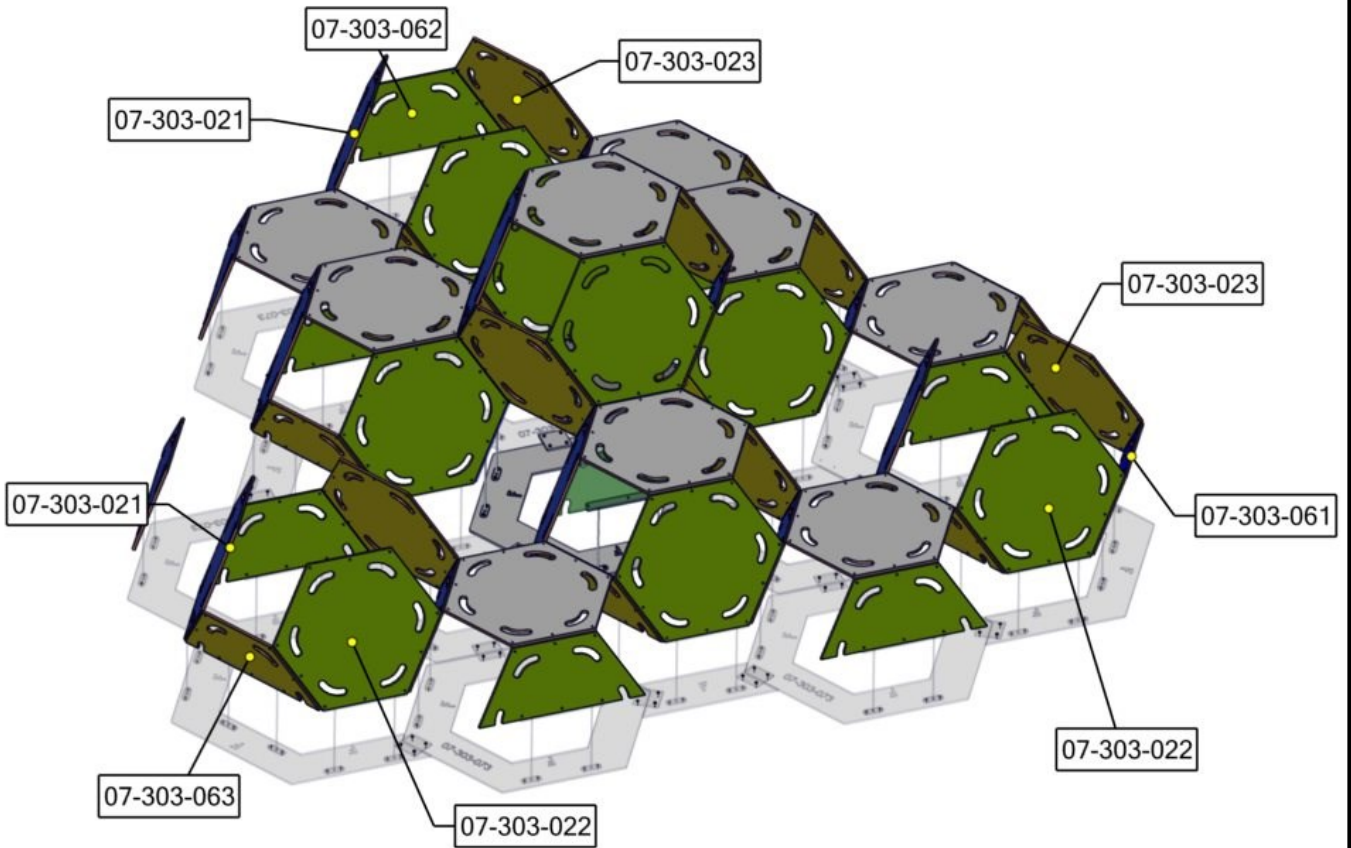

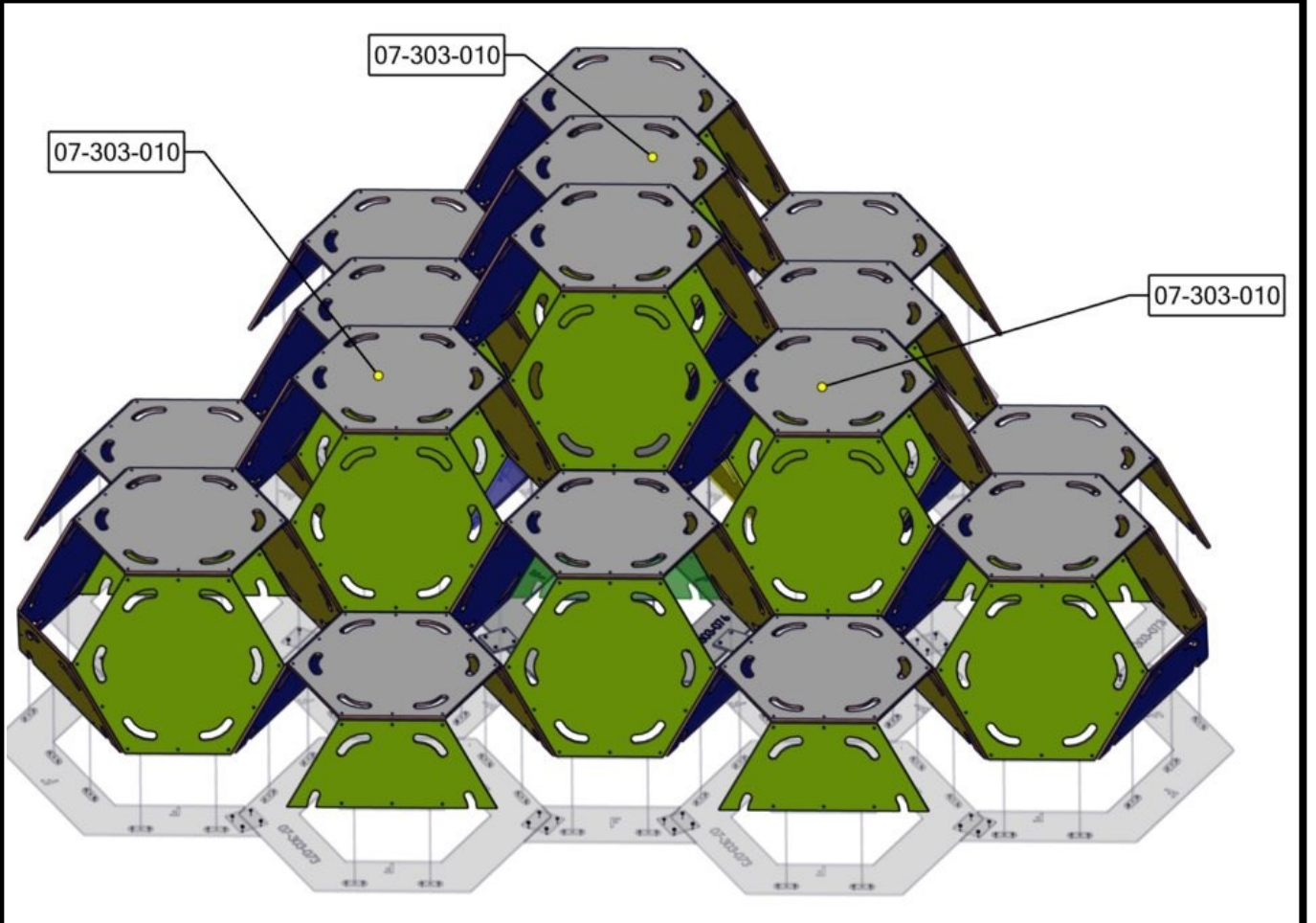
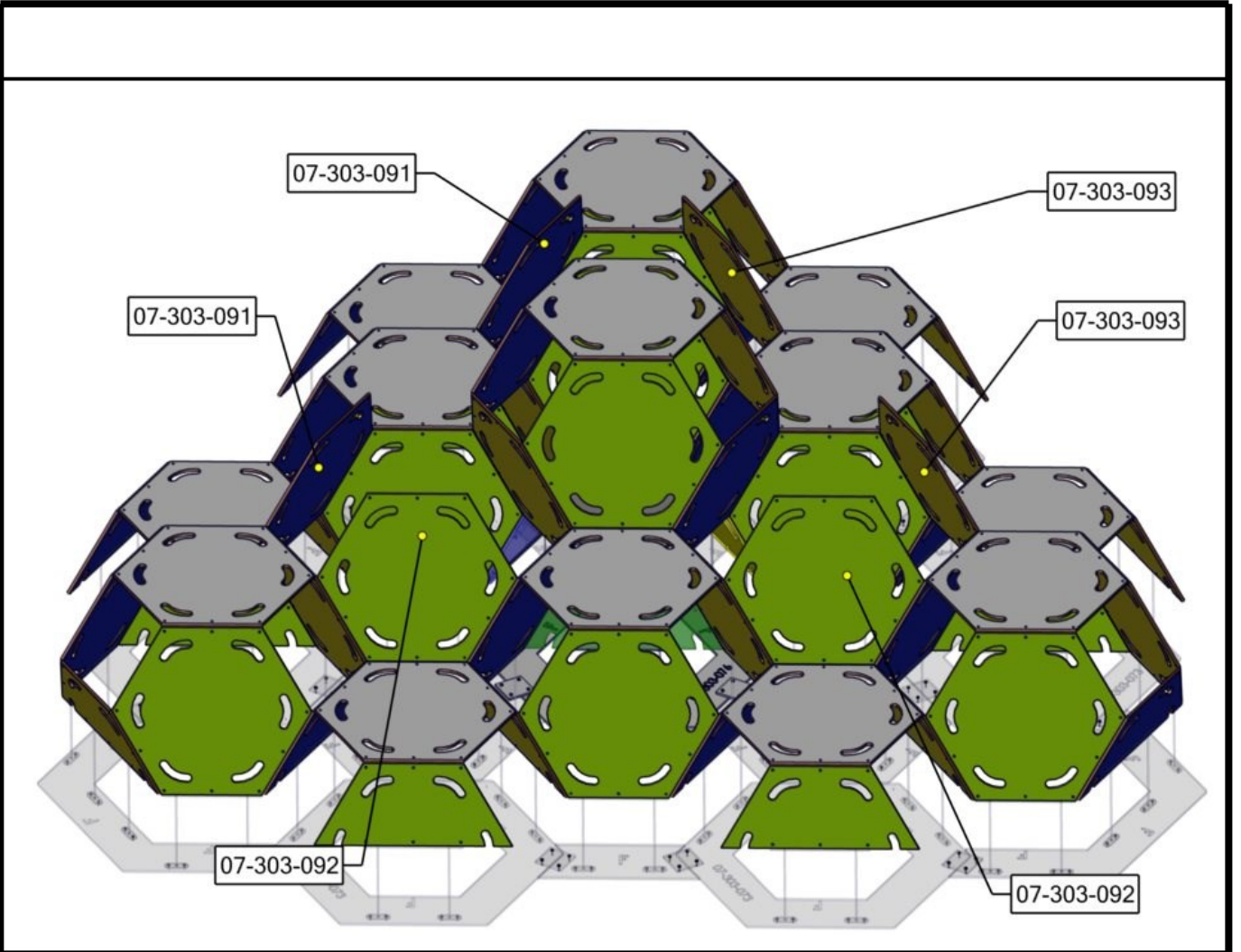



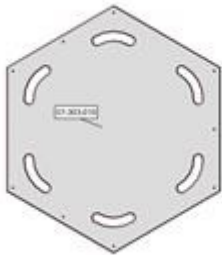

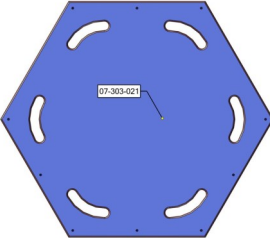
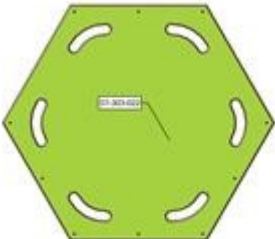





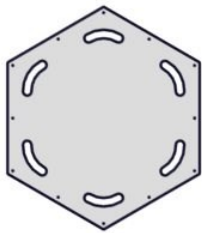
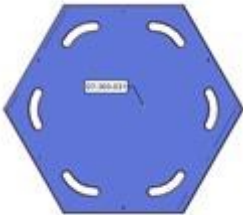
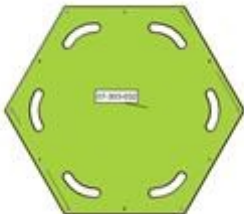

Før utstyret tas i bruk / Before play begins / Innan lekredskapet tas i bruk	
N	<ul style="list-style-type: none"> ● Påse at fallunderlag er utlagt i henhold til gjeldende regler eller vår anbefaling ● Fjern alle monteringshjelpemidler (rester av betong, planker, paller, plast, og lignende) ● Før utstyret tas i bruk, burde man sjekke at det ikke er fare for at anorakksnorer og lignende som kan hekte seg fast noen steder på lekeapparatet. (Vedlagte snor med dobbe (kneledd) kan brukes til å sjekke at dette er i orden. Se vedlagte veiledning for bruk av denne. Dette gjøres for å oppdage eventuelle feilmonteringer.? ● NB! Bør stå i 2-3 dager før bruk
EN	<ul style="list-style-type: none"> ● Make sure the area and depth of safer surfacing are according to the current standard, or to the manufacturer's recommendation ● Make sure all tools and surplus materials are removed before play begins ● PS! When complete, allow 2-3 days for the concrete to set before use
S	<ul style="list-style-type: none"> ● Kontrollera att fallunderlag är utlagt enligt gällande regler eller vårt rekommendation ● Ta bort alla monteringshjälpmedel (rester av betong, plankor, pallar, plast och liknande) ● Innan lekredskapet används, kontrollera att anoracksnoddar eller kläder/delar av kläder eller liknande inte kan fastna i några delar på redskapet. (Den bipackade "knävringen" kan man med fördel användas för denna kontroll. ● Detta görs för att upptäcka eventuella felmonteringar.)

Boltepakker for / Boltpackage for / Bultpaket för		Sign. _____.		
	Navn	Artnr/dimensjon	Ant	Lev
	Okta 3hull grå	07-303-010	7	
	Okta 4hull grå Type1	07-303-020	9	
	Okta 4hull blå Type1	07-303-021	2	
	Okta 4hull grønn Type1	07-303-022	2	
	Okta 4hull gul Type1	07-303-023	2	
	Merkeskilt Montert hos Søve	00-100-400	0	



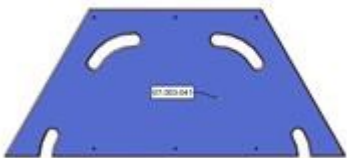

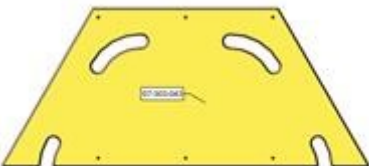
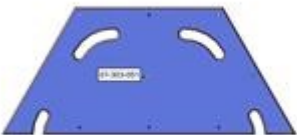
Boltepakker for / Boltpackage for / Bultpaket för

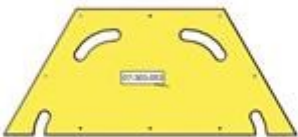



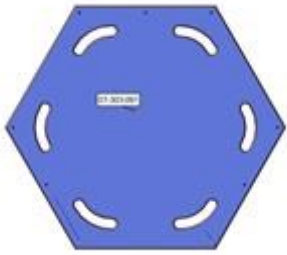
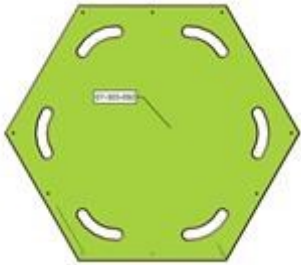
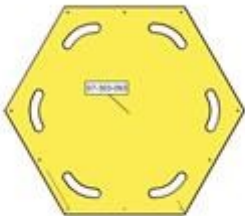

Sign. _____





	Navn	Artnr/dimensjon	Ant	Lev
	Okta 6hull grå Type1	07-303-030	1	
	Okta 6hull blå Type1	07-303-031	1	
	Okta 6hull grønn Type1	07-303-032	1	
	Okta 6hull gul Type1	07-303-033	1	
	Møbelknapp M8 16x11	04-030-011	692	
	QR merke Montert hos Søve	00-100-406	0	

Boltepakker for / Boltpackage for / Bultpaket för		Sign. _____.		
	Navn	Artnr/dimensjon	Ant	Lev
	Okta H-fun-H-opp blå	07-303-041	2	
	Okta H-fun-H-opp grønn	07-303-042	2	
	Okta H-fun-H-opp gul	07-303-043	2	
	Okta H-fun-H-opp H- VogH blå	07-303-051	4	
	Okta H-fun-H-opp H- VogH grønn	07-303-052	4	
	Okta H-fun-H-opp H- VogH gul	07-303-053	4	

Boltepakker for / Boltpackage for / Bultpaket för		Sign. _____.		
	Navn	Artnr/dimensjon	Ant	Lev
	Okta H-fun-H-VogH blå	07-303-061	1	
	Okta H-fun-H-VogH grønn	07-303-062	1	
	Okta H-fun-H-VogH gul	07-303-063	1	
	Okta 6 hull blå Type 2	07-303-081	3	
	Okta 6 hull grønn Type 2	07-303-082	3	
	Okta 6 hull gul Type 2	07-303-083	3	

Boltepakker for / Boltpackage for / Bultpaket för		Sign. _____.		
	Navn	Artnr/dimensjon	Ant	Lev
	Okta 4 hull blå Type2	07-303-091	4	
	Okta 4 hull grønn Type2	07-303-092	4	
	Okta 4 hull gul Type2	07-303-093	4	
	Okta vinkel grå	07-303-004	87	
	Okta kappet vinkel grå	07-303-005	36	
	Okta fundamentforankring	07-303-070	42	

Boltepakker for / Boltpackage for / Bultpaket för		Sign. _____.		
	Navn	Artnr/dimensjon	Ant	Lev
	Okta fundament kobling	07-303-071	21	
	Okta fundament type1	07-303-072	3	
	Okta fundament type2	07-303-073	6	
	Okta fundament type3	07-303-074	3	
	Okta fundament type4	07-303-075	3	
	Okta fundament type5	07-303-076	1	

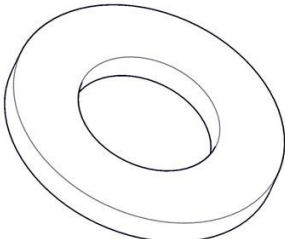
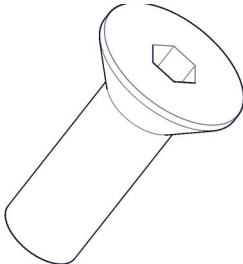
Boltepakker for / Boltpackage for / Bultpaket för		Sign. _____		
	Navn	Artnr/dimensjon	Ant	Lev
	Torx M8x20 Torx M8x30	04-000-020 04-000-030	168 84	
	Sikkerhetshette 20mm M8 Sort	05-301-033	102	
	Sikkerhetshette kropp 32mm M8 Sort	05-301-033	102	
	Låsemutter M8	04-040-08	102	
	Skive M8	04-050-008	168	
	Unbrako Skrue M8x16 For- senket hode Unbrako Skrue M8x40 For- senket hode	04-034-016 04-034-040	516 102	

Revisjon:

09.09.2020 MTF

Lagt til tabell med mål, betong og vekt

Oppdatert BOM

Oppdatert fundamentbilder

Oppdatert div view

Oppdatert/endret bilder for sikkerhetssone, areal og stolpeplassering

Lagt til bilde/forklaring på s. 3

Oppdatert plukklister med møbelknapper

MTK 29-11-2023

QR merking i tillegg