

N**Monteringsanvisning****EN****Assembly Instructions****S****Monteringsanvisning**

Produkt nr. / Product no. / Produkt nr.

23-400-028

Ordr nr. _____

Dato. _____

Sign. _____

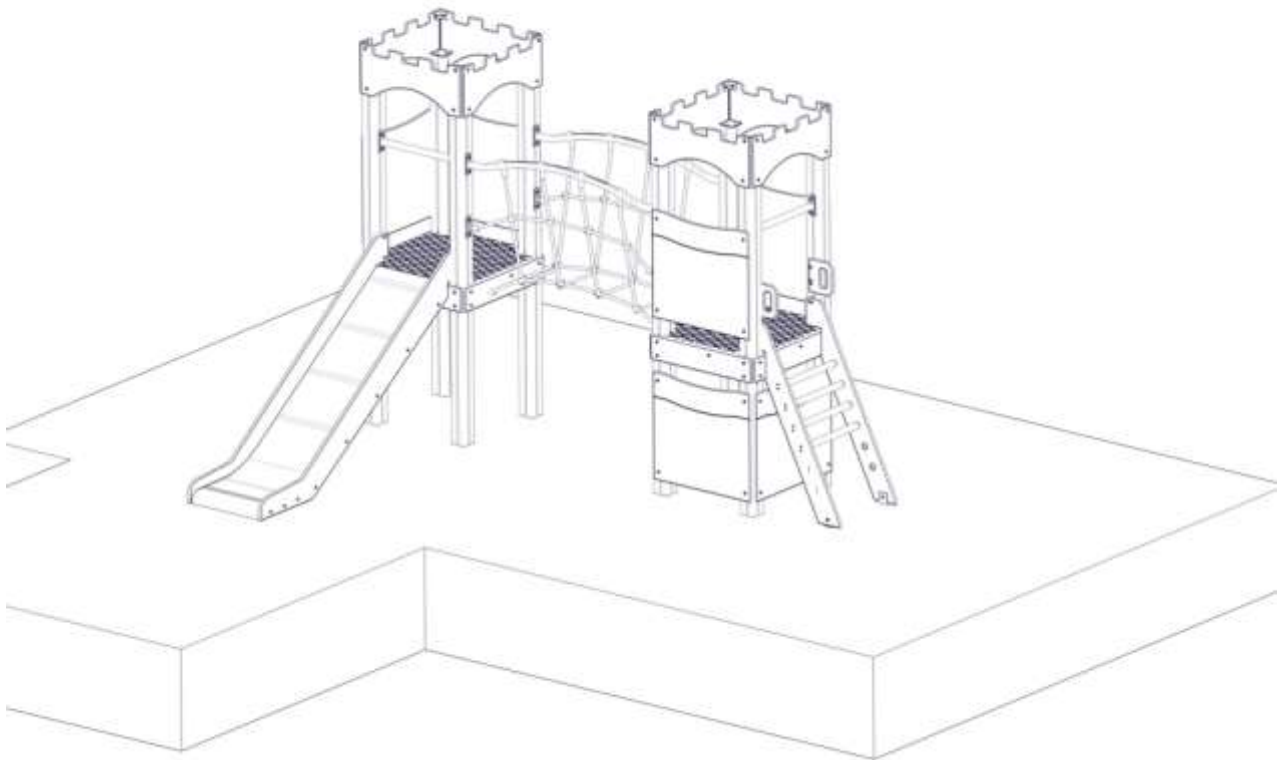
**sove**

Søve AS
3830 Ulefoss - Norway
Tlf: +47 35 94 65 65
www.sove.no



Søve AB
EA Rosengrensgatan 32
421 31 Västra Frölunda
Phone: +46 (0)31 773 97 00
www.sove.se

Monteringstips / Assembly Advice / Monteringsstips

N

- Les monteringsanvisningen nøye før montering.
- Monter elementene i rekkefølgen som vist.
- Boltene bør ikke skrues for hardt til før alt er montert, vatret og loddet. Skru så boltene til.
- NB! Ved bruk av drill, kan boltene ryke.
- På grunn av at solen kan gjøre rutsjeflaten veldig varm, bør rutsjebanens utløp vende mot nord-øst eller nord-vest.
- Er lekeutstyret plassert i naturlige ferdselstraséer må området sikres mot gjennomgang.
- Innspringningshinder bør vurderes rundt lekeapparater hvor det er stor bevegelse, f.eks. ved huskestativ.
- Det bør være fritt innsyn til lekeutstyr som er beregnet for barn under 3 år.

NB! Under monteringsarbeidet må utstyr, som ikke er forankret forsvarlig i bakken, sikres slik at det ikke velte. Området må avstenges under montering av apparatene med sperrebånd eller lignende.

EN

- Read the instruction carefully before assembling the play unit..
- Assemble the components in the sequence shown in these instructions.
- Fixings must not be fully tightened during assembly. Before casting the foundations, the structure must be level and plumb, at which point all fixings are tightened.
- PS! If use of drill, the bolts may be wrecked.
- Avoid positioning the slide facing due south because of overheating – ideal positions are facing north-east or north-west.
- Secure the construction-area to prevent people from walking through it.
- Consider installing barriers around play-equipment which gives rise to a lot of activity – i.e.swings.
- Ensure that clear vision is possible across the play area so that supervision is possible from any position, particularly where children under 3 years of age will be playing.

NB! During assembly of the equipment, ensure that all structures are securely propped, especially when left overnight. Also ensure that equipment is supported whilst concrete foundations are setting and enclose the area securely to prevent access.

Monteringstips / Assembly Advice / Monteringsstips











S

- Läs monteringsanvisningen noga före montering.
 - Montera delarna i den ordningen som anvisas
 - Skruvarna bör inte skruvas för hårt tills allt är monterat, i väg och lodat.
- OBS! Används elektrisk skruvdragare, kan bulten gå sönder. Hårddra därför manuellt!
- Solen kan göra att rutchbanan blir väldigt varm. Banans nedfart rekommenderas att vändas i norrlig riktning
 - Om lekplatsen placeras vid en gångväg mm bör området säkras mot genomfart av gående och cyklister.
 - Insprängningshinder bör placeras runt lekutrustning med stor rörelse, t ex, gungställning.
 - Det bör vara fri insyn till lekutrustning beräknat till barn under 3 år.

OBS! Under monteringsarbete bör utrustningen som inte ska förankras i marken, ställs så att den inte kan välta.

Området måste spärras när lekutrustningen byggs upp, med avspärrningsband eller liknande.

Nødvendig verktøy / Tools required / Nödvändiga verktyg

<p>(N)</p> <p>(EN)</p> <p>(S)</p>	<p>(A)</p> 	<p>(B)</p>  <p>Torx Nr 45 High quality</p>	<p>(C)</p> <p>5 mm 6 mm</p> 	<p>(D)</p> 	<p>(E)</p> 
		<p>Metermål Metric measure Tumstock</p> 	<p>16 V</p> 	<p>Merkebånd Mark ribbon Märkeband</p> 	<p>13 + 17mm</p> 

Nødvendig antall personer / Number of persons required / Rekommenderad antal personer

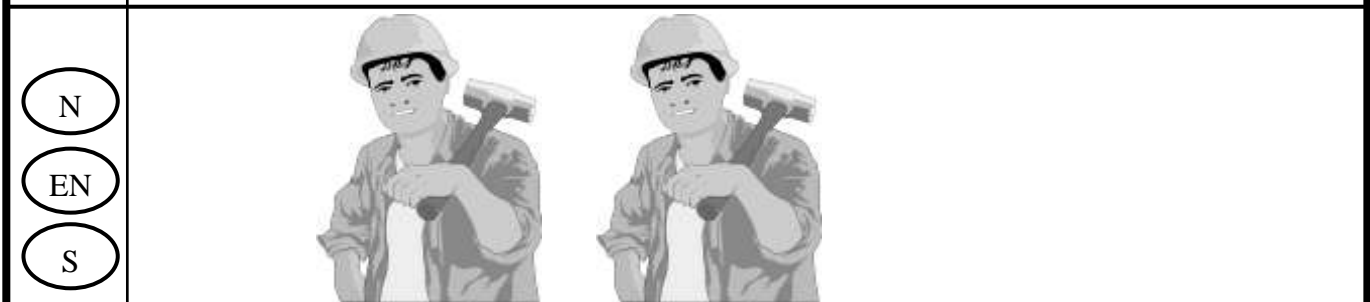



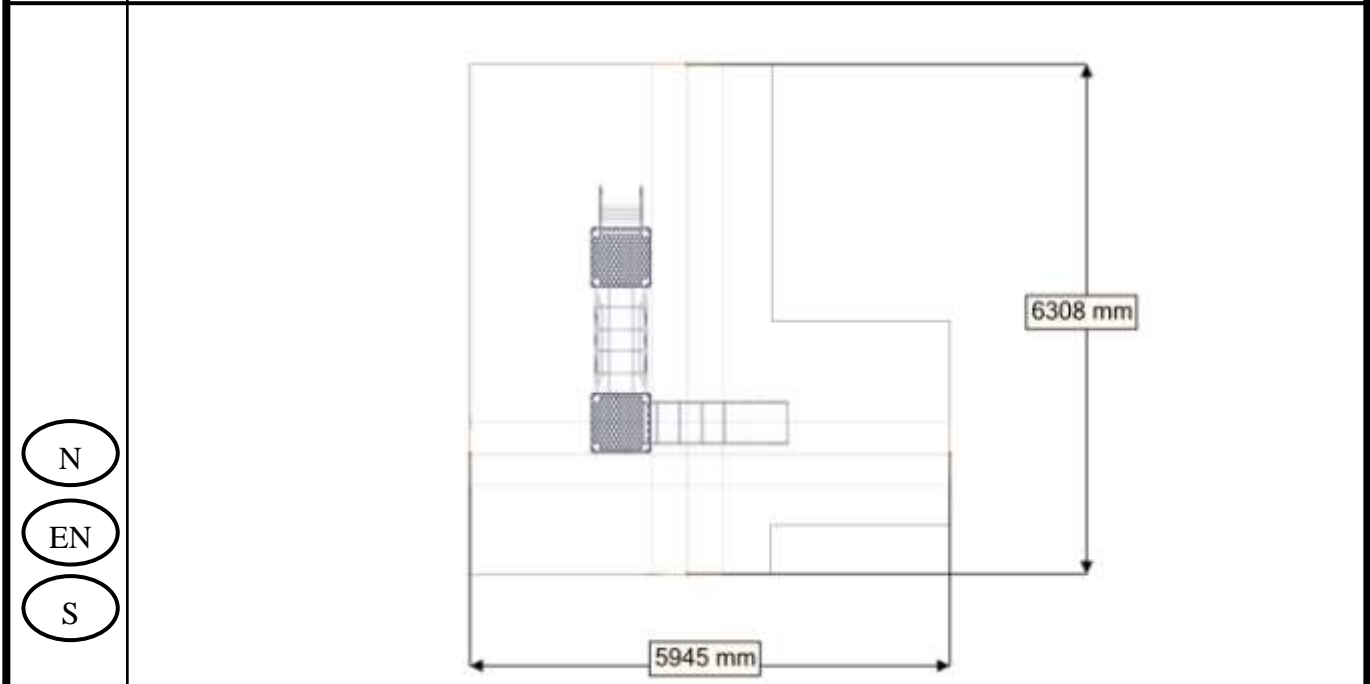







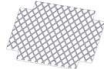







Anbefalt arealbehov ved montering / Recommended working space / Rekommenderad arealbehov ved montering











Boltepakker for / Boltpackage for / Bultpaket för

Sign. _____

Stolpe 95x95	Ant= 1	Navn	Artnr/dimensjon	Ant	Lev
		VK95 L=2600 600-2000 (16)	00-400-018	8	
		Stolp ende (1)	00-400-998	8	
Gulv 740x740x15	Ant= 2	Navn	Artnr/dimensjon	Ant	Lev
		Gulv (1)	00-400-300	2	
		Vinkel 50x50x4(1)	04-070-050	3	
		Torx M8x30 (1) Torx M8x12(1)	04-000-030 04-000-012	3 3	
		Møbelknapp (1)	04-030-011	3	
		Plast plug 9-11 mm (16)	04-090-002	32	
		Plug spor (8)	00-400-980	16	
		Skive M8 (2)	04-050-008	6	
		Låsemutter M8(1)	04-040-008	3	
Sprosse 01-400-108	Ant= 6	Navn	Artnr/dimensjon	Ant	Lev
		Sprosse (1) 740x145x15	01-400-108	6	
		Torx M8x35 (4)	04-000-035	24	
		Brikke 150_3T (6) På stolpe	04-050-008	0	
Sprosse 01-400-109	Ant= 2	Navn	Artnr/dimensjon	Ant	Lev
2 hull for bro cc300 		Sprosse (1) 740x145x15 2 hull bro	01-400-109 2 hull bro CC300	2	
		Torx M8x35 (4)	04-000-035	8	
		Brikke 150_3T (6) På stolpe	04-050-008	0	





Boltepakker for / Boltpackage for / Bultpaket för

Sign. _____.

Nettbro rett 07-510-174	Ant= 1	Navn	Artnr/dimensjon	Ant	Lev
		Nett (1) INKL. beslag	07-510-174	1	
		Rør bue(2)	07-510-164	2	
		Brikke120 3T(8)	04-060-120	8	
		Torx M8x25(16)	04-000-025	16	
		Saddelwasher 38mm (16)	04-210-010	16	
		Møbelknapp M8x25 (8)	04-030-025	8	
		Låsemutter	04-040-008	4	
		Skive M8	04-055-008	4	













Boltepakker for / Boltpackage for / Bultpaket för

Sign. _____.

Vegg 688x636x12 01-125-010	Ant= 7	Navn	Artnr/dimensjon	Ant	Lev
		Vegg 688x636x12 (1)	01-125-010	7	
		Brikke 50_1T(4)	04-060-050	28	
		Torx M8x35(4)	04-000-035	28	















Boltepakker for / Boltpackage for / Bultpaket för

Sign. _____

Rutsjebane 950 40-142-020	Ant= 1	Navn	Artnr/dimensjon	Ant	Lev
		Systembane 950	40-142-020	1	
		Brikke160 3T(5)	04-060-160	2	
		Torx M8x35(4)	04-000-035	4	
		Torx M8x45(2)	04-000-045	2	
		Torzx M8x30(4)	04-000-030	4	
		Fundamentskive(2) 2H 80	00-003-106	2	
		Skive M8(2)	04-050-008	4	
		Mutter M8(2)	04-040-008	6	
	Stålforankering(2)	00-100-310	2		
	Plast plug 9-11 mm (4)	04-090-002	4		
Sperrerør 520	Ant= 2	Navn	Artnr/dimensjon	Ant	Lev
		Sperrerør 520 (1)	00-450-155	2	
		Brikke 120_3T (2)	04-060-120	4	
		Torx M8x25 (4)	04-000-025	8	







Boltepakker for / Boltpackage for / Bultpaket för

Sign. _____

Stigge 950 00-400-615	Ant= 1	Navn	Artnr/dimensjon	Ant	Lev
		Stigge 950	00-400-615 Med 4 trinn	1	
		Brikke 50_1T(2)	04-060-050	2	
		Torx M8x30(6)	04-000-030	6	
		Torx M8x20(2)	04-000-020	2	
		Fundamentskive(2) 2H 80	00-003-106	2	
		Skive M8(2)	04-050-008	4	
		Mutter M8(2)	04-040-008	4	
		Møbelknapp(2) M7_13-17	04-030-011	2	
		Stålforankering(2)	00-100-310	2	
handtak	Ant= 2	Navn	Artnr/dimensjon	Ant	Lev
		handtak (1)	00-400-170	2	
		Brikke 120-3T	04-060-120	2	
		Torx M8x30 (2)	04-000-030	4	
		Propp 11mm(1)	04-090-002	2	





Boltepakker for / Boltpackage for / Bultpaket för

Sign. _____.

Tak borg 01-450-502	Ant= 2	Navn	Artnr/dimensjon	Ant	Lev
		Tak 2230x400x12 (4)	01-450-502	8	
		Brikke 50_1T (8)	04-060-050	16	
		Torx M8x25(8) Torx M8x35(8)	04-000-025 04-000-035	16 16	
		Vinkel 50x50x50x4 (4)	04-075-050	8	
		Låsemutter M8(8)	04-040-008	16	

Boltepakker for / Boltpackage for / Bultpaket för

Sign. _____.

Fundament	Ant= 8	Navn	Artnr/dimensjon	Ant	Lev
		Fundament plate(1)	00-003-010	8	
		Fundamentdel1 (1) 4x med VK70 hull 1x med VK95 hull	00-003-010	8	
		Fundament del2 (1) 4x med VK70 hull 1x med VK95 hull	00-003-010	8	
		Torx M8x35(3)	04-000-035	24	
		Brikke 120 3T (1) Brikke 501T(1)	04-060-120 04-060-120	8 8	

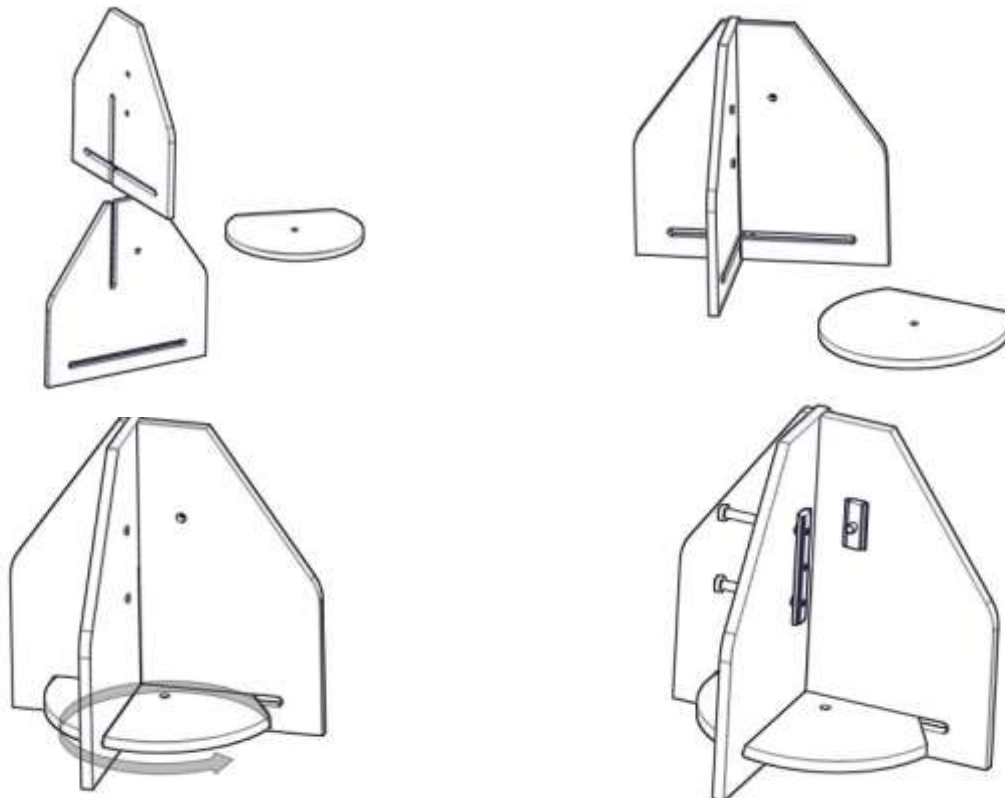

Fundamentering med betong / Foundation concrete / Förankring med betong

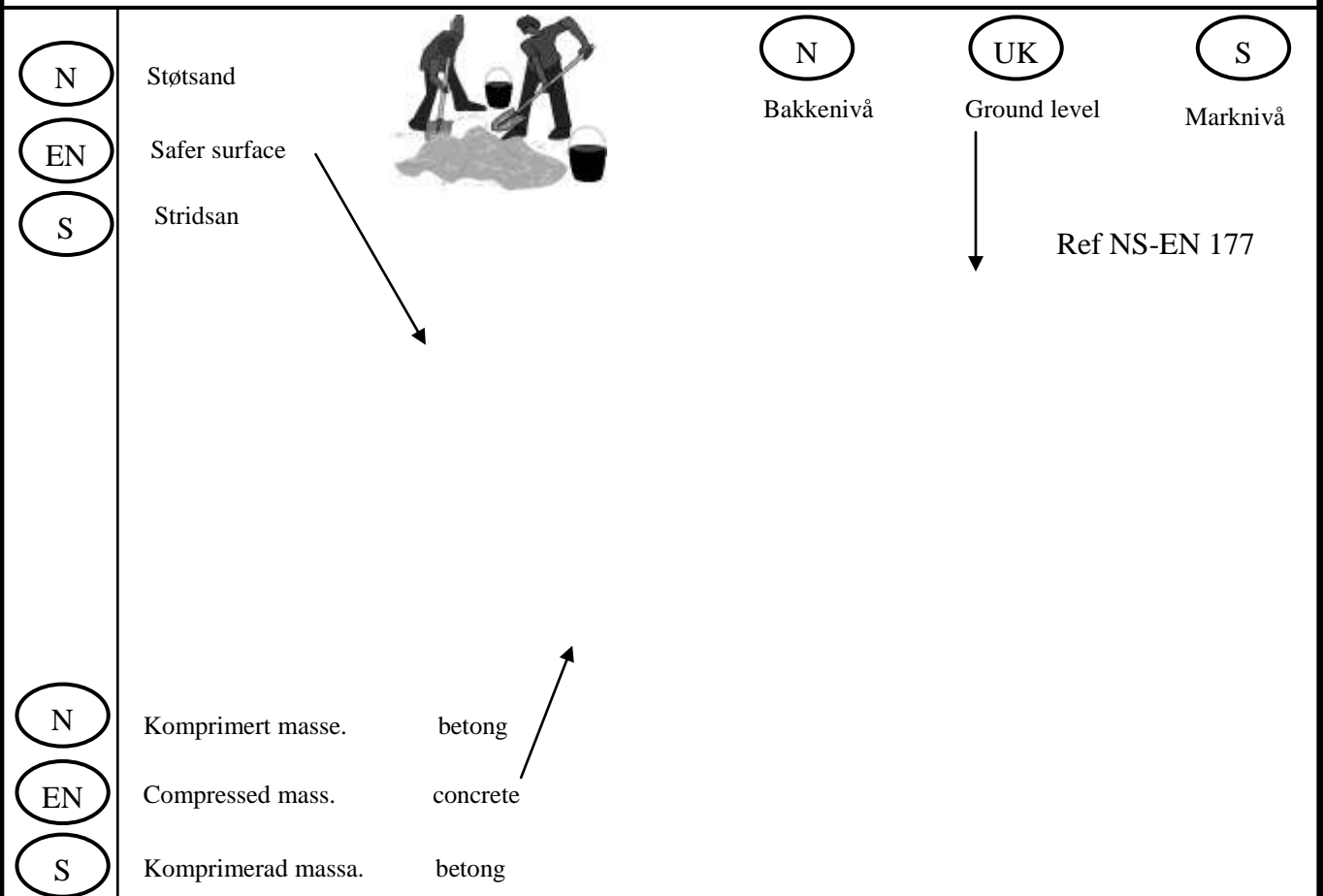

Fundamentering uten betong / Foundation without concrete / Förankring utan betong

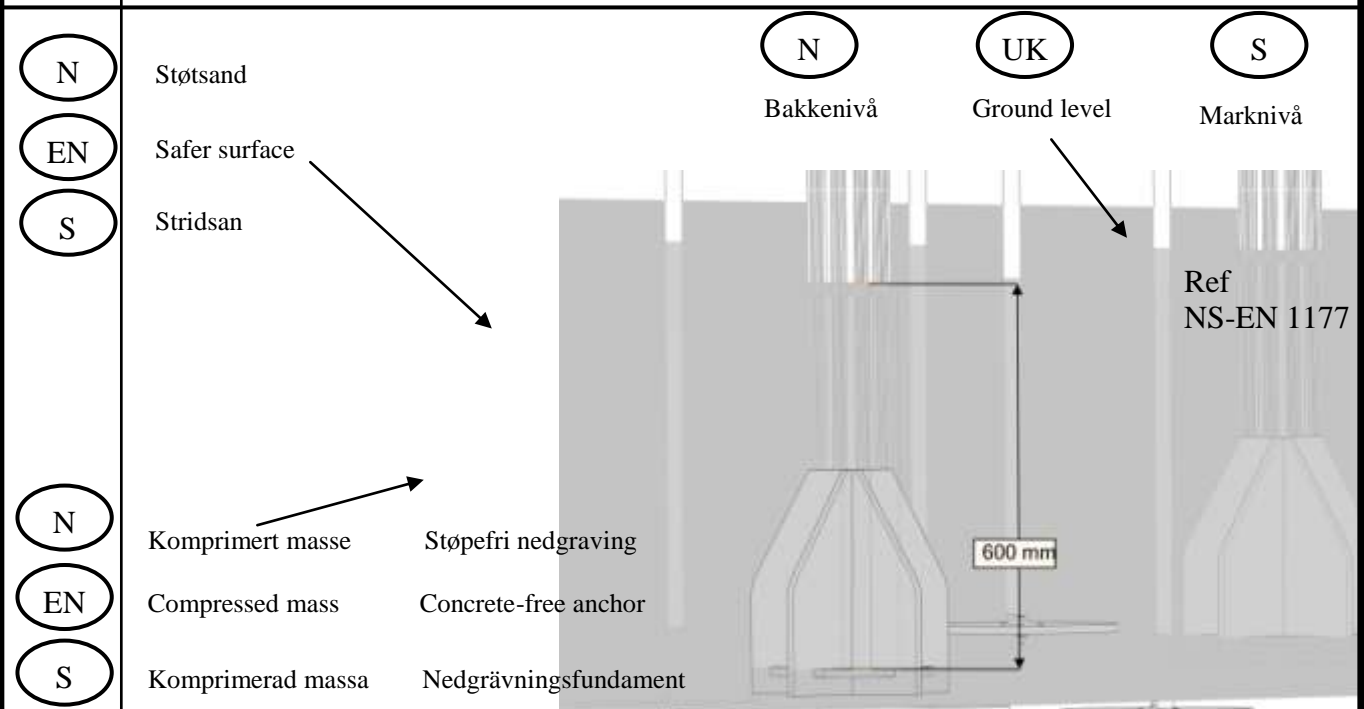

(N) Alle mål er oppgitt i millimeter
 (EN) Scale measured in mm
 (S) Alla mått är i millimeter.

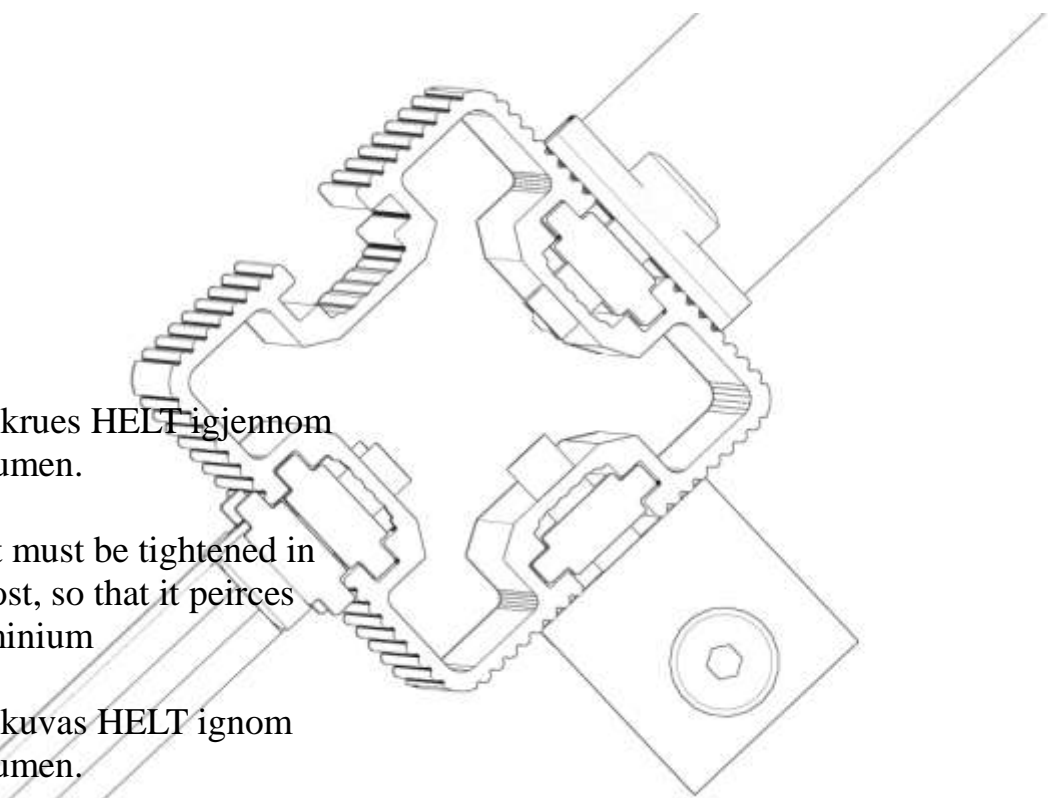
<p data-bbox="119 1556 215 1624">N</p> <p data-bbox="119 1691 215 1758">EN</p> <p data-bbox="119 1848 215 1915">S</p>	 <p data-bbox="239 1579 702 1668">Bolten skrues HELT igjennom aluminiumen.</p> <p data-bbox="239 1713 686 1836">The bolt must be tightened in to the post, so that it peirces the aluminium</p> <p data-bbox="239 1881 662 1971">Bulten skruvas HELT ignom aluminiumen.</p>

Fallhøyder / Free height of fall / Fallhöjder

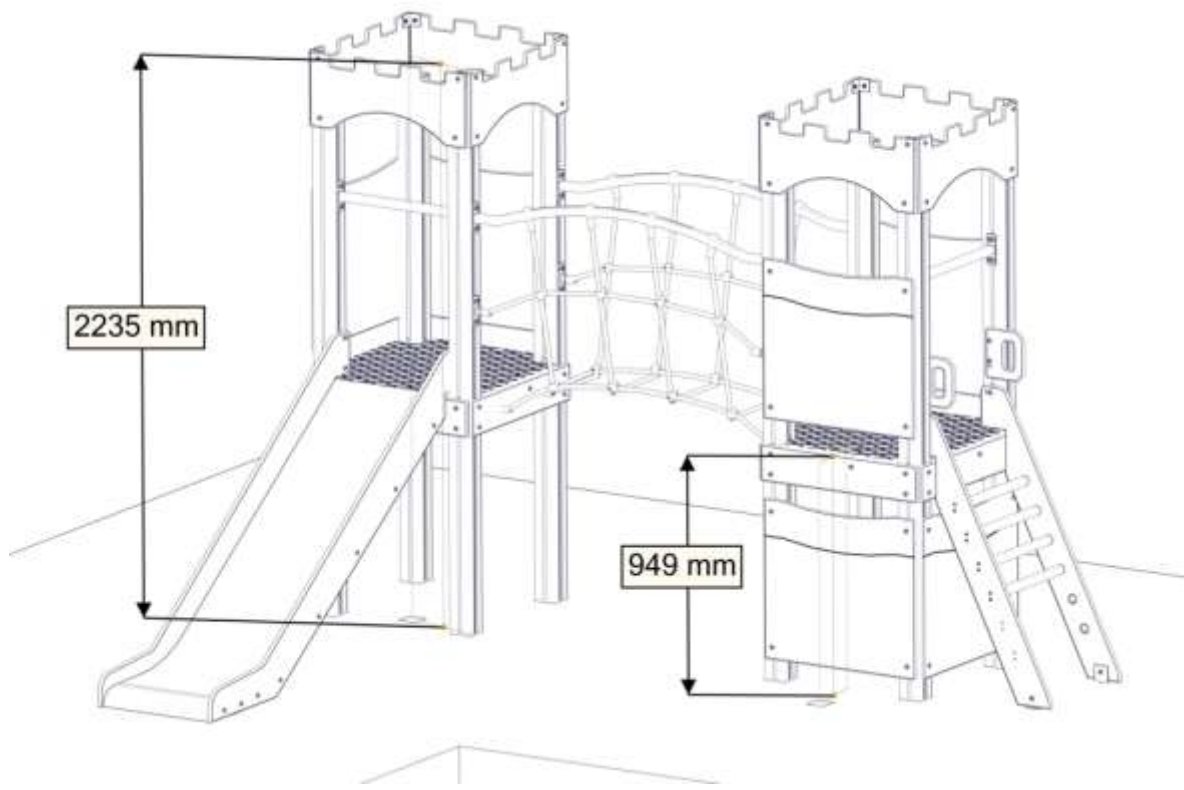

Sikkerhetszone / Safety zone / Säkerhetszon

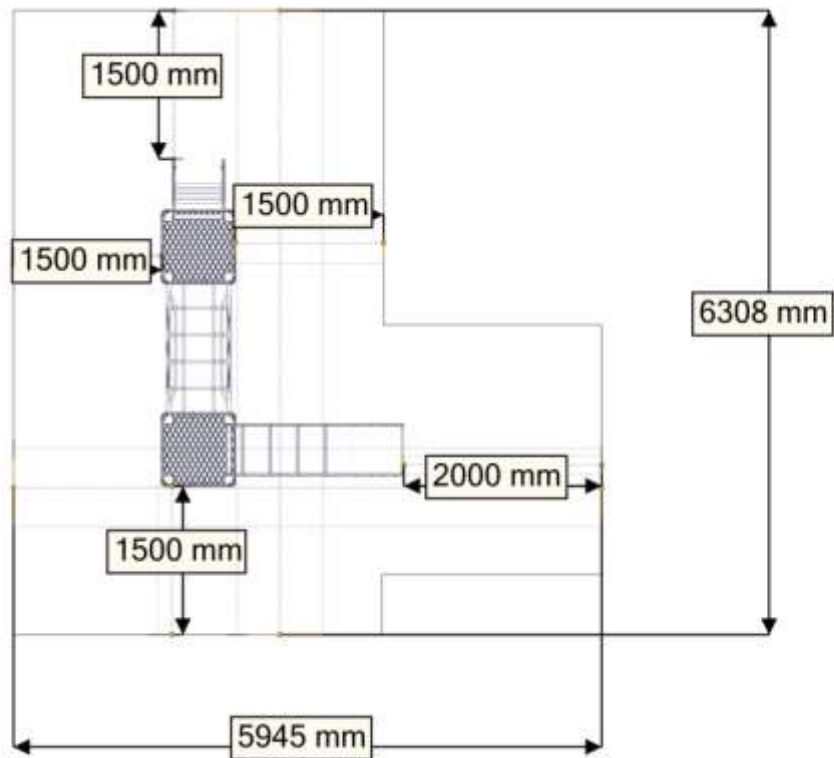

Plassering av forankringer / Ground plan / Placering av förankringar

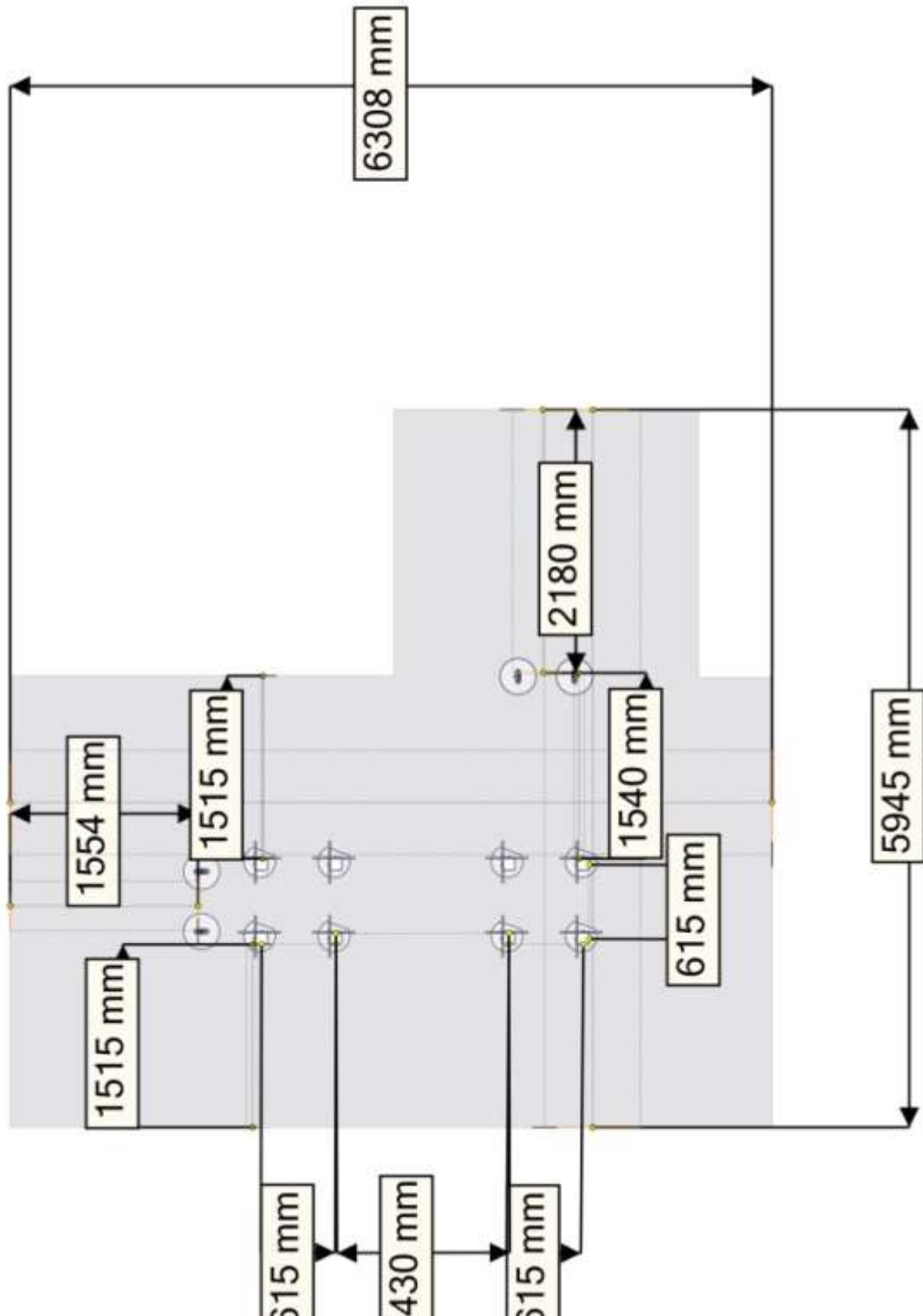

N

Alle mål er oppgitt i millimeter

EN

Scale measured in mm

S

Alla mått är i millimeter.

Montering av lekeapparatet / Assembly instructions / Montering av lekredskapet

2600 mm

1461 mm

nr	PartName	Artnr	Antall
1	Stope95x95 600-2000	00-400-018	4
2	Sprosse gulv 710x145x15	01-400-108	3
3	Sprosse 2 hull bro	01-400-109	1
4	Torx M8x35	04-000-035	16

89 mm

Montering av lekeapparatet / Assembly instructions / Montering av lekredskapet

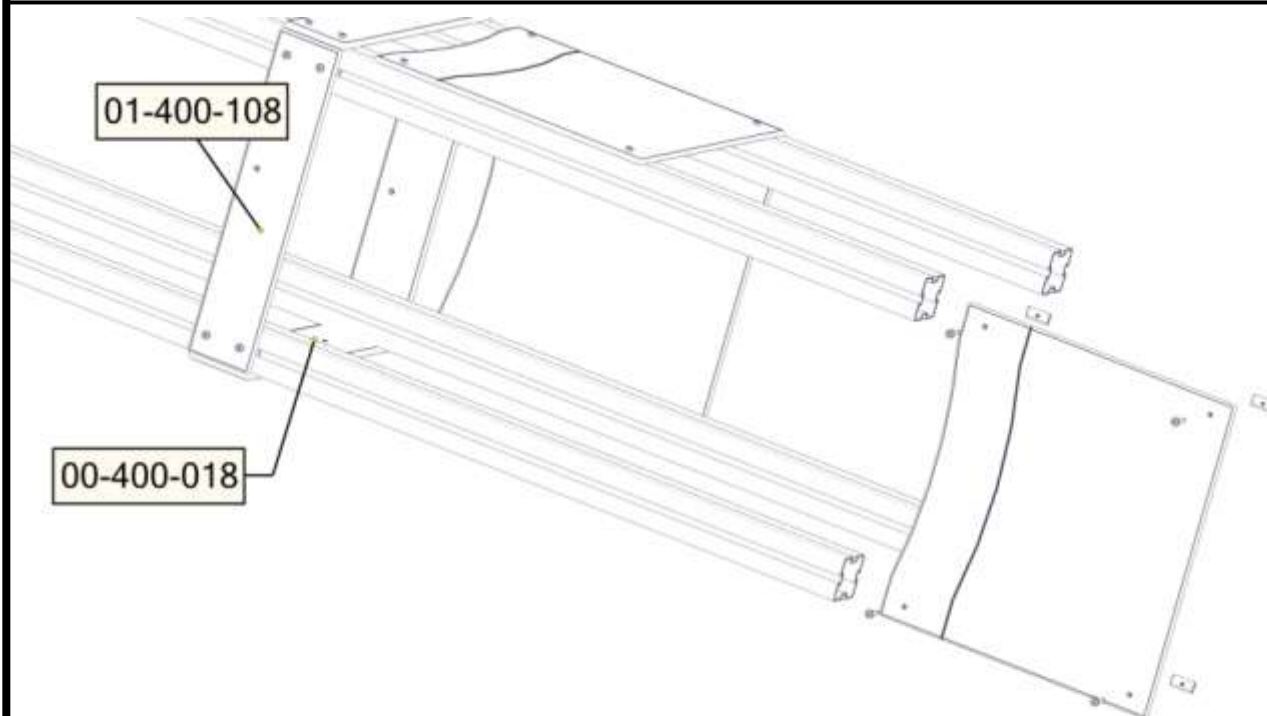

nr	PartName	Artnr	Antall
1	vegg_688x638	01-125-010	3
2	Torx M8x35	04-000-035	12
3	Brikke50 1XM8	04-060-050	12

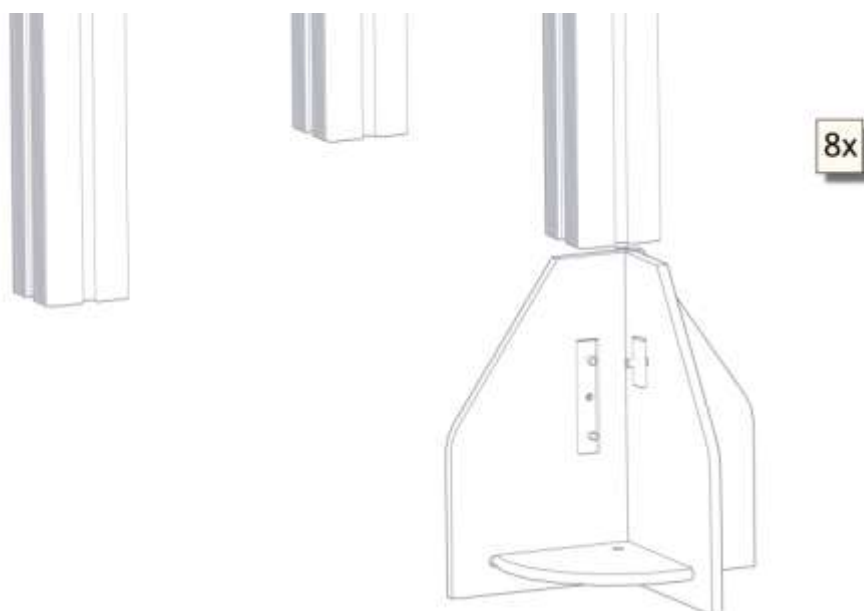

nr	PartName	Artnr	Antall
1	Fundament spor ned	00-003-100	1
2	Fundament spor opp	00-003-101	1
3	Fundament skive	00-003-102	1
4	Torx M8x35	04-000-035	3

nr	PartName	Artnr	Antall
5	Skive M8 stor	04-055-008	3
6	Brikke50 1XM8	04-060-050	1
7	Brikke 120 3xM8	04-060-120	1

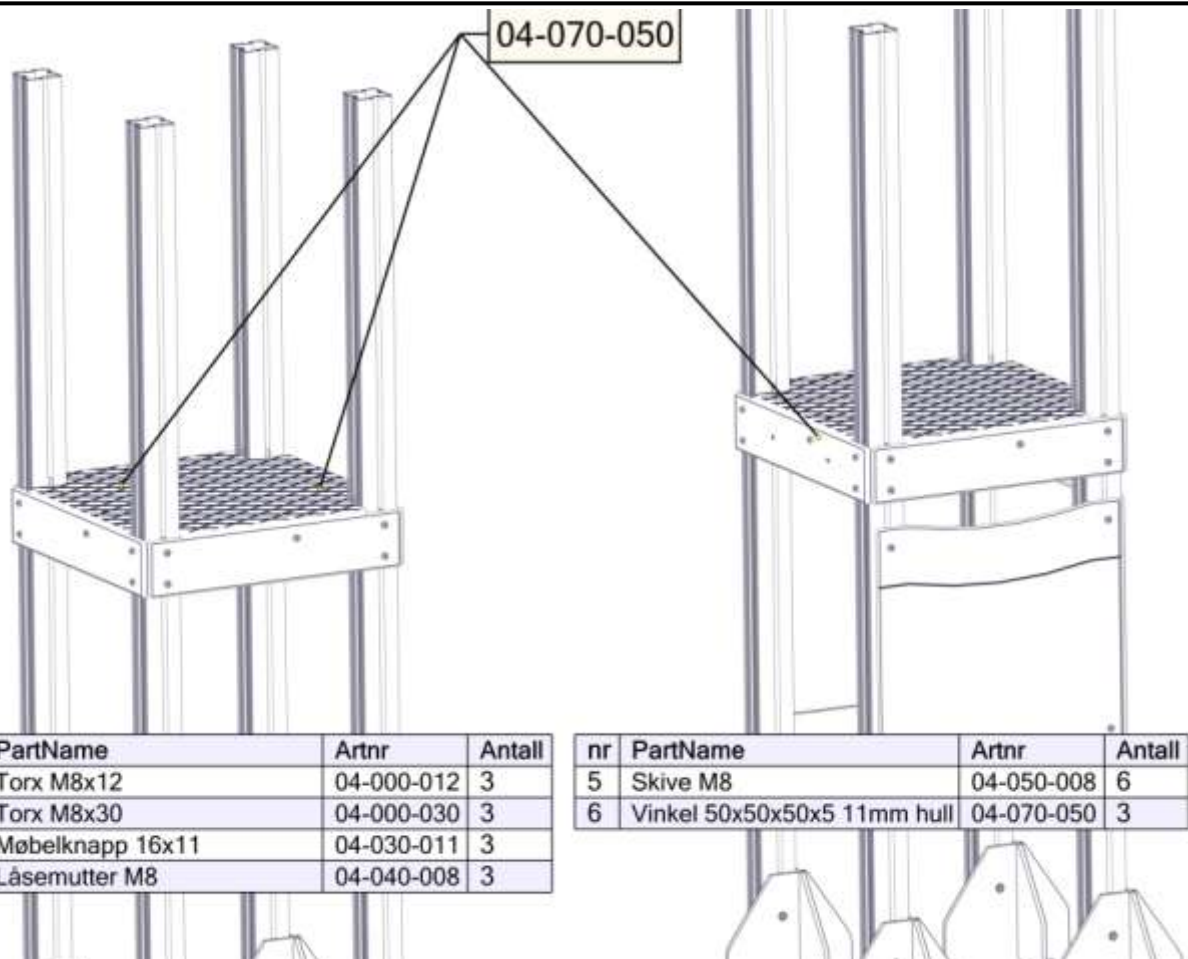
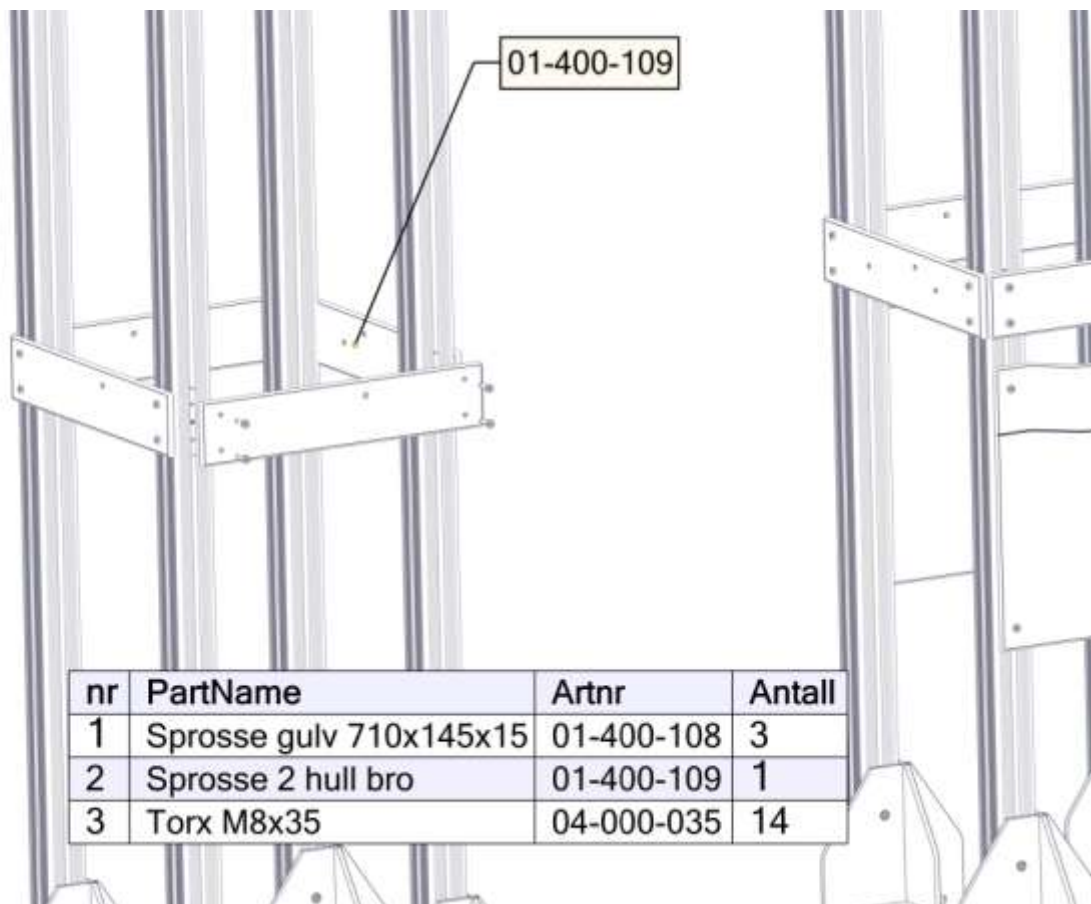

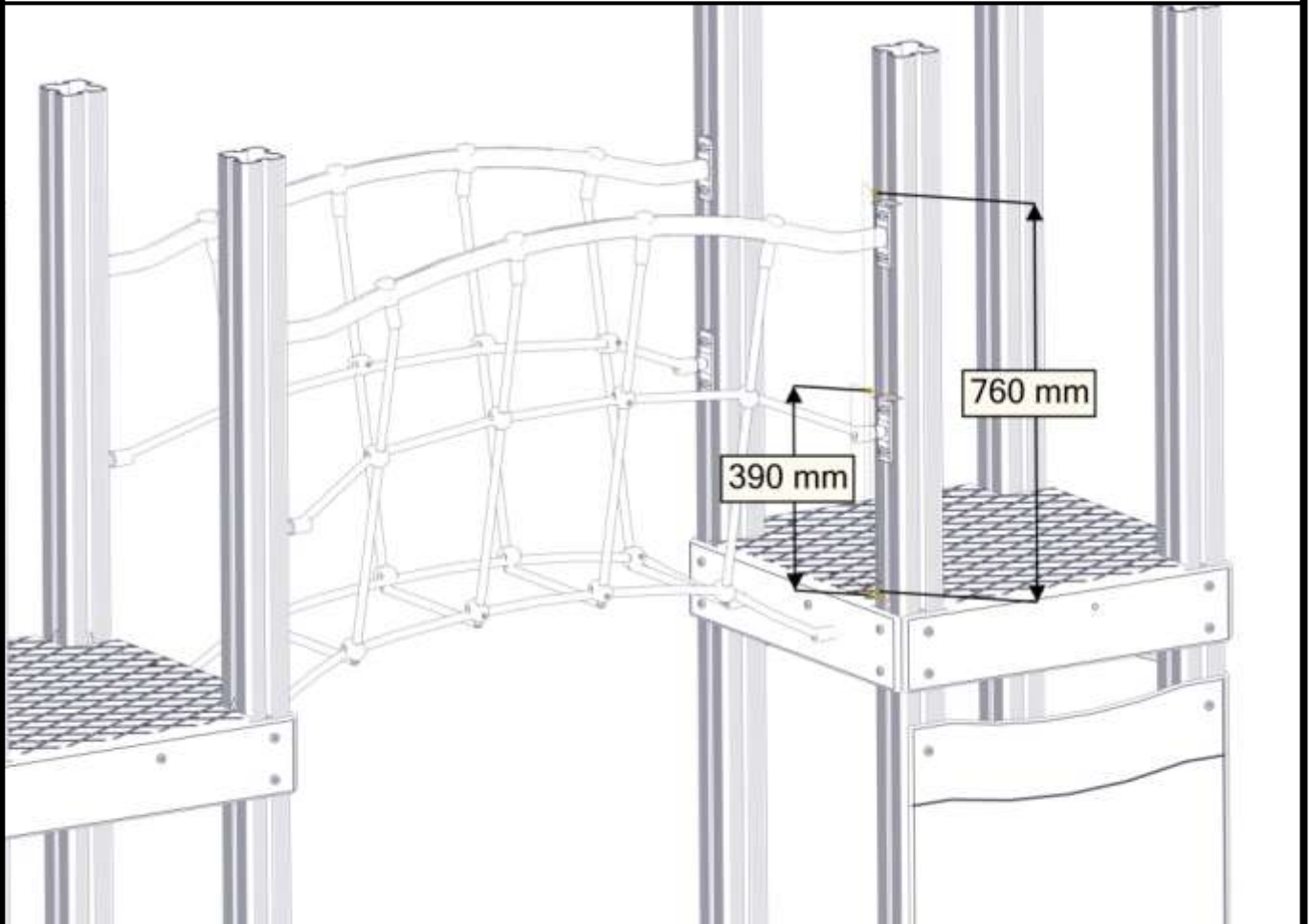
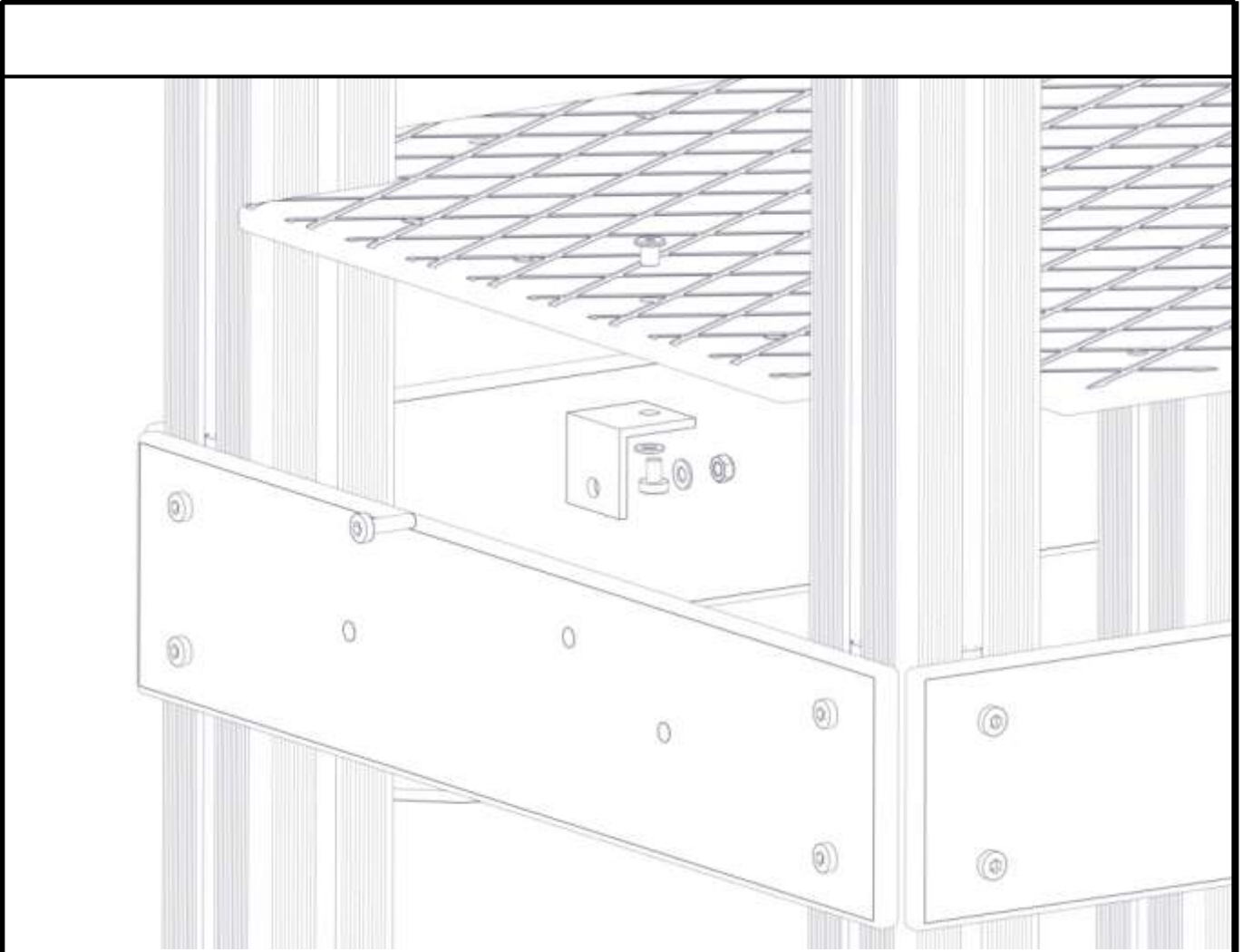

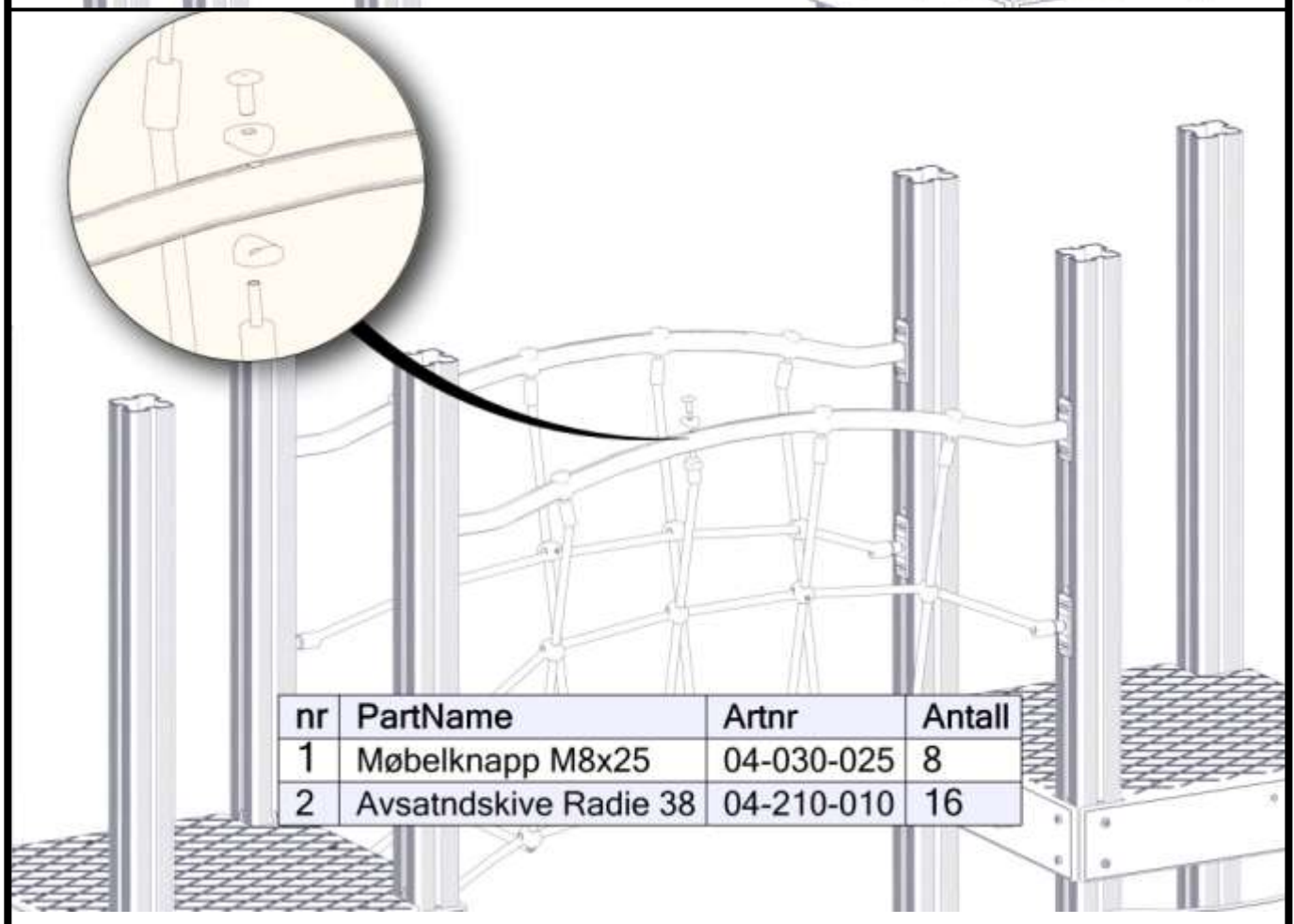
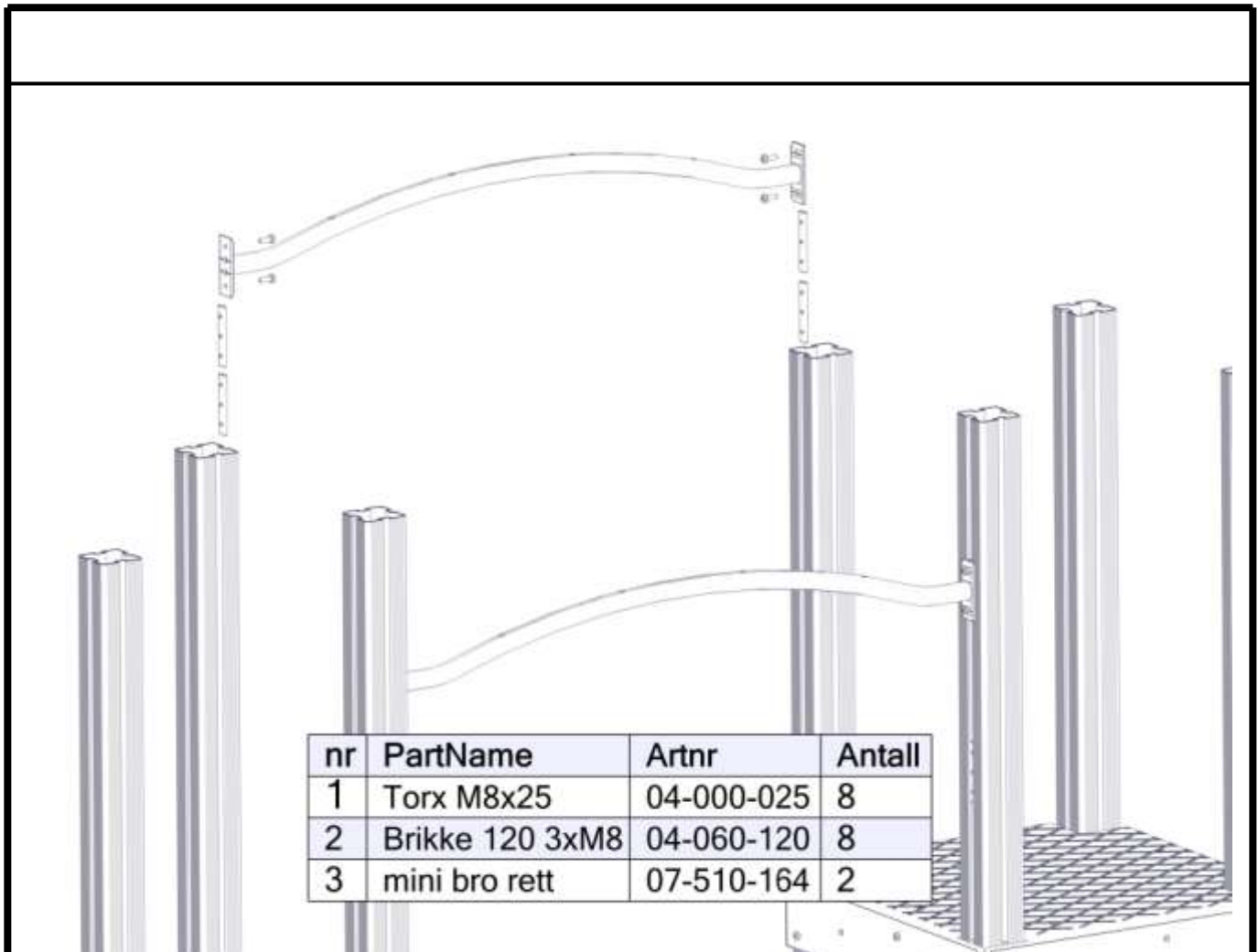

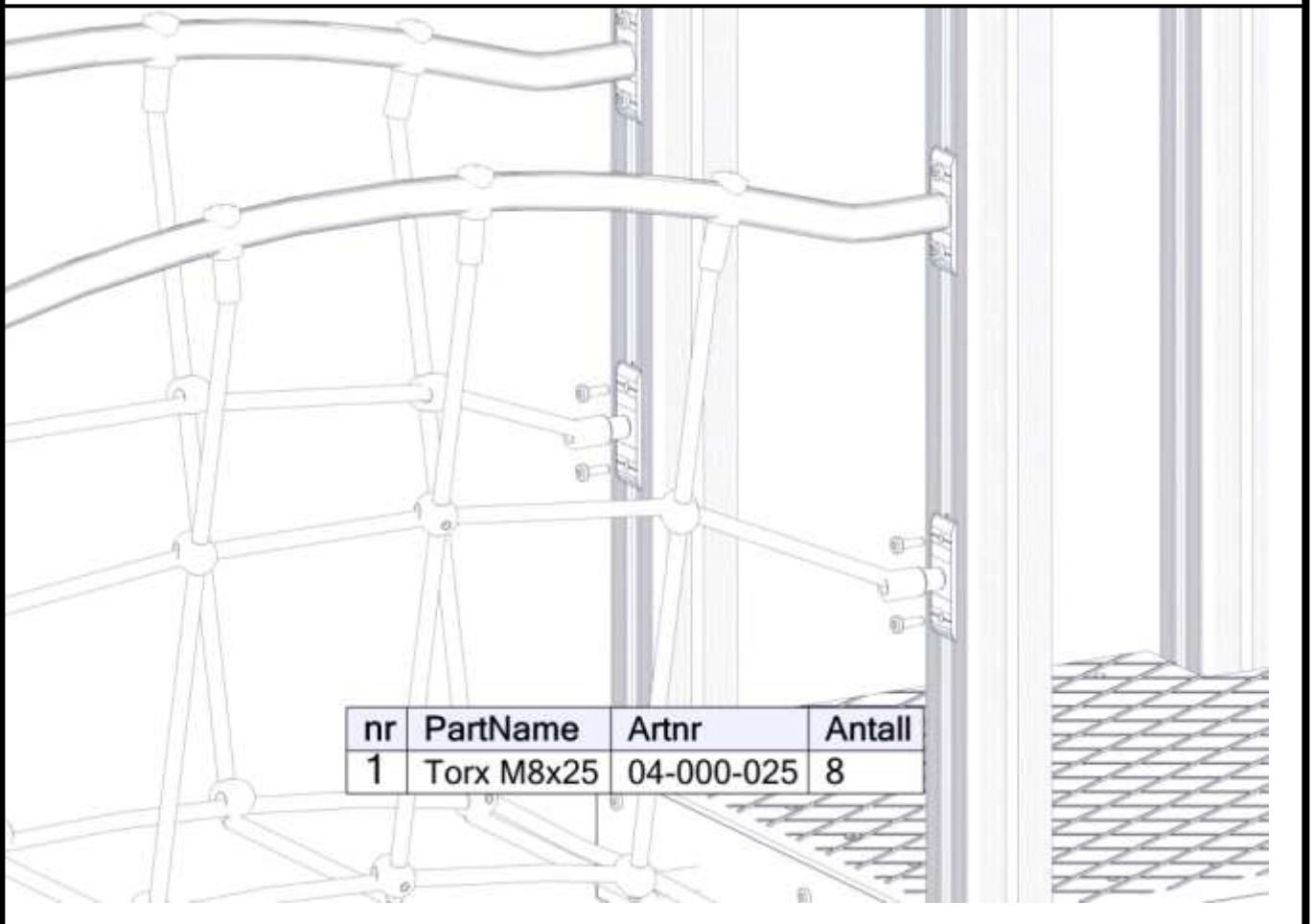
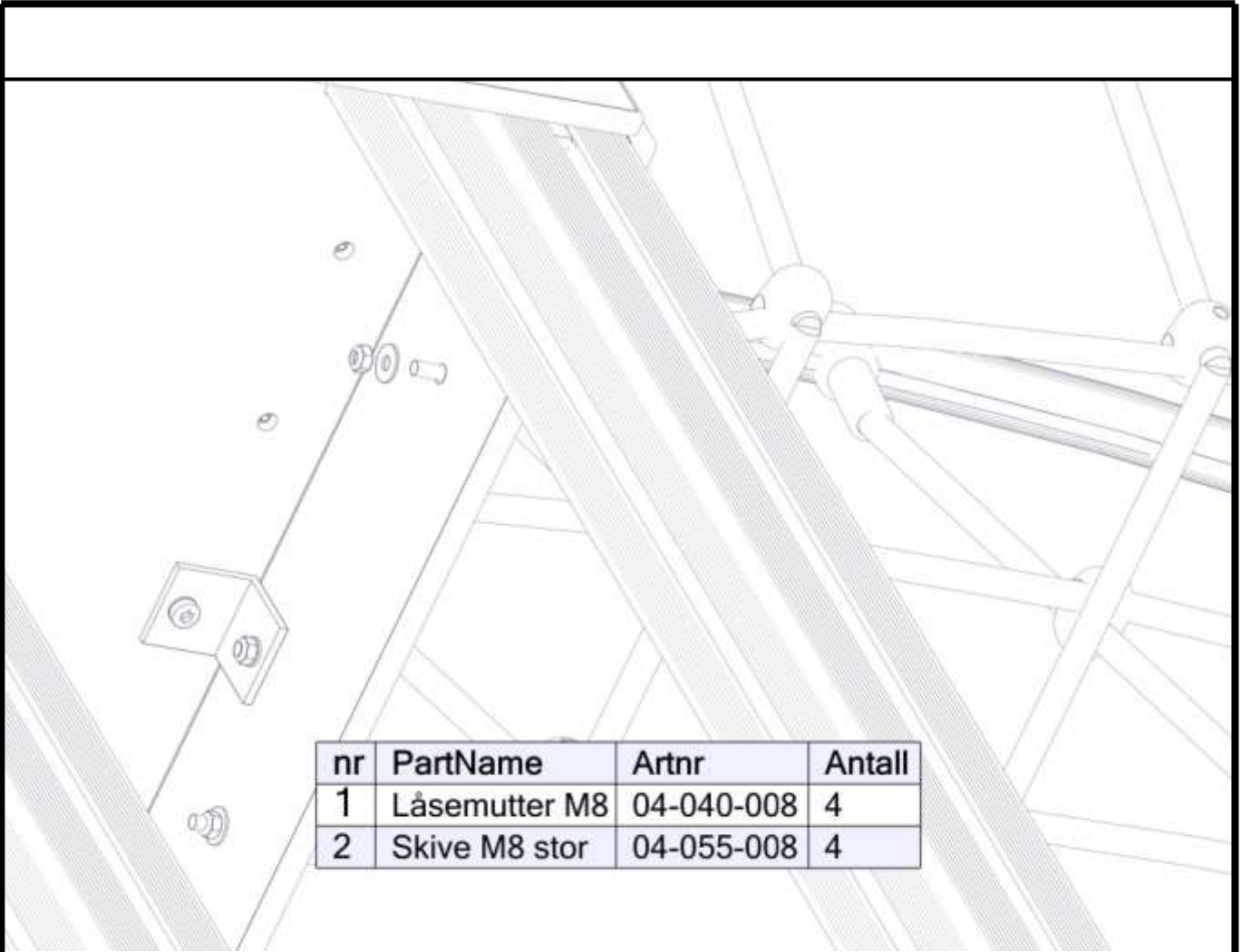

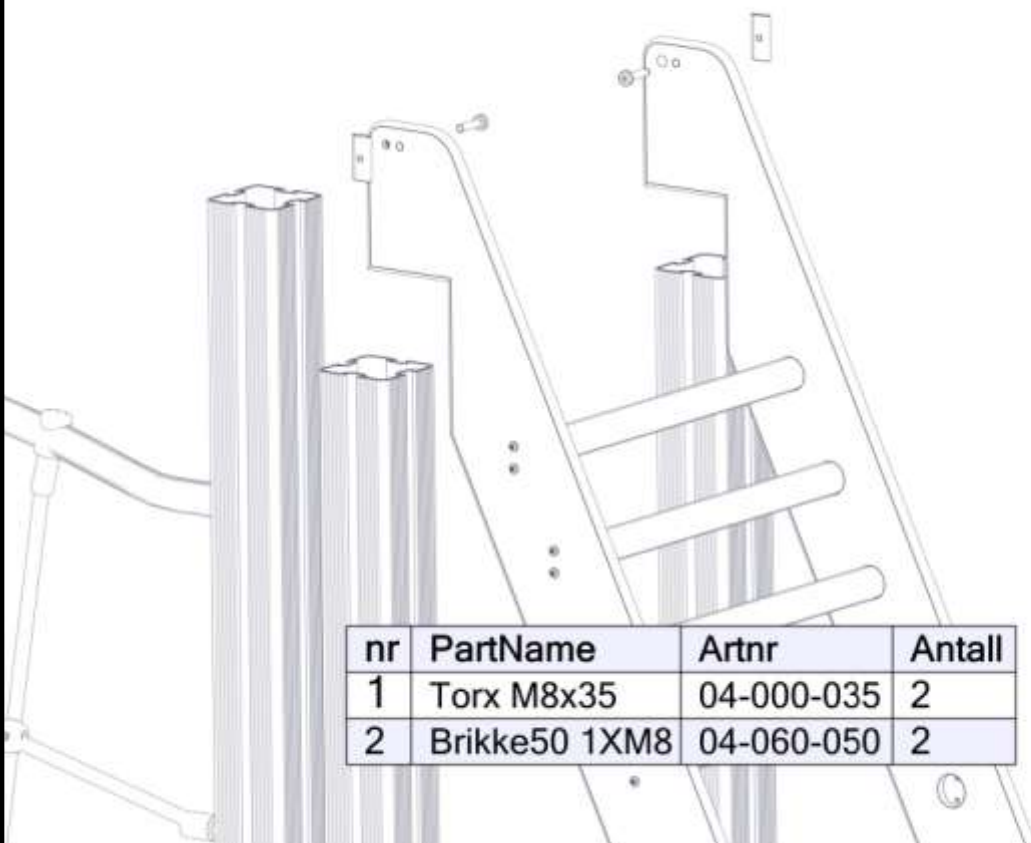
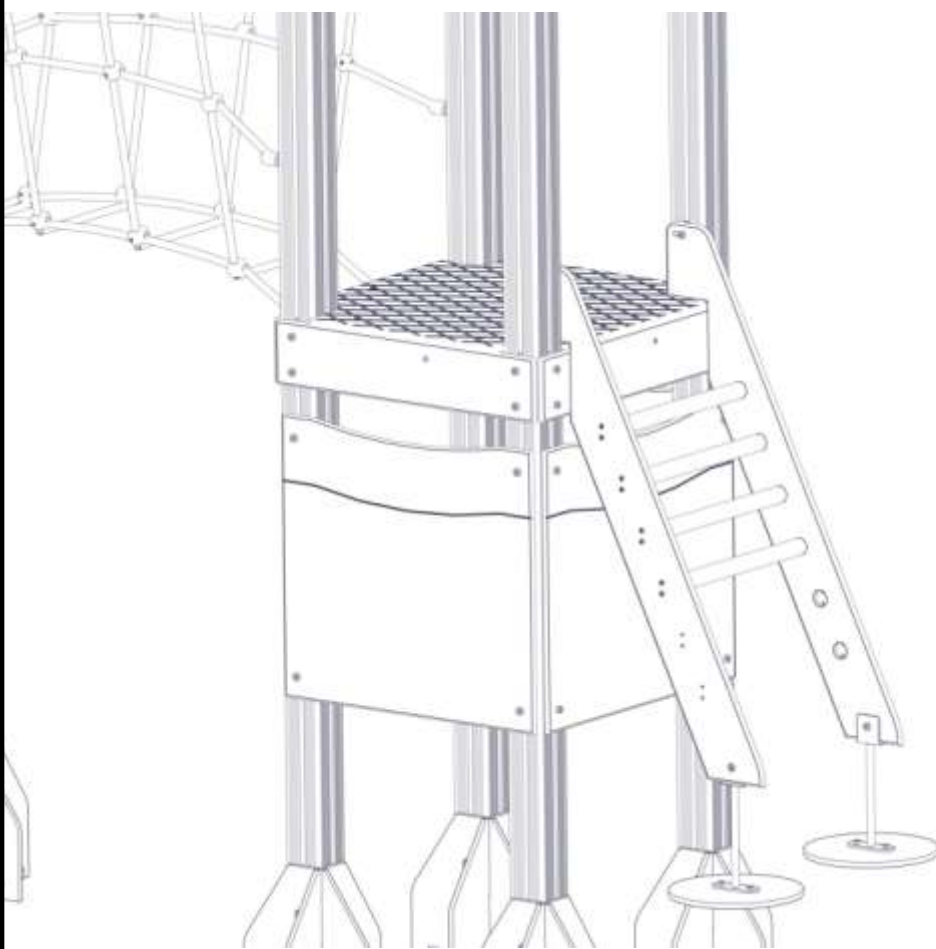



nr	PartName	Artnr	Antall
1	Fundament plate	00-003-106	2
2	Stålforankring 300	00-100-312	2
3	Torx M8x16	04-000-016	2
4	Torx M8x35	04-000-035	4

nr	PartName	Artnr	Antall
5	Møbelknapp 16x11	04-030-011	2
6	Låsemutter M8	04-040-008	4
7	Skive M8	04-050-008	4

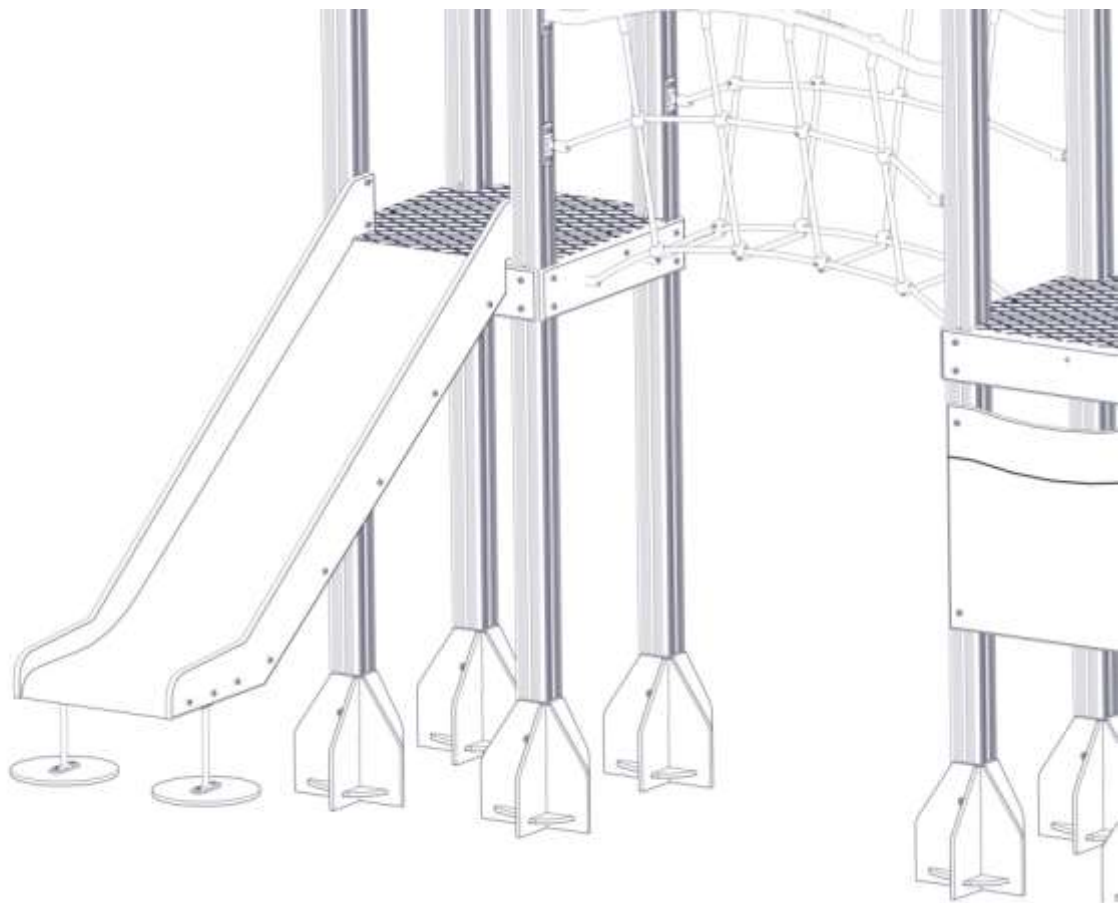

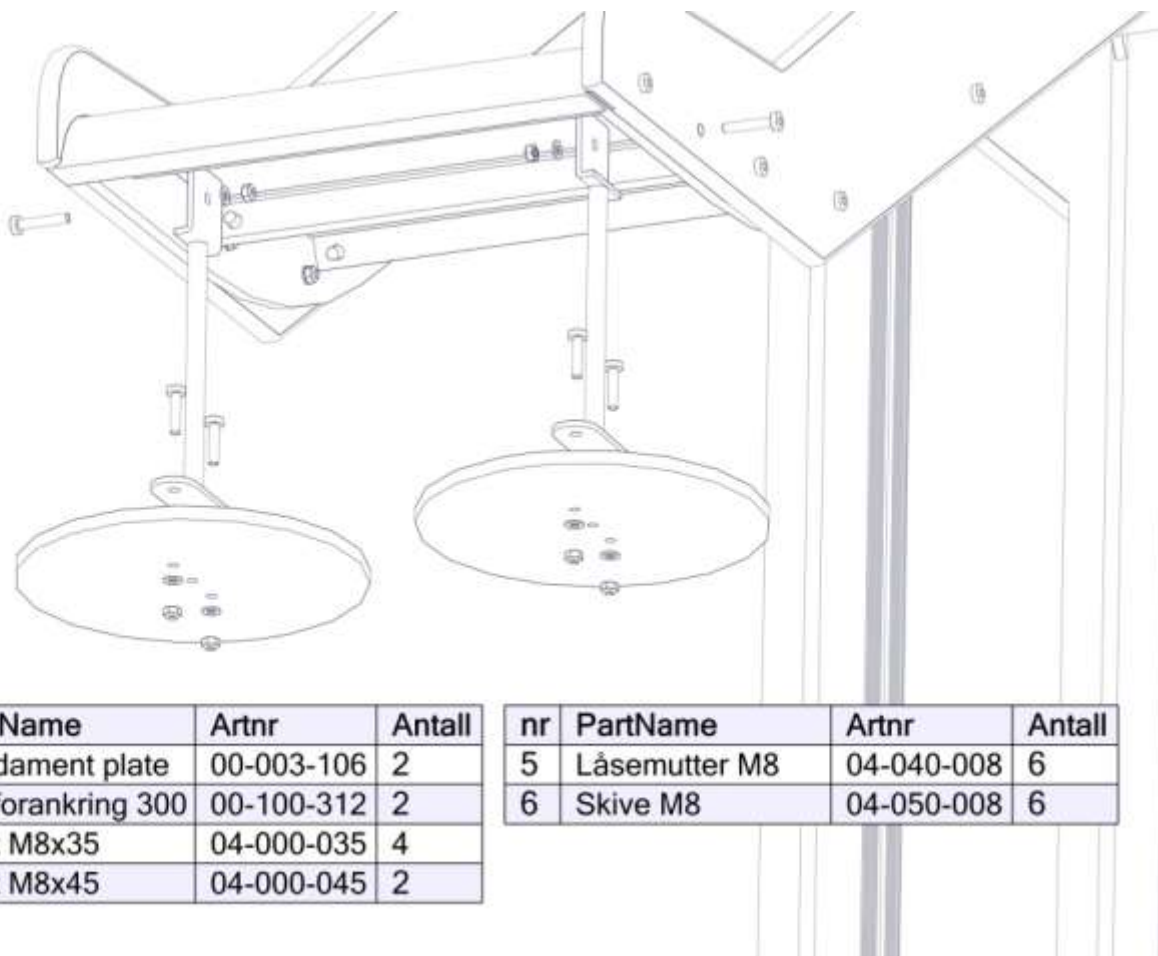
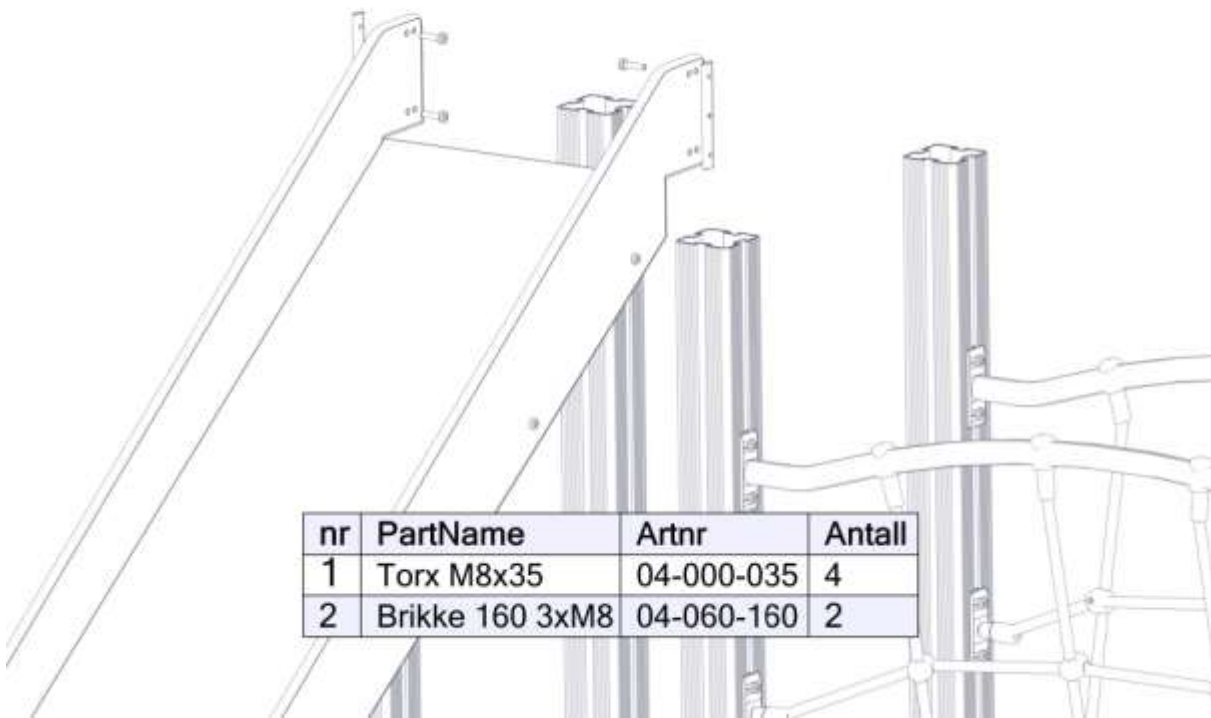

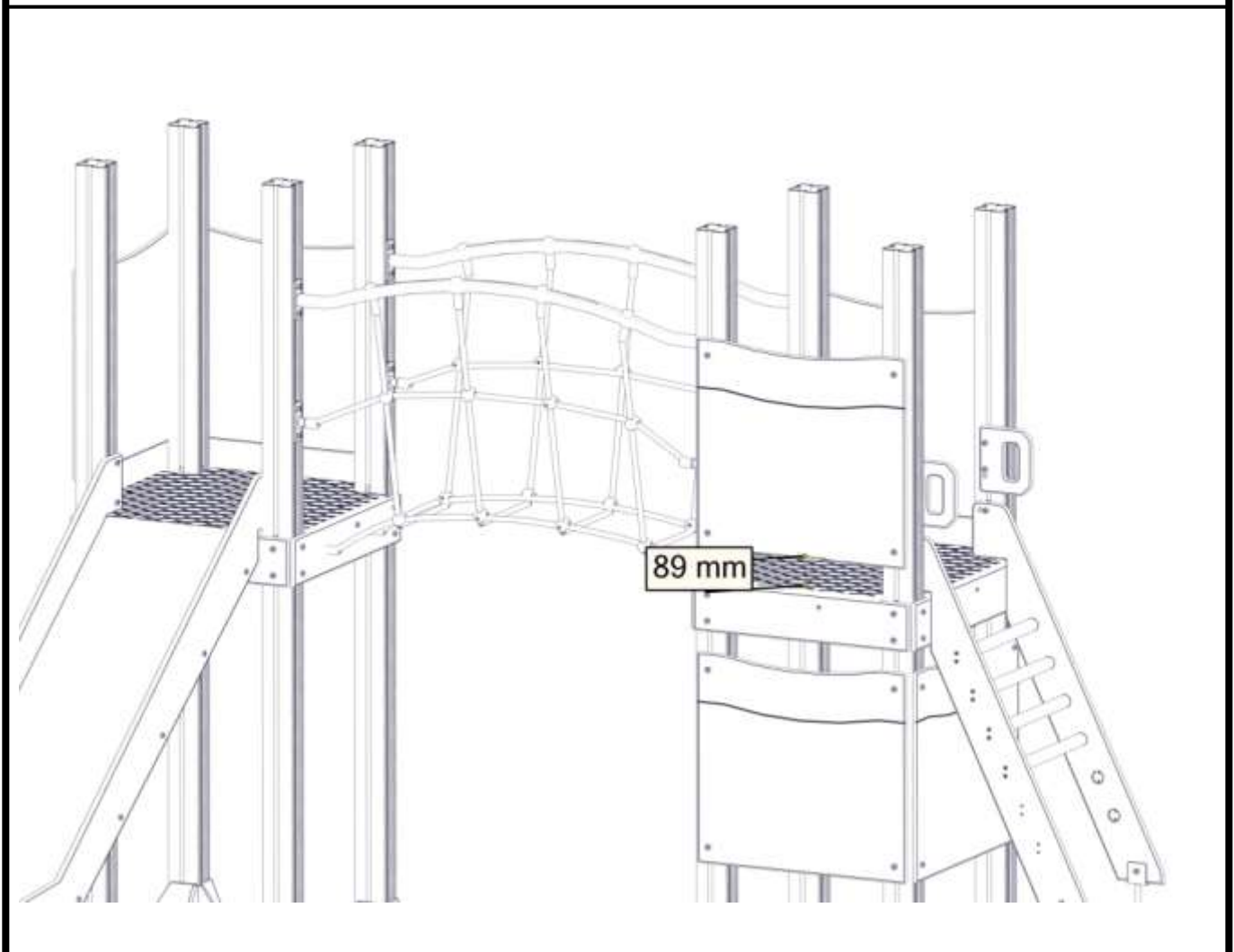
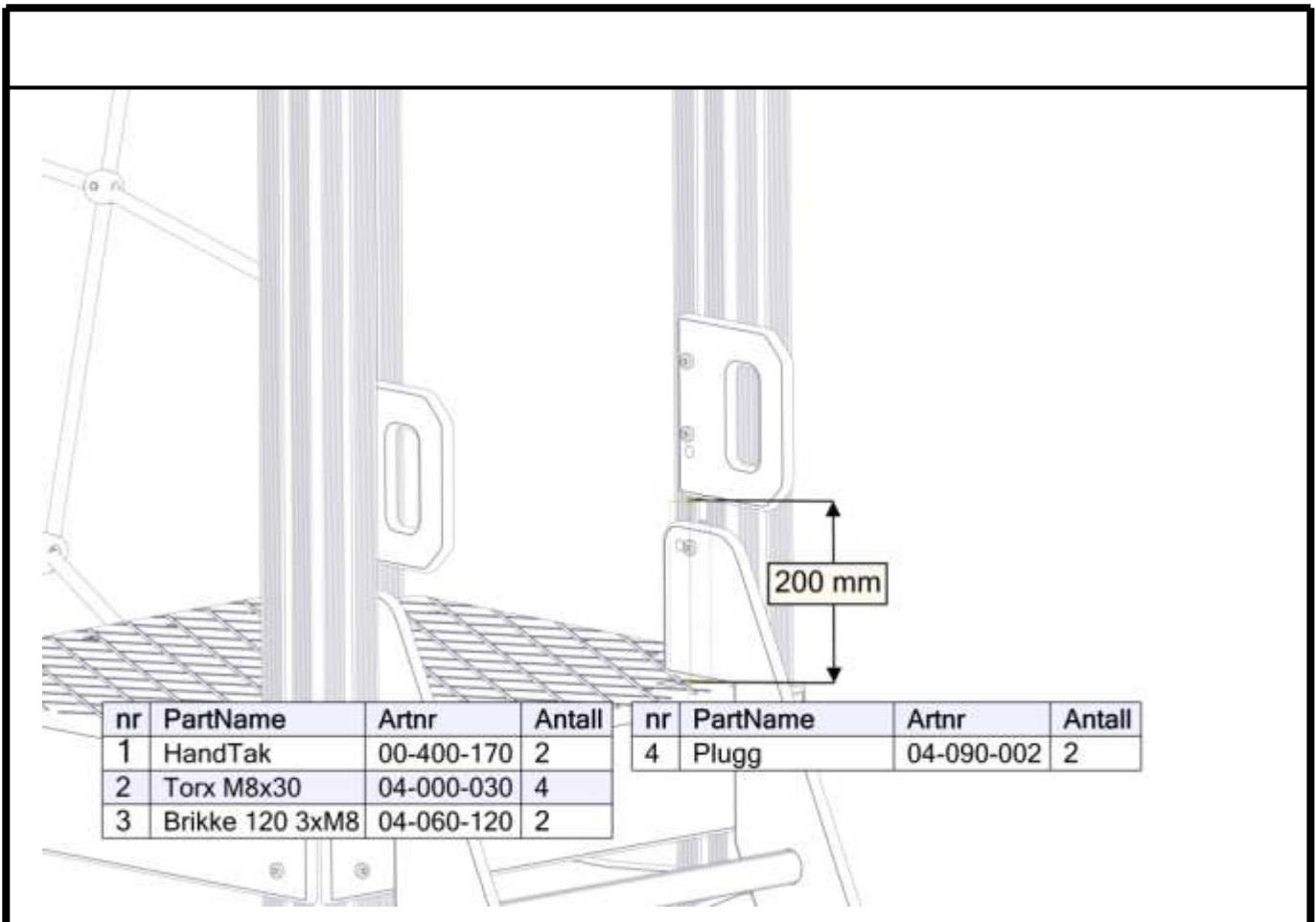

4x

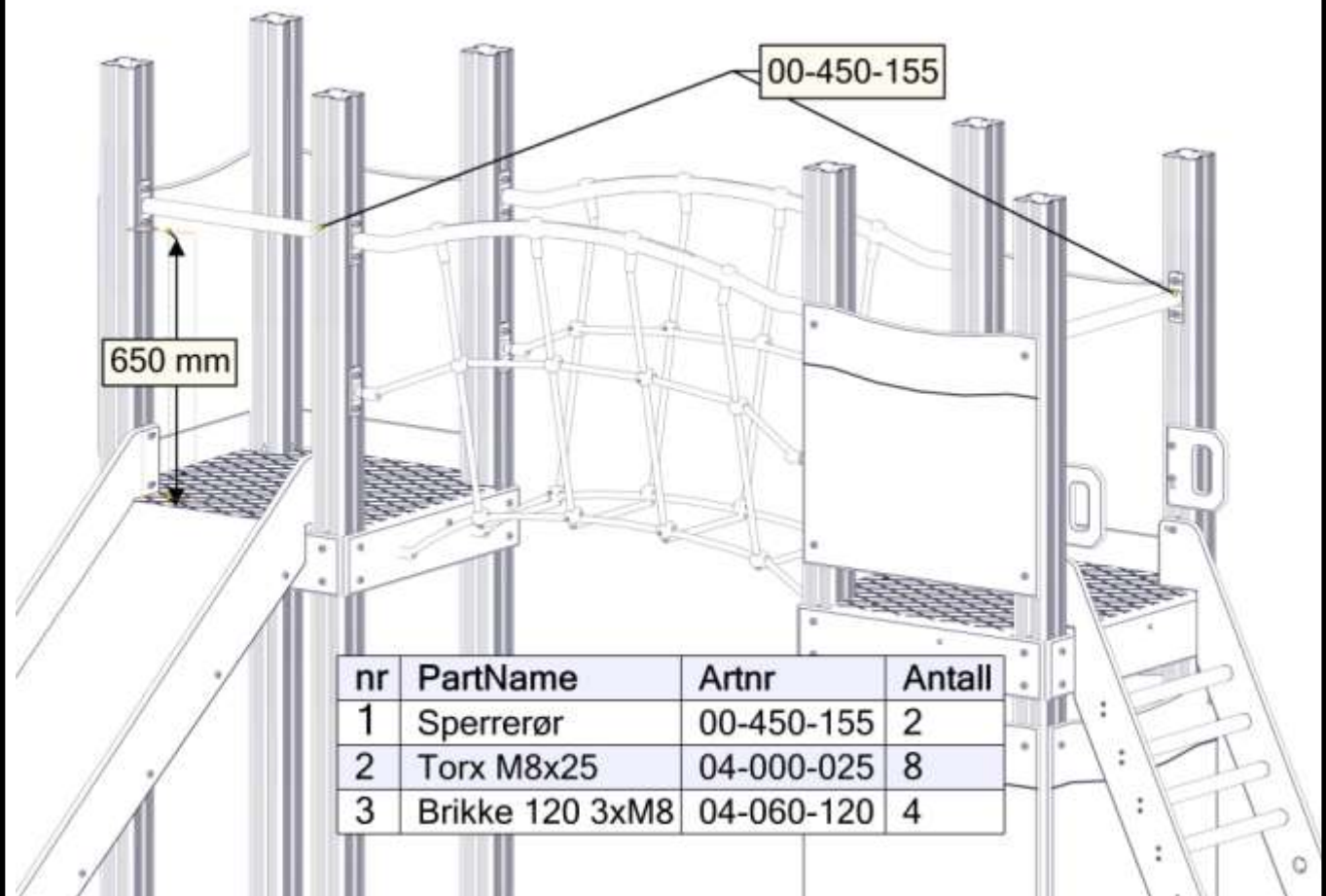
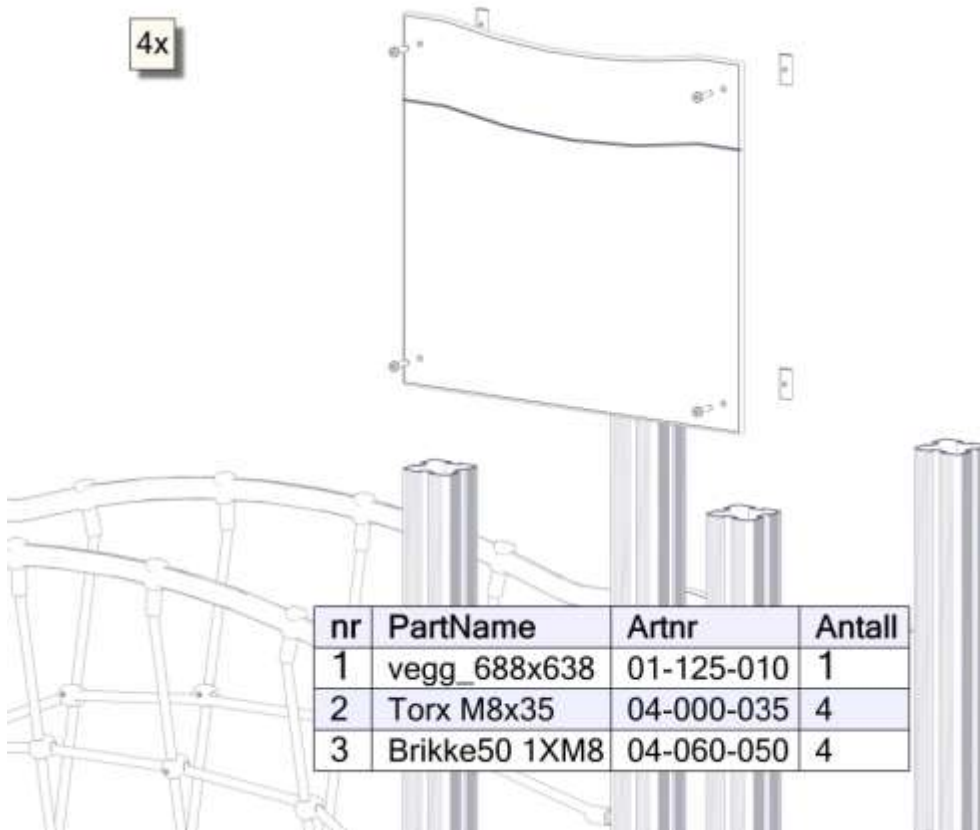

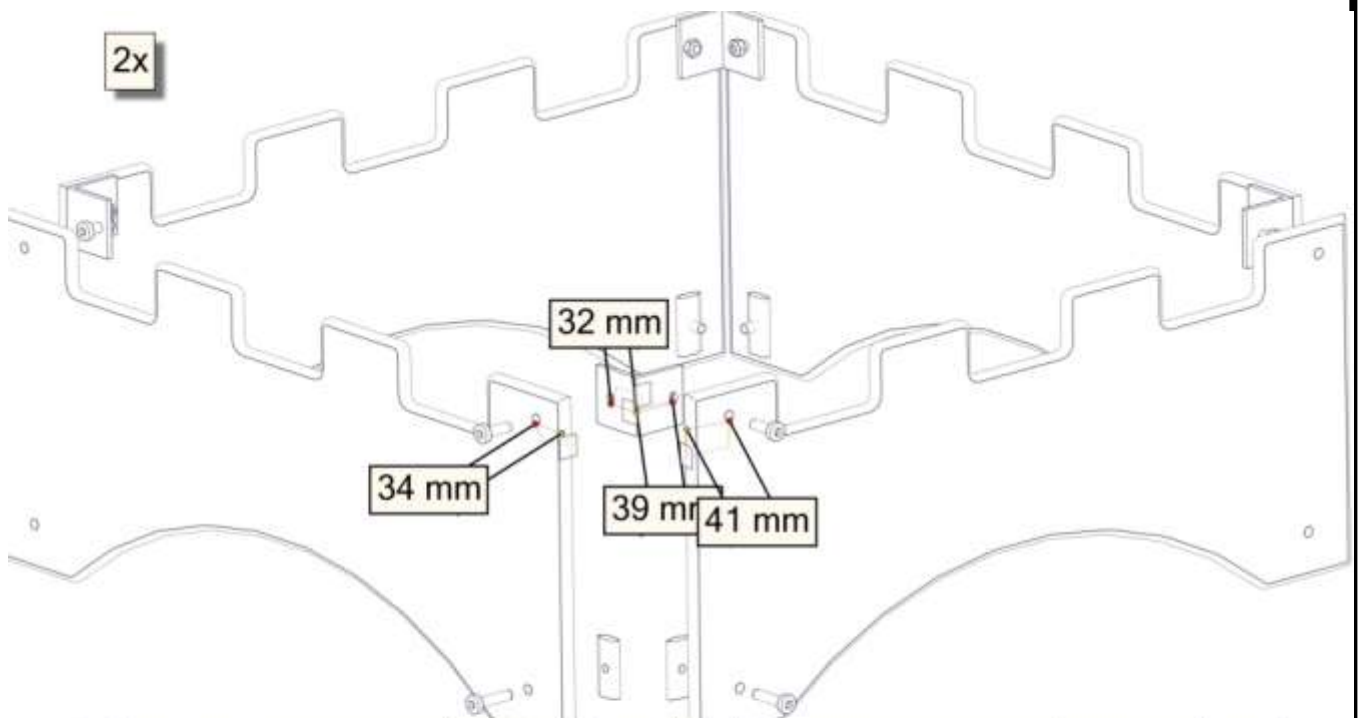
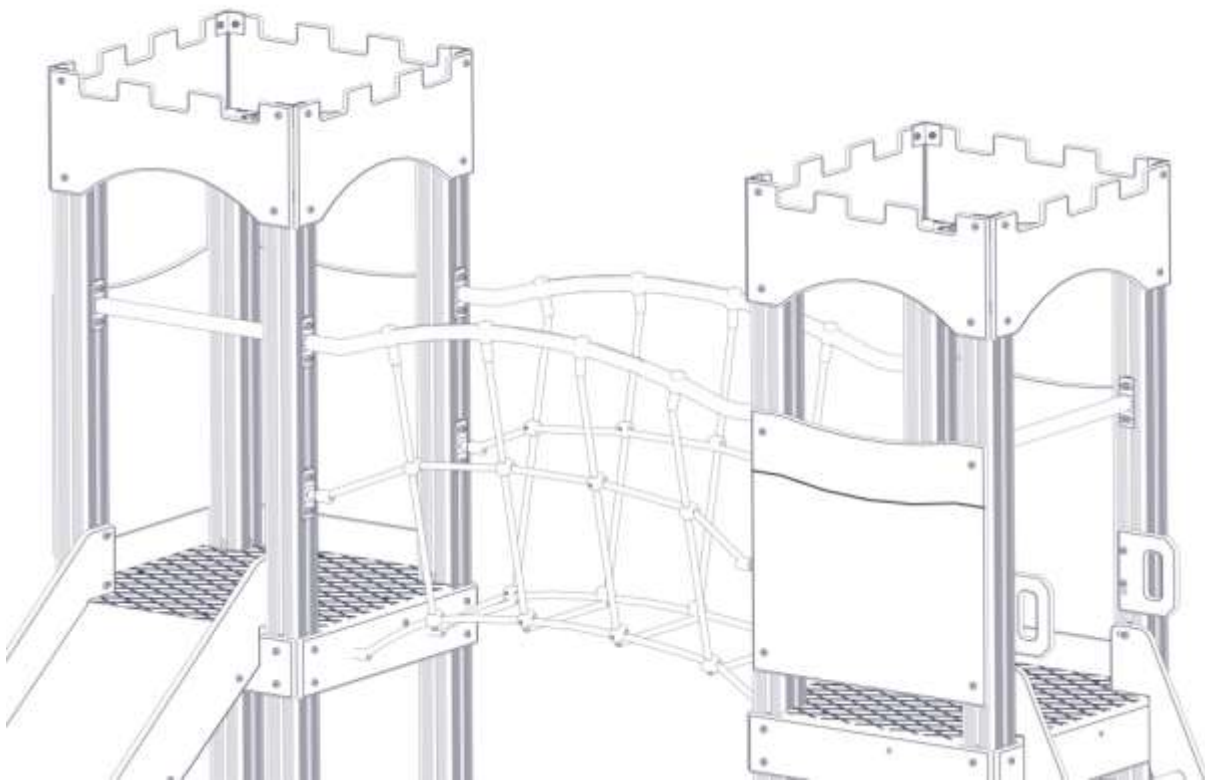





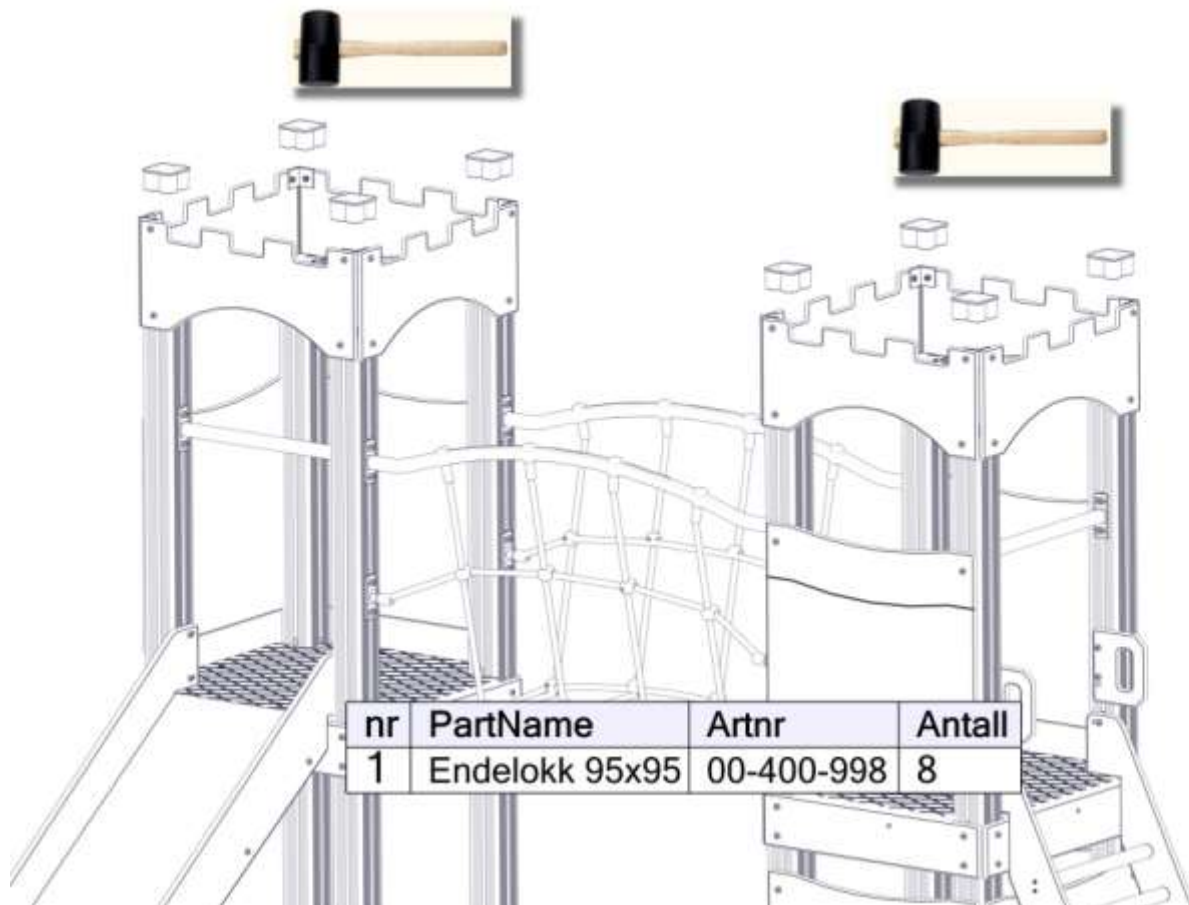
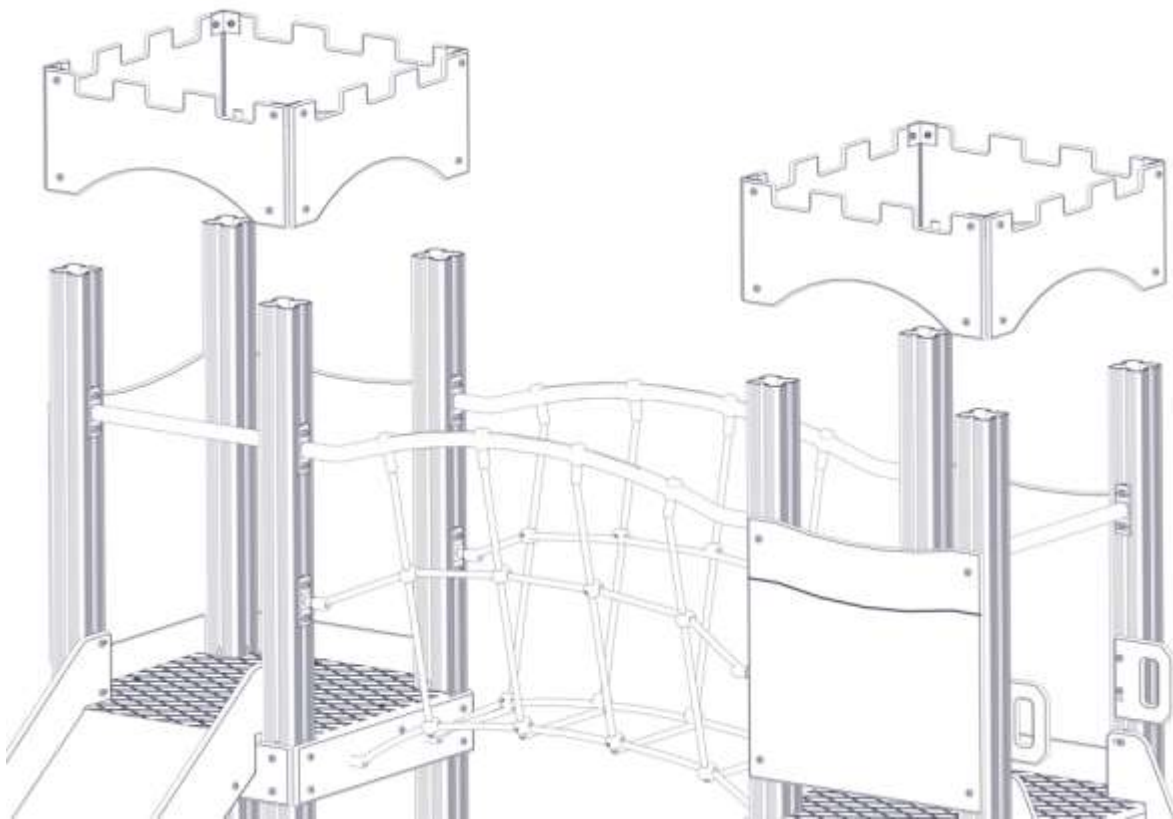

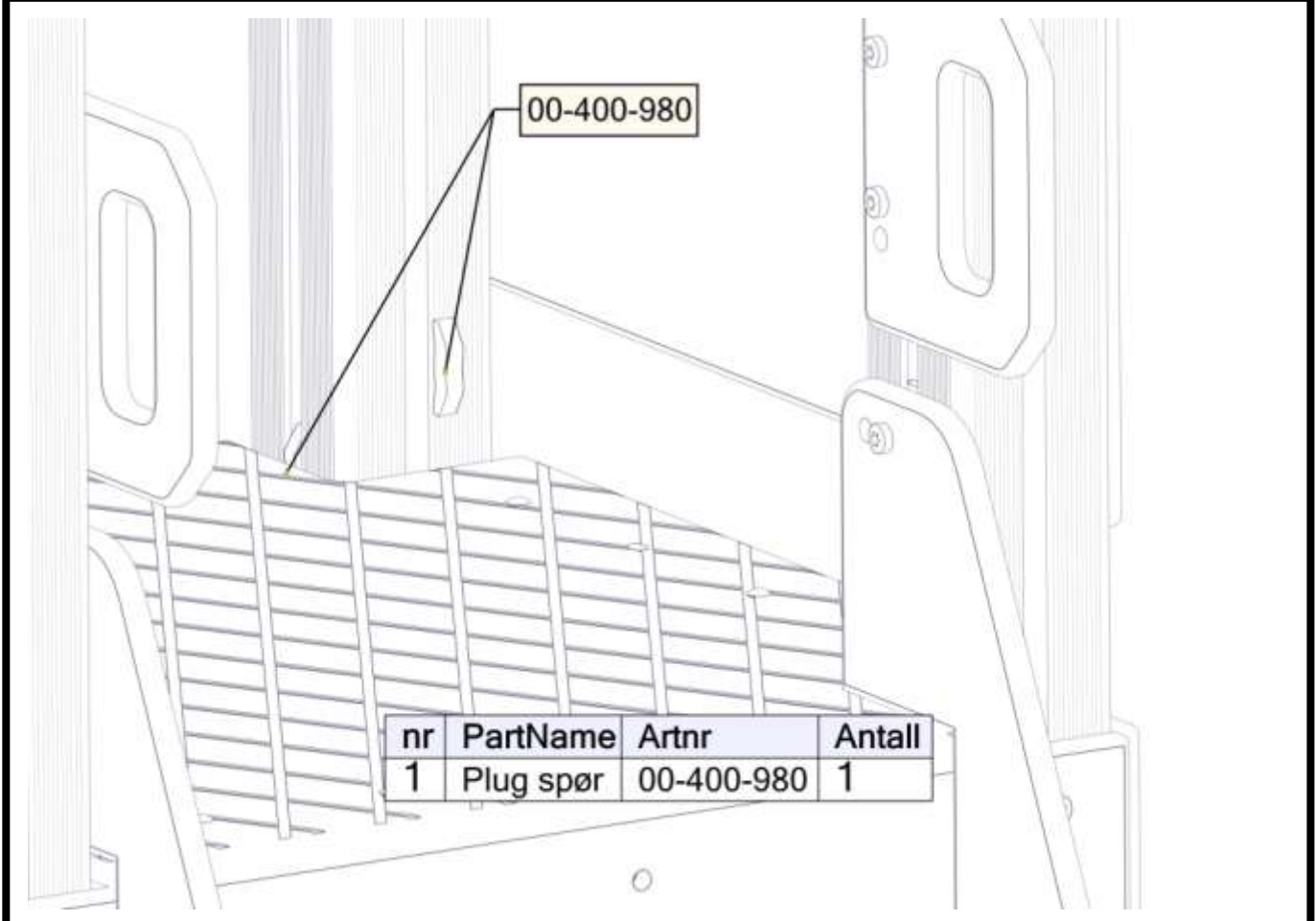
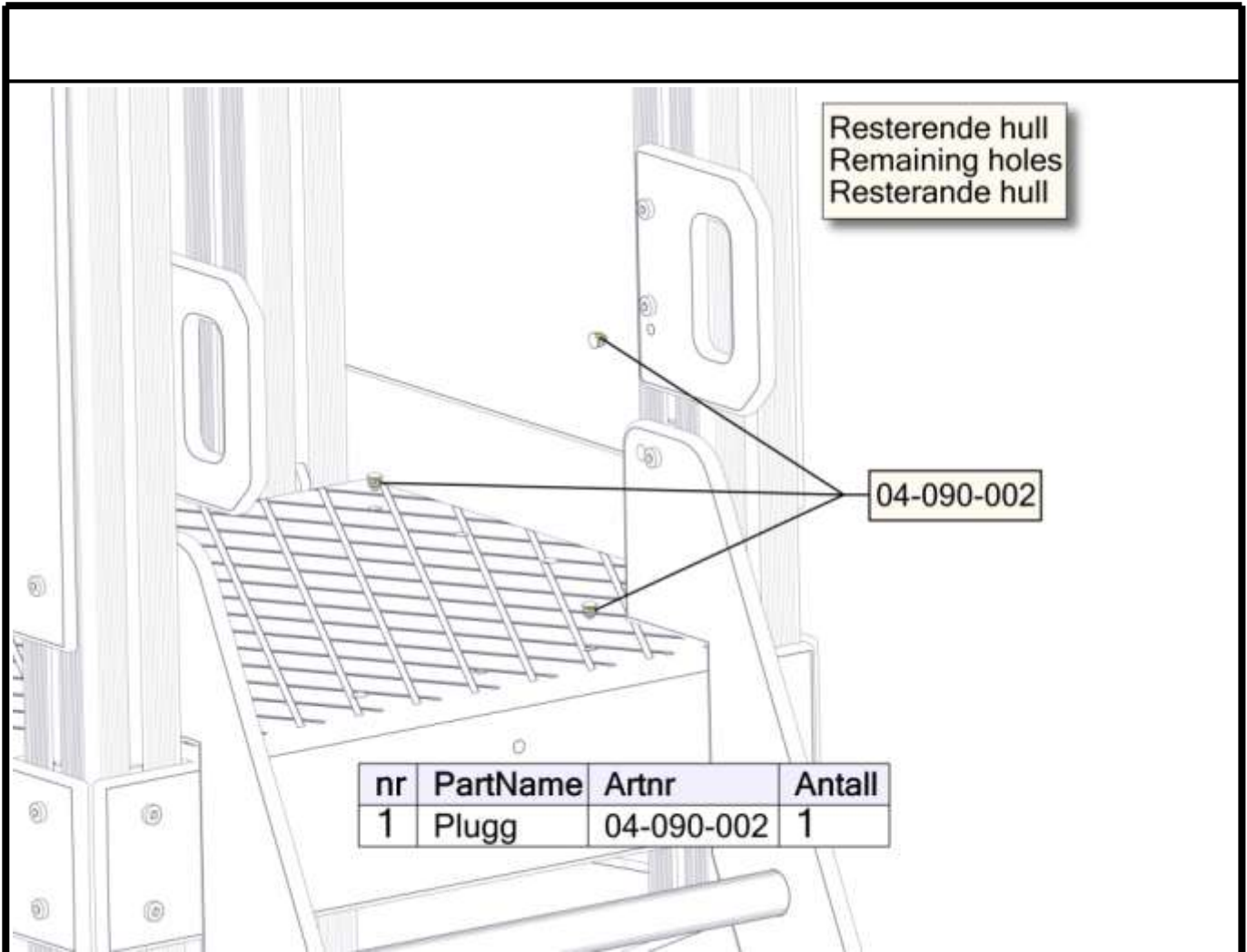





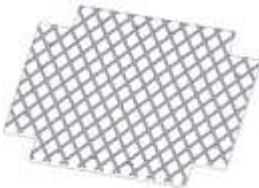



nr	PartName	Artnr	Antall
1	Tårn 710x300x12	01-450-502	1
2	Torx M8x25	04-000-025	2
3	Torx M8x35	04-000-035	2
4	Låsemutter M8	04-040-008	2











nr	PartName	Artnr	Antall
5	Brikke50 1XM8	04-060-050	2
6	Vinkel 50x50x50x5 9mm hull	04-075-050	2





Før utstyret tas i bruk / Before play begins / Innan lekredskapet tas i bruk	
N	<ul style="list-style-type: none"> ● Påse at fallunderlag er utlagt i henhold til gjeldende regler eller vår anbefaling ● Fjern alle monteringshjelpemidler (rester av betong, planker, paller, plast, og lignende) ● Før utstyret tas i bruk, burde man sjekke at det ikke er fare for at anorakksnorer og lignende som kan hekte seg fast noen steder på lekeapparatet. (Vedlagte snor med dobbe (kneledd) kan brukes til å sjekke at dette er i orden. Se vedlagte veiledning for bruk av denne. Dette gjøres for å oppdage eventuelle feilmonteringer.?) ● NB! Bør stå i 2-3 dager før bruk
EN	<ul style="list-style-type: none"> ● Make sure the area and depth of safer surfacing are according to the current standard, or to the manufacturer's recommendation ● Make sure all tools and surplus materials are removed before play begins ● PS! When complete, allow 2-3 days for the concrete to set before use
S	<ul style="list-style-type: none"> ● Kontrollera att fallunderlag är utlagt enligt gällande regler eller vårt rekommendation ● Ta bort alla monteringshjälpmedel (rester av betong, plankor, pallar, plast och liknande) ● Innan lekredskapet används, kontrollera att anoracksnoddar eller kläder/delar av kläder eller liknande inte kan fastna i några delar på redskapet. (Den bipackade "knävringen" kan man med fördel användas för denna kontroll. ● Detta görs för att upptäcka eventuella felmonteringar.)

komponenter		Sign. _____.			
	VK95 L=2600 600-2000 00-400-010	8		Gulv 740x740x15 00-400-300	2
				Ende lokk 00-400-998	8
	Vegg 688x636x12 01-125-010	7		Fundametplate 00-003-106	4
	Sprosse 740x145x15 01-400-108	6		Sprosse 740x145x15 2 H cc300 01-400-109	2
	Nett bro inkl beslag 07-510-174	1		Rør bua 07-510-164	2
	Stige 950 00-400-615 4 trinn	1		Handtak 00-400-170	2
	Rursjebane 950 40-142-020	1		Spererør 520 00-450-155	2
	Tak tårn 01-450-502	8		Eventuelt funda- menter	8
			M8x35 Brikke 120 Brikke 50	M8x35 04-060-120 04-060-050	24 8 8

komponenter		Sign. _____			
	Torx M8x12 04-000-012	3		Brikke 50-1T 04-060-050	46
	Torx M8x16 04-000-016			Brikke 120-3T 04-060-120	6
	Torx M8x20 04-000-020	2			
	Torx M8x25 04-000-025	40		Brikke 160-3T 04-060-160	2
	Torx M8x30 04-000-030	17		Låsemutter M8 04-040-008	30
	Torx M8x35 04-000-035	80			
	Torx M8x45 04-000-045	2		Stålforankring 00-100-310	4
	Møbelknapp M8x13x17 04-030-011	5			
	04-030-025	8			
	Saddelwisher 04-210-010	16			
	Plast plug 9-11mm 04-090-002	38		Plug spor 00-400-980	16
	Skive M8 04-050-008	8			
	Skive M8 stor 04-055-008	4		Vinkel 50x50x50 04-075-050 9mm	8