

N

Monteringsanvisning

EN

Assembly Instructions

S

Monteringsanvisning

Produkt nr. / Product no. / Produkt nr.

23-400-065

Ordr nr. _____

Dato. _____

Sign. _____

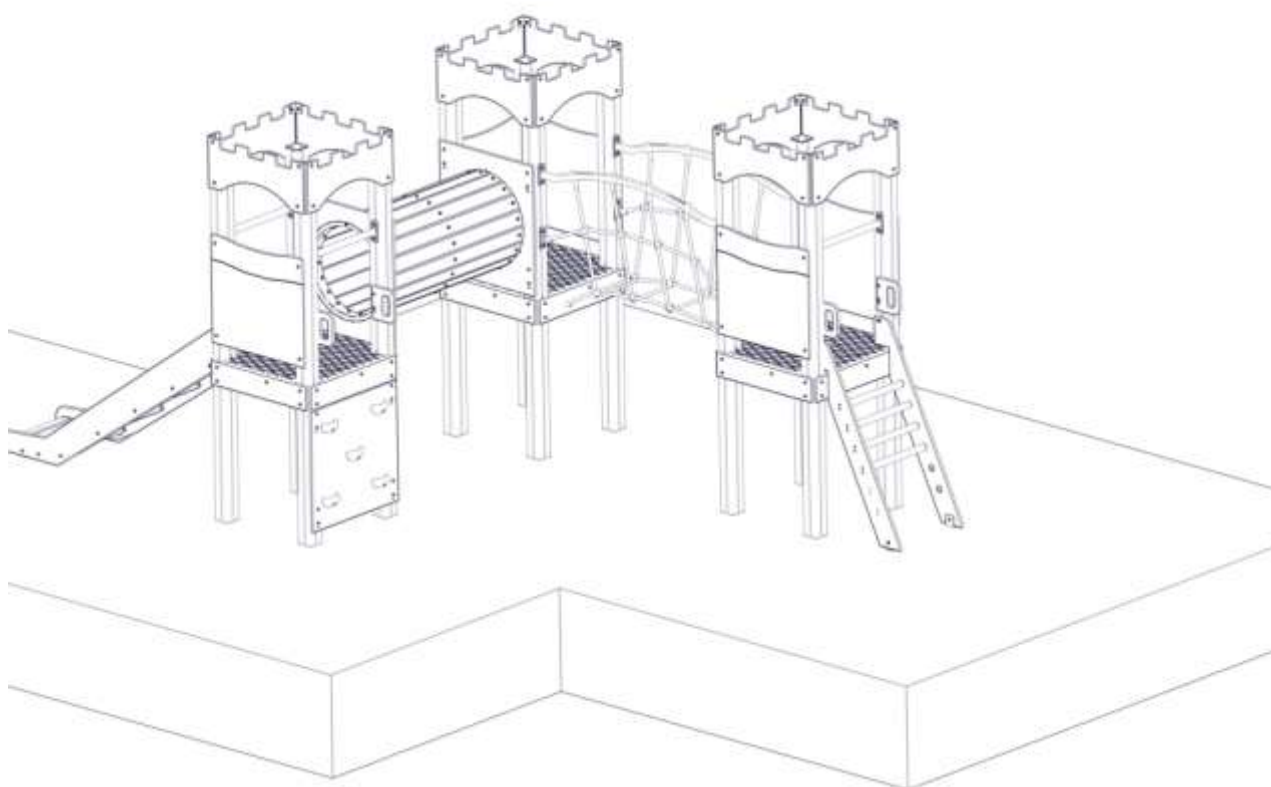
**sove**

Søve AS
3830 Ulefoss - Norway
Tlf: +47 35 94 65 65
www.sove.no



Søve AB
EA Rosengrensgatan 32
421 31 Västra Frölunda
Phone: +46 (0)31 773 97 00
www.sove.se

Monteringstips / Assembly Advice / Monteringsstips

N

- Les monteringsanvisningen nøye før montering.
- Monter elementene i rekkefølgen som vist.
- Boltene bør ikke skrues for hardt til før alt er montert, vatret og loddet. Skru så boltene til.
- NB! Ved bruk av drill, kan boltene ryke.
- På grunn av at solen kan gjøre rutsjeplaten veldig varm, bør rutsjebanens utløp vende mot nord-øst eller nord-vest.
- Er lekeutstyret plassert i naturlige ferdselstraséer må området sikres mot gjennomgang.
- Innspringningshinder bør vurderes rundt lekeapparater hvor det er stor bevegelse, f.eks. ved huskestativ.
- Det bør være fritt innsyn til lekeutstyr som er beregnet for barn under 3 år.

NB! Under monteringsarbeidet må utstyr, som ikke er forankret forsvarlig i bakken, sikres slik at det ikke velte. Området må avstenges under montering av apparatene med sperrebånd eller lignende.

EN

- Read the instruction carefully before assembling the play unit..
- Assemble the components in the sequence shown in these instructions.
- Fixings must not be fully tightened during assembly. Before casting the foundations, the structure must be level and plumb, at which point all fixings are tightened.
- PS! If use of drill, the bolts may be wrecked.
- Avoid positioning the slide facing due south because of overheating – ideal positions are facing north-east or north-west.
- Secure the construction-area to prevent people from walking through it.
- Consider installing barriers around play-equipment which gives rise to a lot of activity – i.e.swings.
- Ensure that clear vision is possible across the play area so that supervision is possible from any position, particularly where children under 3 years of age will be playing.

NB! During assembly of the equipment, ensure that all structures are securely propped, especially when left overnight. Also ensure that equipment is supported whilst concrete foundations are setting and enclose the area securely to prevent access.











Monteringstips / Assembly Advice / Monteringsstips

S

- Läs monteringsanvisningen noga före montering.
 - Montera delarna i den ordningen som anvisas
 - Skruvarna bör inte skruvas för hårt tills allt är monterat, i väg och lodat.
- OBS! Används elektrisk skruvdragare, kan bulten gå sönder. Hårddra därför manuellt!
- Solen kan göra att rutchbanan blir väldigt varm. Banans nedfart rekommenderas att vändas i norrlig riktning
 - Om lekplatsen placeras vid en gångväg mm bör området säkras mot genomfart av gående och cyklister.
 - Insprängningshinder bör placeras runt lekutrustning med stor rörelse, t ex, gungställning.
 - Det bör vara fri insyn till lekutrustning beräknat till barn under 3 år.

**OBS! Under monteringsarbete bör utrustningen som inte ska förankras i marken, ställs så att den inte kan välta.
Området måste spärras när lekutrustningen byggs upp, med avspärrningsband eller liknande.**

Nødvendig verktøy / Tools required / Nödvändiga verktyg

<p>(N)</p> <p>(EN)</p> <p>(S)</p>	<p>(A)</p> 	<p>(B)</p>  <p>Torx Nr 45 High quality</p>	<p>(C)</p> <p>5 mm 6 mm</p> 	<p>(D)</p> 	<p>(E)</p> 
		<p>Metermål Metric measure Tumstock</p> 	<p>16 V</p> 	<p>Merkebånd Mark ribbon Märkeband</p> 	<p>13 + 17mm</p> 

Nødvendig antall personer / Number of persons required / Rekommenderad antal personer





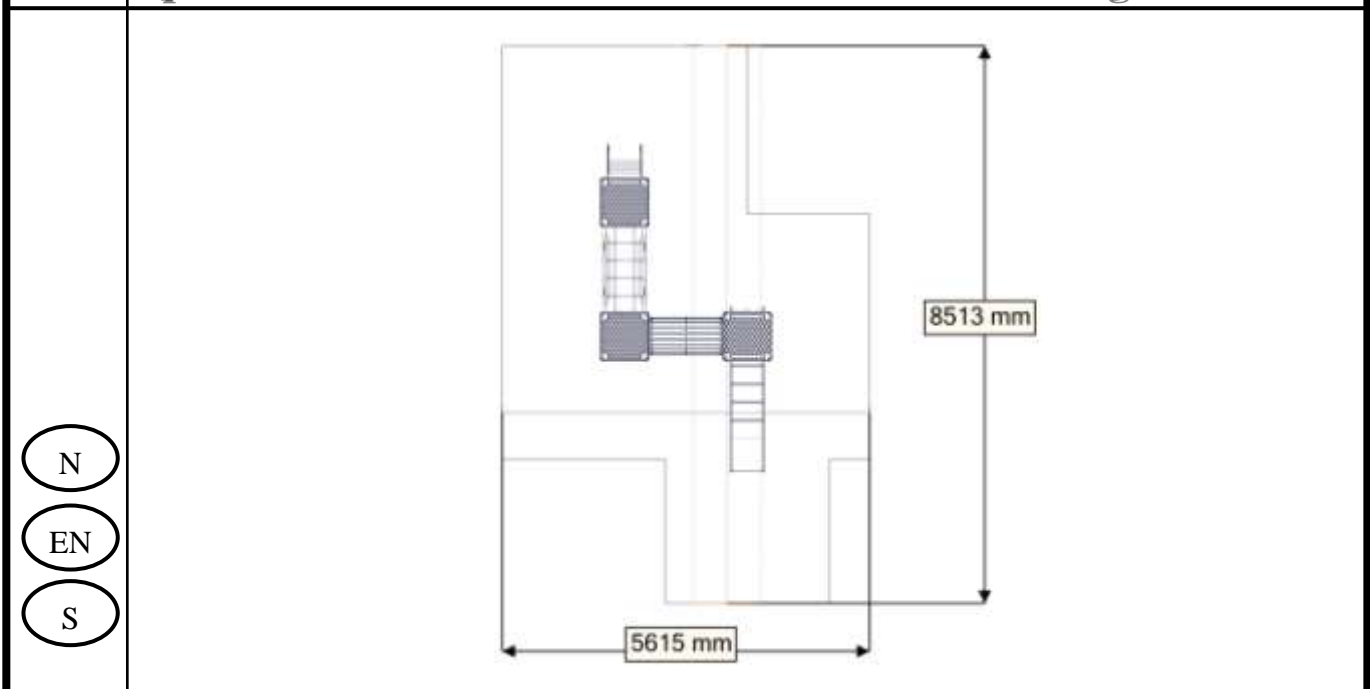







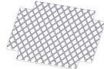







Anbefalt arealbehov ved montering / Recommended working space / Rekommenderad arealbehov ved montering













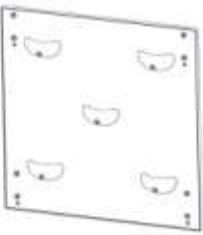

Boltepakker for / Boltpackage for / Bultpaket för

Sign. _____

Stolpe 95x95	Ant= 1	Navn	Artnr/dimensjon	Ant	Lev
		VK95 L=2600 600-2000 (16)	00-400-018	12	
		Stolp ende (1)	00-400-998	12	
Gulv 740x740x15	Ant= 3	Navn	Artnr/dimensjon	Ant	Lev
		Gulv (1)	00-400-300	3	
		Vinkel 50x50x4(1)	04-070-050	3	
		Torx M8x30 (1) Torx M8x12(1)	04-000-030 04-000-012	3 3	
		Møbelknapp (1)	04-030-011	3	
		Plast plug 9-11 mm (16)	04-090-002	48	
		Plug spor (8)	00-400-980	24	
		Skive M8 (2)	04-050-008	6	
		Låsemutter M8(1)	04-040-008	3	
Sprosse 01-400-108	Ant= 10	Navn	Artnr/dimensjon	Ant	Lev
		Sprosse (1) 740x145x15	01-400-108	10	
		Torx M8x35 (4)	04-000-035	40	
		Brikke 150 _3T (6) På stolpe	04-050-008	0	
Sprosse 01-400-109	Ant= 2	Navn	Artnr/dimensjon	Ant	Lev
		Sprosse (1) 740x145x15 2 hull bro	01-400-109 2 hull bro CC300	2	
		Torx M8x35 (4)	04-000-035	8	
		Brikke 150 _3T (6) På stolpe	04-050-008	0	





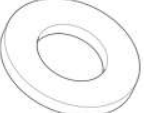





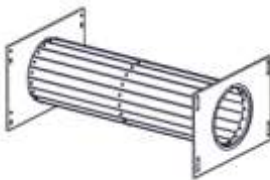

Boltepakker for / Boltpackage for / Bultpaket för

Sign. _____

Klatrevegg mini	Ant= 1	Navn	Artnr/dimensjon	Ant	Lev
		Klatrevegg mini	01-450-762	1	
		Torx M8x25 (8)	04-000-025	8	
		Brikke 120_1T (4)	04-000-120	4	
Nettbro rett 07-510-174	Ant= 1	Navn	Artnr/dimensjon	Ant	Lev
		Nett (1) INKL. beslag	07-510-174	1	
		Rør bue(2)	07-510-164	2	
		Brikke120 3T(8)	04-060-120	8	
		Torx M8x25(16)	04-000-025	16	
		Saddelwasher 38mm (16)	04-210-010	16	
		Møbelknapp M8x25 (8)	04-030-025	8	
		Låsemutter	04-040-008	4	
		Skive M8	04-055-008	4	













Boltepakker for / Boltpackage for / Bultpaket för

Sign. _____

Tunell liten 02-100-050	Ant= 1	Navn	Artnr/dimensjon	Ant	Lev
		Tunell HPL plate (2)	01-244-010 Liten	2	
		Tunell ring (1)	01-243-011	1	
		Tunell sprosse (19) 1130x89	01-243-012	19	
		Torx M8x30 (16) Torx M8x16 (19) Torx M8x12(38)	04-000-030 04-000-016 04-000-012	16 19 38	
		Brikke 120_3T (8)	04-060-120	8	
		Møbelknapp (12) M8-13-17	04-030-011	57	
		propp 9-11mm	04-090-002	8	
		Skive M8 (57)	04-050-008	57	
Vegg 688x636x12 01-125-010	Ant= 5	Navn	Artnr/dimensjon	Ant	Lev
		Vegg 688x636x12 (1)	01-125-010	5	
		Brikke 50_1T(4)	04-060-050	20	
		Torx M8x35(4)	04-000-035	20	















Boltepakker for / Boltpackage for / Bultpaket för

Sign. _____

Rutsjebane 950 40-142-020	Ant= 1	Navn	Artnr/dimensjon	Ant	Lev
		Systembane 950	40-142-020	1	
		Brikke160 3T(5)	04-060-160	2	
		Torx M8x35(4)	04-000-035	4	
		Torx M8x45(2)	04-000-045	2	
		Torzx M8x30(4)	04-000-030	4	
		Fundamentskive(2) 2H 80	00-003-106	2	
		Skive M8(2)	04-050-008	4	
		Mutter M8(2)	04-040-008	6	
	Stålforankering(2)	00-100-310	2		
	Plast plug 9-11 mm (4)	04-090-002	4		
Sperrerør 520	Ant= 3	Navn	Artnr/dimensjon	Ant	Lev
		Sperrerør 520 (1)	00-450-155	3	
		Brikke 120_3T (2)	04-060-120	6	
		Torx M8x25 (4)	04-000-025	12	







Boltepakker for / Boltpackage for / Bultpaket för

Sign. _____.

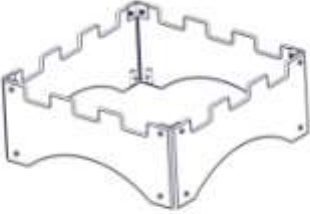
Stigge 950 00-400-615	Ant= 1	Navn	Artnr/dimensjon	Ant	Lev
		Stigge 950	00-400-615 Med 4 trinn	1	
		Brikke 50_1T(2)	04-060-050	2	
		Torx M8x30(6)	04-000-030	6	
		Torx M8x20(2)	04-000-020	2	
		Fundamentskive(2) 2H 80	00-003-106	2	
		Skive M8(2)	04-050-008	4	
		Mutter M8(2)	04-040-008	4	
		Møbelknapp(2) M7 _13-17	04-030-011	2	
	Stålforankering(2)	00-100-310	2		
handtak	Ant= 4	Navn	Artnr/dimensjon	Ant	Lev
		handtak (1)	00-400-170	4	
		Brikke 120-3T	04-060-120	4	
		Torx M8x30 (2)	04-000-030	8	
		Propp 11mm(1)	04-090-002	4	





Boltepakker for / Boltpackage for / Bultpaket för

Sign. _____.

Tak borg 01-450-502	Ant= 3	Navn	Artnr/dimensjon	Ant	Lev
		Tak 2230x400x12 (4)	01-450-502	12	
		Brikke 50_1T (8)	04-060-050	24	
		Torx M8x25(8) Torx M8x35(8)	04-000-025 04-000-035	24 24	
		Vinkel 50x50x50x4 (4)	04-075-050	16	
		Låsemutter M8(8)	04-040-008	24	

Boltepakker for / Boltpackage for / Bultpaket för

Sign. _____.

Fundament	Ant= 12	Navn	Artnr/dimensjon	Ant	Lev
		Fundament plate(1)	00-003-010	12	
		Fundamentdel1 (1) 4x med VK70 hull 1x med VK95 hull	00-003-010	12	
		Fundament del2 (1) 4x med VK70 hull 1x med VK95 hull	00-003-010	12	
		Torx M8x35(3)	04-000-035	36	
		Brikke 120 3T (1) Brikke 501T(1)	04-060-120 04-060-120	12 12	

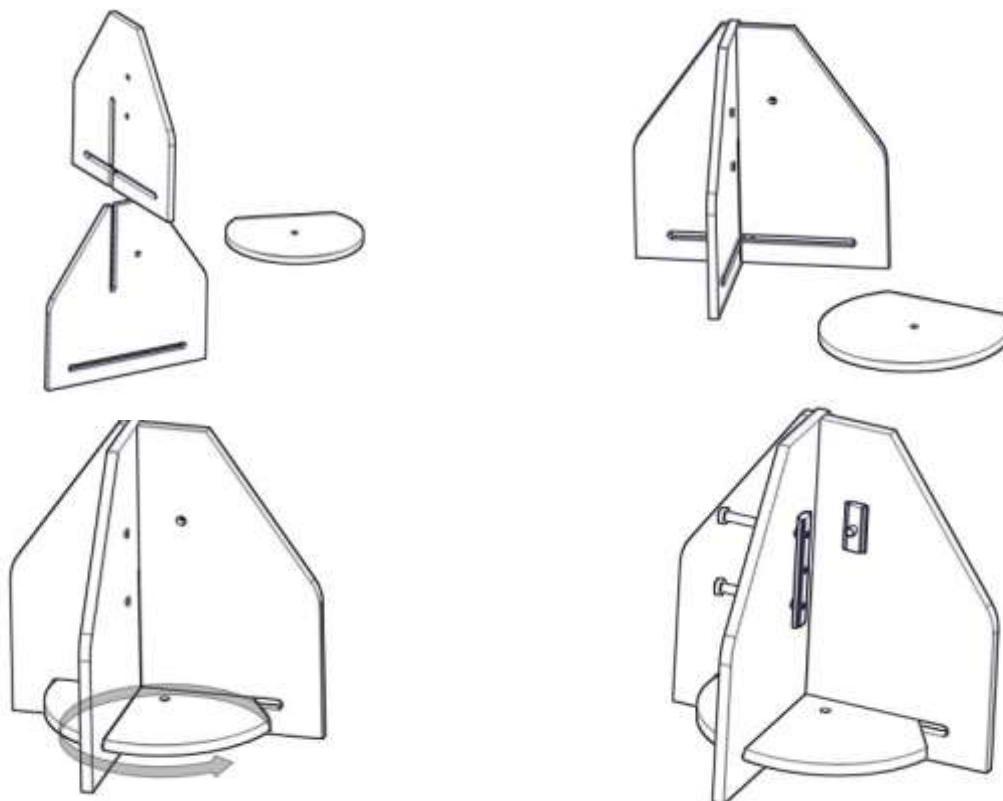

Fundamentering med betong / Foundation concrete / Förankring med betong

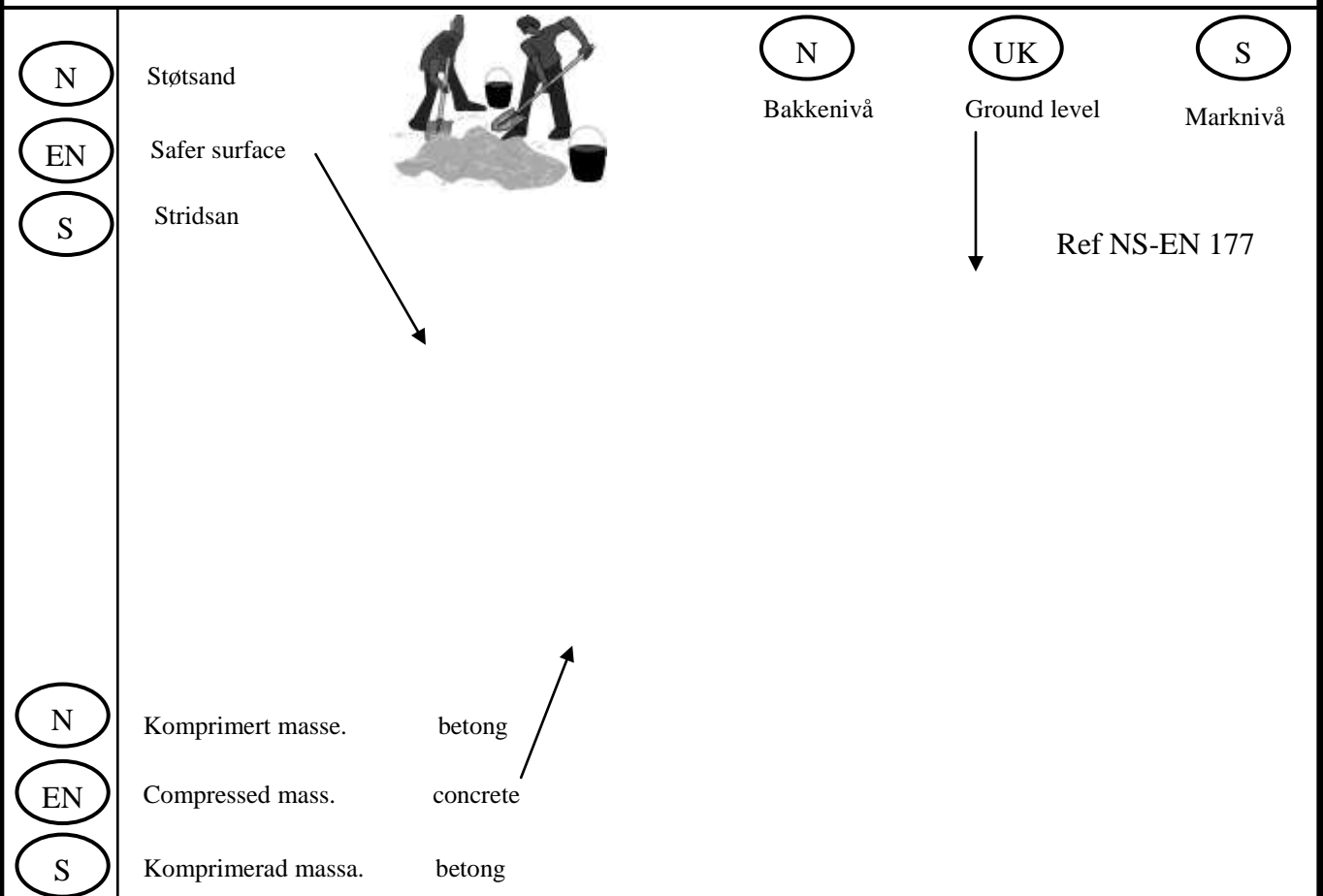

Fundamentering uten betong / Foundation without concrete / Förankring utan betong

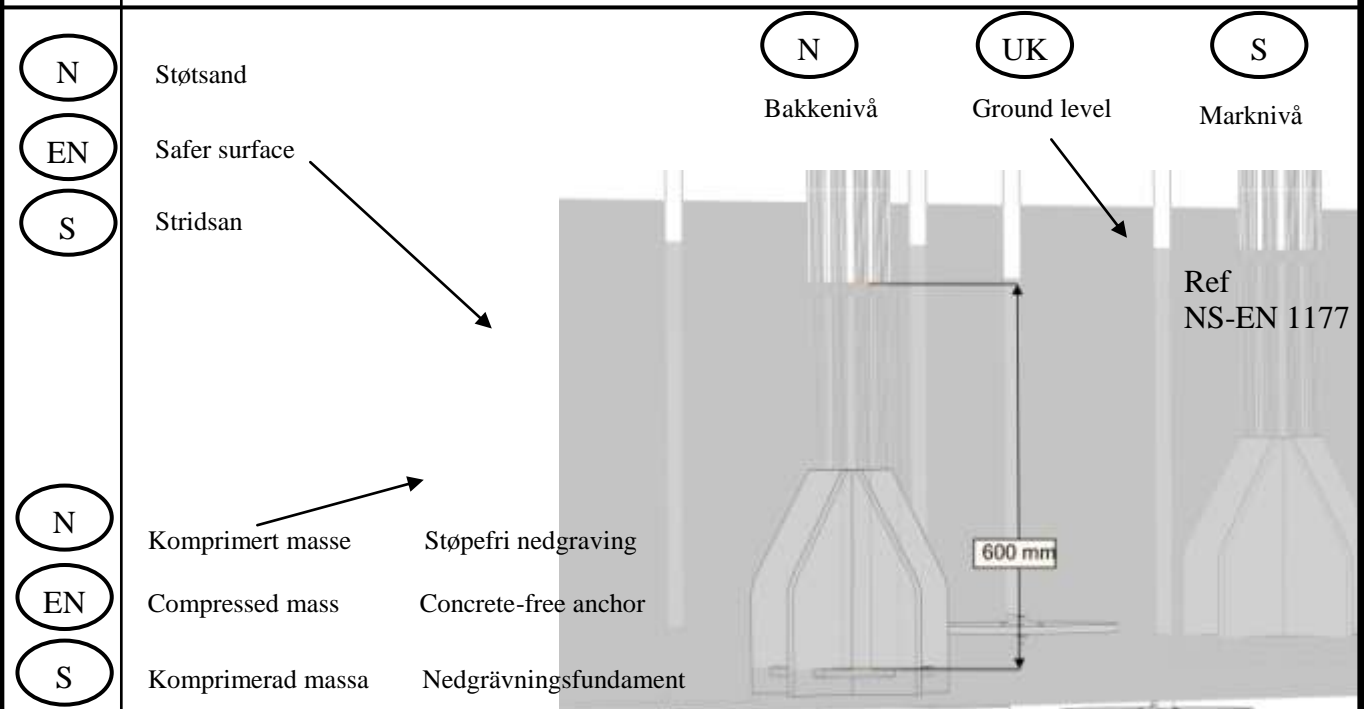

(N) Alle mål er oppgitt i millimeter
 (EN) Scale measured in mm
 (S) Alla mått är i millimeter.

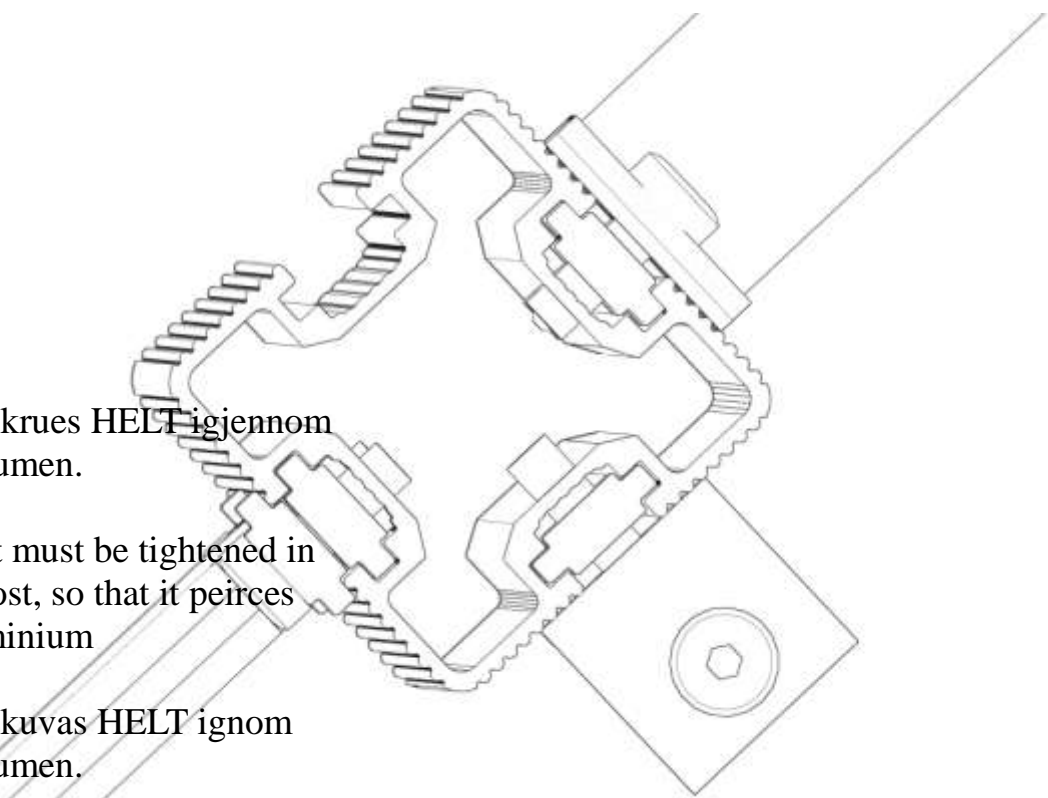
<p data-bbox="119 1556 215 1624">N</p> <p data-bbox="119 1691 215 1758">EN</p> <p data-bbox="119 1848 215 1915">S</p>	 <p data-bbox="239 1579 702 1668">Bolten skrues HELT igjennom aluminiumen.</p> <p data-bbox="239 1713 686 1836">The bolt must be tightened in to the post, so that it peirces the aluminium</p> <p data-bbox="239 1881 662 1971">Bulten skruvas HELT ignom aluminiumen.</p>

Fallhøyder / Free height of fall / Fallhöjder

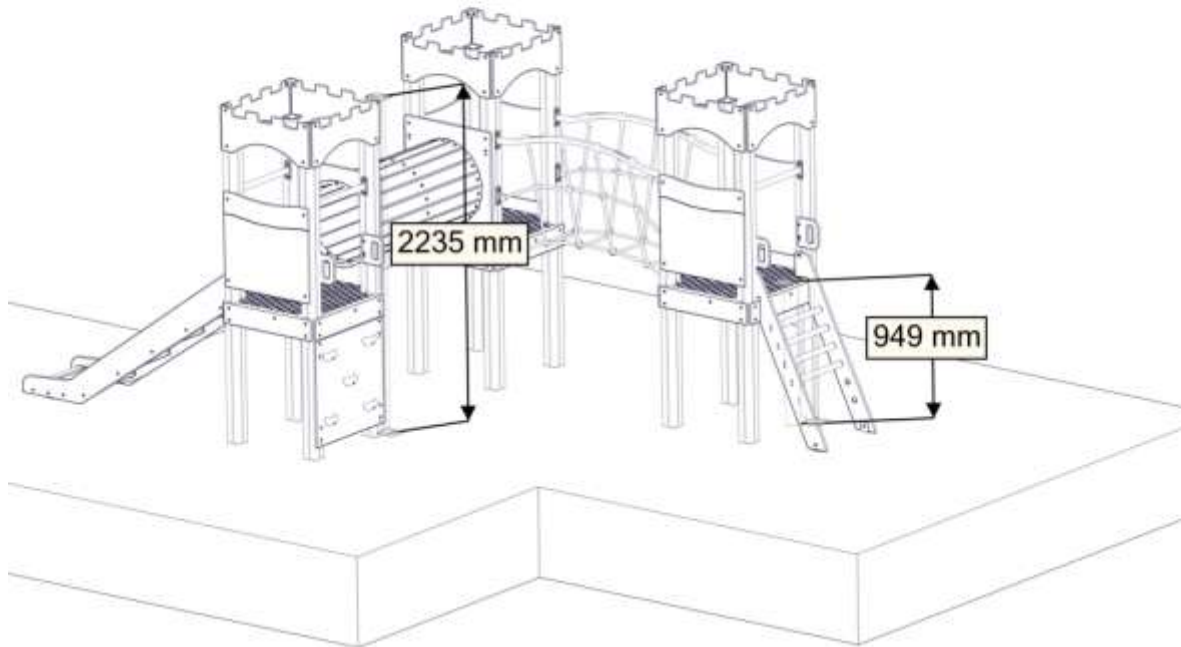

Sikkerhetszone / Safety zone / Säkerhetszon

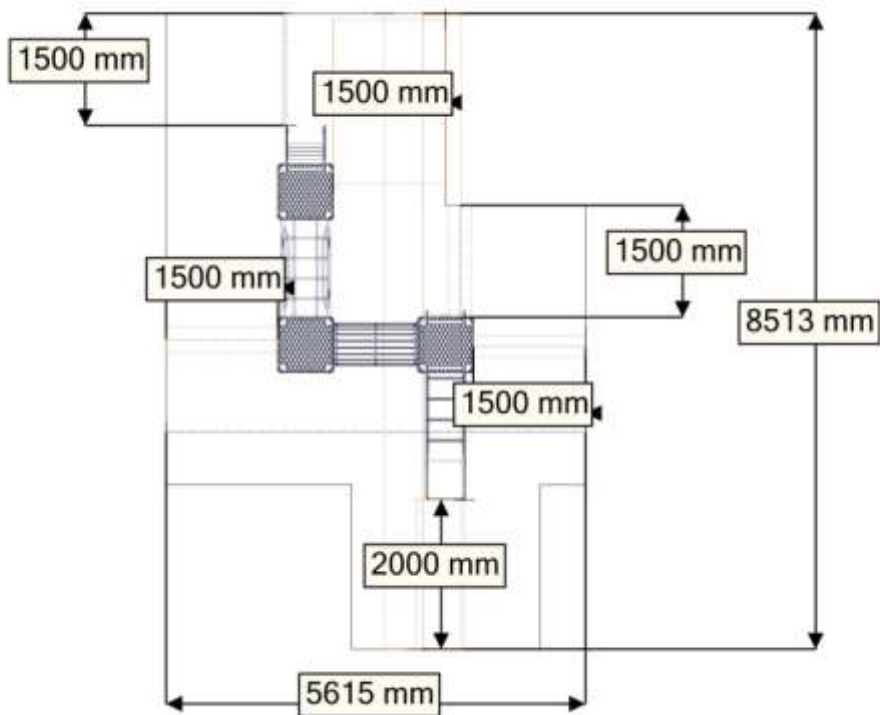

Montering av lekeapparatet / Assembly instructions / Montering av lekredskapet

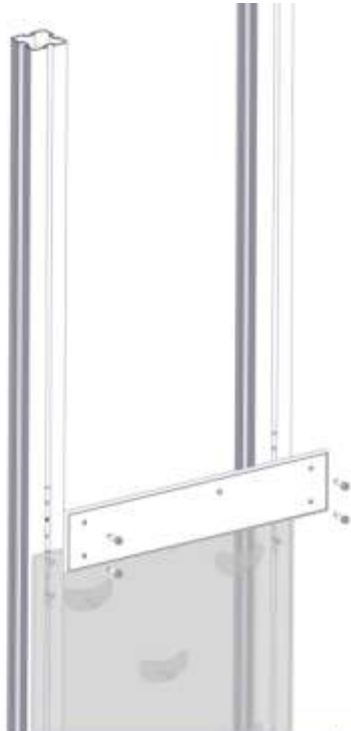

nr	PartName	Artnr	Antall
1	Sprosse gulv 710x145x15	01-400-108	1
2	Torx M8x35	04-000-035	4

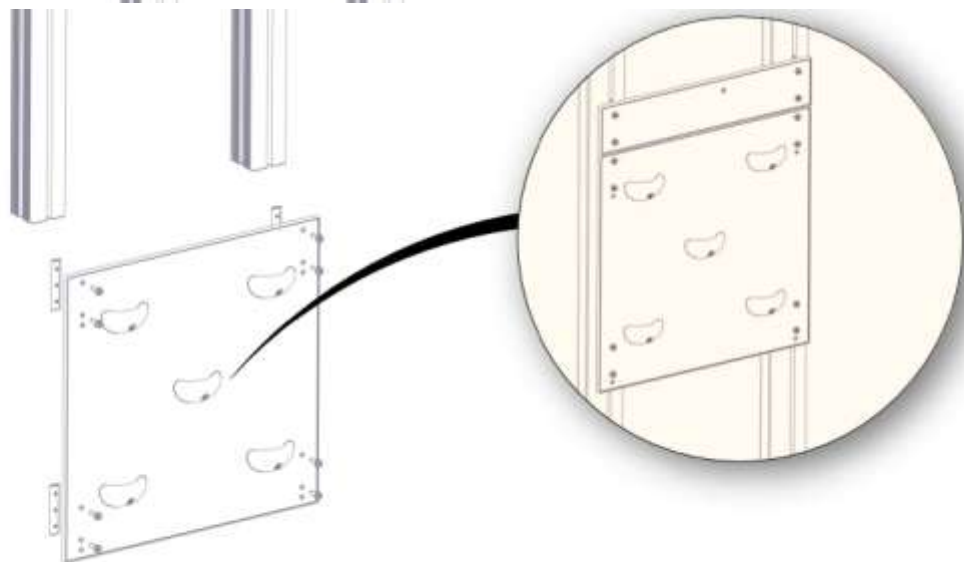

nr	PartName	Artnr	Antall
1	Torx M8x25	04-000-025	8
2	Brikke 120 3xM8	04-060-120	4
3	MiniKlatrevegg	01-450-762	1

Montering av lekeapparatet / Assembly instructions / Montering av lekredskapet

16X

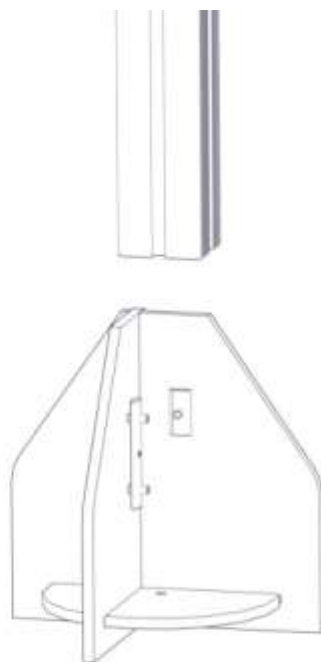

nr	PartName	Artnr	Antall
1	Fundament spor ned	00-003-100	1
2	Fundament spor opp	00-003-101	1
3	Fundament skive	00-003-102	1
4	Stope95x95 600-2000	00-400-018	1
5	Torx M8x35	04-000-035	3

nr	PartName	Artnr	Antall
6	Skive M8 stor	04-055-008	3
7	Brikke50 1XM8	04-060-050	1
8	Brikke 120 3xM8	04-060-120	1

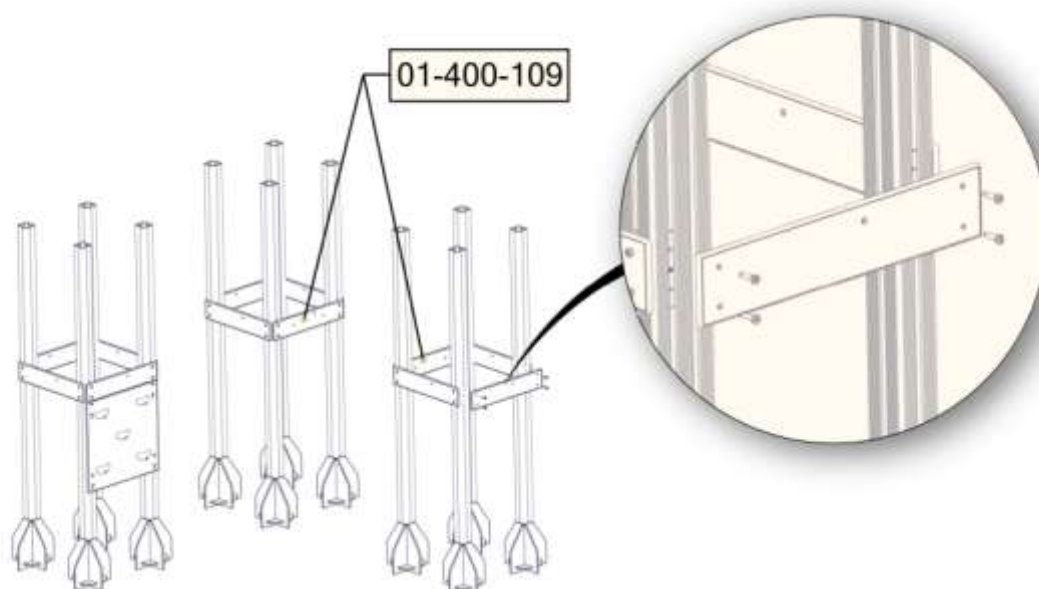

nr	PartName	Artnr	Antall
8	Sprosse gulv 710x145x15	01-400-108	9
9	Sprosse 2 hull bro	01-400-109	2
10	Torx M8x35	04-000-035	44

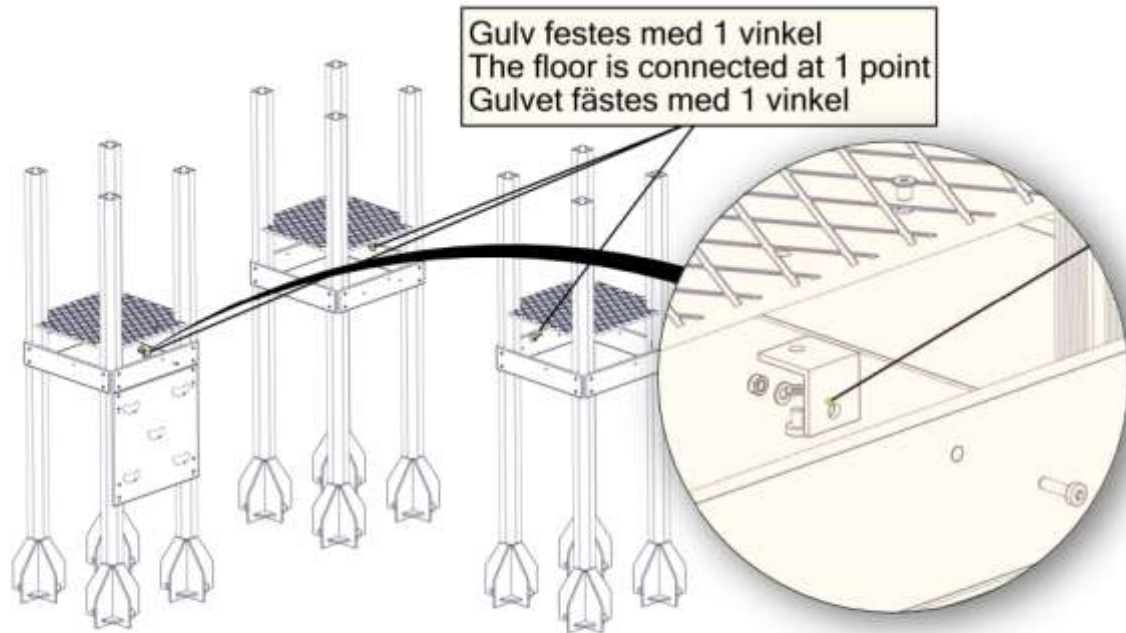

nr	PartName	Artnr	Antall
1	Gulv 740x740x15	00-400-300	3
2	Torx M8x12	04-000-012	3
3	Torx M8x30	04-000-030	3
4	Møbelknapp 16x11	04-030-011	3

nr	PartName	Artnr	Antall
5	Låsemutter M8	04-040-008	3
6	Skive M8	04-050-008	6
7	Vinkel 50x50x50x5 11mm hull	04-070-050	3

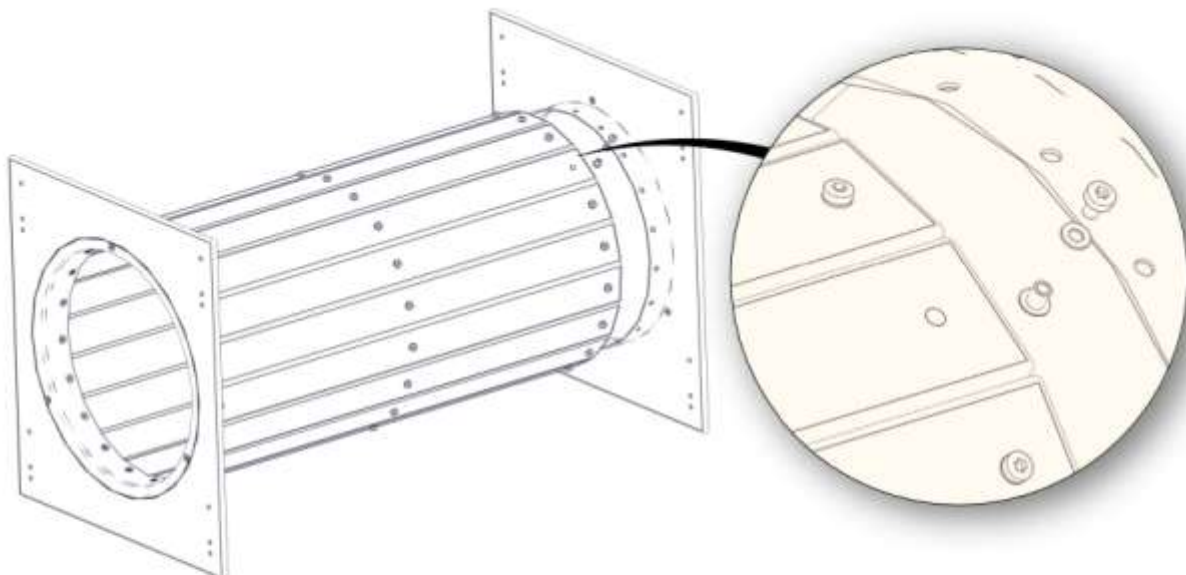

nr	PartName	Artnr	Antall
1	Tunnel_plate_liten	01-244-010	2
2	Torx M8x12	04-000-012	36
3	Torx M8x16	04-000-016	19
4	Møbelknapp 16x11	04-030-011	55

nr	PartName	Artnr	Antall
5	Skive M8	04-050-008	55
6	TunellSprosse 1130x90	01-243-012	1

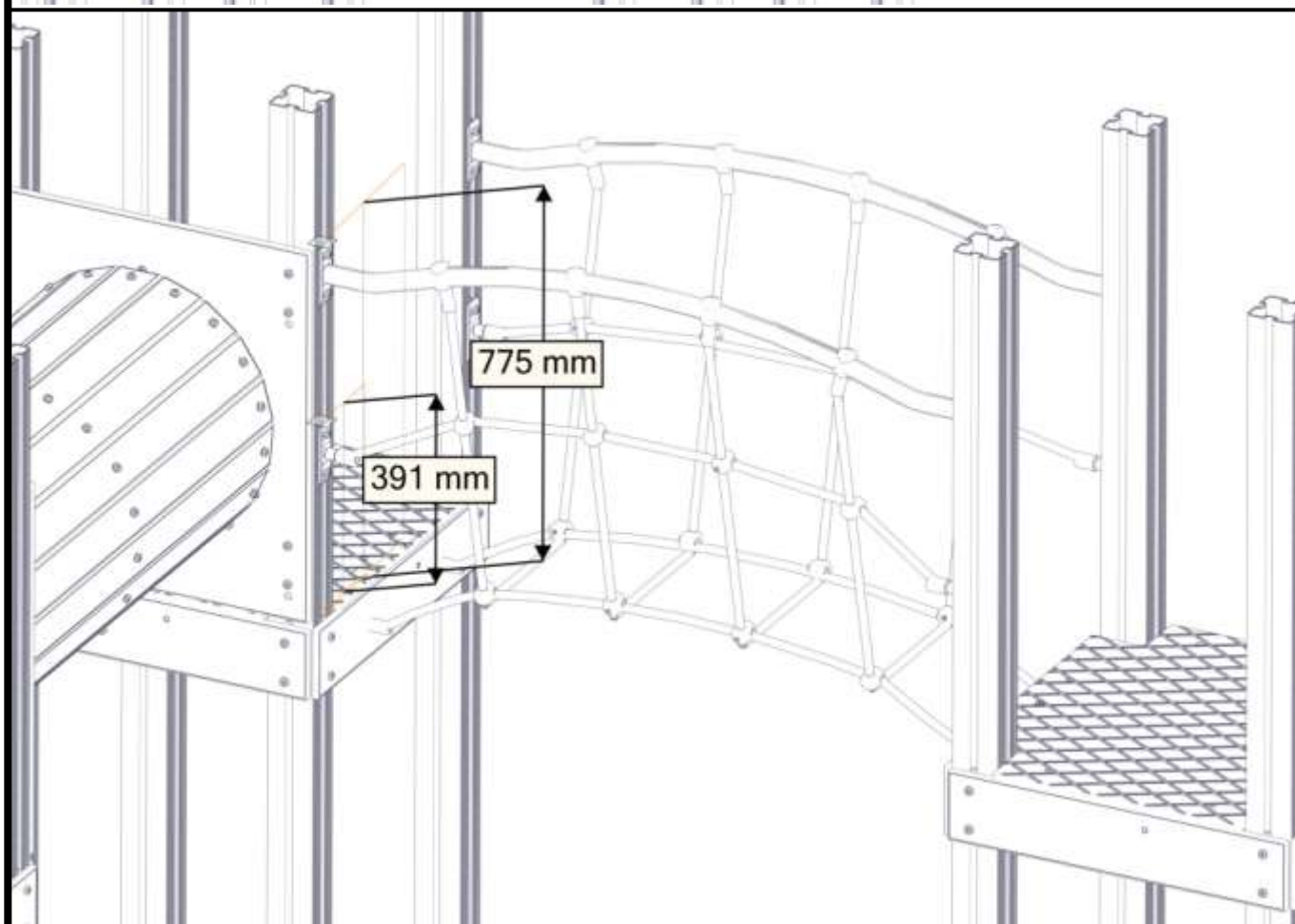
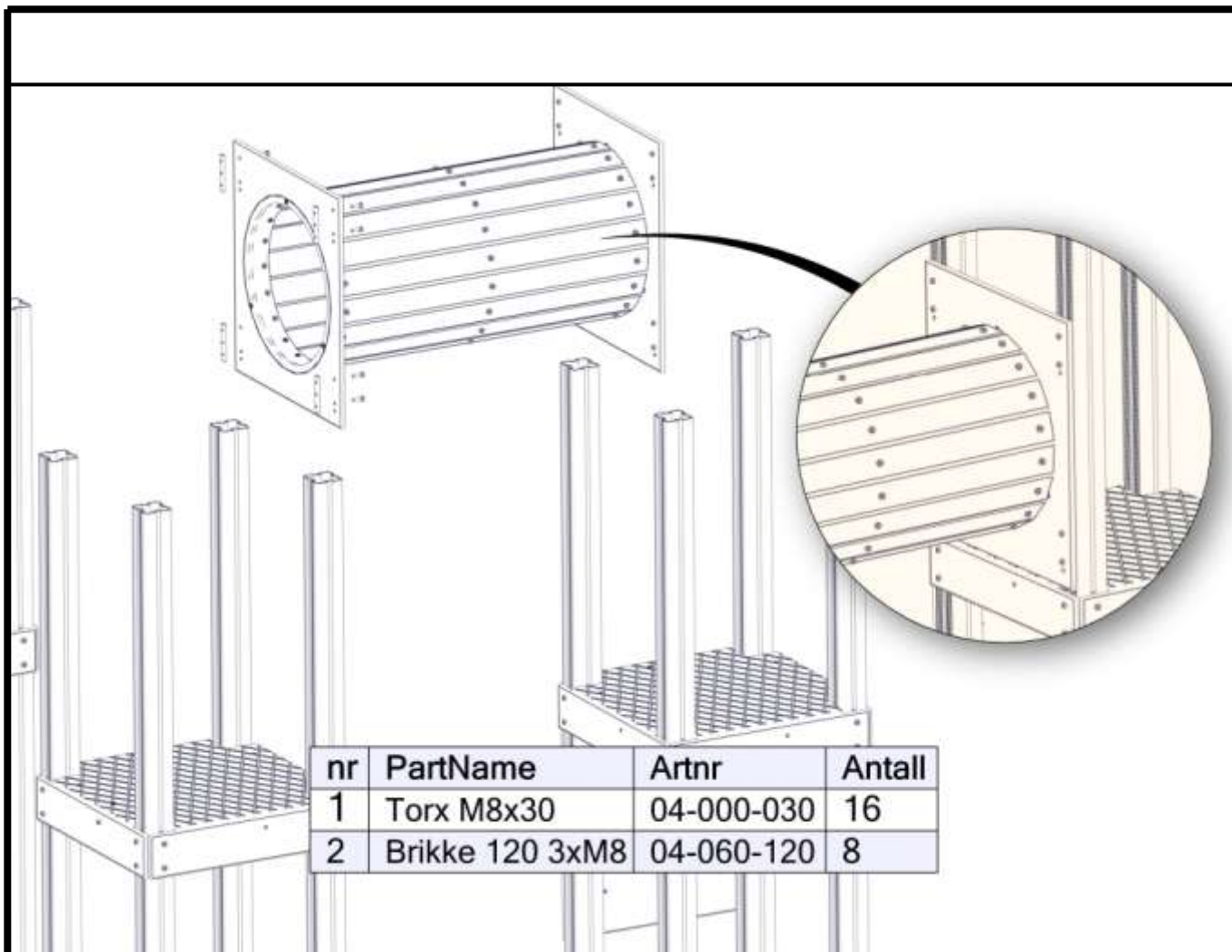

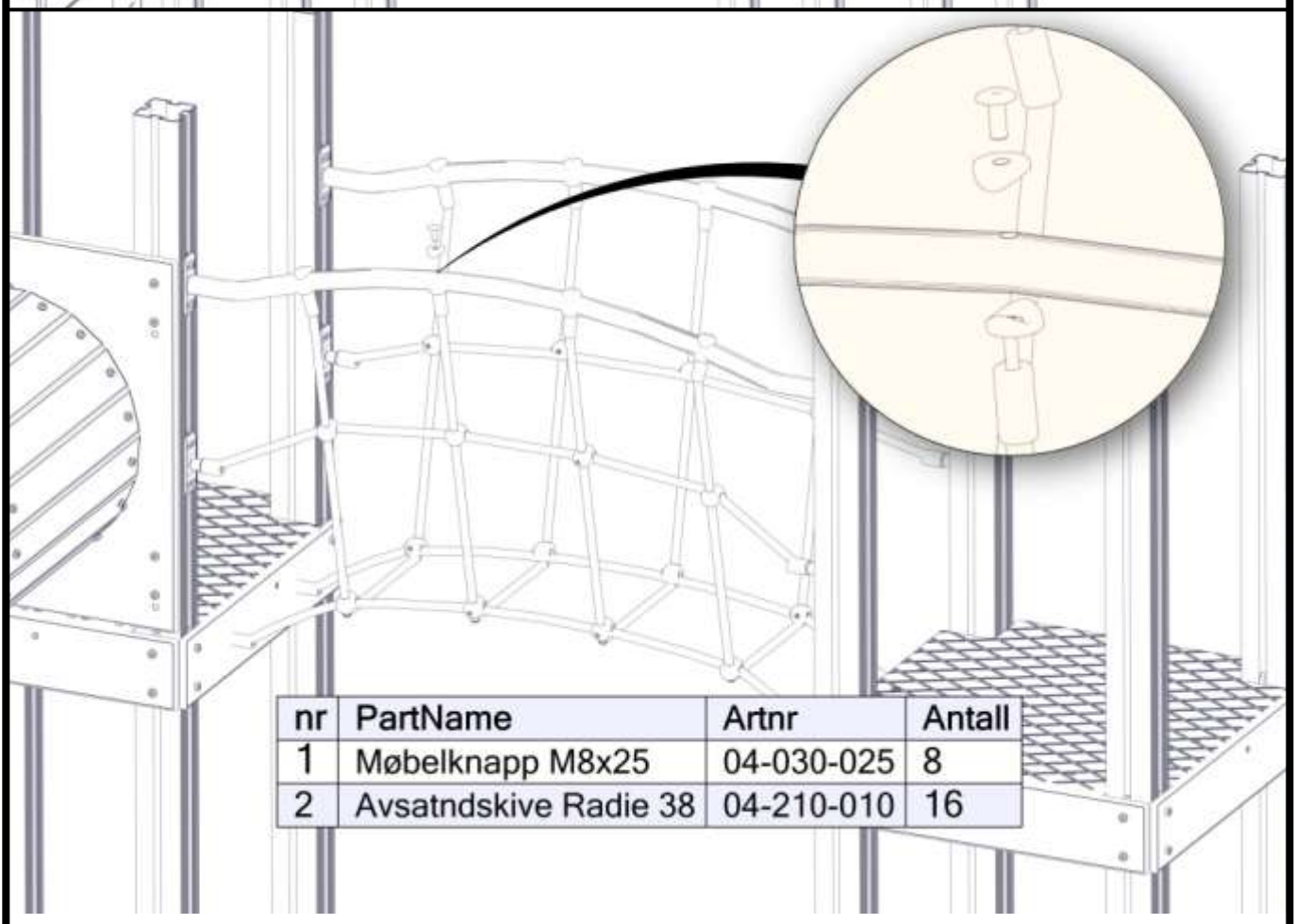
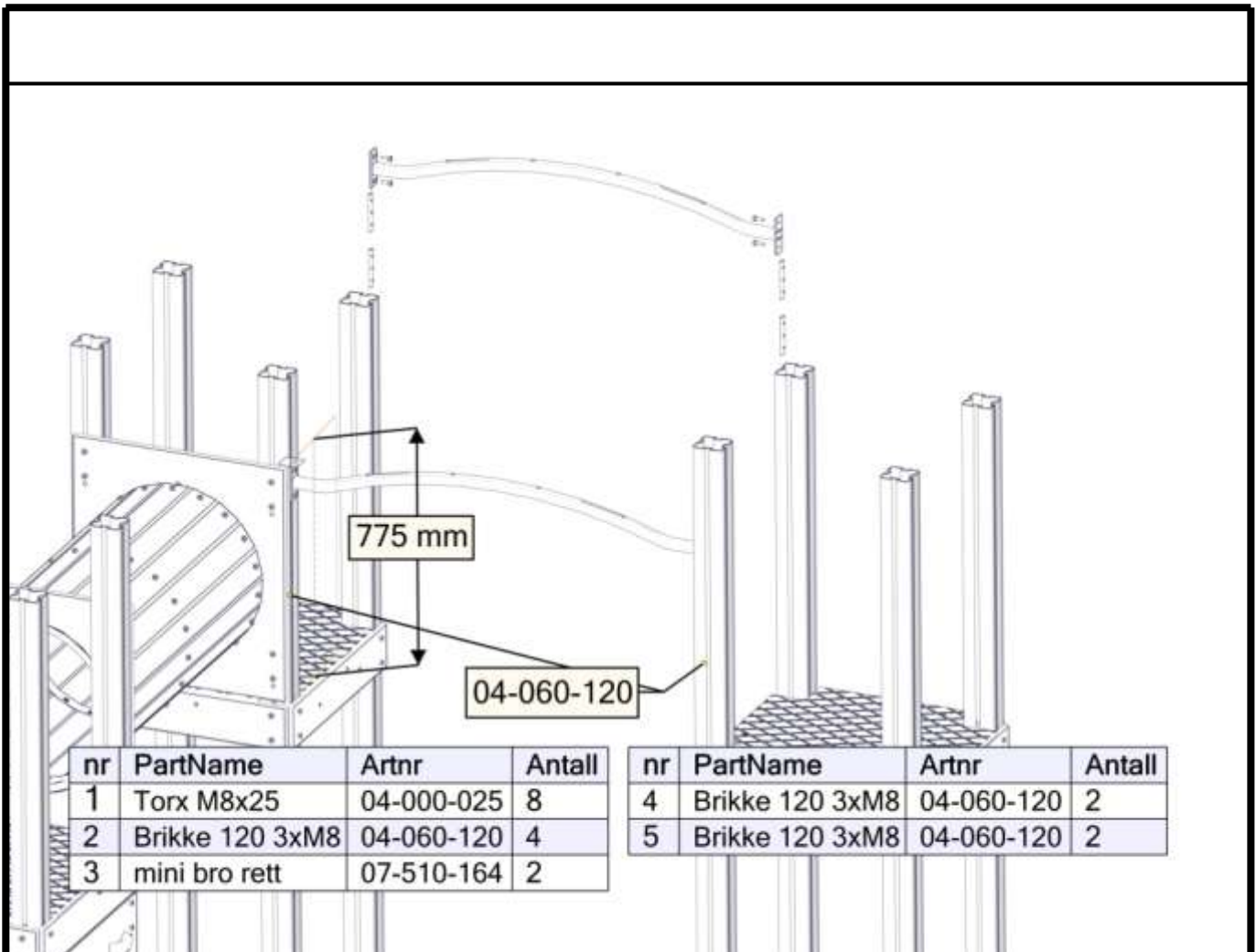

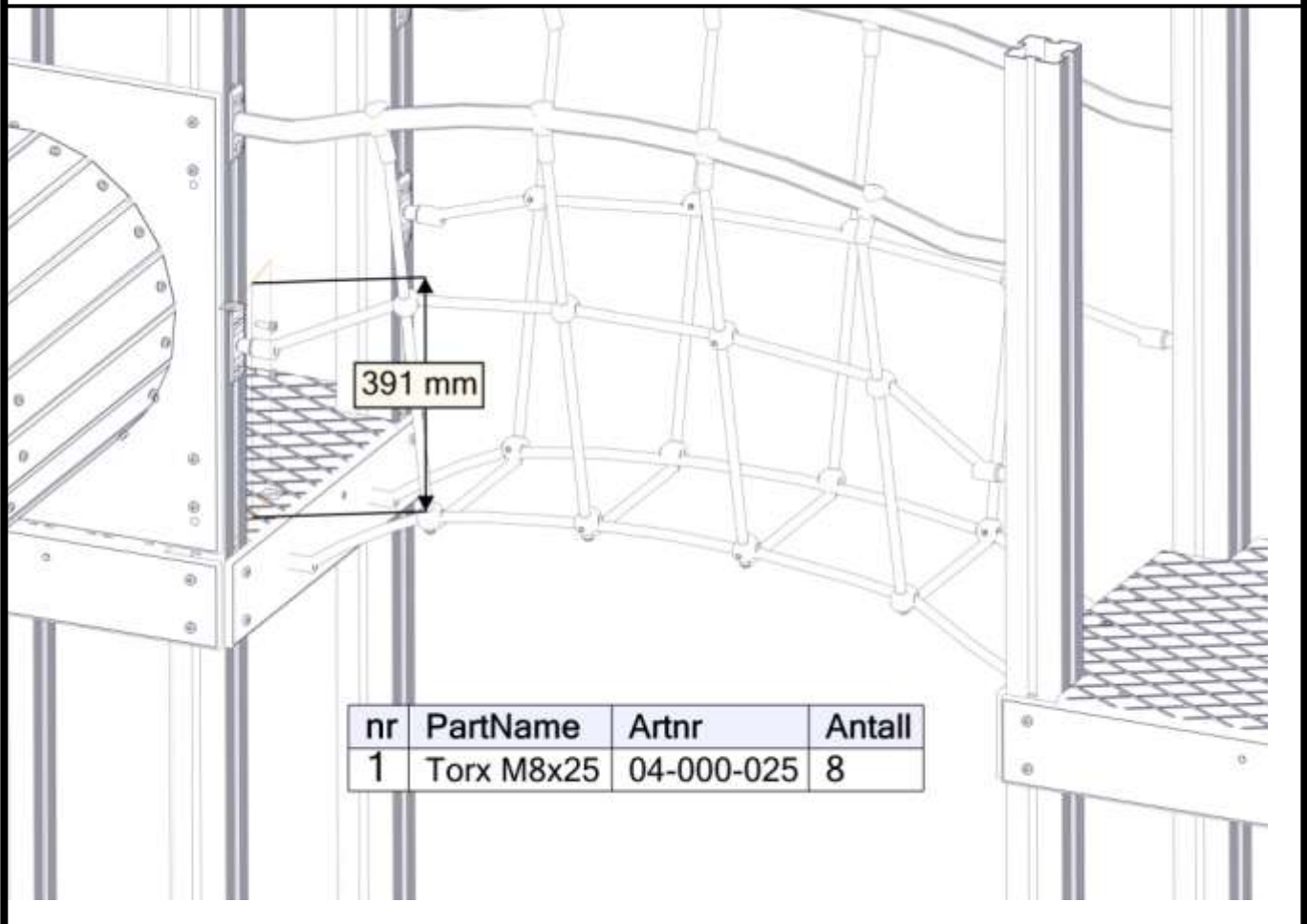
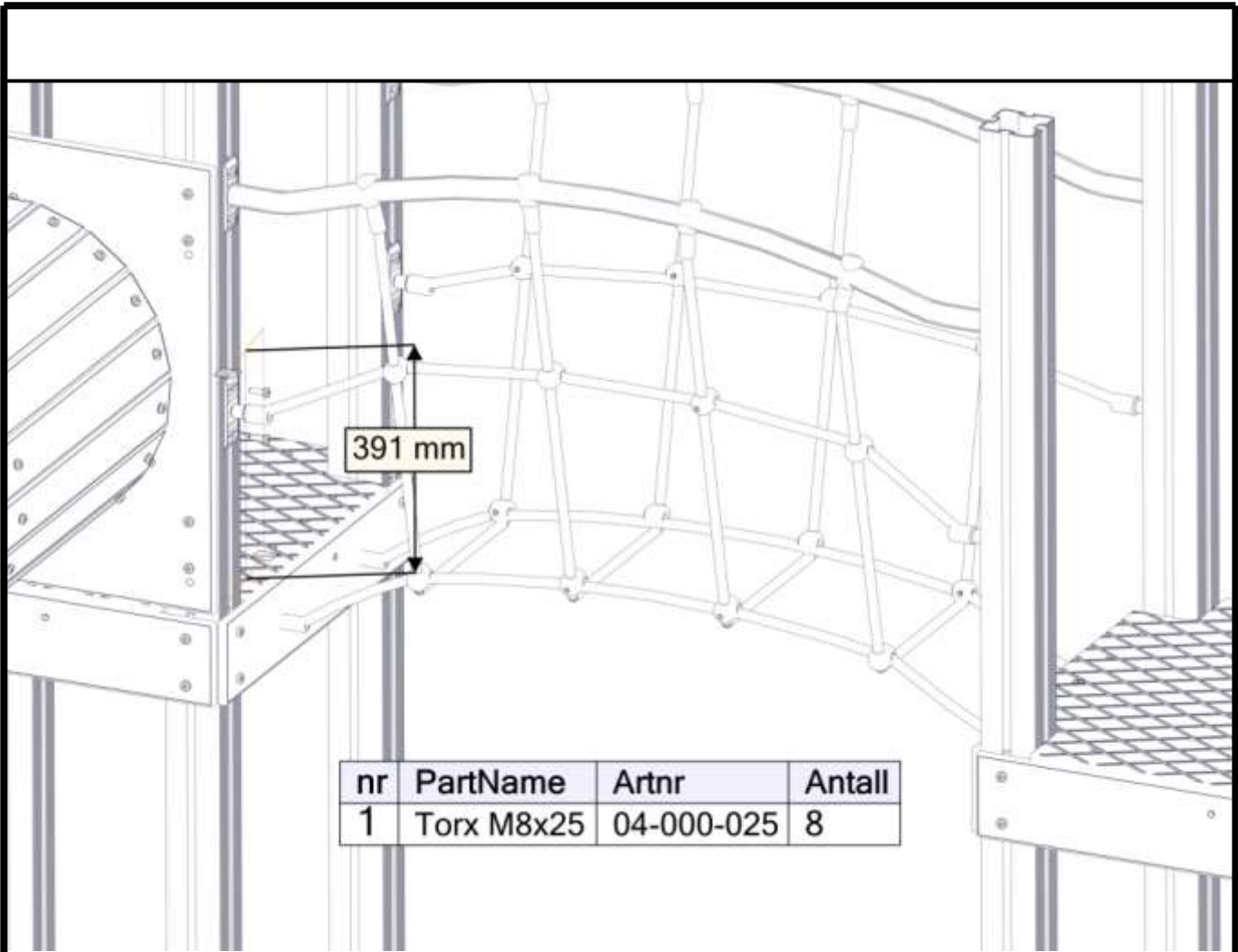

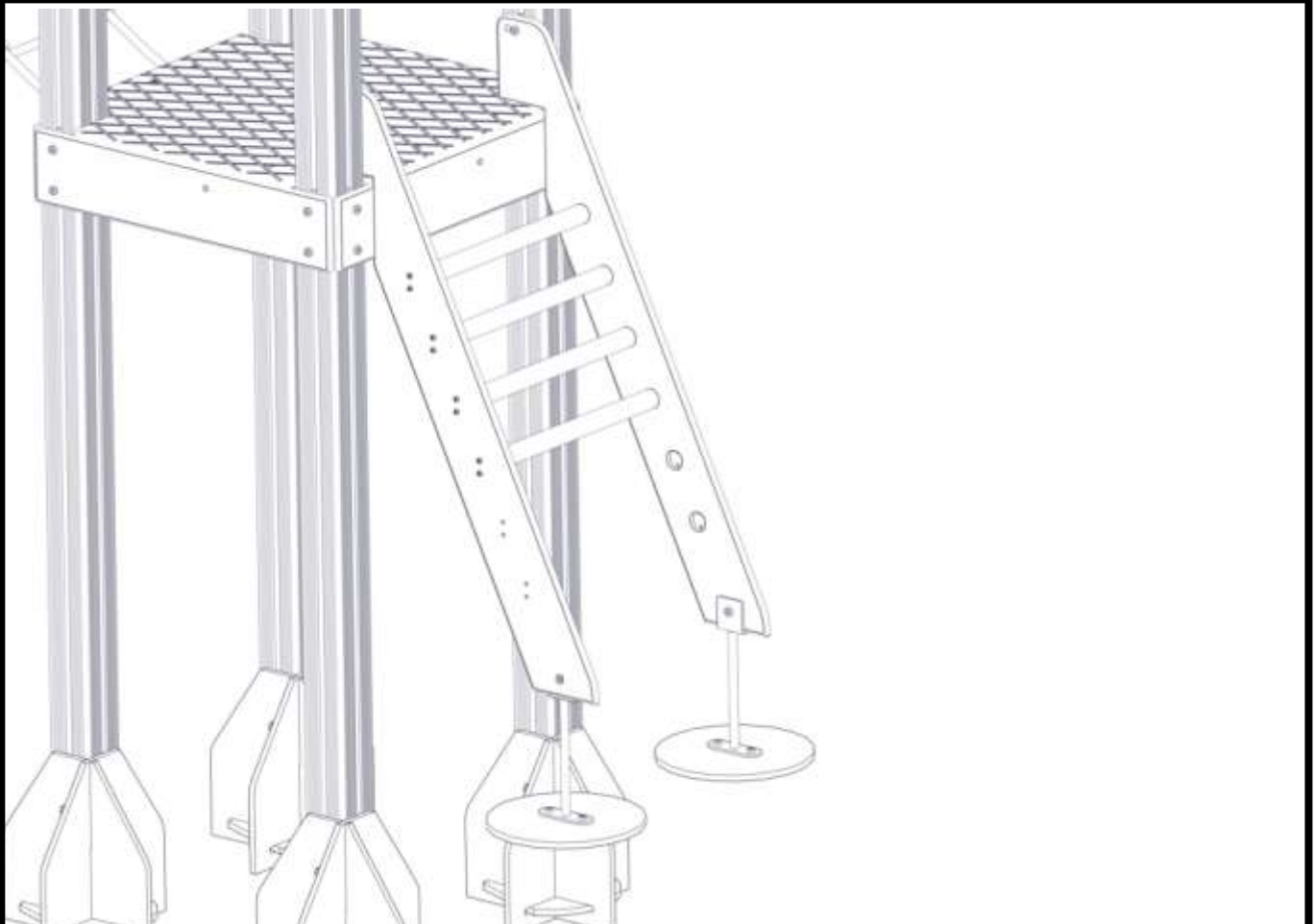
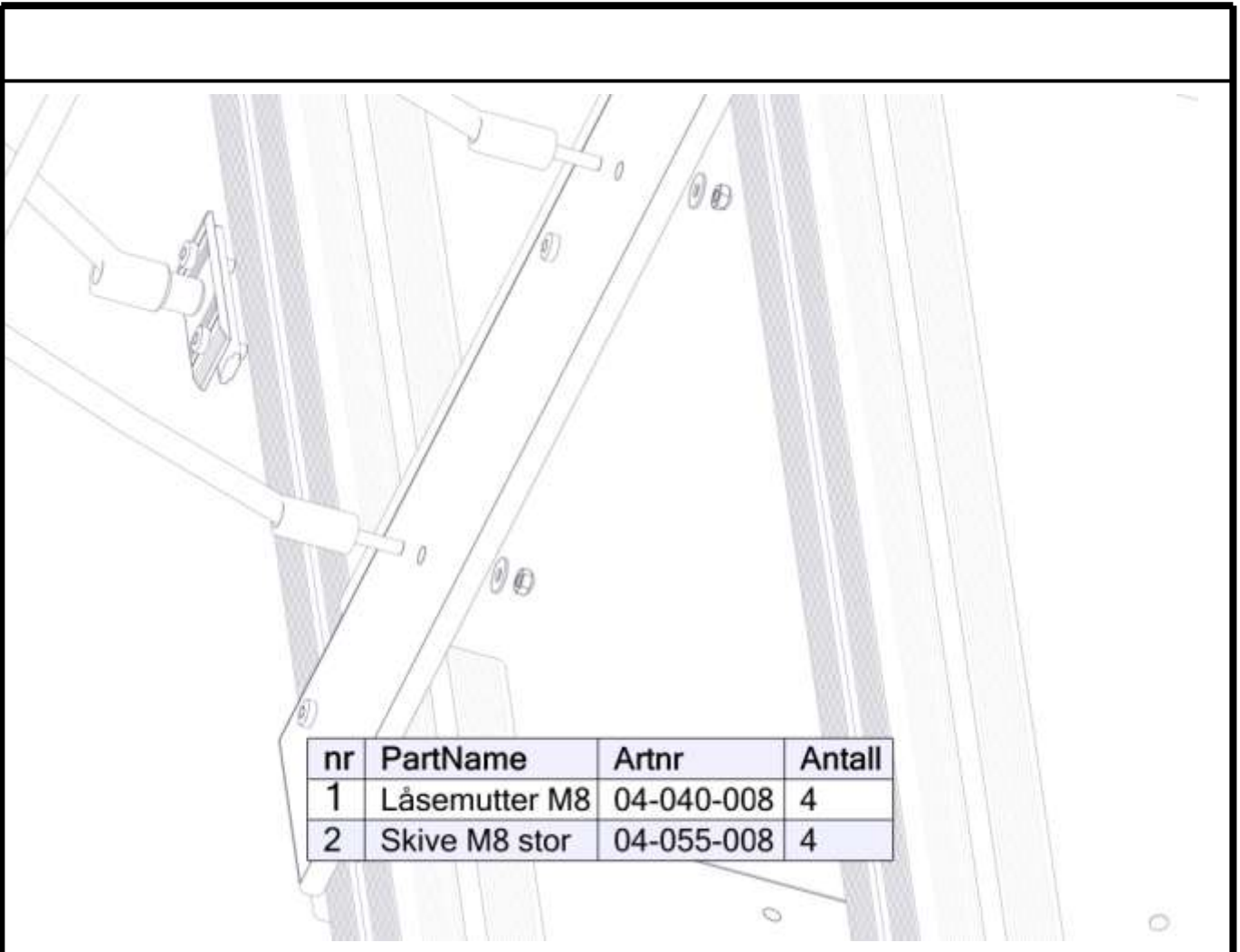

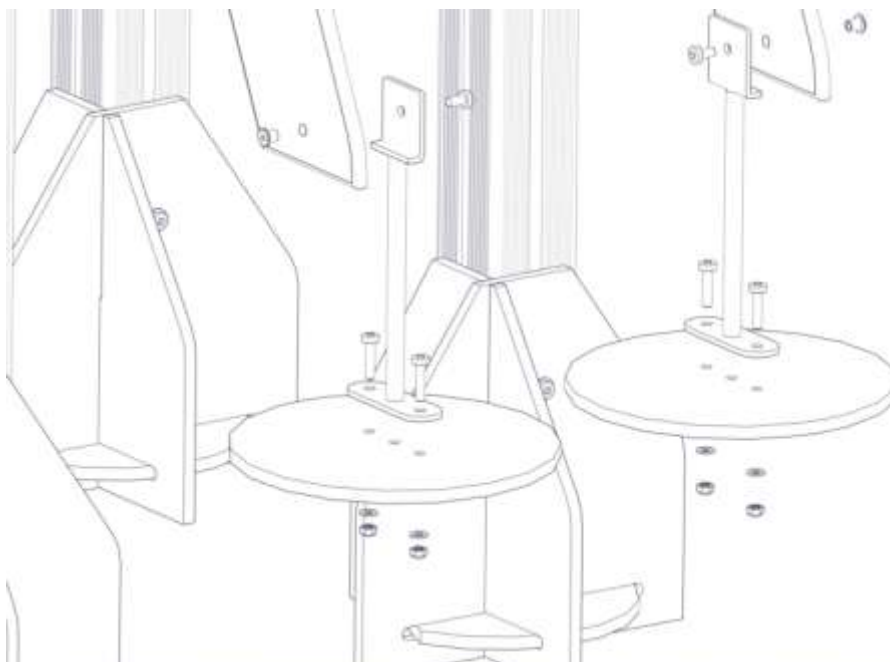
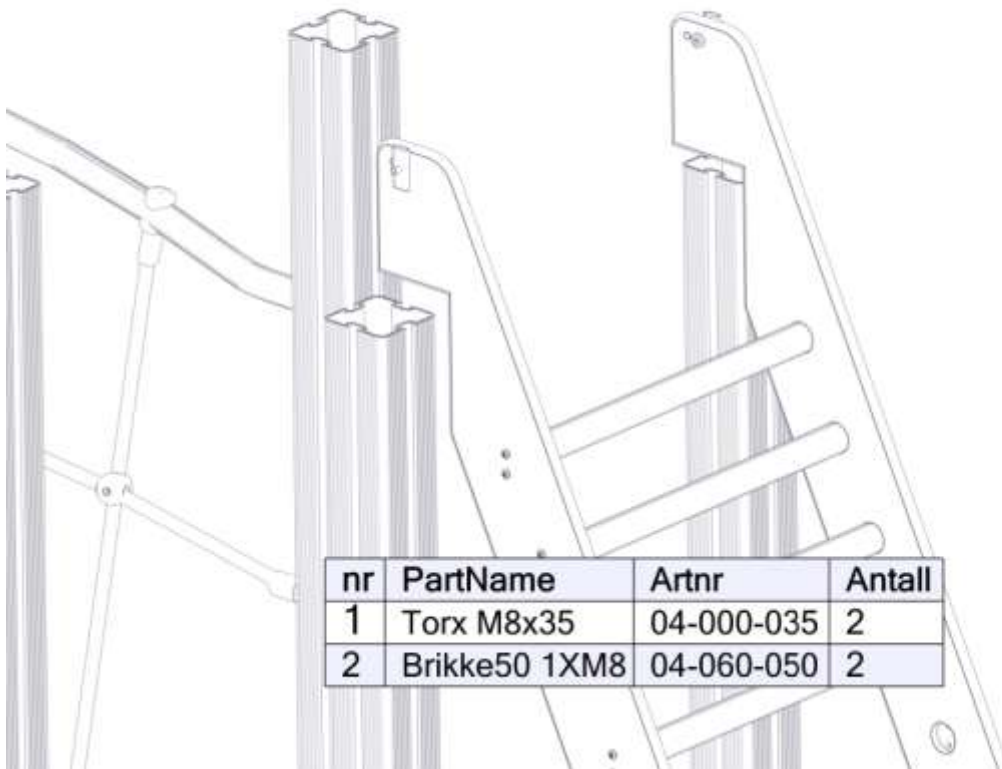

nr	PartName	Artnr	Antall
1	Fundament plate	00-003-106	2
2	Stålforankring 300	00-100-312	2
3	Torx M8x16	04-000-016	2
4	Torx M8x35	04-000-035	4

nr	PartName	Artnr	Antall
5	Møbelknapp 16x11	04-030-011	2
6	Låsemutter M8	04-040-008	4
7	Skive M8	04-050-008	4

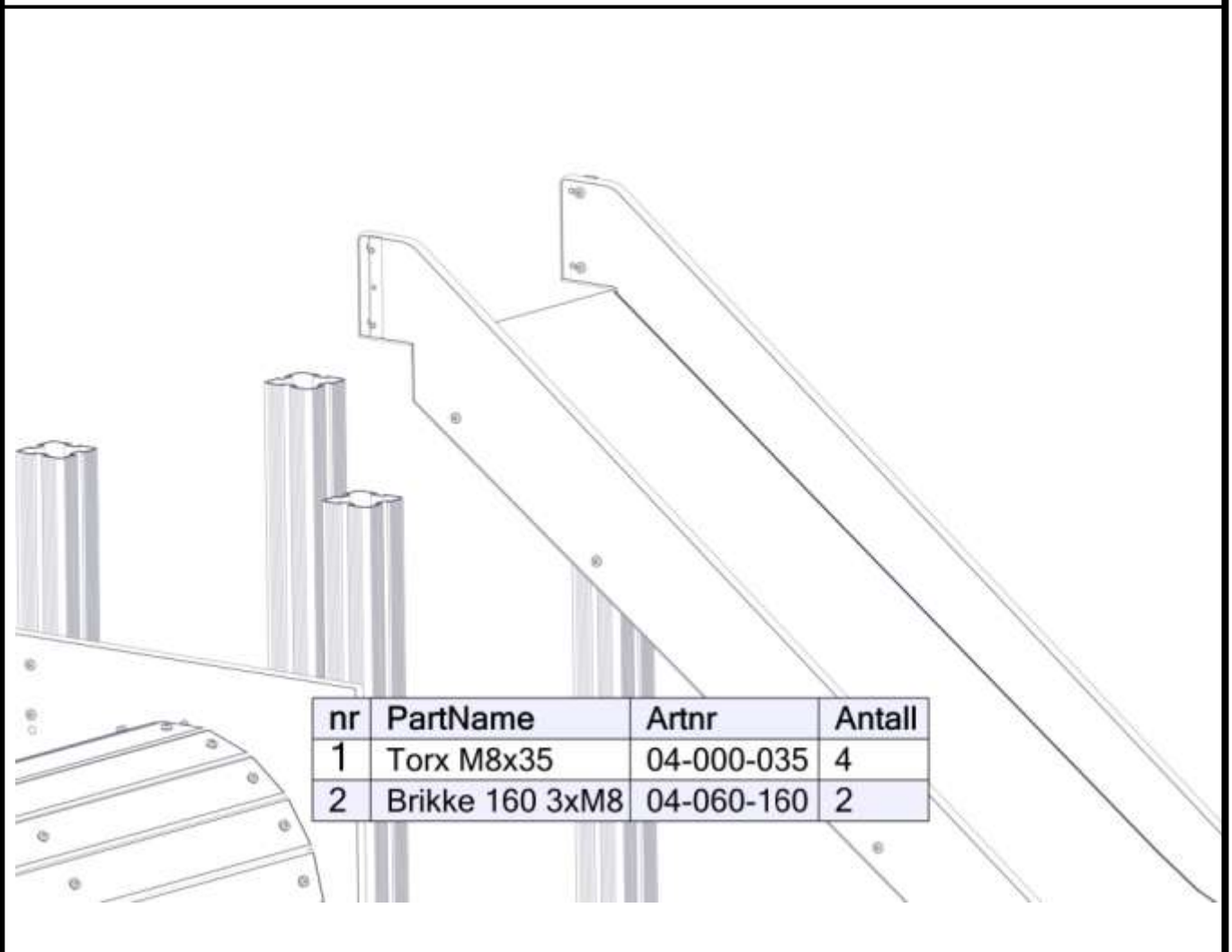
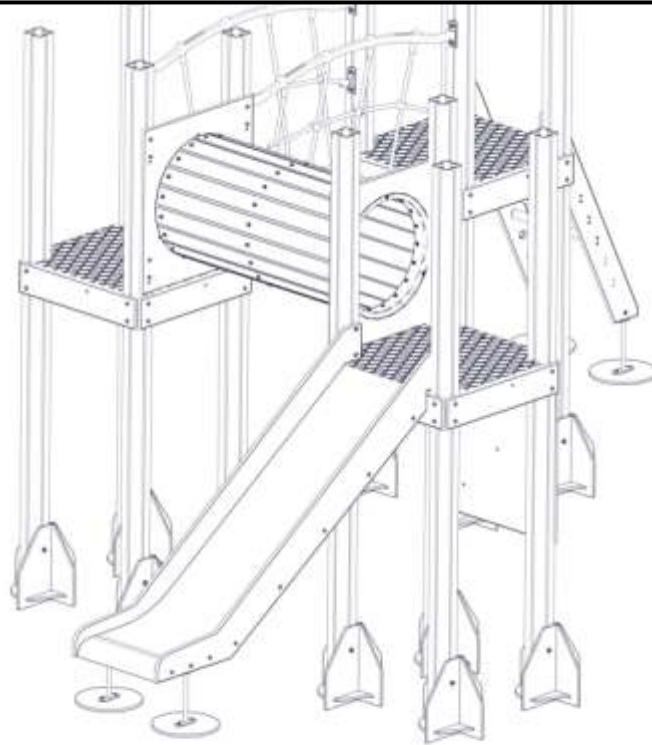

nr	PartName	Artnr	Antall
1	Torx M8x35	04-000-035	4
2	Brikke 160 3xM8	04-060-160	2

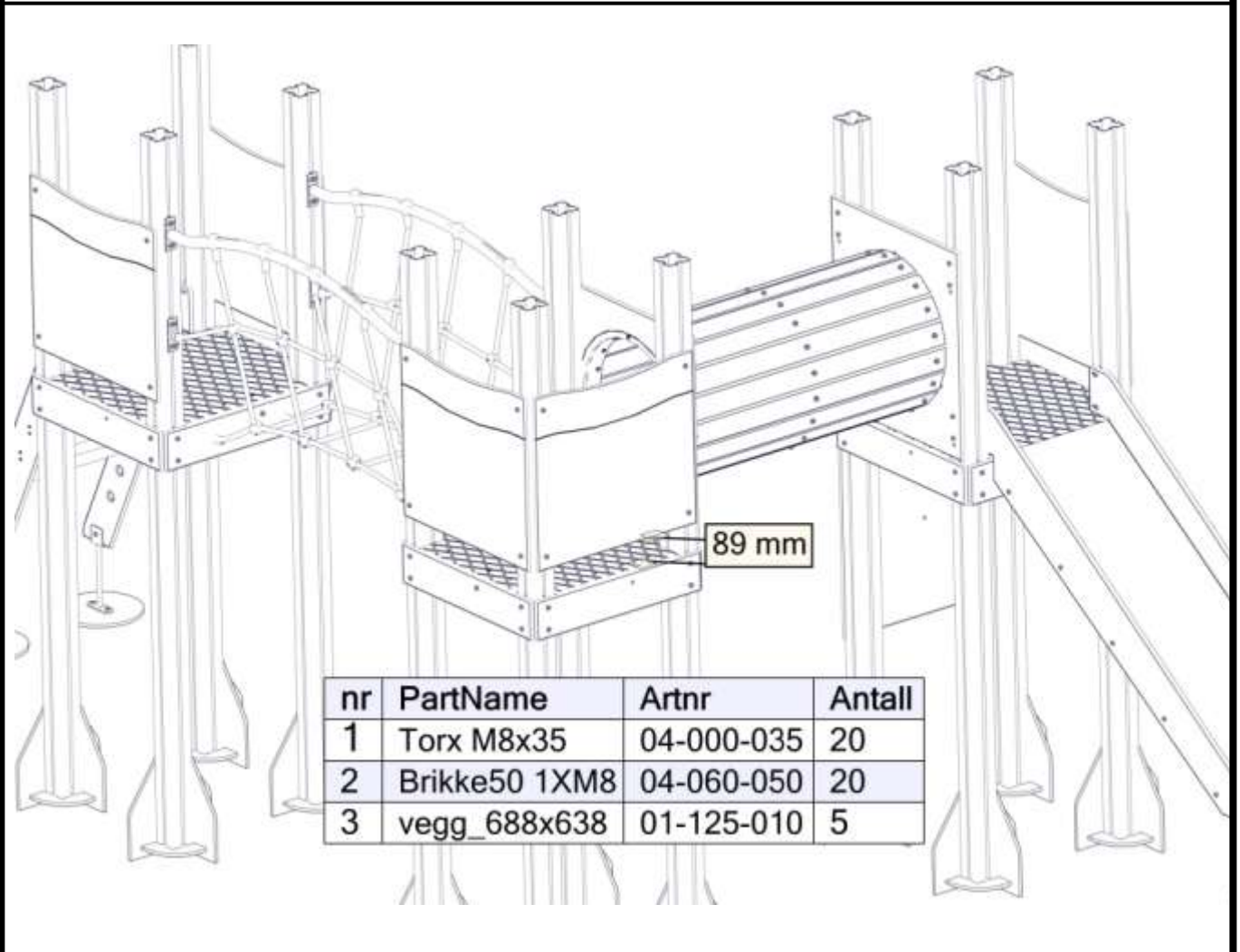
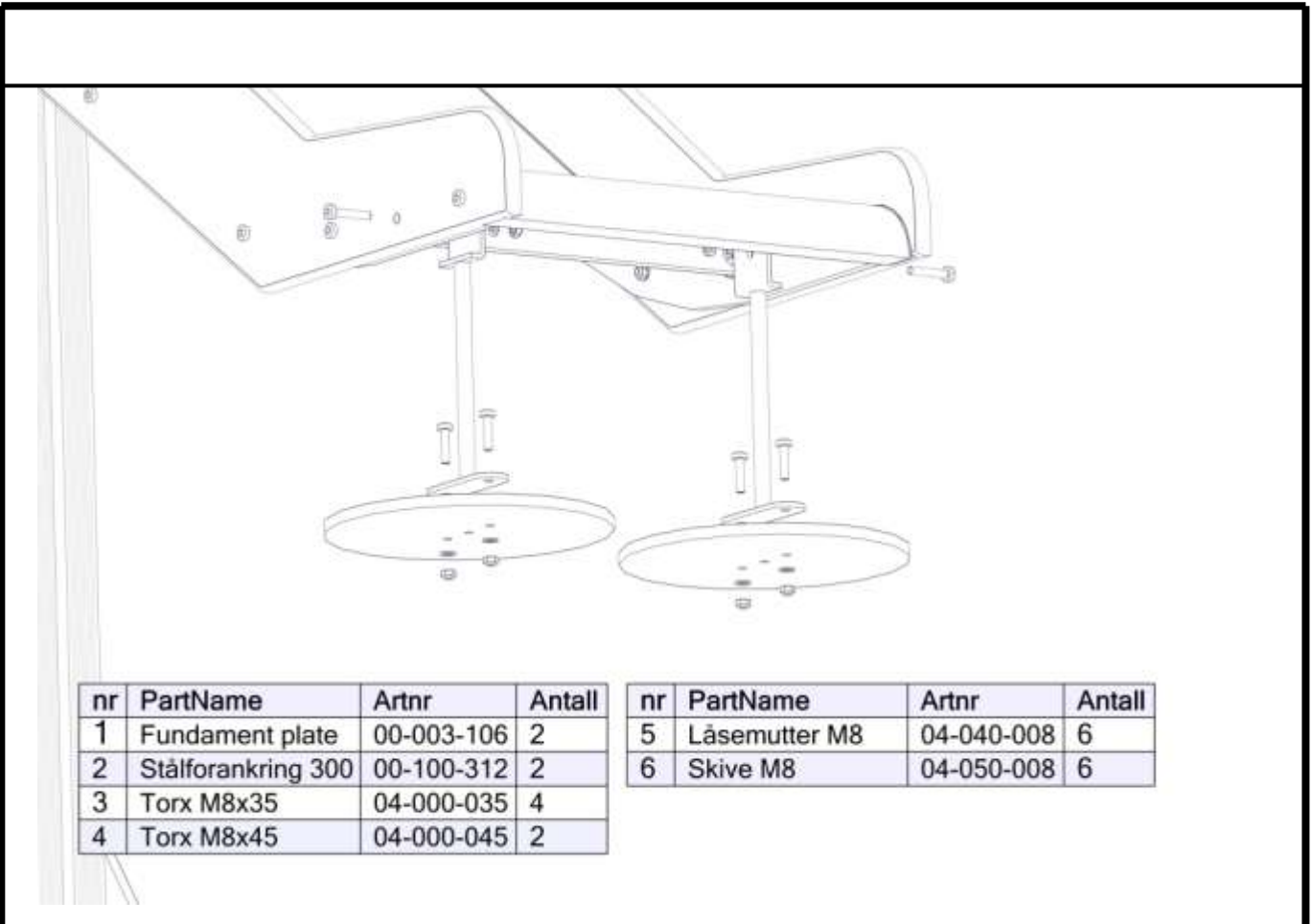

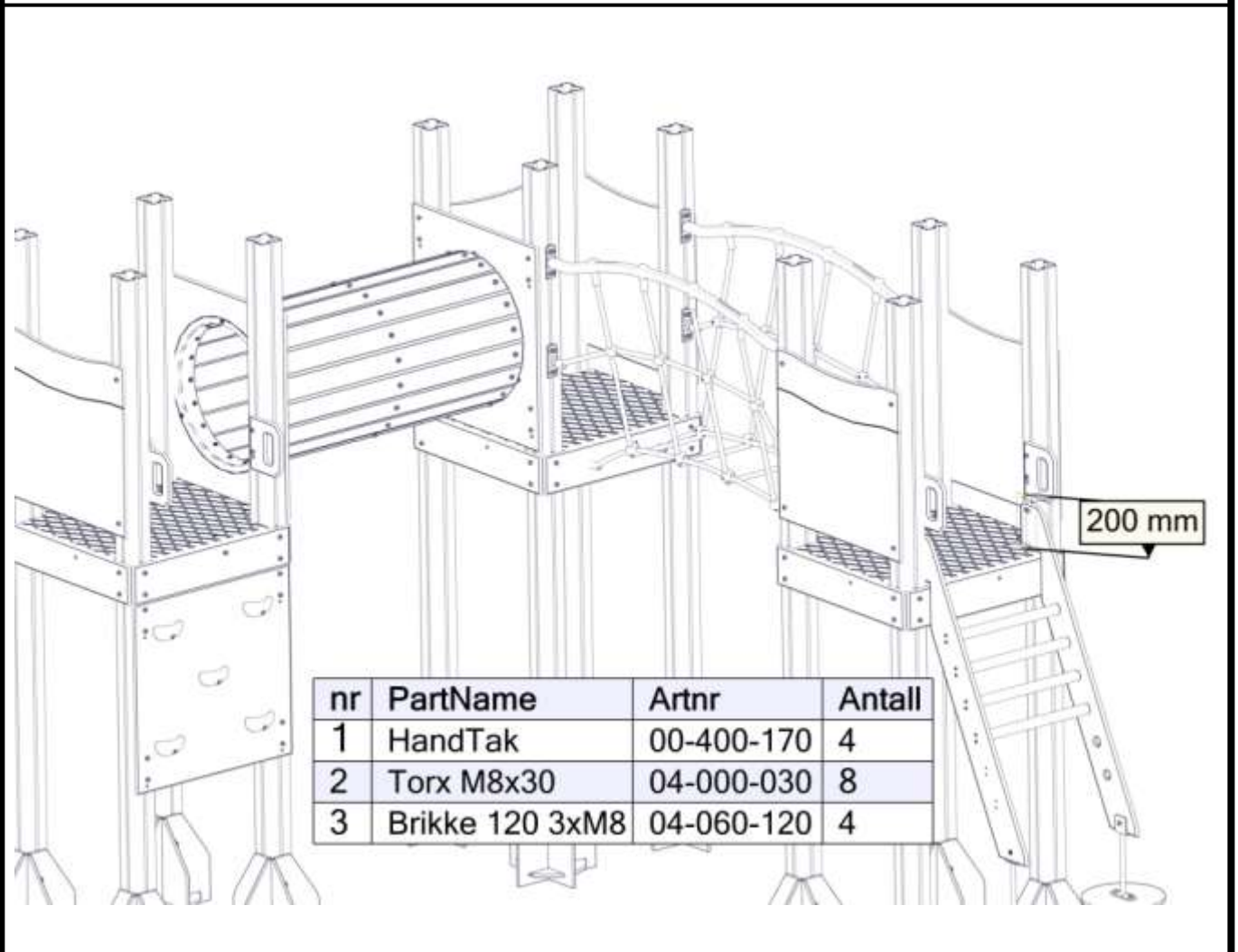
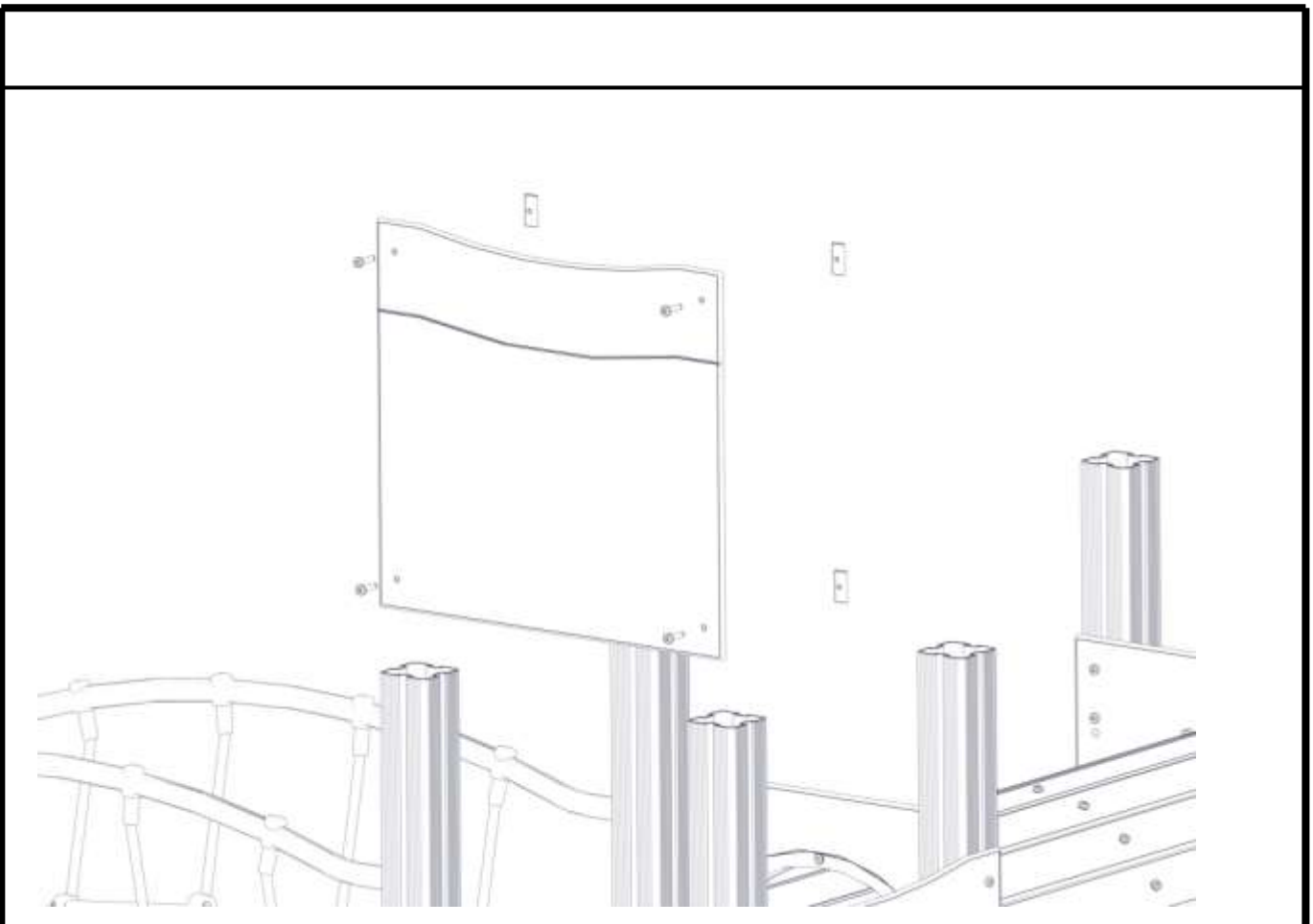

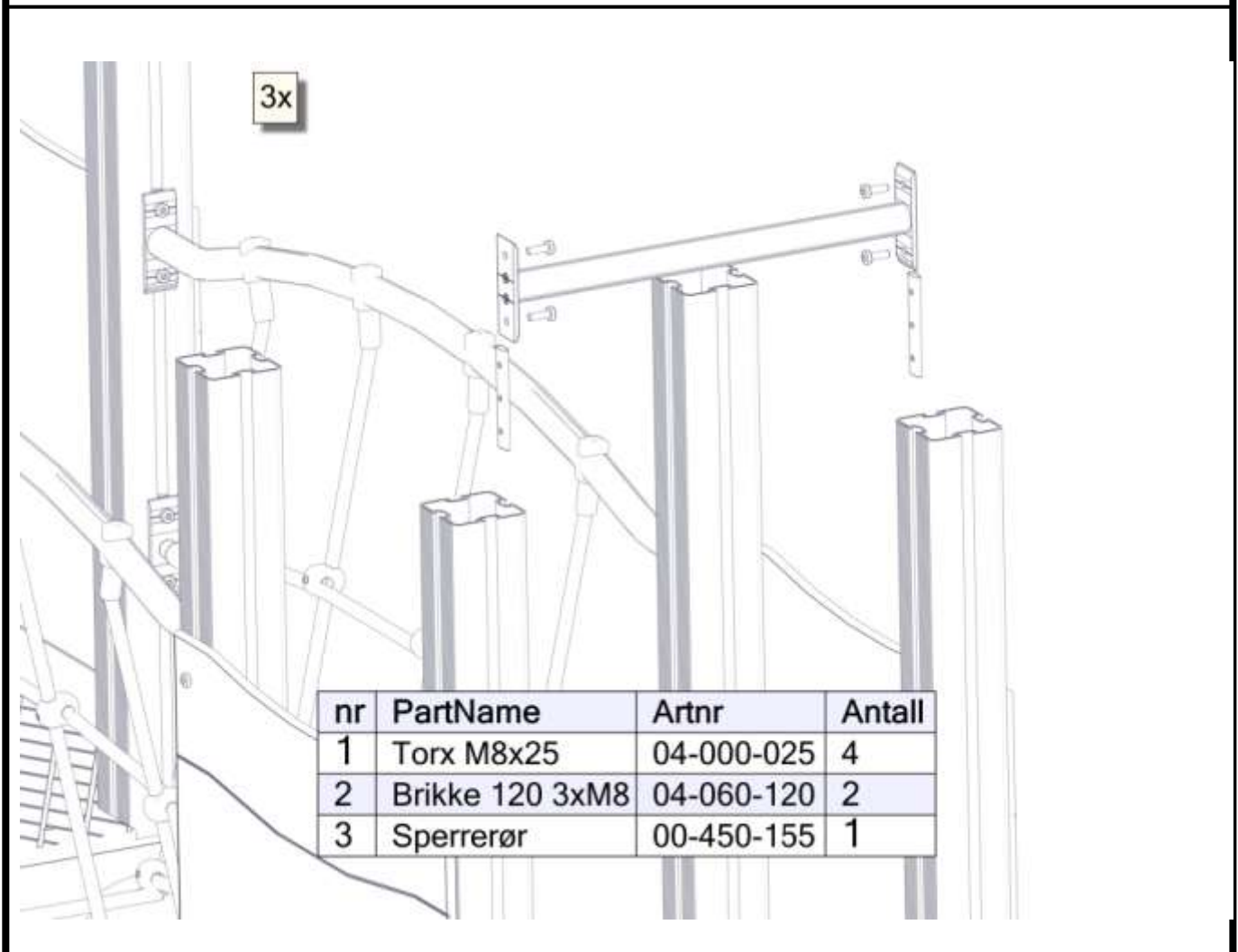
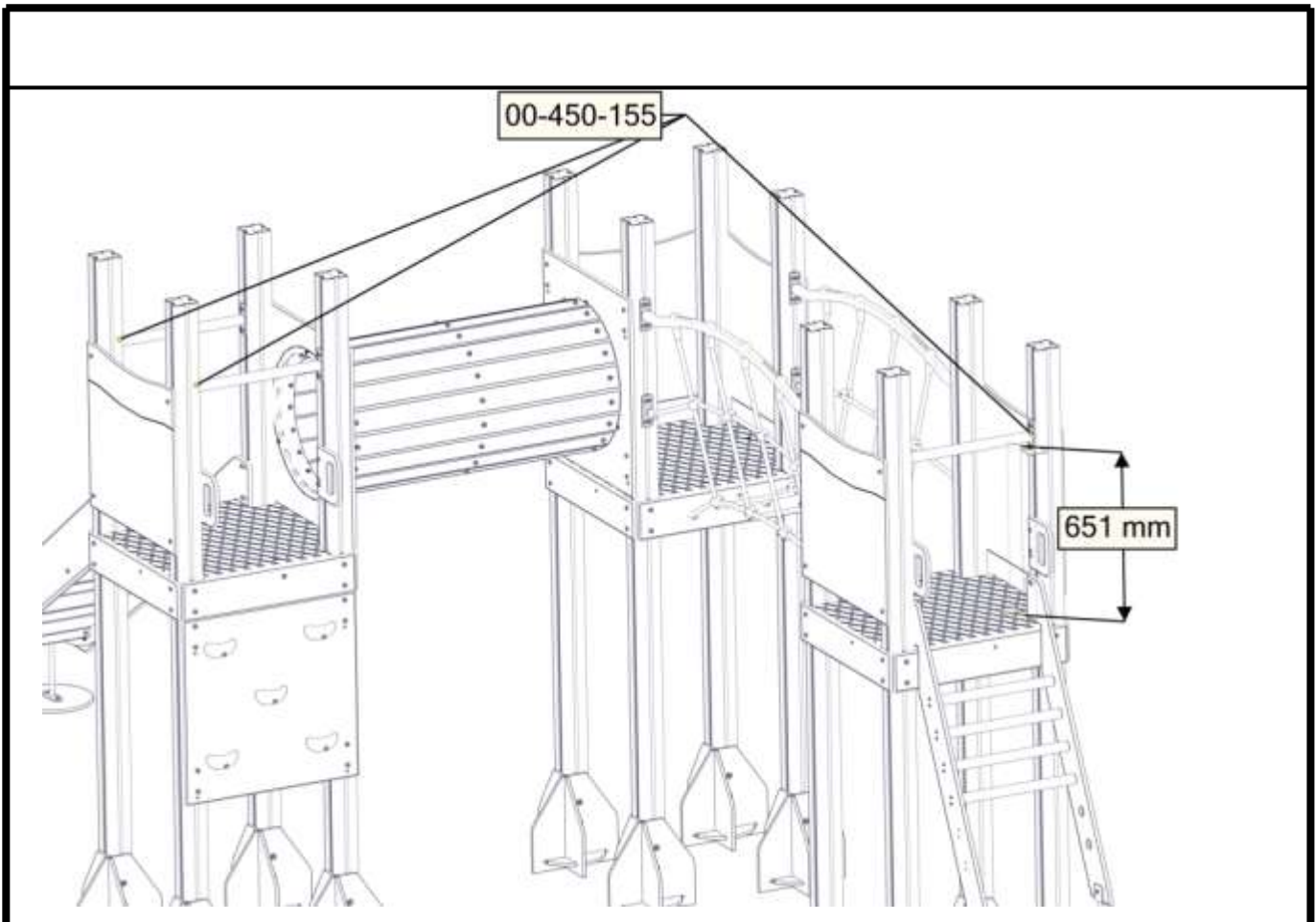

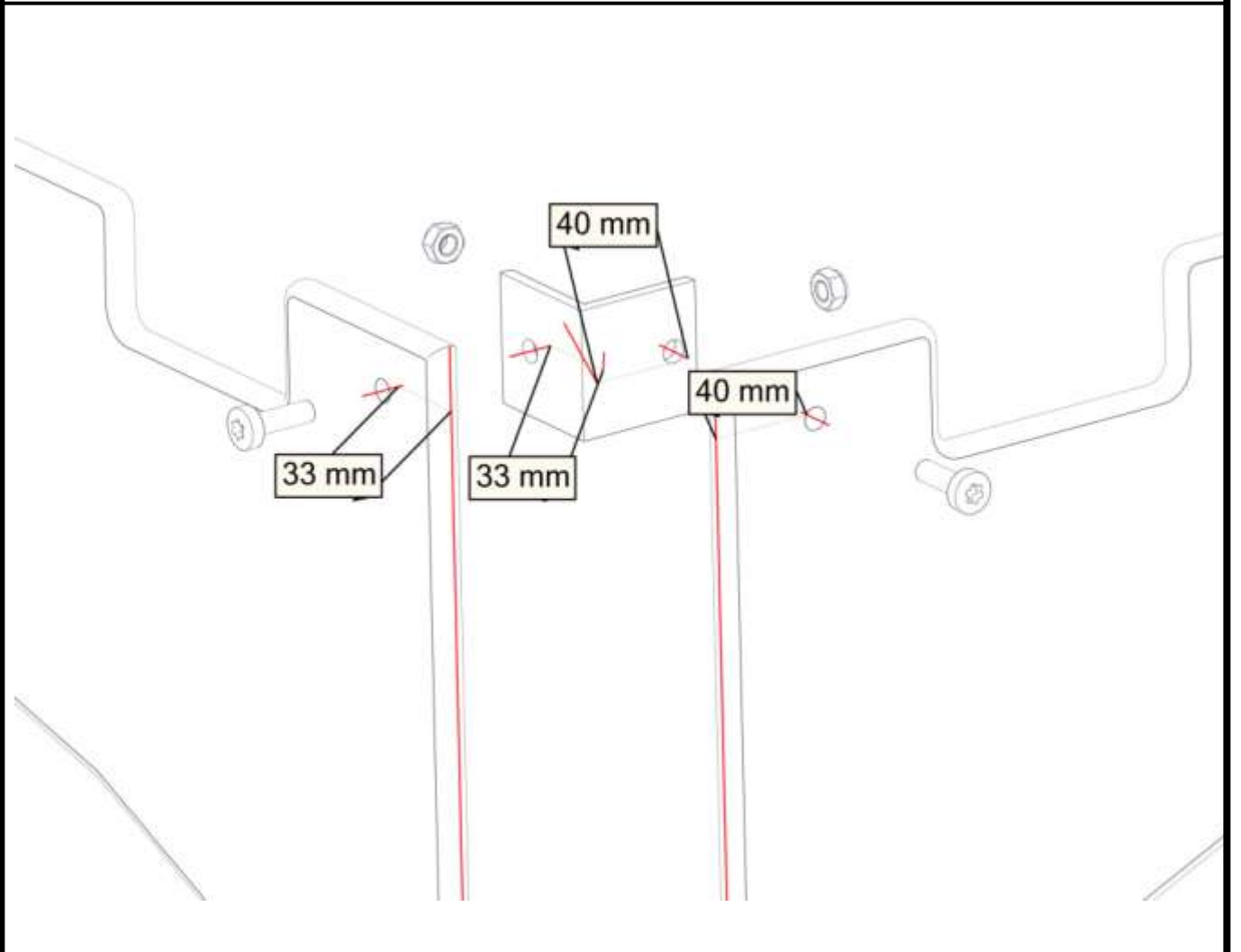
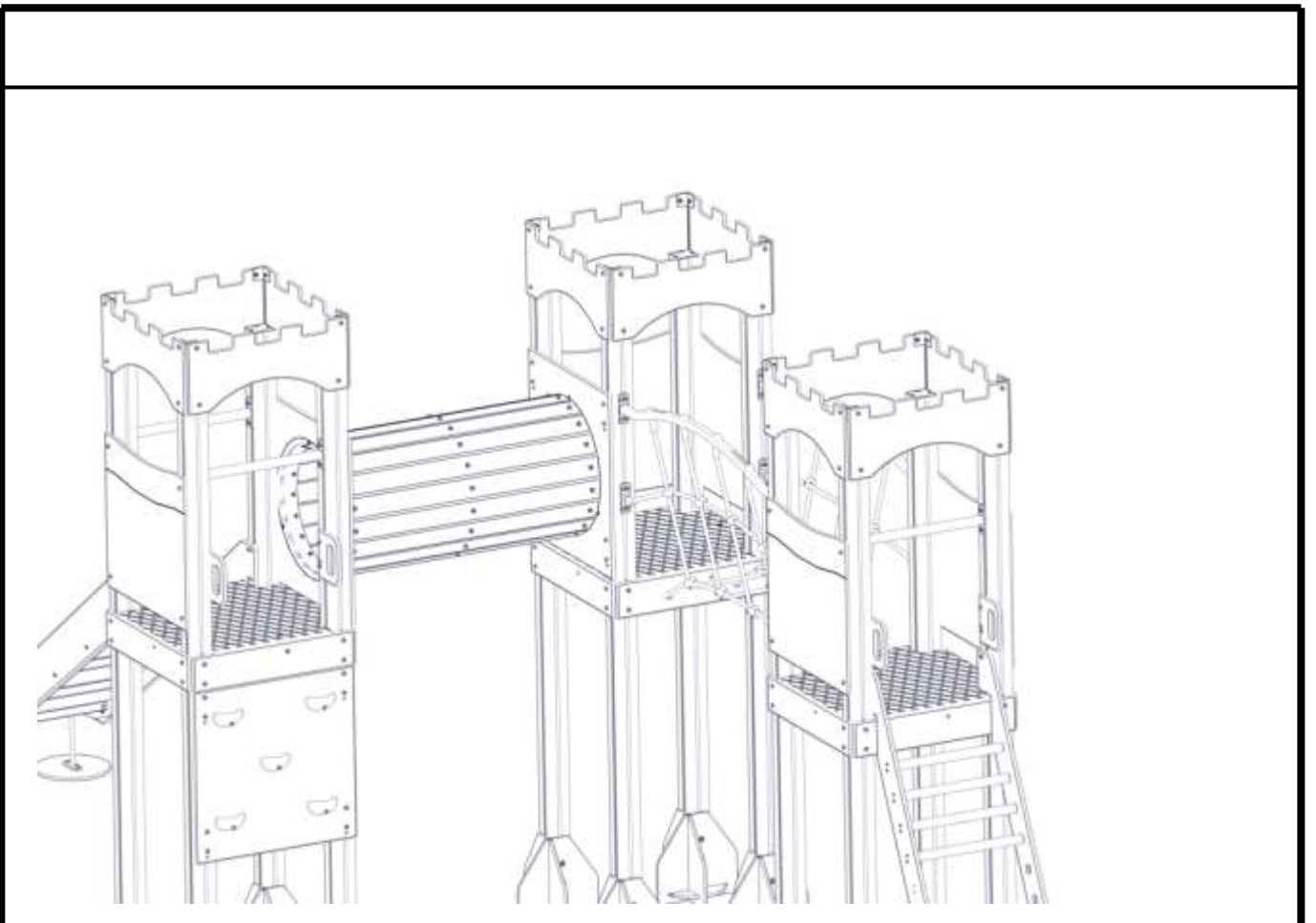

3x

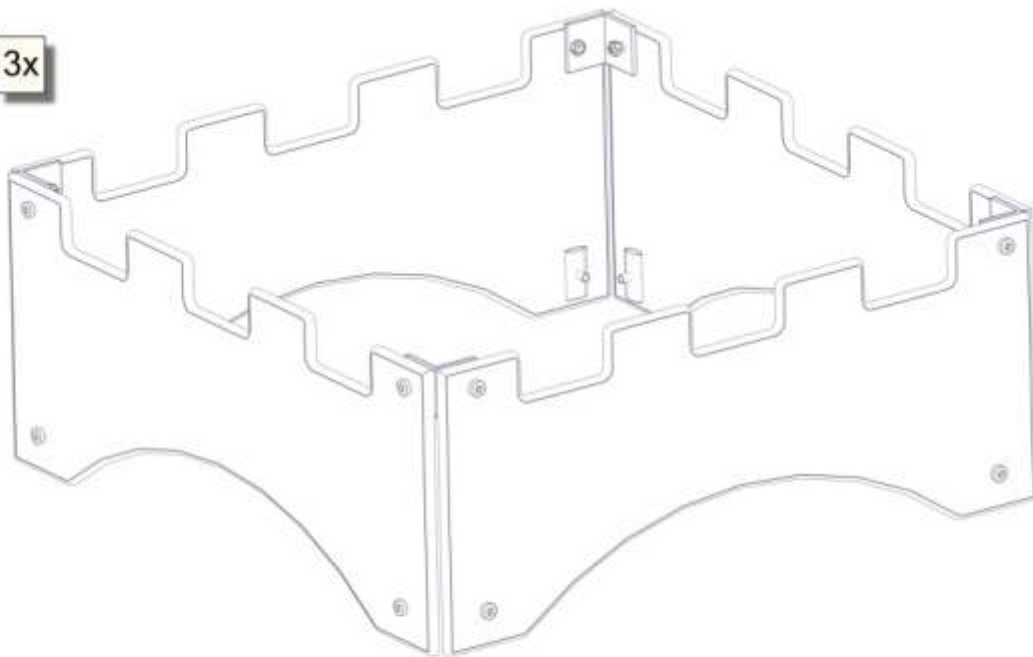

nr	PartName	Artnr	Antall
1	Tårn 710x300x12	01-450-502	4
2	Torx M8x25	04-000-025	8
3	Torx M8x35	04-000-035	8
4	Låsemutter M8	04-040-008	8



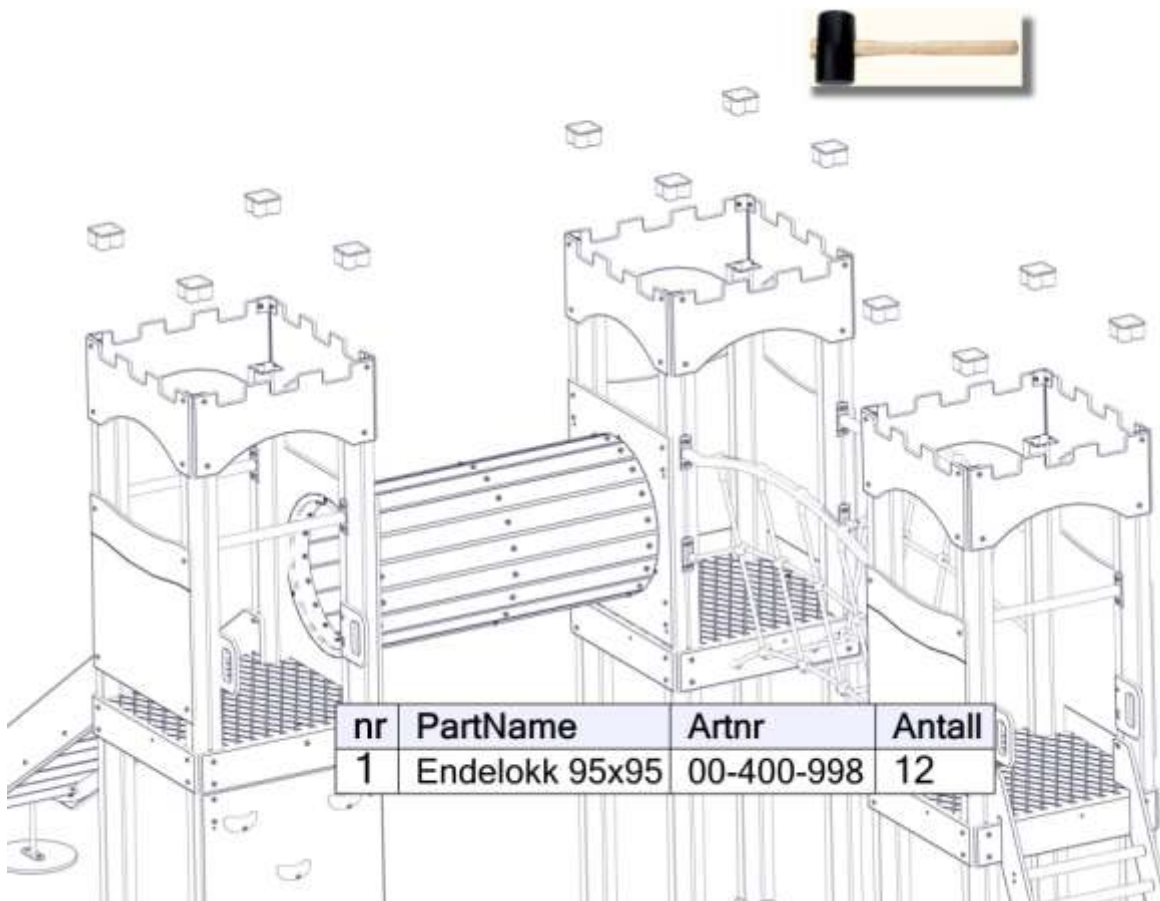

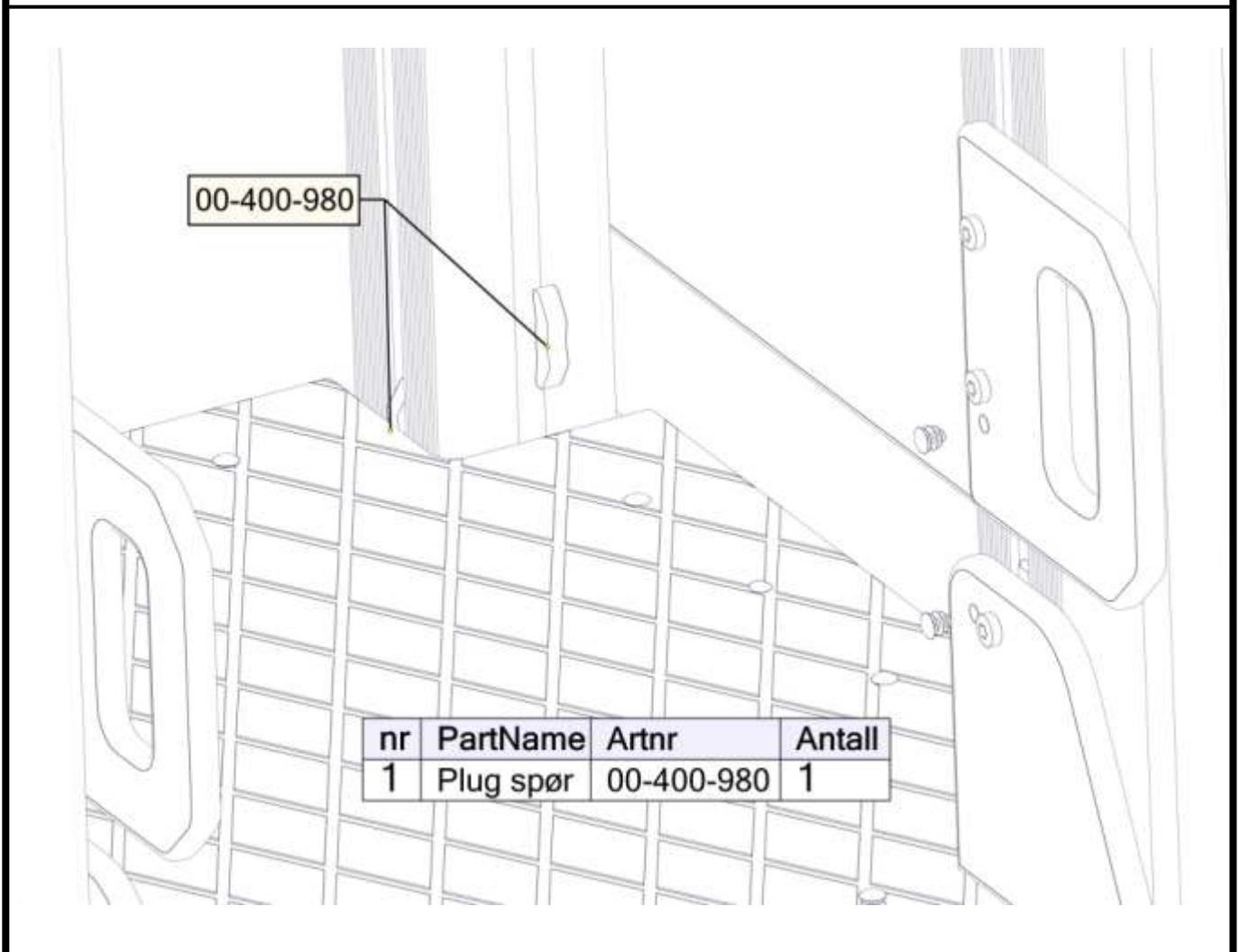
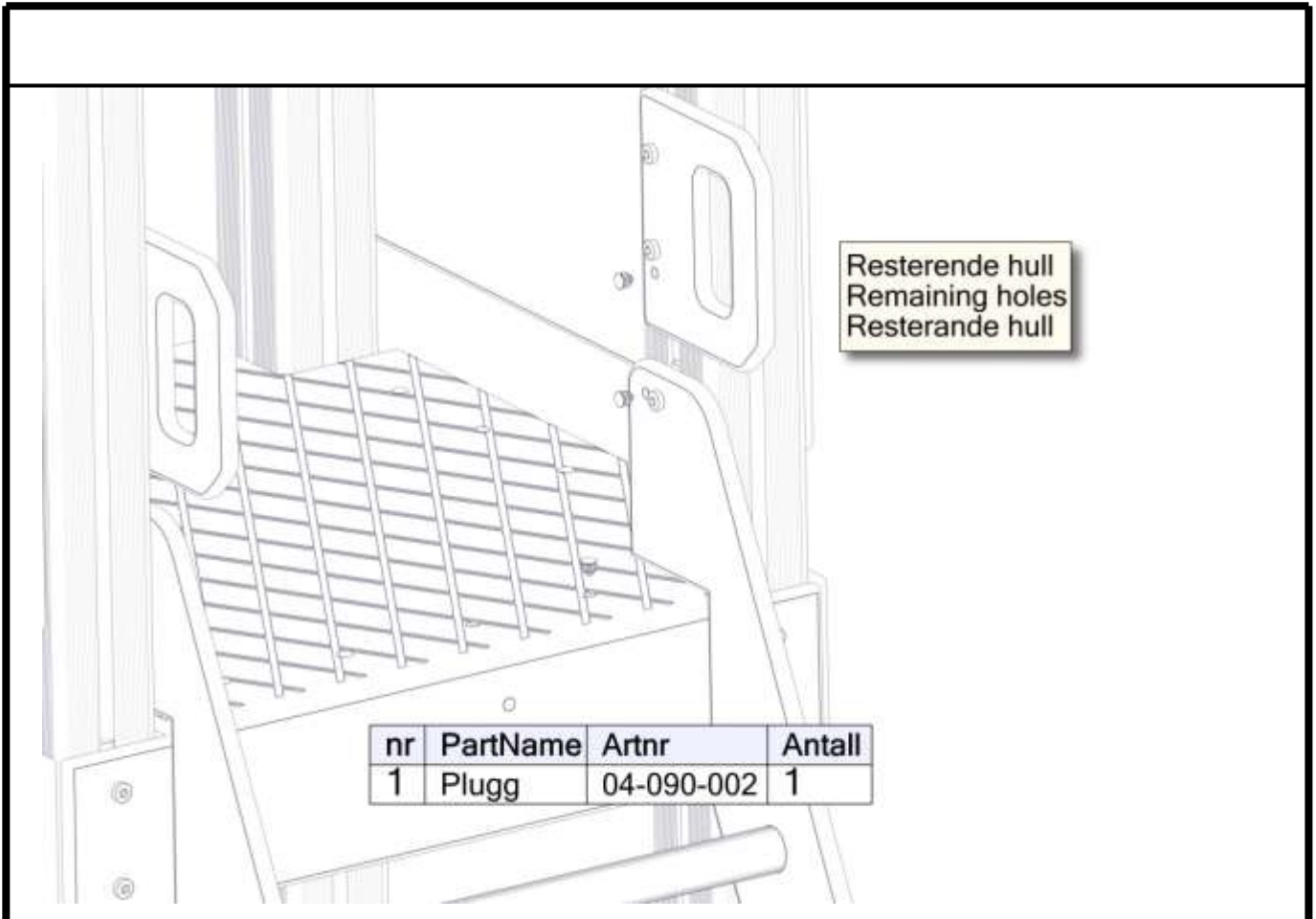

nr	PartName	Artnr	Antall
5	Brikke50 1XM8	04-060-050	8
6	Vinkel 50x50x50x5 9mm hull	04-075-050	4





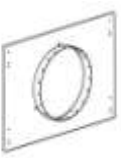









nr	PartName	Artnr	Antall
1	Endelokk 95x95	00-400-998	12



Før utstyret tas i bruk / Before play begins / Innan lekredskapet tas i bruk	
N	<ul style="list-style-type: none"> ● Påse at fallunderlag er utlagt i henhold til gjeldende regler eller vår anbefaling ● Fjern alle monteringshjelpemidler (rester av betong, planker, paller, plast, og lignende) ● Før utstyret tas i bruk, burde man sjekke at det ikke er fare for at anorakksnorer og lignende som kan hekte seg fast noen steder på lekeapparatet. (Vedlagte snor med dobbe (kneledd) kan brukes til å sjekke at dette er i orden. Se vedlagte veiledning for bruk av denne. Dette gjøres for å oppdage eventuelle feilmonteringer.?) ● NB! Bør stå i 2-3 dager før bruk
EN	<ul style="list-style-type: none"> ● Make sure the area and depth of safer surfacing are according to the current standard, or to the manufacturer's recommendation ● Make sure all tools and surplus materials are removed before play begins ● PS! When complete, allow 2-3 days for the concrete to set before use
S	<ul style="list-style-type: none"> ● Kontrollera att fallunderlag är utlagt enligt gällande regler eller vårt rekommendation ● Ta bort alla monteringshjälpmedel (rester av betong, plankor, pallar, plast och liknande) ● Innan lekredskapet används, kontrollera att anoracksnoddar eller kläder/delar av kläder eller liknande inte kan fastna i några delar på redskapet. (Den bipackade "knävringen" kan man med fördel användas för denna kontroll. ● Detta görs för att upptäcka eventuella felmonteringar.)

komponenter		Sign. _____
	VK95 L=2600 12 600-2000 00-400-010 VK95 L=3035 600-2435 00-400-053	Gulv 3 740x740x15 00-400-300
		Ende lokk 12 00-400-998
	Vegg 5 688x636x12 01-125-010	Fundametplate 4 00-003-106
	Sprosse 10 740x145x15 01-400-108	Sprosse 2 740x145x15 2 H cc300 01-400-109
	Tunell HPL plate liten 2 01-244-010	Tunell ring 1 01-243-011
	Tunell Sprosse 19 01-243-012 1130x89	Klatrevegg mini 1 01-450-762
	Nett bro inkl beslag 1 07-510-174	Rør bua 2 07-510-164
	Stige 950 1 00-400-615 4 trinn	Handtak 4 00-400-170

komponenter		Sign. _____.	
	Rursjebane 950 1 40-142-020		Spererør 520 3 00-450-155
	Tak tårn 12 01-450-502		
			Eventuelt funda- 12 menter
	M8x35 Brikke 120 Brikke 50	M8x35 04-060-120 04-060-050	36 12 12

komponenter		Sign. _____
	Torx M8x12 41 04-000-012	Brikke 50-1T 46 04-060-050
	Torx M8x16 19 04-000-016	Brikke 120-3T 30 04-060-120
	Torx M8x20 2 04-000-020	Brikke 160-3T 2 04-060-160
	Torx M8x25 60 04-000-025	
	Torx M8x30 37 04-000-030	
	Torx M8x35 96 04-000-035	
Torx M8x45 2 04-000-045		Låsemutter M8 41 04-040-008
	Møbelknapp 62 M8x13x17 04-030-011	Stålforankring 4 00-100-310
	Saddelwasher 16 04-210-010	
	Plast plug 64 9-11mm 04-090-002	
	Skive M8 71 04-050-008	Plug spor 24 00-400-980
	Skive M8 stor 4 04-055-008	
		Vinkel 50x50x50 19 04-075-050 9mm