

(N) Monteringsanvisning

(UK) Assembly Instructions

(S) Monteringsanvisning

Produkt nr. / Product no. / Produkt nr.

24-100-000

Ordr. nr. _____

Dato. _____

Sign. _____



Søve Lekemiljø AS
3830 Ulefoss - Norway
Tlf: +47 35 94 65 65
www.sove.no



Søve AB
412 50 Göteborg
Phone: +46 (0)31 773 97 00
www.sove.se

17.10.2011

1**Monteringstips / Assembly Advice / Monteringsstips****N**

- ☑ Les monteringsanvisningen nøye før montering.
- ☑ Monter elementene i rekkefølgen som vist.
- ☑ Boltene bør ikke skrues for hardt til før alt er montert, vatret og loddet. Skru så boltene til.
NB! Ved bruk av drill, kan boltene ryke.
- ☑ På grunn av at solen kan gjøre rutsjeflaten veldig varm, bør rutsjebanens utløp vende mot nord-øst eller nord-vest.
- ☑ Er lekeutstyret plassert i naturlige ferdselstraséer må området sikres mot spontan gjennomgang.
- ☑ Innspringningshinder bør vurderes rundt lekeapparater hvor det er stor bevegelse, f.eks. ved huskestativ.
- ☑ Det bør være fritt innsyn til lekeutstyr som er beregnet for barn under 3 år.

NB! Under monteringsarbeidet må utstyr, som ikke er forankret forsvarlig i bakken, avstives slik at det ikke velte. Området må avstenges under oppsettelse av apparatene med sperrebånd eller lignende.

UK

- ☑ Read the instruction carefully before assembling the play unit.
- ☑ Assemble the components in the sequence shown in these instructions.
- ☑ Fixings must not be fully tightened during assembly. Before casting the foundations, the structure must be level and plumb, at which point all fixings are tightened.
- PS! If use of drill, the bolts may be wrecked.
- ☑ Avoid positioning the slide facing due south because of overheating – ideal positions are facing north-east or north-west.
- ☑ Secure the construction-area to prevent people from walking through it.
- ☑ Consider installing barriers around play-equipment which gives rise to a lot of activity – i.e.swings.
- ☑ Ensure that clear vision is possible across the play area so that supervision is possible from any position, particularly where children under 3 years of age will be playing.

NB! During assembly of the equipment, ensure that all structures are securely propped, especially when left overnight. Also ensure that equipment is supported whilst concrete foundations are setting and enclose the area securely to prevent access.

☒ Läs monteringsanvisningen noga före montering.

☒ Montera delarna i den ordningen som anvisas

☒ Skruvarna bör inte skruvas för hårt tills allt är monterat, i våg och lodat.

OBS! Används elektrisk skruvdragare, kan bulten gå sönder. Hårdra därför manuellt!

☒ Solen kan göra att rutchbanan blir väldigt varm. Banans nedfart rekommenderas att vändas i norrlig riktning

☒ Om lekplatsen placeras vid en gångväg mm bör området säkras mot genomfart av gående och cyklister.

☒ Inspringningshinder bör placeras runt lekutrustning med stor rörelse, t ex, gungställning.

☒ Det bör vara fri insyn till lekutrustning beräknat till barn under 3 år.

OBS! Under monteringsarbete bör utrustningen som inte ska förankras i marken, ställs så att den inte kan välta.

Området måste spärras när lekutrustningen byggs upp, med avspärrningsband eller liknande.

2

Nødvendig verktøy / Tools required / Nödvändiga verktyg

N
UK
S

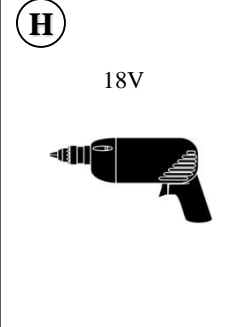
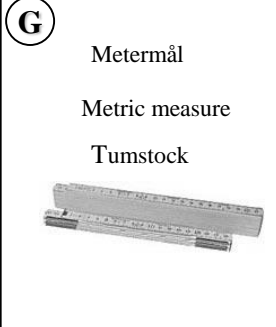
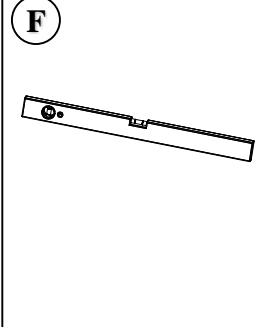
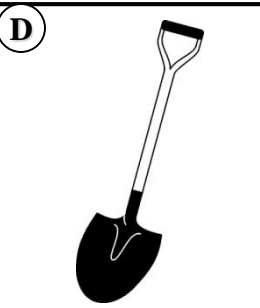
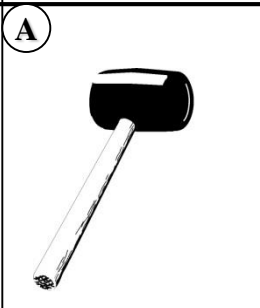

3

Nødvendig antall personer / Number of persons required / Lämpligt antal personer

N
UK
S

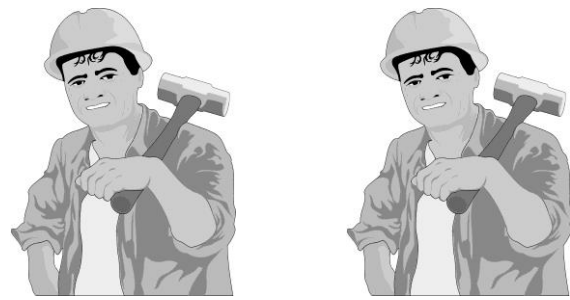



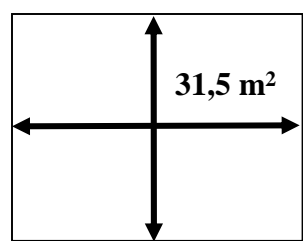

4

Anbefalt arealbehov ved montering / Recommended working space / Rekommenderad arealbehov vid montering

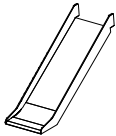
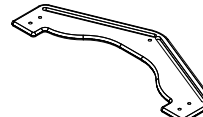
N
UK
S

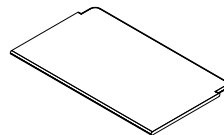
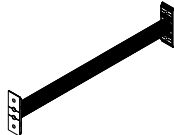
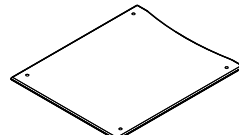
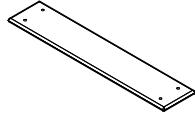
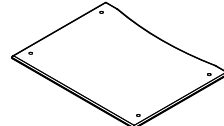
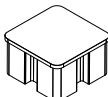
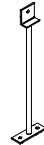
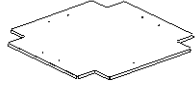
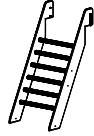
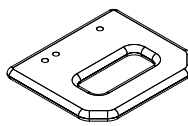



N UK S	Komponenter	Dimensjon	Ant	Lev	Komponenter	Dimensjon	Ant	Lev
	Components	Dimension	Qty	Lev	Components	Dimension	Qty	Lev
	Komponenter	Dimension	Ant	Lev	Komponenter	Dimension	Ant	Lev
	40-142-020 	520 x 2193	1		00-450-533 	710 x 270 x 15	2	
	00-400-006 	2600 x 95 x 95	4		00-450-532 	730 x 430 x 15	2	
	00-450-155 	520 x 120 x 40	2		00-460-001 	520 x 620 x 12	2	
	01-450-111 	710 x 145 x 15	4		00-460-002 	520 x 400 x 12	2	
	00-400-998 	55 x 95 x 95	4		00-100-310 	512 x 120	4	
	00-400-997 Med hull		4					
	00-450-305 	740 x 740 x 15	1		00-450-615 	1260 x 520 x 174	1	
	00-400-170 	172 x 200 x 15	2					
	00-450-148 	710 x 37	1					5

5



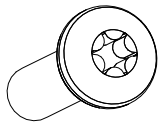
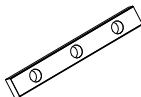
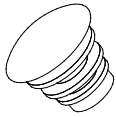







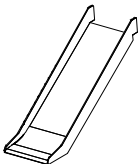

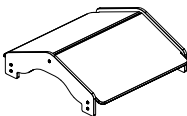







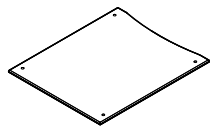

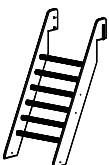



Pakkliste for / Parts list for / Packlista för :
24-100-000

Sign. _____

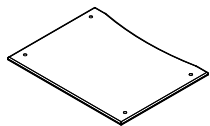
N UK S	Bolter/skruer Bolts/Screws Komponenter	Dimensjon Dimension Dimension	Ant Qty Ant	Lev Lev	Bolter/skruer Bolts/Screws Bultar/Skruvar	Dimensjon Dimension Dimension	Ant Qty Ant	Lev Lev
		04-000-025 8 x 25 mm Torx 04-000-035 8 x 35 mm Torx	8 20			04-060-120 120 x 15 x 8 mm	6	
	04-090-002	8						
	04-400-980	4						

N
UK
S

Boltepakker for / Boltpackage for / Bultpaket för 24-100-000









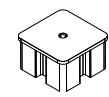

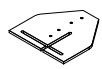

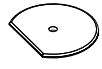

<p>40-142-020</p>  <p>Antall Number Antal</p>	 <p>04-060-120 120 x 15 x 8 mm</p>	2	<p>00-450-531</p>  <p>Antall Number Antal</p>	 <p>04-060-120 120 x 15 x 8 mm</p>	4
	 <p>04-000-045 8 x 45 mm Torx</p>	2		 <p>04-000-035 8 x 35 mm Torx</p>	8
	 <p>04-000-035 8 x 35 mm Torx</p>	2		 <p>04-000-045 8 x 45 mm Torx</p>	2
	 <p>04-040-008 Låsemutter M8</p>	2		 <p>04-090-001 8 mm</p>	2
<p>00-460-001</p>  <p>Antall Number Antal</p>	 <p>04-060-040 40 x 15 x 8 mm</p>	8	<p>00-450-615</p>  <p>Antall Number Antal</p>	 <p>04-060-040 050 x 15 x 8 mm</p>	2
	 <p>04-000-025 8 x 25 mm Torx</p>	16		 <p>04-000-016 8 x 16 mm Torx</p>	2
	 <p>04-076-050 50 x 50 x 5 mm</p>	8		 <p>04-000-035 8 x 35 mm Torx</p>	2
	 <p>04-040-008 8 mm</p>	8		 <p>04-030-016 8 x 16 mm</p>	2
<p>00-460-002</p>  <p>Antall Number Antal</p>	 <p>04-060-040 40 x 15 x 8 mm</p>	8	<p>Antall Number Antal</p>	 <p>04-090-002</p>	6
	 <p>04-000-025 8 x 25 mm Torx</p>	16		<p>Monteringsanvisning Assembly Instructions Monteringsanvisning</p>	1
	 <p>04-076-050 50 x 50 x 5 mm</p>	8			
	 <p>04-040-008 8 mm</p>	8			

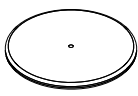
Forankring / Foundations / Markförankring

00-003-003

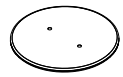
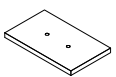
- N Er bestilt Ikke bestilt
- UK In order Not in order
- S Beställt Ej beställt

00-400-997 	-4
---	-----------

	 00-003-100  00-003-101  00-003-102		4			 04-000-035 8 x 35 mm Torx	12	
						 04-050-008 8 mm	12	
						 04-060-120 120 x 15 x 8 mm	8	
	00-003-103 		0			 04-000-040 8 x 40 mm Torx	0	
						 04-040-008 8 mm	0	
						 04-050-008 8 mm	0	
Eller Or Eller	00-003-105  00-003-106 		4			 04-010-035 10 x 35 mm	8	
						 04-040-010 10 mm	8	
						 04-050-010 10 mm	8	

6

Fundamentering med betong / Foundation concrete / Förankring med betong



(N) Bakkenivå (UK) Ground level (S) Marknivå

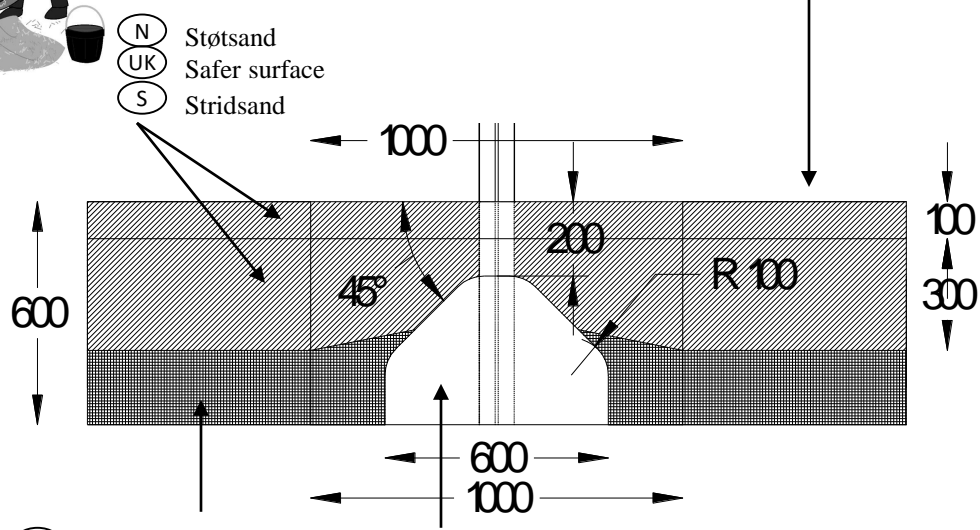

(N) Komprimert masse. betong
 (UK) Compressed mass. concrete
 (S) Komprimerad massa. betong

6

Fundamentering uten betong / Foundation without concrete / Förankring utan betong

(N) Bakkenivå (UK) Ground level (S) Marknivå

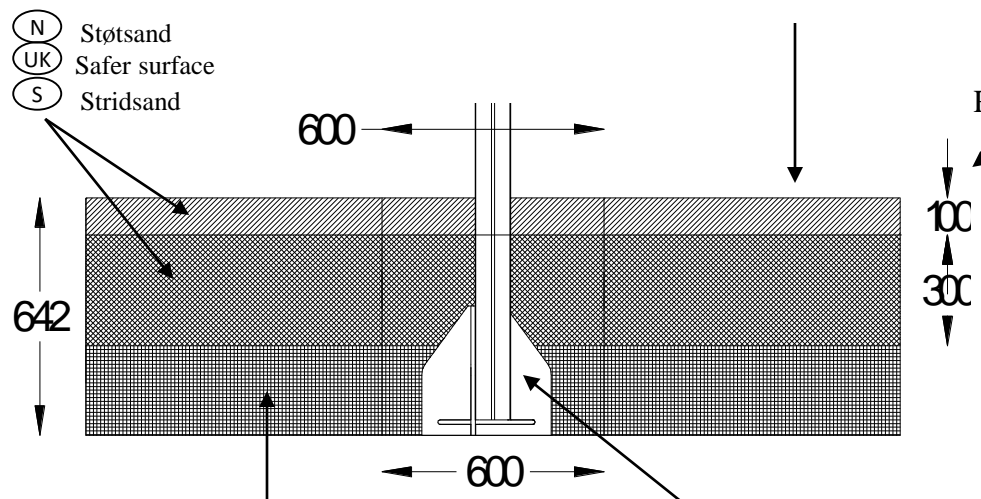

(N) Komprimert masse Støpefri nedgraving
 (UK) Compressed mass Concrete-free anchor
 (S) Komprimerad massa Nedgravningsfundament

(N)

Alle mål er oppgitt i millimeter

(UK)

Scale measured in mm

(S)

Alla mått är i millimeter.

- (N) For klatrenett
- (UK) For climbing net
- (S) För klätternät

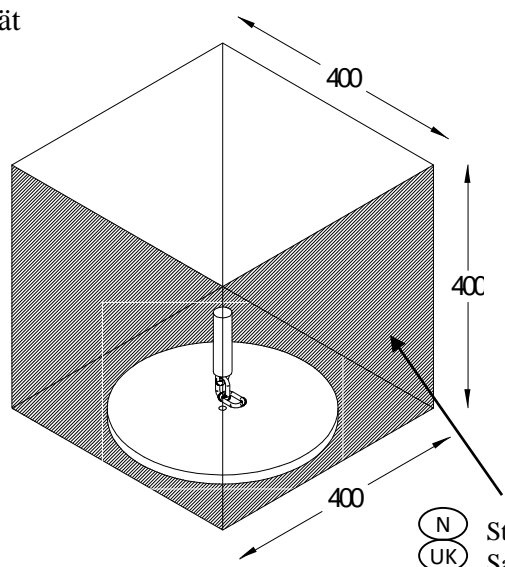
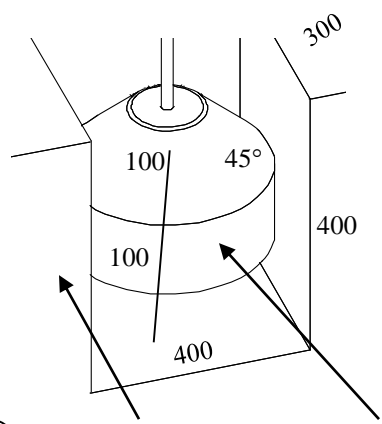

- (N) Komprimert masse. betong
- (UK) Compressed mass. concrete
- (S) Komprimerad massa. betong

- (N) Støtsand
- (UK) Safer surface
- (S) Stridsand

- (N) Alle mål er oppgitt i millimeter
- (UK) Scale measured in mm
- (S) Alla mått är i millimeter.

6

(N) Dybde for støping og forankring

(UK) Depth of foundations /

(S) Djup för gjutning och markförankring

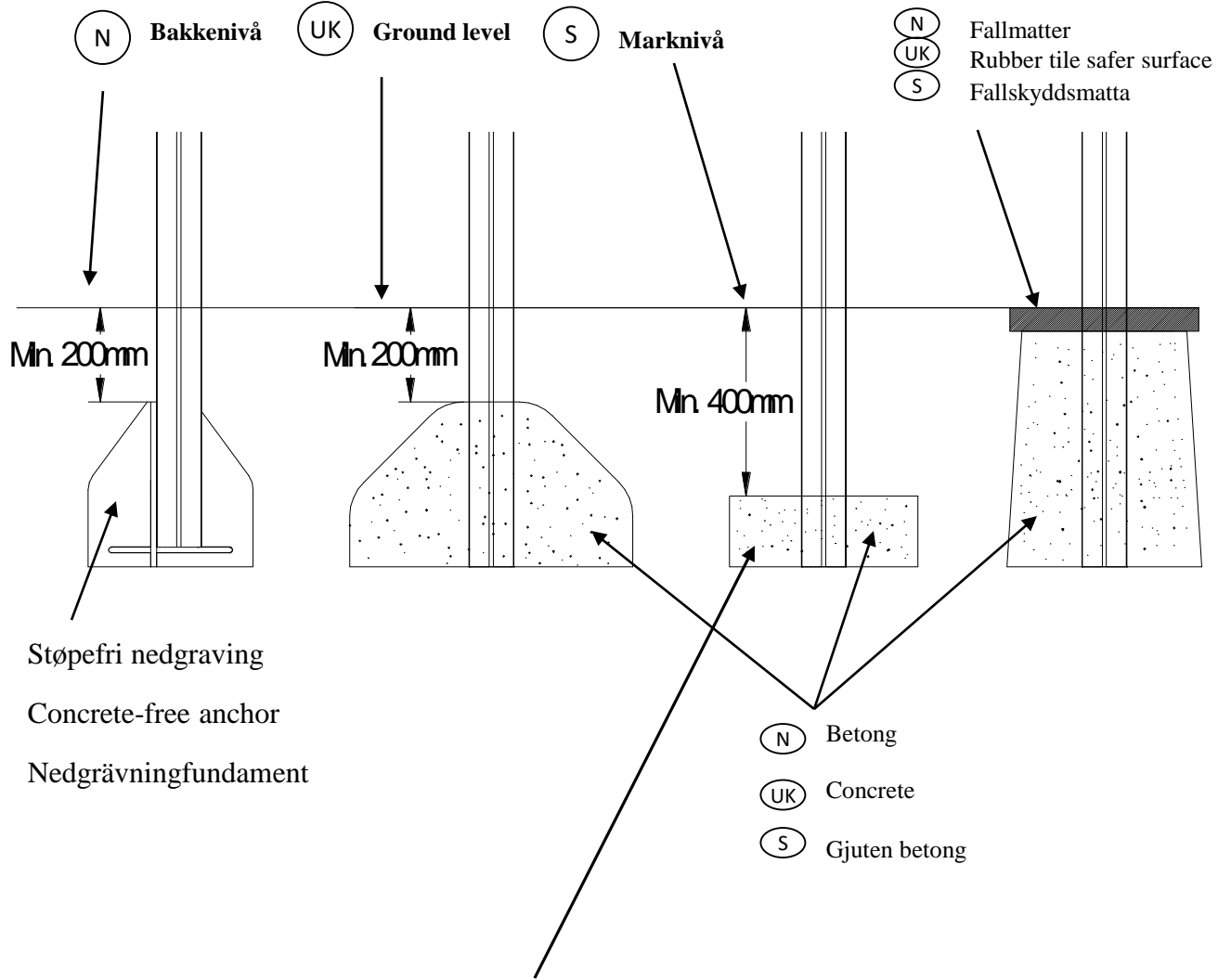

(N) Denne støpemetoden anbefales ikke grunnet dårlig stabilitet av lekeapparatet.

(UK) This anchor is recommend not to use because of poor stability of the play unit.

(S) Denna förankring avrådes från att användas, därför att lekutrustningen får dålig fäste.

1

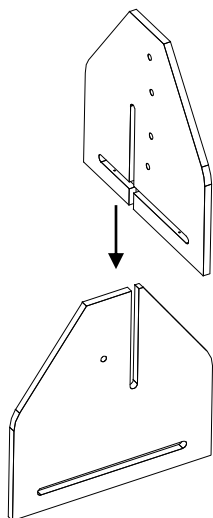

2

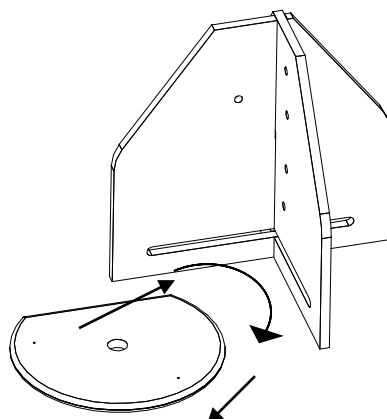

3

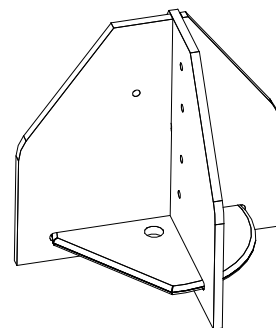

4

04-060-120 x 2
120 x 15 x 8 mm

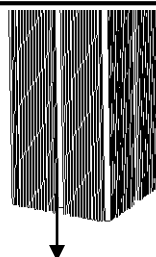

04-000-035 x 3
8 x 35 mm Torx

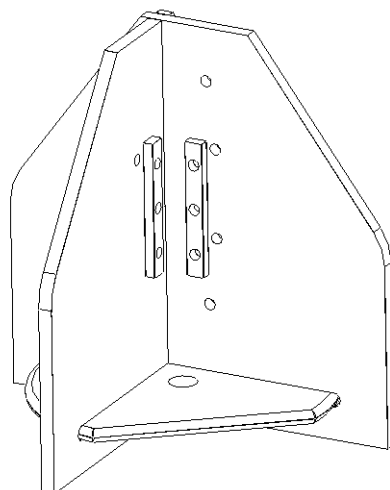

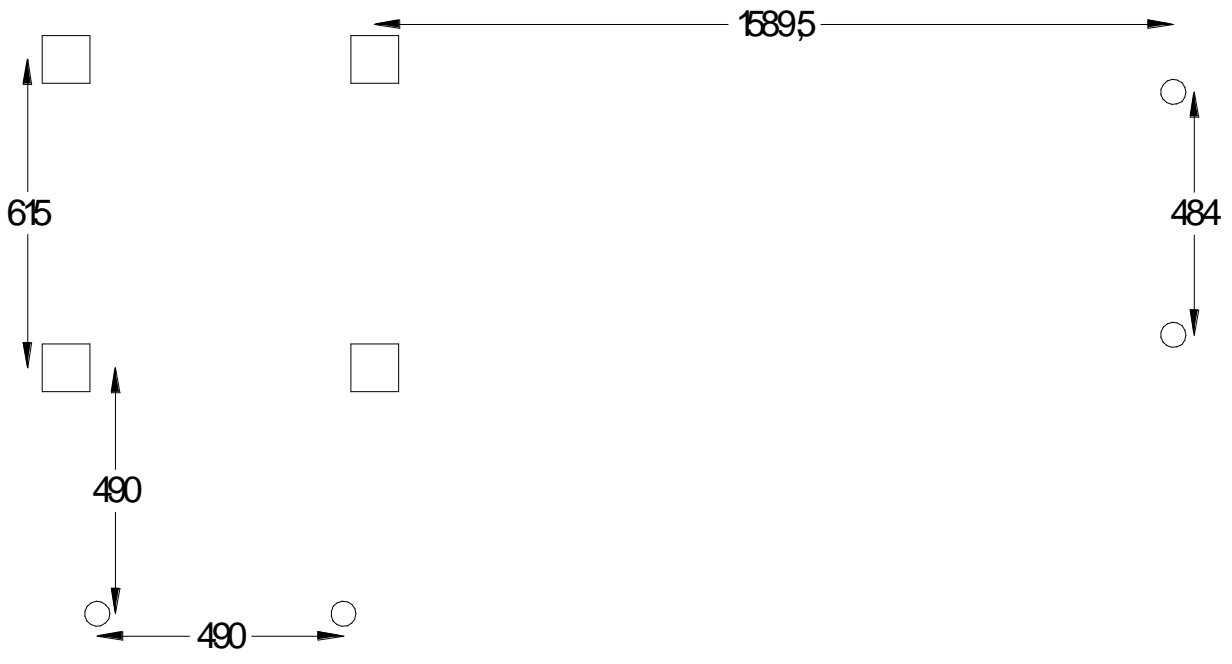

N

Alle mål er oppgitt i millimeter

UK

Scale measured in mm

S

Alla mått är i millimeter

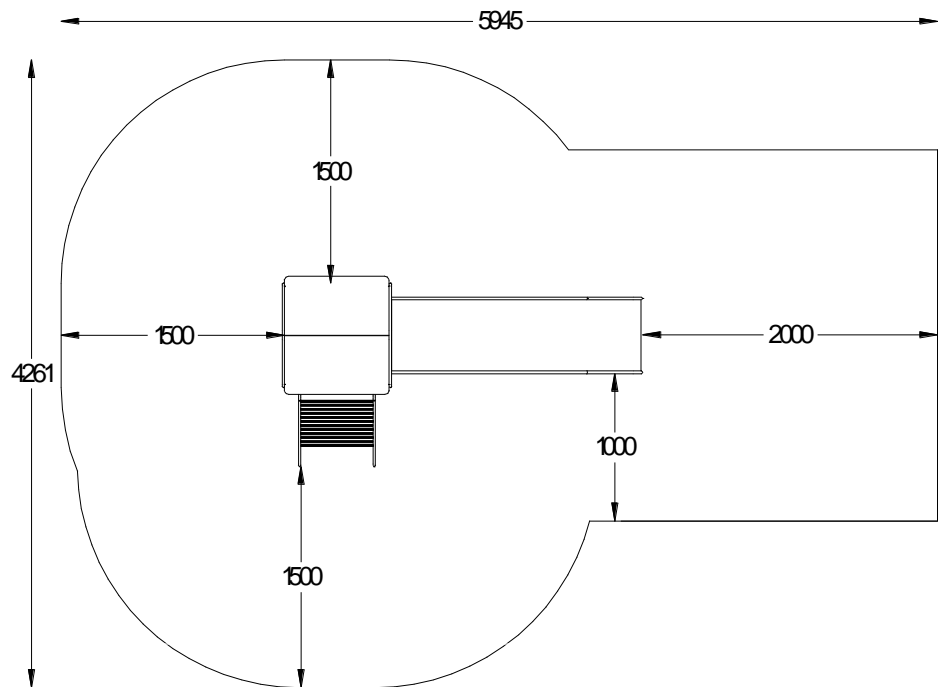
7**Sikkerhetszone / Safety zone / Säkerhetszon**

N

Alle mål er oppgitt i millimeter

UK

Scale measured in mm

S

Alla mått är i millimeter

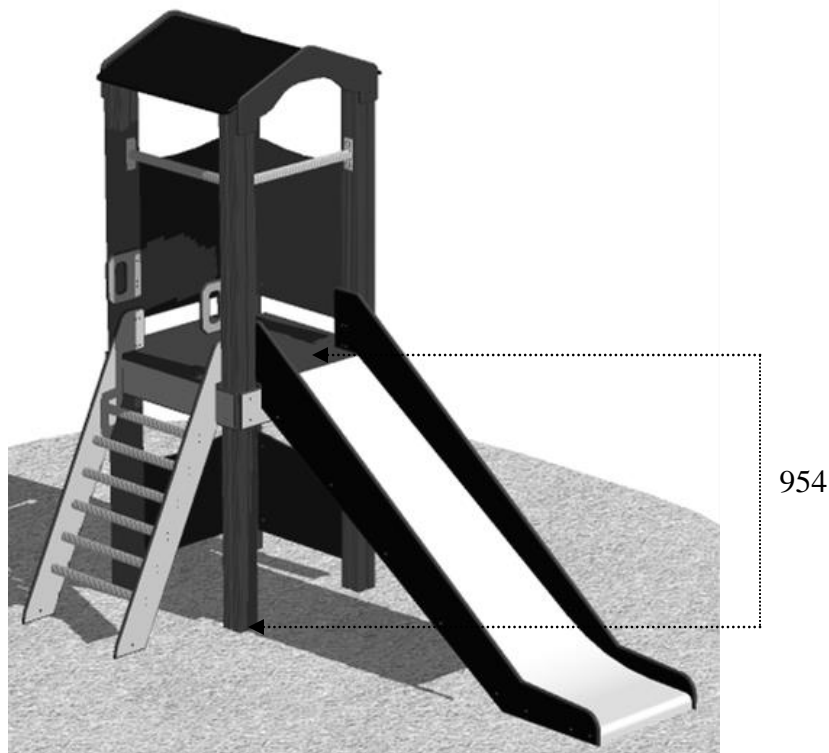
8**Fallhøyder / Free height of fall / Fallhöjder**

N

Alle mål er oppgitt i millimeter

UK

Scale measured in mm

S

Alla mått är i millimeter.

OBS !

- Ⓝ Bolter skrues helt igjennom aluminiumstolpene. Om elektrisk drill brukes anbefales 18 V
- ⓊⓀ Bolts must be tightened through the post, so that it pierces the aluminium.
- Ⓢ Bultarna skruvas rakt igenom aluminiumstolparna. Om elektrisk skruvdragare används rekommenderas 18 V

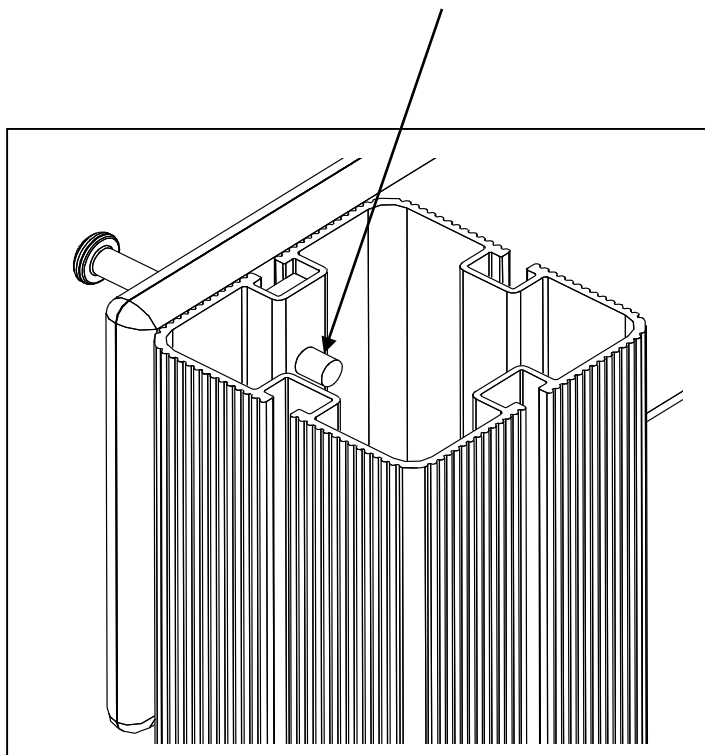

- (N) Uten betong
- (UK) Without concrete
- (S) Utan betong

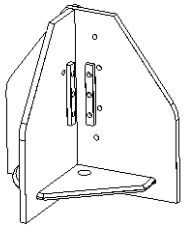

00-003-003

- (N) Med bruk av betong
- (UK) With use of concrete
- (S) Användning av betong

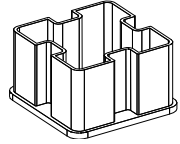
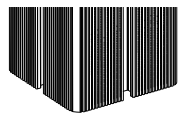

00-400-997

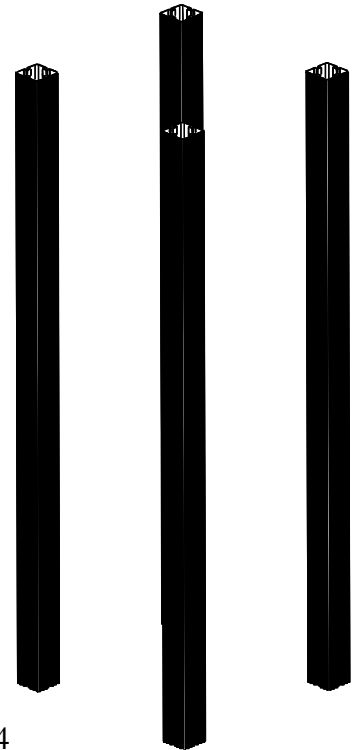

00-400-006 x 4

1

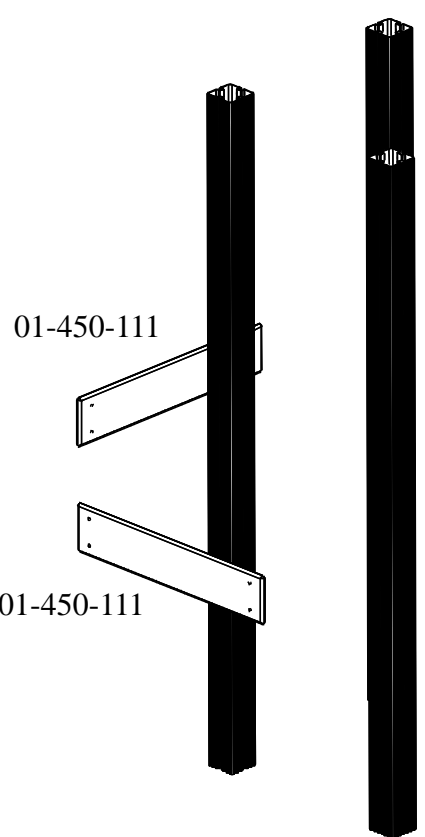

01-450-111

01-450-111

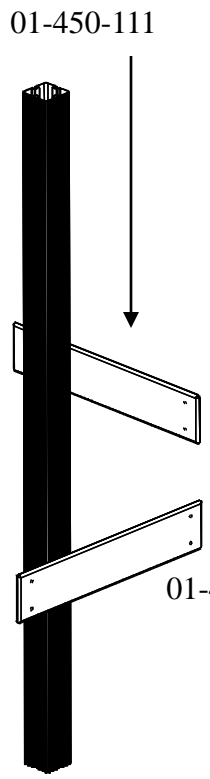

01-450-111

01-450-111

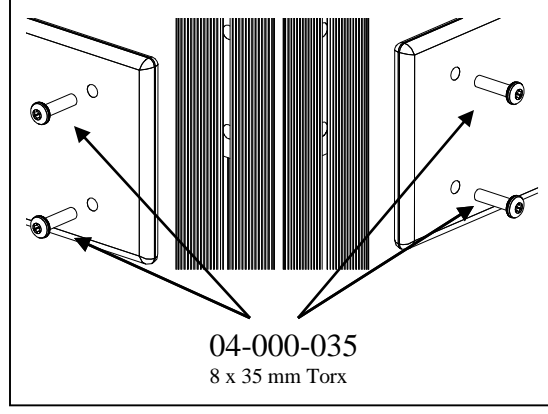

04-000-035
8 x 35 mm Torx

2

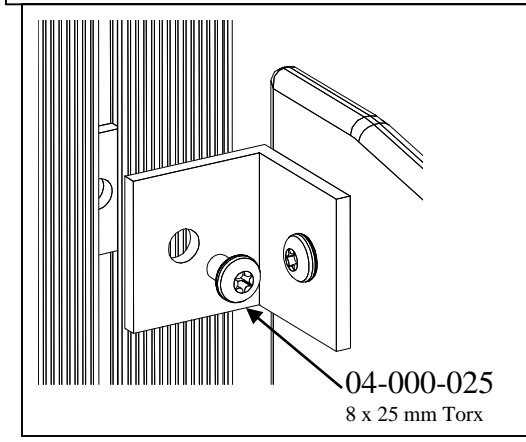
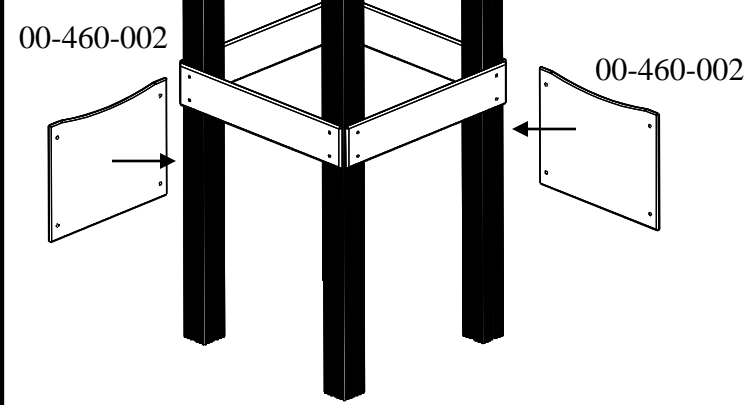
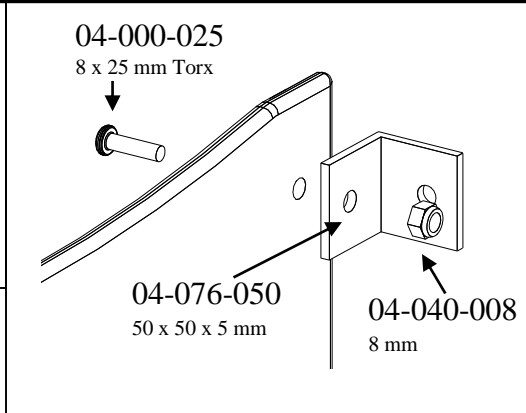
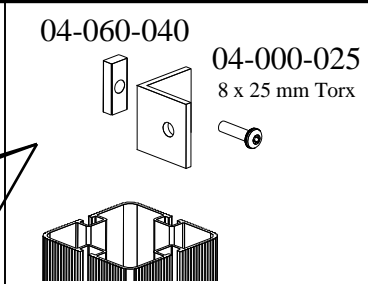
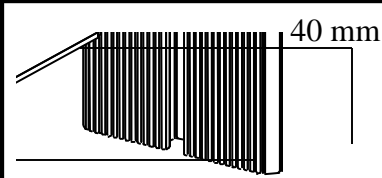

3

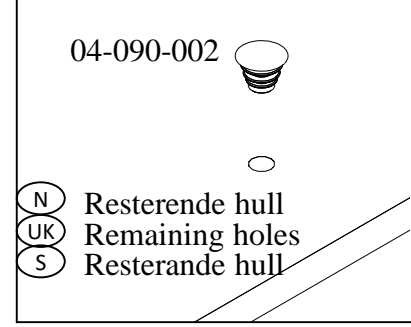
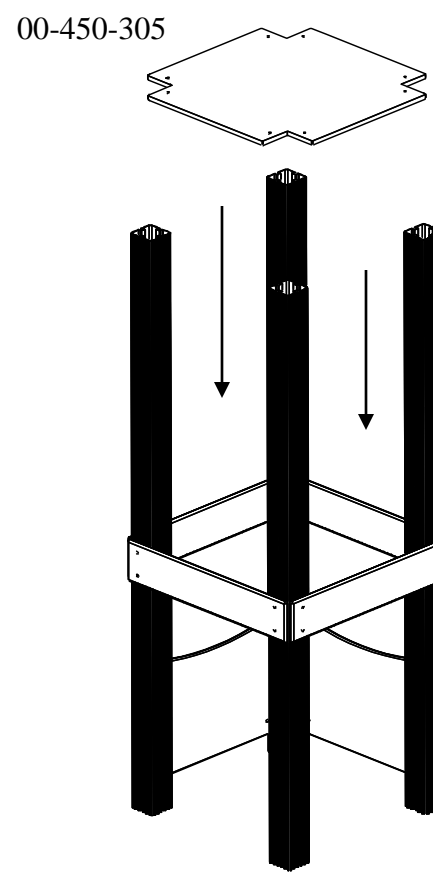

- (N) Gulvet festes ikke med vinkler
- (UK) The floor is not connected
- (S) Golvet fästes inte med vinklar

4

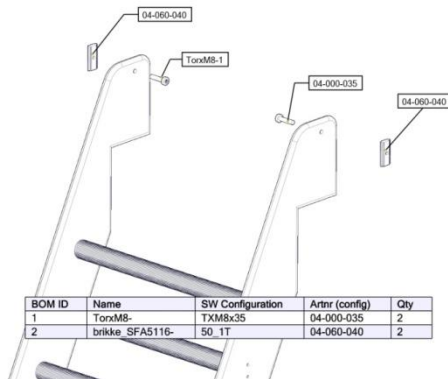

BOM ID	Name	SW Configuration	Artnr (config)	Qty
1	TorxMB-	TXM8x35	04-000-035	2
2	brikke SFAS116-	50_11	04-060-040	2

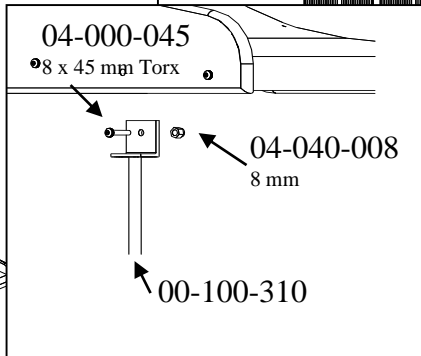
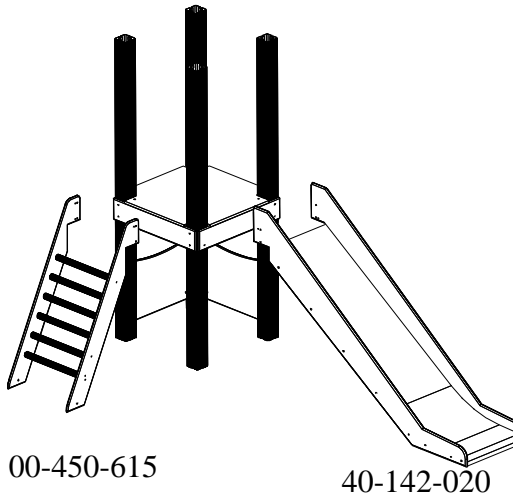
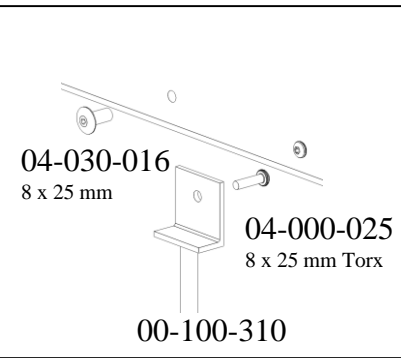
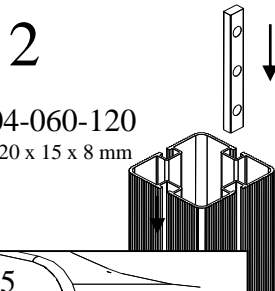
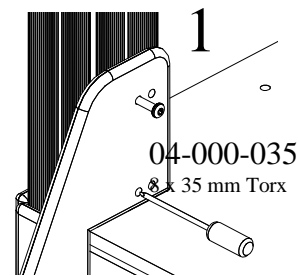
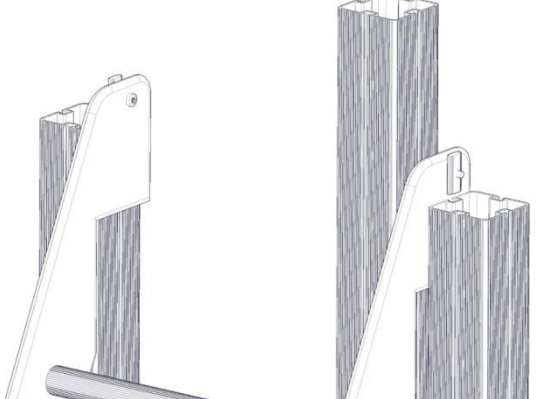

5

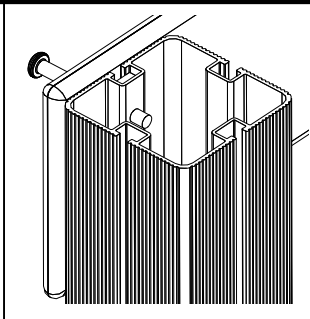
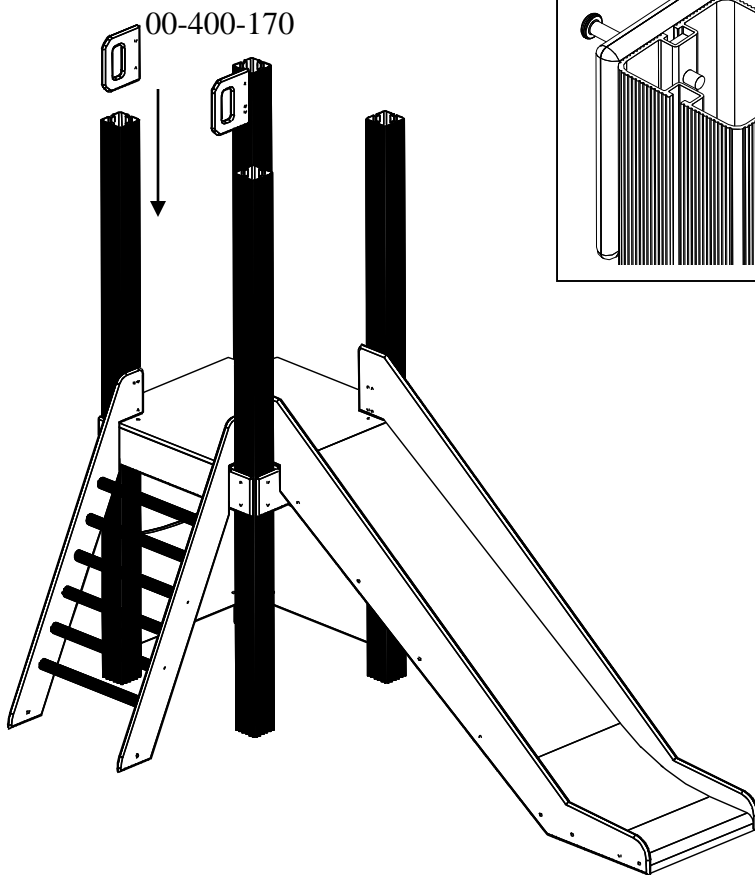
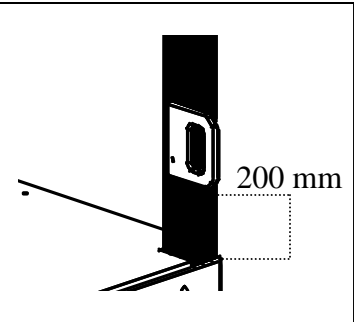
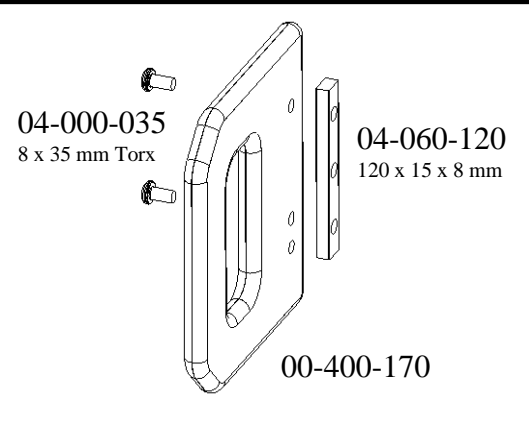

6

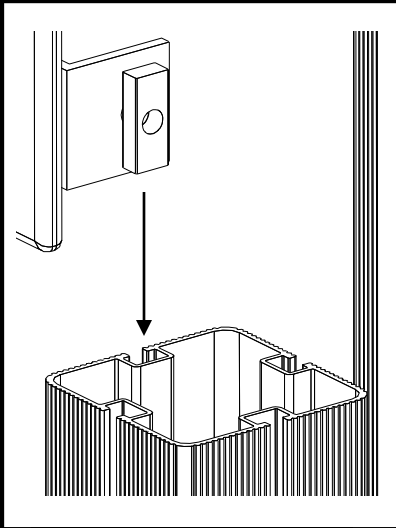

00-460-001 x 2

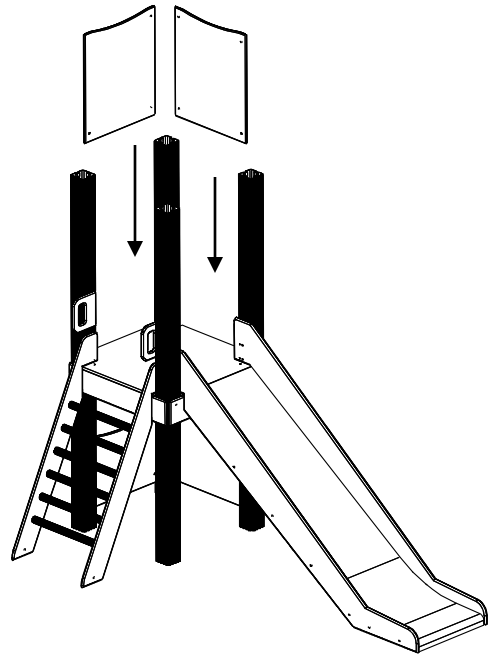

04-000-025

8 x 25 mm Torx

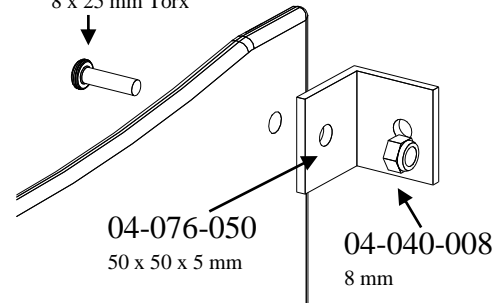

04-076-050
50 x 50 x 5 mm

04-040-008
8 mm

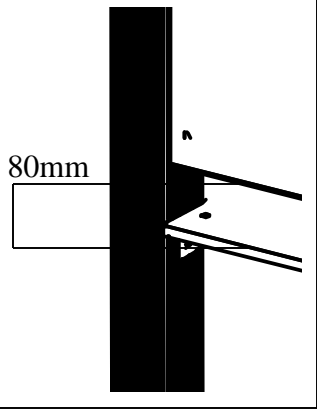

80mm

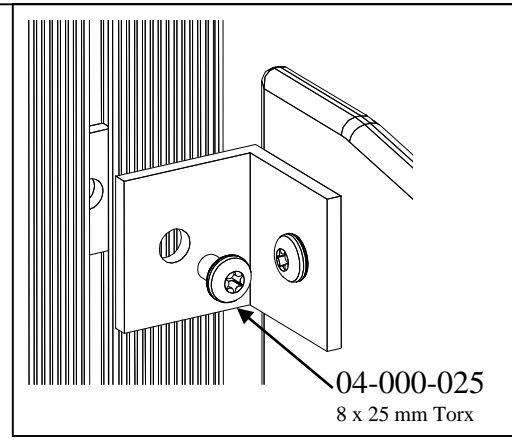

04-000-025
8 x 25 mm Torx

7

00-450-155 x 2

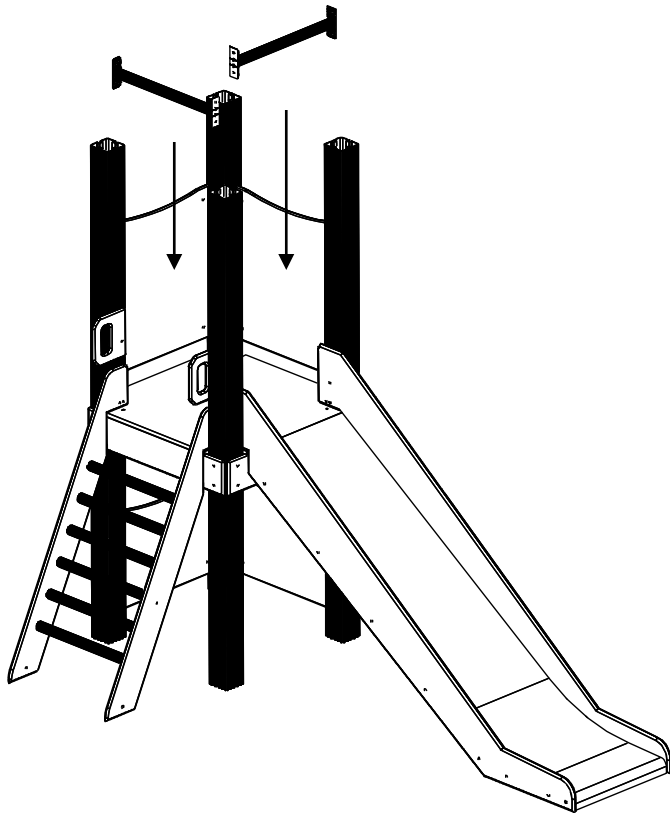

04-060-120

120 x 15 x 8 mm

04-000-025

8 x 25 mm Torx

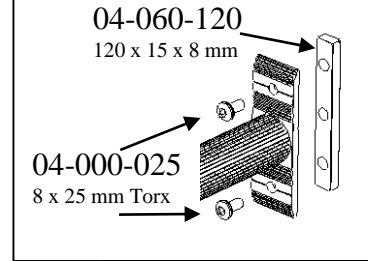

650

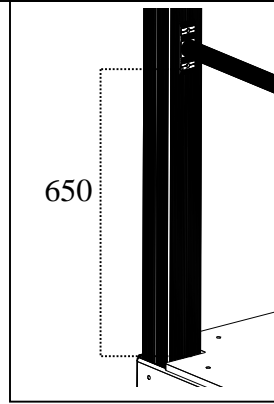

8

04-060-120
120 x 15 x 8 mm

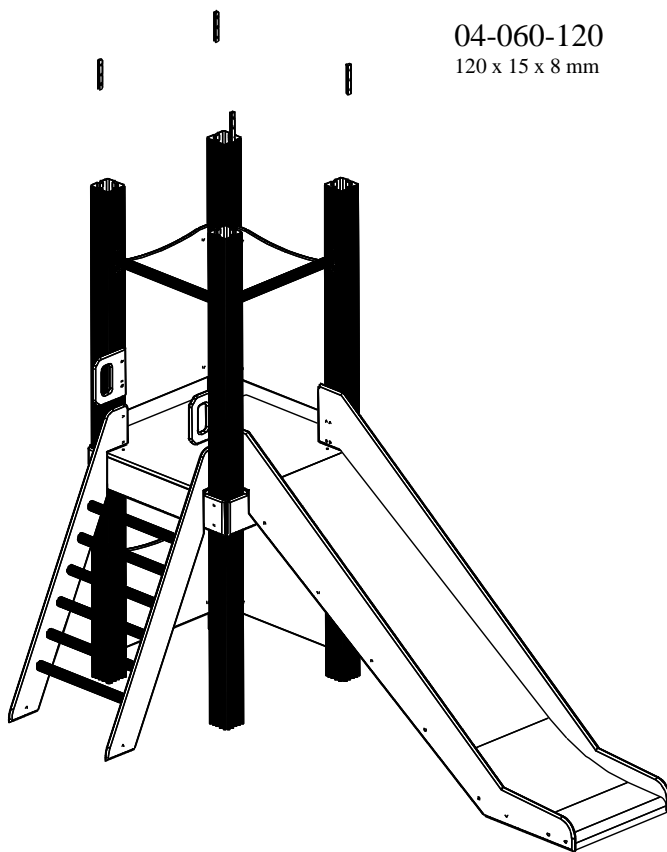

9

00-400-998 x 4

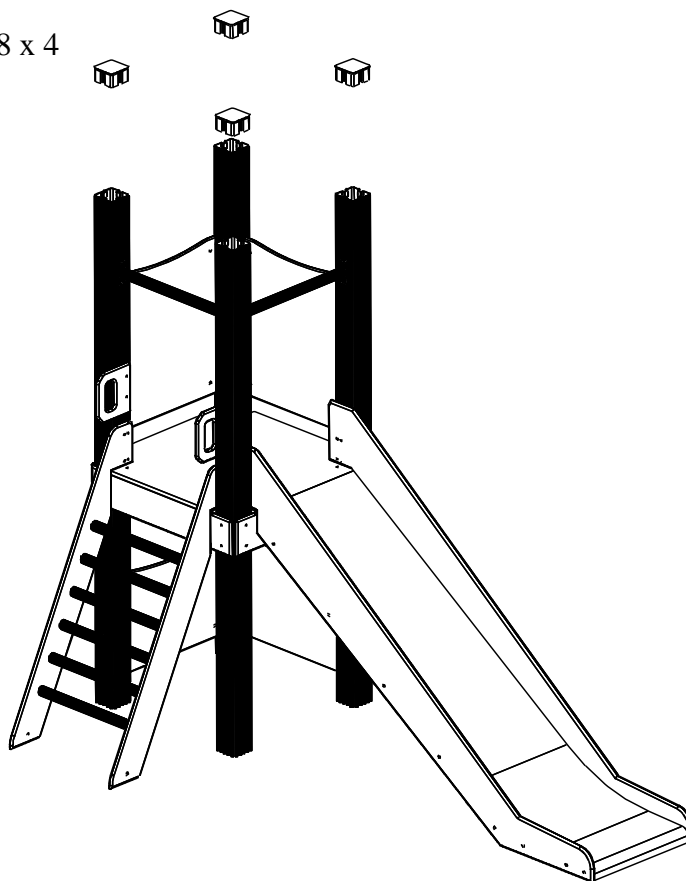

10

00-450-531

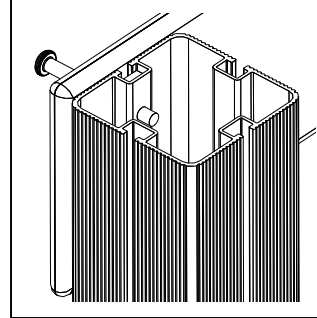
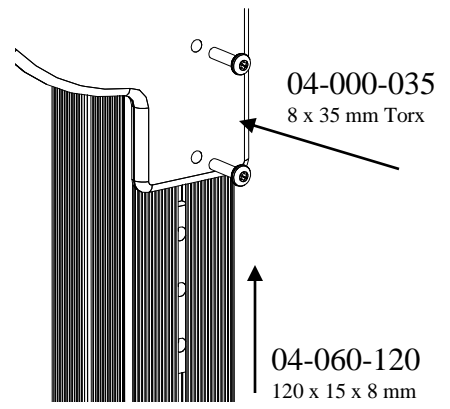
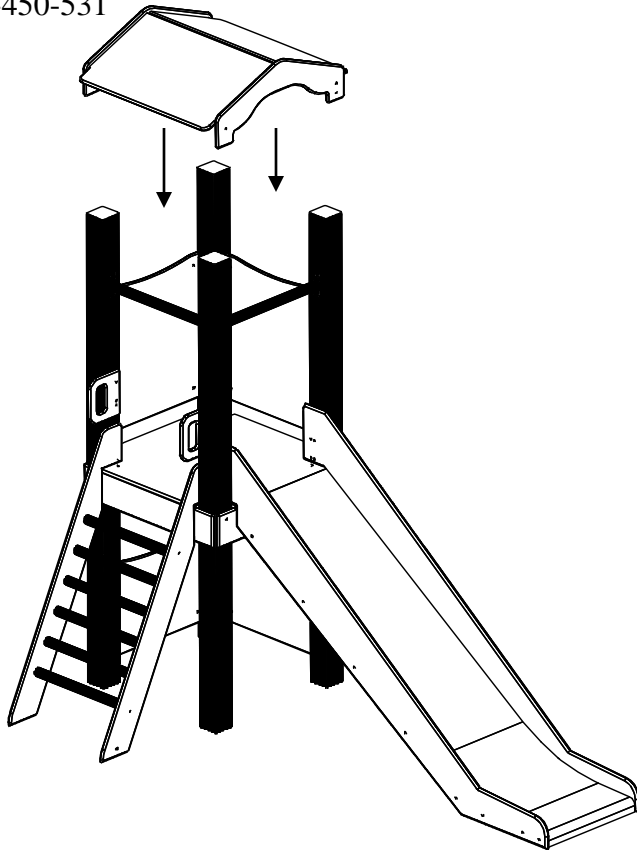

11

1

00-400-980

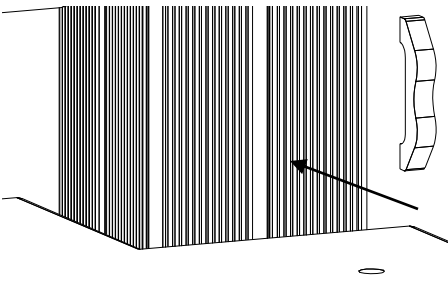

2

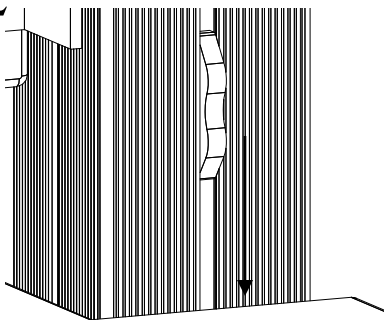

3

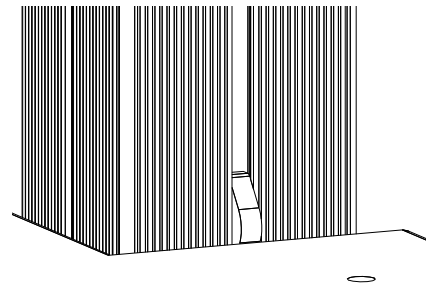

N

- ☑ Påse at fallunderlag er lagt i henhold til gjeldende regler eller vår anbefaling
- ☑ Fjern alle monteringshjelpemidler (rester av betong, planker, paller, plast, og lignende)
- ☑ Før utstyret tas i bruk, sjekk at det ikke er hektefare for anorakksnorer og lignende noen steder på lekeapparatet.

NB! Bør stå i 2-3 dager før bruk når forankring støpes.

UK

- ☑ Make sure the area and depth of safer surfacing are according to the current standard, or to the manufacturer's recommendation
- ☑ Make sure all tools and surplus materials are removed before play begins







PS! When complete, allow 2-3 days for the concrete to set before use.

S

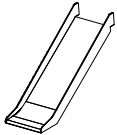
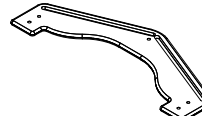
- ☑ Kontrollera att fallunderlag är utlagt enligt gällande regler eller vår rekommendation
- ☑ Ta bort alla monteringshjälpmedel (rester av betong, plankor, pallar, plast och liknande)
- ☑ Innan lekredskapet används, kontrollera att anoracksnoddar eller kläder/delar av kläder eller liknande inte kan fastna i några delar på redskapet.

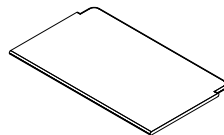
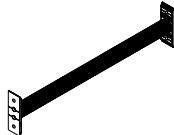
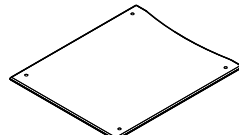
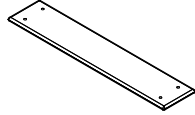
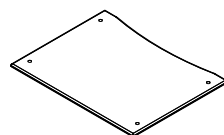
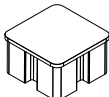
- ☑ OBS! Bör stå i 2-3 dagar innan användning när det gjuts

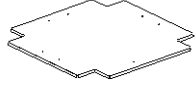
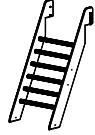
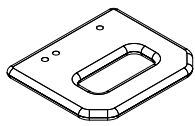

N
UK
S

Komponenter Components Komponenter	Dimensjon Dimension Dimension	Ant Qty Ant	Lev Lev	Komponenter Components Komponenter	Dimensjon Dimension Dimension	Ant Qty Ant	Lev Lev
40-142-020 	520 x 2193	1		00-450-533 	710 x 270 x 15	2	
00-400-006 	2600 x 95 x 95	4		00-450-532 	730 x 430 x 15	2	
00-450-155 	520 x 120 x 40	2		00-460-001 	520 x 620 x 12	2	
01-450-111 	710 x 145 x 15	4		00-460-002 	520 x 400 x 12	2	
00-400-998 	55 x 95 x 95	4		00-100-310 	512 x 120	4	
00-400-997 Med hull		4					
00-450-305 	740 x 740 x 15	1		00-450-615 	1260 x 520 x 174	1	
00-400-170 	172 x 200 x 15	2					
00-450-148 	710 x 37	1					

5



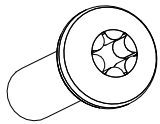
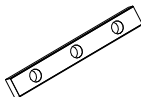
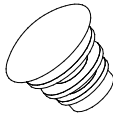







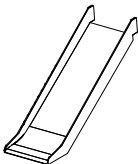

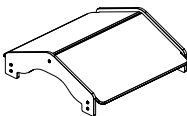







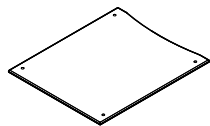

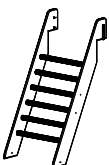



Pakkliste for / Parts list for / Packlista för :
24-100-000

Sign. _____

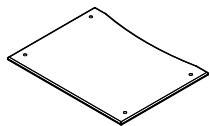
N UK S	Bolter/skruer Bolts/Screws Komponenter	Dimensjon Dimension Dimension	Ant Qty Ant	Lev Lev	Bolter/skruer Bolts/Screws Bultar/Skruvar	Dimensjon Dimension Dimension	Ant Qty Ant	Lev Lev
		04-000-025 8 x 25 mm Torx	8				04-060-120 120 x 15 x 8 mm	6
	04-090-002	8						
	04-400-980	4						

N
UK
S

Boltepakker for / Boltpackage for / Bultpaket för 24-100-000

<p>40-142-020</p>  <p>Antall Number Antal</p>	 <p>04-060-120 120 x 15 x 8 mm</p>	2	<p>00-450-531</p>  <p>Antall Number Antal</p>	 <p>04-060-120 120 x 15 x 8 mm</p>	4
	 <p>04-000-045 8 x 45 mm Torx</p>	2		 <p>04-000-035 8 x 35 mm Torx</p>	8
	 <p>04-000-035 8 x 35 mm Torx</p>	2		 <p>04-000-045 8 x 45 mm Torx</p>	2
	 <p>04-040-008 8 x 25 mm</p>	2		 <p>04-090-001 8 mm</p>	2
<p>00-460-001</p>  <p>Antall Number Antal</p>	 <p>04-060-040 40 x 15 x 8 mm</p>	8	<p>00-450-615</p>  <p>Antall Number Antal</p>	 <p>04-060-040 050 x 15 x 8 mm</p>	2
	 <p>04-000-025 8 x 25 mm Torx</p>	16		 <p>04-000-016 8 x 16 mm Torx</p>	2
	 <p>04-076-050 50 x 50 x 5 mm</p>	8		 <p>04-000-035 8 x 35 mm Torx</p>	2
	 <p>04-040-008 8 mm</p>	8		 <p>04-030-016 8 x 16 mm</p>	2
<p>00-460-002</p>  <p>Antall Number Antal</p>	 <p>04-060-040 40 x 15 x 8 mm</p>	8	<p>Antall Number Antal</p>	 <p>04-090-002</p>	6
	 <p>04-000-025 8 x 25 mm Torx</p>	16			1
	 <p>04-076-050 50 x 50 x 5 mm</p>	8			
	 <p>04-040-008 8 mm</p>	8			

(N) Produkt merking

(UK) Product marking









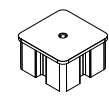

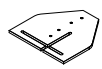

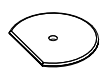

(S) Produkt märkning

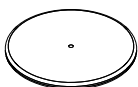
Forankring / Foundations / Markförankring

00-003-003

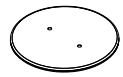
- N Er bestilt Ikke bestilt
- UK In order Not in order
- S Bestållt Ej bestållt

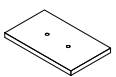
00-400-997 	-4
---	-----------

	00-003-100 						04-000-035 8 x 35 mm Torx	12	
	00-003-101 						04-050-008 8 mm	12	
	00-003-102 		4				04-060-120 120 x 15 x 8 mm	8	
	00-003-103 						04-000-040 8 x 40 mm Torx	0	
							04-040-008 8 mm	0	
			0				04-050-008 8 mm	0	
	00-003-105 						04-010-035 10 x 35 mm	8	
	00-003-106 						04-040-010 10 mm	8	
Eller Or Eller			4				04-050-010 10 mm	8	