

N

Monteringsanvisning

EN

Assembly Instructions

S

Monteringsanvisning

Produkt nr. / Product no. / Produkt nr.

25-050-040

Ord. nr. _____

Dato. _____

Sign. _____

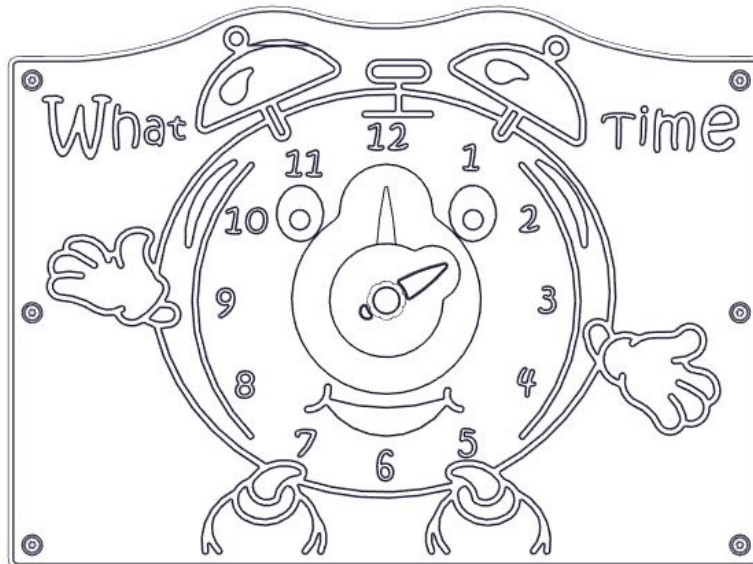
**søve**

Søve AS
Grønnvoldveien 290
3830 Ulefoss - Norway
Tlf: +47 35 94 65 65
www.sove.no

**søve**

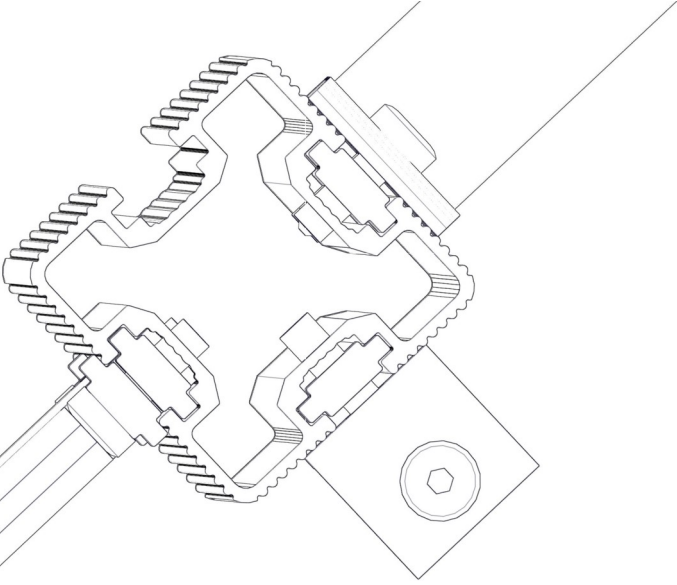

Søve AB
EA Rosengrensgatan 32
421 31 Västra Frölunda
Phone: +46 (0)31 773 97 00
www.sove.se

N	Bolten skrues HELT igjennom aluminiumen. Maks moment: 30Nm	
EN	The bolt must be tightened in to the post, so that it pierces the aluminium Max torque: 30Nm	
S	Bulten skruvas HELT genom aluminiumen. Maks vridmoment: 30Nm	

NO	Betongkvalitet	C25/30		
SE	Betongkvalitet			
EN	Concrete quality			
NO	Mengde betong			m ³
SE	Mängd betong			
EN	Amount of concrete			
NO	Fundament størrelse		0,5 x 0,5 x 0,4	m
SE	Stiftelsestorlek			
EN	Foundation size			
NO	For sikkerhet må fundamentene med sand eller myk jord være minst 50% større i areal			
SE	För säkerheten måste grunden med sand eller mjuk jord vara minst 50% större i området			
EN	For safety, the foundations with sand or soft soil must be at least 50% larger in area			
NO	Tyngste element	07-520-041	10	Kg
SE	Tyngsta element			
EN	Heaviest element			
NO	Største element	07-520-041	0,8 x 0,6 x 0,11	m
SE	Största element			
EN	Biggest element			

Boltepakker for / Boltpackage for / Bultpaket för

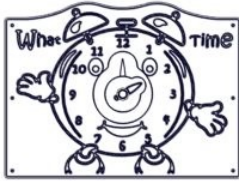
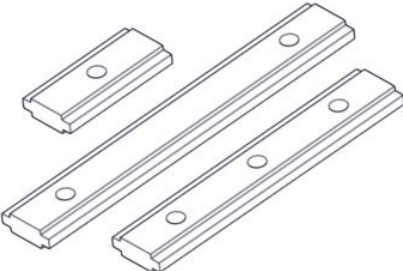
Sign. _____

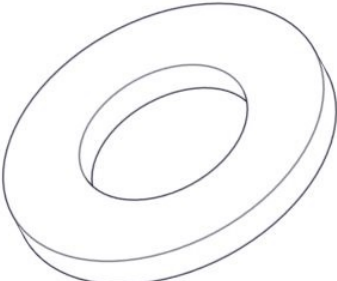
Hva er klokka 25-050-040	Navn	Artnr/ dimensjon	Ant	Lev
	Hva er klokka m/hull 800x595	07-520-041	1	
	Brikke 50 1xM8	04-060-050	6	
	Torx M8x40	04-000-040	6	
	Skive M8 Stor	04-055-008	6	

Montering av lekeapparatet / Assembly instructions / Montering av lekredskapet

Se på hovedmontering for posisjon
 Look at main assembly for position
 Titta på hovudmontering för position

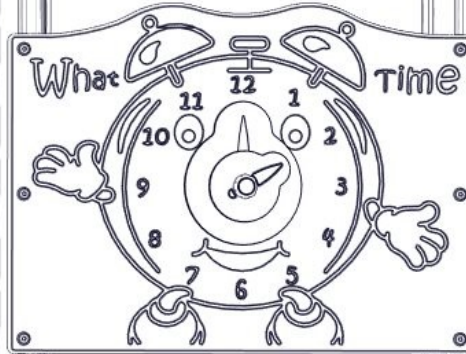

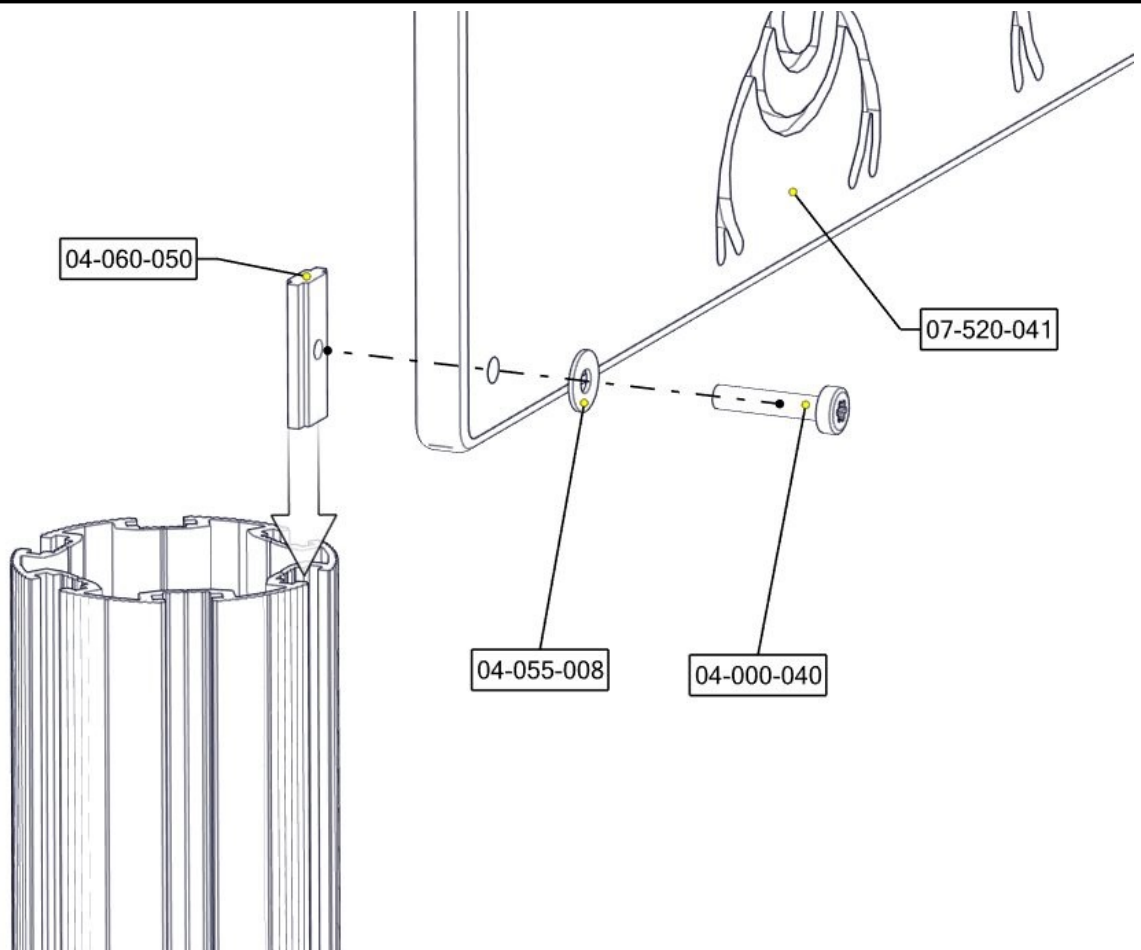

Part Name	Article nr.	Qty
Brikke 50 1XM8	04-060-050	6
Hva_er_klokka m/hull	07-520-041	1
Skive M8 stor	04-055-008	6

Part Name	Article nr.	Qty
Torx M8x40	04-000-040	6

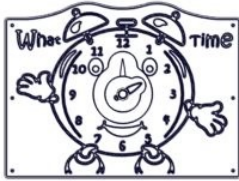
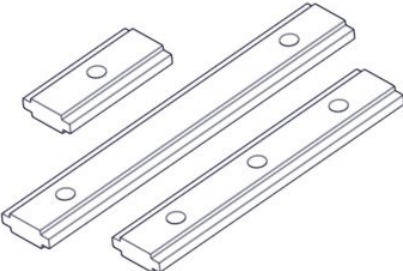

Boltepakker for / Boltpackage for / Bultpaket för

Sign. _____.

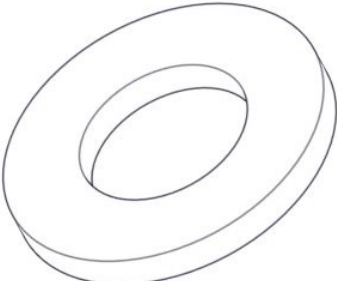
Hva er klokka 25-050-040	Navn	Artnr/ dimensjon	Ant	Lev
	Hva er klokka m/hull 800x595	07-520-041	1	
	Brikke 50 1xM8	04-060-050	6	
	Torx M8x40	04-000-040	6	
	Skive M8 Stor	04-055-008	6	