

N

Monteringsanvisning

EN

Assembly Instructions

S

Monteringsanvisning

Produkt nr. / Product no. / Produkt nr.

25-050-051

Ord. nr. _____

Dato. _____

Sign. _____

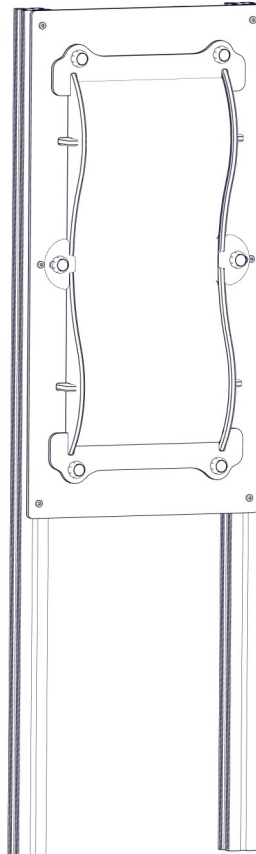







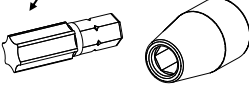

**søve**

Søve AS
Grønnvoldveien 290
3830 Ulefoss - Norway
Tlf: +47 35 94 65 65
www.sove.no

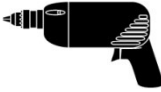

Søve AB
EA Rosengrensgatan 32
421 31 Västra Frölunda
Phone: +46 (0)31 773 97 00
www.sove.se

Nødvendig verktøy / Tools required / Nödvändiga verktyg

<p>(N)</p> <p>(EN)</p> <p>(S)</p>	<p>(A)</p> 	<p>(B)</p>  <p>Torx Nr 45 High quality</p> 	<p>(C)</p>  <p>13 + 17mm</p> 	<p>(D)</p> 	<p>(E)</p> 
		<p>Metermål</p> <p>Metric measure</p> <p>Tumstock</p> 	<p>16 V</p> 	<p>Merkebånd</p> <p>Mark ribbon</p> <p>Märkeband</p> 	<p>5 mm</p> <p>6 mm</p> 

Nødvendig antall personer / Number of persons required / Rekommenderad antal personer

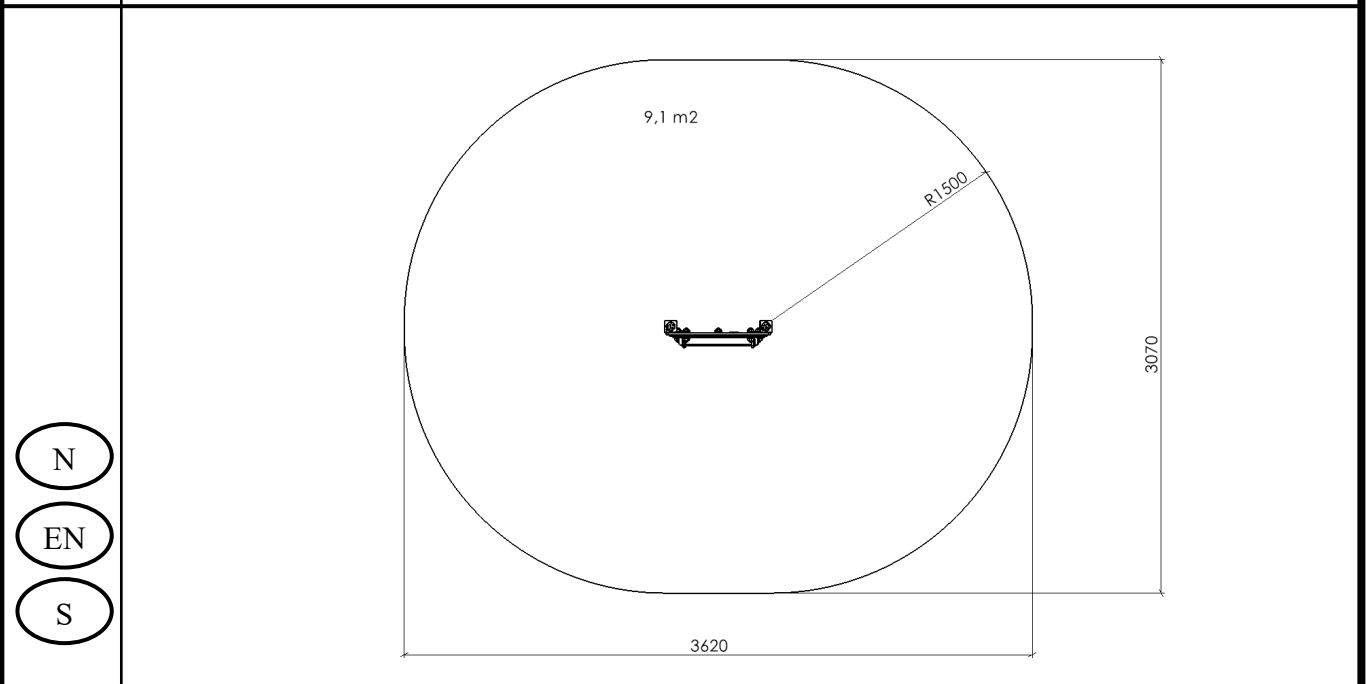

<p>(N)</p> <p>(EN)</p> <p>(S)</p>	
-----------------------------------	---

Anbefalt arealbehov ved montering / Recommended working space / Rekommenderad arealbehov vid montering

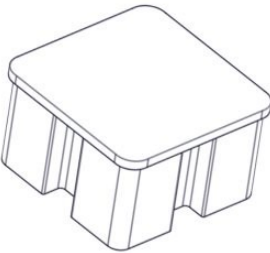

Boltepakker for / Boltpackage for / Bultpaket för

Sign. _____.

Klovnespeil på stolper 25-050-051	Navn	Artnr/ dimensjon	Ant	Lev
	Klovnespeil montert på stolper	07-201-622	1	
	Endelokk 70x70	00-400-996	2	
	Produktmerke montert hos Søve	00-100-401	0	

Boltepakker for / Boltpackage for / Bultpaket för

Sign. _____.

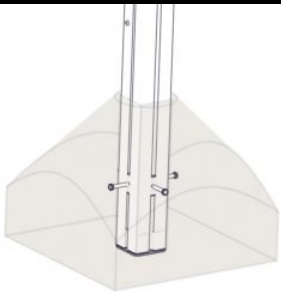
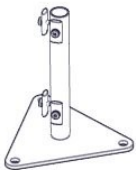
Klovnespil på stolper 25-050-051	Navn	Artnr/ dimensjon	Ant	Lev
	Fundament Støp			
	Støpefundament 70x70 stolpe	00-003-112K (se egen del- montering)	2	
	Overflate montering			
	Fundament 70x70 stolpe for betongdekke Ekstra	00-003-129k (se egen del- montering)	2	

Fundamentering med betong // Foundation concrete // Förankring med betong

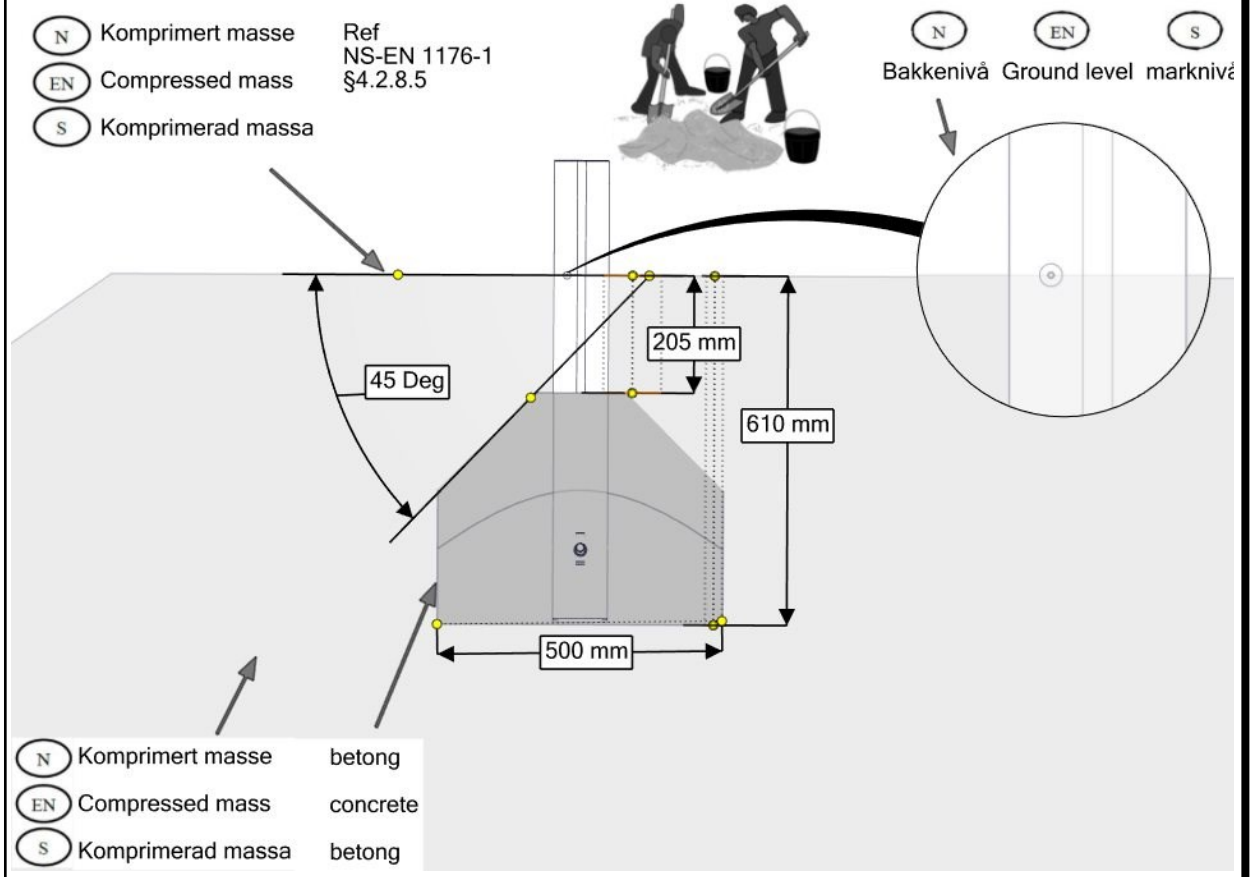

Overflatemontering / Surface mounting / Ytmontering

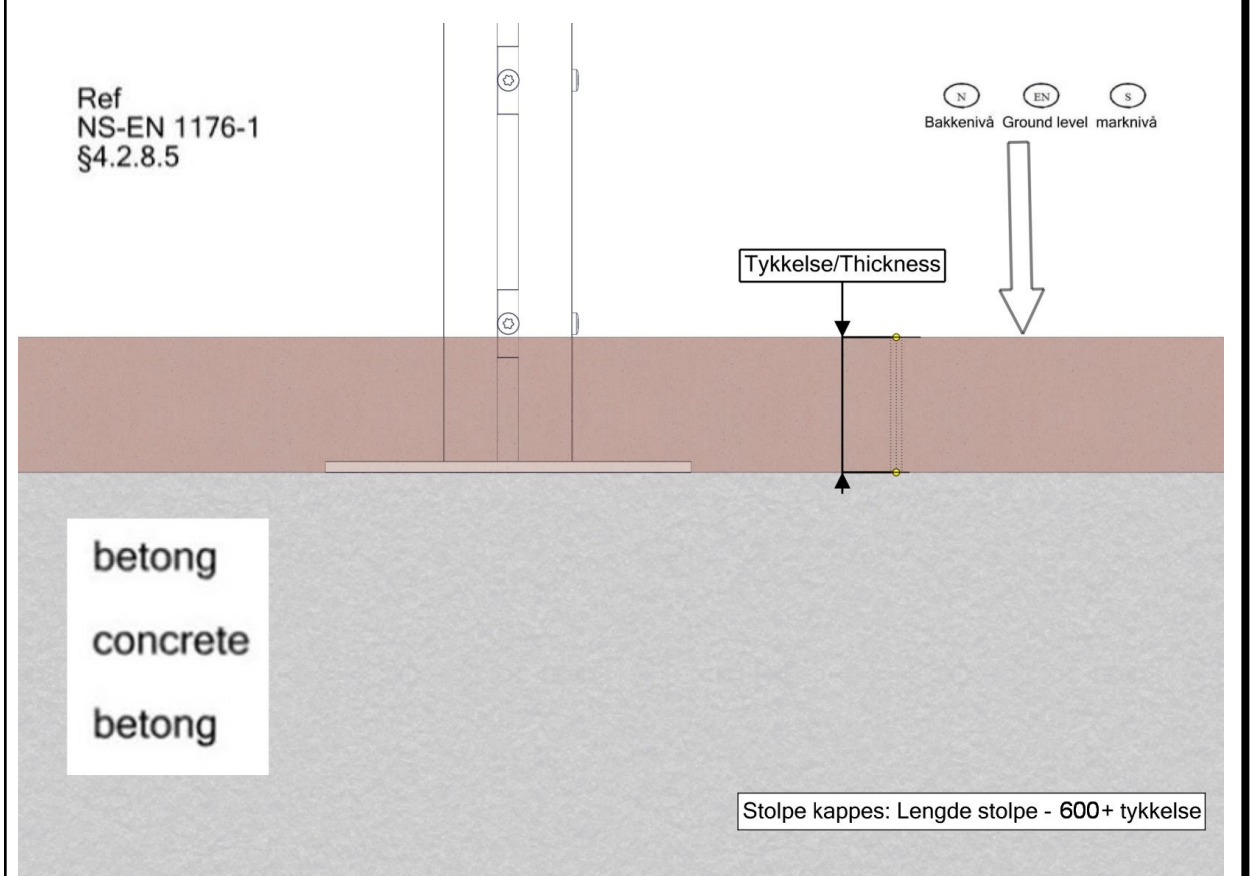

Sikkerhetsone / Safety area / Säkerhetsområde

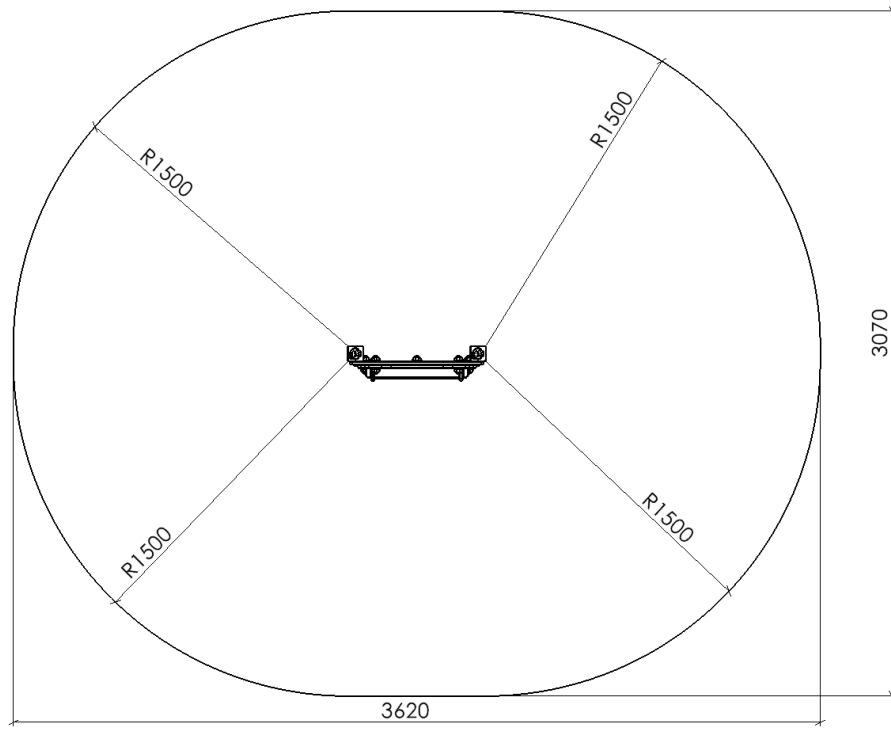

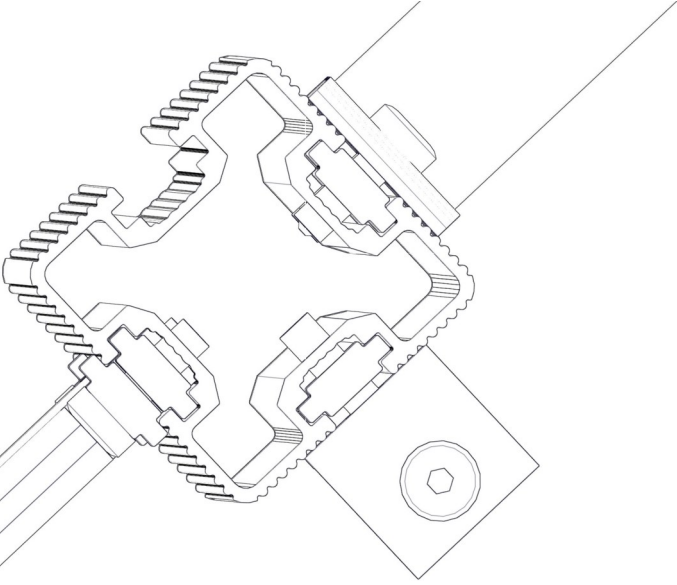
N	<p>Bolten skrues HELT igjennom aluminiumen. Maks moment: 30Nm</p>	
EN	<p>The bolt must be tightened in to the post, so that it pierces the aluminium Max torque: 30Nm</p>	
S	<p>Bulten skruvas HELT genom aluminiumen. Maks vridmoment: 30Nm</p>	

NO	Betongkvalitet	C25/30		
SE	Betongkvalitet			
EN	Concrete quality			
NO	Mengde betong		0,09 (0,5x0,5x0,5x2)	m ³
SE	Mängd betong			
EN	Amount of concrete			
NO	Fundament størrelse		0,5x0,5x0,5	
SE	Stiftelsestorlek			
EN	Foundation size			
NO	For sikkerhet må fundamentene med sand eller myk jord være minst 50% større i areal			
SE	För säkerheten måste grunden med sand eller mjuk jord vara minst 50% större i området			
EN	For safety, the foundations with sand or soft soil must be at least 50% larger in area			
NO	Tyngste element	07-201-622	25	Kg
SE	Tyngsta element			
EN	Heaviest element			
NO	Største element	07-201-622	2x0,7x0,2	m
SE	Största element			
EN	Biggest element			

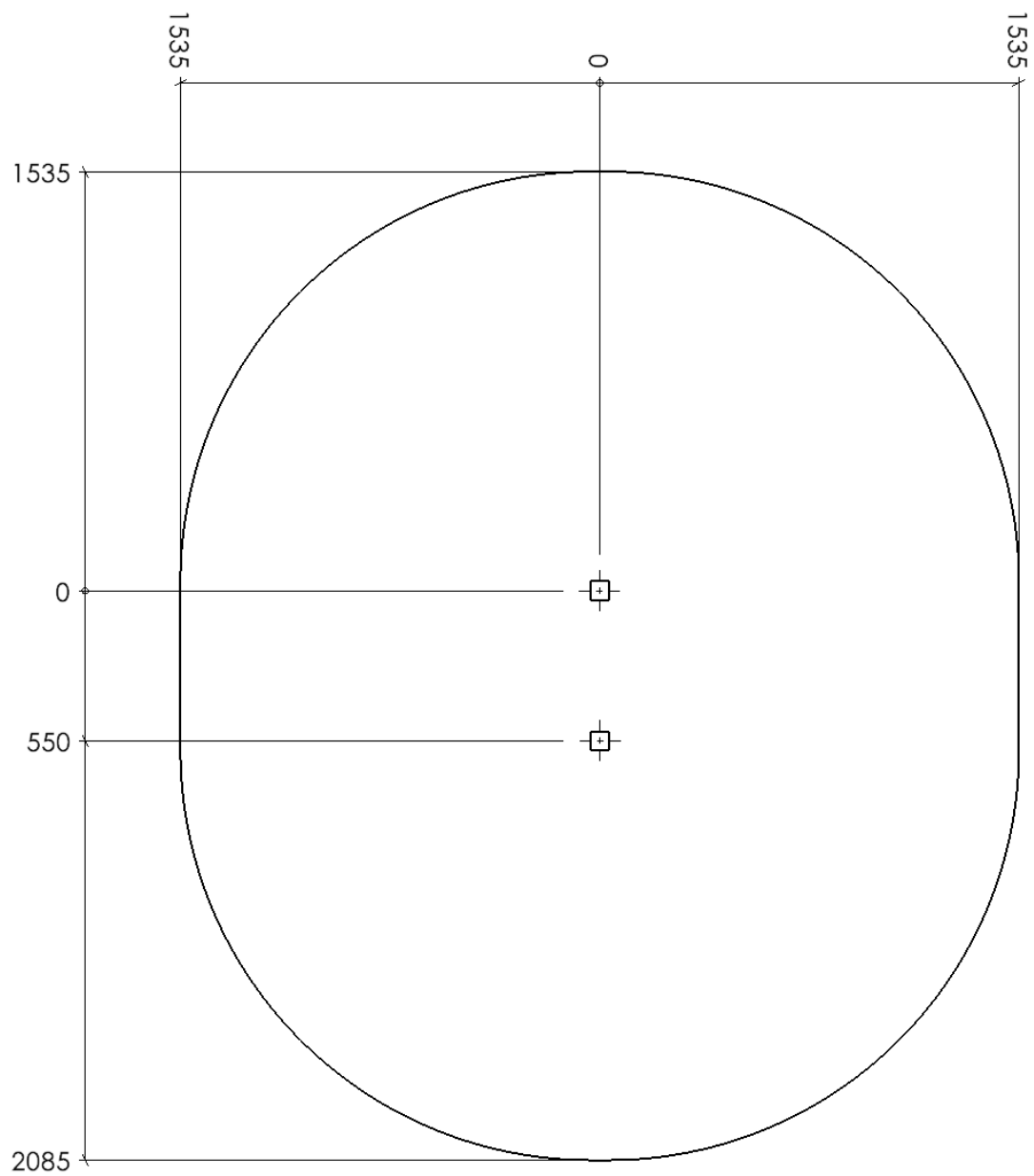
Plassering av forankringer / Ground plan / Placering av förankringar

N

Alle mål er oppgitt i millimeter

EN

Scale measured in mm

S

Alla mått är i millimeter.

Montering av lekeapparatet / Assembly instructions / Montering av lekredskapet

Se separat delmontering for detaljer
 See separate assembly for details
 Se separata delmontering för detaljer

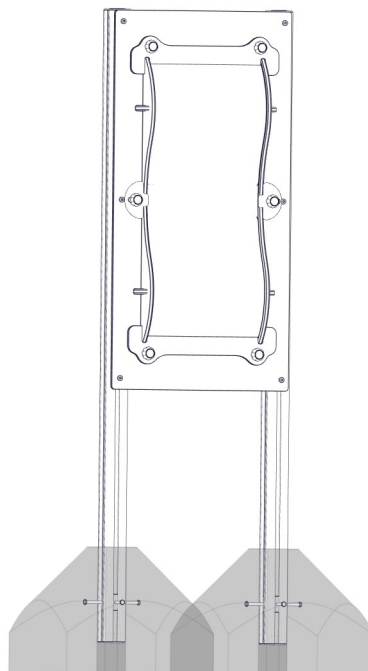

Må støpes
 Må gjutes
 Use concret

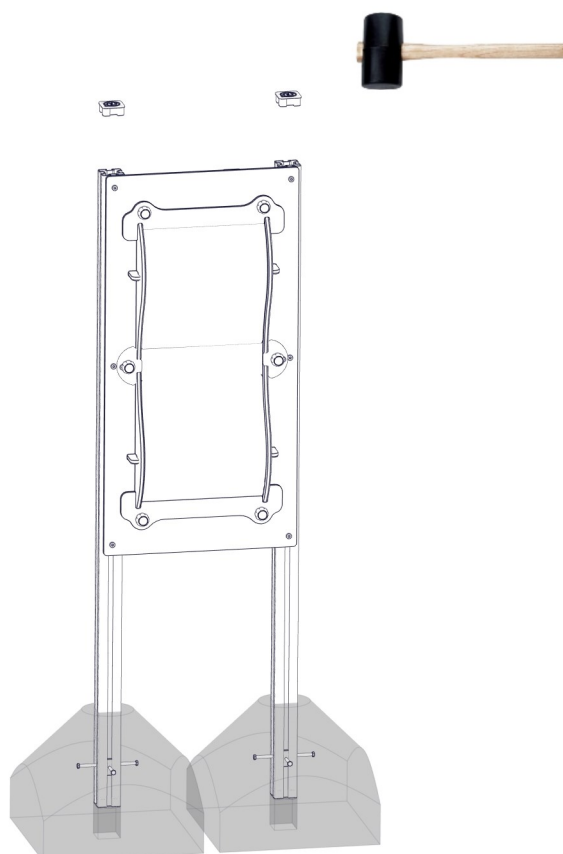

PartName	Artnr	Antall
Betongfundament 70x70	00-003-112K	2
Endelokk 70x70	00-400-996	2



Før utstyret tas i bruk / Before play begins / Innan lekredskapet tas i bruk	
N	<ul style="list-style-type: none"> ● Påse at fallunderlag er utlagt i henhold til gjeldende regler eller vår anbefaling ● Fjern alle monteringshjelpemidler (rester av betong, planker, paller, plast, og lignende) ● Før utstyret tas i bruk, burde man sjekke at det ikke er fare for at anorakksnorer og lignende som kan hekte seg fast noen steder på lekeapparatet. (Vedlagte snor med dobbe (kneledd) kan brukes til å sjekke at dette er i orden. Se vedlagte veiledning for bruk av denne. Dette gjøres for å oppdage eventuelle feilmonteringer.? ● NB! Bør stå i 2-3 dager før bruk
EN	<ul style="list-style-type: none"> ● Make sure the area and depth of safer surfacing are according to the current standard, or to the manufacturer's recommendation ● Make sure all tools and surplus materials are removed before play begins ● PS! When complete, allow 2-3 days for the concrete to set before use
S	<ul style="list-style-type: none"> ● Kontrollera att fallunderlag är utlagt enligt gällande regler eller vårt rekommendation ● Ta bort alla monteringshjälpmedel (rester av betong, plankor, pallar, plast och liknande) ● Innan lekredskapet används, kontrollera att anoracksnoddar eller kläder/delar av kläder eller liknande inte kan fastna i några delar på redskapet. (Den bipackade "knävringen" kan man med fördel användas för denna kontroll. ● Detta görs för att upptäcka eventuella felmonteringar.)

Boltepakker for / Boltpackage for / Bultpaket för

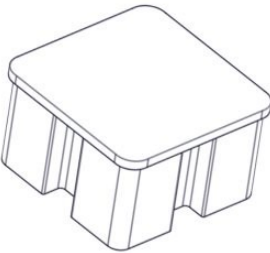
Sign. _____.

Klovnespeil på stolper 25-050-051	Navn	Artnr/ dimensjon	Ant	Lev
	Klovnespeil montert på stolper	07-201-622	1	
	Endelokk 70x70	00-400-996	2	
	Produktmerke montert hos Søve	00-100-401	0	

Boltepakker for / Boltpackage for / Bultpaket för

Sign. _____.

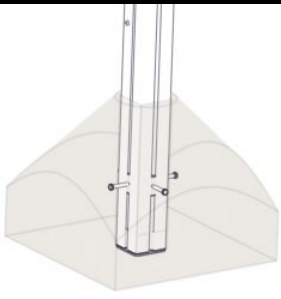
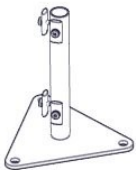
Klovnespil på stolper 25-050-051	Navn	Artnr/ dimensjon	Ant	Lev
	Fundament Støp			
	Støpefundament 70x70 stolpe	00-003-112K (se egen del- montering)	2	
	Overflate montering			
	Fundament 70x70 stolpe for betongdekke Ekstra	00-003-129k (se egen del- montering)	2	