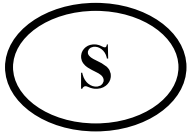

**Monteringsanvisning****Assembly Instructions****Monteringsanvisning**

Produkt nr. / Product no. / Produkt nr.

25-060-003**Sort**

Ord. nr. _____

Dato. _____

Sign. _____

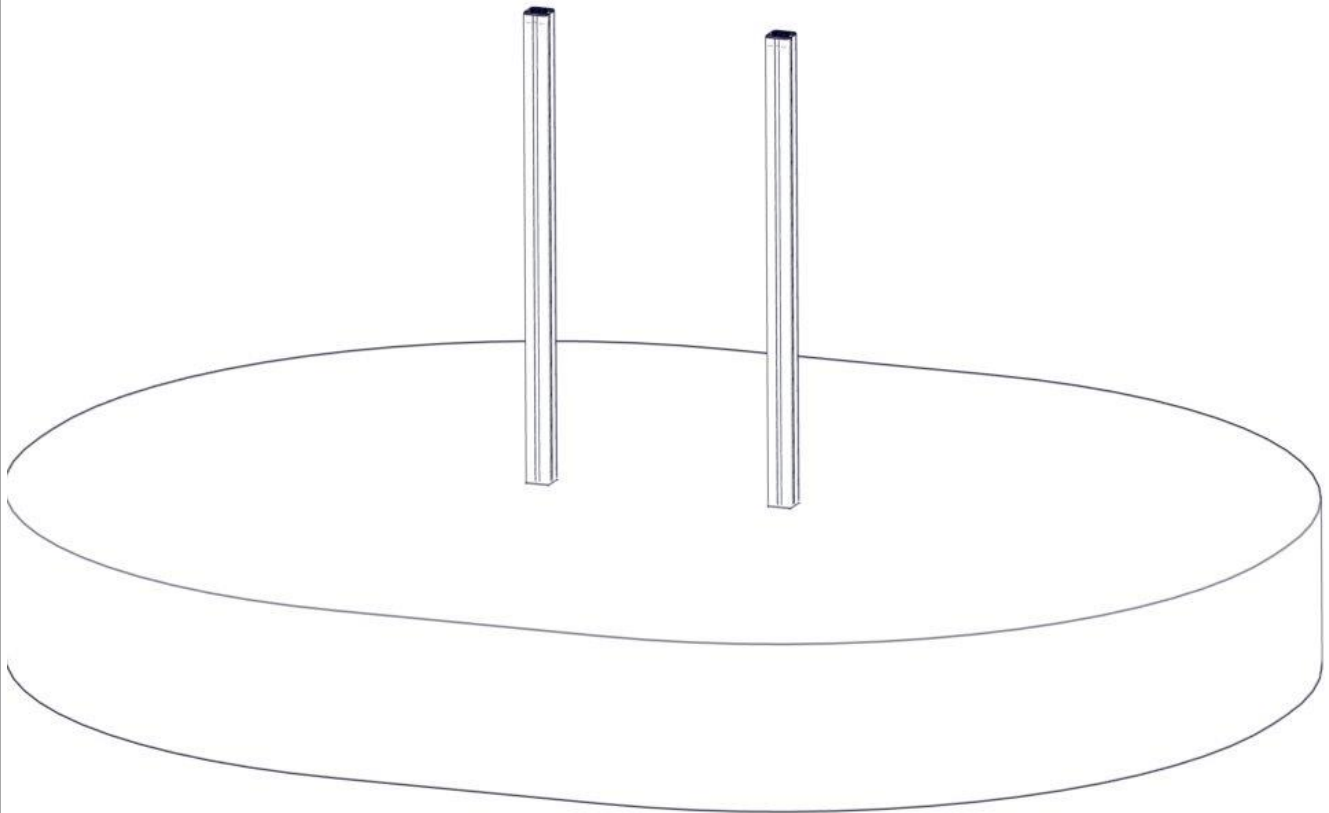
**søve**

Søve AS
Grønnvoldveien 290
3830 Ulefoss - Norway
Tlf: +47 35 94 65 65
www.sove.no

**søve**

Søve AB
EA Rosengrensgatan 32
421 31 Västra Frölunda
Phone: +46 (0)31 773 97 00
www.sove.se

Fundamentering med betong / Foundation concrete / Förankring med betong

- (N) Støtdempende materialer Ref NS-EN 1176-1
- (EN) Impact attenuating materials §4.2.8.5
- (S) Støtdämpande material



- (N) Bakkenivå
- (EN) Ground level
- (S) marknivå

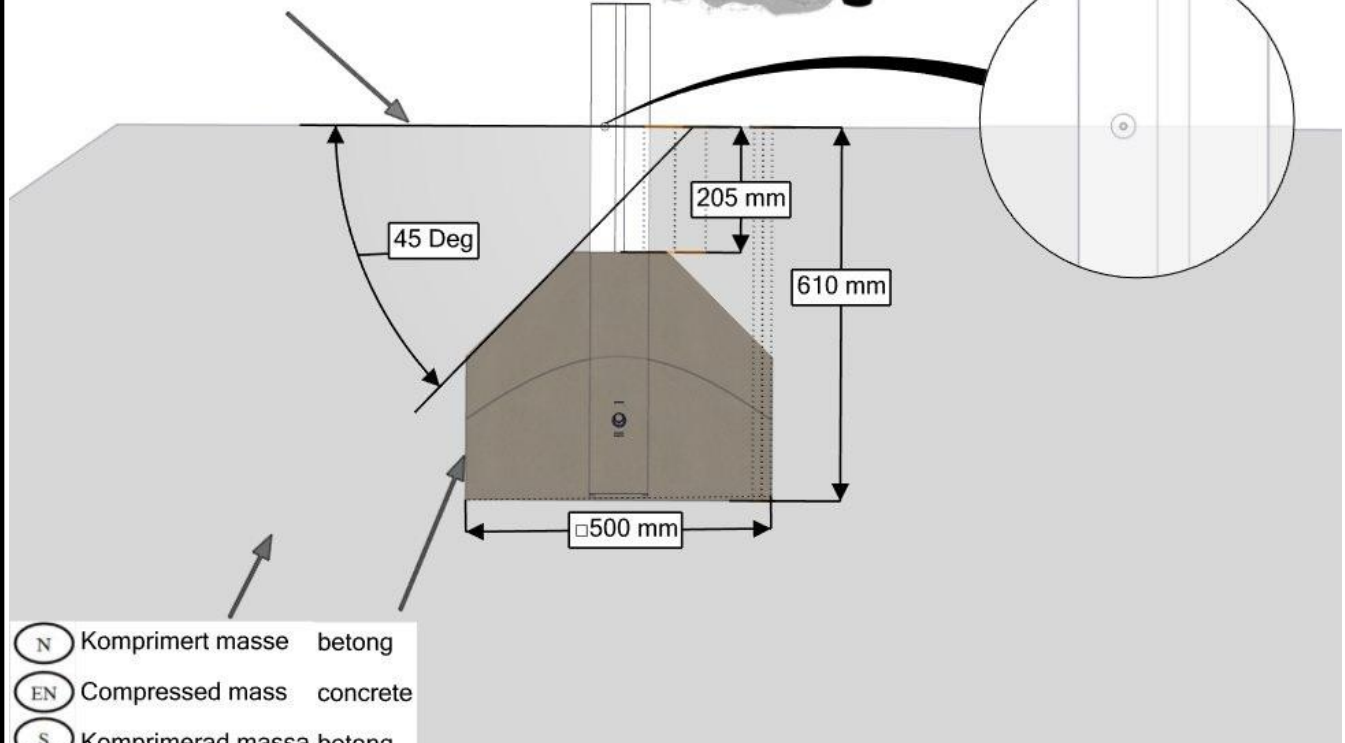

- (N) Komprimert masse betong
- (EN) Compressed mass concrete
- (S) Komprimerad massa betong



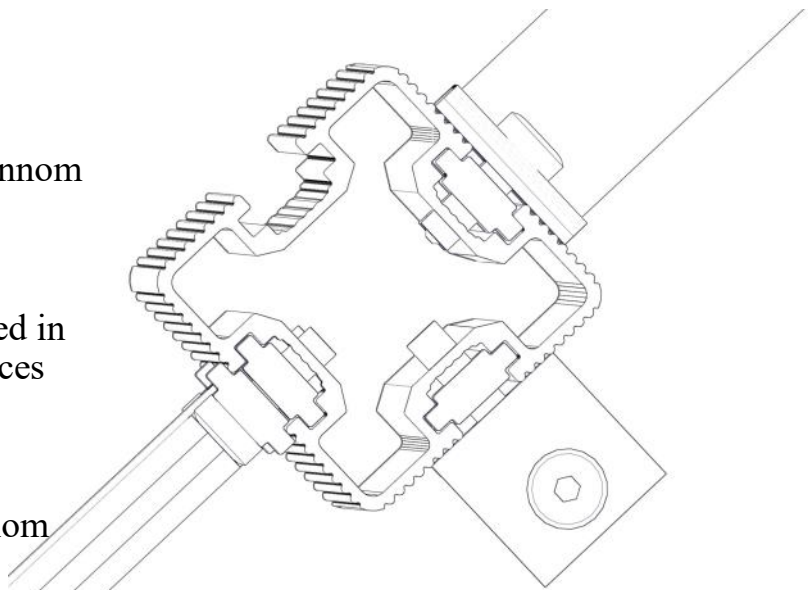

- (N) Bolten skrues HELT igjennom aluminiumen.
Maks moment: 30Nm
- (EN) The bolt must be tightened in to the post, so that it pierces the aluminium
Max torque: 30Nm
- (S) Bulten skruvas HELT genom aluminiumen.
Maks vridmoment: 30Nm

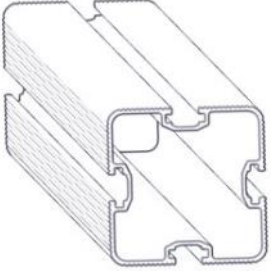

NO	Betongkvalitet	C25/30		
SE	Betongkvalitet			
EN	Concrete quality			
NO	Mengde betong		0,2	m ³
SE	Mängd betong			
EN	Amount of concrete			
NO	Fundament størrelse		0,5 x 0,5 x 0,4	m
SE	Stiftelsestorlek			
EN	Foundation size			
NO	For sikkerhet må fundamentene med sand eller myk jord være minst 50% større i areal			
SE	För säkerheten måste grunden med sand eller mjuk jord vara minst 50% större i området			
EN	For safety, the foundations with sand or soft soil must be at least 50% larger in area			
NO	Tyngste element	SFA5123/1	6	Kg
SE	Tyngsta element			
EN	Heaviest element			
NO	Største element	SFA5123/1	2x0,095x0,095	m
SE	Största element			
EN	Biggest element			

Boltepakker for / Boltpackage for / Bultpaket för

Sign. _____

2- stolper 25-060-003	Navn	Artnr/ dimensjon	Ant	Lev
	Stolpe 70x70 600-1400 L= 2000 Sort	SFA5123/1	2	
	Endelokk 70x70 Sort	00-400-996	2	
	Støpefundament 70x70 stolpe	00-003-112K (se egen del- montering)	2	
	Produktmerke	00-100-400 (montert hos Søve)	0	

Montering av lekeapparatet / Assembly instructions / Montering av lekredskapet

Se separat delmontering for detaljer
 See separate assembly for details
 Se separata delmontering för detaljer

2x





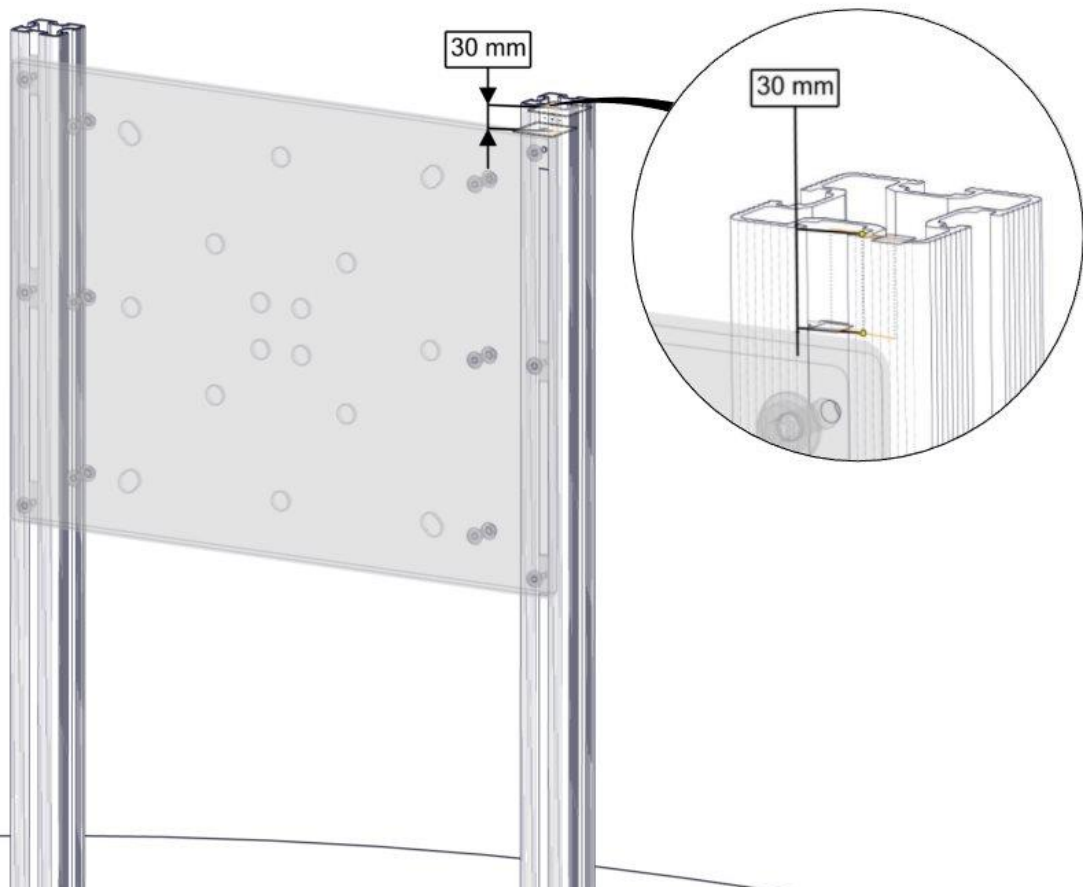

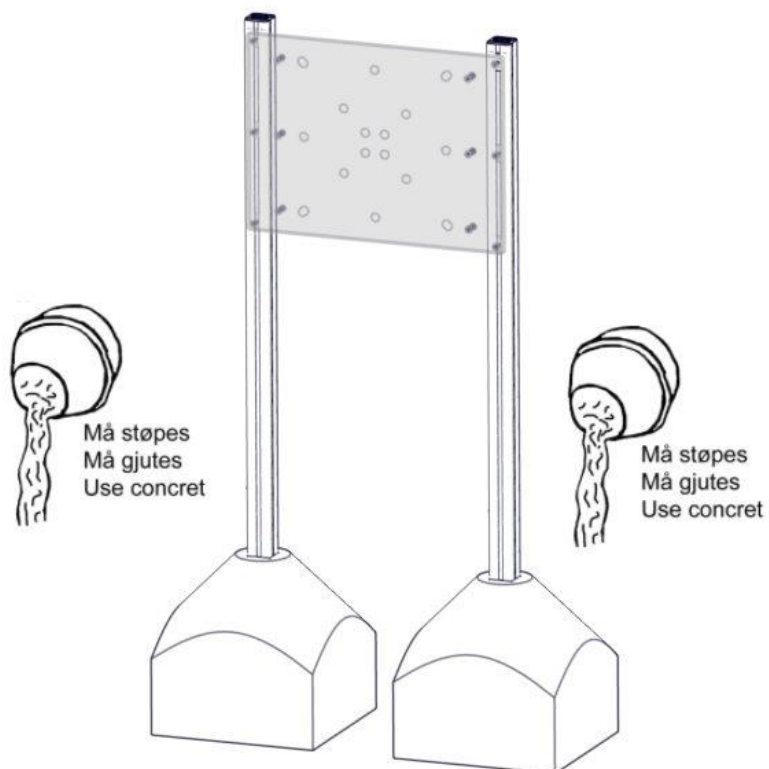
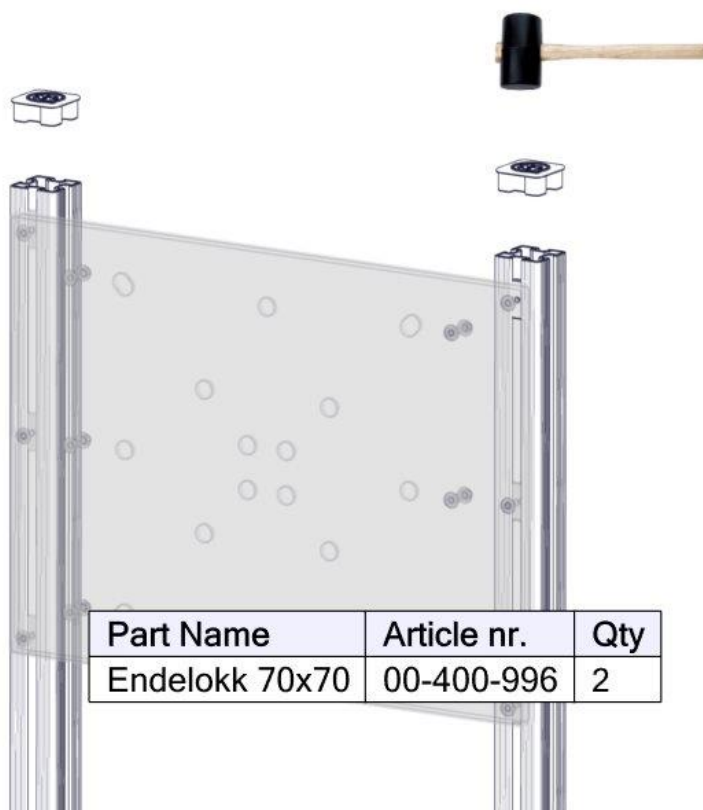
Part Name	Article nr.	Qty
Stolpe 70x70 600-1400 L=2000	SFA5123_6	1
Betongfundament 70x70	00-003-112K	1

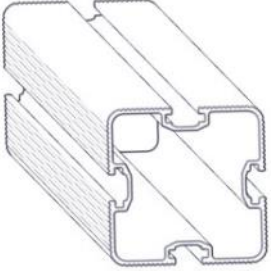

Montering av lekeapparatet / Assembly instructions / Montering av lekredskapet

Boltepakker for / Boltpackage for / Bultpaket för

Sign. _____.

2- stolper 25-060-003	Navn	Artnr/ dimensjon	Ant	Lev
	Stolpe 70x70 600-1400 L= 2000 Sort	SFA5123/1	2	
	Endelokk 70x70 Sort	00-400-996	2	
	Støpefundament 70x70 stolpe	00-003-112K (se egen del- montering)	2	
	Produktmerke	00-100-400 (montert hos Søve)	0	

Revidert

14-02-2020

Lagt inn spesifikasjonstabell

MTK 30-11-2020

Med produktmerking