



Monteringsanvisning



Assembly Instructions



Monteringsanvisning

Produkt nr. / Product no. / Produkt nr.

25-200-010

Ordr. nr. _____

Dato. _____

Sign. _____

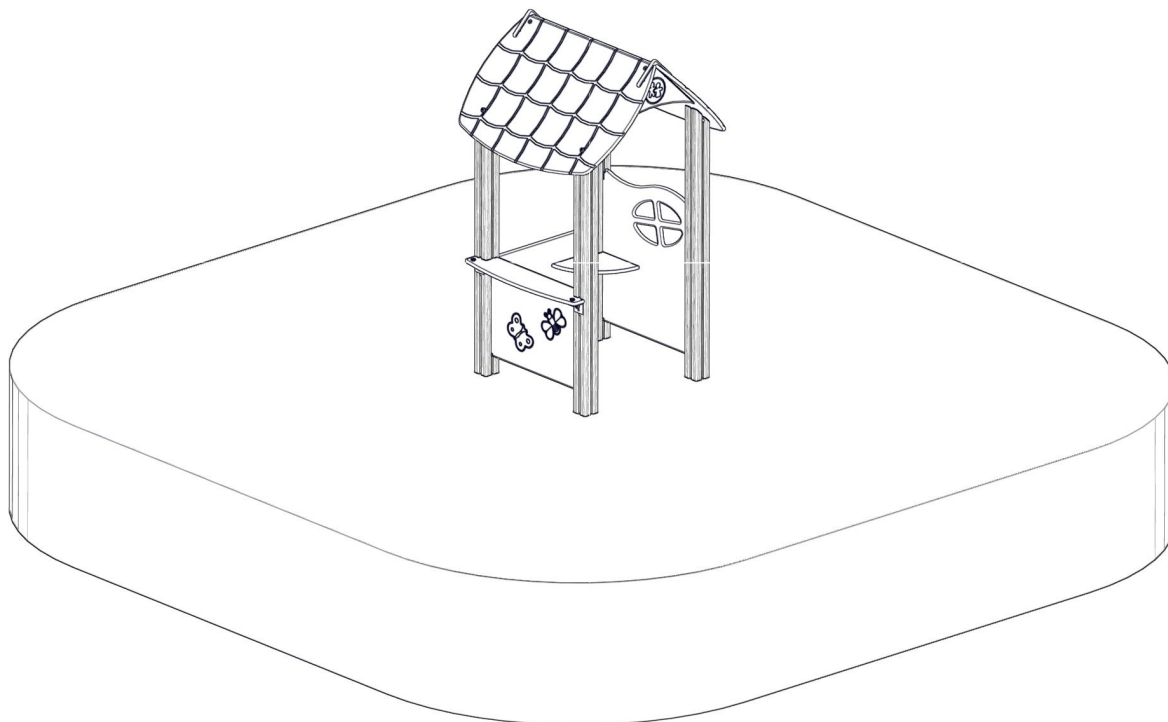

søve

Søve AS
Grønnvoldveien 290
3830 Ulefoss - Norway
Tlf: +47 35 94 65 65



søve

Søve AB
EA Rosengrensgatan 32
421 31 Västra Frölunda
Phone: +46 (0)31 773 97 00
www.sove.se

Monteringstips / Assembly Advice / Monteringsstips**N**

- Les monteringsanvisningen nøye før montering.
- Monter elementene i rekkefølgen som vist.
- Boltene bør ikke skrues for hardt til før alt er montert, vatret og loddet. Skru så boltene til.
- NB! Ved bruk av drill, kan boltene ryke.
- På grunn av at solen kan gjøre rutsjeflaten veldig varm, bør rutsjebanens utløp vende mot nord-øst eller nord-vest.
- Er lekeutstyret plassert i naturlige ferdselstraséer må området sikres mot gjennomgang.
- Innspringningshinder bør vurderes rundt lekeapparater hvor det er stor bevegelse, f.eks. ved huskestativ.
- Det bør være fritt innsyn til lekeutstyr som er beregnet for barn under 3 år.

NB! Under monteringsarbeidet må utstyr, som ikke er forankret forsvarlig i bakken, sikres slik at det ikke velte.

Området må avstenges under montering av apparatene med sperrebånd eller lignende.

EN

- Read the instruction carefully before assembling the play unit..
- Assemble the components in the sequence shown in these instructions.
- Fixings must not be fully tightened during assembly. Before casting the foundations, the structure must be level and plumb, at which point all fixings are tightened.
- PS! If use of drill, the bolts may be wrecked.
- Avoid positioning the slide facing due south because of overheating – ideal positions are facing north-east or north-west.
- Secure the construction-area to prevent people from walking through it.
- Consider installing barriers around play-equipment which gives rise to a lot of activity – i.e.swings.
- Ensure that clear vision is possible across the play area so that supervision is possible from any position, particularly where children under 3 years of age will be playing.

NB! During assembly of the equipment, ensure that all structures are securely propped, especially when left overnight. Also ensure that equipment is supported whilst concrete foundations are setting and enclose the area securely to prevent access.

Monteringstips / Assembly Advice / Monteringsstips**S**

- Läs monteringsanvisningen noga före montering.
- Montera delarna i den ordningen som anvisas
- Skruvarna bör inte skruvas för hårt tills allt är monterat, i våg och lodat.









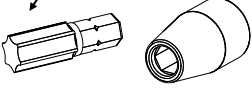

OBS! Används elektrisk skruvdragare, kan bulten gå sönder. Hårdtra därför manuellt!

- Solen kan göra att rutchbanan blir väldigt varm. Banans nedfart rekommenderas att vändas i norrlig riktning
- Om lekplatsen placeras vid en gångväg mm bör området säkras mot genomfart av gående och cyklister.
- Inspjningshinder bör placeras runt lekutrustning med stor rörelse, t ex, gungställning.
- Det bör vara fri insyn till lekutrustning beräknat till barn under 3 år.

OBS! Under monteringsarbete bör utrustningen som inte ska förankras i marken, ställs så att den inte kan välta.

Området måste spärras när lekutrustningen byggs upp, med avspärrningsband eller liknande.

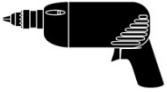
Nødvendig verktøy / Tools required / Nödvändiga verktyg

<p>(N)</p> <p>(EN)</p> <p>(S)</p>	<p>(A)</p> 	<p>(B)</p>  <p>Torx Nr 45 High quality</p> 	<p>(C)</p> <p>5 mm 6 mm</p> 	<p>(D)</p> 	<p>(E)</p> 
		<p>Metermål Metric measure Tumstock</p> 	<p>16 V</p> 	<p>Merkebånd Mark ribbon Märkeband</p> 	<p>13 + 17mm</p> 

Nødvendig antall personer / Number of persons required / Rekommenerad antal personer





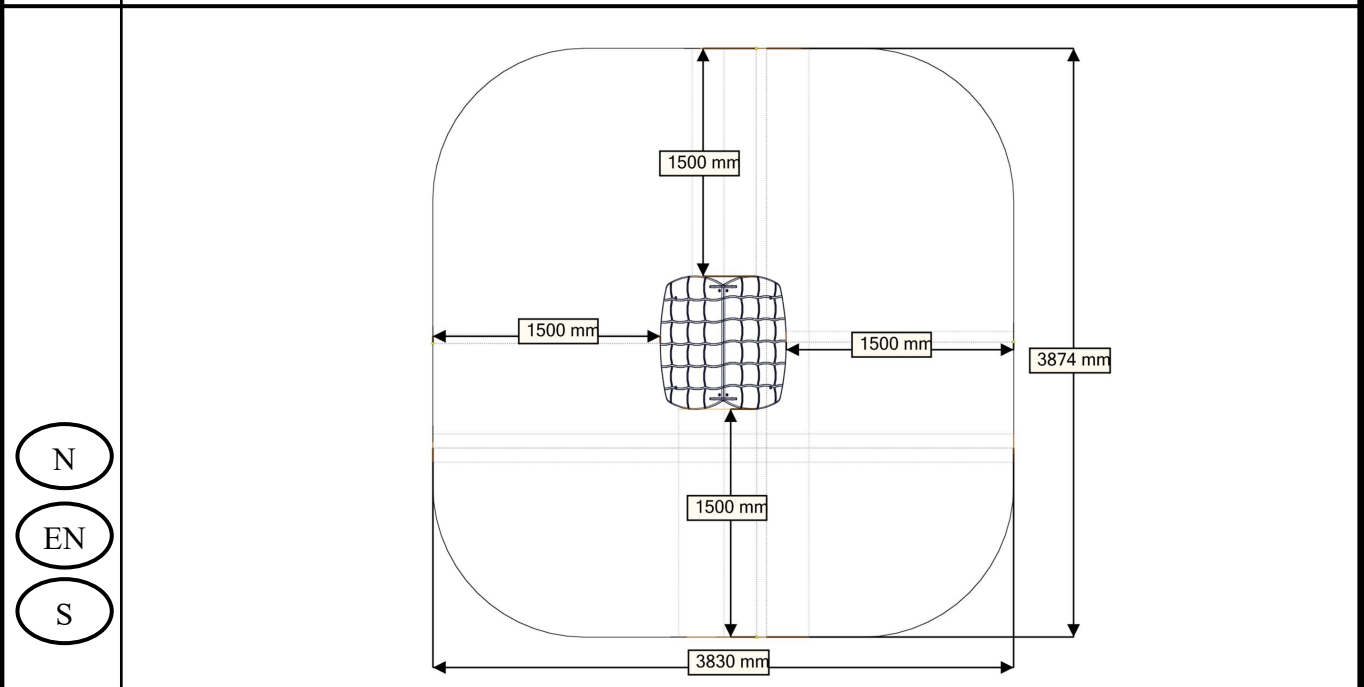





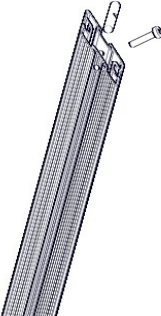

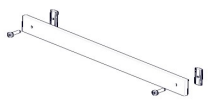
Anbefalt arealbehov ved montering / Recommended working space / Rekommenderad arealbehov vid montering

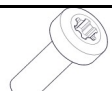
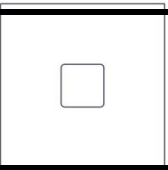
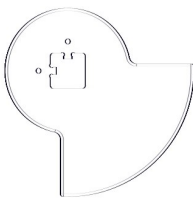















Boltepakker for / Boltpackage for / Bultpaket för

Sign. _____

Stolpe 70x70 skrå	Ant= 4	Navn	Artnr/dimensjon	Ant	Lev
		VK70 skrå 1150-400 (1)	07-510-155	4	
		Torx M8x40 (1)	04-000-040	4	
		Hullsemutter (1) VK70	04-018-070	4	
FundamentMini 660	Ant= 4	Navn	Artnr/dimensjon	Ant	Lev
		miniSprosse 660 (1)	07-510-200	4	
		Brikke 50_1T (2)	04-060-050	8	
		Torx M8x35 (2)	04-000-035	8	
FundamentSkive	Ant= 4	Navn	Artnr/dimensjon	Ant	Lev
		Skive (1)	07-510-201	4	
Sete rund stolpe	Ant= 1	Navn	Artnr/dimensjon	Ant	Lev
		Sete rund stolpe	07-510-132	1	
		Vinkel 35x35x3(2) 11mm	04-070-036	2	
		Møbelknapp(2)	04-030-011	2	
		Brikke 501T(2)	04-060-050	2	
		Torx M8x12 (2) Torx M8x20 (2)	04-000-012 04-000-020	2 2	
		Skive M8 (2)	04-050-008	2	

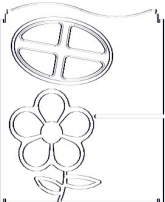
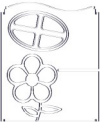











Boltepakker for / Boltpackage for / Boltpaket för

Sign. _____

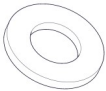
Vegge 520x400 spor Sommerfugl/bie	Ant= 1	Navn	Artnr/dimensjon	Ant	Lev
		Vegge520x400(1) Sommerfugl /bie Med spor	07-510-112	1	
		Brikkespesial(4)	04-060-051	4	
		Brikke(4)	04-060-050	4	
		Torx M8x25(4)	04-000-025	4	
Vegge 520x400 Sommerfugl / bie	Ant= 1	Navn	Artnr/dimensjon	Ant	Lev
		Vegge520x400 (1) Sommerfugl/bi	07-510-110	1	
		Brikkespesial(4)	04-060-051	4	
		Brikke(4)	04-060-050	4	
		Torx M8x25(4)	04-000-025	4	
Vegge 520x600 Spor Vindu bloms	Ant= 1	Navn	Artnr/dimensjon	Ant	Lev
		Vegge520x600 (1) Vindu blom med spor	07-510-121	1	
		Brikkespesial(4)	04-060-051	4	
		Brikke(4)	04-060-050	4	
		Torx M8x25(4)	04-000-025	4	

Boltepakker for / Boltpackage for / Bultpaket för

Sign. _____

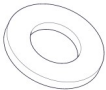
Tak	Ant= 1	Navn	Artnr/dimensjon	Ant	Lev
		Tak mini (2)	07-510-105	2	
		Gavelplate(2)	07-510-106	2	
		Vinkel 35x35x3(2) 11mm	04-070-036	2	
		Møbelknapp	04-030-011	4	
		Torx M8x12(4)	04-000-012	4	
		Skive M8 (4)	04-050-008	4	
Buttikkdisk	Ant= 1	Navn	Artnr/dimensjon	Ant	Lev
		Buttikkdiskk	07-510-130	1	
		Vinkel 50x50x4(2) 11mm	04-070-050	2	
		Møbelknapp(2)	04-030-011	2	
		Brikke 501T(2)	04-060-050	2	
		Torx M8x12 (2) Torx M8x20 (2)	04-000-012 04-000-020	2 2	
		Skive M8 (2)	04-050-008	2	

Boltepakker for / Boltpackage for / Bultpaket för

Sign. _____.

Produktmerke	Ant= 1	Navn	Artnr/dimensjon	Ant	Lev
		Produktmerking Hos Søve	25-200-090	1	

Fundamentering med betong // Foundation concrete // Förankring med betong

(N)	Støtsand		(N)	(UK)	(S)
(UK)	Safer surface		Bakkenivå	Ground level	Marknivå
(S)	Stridsan		↓ Ref NS-EN 177		
(N)	Komprimert masse.	betong			
(UK)	Compressed mass.	concrete			
(S)	Komprimerad massa.	betong			

Fundamentering uten betong // Foundation without concrete // Förankring utan betong

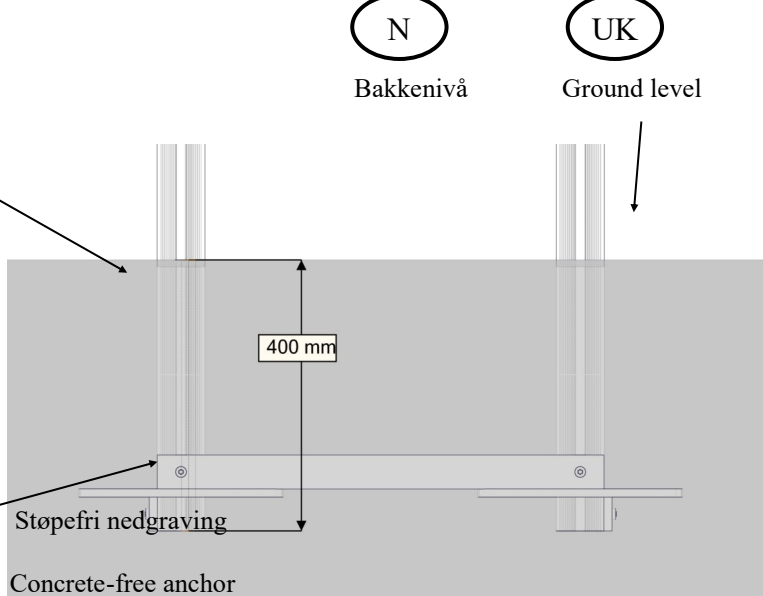
(N)	Støtsand		(N)	(UK)	(S)
(UK)	Safer surface		Bakkenivå	Ground level	Marknivå
(S)	Stridsan		↓ Ref NS-EN 1177		
(N)	Komprimert masse	Støpefri nedgraving			
(UK)	Compressed mass	Concrete-free anchor			
(S)	Komprimerad massa	Nedgrävningfundament			

(N)	Alle mål er oppgitt i millimeter
(UK)	Scale measured in mm
(S)	Alla mått är i millimeter.

Fundamentering klatrenett / Foundation nets / Förankring klätternät

- N** For klatrenett
- UK** For climbing net
- S** För klätternät

- | | | |
|-----------|-------------------|-----------------------|
| N | Komprimert masse | Støpefri nedgraving |
| UK | Compressed mass | Concrete-free anchor |
| S | Komprimerad massa | Nedgravningsfundament |

- N** Dybde for støping og forankring
- UK** Depth for foundations
- S** Djup för gjutning och markförankring

- N** Alle mål er oppgitt i millimeter
- UK** Scale measured in mm
- S** Alla mått är i millimeter.

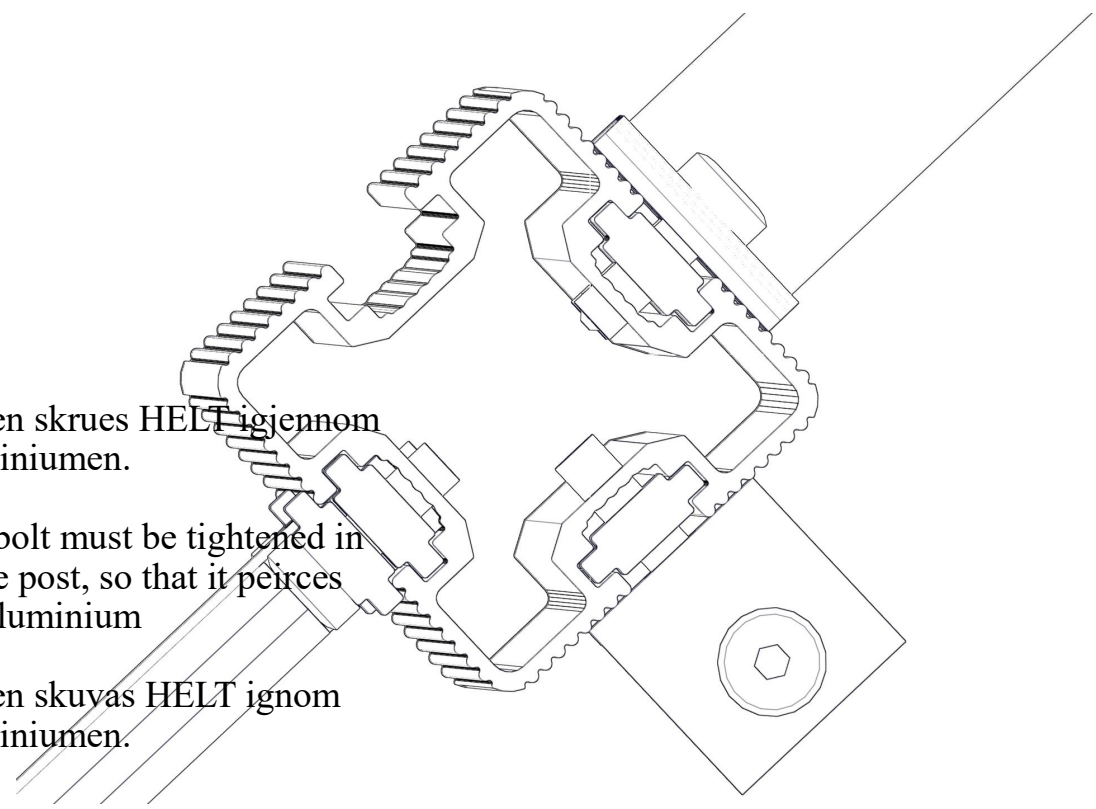
<p data-bbox="119 1556 215 1624">N</p> <p data-bbox="119 1691 215 1758">UK</p> <p data-bbox="119 1848 215 1915">S</p>	 <p data-bbox="231 1579 702 1668">Bolten skrues HELT igjennom aluminiumen.</p> <p data-bbox="231 1691 686 1825">The bolt must be tightened in to the post, so that it peirces the aluminium</p> <p data-bbox="231 1848 662 1937">Bulten skuyas HELT ignom aluminiumen.</p>

Fallhøyder / Free height of fall / Fallhöjder

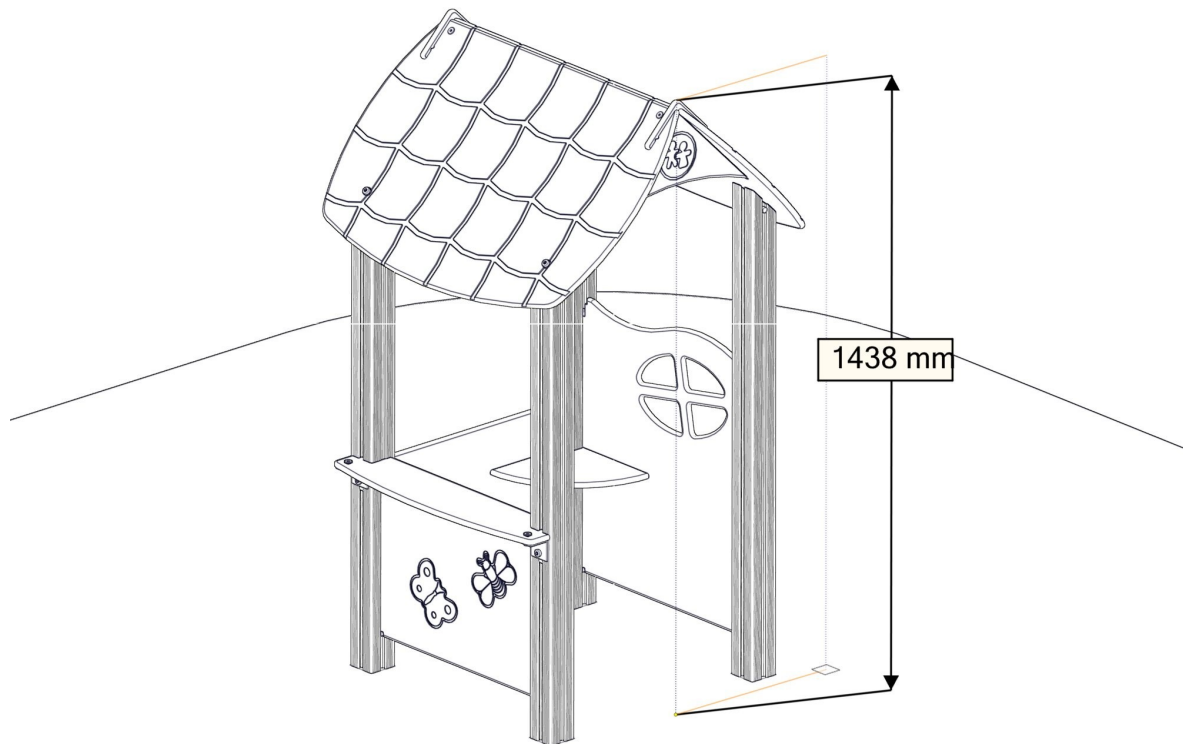

Sikkerhetszone / Safety zone / Säkerhetszon

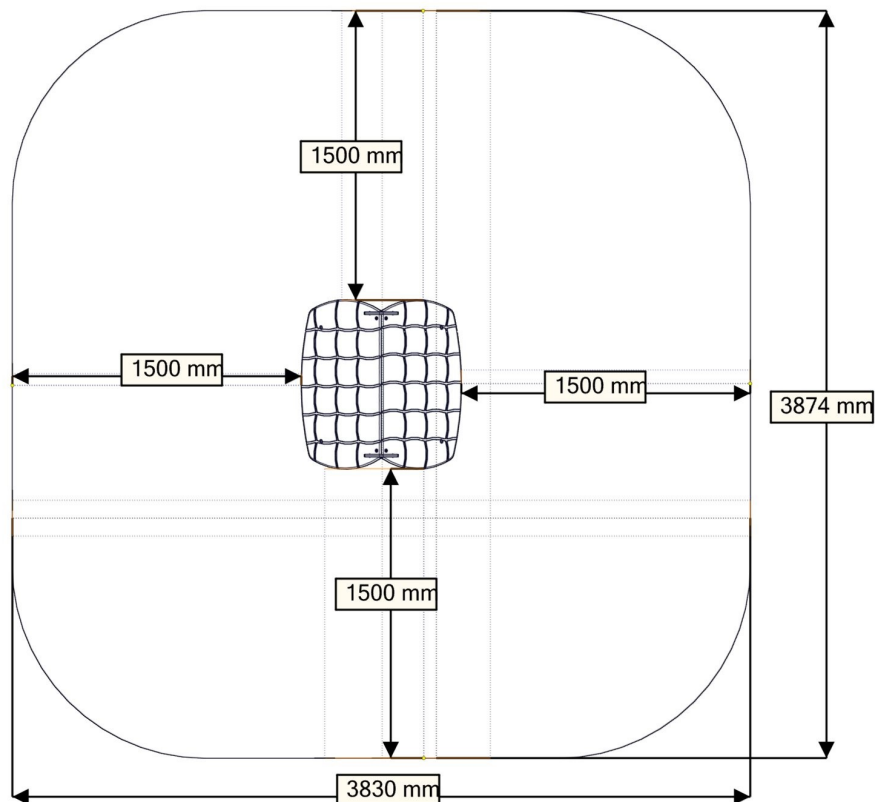

Plassering av forankringer / Ground plan / Placering av förankringar

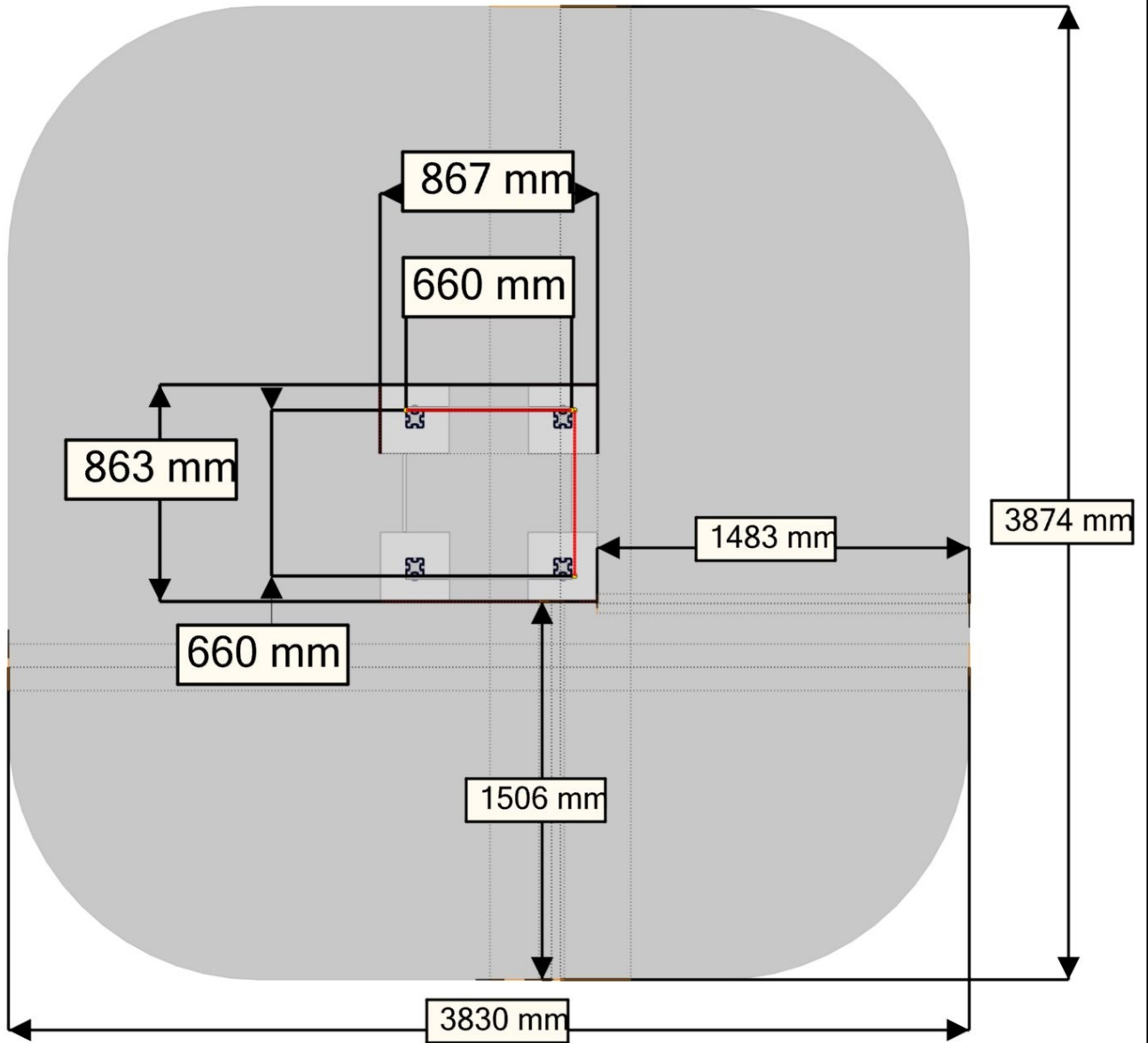

N

Alle mål er oppgitt i millimeter

UK

Scale measured in mm

S

Alla mått är i millimeter.

Montering av lekeapparatet / Assembly instructions / Montering av lekredskapet

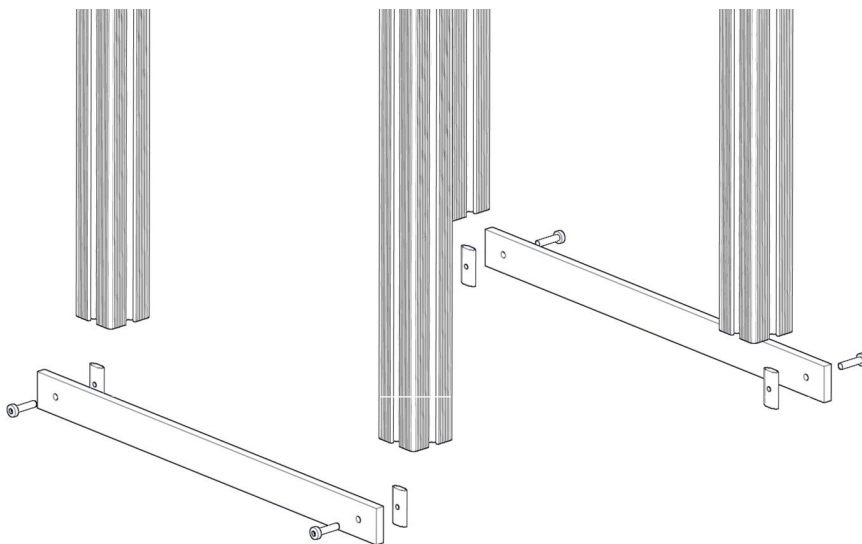
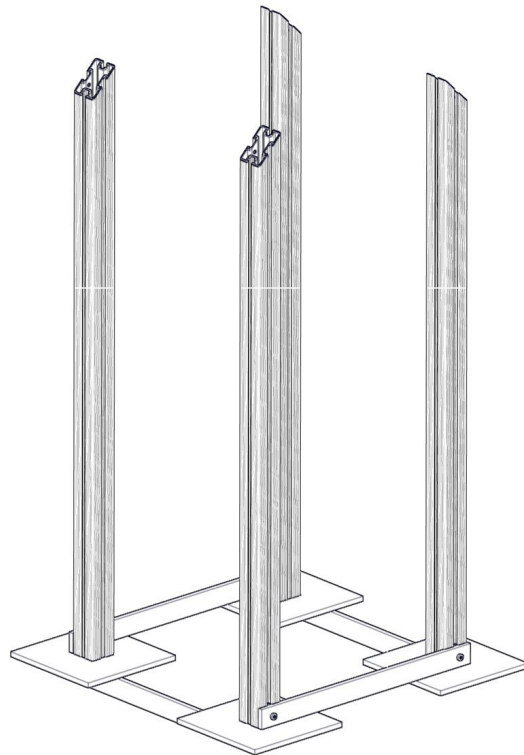

BOM ID	Name	SW Configuration	Artnr (config)	Qty
1	TorxM8-	TXM8x35	04-000-035	4
2	brikke_SFA5116-	50_1T	04-060-050	4
3	VK70_SFA5123_miniSkra-1	1150-400	07-510-155	4
4	minifun_sprosse-1	660	07-510-200	2

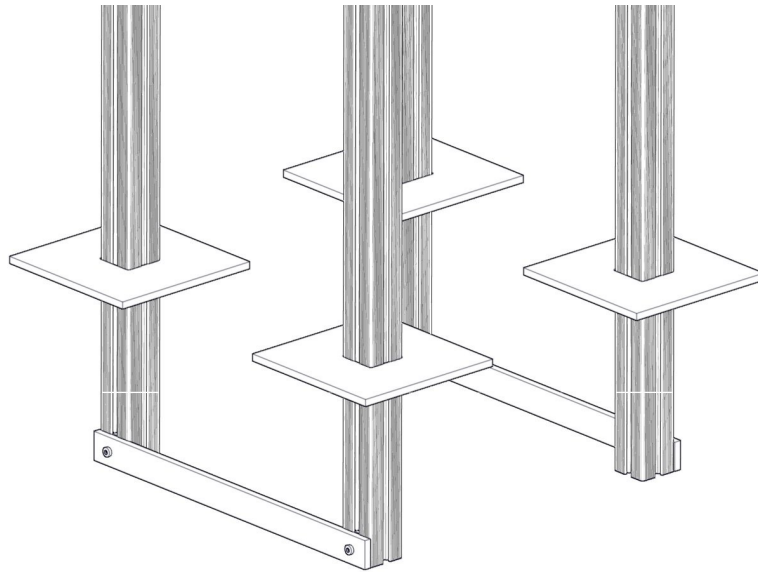

BOM ID	Name	SW Configuration	Artnr (config)	Qty
1	minifunSkive-	Default	07-510-201	4

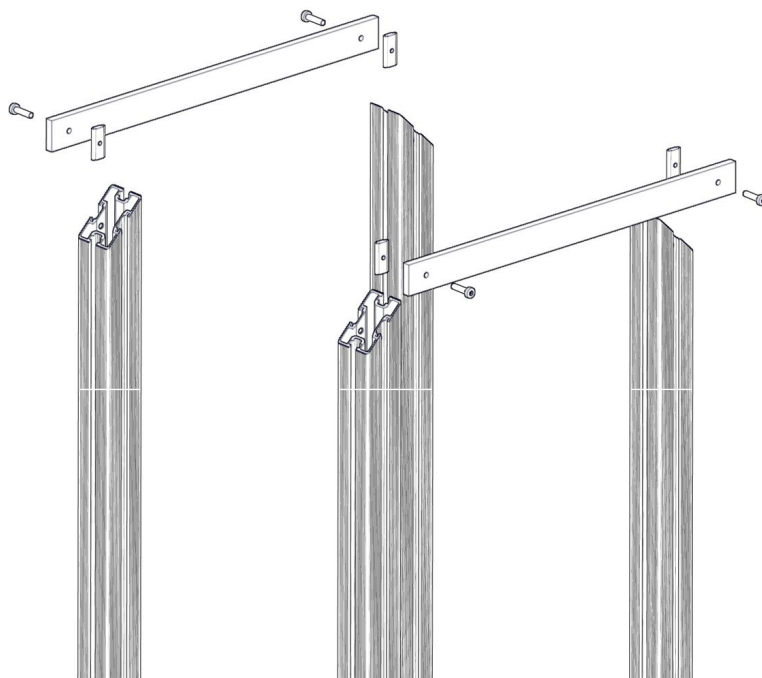

BOM ID	Name	SW Configuration	Artnr (config)	Qty
1	TorxM8-	TXM8x35	04-000-035	4
2	brikke_SFA5116-	50_1T	04-060-050	4
3	minifun_sprosse-1	660	07-510-200	2

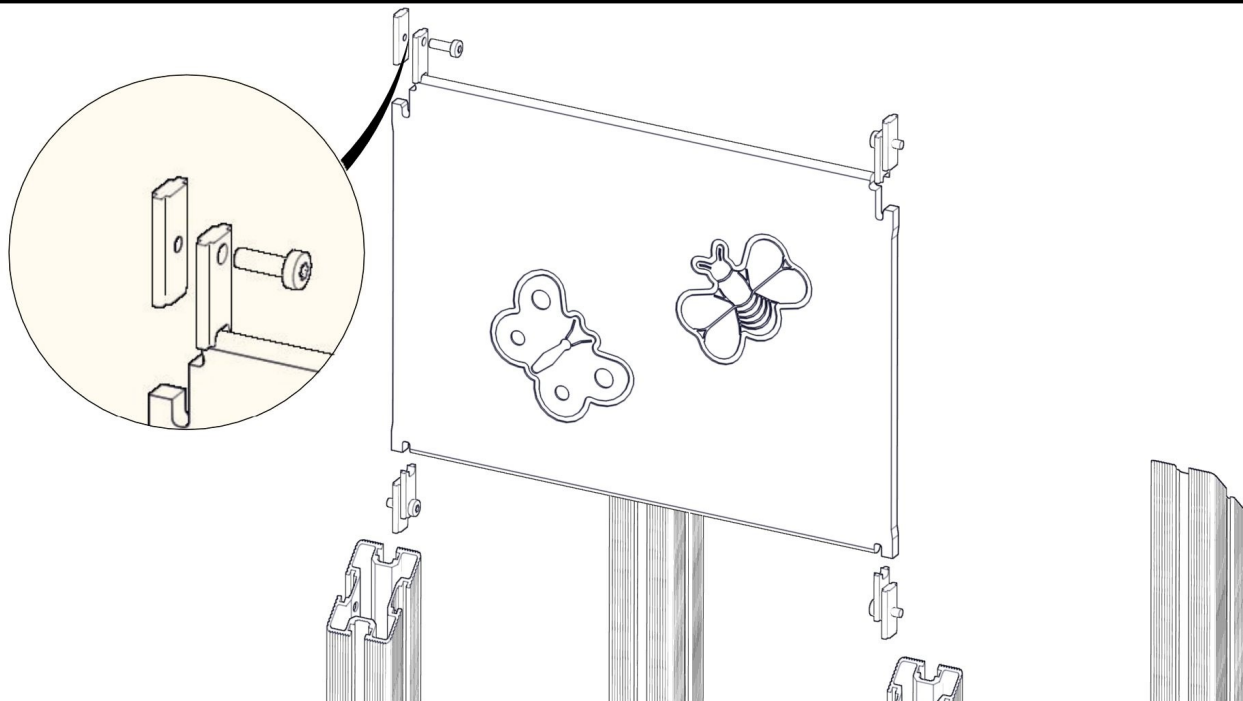
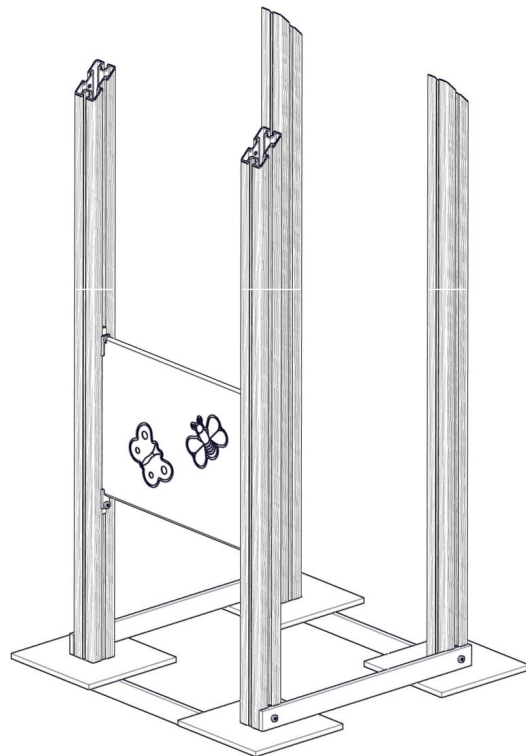

BOM ID	Name	SW Configuration	Artnr (config)	Qty
1	TorxM8-1	TXM8x25	04-000-025	4
2	brikke_SFA5116-1	50_1T	04-060-050	4
3	brikke_SFA5116Special-1	12mm	04-060-041	4
4	VeggMini520x400-1	STD	07-510-110	1

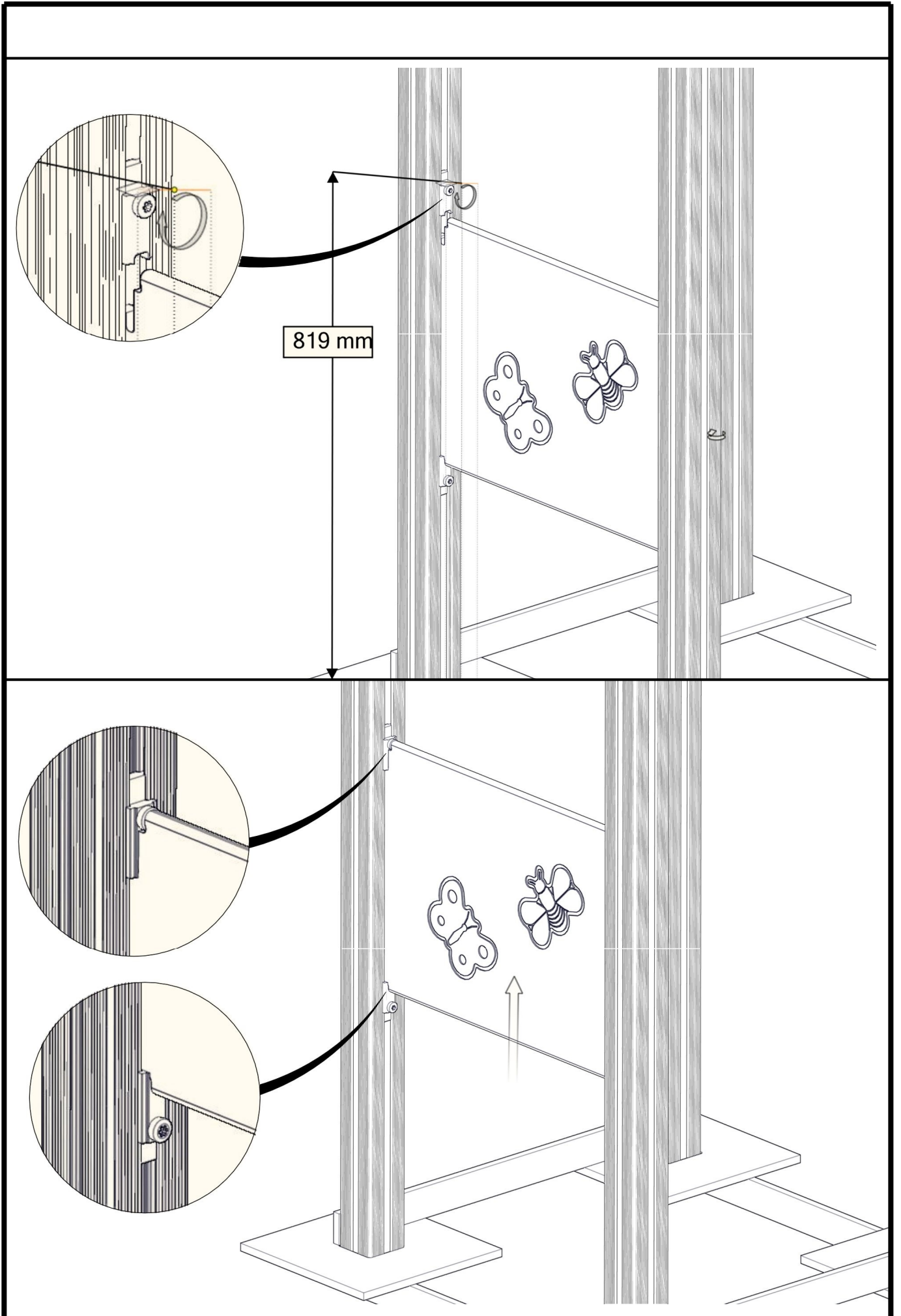

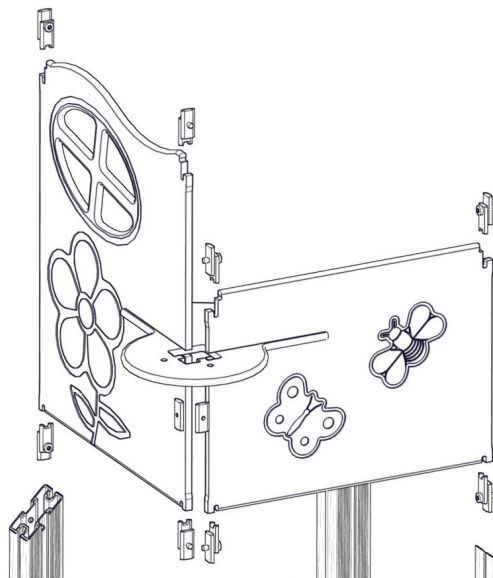
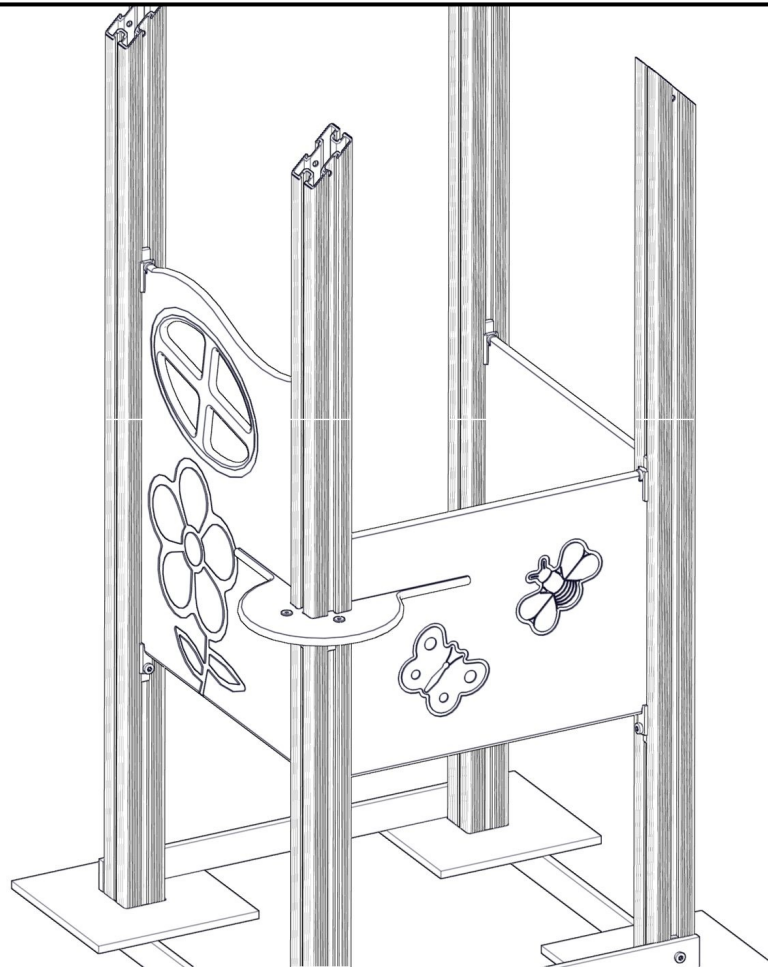

BOM ID	Name	SW Configuration	Artnr (config)	Qty
1	Torxm8-1	TXM8x25	04-000-025	8
2	brikke_SFA5116-1	50_1T	04-060-050	10
3	brikke_SFA5116Special-1	12mm	04-060-041	8
4	VeggMini520x400-1	Med_Spor	07-510-112	1
5	VeggMini520x600-1	Rvindo_Spor2	07-510-121	1
6	SeteRundStolpe-1	Stor	07-510-132	1

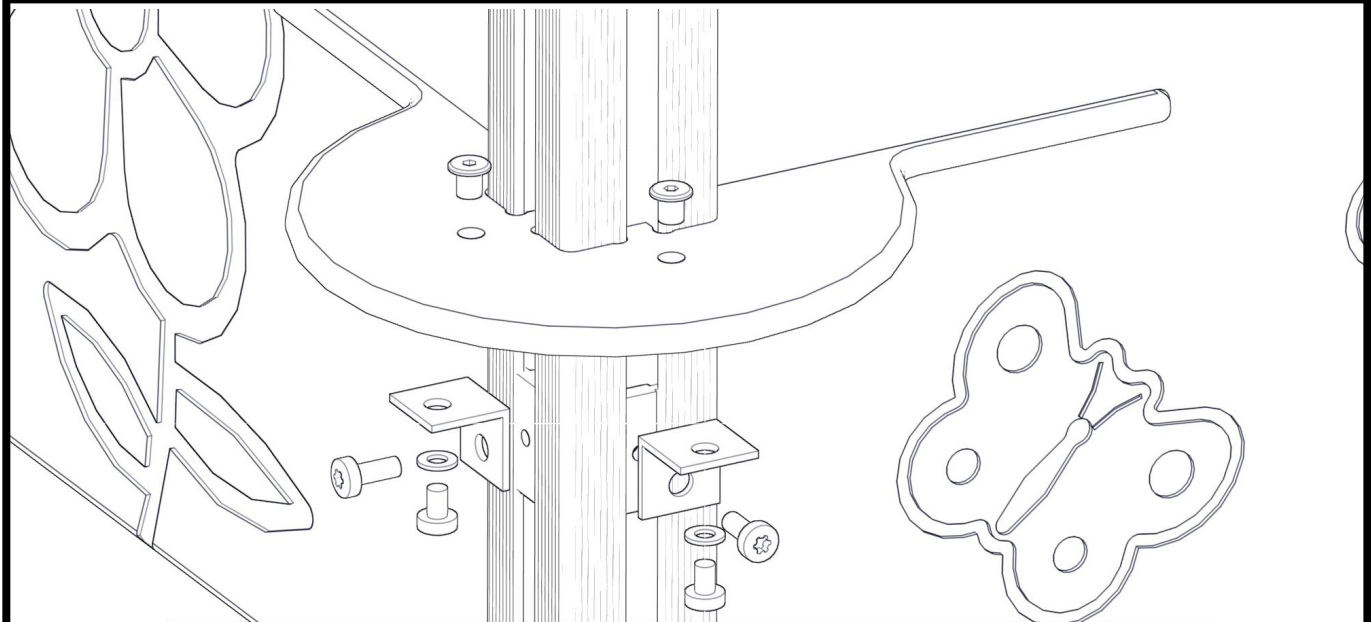
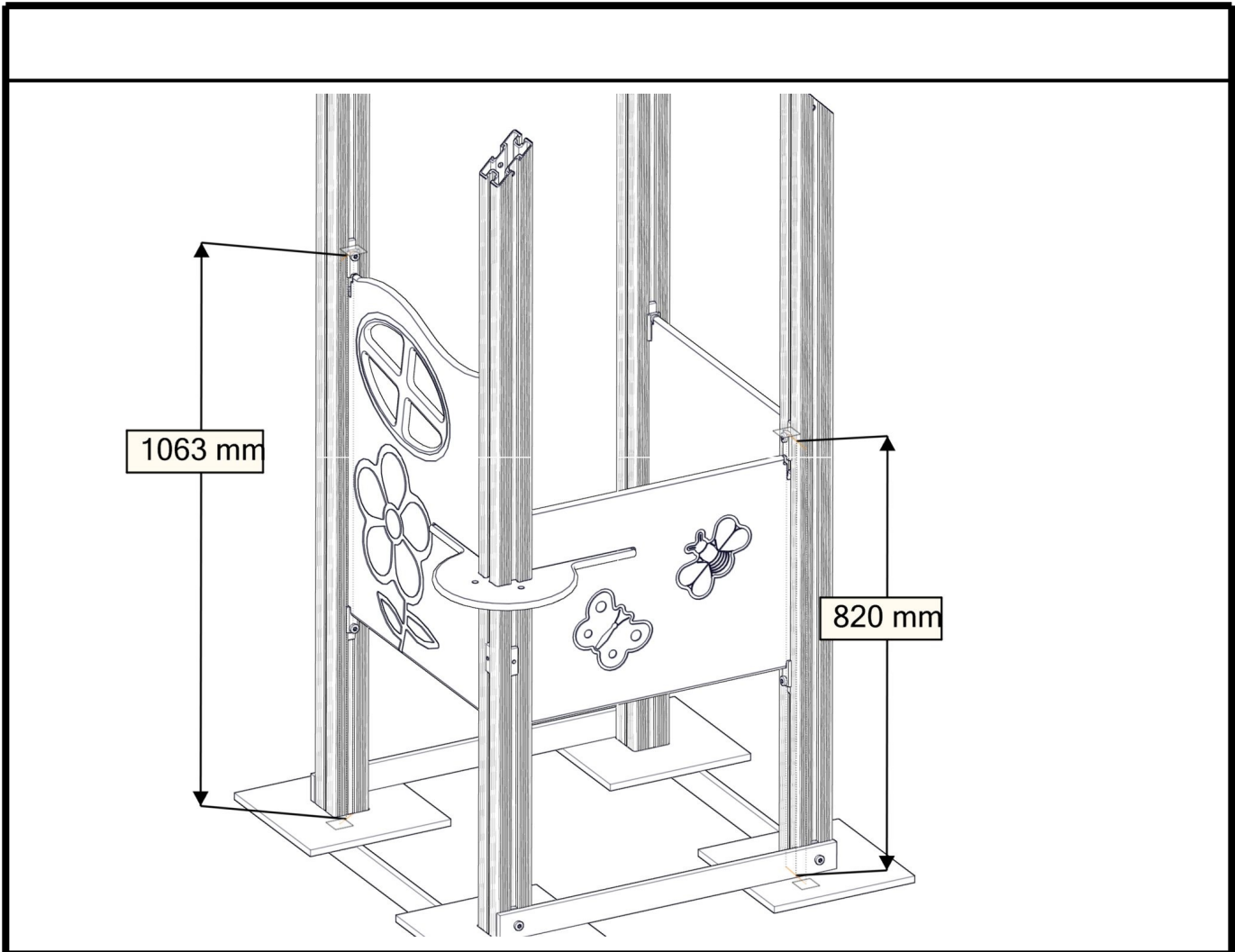

BOM ID	Name	SW Configuration	Artnr (config)	Qty
1	TorxM8-1	TXM8x12	04-000-012	2
2	TorxM8-2	TXM8x20	04-000-020	2
3	Mobelknapp-1	M8_13_17	04-030-011	2
4	Skive-1	M8	04-050-008	2
5	35x35x3-1	11mm	04-070-036	2

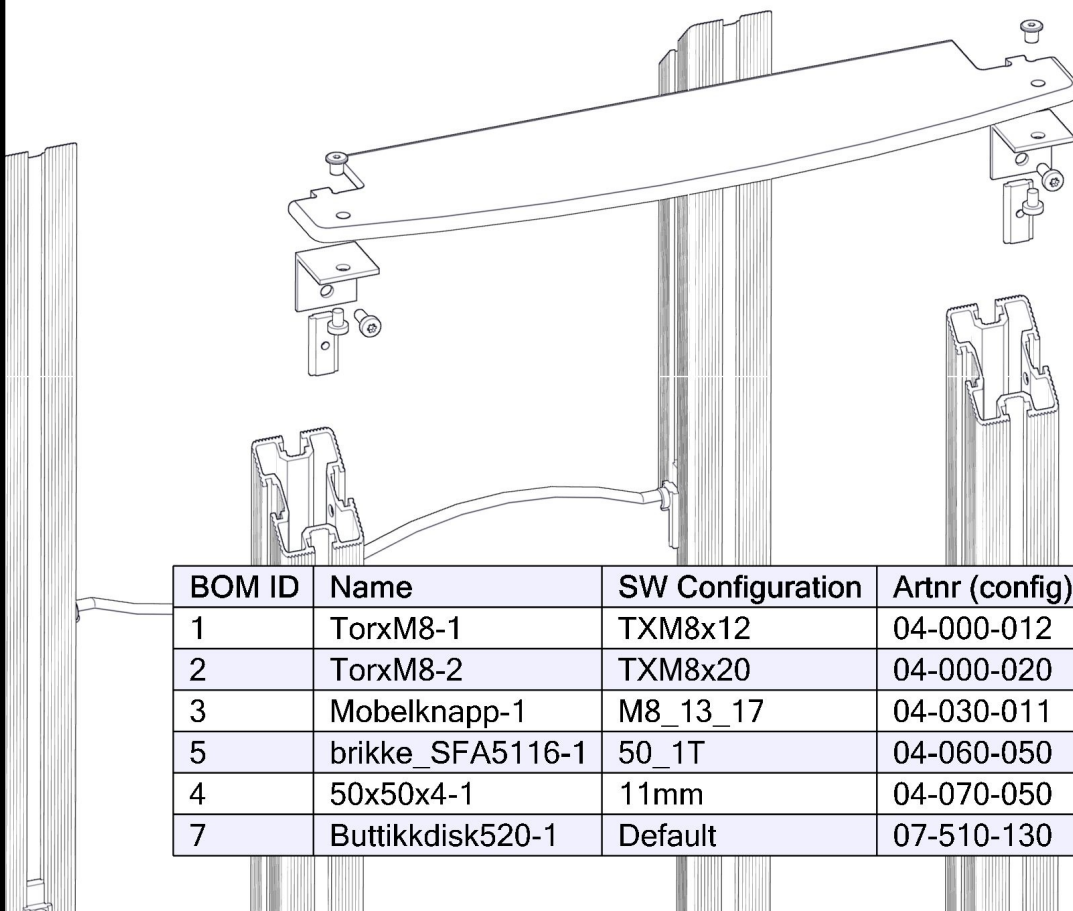
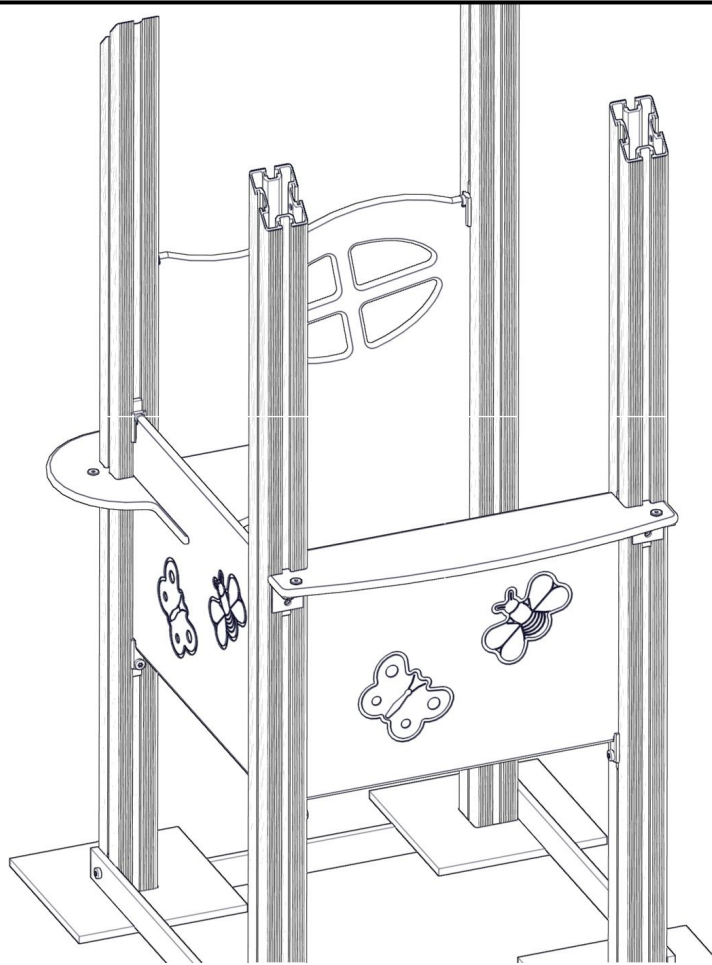

BOM ID	Name	SW Configuration	Artnr (config)	Qty
1	TorxM8-1	TXM8x12	04-000-012	2
2	TorxM8-2	TXM8x20	04-000-020	2
3	Mobelknapp-1	M8_13_17	04-030-011	2
5	brikke_SFA5116-1	50_1T	04-060-050	2
4	50x50x4-1	11mm	04-070-050	2
7	Buttikkdisk520-1	Default	07-510-130	1

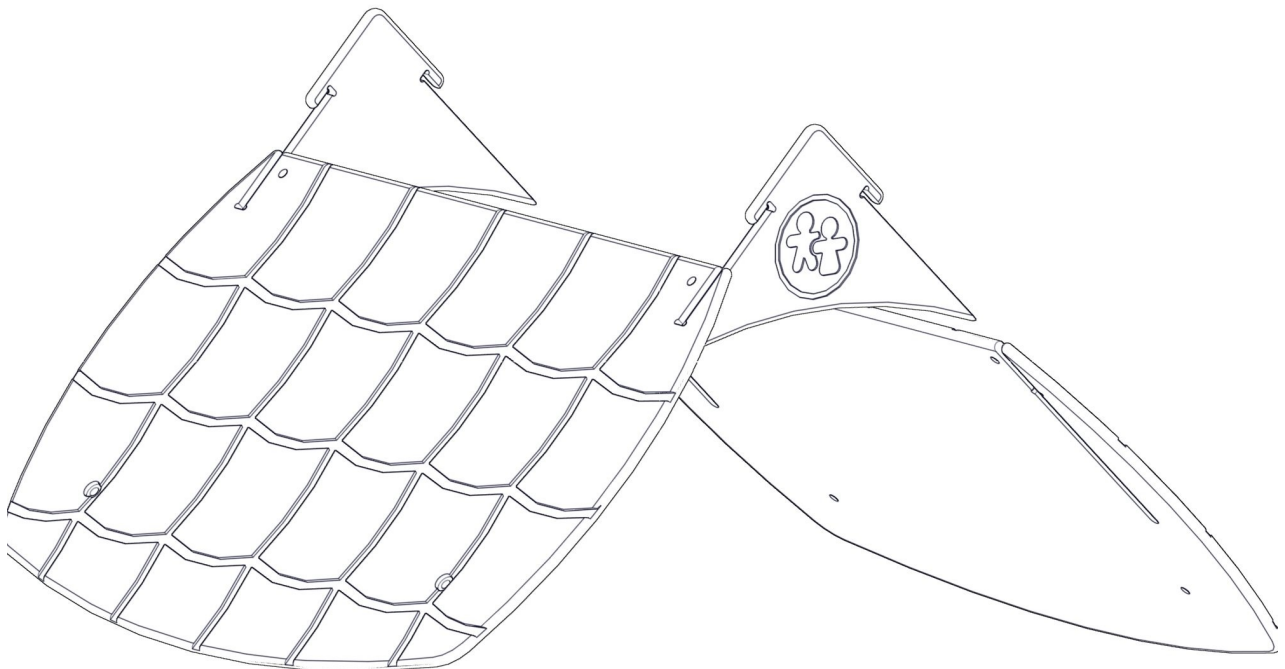
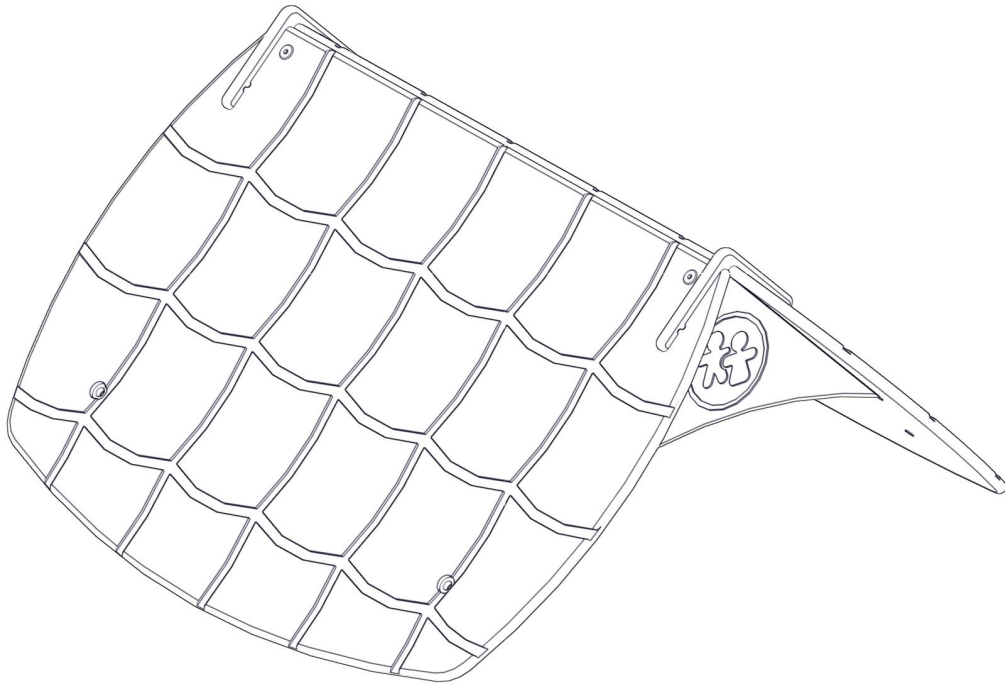



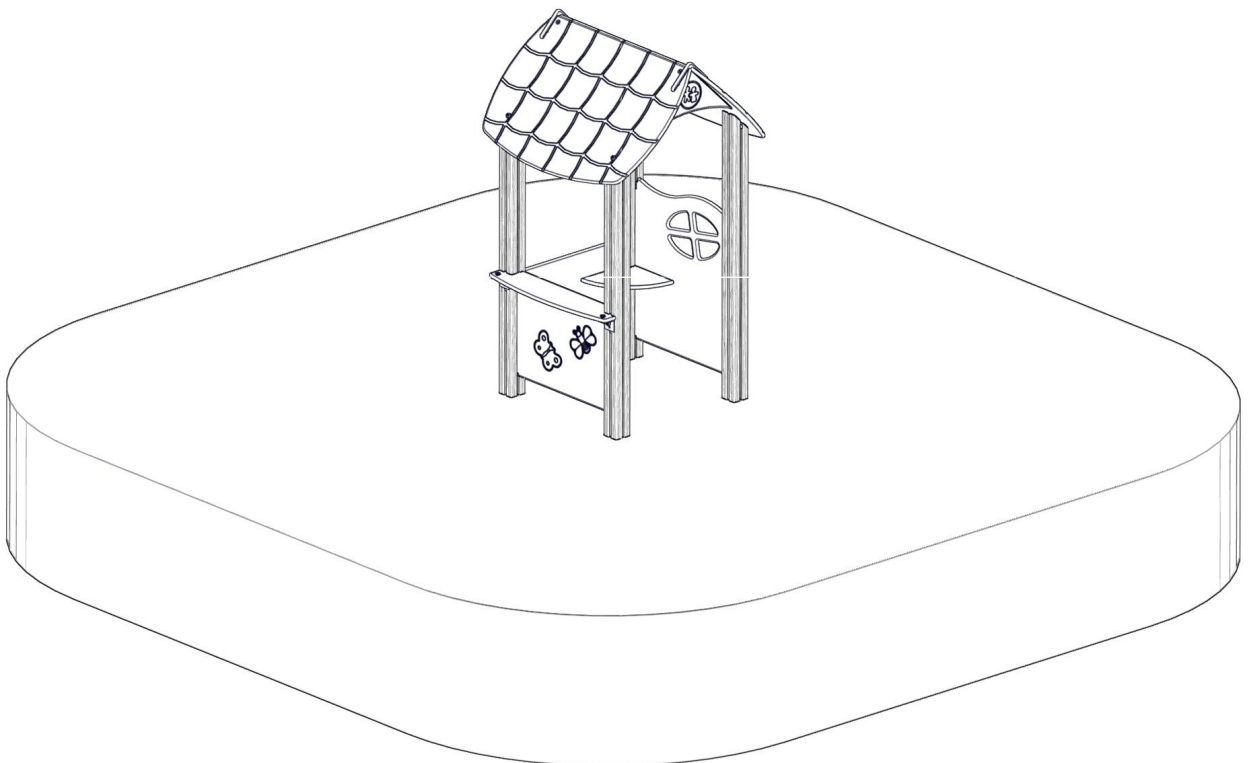
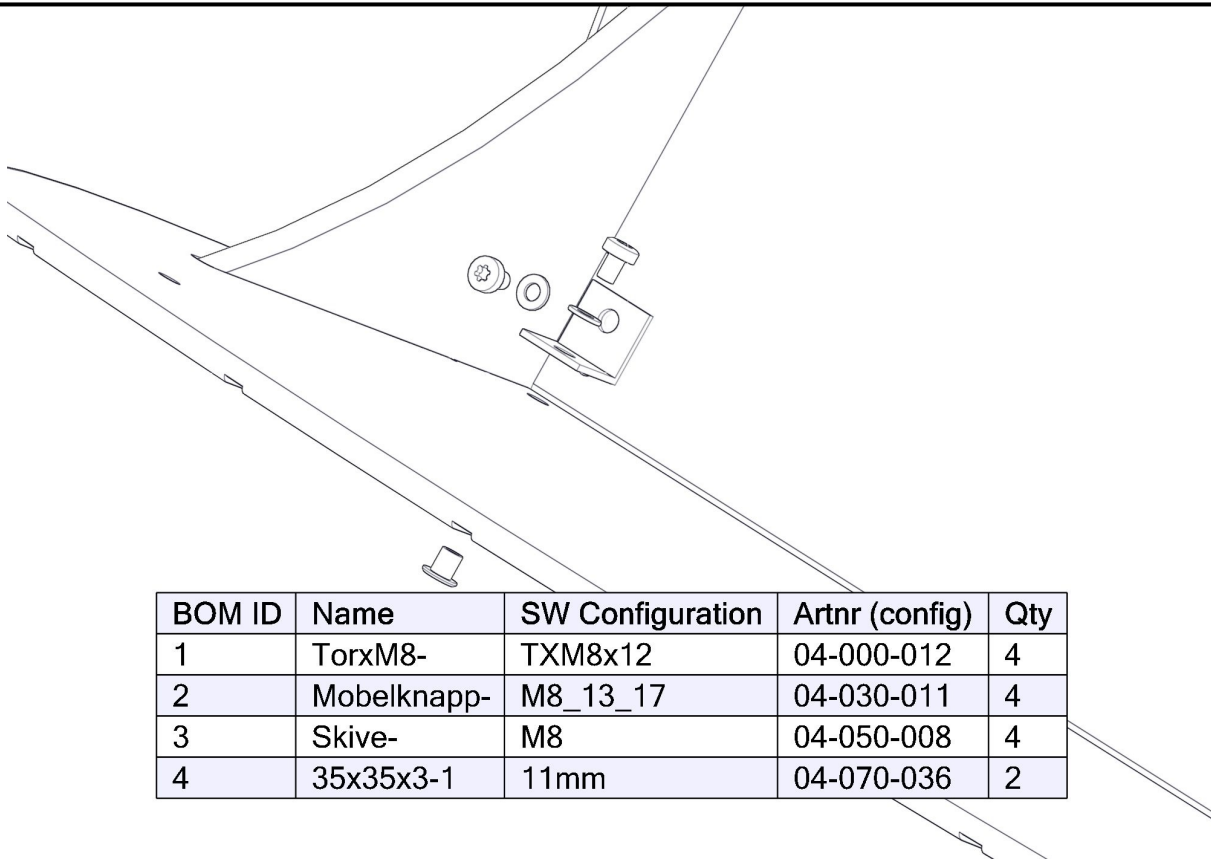

BOM ID	Name	SW Configuration	Artnr (config)	Qty
1	Tak_Miniserie2011-	rod	07-510-105	2
2	Gavelplatemini2011-	Rod	07-510-106	2



Før utstyret tas i bruk / Before play begins // Innan lekredskapet tas i bruk	
N	<ul style="list-style-type: none"> • Påse at fallunderlag er utlagt i henhold til gjeldende regler eller vår anbefaling • Fjern alle monteringshjelpemidler (rester av betong, planker, paller, plast, og lignende) • Før utstyret tas i bruk, burde man sjekke at det ikke er fare for at anorakksnorer og lignende som kan hekte seg fast noen steder på lekeapparatet. (Vedlagte snor med dobbe (kneledd) kan brukes til å sjekke at dette er i orden. Se vedlagte veiledning for bruk av denne. Dette gjøres for å oppdage eventuelle feilmonteringer.?) • NB! Bør stå i 2-3 dager før bruk
UK	<ul style="list-style-type: none"> • Make sure the area and depth of safer surfacing are according to the current standard, or to the manufacturer's recommendation • Make sure all tools and surplus materials are removed before play begins • PS! When complete, allow 2-3 days for the concrete to set before use
S	<ul style="list-style-type: none"> • Kontrollera att fallunderlag är utlagt enligt gällande regler eller vårt rekomenation • Ta bort alla monteringshjälpmedel (rester av betong, plankor, pallar, plast och liknande) • Innan lekredskapet används, kontrollera att anoracksnoddar eller kläder/delar av kläder eller liknande inte kan fastna i några delar på redskapet. (Den bipackade "knävringen" kan man med fördel användas för denna kontroll. • Detta görs för att upptäcka eventuella felmonteringar.)

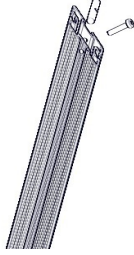
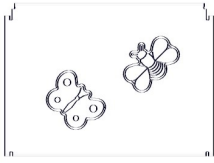
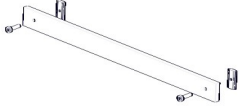
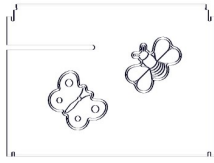
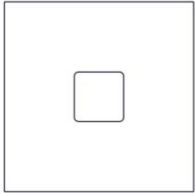
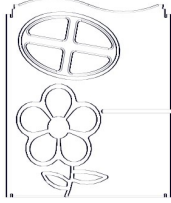

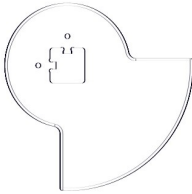





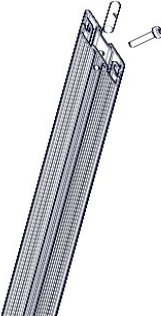

Boltepakker for / Boltpackage for / Bultpaket för

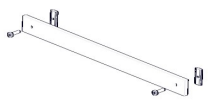
Sign. _____

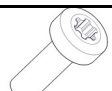
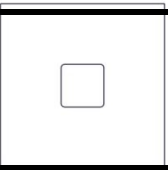
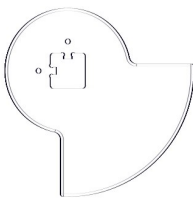
 <p>VK70 skrå 1150-400 07-510-155</p> <p style="text-align: right;">4</p>	 <p>Vegge520x400 Sommerfugl/Bi 07-510-110</p> <p style="text-align: right;">1</p>
 <p>MiniSprosse 660 07-510-200</p> <p style="text-align: right;">4</p>	 <p>Vegge520x400 Med SPOR Sommerfugl/Bi 07-510-112</p> <p style="text-align: right;">1</p>
 <p>FunMiniSkive 07-510-201</p> <p style="text-align: right;">4</p>	 <p>Vegge520x600 Vindo Blom Med Spor 07-510-121</p> <p style="text-align: right;">1</p>
 <p>Butikkdisk 07-510-130</p> <p style="text-align: right;">1</p>	 <p>Sete rund stolpe 07-510-132</p> <p style="text-align: right;">1</p>
 <p>Tak 07-510-105</p> <p style="text-align: right;">1</p>	















Boltepakker for / Boltpackage for / Bultpaket för

Sign. _____

Stolpe 70x70 skrå	Ant= 4	Navn	Artnr/dimensjon	Ant	Lev
		VK70 skrå 1150-400 (1)	07-510-155	4	
		Torx M8x40 (1)	04-000-040	4	
		Hullsemutter (1) VK70	04-018-070	4	
FundamentMini 660	Ant= 4	Navn	Artnr/dimensjon	Ant	Lev
		miniSprosse 660 (1)	07-510-200	4	
		Brikke 50_1T (2)	04-060-050	8	
		Torx M8x35 (2)	04-000-035	8	
FundamentSkive	Ant= 4	Navn	Artnr/dimensjon	Ant	Lev
		Skive (1)	07-510-201	4	
Sete rund stolpe	Ant= 1	Navn	Artnr/dimensjon	Ant	Lev
		Sete rund stolpe	07-510-132	1	
		Vinkel 35x35x3(2) 11mm	04-070-036	2	
		Møbelknapp(2)	04-030-011	2	
		Brikke 501T(2)	04-060-050	2	
		Torx M8x12 (2) Torx M8x20 (2)	04-000-012 04-000-020	2 2	
		Skive M8 (2)	04-050-008	2	

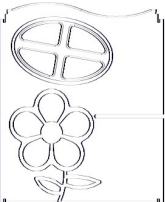
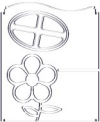











Boltepakker for / Boltpackage for / Bultpaket för

Sign. _____

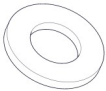
Vegge 520x400 spor Sommerfugl/bie	Ant= 1	Navn	Artnr/dimensjon	Ant	Lev
		Vegge520x400(1) Sommerfugl /bie Med spor	07-510-112	1	
		Brikkespesial(4)	04-060-041	4	
		Brikke(4)	04-060-050	4	
		Torx M8x25(4)	04-000-025	4	
Vegge 520x400 Sommerfugl / bie	Ant= 1	Navn	Artnr/dimensjon	Ant	Lev
		Vegge520x400 (1) Sommerfugl/bi	07-510-110	1	
		Brikkespesial(4)	04-060-051	4	
		Brikke(4)	04-060-050	4	
		Torx M8x25(4)	04-000-025	4	
Vegge 520x600 Spor Vindo bloms	Ant= 1	Navn	Artnr/dimensjon	Ant	Lev
		Vegge520x600 (1) Vindu blom med spor	07-510-121	1	
		Brikkespesial(4)	04-060-051	4	
		Brikke(4)	04-060-050	4	
		Torx M8x25(4)	04-000-025	4	

Boltepakker for / Boltpackage for / Bultpaket för

Sign. _____

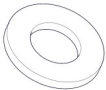
Tak	Ant= 1	Navn	Artnr/dimensjon	Ant	Lev
		Tak mini (2)	07-510-105	2	
		Gavelplate(2)	07-510-106	2	
		Vinkel 35x35x3(2) 11mm	04-070-036	2	
		Møbelknapp	04-030-011	4	
		Torx M8x12(4)	04-000-012	4	
		Skive M8 (4)	04-050-008	4	
Buttikkdisk	Ant= 1	Navn	Artnr/dimensjon	Ant	Lev
		Buttikkdiskk	07-510-130	1	
		Vinkel 50x50x4(2) 11mm	04-070-050	2	
		Møbelknapp(2)	04-030-011	2	
		Brikke 501T(2)	04-060-050	2	
		Torx M8x12 (2) Torx M8x20 (2)	04-000-012 04-000-020	2 2	
		Skive M8 (2)	04-050-008	2	

Boltepakker for / Boltpackage for / Bultpaket för

Sign. _____.

Produktmerke	Ant= 1	Navn	Artnr/dimensjon	Ant	Lev
		Produktmerking Hos Søve	25-200-090	1	