

N

**Monteringsanvisning**

EN

**Assembly Instructions**

S

**Monteringsanvisning**

Produkt nr. / Product no. / Produkt nr.

**25-200-081**

Ordr. nr. \_\_\_\_\_

Dato. \_\_\_\_\_

Sign. \_\_\_\_\_

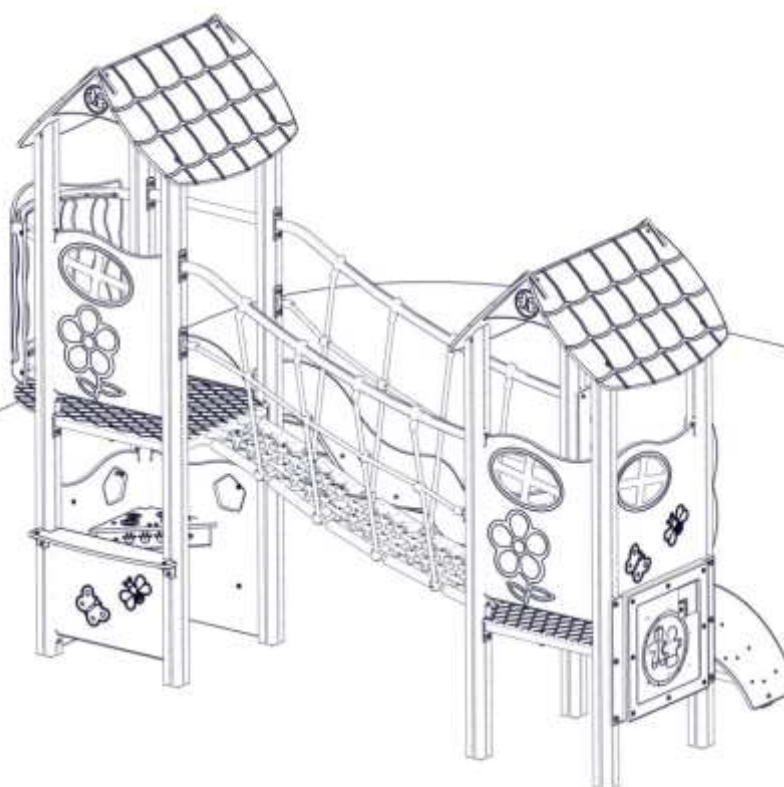

Søve AS  
Grønnvoldveien 290  
3830 Ulefoss - Norway  
Tlf: +47 35 94 65 65  
[www.sove.no](http://www.sove.no)



Søve AB  
EA Rosengrensgatan 32  
421 31 Västra Frölunda  
Phone: +46 (0)31 773 97 00  
[www.sove.se](http://www.sove.se)

## Monteringstips / Assembly Advice / Monteringsstips

N

- Les monteringsanvisningen nøye før montering.
- Monter elementene i rekkefølgen som vist.
- Boltene bør ikke skrues for hardt til før alt er montert, vatret og loddet. Skru så boltene til.
- NB! Ved bruk av drill, kan boltene ryke.
- På grunn av at solen kan gjøre rutsjeplaten veldig varm, bør rutsjebanens utløp vende mot nord-øst eller nord-vest.
- Er lekeutstyret plassert i naturlige ferdselstraséer må området sikres mot gjennomgang.
- Innspringningshinder bør vurderes rundt lekeapparater hvor det er stor bevegelse, f.eks. ved huskestativ.
- Det bør være fritt innsyn til lekeutstyr som er beregnet for barn under 3 år.

**NB! Under monteringsarbeidet må utstyr, som ikke er forankret forsvarlig i bakken, sikres slik at det ikke velte.**

**Området må avstenges under montering av apparatene med sperrebånd eller lignende.**

EN

- Read the instruction carefully before assembling the play unit.
- Assemble the components in the sequence shown in these instructions. Fixings must not be fully tightened during assembly. Before casting the foundations, the structure must be level and plumb, at which point all fixings are tightened. PSI If use of drill, the bolts may be wrecked.
- Avoid positioning the slide facing due south because of overheating – ideal positions are facing north-east or north-west. Secure the construction-area to prevent people from walking through it.
- Consider installing barriers around play-equipment which gives rise to a lot of activity – i.e. swings.
- Ensure that clear vision is possible across the play area so that supervision is possible from any position, particularly where children under 3 years of age will be playing.

**NB! During assembly of the equipment, ensure that all structures are securely propped, especially when left overnight. Also ensure that equipment is supported**

## Monteringstips / Assembly Advice / Monteringsstips

**S**

- Läs monteringsanvisningen noga före montering.

- Montera delarna i den ordningen som anvisas
- Skruvarna bör inte skruvas för hårt tills allt är monterat, i våg och lodat.











OBS! Används elektrisk skruvdragare, kan bulten gå sönder. Härddra därför manuellt!

- Solen kan göra att rutchbanan blir väldigt varm. Banans nedfart rekommenderas att vändas i norrlig riktning
- Om lekplatsen placeras vid en gångväg mm bör området säkras mot genomfart av gående och cyklister.
- Insprängningshinder bör placeras runt lekutrustning med stor rörelse, t ex, gungställning.
- Det bör vara fri insyn till lekutrustning beräknat till barn under 3 år.

**OBS! Under monteringsarbete bör utrustningen som inte ska förankras i marken, ställs så att den inte kan välta.**

**Området måste spärras när lekutrustningen byggs upp, med avspärrningsband eller liknande.**

**Nødvendig verktøy / Tools required / Nödvändiga verktyg**

<p>(N)</p> <p>(EN)</p> <p>(S)</p>	<p>(A)</p> 	<p>(B)</p>  <p>Torx Nr 45 High quality</p>	<p>(C)</p> <p>5 mm 6 mm</p> 	<p>(D)</p> 	<p>(E)</p> 
		<p>Metermål Metric measure Tumstock</p> 	<p>16 V</p> 	<p>Merkebånd Mark ribbon Märkeband</p> 	<p>13 + 17mm</p> 

**Nødvendig antall personer / Number of persons required / Lämpligt antal personer**





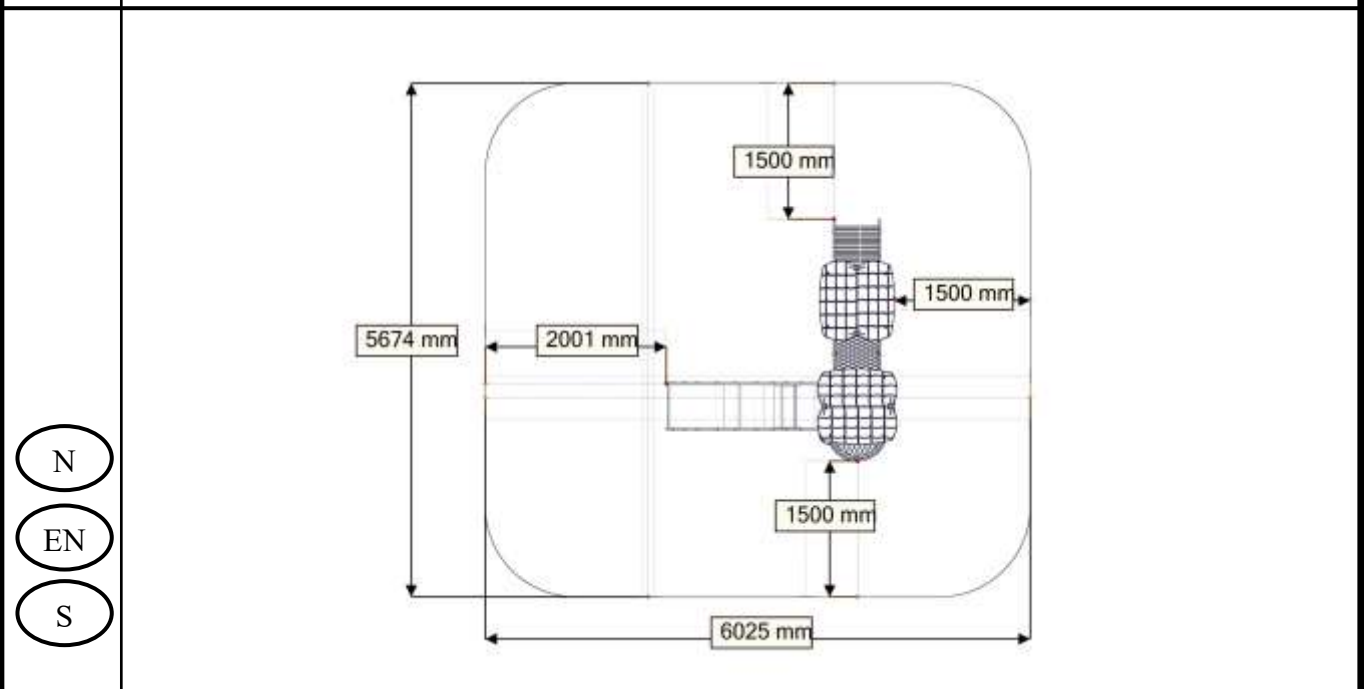







**Anbefalt arealbehov ved montering / Recommended working space / Rekommenderad arealbehov vid montering**





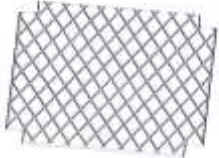
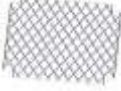











**Boltepakker for / Boltpackage for / Bultpaket för**

Sign. \_\_\_\_\_

<b>Stolpe 70x70 skrå</b>	<b>Ant= 4</b>	<b>Navn</b>	<b>Artnr/dimensjon</b>	<b>Ant</b>	<b>Lev</b>
		VK70 2200-600 (1) Skrå VK70 1700-600 Brikke på stolpe!	07-510-158	4	
		Torx M8x40 (1)	04-000-040	8	
		Hullsemutter (1) VK70	04-018-070	8	
<b>FundamentMini</b>	<b>Ant= 8</b>	<b>Navn</b>	<b>Artnr/dimensjon</b>	<b>Ant</b>	<b>Lev</b>
		MiniSprosse 660 (1)	07-510-200	8	
		Brikke 50_1T (2)	04-060-040	16	
		Torx M8x35 (2)	04-000-035	16	
<b>FundamentSkive</b>	<b>Ant= 8</b>	<b>Navn</b>	<b>Artnr/dimensjon</b>	<b>Ant</b>	<b>Lev</b>
		Skive (1)	07-510-201	8	
<b>Gulv mini LANG på 1 side</b>	<b>Ant= 1</b>	<b>Navn</b>	<b>Artnr/dimensjon</b>	<b>Ant</b>	<b>Lev</b>
		Gulv Mini 520(1)	07-510-104 LANG PÅ 1 SIDE	1	
		Møbelknapp (4)	04-030-011	4	
		Torx M8x45 (4)	04-000-045	4	







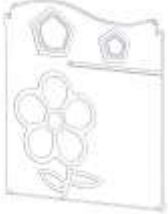

**Boltepakker for / Boltpackage for / Bultpaket för**

Sign. \_\_\_\_\_

<b>Vegge 520x600 Vindo bloms</b>	<b>Ant= 2</b>	<b>Navn</b>	<b>Artnr/dimensjon</b>	<b>Ant</b>	<b>Lev</b>
		Vegge520x600 (1) Vindu blom	07-510-120	2	
		Brikkespesial(4)	04-060-041	8	
		Brikke(4)	04-060-040	8	
		Torx M8x25(4)	04-000-025	8	
<b>Vegge 520x600 Vindo Bi</b>	<b>Ant= 1</b>	<b>Navn</b>	<b>Artnr/dimensjon</b>	<b>Ant</b>	<b>Lev</b>
		Vegge520x600 (1) Vindu bi/ Sommerfulg	07-510-120	1	
		Brikkespesial(4)	04-060-041	4	
		Brikke(4)	04-060-040	4	
		Torx M8x25(4)	04-000-025	4	
<b>Vegge 520x400 Sommerfugl / bie</b>	<b>Ant= 1</b>	<b>Navn</b>	<b>Artnr/dimensjon</b>	<b>Ant</b>	<b>Lev</b>
		Vegge520x400 (1) Sommerfugl/bi	07-510-110	1	
		Brikkespesial(4)	04-060-041	4	
		Brikke(4)	04-060-040	4	
		Torx M8x25(4)	04-000-025	4	

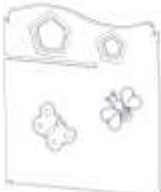
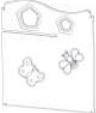











**Boltepakker for / Boltpackage for / Bultpaket för**

Sign. \_\_\_\_\_

<b>Vegge 520x520 Vindo bloms med spor</b>	<b>Ant= 1</b>	<b>Navn</b>	<b>Artnr/dimensjon</b>	<b>Ant</b>	<b>Lev</b>
Til Kokeplatte 		Vegge520x520 (1) Vindu blom	07-510-123	1	
		Brikkespesial(4)	04-060-041	4	
		Brikke(4)	04-060-040	4	
		Torx M8x25(4)	04-000-025	4	
<b>Vegge 520x520 Vindo Bi med spor</b>	<b>Ant= 1</b>	<b>Navn</b>	<b>Artnr/dimensjon</b>	<b>Ant</b>	<b>Lev</b>
Til Kokeplatte 		Vegge520x520 (1) Vindu bi/ Sommerfulg	07-510-124	1	
		Brikkespesial(4)	04-060-041	4	
		Brikke(4)	04-060-040	4	
		Torx M8x25(4)	04-000-025	4	

**Boltepakker for / Boltpackage for / Bultpaket för**

Sign. \_\_\_\_\_.

Kokeplate rund stolpe	Ant= 1	Navn	Artnr/dimensjon	Ant	Lev
		Kokeplate rund stolpe	07-510-136	1	
		Kokeplate front	07-510-137	1	
		Vinkel 50x50x5(4) 11mm	04-070-050	4	
		Møbelknapp(6)	04-030-011	6	
		Brikke 501T(2)	04-060-050	2	
		Torx M8x12 (6) Torx M8x20 (2)	04-000-012 04-000-020	6 2	
		Skive M8 (6)	04-050-008	6	
Sperrerør 520 gulv 4 hull 100	Ant= 2	Navn	Artnr/dimensjon	Ant	Lev
		Sperrerør 520 (1) For brua	07-510-162	2	
		Brikke 90_2T (2)	04-060-090	0 På stolpe	
		Torx M8x25 (2)	04-000-025	4	













**Boltepakker for / Boltpackage for / Bultpaket för**

Sign. \_\_\_\_\_.

<b>Sperrerør 520</b>	<b>Ant= 1</b>	<b>Navn</b>	<b>Artnr/dimensjon</b>	<b>Ant</b>	<b>Lev</b>
		Sperrerør 520 (1)	07-510-160	1	
		Brikke 120_3T (2)	04-060-120	2	
		Torx M8x25 (4)	04-000-025	4	
<b>Sperrerør 520 gulv</b>	<b>Ant= 6</b>	<b>Navn</b>	<b>Artnr/dimensjon</b>	<b>Ant</b>	<b>Lev</b>
		Sperrerør 520 (1)	07-510-161	6	
		Brikke 90_2T (2)	04-060-090	0 På stolpe	
		Torx M8x25 (2)	04-000-025	12	
<b>Utsikt</b>	<b>Ant= 1</b>	<b>Navn</b>	<b>Artnr/dimensjon</b>	<b>Ant</b>	<b>Lev</b>
		Utsikt med sperrerør (1)	07-510-134	1	
		Gulv til utsikt (4)	05-510-101	1	
		Torx M8x45 (4) Torx M8x25 (8)	04-000-045 04-000-025	4 8	
		Møbelknapp M8x13x17	04-030-011	4	
		Brikke 120_3T	04-060-120	4	













**Boltepakker for / Boltpackage for / Bultpaket för**

Sign. \_\_\_\_\_.

<b>Nettbro skrå tett 07-510-179K</b>	<b>Ant= 1</b>	<b>Navn</b>	<b>Artnr/dimensjon</b>	<b>Ant</b>	<b>Lev</b>
		Nett (1) INKL. beslag	07-510-179	1	
		Rør bue(2)	07-510-166	2	
		Brikke120 3T(8)	04-060-120	8	
		Torx M8x25(16)	04-000-025	16	
		Saddelwasher 38mm (32)	04-210-010	32	
		Møbelknapp (12)	04-030-025	16	
<b>Håndtak dobbel</b>	<b>Ant= 2</b>	<b>Navn</b>	<b>Artnr/dimensjon</b>	<b>Ant</b>	<b>Lev</b>
		Håndtak dobbel (1)	00-400-172	2	
		Brikke 50_1T (3)	04-060-050	6	
		Torx M8x30 (3)	04-000-030	6	







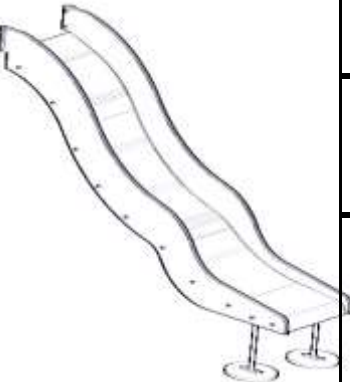

**Boltepakker for / Boltpackage for / Bultpaket för**

Sign. \_\_\_\_\_.

<b>Trappe 550 01-290-090</b>	<b>Ant= 1</b>	<b>Navn</b>	<b>Artnr/dimensjon</b>	<b>Ant</b>	<b>Lev</b>
		Rutsjebane	01-290-090	1	
		Brikke90 3T(5)	04-060-090	2	
		Torx M8x35(4)	04-000-035	10	
		Fundamentskive(2) 2H 80	00-003-106	2	
		Skive M8(2)	04-050-008	6	
		Mutter M8(2)	04-040-008	6	
		Stålforankring(2)	00-100-312	2	
<b>Søve Slide</b>	<b>Ant= 1</b>	<b>Navn</b>	<b>Artnr/dimensjon</b>	<b>Ant</b>	<b>Lev</b>
		Søve Slide	25-100-020	1	
		Brikke 50_1T (6)	04-060-050	6	
		Torx M8x30 (6)	04-000-030	6	
		Skive M8	04-050-008	6	











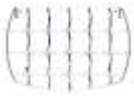

**Boltepakker for / Boltpackage for / Bultpaket för**

Sign. \_\_\_\_\_.

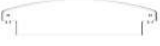
<b>Rutsjebane 950 07-510-310</b>	<b>Ant= 1</b>	<b>Navn</b>	<b>Artnr/dimensjon</b>	<b>Ant</b>	<b>Lev</b>
		Rutsjebane	07-510-310	1	
		Brikke120 3T(5)	04-060-120	2	
		Torx M8x35(4)	04-000-035	4	
		Torx M8x45(2)	04-000-045	2	
		Torx M8x30(4)	04-000-030	4	
		Fundamentskive(2) 2H 80	00-003-106	2	
		Skive M8(2)	04-050-008	6	
		Mutter M8(2)	04-040-008	6	
	Stålforankering(2)	00-100-312	2		
<b>Produktmerke</b>	<b>Ant= 1</b>	<b>Navn</b>	<b>Artnr/dimensjon</b>	<b>Ant</b>	<b>Lev</b>
		Produktmerking Hos Søve	25-200-180	0	

**Boltepakker for / Boltpackage for / Bultpaket för**

Sign. \_\_\_\_\_

Tak	Ant= 2	Navn	Artnr/dimensjon	Ant	Lev
		Tak mini (2)	07-510-105	4	
		Gavelplate(2)	07-510-106	4	
		Vinkel 35x35x3(2) 11mm	04-070-036	4	
		Møbelknapp	04-030-011	8	
		Torx M8x12(4)	04-000-012	8	
		Skive M8 (4)	04-050-008	8	
Buttikdisk	Ant= 1	Navn	Artnr/dimensjon	Ant	Lev
		Buttikdiskk	07-510-130	1	
		Vinkel 50x50x4(2) 11mm	04-070-050	2	
		Møbelknapp(2)	04-030-011	2	
		Brikke 501T(2)	04-060-040	2	
		Torx M8x12 (2) Torx M8x20 (2)	04-000-012 04-000-020	2 2	
		Skive M8 (2)	04-050-008	2	

**Fundamentering med betong / Foundation concrete / Förankring med betong**

(N)	Støtsand		(N)	(UK)	(S)
(UK)	Safer surface		Bakkenivå	Ground level	Marknivå
(S)	Stridsan		↓ Ref NS-EN 177		
(N)	Komprimert masse.	betong			
(UK)	Compressed mass.	concrete			
(S)	Komprimerad massa.	betong			

**Fundamentering uten betong / Foundation without concrete / Förankring utan betong**

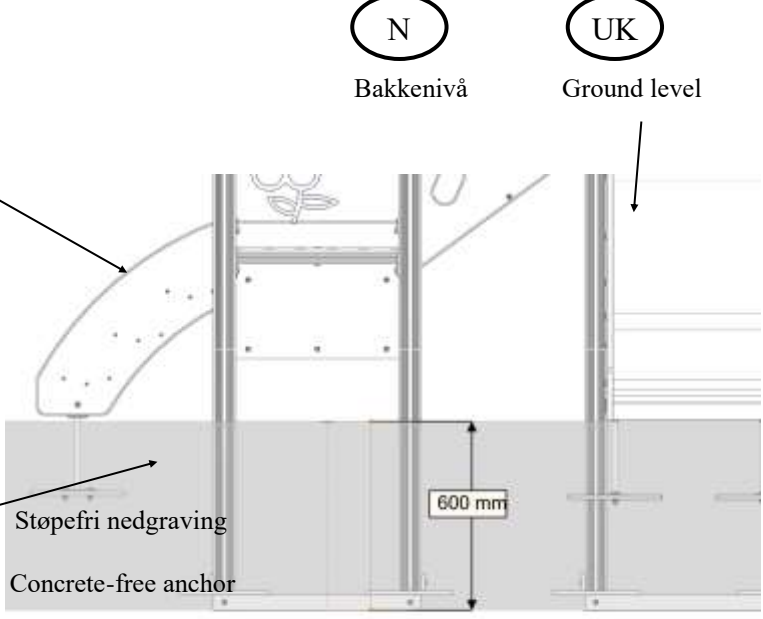
(N)	Støtsand		(N)	(UK)	(S)
(UK)	Safer surface		Bakkenivå	Ground level	Marknivå
(S)	Stridsan		↓ Ref NS-EN 1177		
(N)	Komprimert masse	Støpefri nedgraving			
(UK)	Compressed mass	Concrete-free anchor			
(S)	Komprimerad massa	Nedgrävningfundament			

(N)	Alle mål er oppgitt i millimeter
(UK)	Scale measured in mm
(S)	Alla mått är i millimeter.

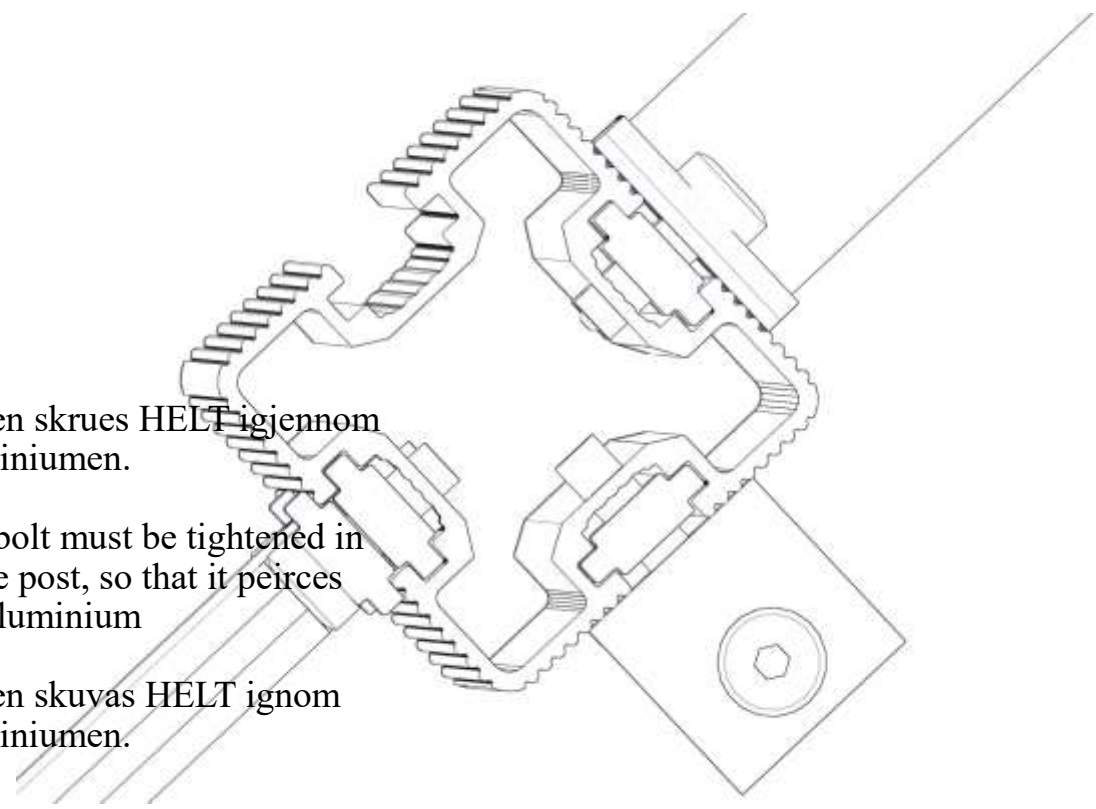
<p data-bbox="119 1556 215 1624">N</p> <p data-bbox="119 1691 215 1758">UK</p> <p data-bbox="119 1848 215 1915">S</p>	 <p data-bbox="231 1579 702 1668">Bolten skrues HELT igjennom aluminiumen.</p> <p data-bbox="231 1691 686 1825">The bolt must be tightened in to the post, so that it peirces the aluminium</p> <p data-bbox="231 1848 662 1937">Bulten skruvas HELT ignom aluminiumen.</p>

**Fallhøyder / Free height of fall / Fallhöjder**

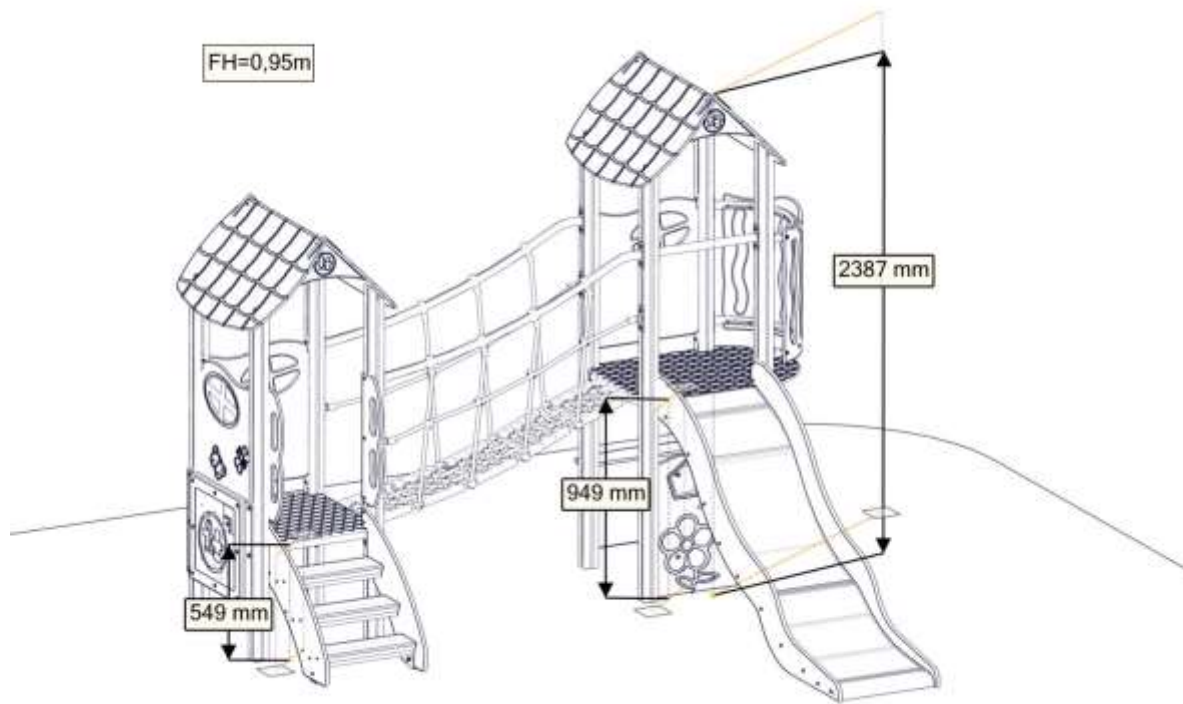

**Sikkerhetszone / Safety zone / Säkerhetszon**

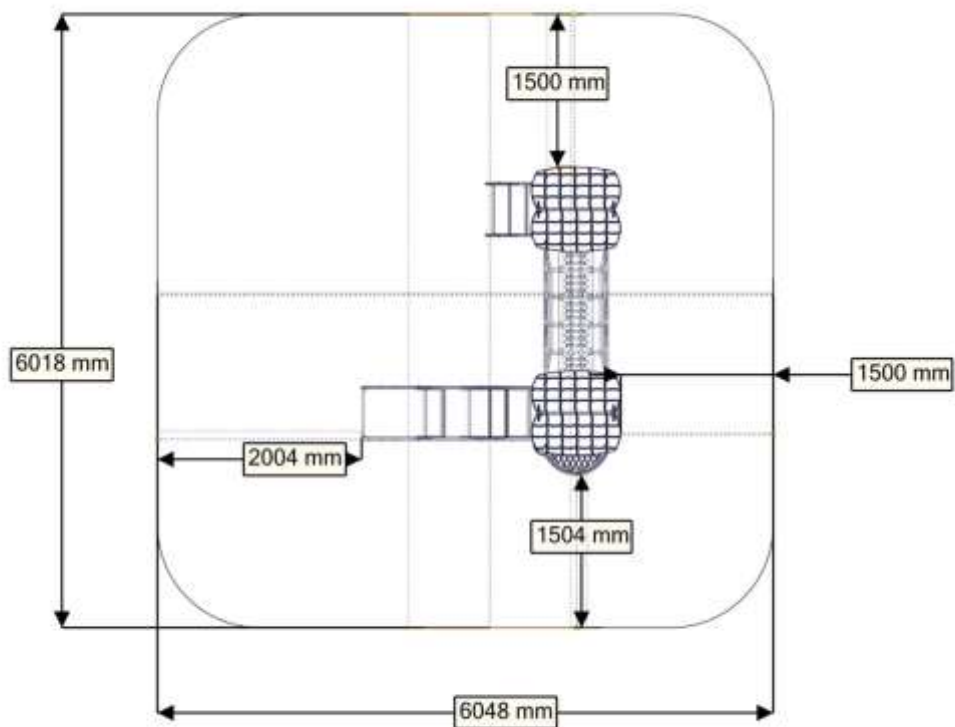



**Plassering av forankringer / Ground plan / Placering av förankringar**

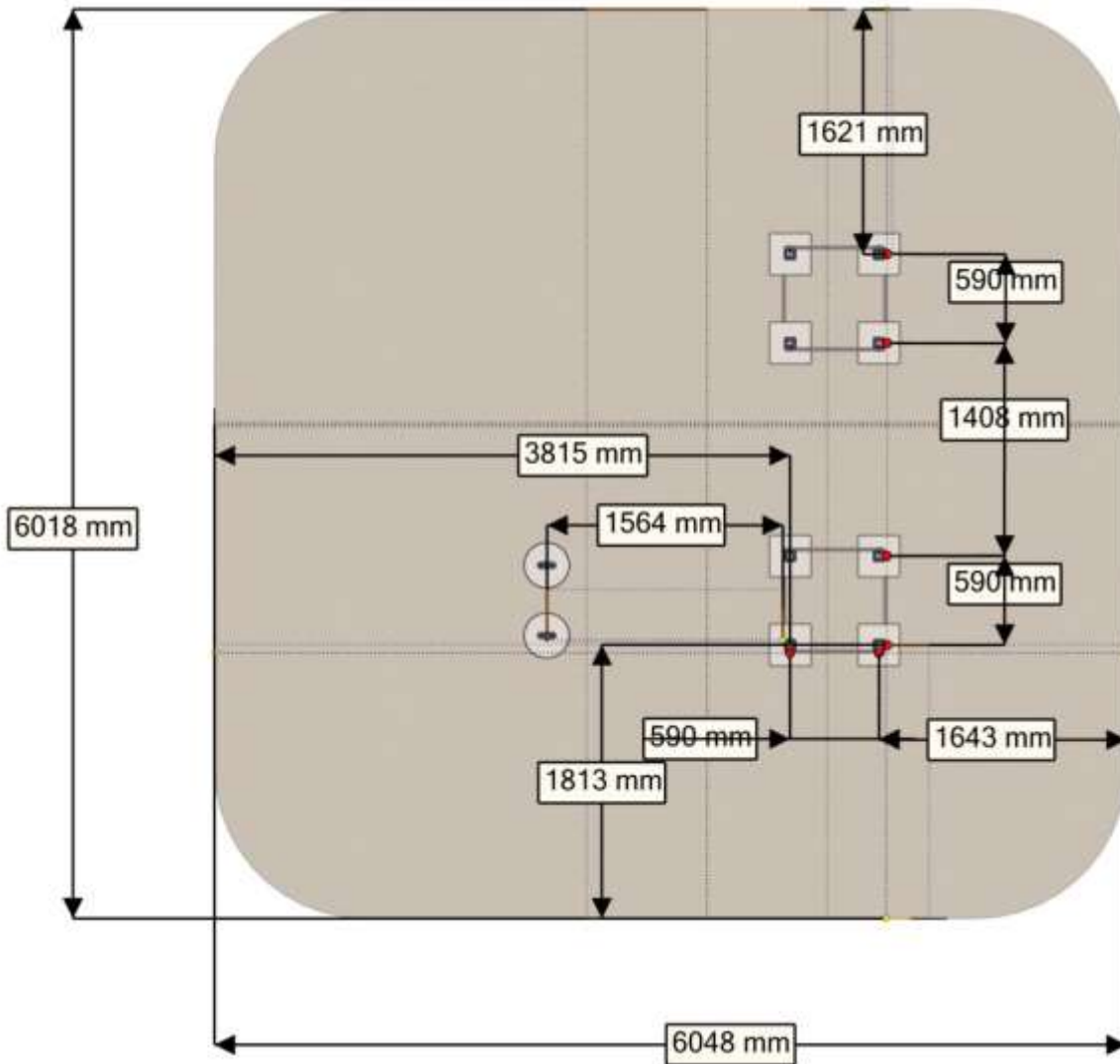

N

Alle mål er oppgitt i millimeter

UK

Scale measured in mm

S

Alla mått är i millimeter.

## Montering av lekeapparatet / Assembly instructions / Montering av lekredskapet

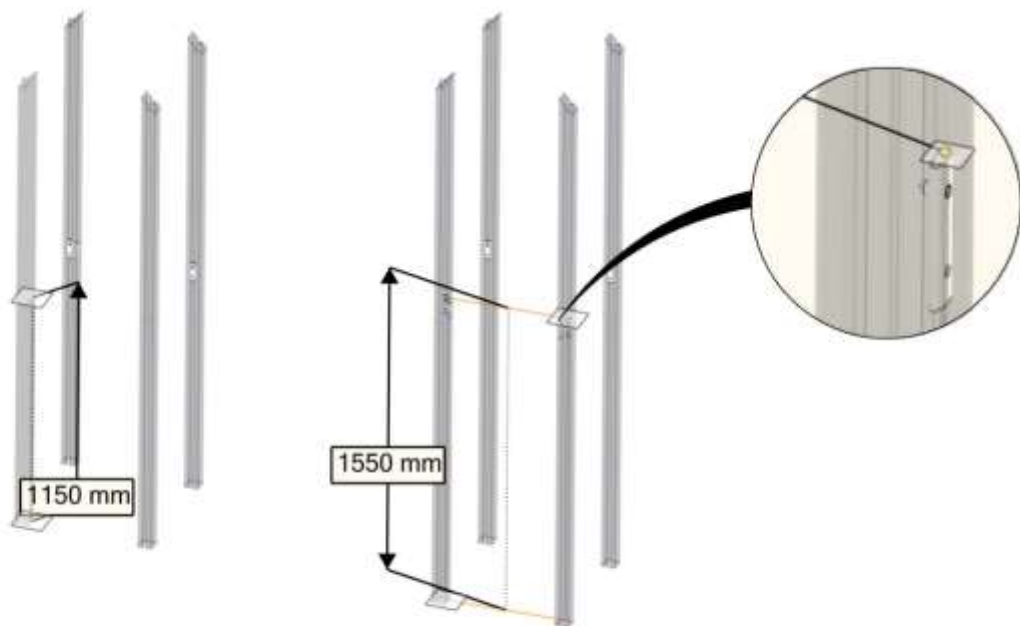

nr	PartName	Artnr	Antall
1	70x70 2300 skrå	07-510-156	4
2	70x70 2700 skrå	07-510-158	4

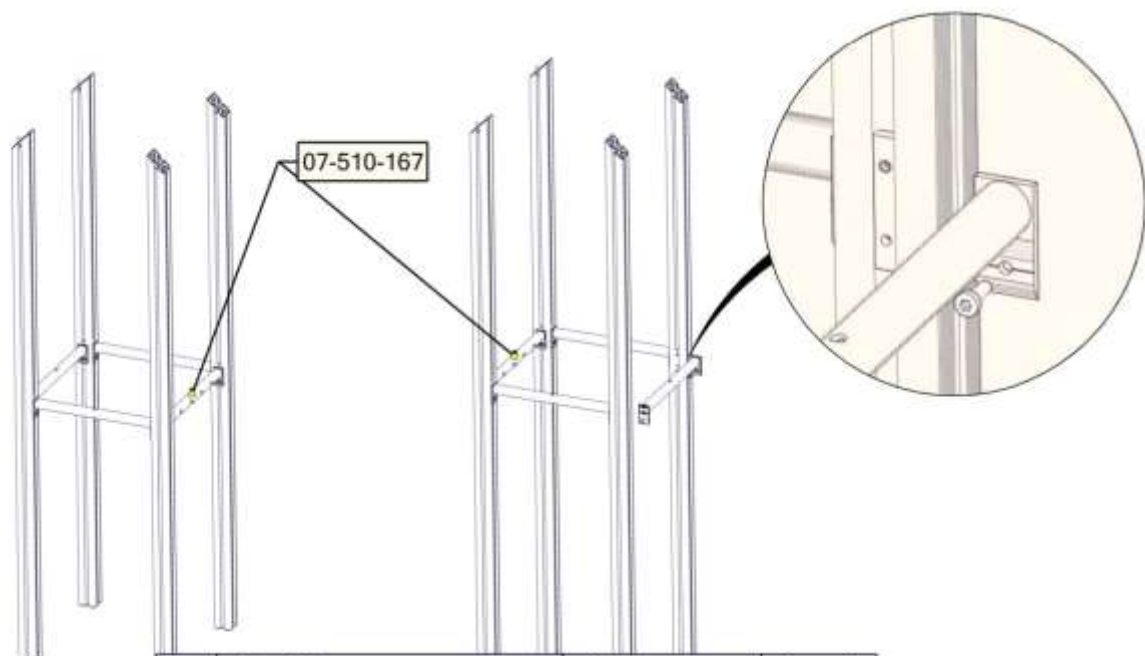

nr	PartName	Artnr	Antall
1	Torx M8x	04-000-0	16
2	Sperrerør gulv	07-510-161	6
3	Sperrerør gulv og nett	07-510-167	2

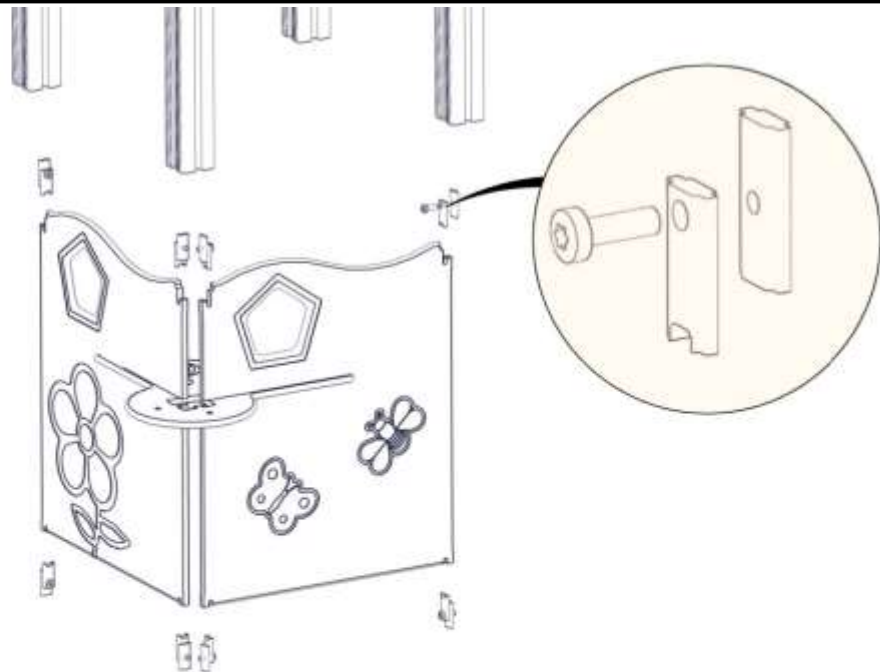
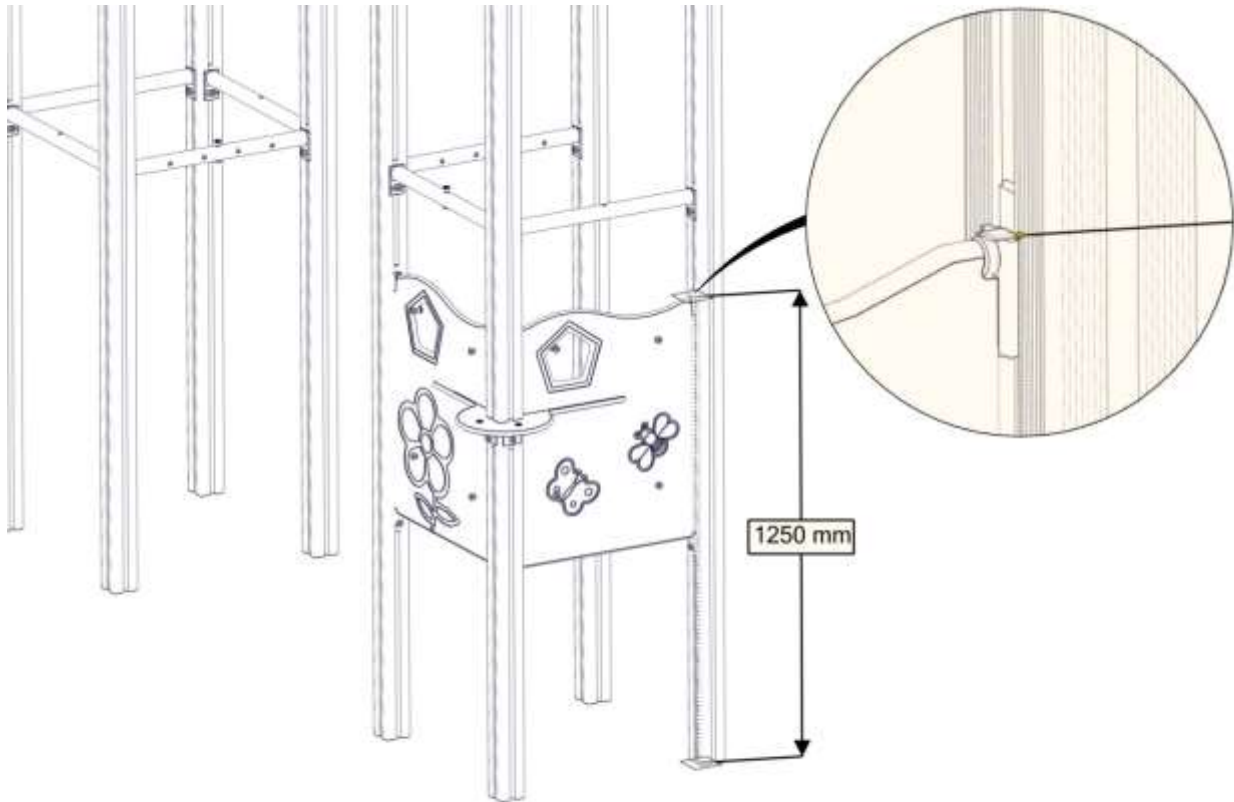

nr	PartName	Artnr	Antall
1	Torx M8x25	04-000-025	8
2	Brikke 50 1XM8	04-060-050	8
3	Brikke Spesial 12mm	04-060-051	8
4		07-510-123	1

nr	PartName	Artnr	Antall
5		07-510-124	1
6	Kokeplate rund stolpe	07-510-138	1

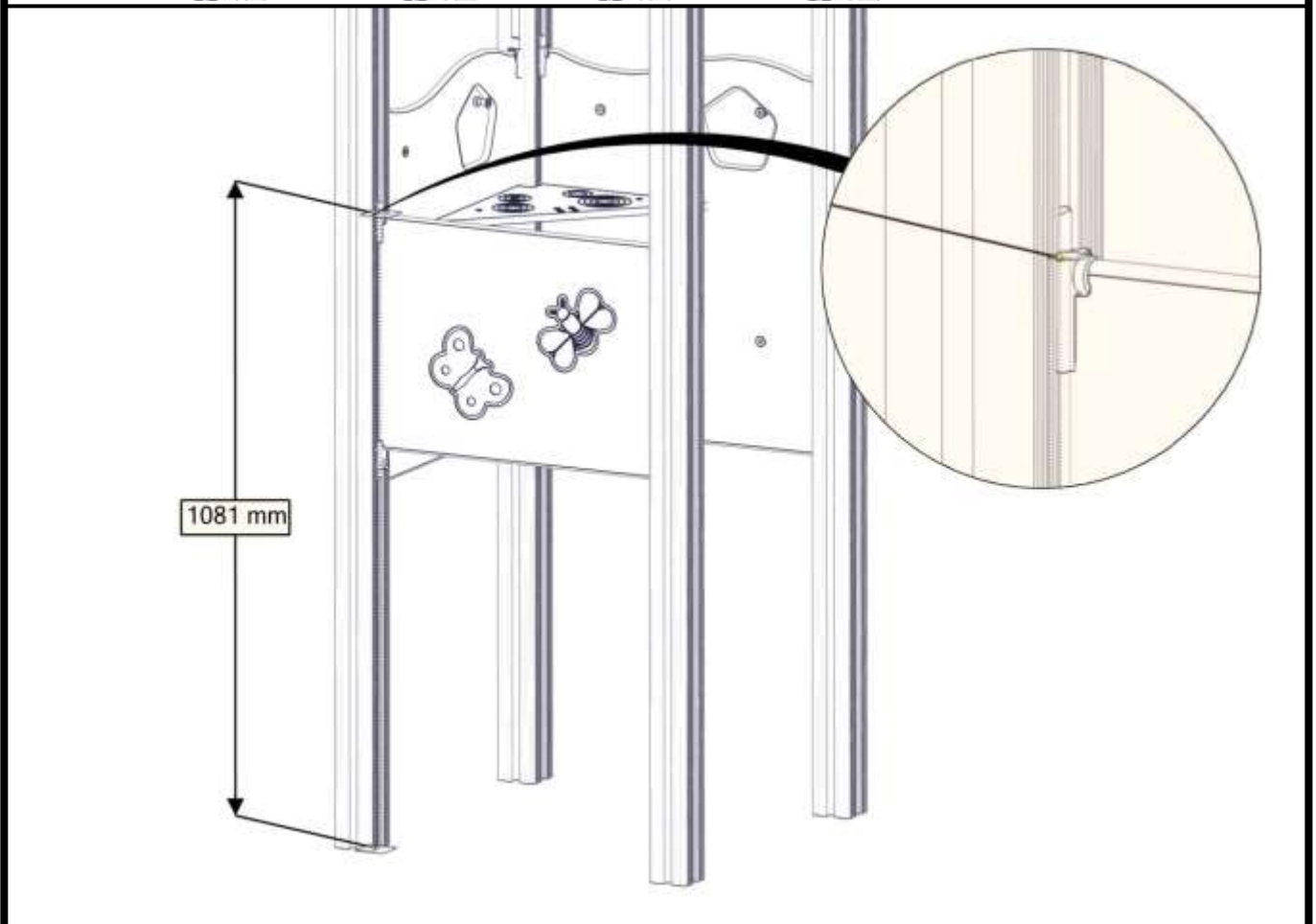
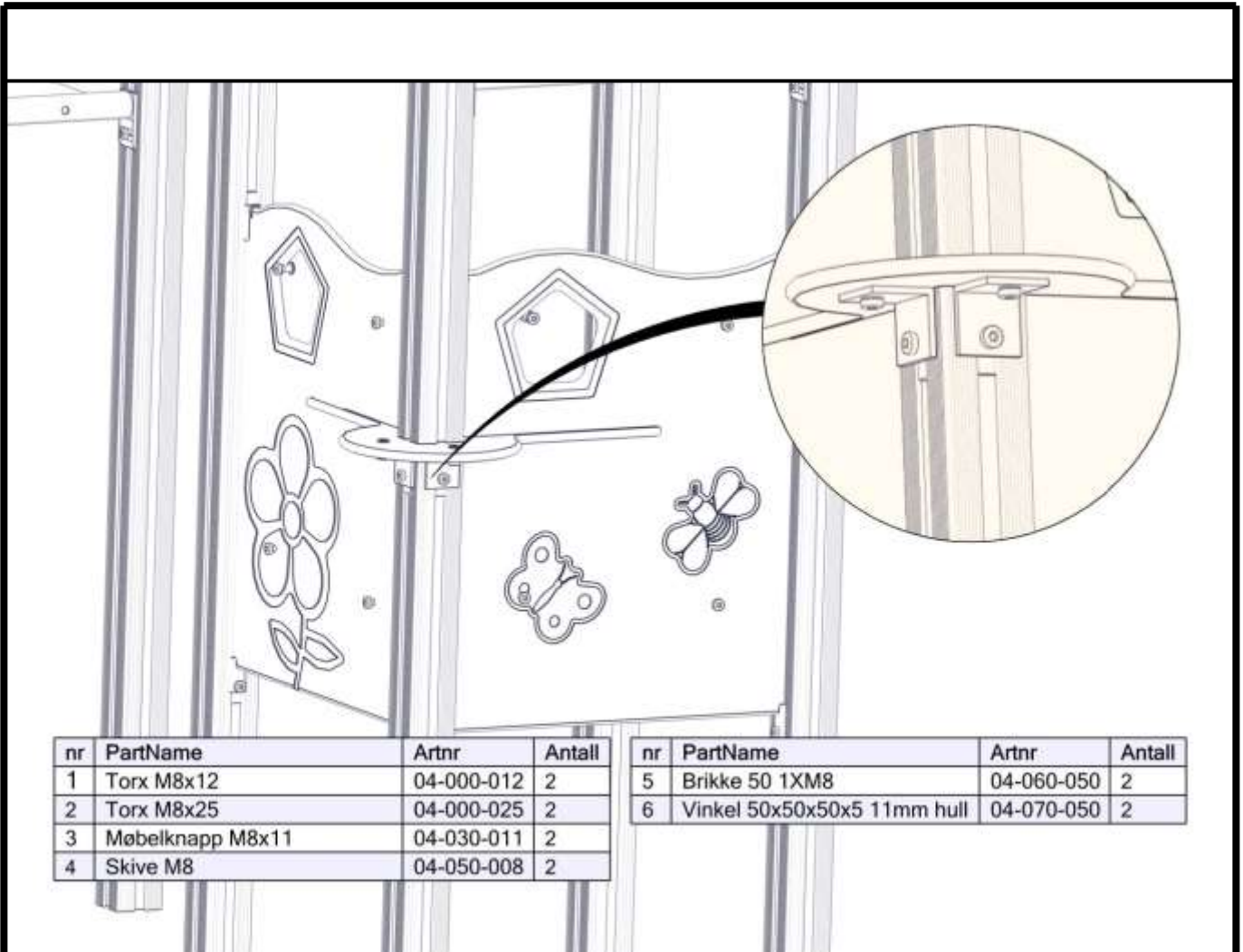

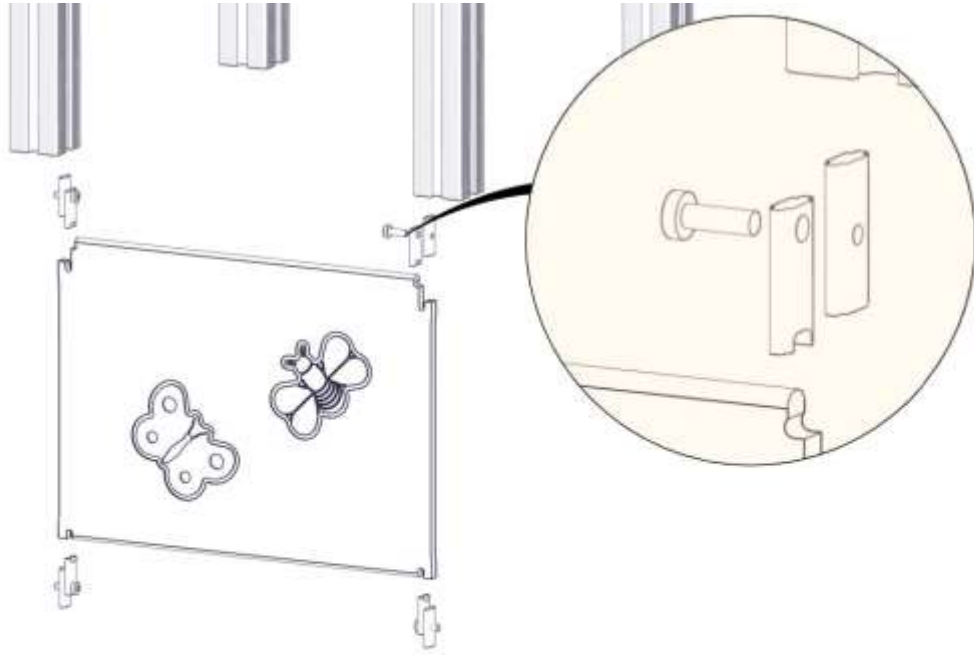

nr	PartName	Artnr	Antall
3	Brikke 50 1XM8	04-060-050	4
4	Brikke Spesial 12mm	04-060-051	4
1	Torx M8x25	04-000-025	4
2	Vegg 520x400	07-510-110	1

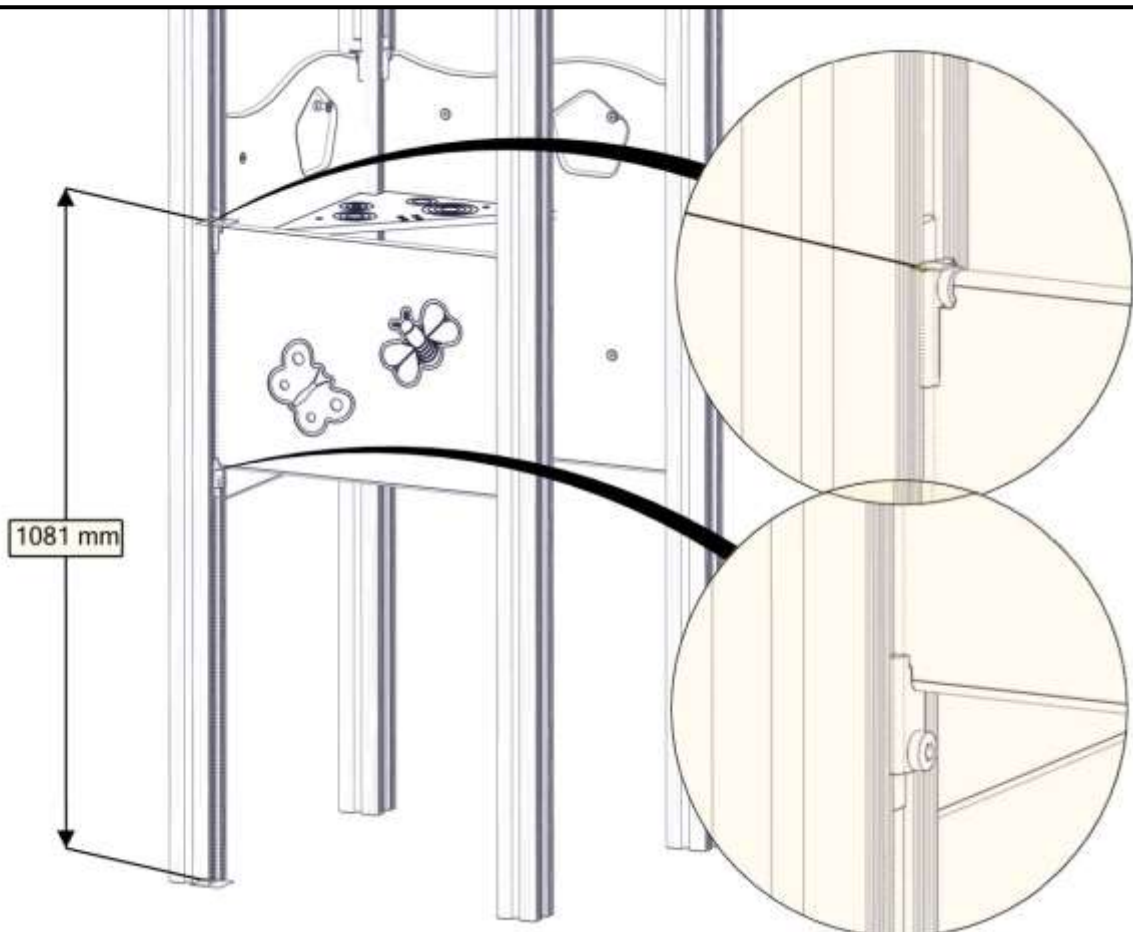

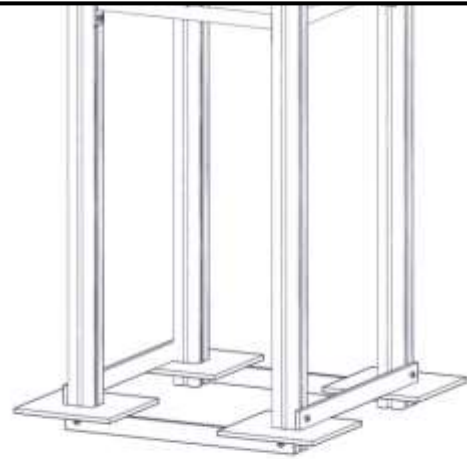
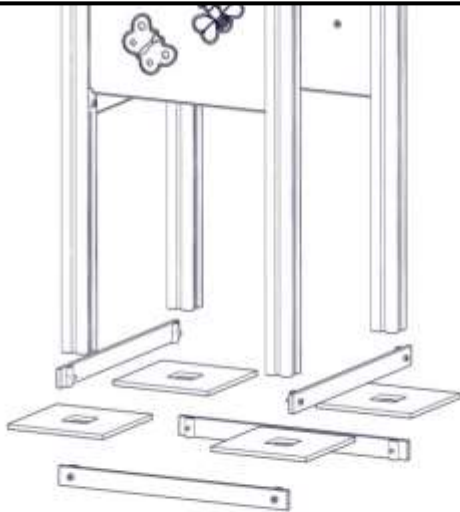
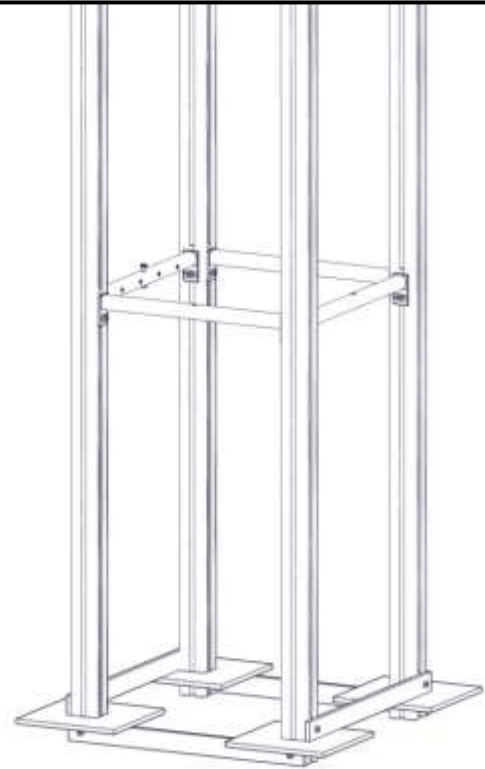
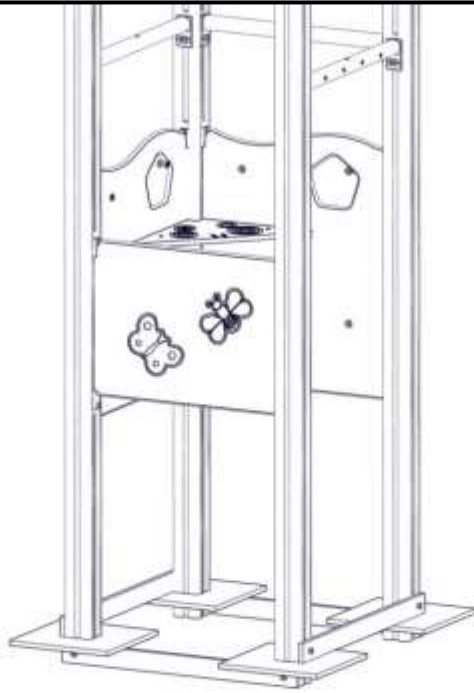

nr	PartName	Artnr	Antall
2	Brikke 50 1XM8	04-060-050	16
4	Fundamet sprosse 660x50	07-510-200	8
3	Fundament 275x275x12	07-510-201	8
1	Torx M8x35	04-000-035	16

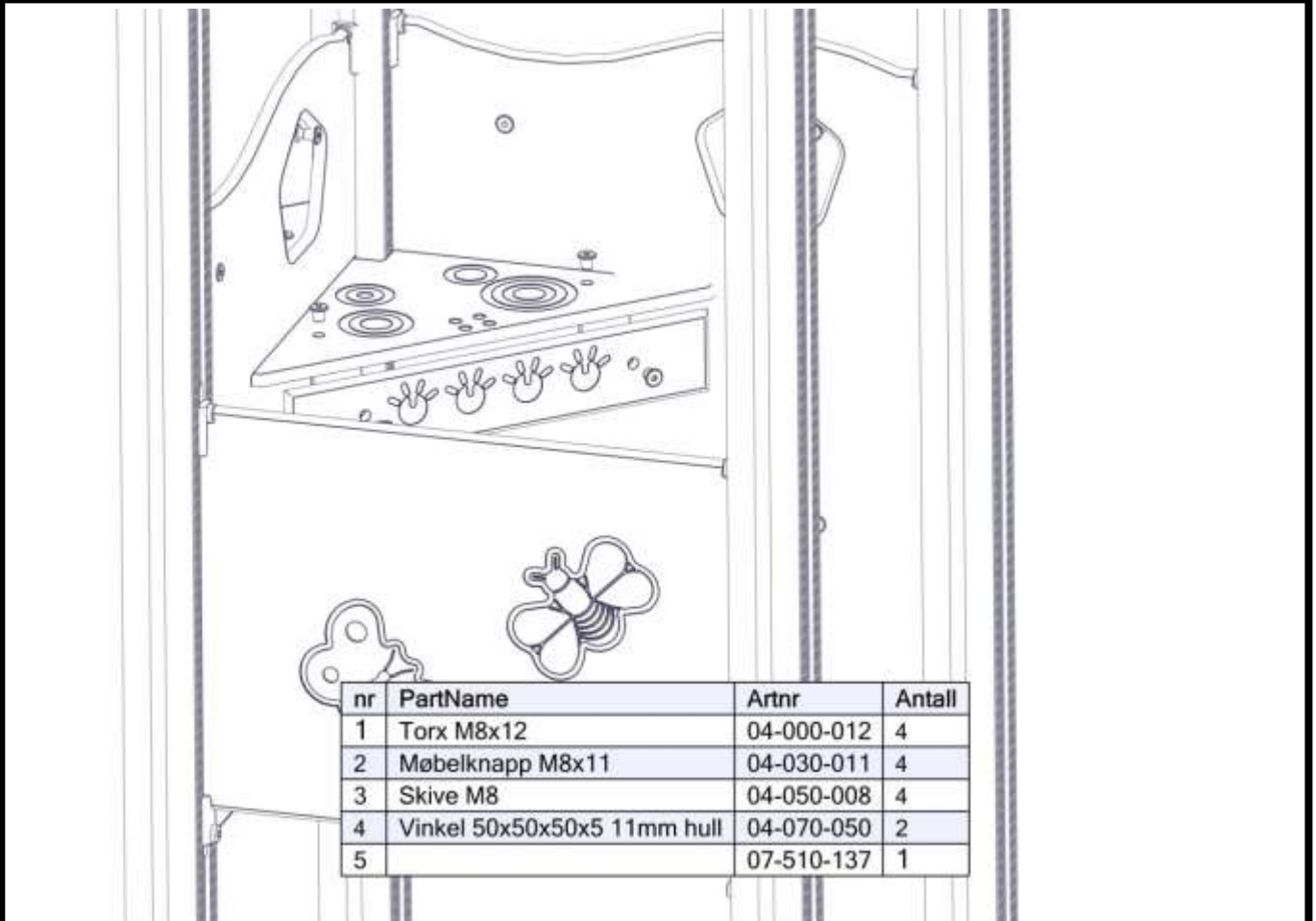
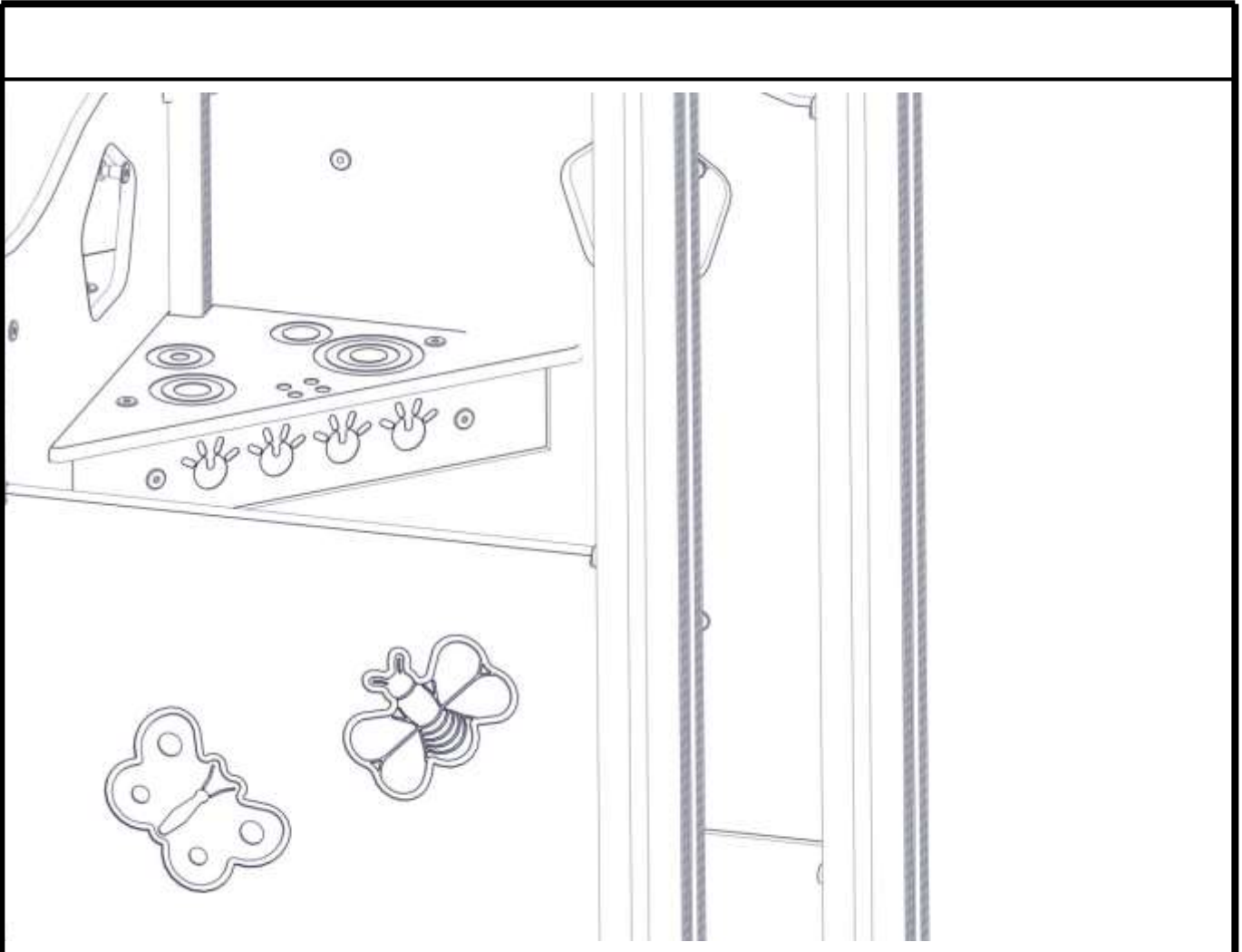

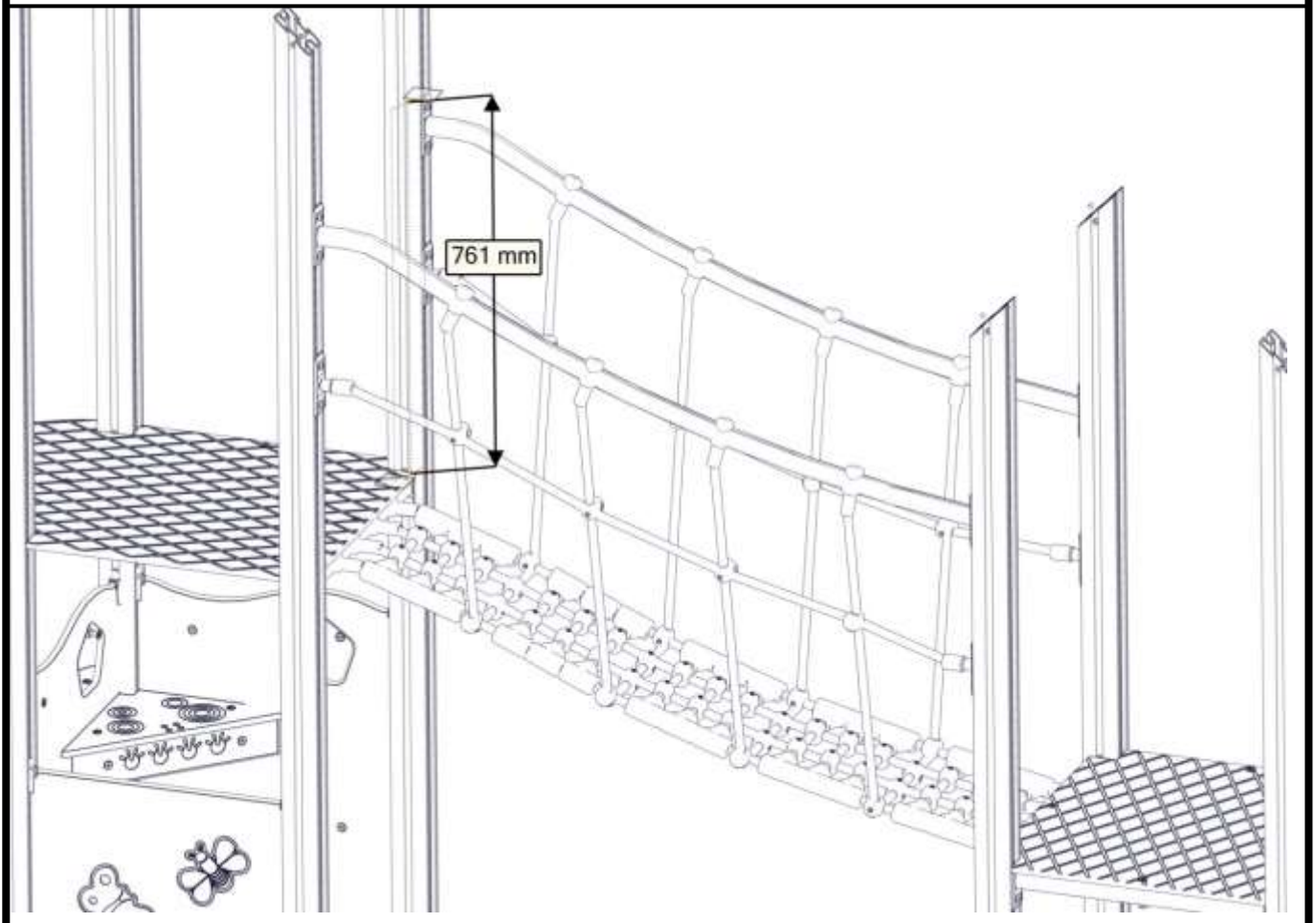
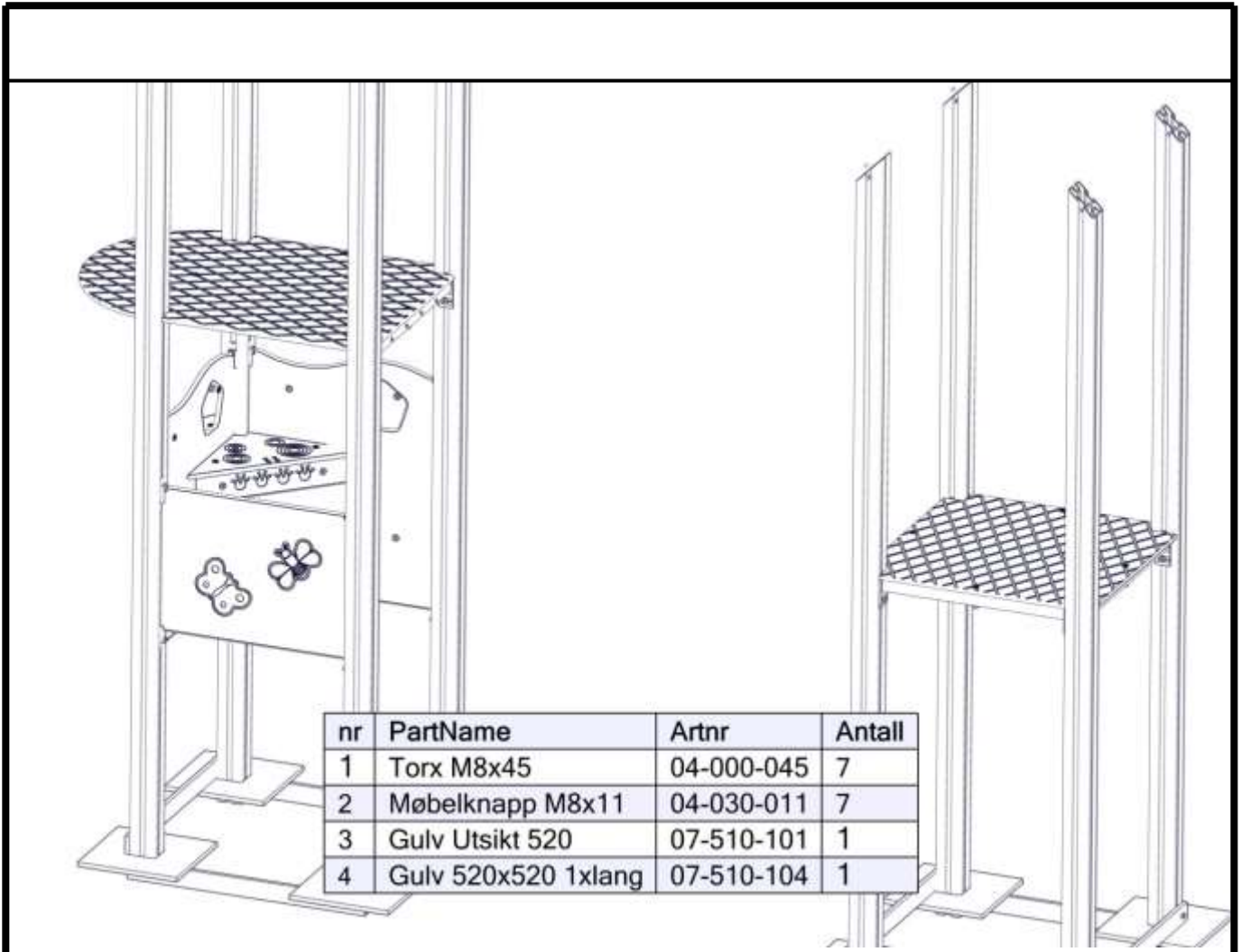



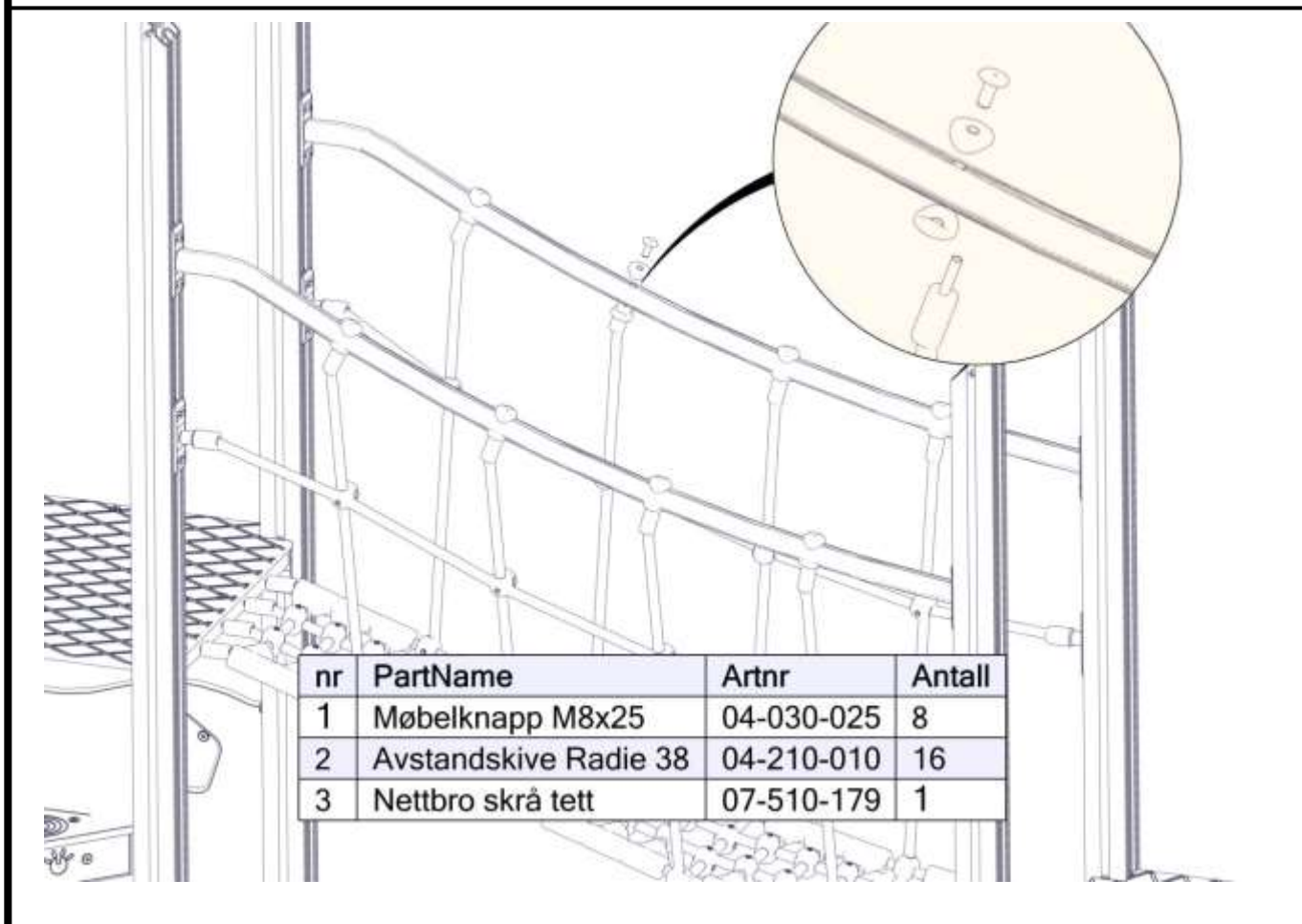
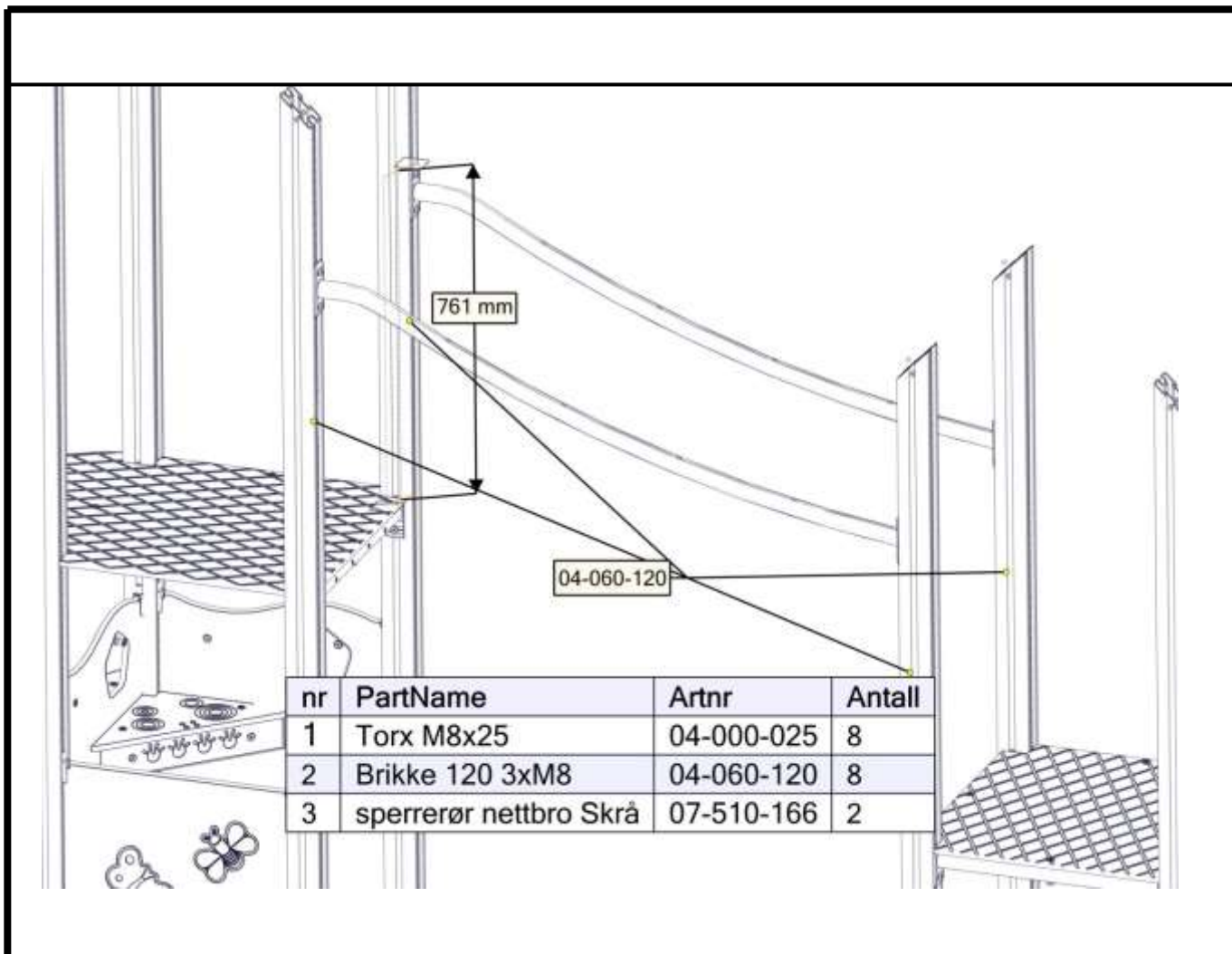

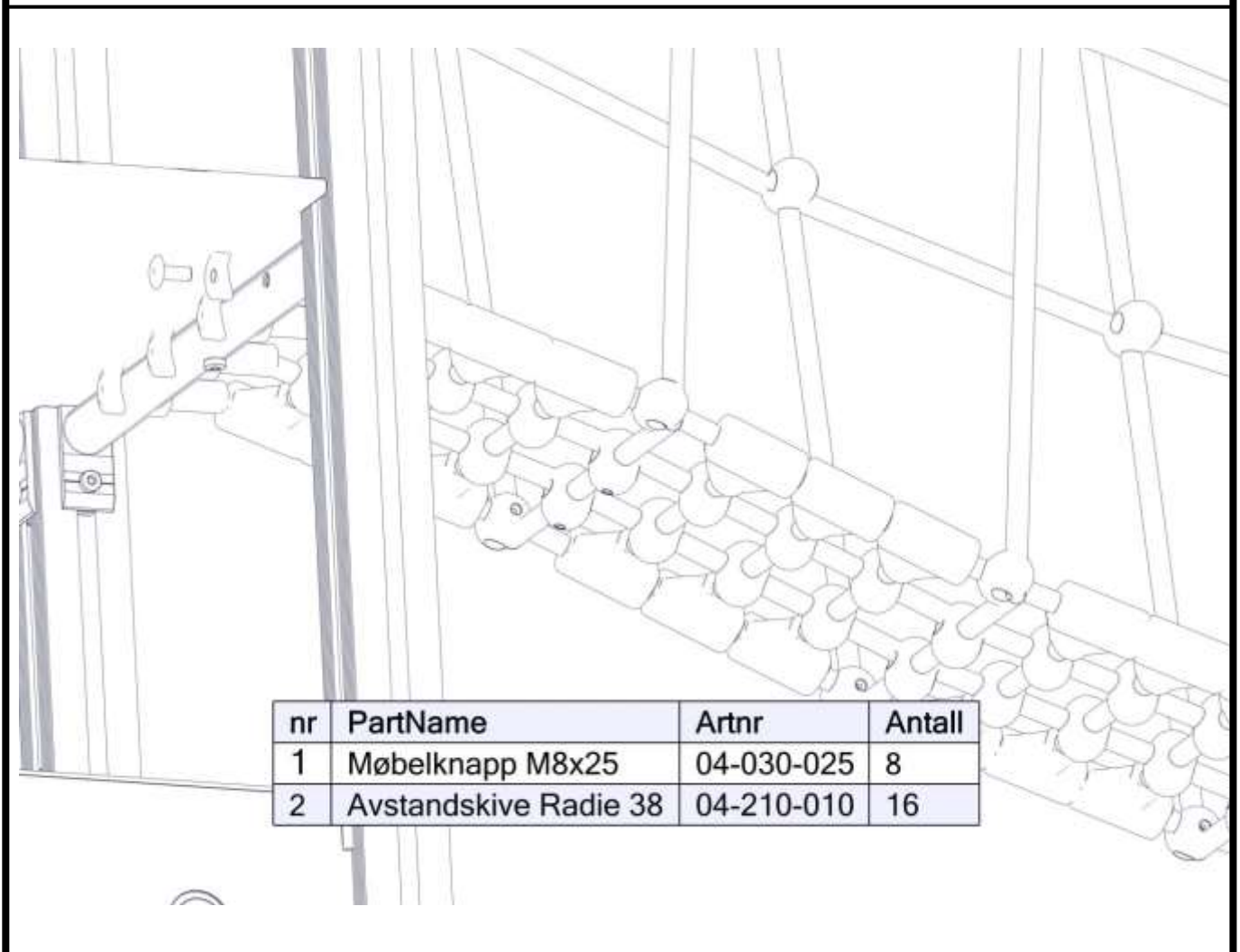
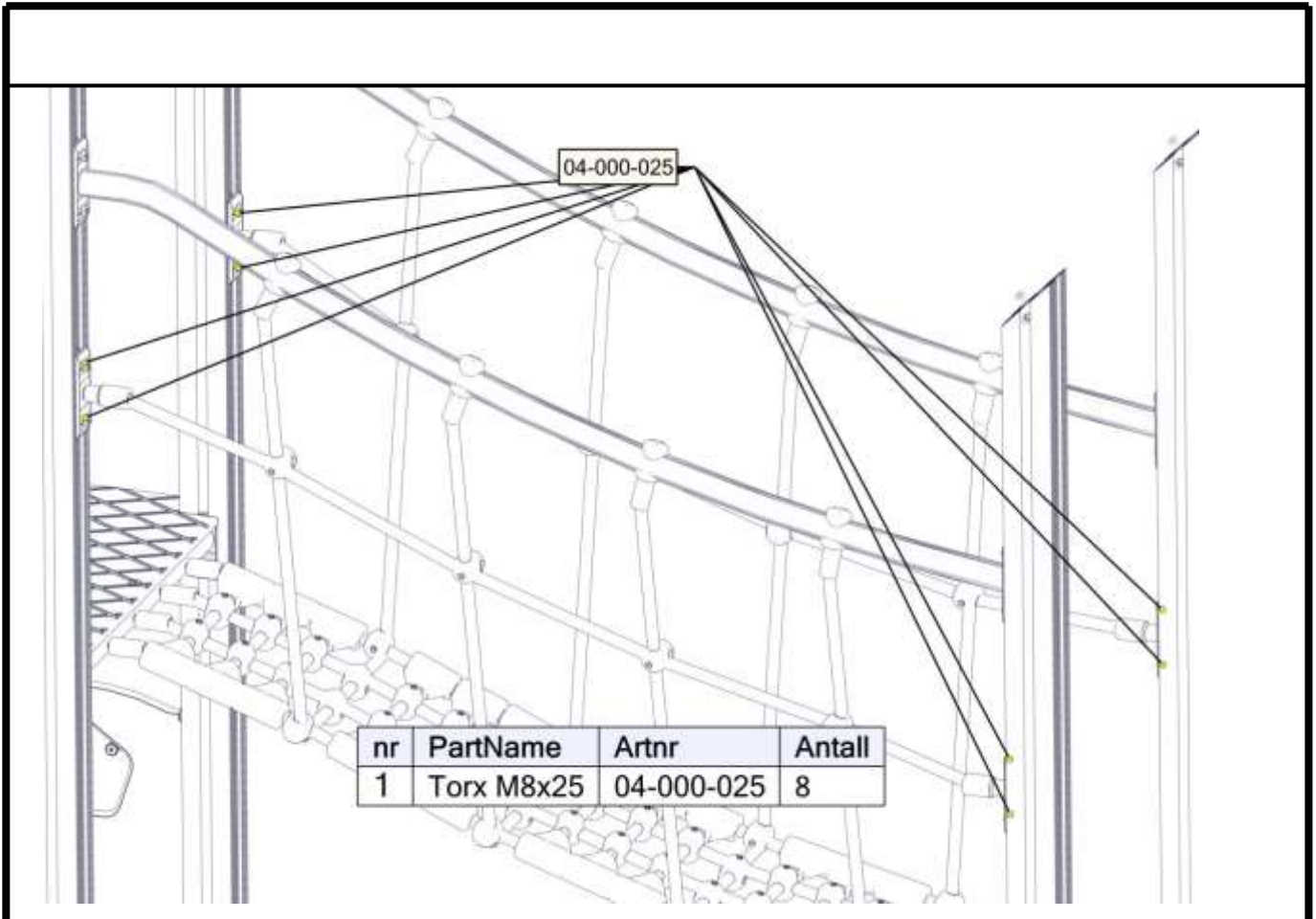

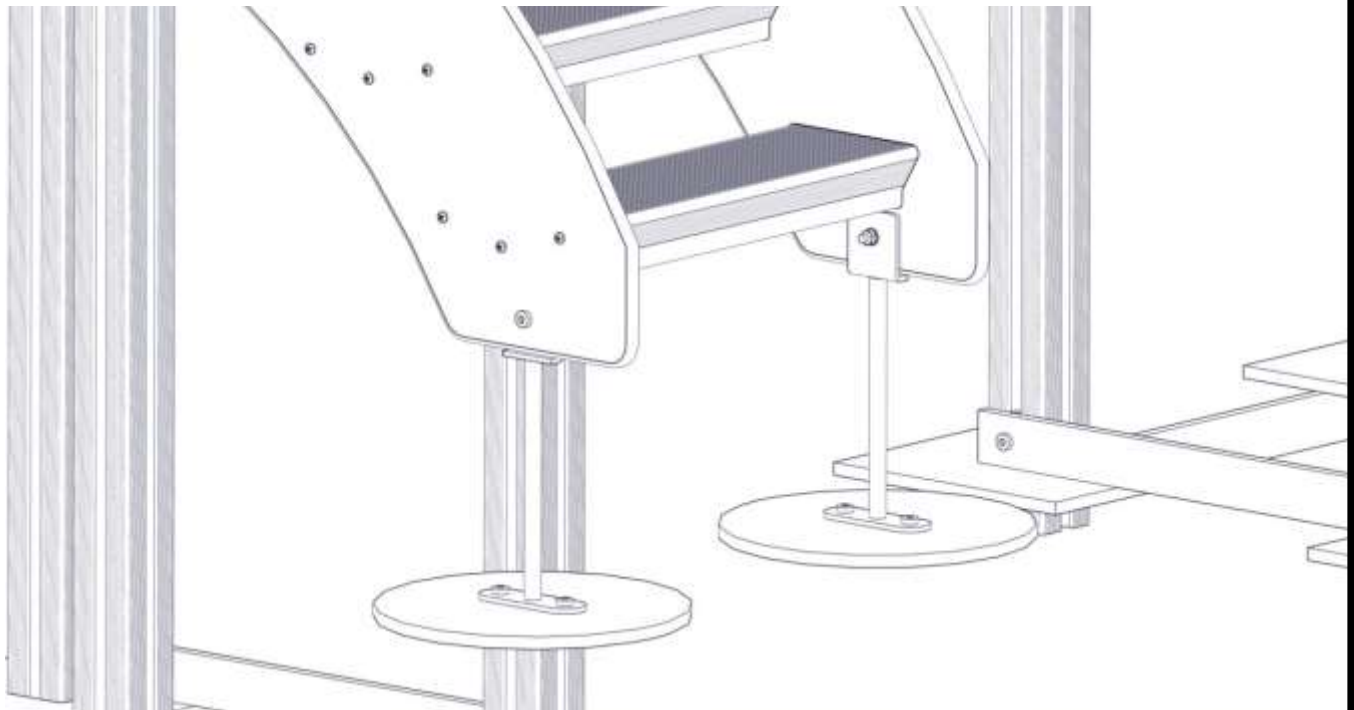
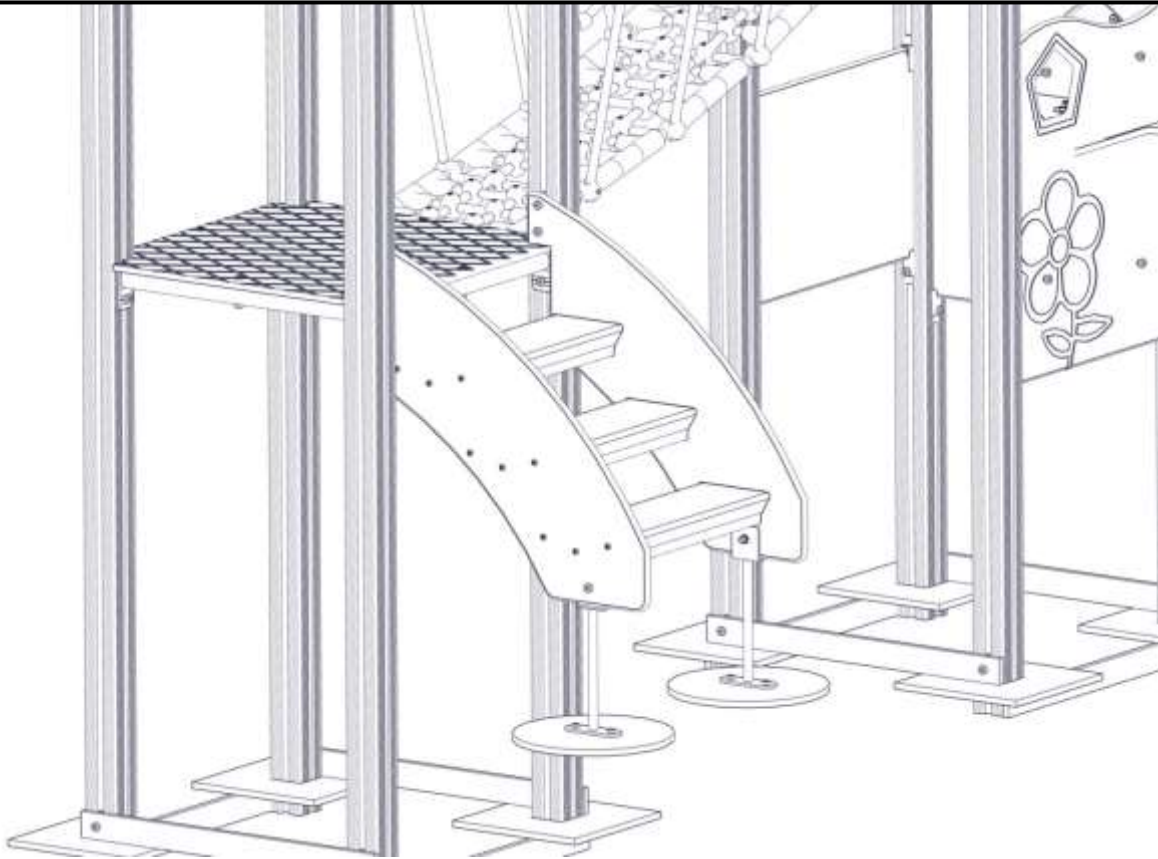

nr	PartName	Artnr	Antall
1	Fundament plate	00-003-103	2
2	Stålforankring 300	00-100-312	2
3	Torx M8x35	04-000-035	6

nr	PartName	Artnr	Antall
4	Låsemutter M8	04-040-008	6
5	Skive M8	04-050-008	6

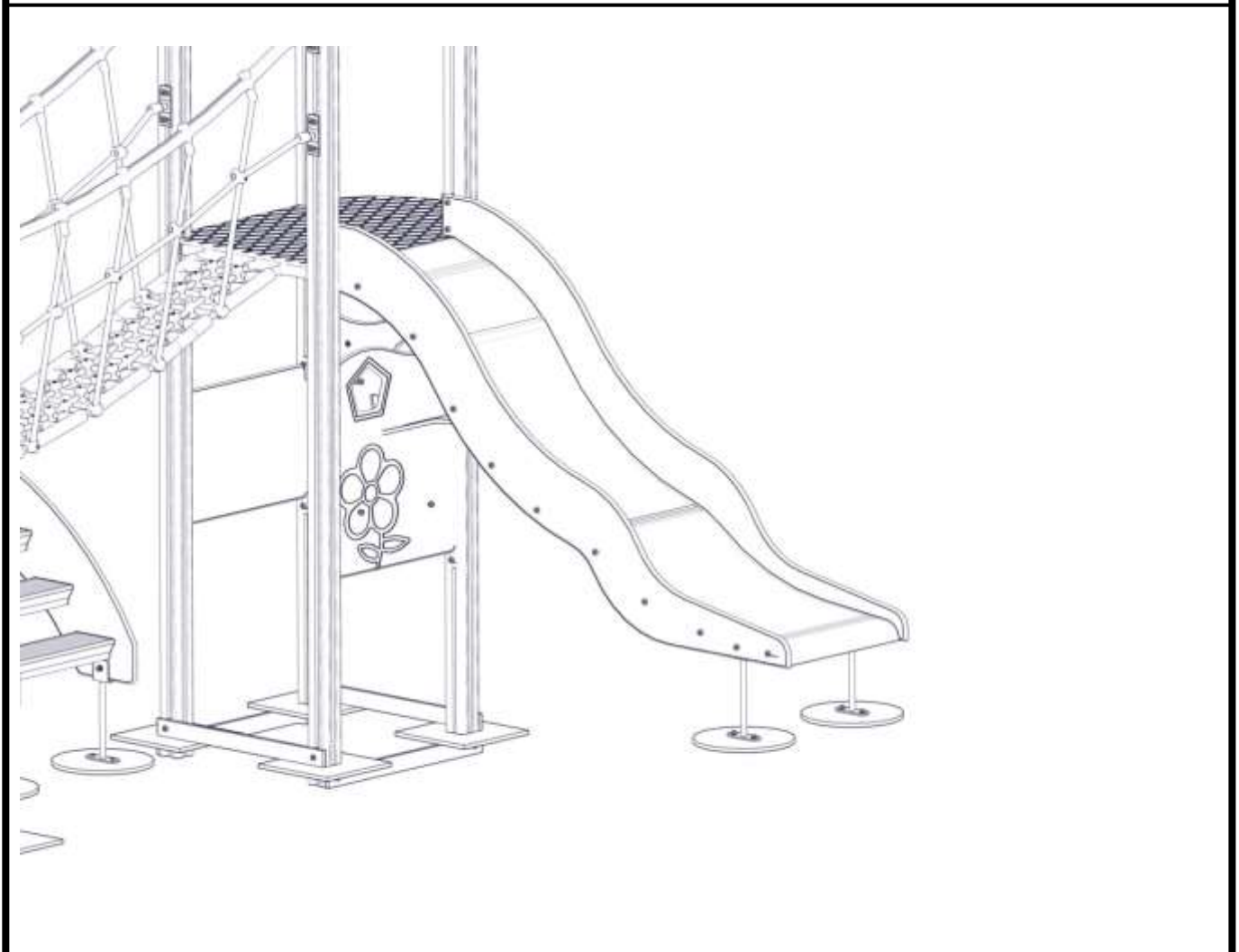
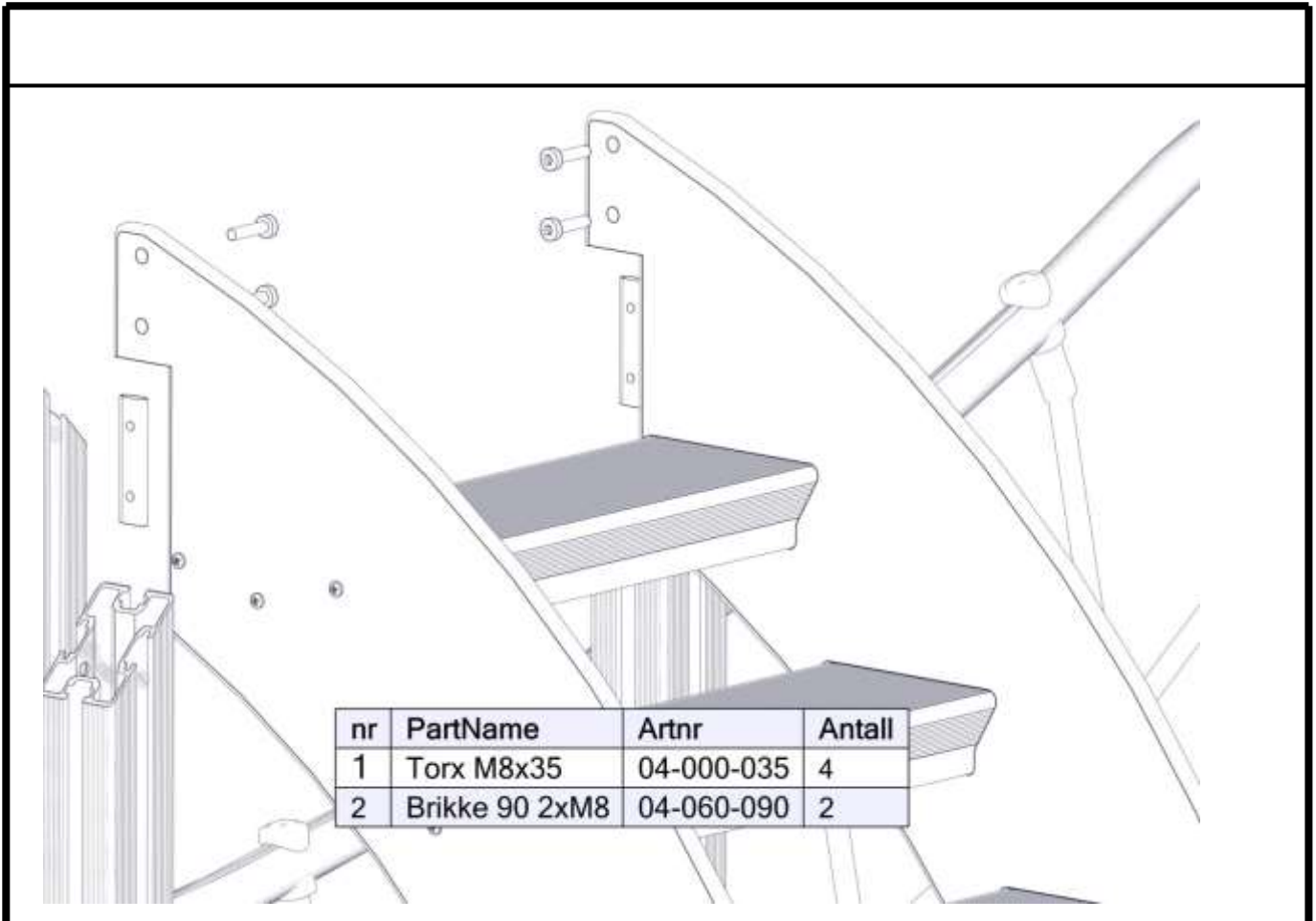

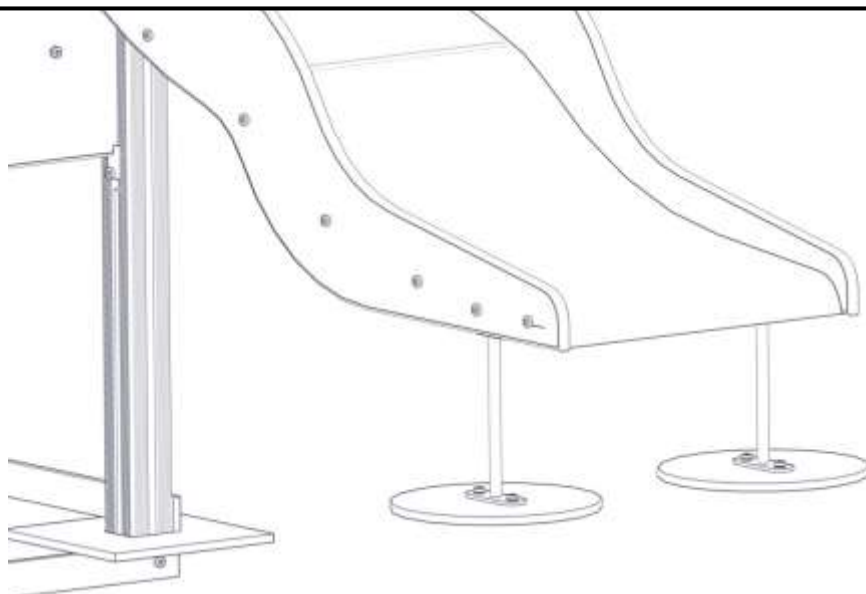

nr	PartName	Artnr	Antall
1	Fundament plate	00-003-103	2
2	Stålforankring 300	00-100-312	2
3	Torx M8x35	04-000-035	4
4	Torx M8x45	04-000-045	2

nr	PartName	Artnr	Antall
5	Låsemutter M8	04-040-008	6
6	Skive M8	04-050-008	10

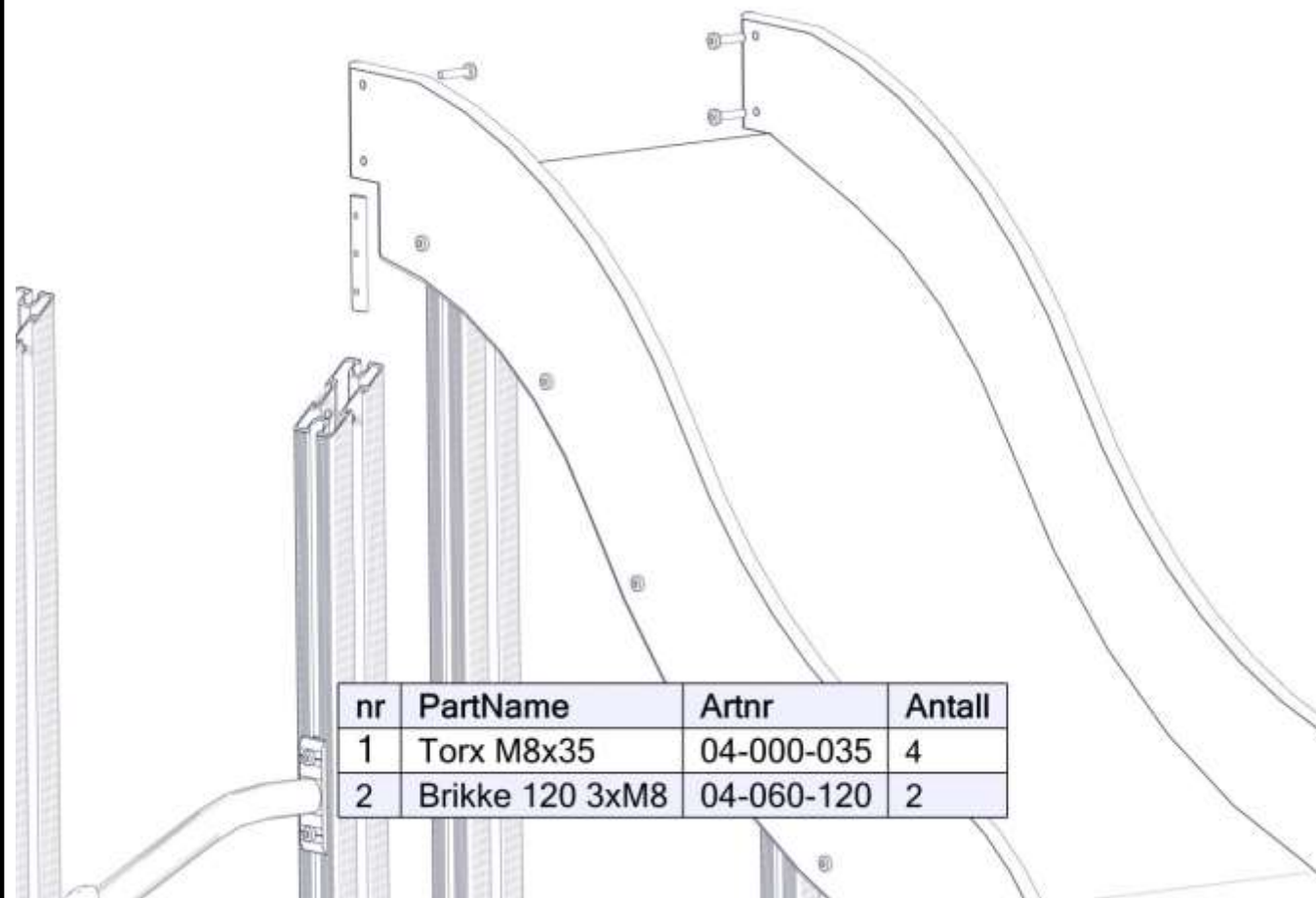

nr	PartName	Artnr	Antall
1	Torx M8x35	04-000-035	4
2	Brikke 120 3xM8	04-060-120	2

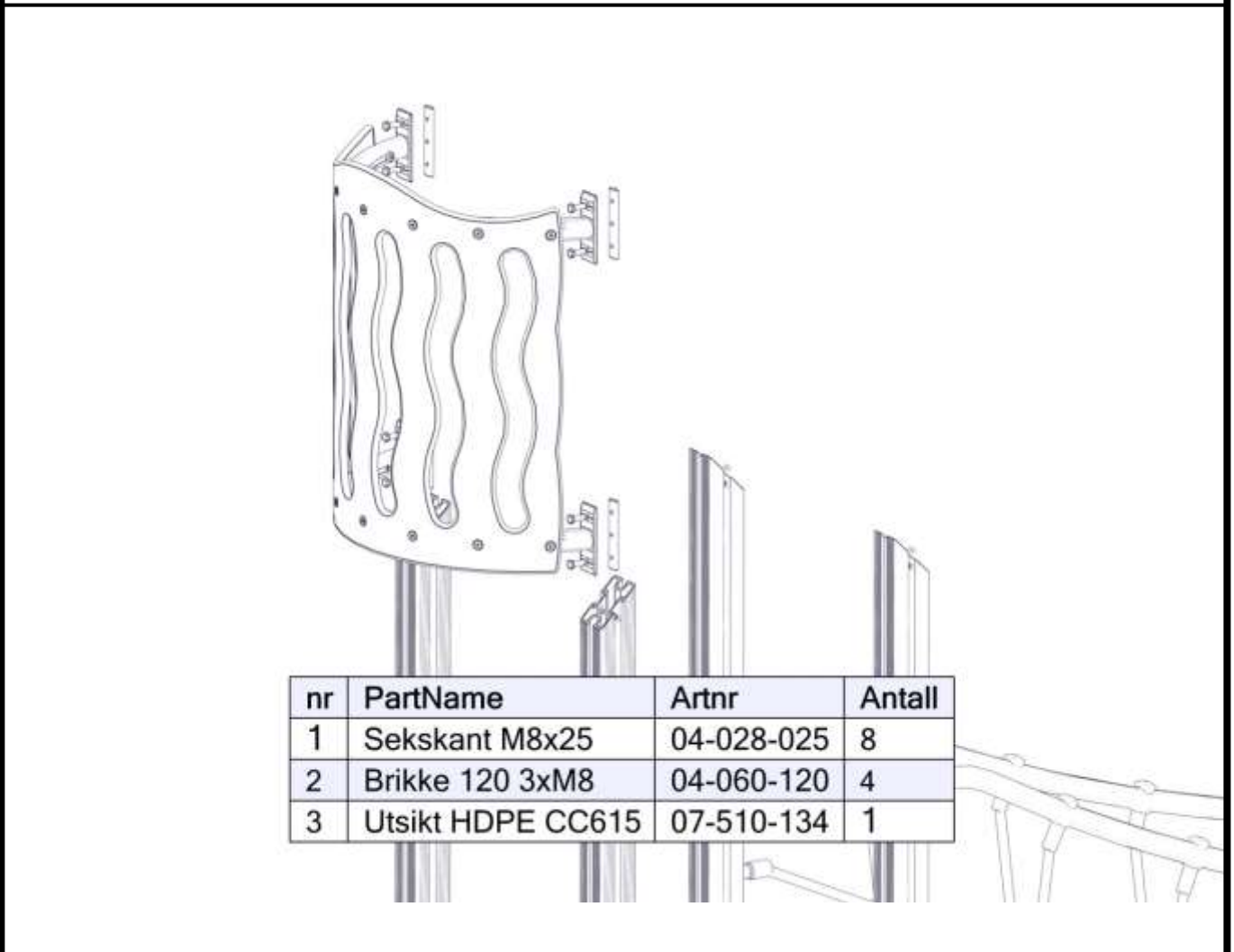
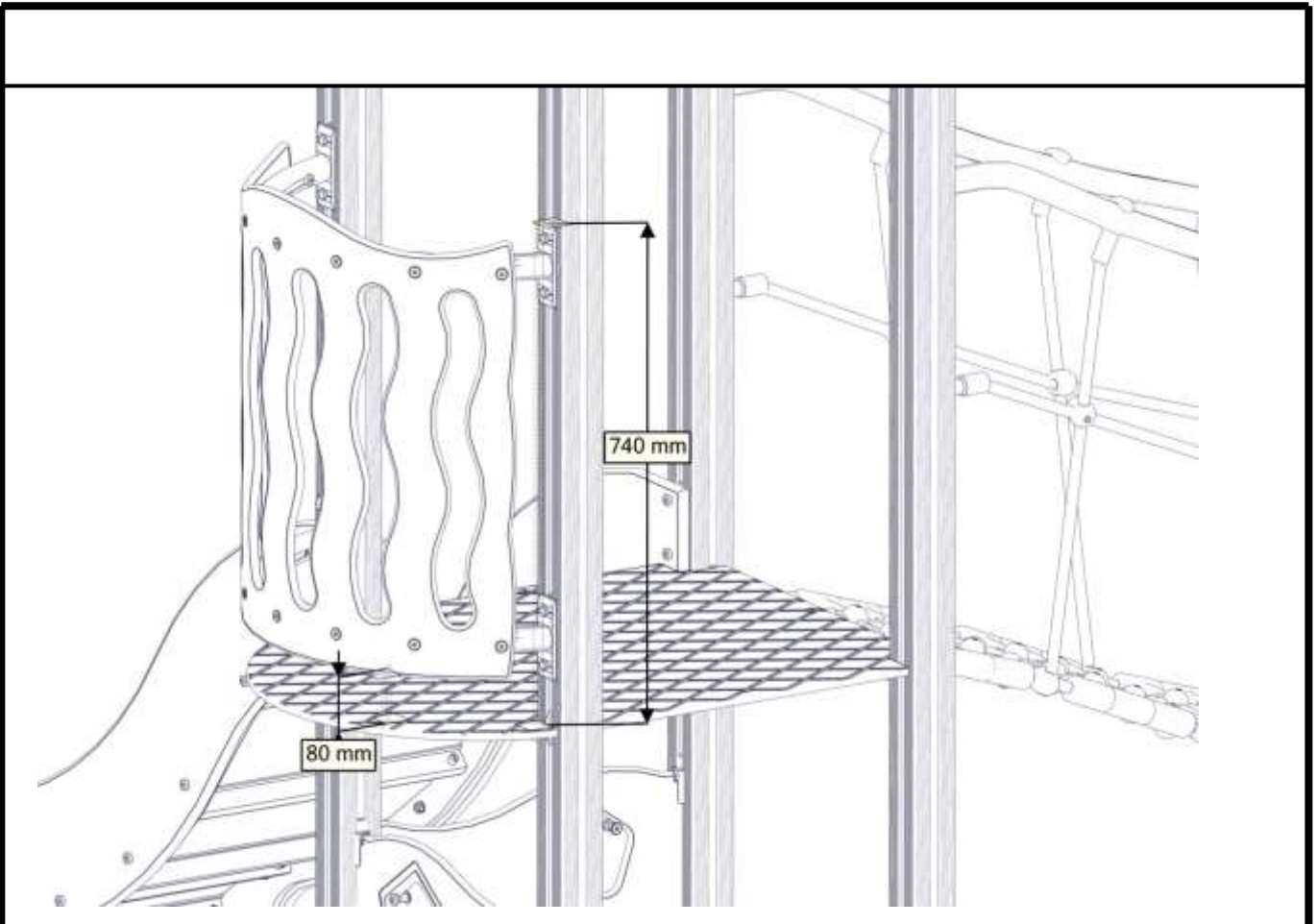

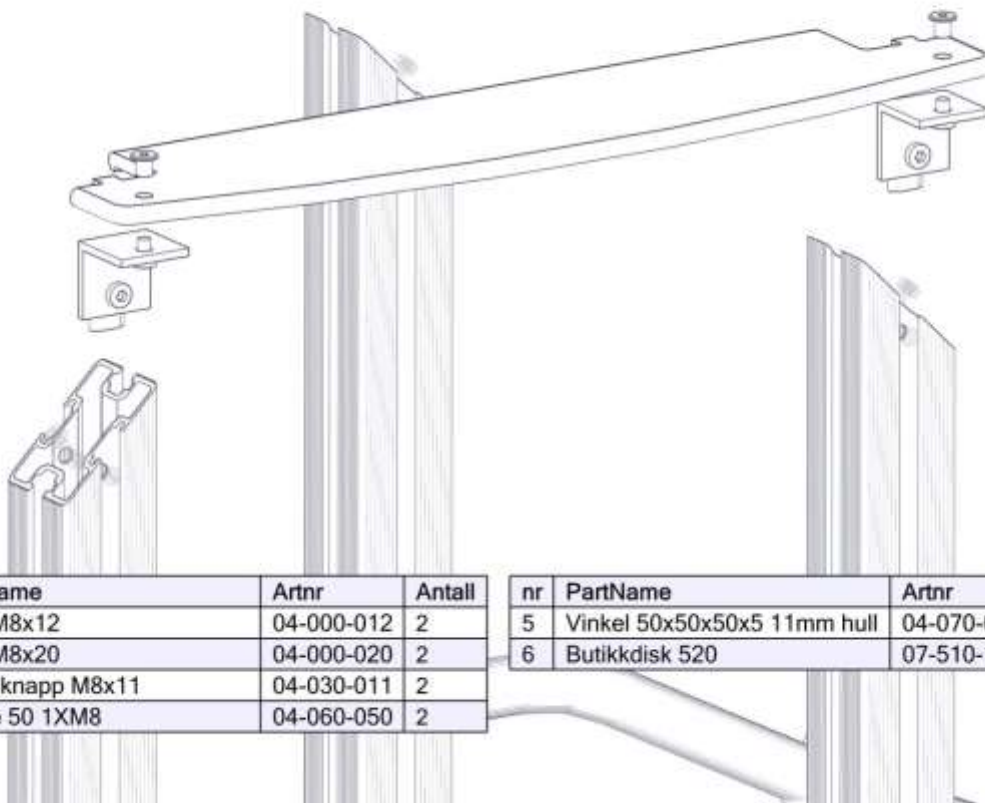
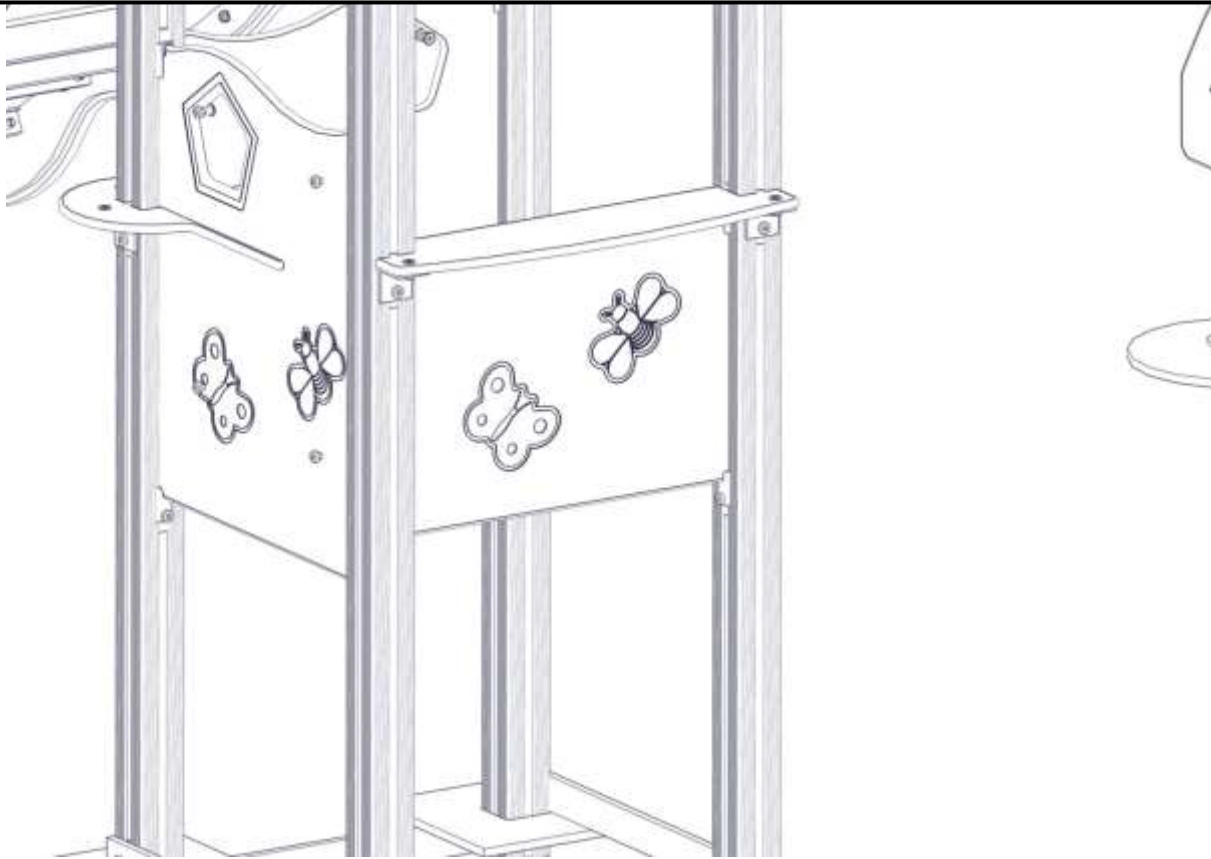

nr	PartName	Artnr	Antall	nr	PartName	Artnr	Antall
1	Torx M8x12	04-000-012	2	5	Vinkel 50x50x50x5 11mm hull	04-070-050	2
2	Torx M8x20	04-000-020	2	6	Butikdisk 520	07-510-130	1
3	Møbelknapp M8x11	04-030-011	2				
4	Brikke 50 1XM8	04-060-050	2				

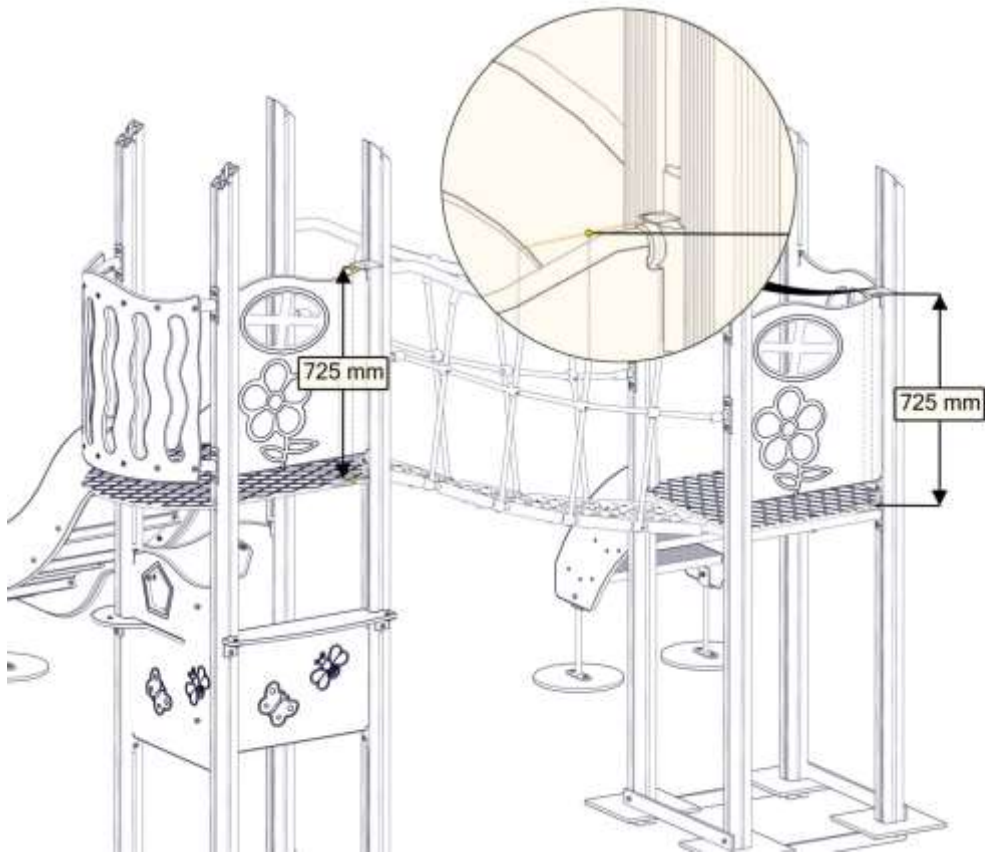

3x

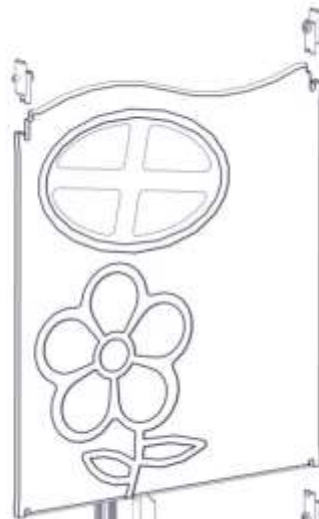

nr	PartName	Artnr	Antall
3	Brikke 50 1XM8	04-060-050	4
4	Brikke Spesial 12mm	04-060-051	4
1	Torx M8x25	04-000-025	4
2	Vegg med vindu	07-510-120	1



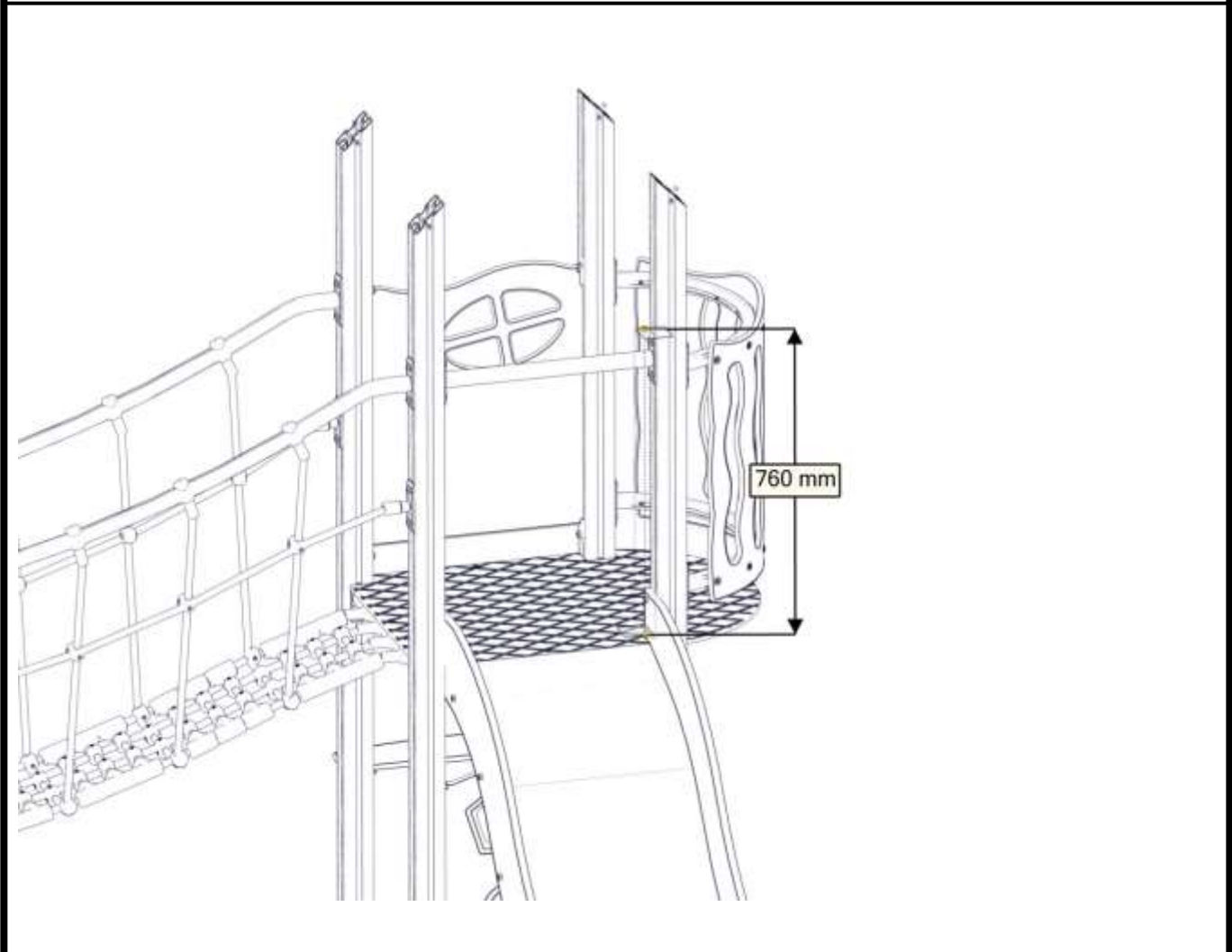
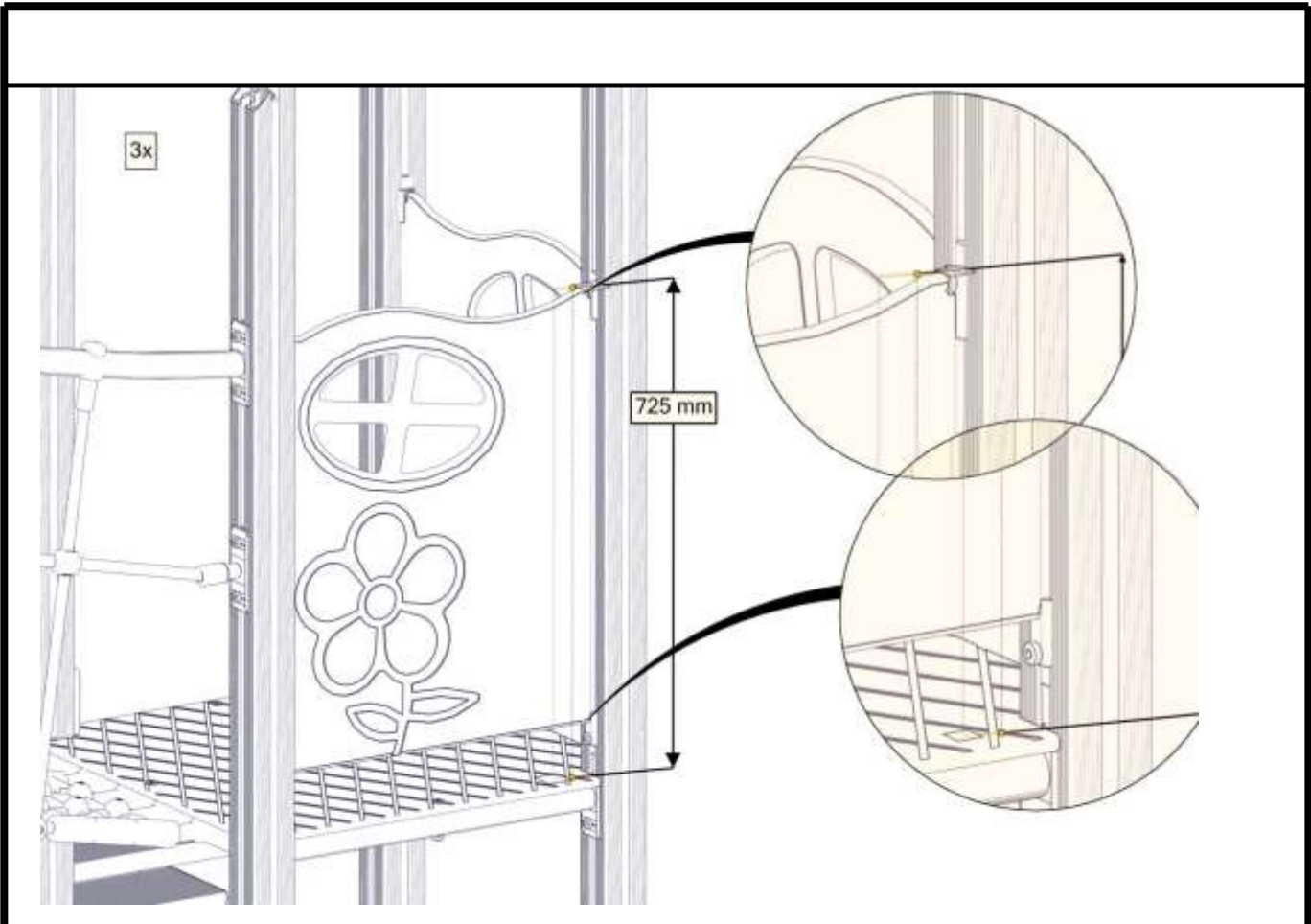

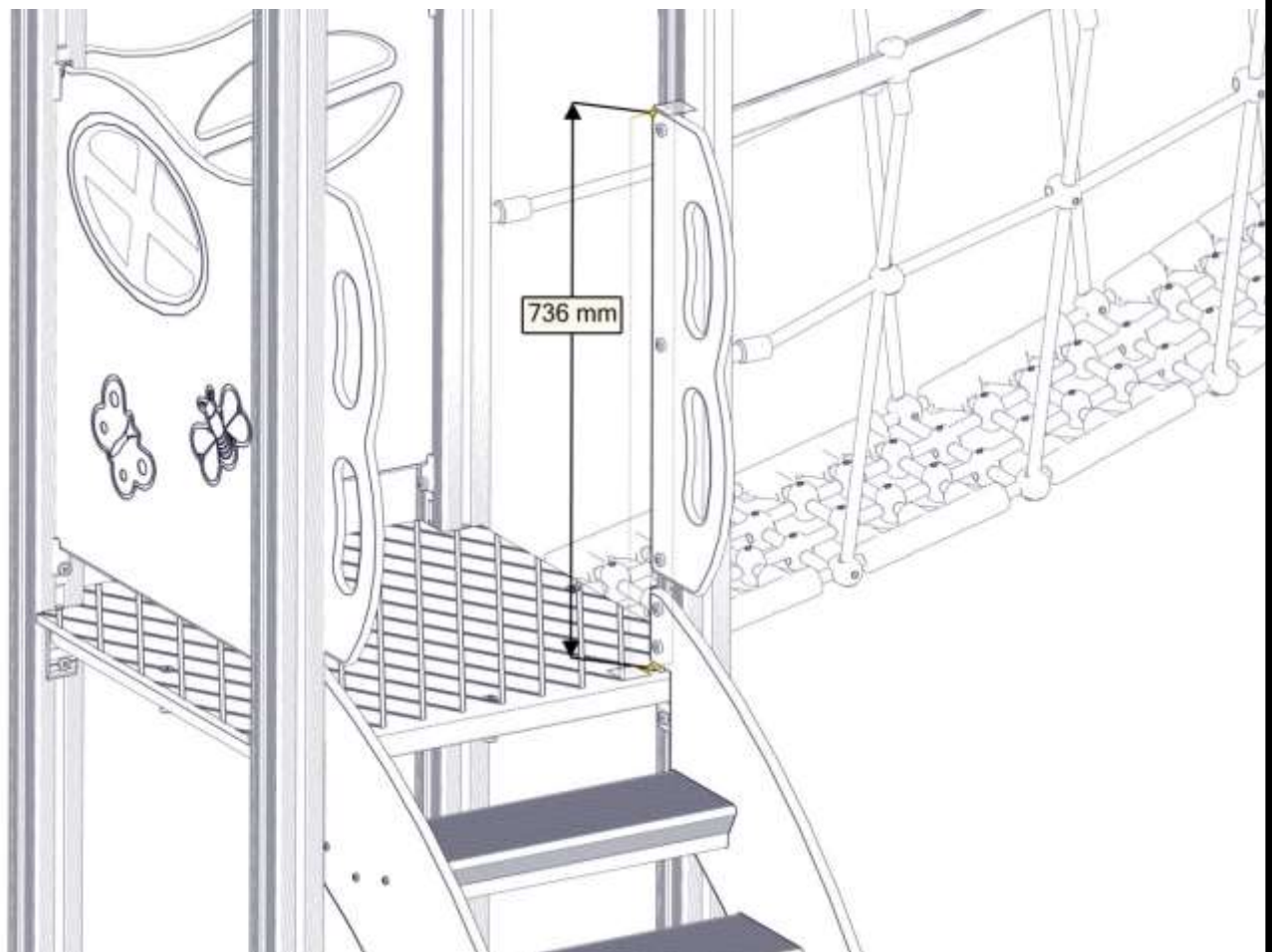
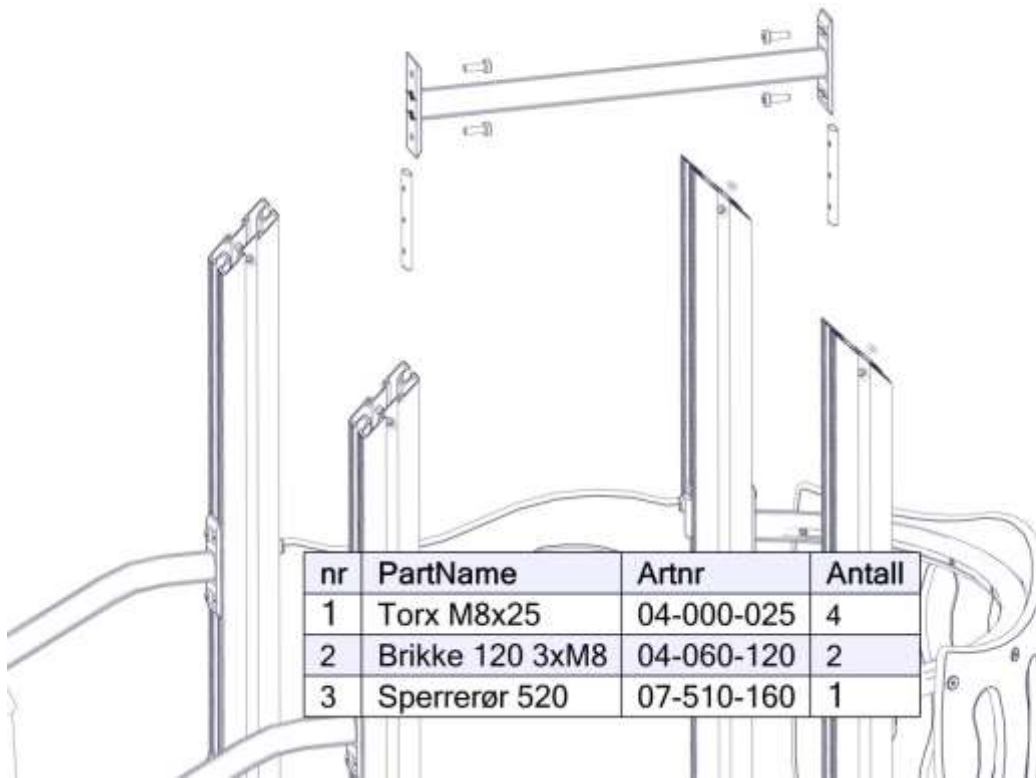

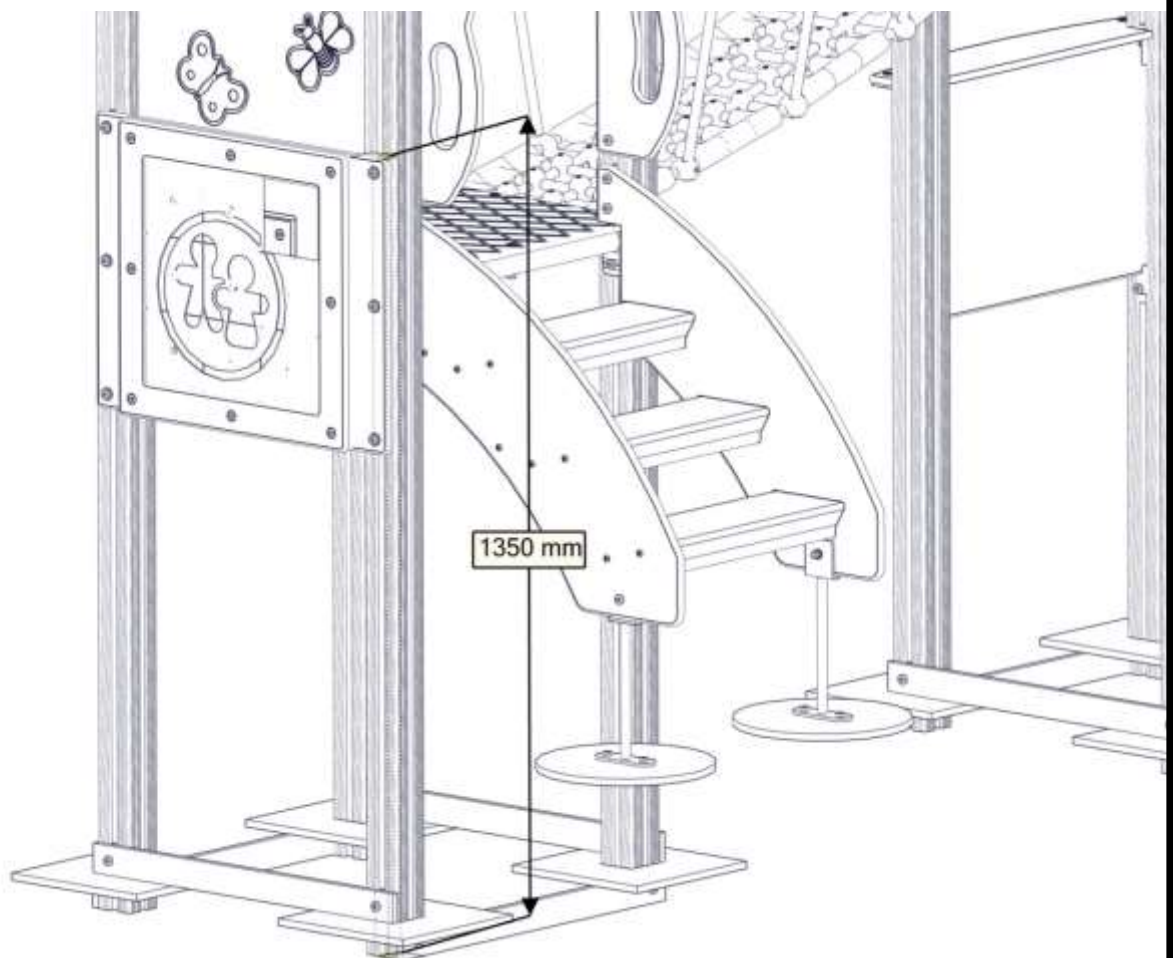
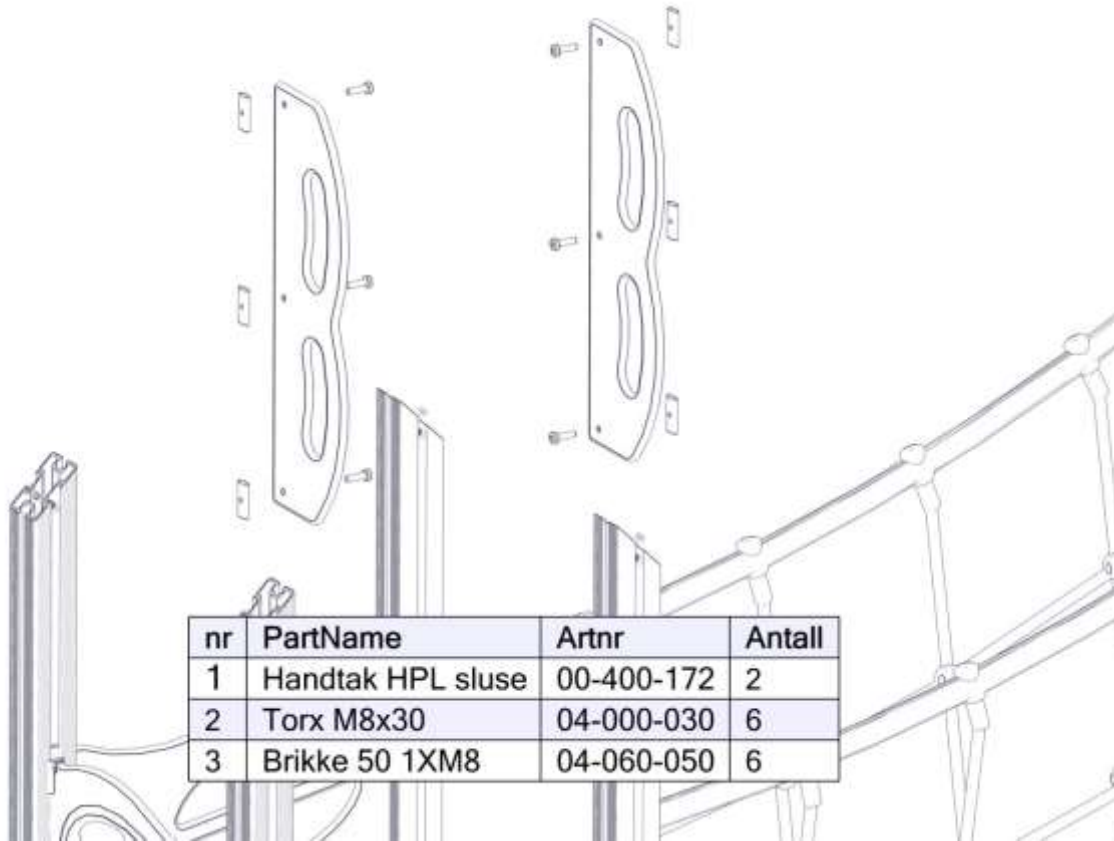

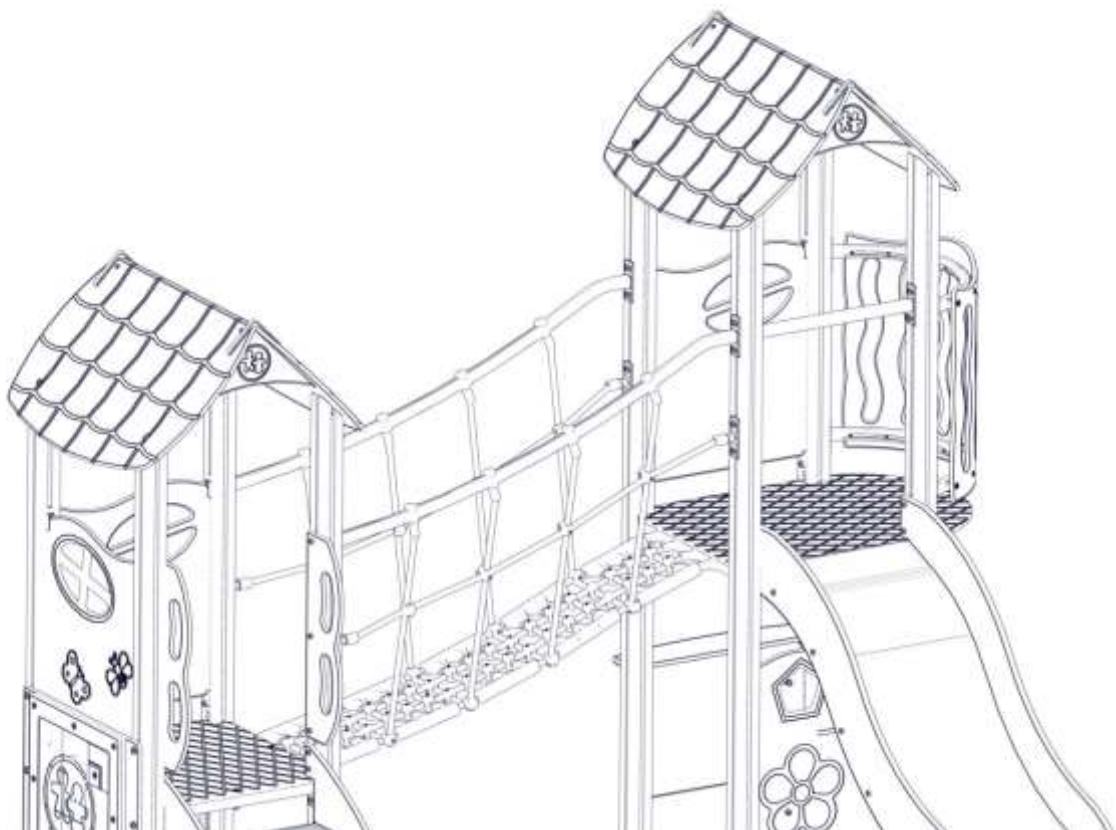
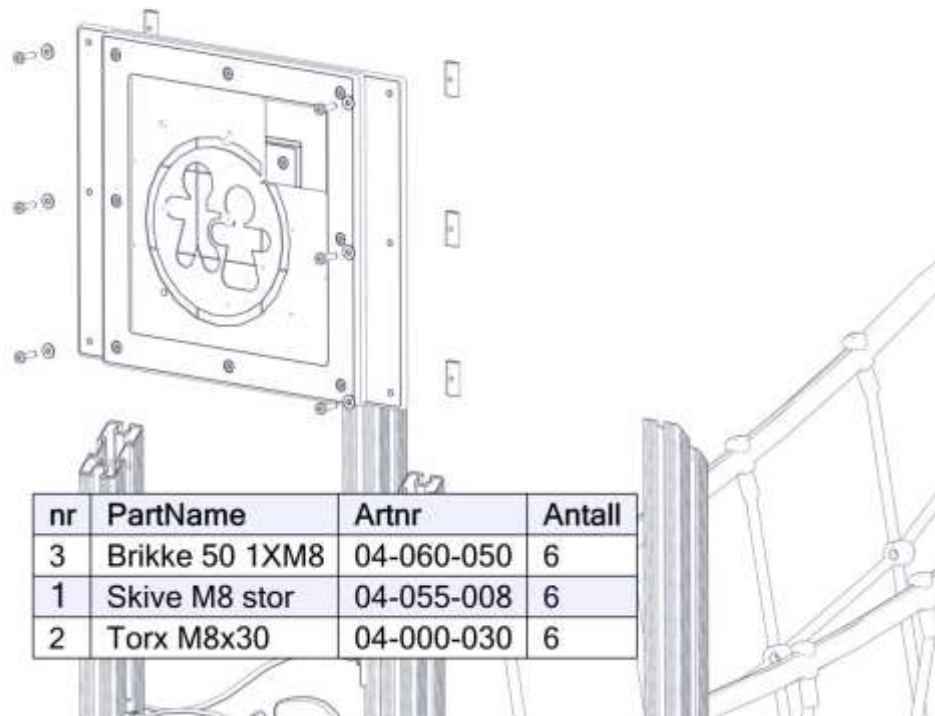

2x

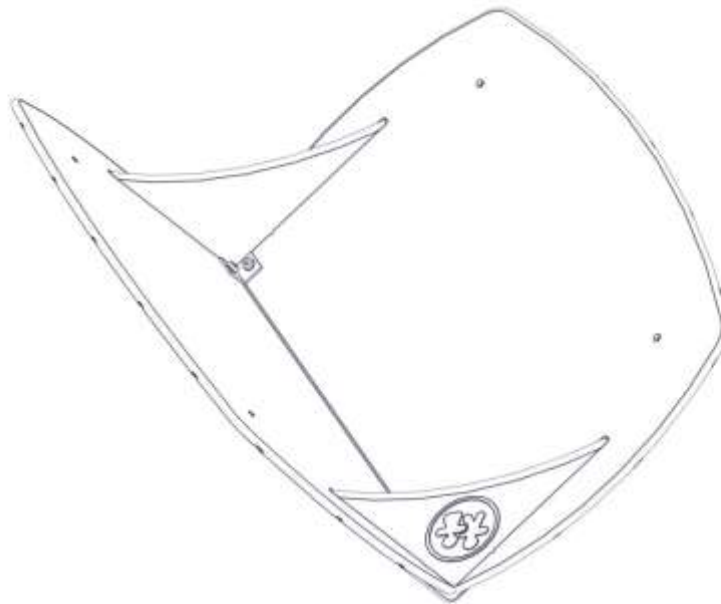

nr	PartName	Artnr	Antall
1	Vinkel 35x35x35x3 11mm hull	04-070-036	2
2	Gavelplate	07-510-106	2
3	Møbelknapp M8x11	04-030-011	4
4	Skive M8	04-050-008	4

nr	PartName	Artnr	Antall
5	Tak 880x580	07-510-105	2
6	Torx M8x12	04-000-012	4

2x

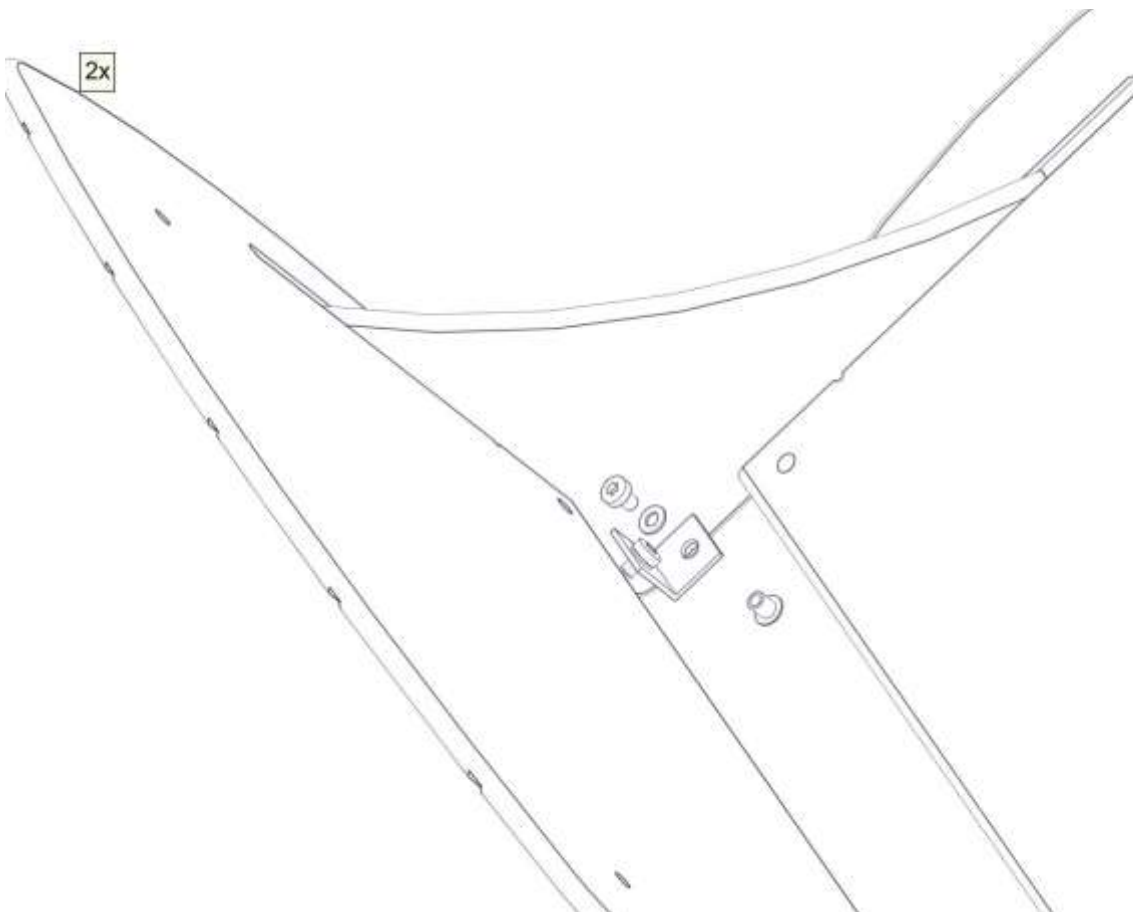

2x

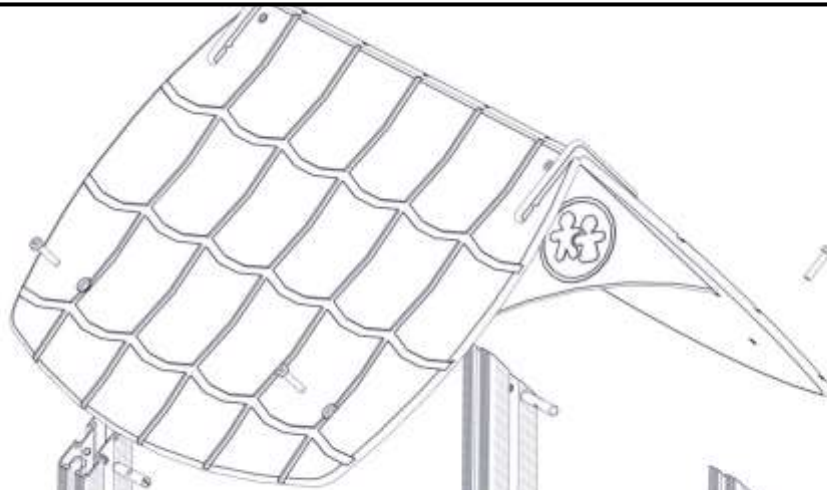









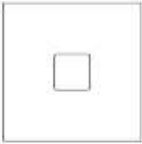



nr	PartName	Artnr	Antall
1	Torx M8x40	04-000-040	4
2	Hylsemutter 70x12 M8	04-018-070	4





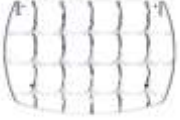



<b>Før utstyret tas i bruk / Before play begins / Innan lekredskapet tas i bruk</b>	
<b>N</b>	<ul style="list-style-type: none"> <li>● Påse at fallunderlag er utlagt i henhold til gjeldende regler eller vår anbefaling</li> <li>● Fjern alle monteringshjelpemidler ( rester av betong, planker, paller, plast, og lignende)</li> <li>● Før utstyret tas i bruk, burde man sjekke at det ikke er fare for at anorakksnorer og lignende som kan hekte seg fast noen steder på lekeapparatet. (Vedlagte snor med dobbe (kneledd) kan brukes til å sjekke at dette er i orden. Se vedlagte veiledning for bruk av denne. Dette gjøres for å oppdage eventuelle feilmonteringer.?)</li> <li>● NB! Bør stå i 2-3 dager før bruk</li> </ul>
<b>EN</b>	<ul style="list-style-type: none"> <li>● Make sure the area and depth of safer surfacing are according to the current standard, or to the manufacturer's recommendation</li> <li>● Make sure all tools and surplus materials are removed before play begins</li> <li>● PS! When complete, allow 2-3 days for the concrete to set before use</li> </ul>
<b>S</b>	<ul style="list-style-type: none"> <li>● Kontrollera att fallunderlag är utlagt enligt gällande regler eller vårt rekommendation</li> <li>● Ta bort alla monteringshjälpmedel (rester av betong, plankor, pallar, plast och liknande)</li> <li>● Innan lekredskapet används, kontrollera att anoracksnoddar eller kläder/delar av kläder eller liknande inte kan fastna i några delar på redskapet. (Den bipackade "knävringen" kan man med fördel användas för denna kontroll.</li> <li>● Detta görs för att upptäcka eventuella felmonteringar.)</li> </ul>



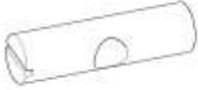

<b>komponenter</b>		Sign. _____.
	VK70 2200-600 skrå 07-510-158	<b>4</b>
	VK70 1700-600 Skrå 07-510-156	<b>4</b>
	Mini fundament skive 07-510-201	<b>8</b>
	Minisprosse fund L=660 07-510-200	<b>8</b>
	Mini Nett brua Skrå 07-510-179	<b>1</b>
	Mini sperrerør brp Skrå 07-510-166	<b>2</b>
	Vegg 520x600 07-510-120	<b>2</b>
	Vegg 520x600 07-510-120	<b>1</b>
	Vegg 520x520 07-510-124 Spor venstre	<b>1</b>
	Vegg 520x520 07-510-123 Spor høyre	<b>1</b>
	Vegg 520x400 07-510-110	<b>1</b>
	Gulv Mini 520 07-510-104 <b>LANG på 1 side</b>	<b>1</b>
	Sperrerør 520 07-510-160	<b>1</b>
	Sperrerø gulv 07-510-161	<b>6</b>
	Produktmerking	
	Sperrerør gulv MED 4 hull 07-510-162	<b>2</b>

<b>komponenter</b>		Sign. _____.
	Utsikt på sper- rerør <b>1</b>  07-510-134	Gulv Utsikt <b>1</b> 05-510-101
	Tak mini <b>4</b> 07-510-105	GavelplateMini <b>4</b> 07-510-106
		Trapp 550 <b>1</b> 01-290-090
	Rutsjebane <b>1</b> 07-510-310	Søve Slide <b>1</b> 25-100-020
	Kokeplate rund <b>1</b> stolpe 07-510-136	Butikkdiskk <b>1</b> 07-510-130
	Kokeplate front <b>1</b> 07-510-135	Håndtak dobbel <b>2</b> 00-400-172
		Produktmerking <b>0</b>  Montert hos Søve

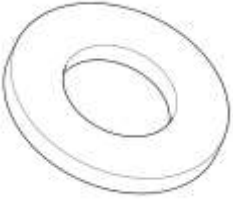
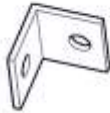
<b>komponenter</b>		Sign. _____				
	Torx M8x12 04-000-012	<b>12</b>		Brikke 50-1T 04-060-050	<b>56</b>	
	Torx M8x20 04-000-020	<b>4</b>			Brikke 120-3T 04-060-120	<b>16</b>
	Torx M8x25 04-000-025	<b>68</b>			Brikke 90-2T 04-060-090	<b>2</b>
	Torx M8x30 04-000-030	<b>16</b>		Spesialbrikke 04-060-041	<b>24</b>	
	Torx M8x35 04-000-035	<b>30</b>			Låsemutter M8 04-040-008	<b>12</b>
	Torx M8x40 04-000-040	<b>8</b>				Stålforankring 00-100-312
	Torx M8x45 04-000-045	<b>10</b>				
	Møbelknapp M8x13x17 04-030-011	<b>24</b>		Hylsemutter M8 12-70 04-018-070	<b>8</b>	
		04-030-025		<b>16</b>		
	Saddelwasher 04-210-010	<b>32</b>				
				Fundamentplate 00-003-106	<b>4</b>	
	Skive M8 04-050-008	<b>30</b>		Vinkel 35x35x35 04-070-036	<b>4</b>	
				Vinkel 50x50x50 04-070-050 11mm	<b>6</b>	