

N**Monteringsanvisning****EN****Assembly Instructions****S****Monteringsanvisning**

Produkt nr. / Product no. / Produkt nr.

25-200-082

Ordr. nr. _____

Dato. _____

Sign. _____



Søve AS
Grønnvoldveien 290
3830 Ulefoss - Norway
Tlf: +47 35 94 65 65
www.sove.no



Søve AB
EA Rosengrensgatan 32
421 31 Västra Frölunda
Phone: +46 (0)31 773 97 00
www.sove.se

Monteringstips / Assembly Advice / Monteringsstips

N

- Les monteringsanvisningen nøye før montering.
- Monter elementene i rekkefølgen som vist.
- Boltene bør ikke skrues for hardt til før alt er montert, vatret og loddet. Skru så boltene til.
- NB! Ved bruk av drill, kan boltene ryke.
- På grunn av at solen kan gjøre rutsjeplaten veldig varm, bør rutsjebanens utløp vende mot nord-øst eller nord-vest.
- Er lekeutstyret plassert i naturlige ferdselstraséer må området sikres mot gjennomgang.
- Innspringningshinder bør vurderes rundt lekeapparater hvor det er stor bevegelse, f.eks. ved huskestativ.
- Det bør være fritt innsyn til lekeutstyr som er beregnet for barn under 3 år.

NB! Under monteringsarbeidet må utstyr, som ikke er forankret forsvarlig i bakken, sikres slik at det ikke velte.

Området må avstenges under montering av apparatene med sperrebånd eller lignende.

EN

- Read the instruction carefully before assembling the play unit.
- Assemble the components in the sequence shown in these instructions. Fixings must not be fully tightened during assembly. Before casting the foundations, the structure must be level and plumb, at which point all fixings are tightened. PSI If use of drill, the bolts may be wrecked.
- Avoid positioning the slide facing due south because of overheating – ideal positions are facing north-east or north-west. Secure the construction-area to prevent people from walking through it.
- Consider installing barriers around play-equipment which gives rise to a lot of activity – i.e. swings.
- Ensure that clear vision is possible across the play area so that supervision is possible from any position, particularly where children under 3 years of age will be playing.

NB! During assembly of the equipment, ensure that all structures are securely propped, especially when left overnight. Also ensure that equipment is supported

Monteringstips / Assembly Advice / Monteringsstips

S

- Läs monteringsanvisningen noga före montering.

- Montera delarna i den ordningen som anvisas
- Skruvarna bör inte skruvas för hårt tills allt är monterat, i våg och lodat.











OBS! Används elektrisk skruvdragare, kan bulten gå sönder. Härddra därför manuellt!

- Solen kan göra att rutchbanan blir väldigt varm. Banans nedfart rekommenderas att vändas i norrlig riktning
- Om lekplatsen placeras vid en gångväg mm bör området säkras mot genomfart av gående och cyklister.
- Insprängningshinder bör placeras runt lekutrustning med stor rörelse, t ex, gungställning.
- Det bör vara fri insyn till lekutrustning beräknat till barn under 3 år.

OBS! Under monteringsarbete bör utrustningen som inte ska förankras i marken, ställs så att den inte kan välta.

Området måste spärras när lekutrustningen byggs upp, med avspärrningsband eller liknande.

Nødvendig verktøy / Tools required / Nödvändiga verktyg

<p>(N)</p> <p>(EN)</p> <p>(S)</p>	<p>(A)</p> 	<p>(B)</p>  <p>Torx Nr 45 High quality</p>	<p>(C)</p> <p>5 mm 6 mm</p> 	<p>(D)</p> 	<p>(E)</p> 
		<p>Metermål Metric measure Tumstock</p> 	<p>16 V</p> 	<p>Merkebånd Mark ribbon Märkeband</p> 	<p>13 + 17mm</p> 

Nødvendig antall personer / Number of persons required / Lämpligt antal personer





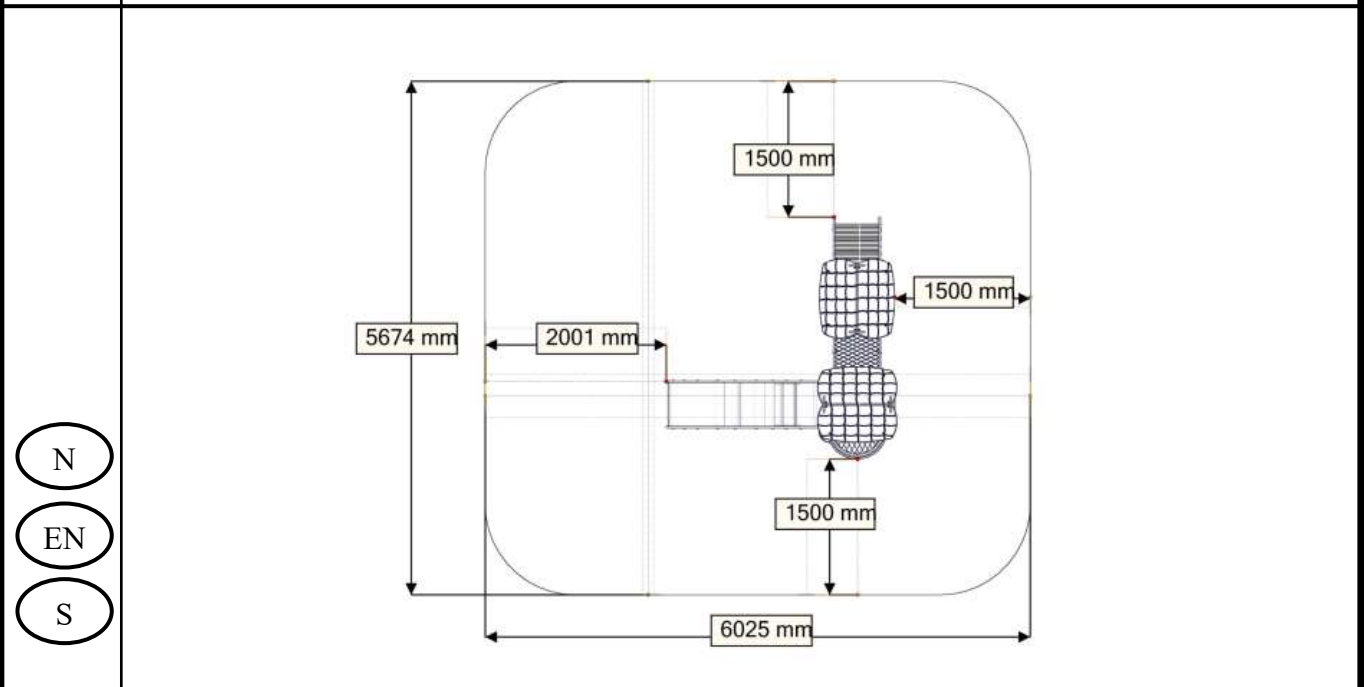







Anbefalt arealbehov ved montering / Recommended working space / Rekommenderad arealbehov vid montering

















Boltepakker for / Boltpackage for / Bultpaket för

Sign. _____

Stolpe 70x70 skrå	Ant= 4	Navn	Artnr/dimensjon	Ant	Lev
		VK70 2200-600 (1) Skrå	07-510-154	4	
		VK70 1700-600 Brikke på stolpe!	07-510-156	4	
		Torx M8x40 (1)	04-000-040	8	
		Hullsemutter (1) VK70	04-018-070	8	
FundamentMini	Ant= 8	Navn	Artnr/dimensjon	Ant	Lev
		MiniSprosse 660 (1)	07-510-200	8	
		Brikke 50_1T (2)	04-060-040	16	
		Torx M8x35 (2)	04-000-035	16	
FundamentSkive	Ant= 8	Navn	Artnr/dimensjon	Ant	Lev
		Skive (1)	07-510-201	8	
Gulv mini LANG på 1 side	Ant= 1	Navn	Artnr/dimensjon	Ant	Lev
		Gulv Mini 520(1)	07-510-104 LANG PÅ 1 SIDE	1	
		Møbelknapp (4)	04-030-011	4	
		Torx M8x45 (4)	04-000-045	4	







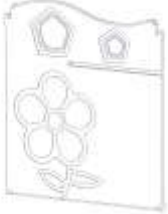

Boltepakker for / Boltpackage for / Bultpaket för

Sign. _____

Vegge 520x600 Vindo bloms	Ant= 2	Navn	Artnr/dimensjon	Ant	Lev
		Vegge520x600 (1) Vindu blom	07-510-120	2	
		Brikkespesial(4)	04-060-041	8	
		Brikke(4)	04-060-040	8	
		Torx M8x25(4)	04-000-025	8	
Vegge 520x600 Vindo Bi	Ant= 1	Navn	Artnr/dimensjon	Ant	Lev
		Vegge520x600 (1) Vindu bi/ Sommerfulg	07-510-120	1	
		Brikkespesial(4)	04-060-041	4	
		Brikke(4)	04-060-040	4	
		Torx M8x25(4)	04-000-025	4	
Vegge 520x400 Sommerfugl / bie	Ant= 1	Navn	Artnr/dimensjon	Ant	Lev
		Vegge520x400 (1) Sommerfugl/bi	07-510-110	1	
		Brikkespesial(4)	04-060-041	4	
		Brikke(4)	04-060-040	4	
		Torx M8x25(4)	04-000-025	4	

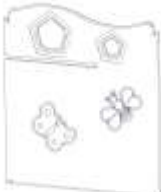







Boltepakker for / Boltpackage for / Bultpaket för

Sign. _____.

Vegge 520x520 Vindo bloms med spor	Ant= 1	Navn	Artnr/dimensjon	Ant	Lev
Til Kokeplatte 		Vegge520x520 (1) Vindu blom	07-510-123	1	
		Brikkespesial(4)	04-060-041	4	
		Brikke(4)	04-060-040	4	
		Torx M8x25(4)	04-000-025	4	
Vegge 520x520 Vindo Bi med spor	Ant= 1	Navn	Artnr/dimensjon	Ant	Lev
Til Kokeplatte 		Vegge520x520 (1) Vindu bi/ Sommerfulg	07-510-124	1	
		Brikkespesial(4)	04-060-041	4	
		Brikke(4)	04-060-040	4	
		Torx M8x25(4)	04-000-025	4	

Boltepakker for / Boltpackage for / Bultpaket för

Sign. _____.

Kokeplate rund stolpe	Ant= 1	Navn	Artnr/dimensjon	Ant	Lev
		Kokeplate rund stolpe	07-510-136	1	
		Kokeplate front	07-510-137	1	
		Vinkel 50x50x5(4) 11mm	04-070-050	4	
		Møbelknapp(6)	04-030-011	6	
		Brikke 501T(2)	04-060-050	2	
		Torx M8x12 (6) Torx M8x20 (2)	04-000-012 04-000-020	6 2	
		Skive M8 (6)	04-050-008	6	

Boltepakker for / Boltpackage for / Bultpaket för

Sign. _____.

Sperrerør 520	Ant= 2	Navn	Artnr/dimensjon	Ant	Lev
		Sperrerør 520 (1)	07-510-160	2	
		Brikke 120_3T (2)	04-060-120	4	
		Torx M8x25 (4)	04-000-025	8	
Sperrerør 520 gulv	Ant= 8	Navn	Artnr/dimensjon	Ant	Lev
		Sperrerør 520 (1)	07-510-161	8	
		Brikke 90_2T (2)	04-060-090	0 På stolpe	
		Torx M8x25 (2)	04-000-025	16	
Utsikt	Ant= 1	Navn	Artnr/dimensjon	Ant	Lev
		Utsikt med sperrerør (1)	07-510-134	1	
		Gulv til utsikt (4)	05-510-101	1	
		Torx M8x45 (4) Torx M8x25(8)	04-000-045 04-000-025	4 8	
		Møbelknapp M8x13x17	04-030-011	4	
		Brikke 120_3T	04-060-120	4	













Boltepakker for / Boltpackage for / Bultpaket för

Sign. _____.

Skrå plato	Ant= 1	Navn	Artnr/dimensjon	Ant	Lev
		Venstre vegg Skrå plato	07-510-321	1	
		Gulv Skrå plato	07-510-323	1	
		Høyre vegg Skrå plato	07-510-322	1	
		Vinkel 35x35x35x3 11mm hull	04-070-036	2	
		Møbelknapp M8x13x17	04-030-011	2	
		Torx M8x12 Torx M8x25	04-000-012 04-000-025	2 14	
		Låsse Mutter M8	04-040-008	2	
		Skive M8	04-050-008	4	
		Brikke 50_1T	04-060-050	12	









Boltepakker for / Boltpackage for / Bultpaket för

Sign. _____.

Trappe 550 01-290-090	Ant= 1	Navn	Artnr/dimensjon	Ant	Lev
		Rutsjebane	01-290-090	1	
		Brikke90 3T(5)	04-060-090	2	
		Torx M8x35(4)	04-000-035	10	
		Fundamentskive(2) 2H 80	00-003-106	2	
		Skive M8(2)	04-050-008	6	
		Mutter M8(2)	04-040-008	6	
		Stålforankering(2)	00-100-312	2	
Søve Slide	Ant= 1	Navn	Artnr/dimensjon	Ant	Lev
		Søve Slide	25-100-020	1	
		Brikke 50_1T (6)	04-060-050	6	
		Torx M8x30 (6)	04-000-030	6	
		Skive M8	04-050-008	6	











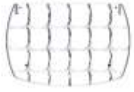

Boltepakker for / Boltpackage for / Bultpaket för

Sign. _____

Rutsjebane 950 07-510-310	Ant= 1	Navn	Artnr/dimensjon	Ant	Lev
		Rutsjebane	07-510-310	1	
		Brikke120 3T(5)	04-060-120	2	
		Torx M8x35(4)	04-000-035	4	
		Torx M8x45(2)	04-000-045	2	
		Torx M8x30(4)	04-000-030	4	
		Fundamentskive(2) 2H 80	00-003-106	2	
		Skive M8(2)	04-050-008	6	
		Mutter M8(2)	04-040-008	6	
	Stålforankering(2)	00-100-312	2		

Boltepakker for / Boltpackage for / Bultpaket för

Sign. _____.

Tak	Ant= 2	Navn	Artnr/dimensjon	Ant	Lev
		Tak mini (2)	07-510-105	4	
		Gavelplate(2)	07-510-106	4	
		Vinkel 35x35x3(2) 11mm	04-070-036	4	
		Møbelknapp	04-030-011	8	
		Torx M8x12(4)	04-000-012	8	
		Skive M8 (4)	04-050-008	8	
Buttikdisk	Ant= 1	Navn	Artnr/dimensjon	Ant	Lev
		Buttikdiskk	07-510-130	1	
		Vinkel 50x50x4(2) 11mm	04-070-050	2	
		Møbelknapp(2)	04-030-011	2	
		Brikke 501T(2)	04-060-040	2	
		Torx M8x12 (2) Torx M8x20 (2)	04-000-012 04-000-020	2 2	
		Skive M8 (2)	04-050-008	2	

Fundamentering med betong / Foundation concrete / Förankring med betong

(N)	Støtsand		(N)	(UK)	(S)
(UK)	Safer surface		Bakkenivå	Ground level	Marknivå
(S)	Stridsan		↓ Ref NS-EN 177		
(N)	Komprimert masse.	betong			
(UK)	Compressed mass.	concrete			
(S)	Komprimerad massa.	betong			

Fundamentering uten betong / Foundation without concrete / Förankring utan betong

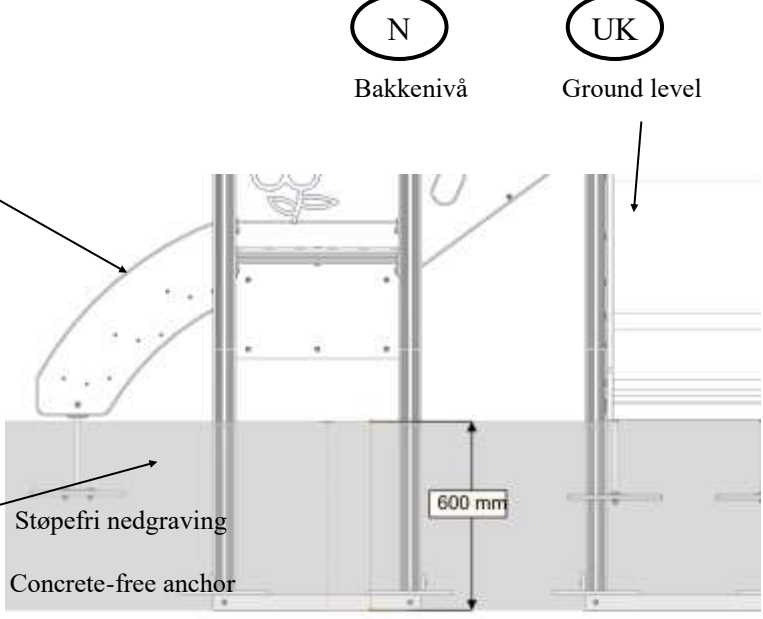
(N)	Støtsand		(N)	(UK)	(S)
(UK)	Safer surface		Bakkenivå	Ground level	Marknivå
(S)	Stridsan		↓ Ref NS-EN 1177		
(N)	Komprimert masse	Støpefri nedgraving			
(UK)	Compressed mass	Concrete-free anchor			
(S)	Komprimerad massa	Nedgrävningfundament			

(N)	Alle mål er oppgitt i millimeter
(UK)	Scale measured in mm
(S)	Alla mått är i millimeter.

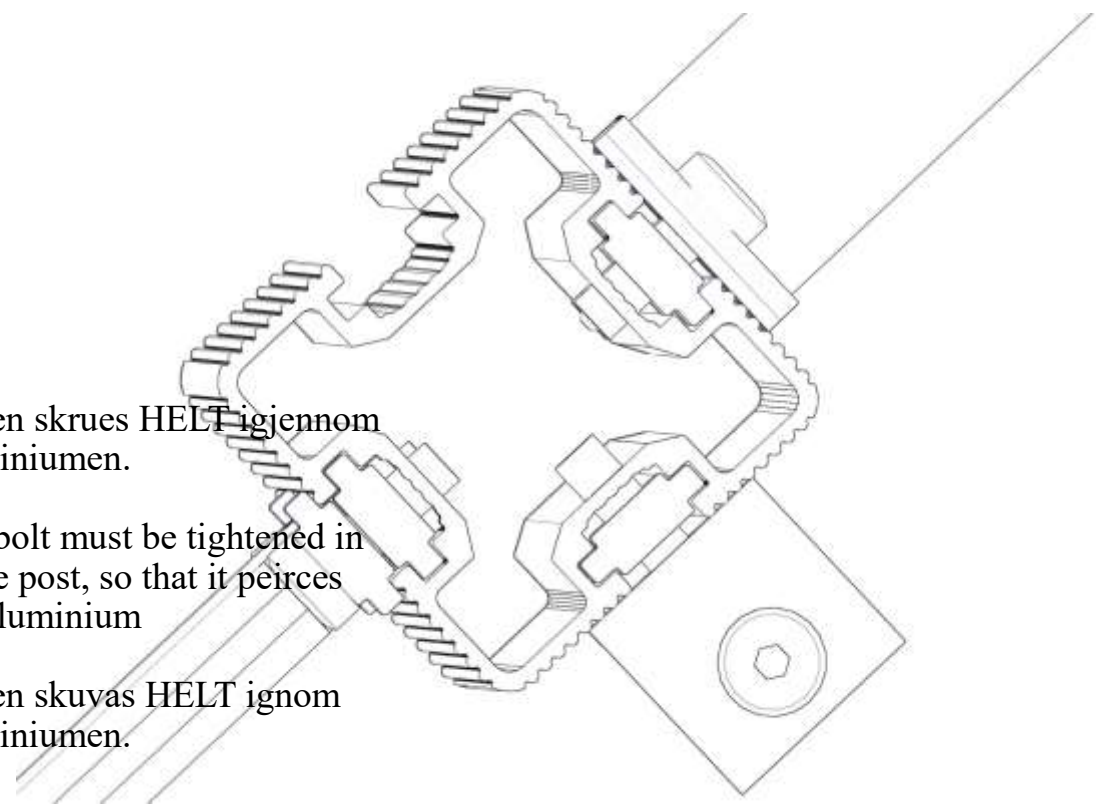
<p>(N) Bolten skrues HELT igjennom aluminiumen.</p> <p>(UK) The bolt must be tightened in to the post, so that it peirces the aluminium</p> <p>(S) Bulten skruvas HELT ignom aluminiumen.</p>	

Fallhøyder / Free height of fall / Fallhöjder

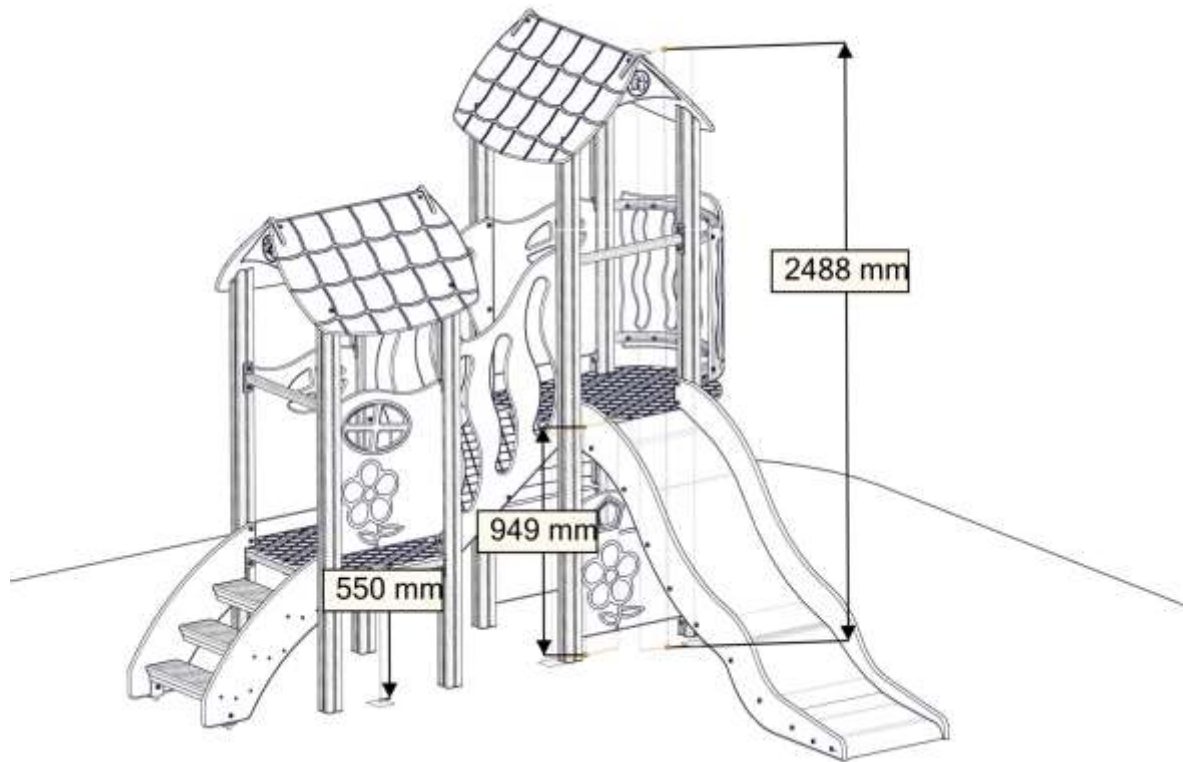

Sikkerhetszone / Safety zone / Säkerhetszon

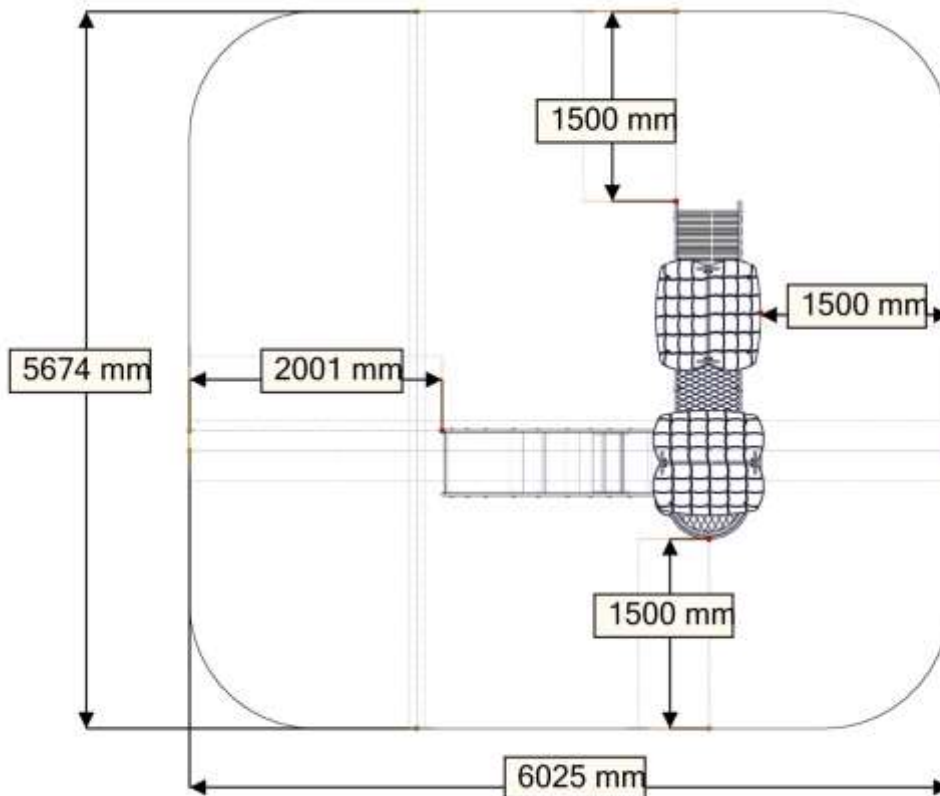

Plassering av forankringer / Ground plan / Placering av förankringar

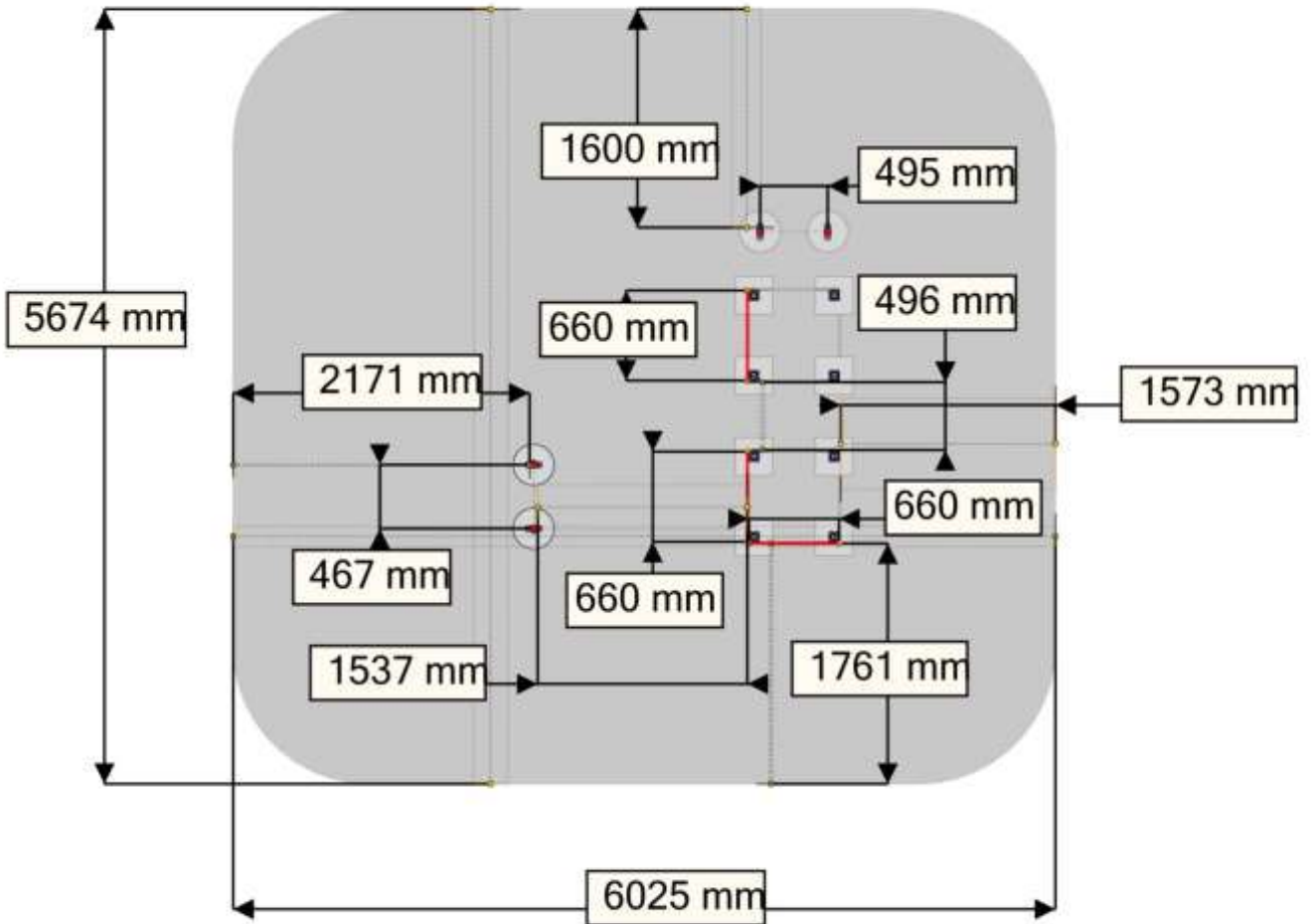

N

Alle mål er oppgitt i millimeter

UK

Scale measured in mm

S

Alla mått är i millimeter.

Montering av lekeapparatet / Assembly instructions / Montering av lekredskapet

Brikke påmontert hos Søve

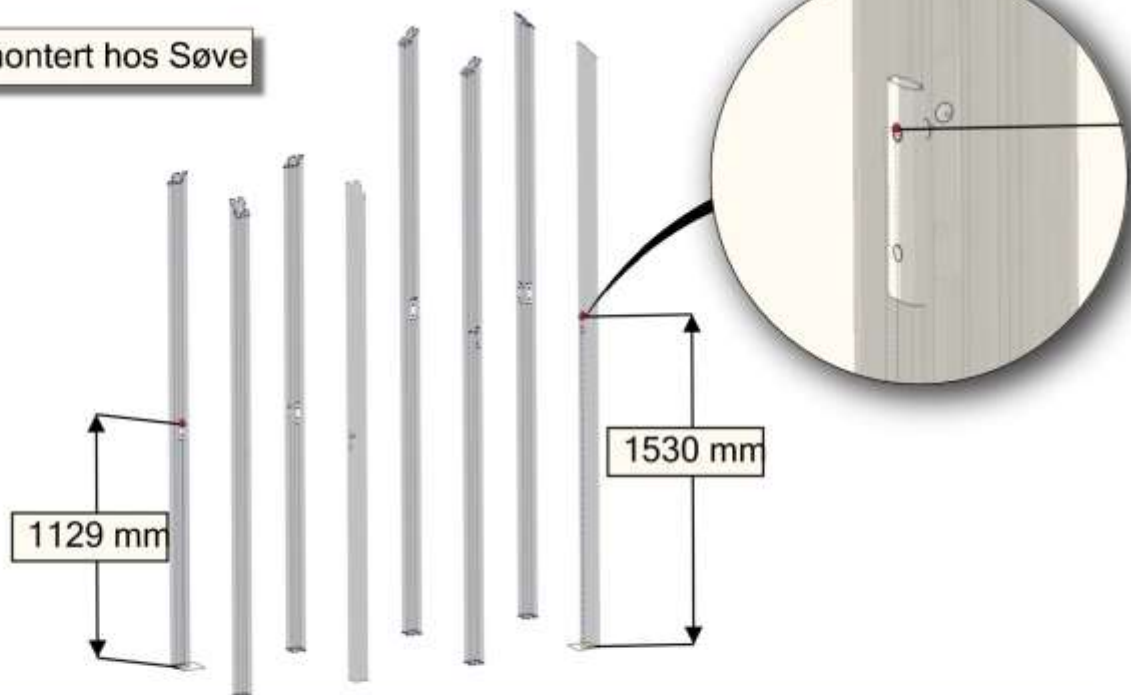

BOM ID	Name	SW Configuration	Artnr (config)	Qty
1	VK70_SFA5123_miniSkra-1	1700-600	07-510-156	4
2	VK70_SFA5123_miniSkra-1	2200-600	07-510-158	4

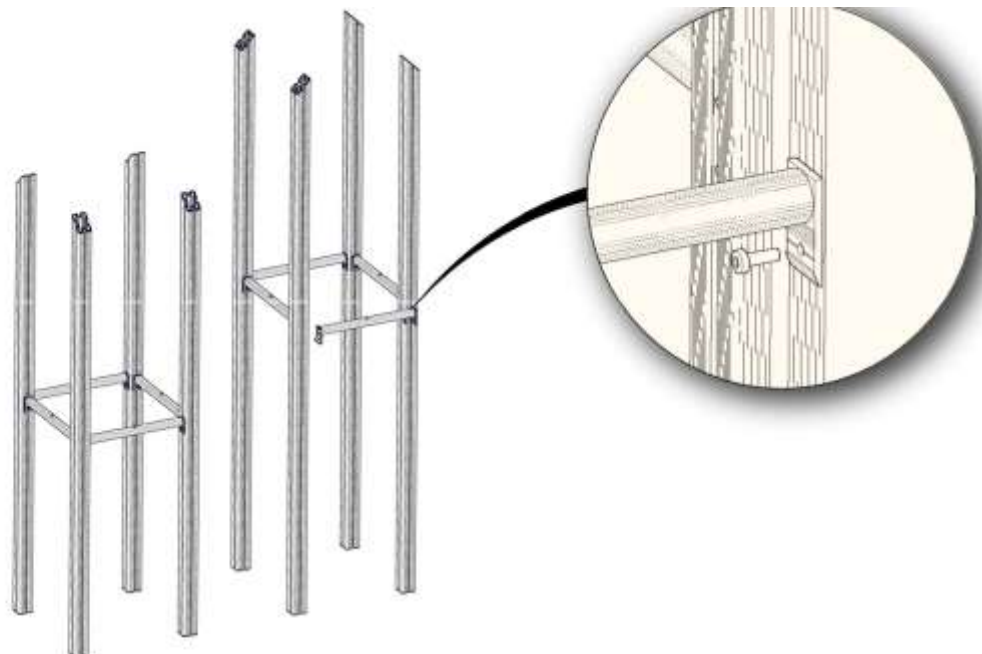

BOM ID	Name	SW Configuration	Artnr (config)	Qty
1	Torxm8-	TXM8x25	04-000-025	16
2	Sperror_MINI508-1	520_Gulv	07-510-161	8

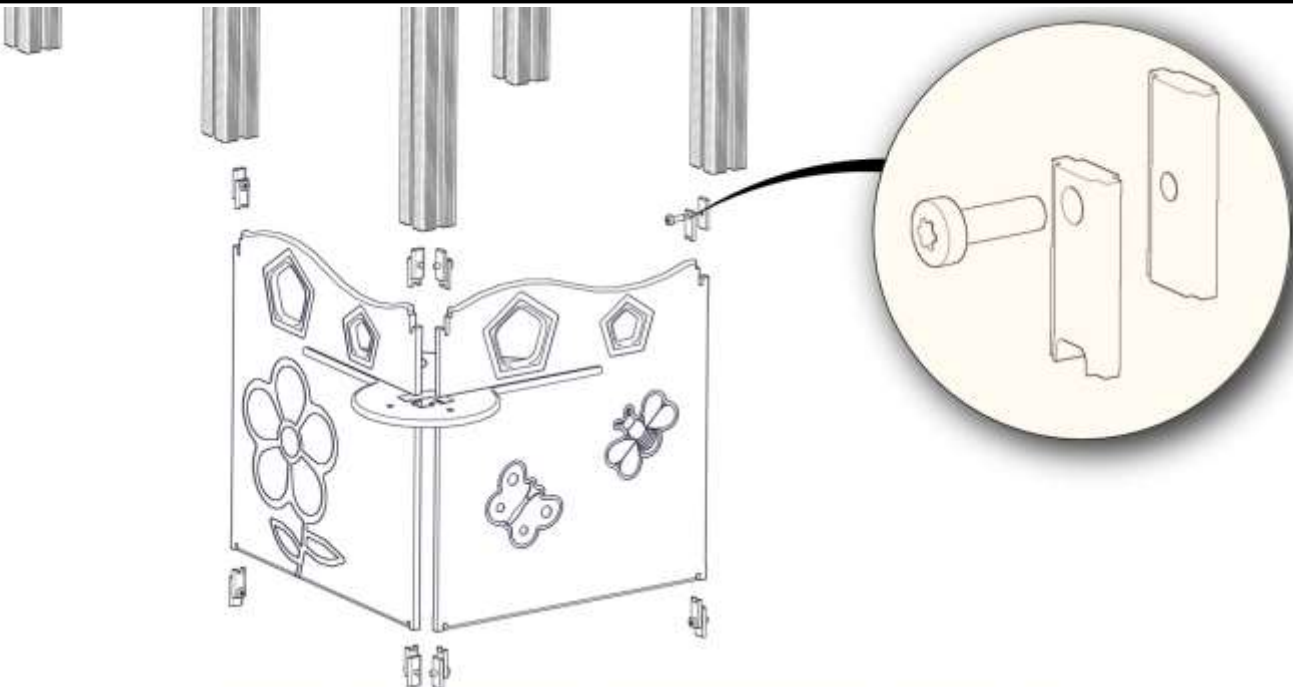
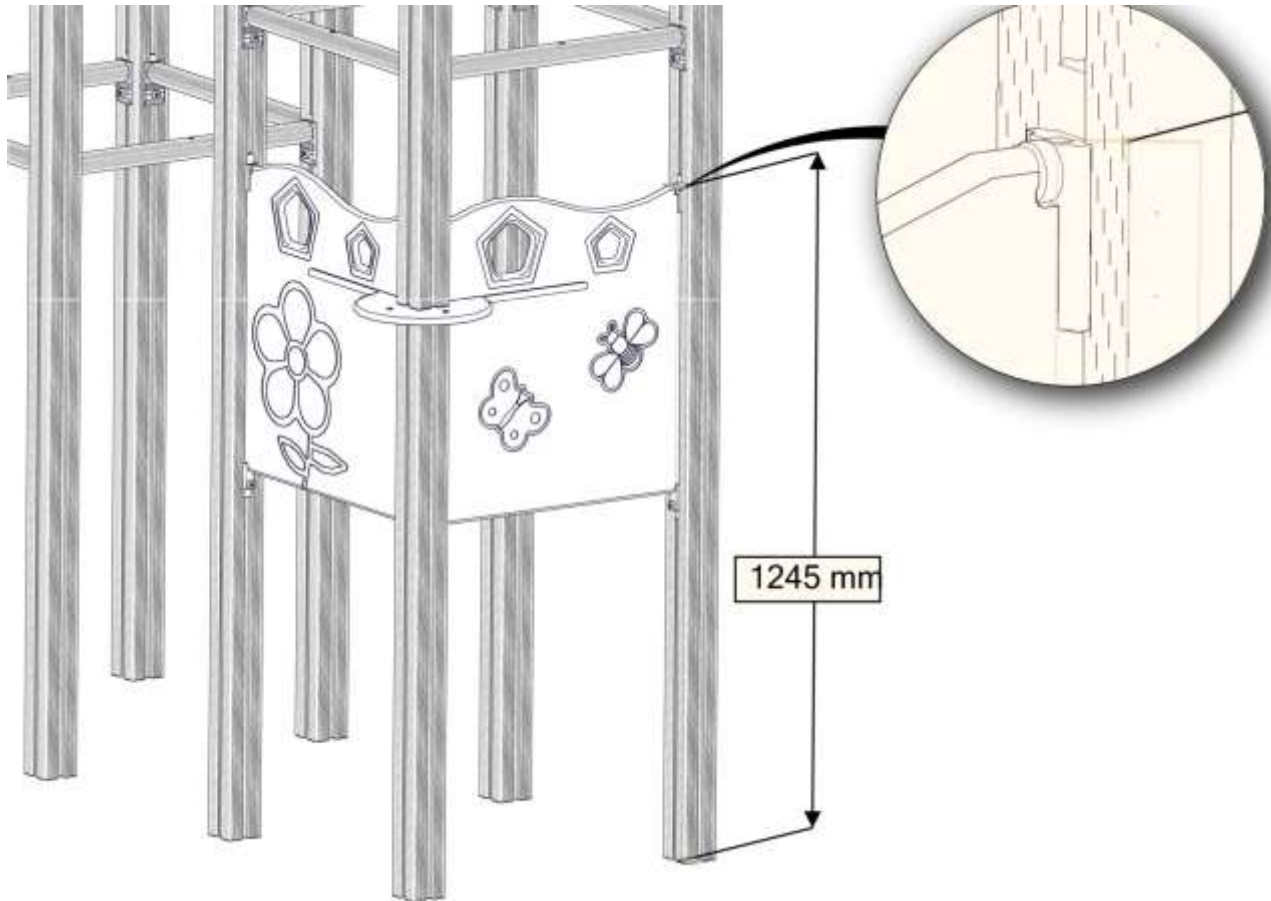

BOM ID	Name	SW Configuration	Artnr (config)	Qty
1	Torxm8-1	TXM8x25	04-000-025	8
2	brikke_SFA5116Special-1	12mm	04-060-041	8
3	brikke_SFA5116-1	50_1T	04-060-050	8
4	VeggMini520x520-1	Rvindow_sporHoy	07-510-123	1
5	VeggMini520x520-1	Rvindo_sporhoy_venstre	07-510-124	1
6	KokeRundStolpe-1	Default	07-510-136	1

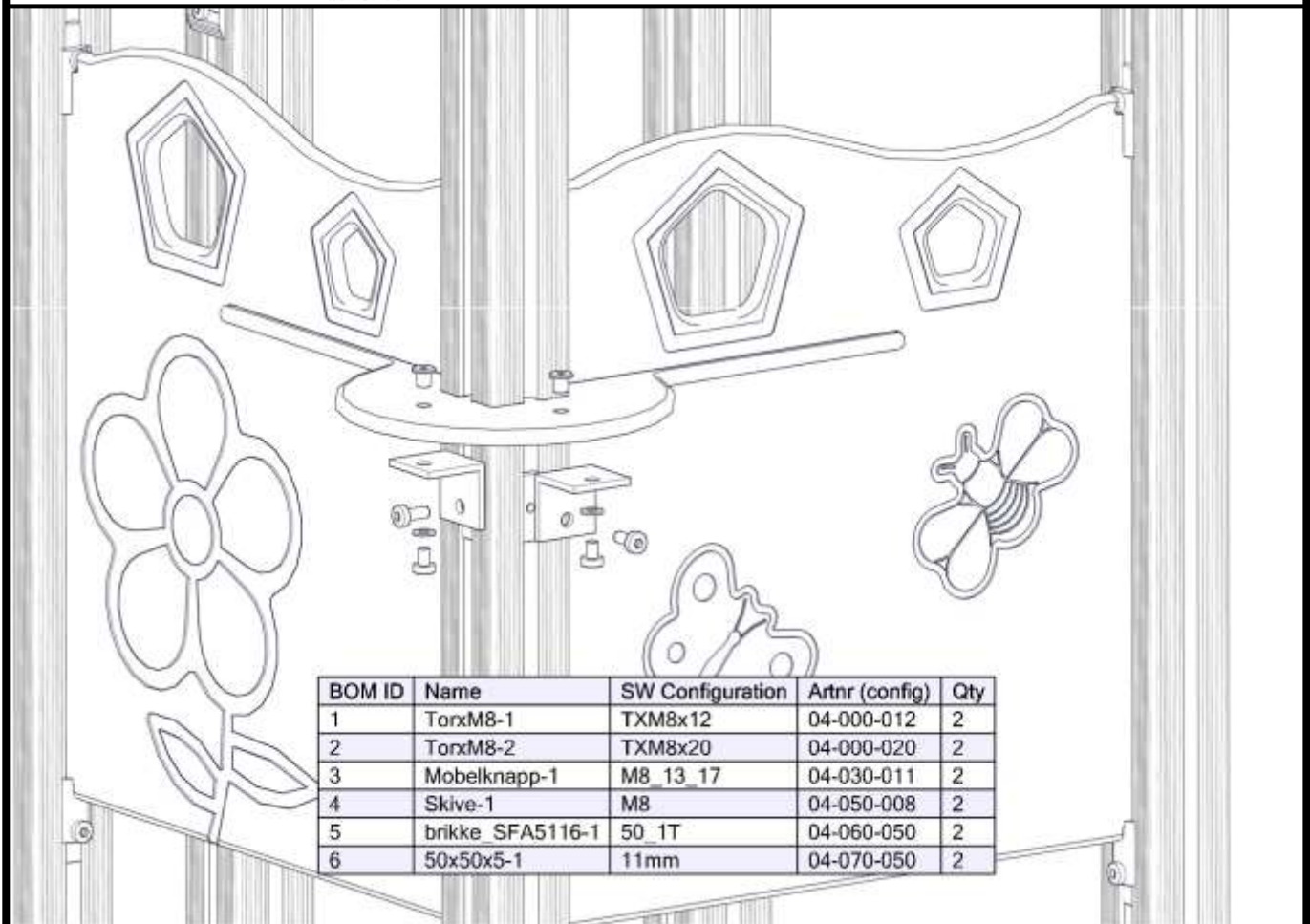
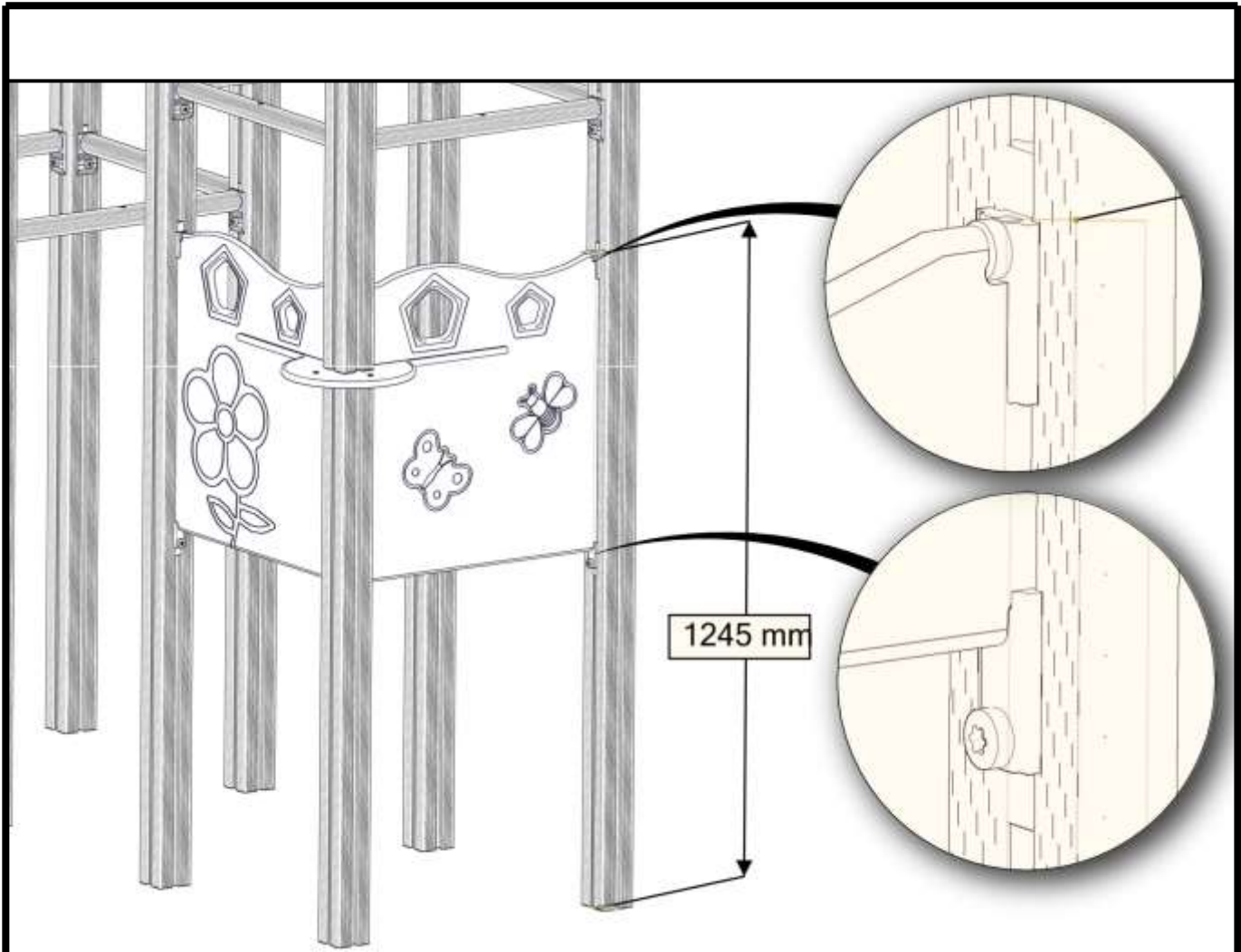

BOM ID	Name	SW Configuration	Artnr (config)	Qty
1	TorxM8-1	TXM8x12	04-000-012	2
2	TorxM8-2	TXM8x20	04-000-020	2
3	Mobelknapp-1	M8_13_17	04-030-011	2
4	Skive-1	M8	04-050-008	2
5	brikke SFA5116-1	50_1T	04-060-050	2
6	50x50x5-1	11mm	04-070-050	2

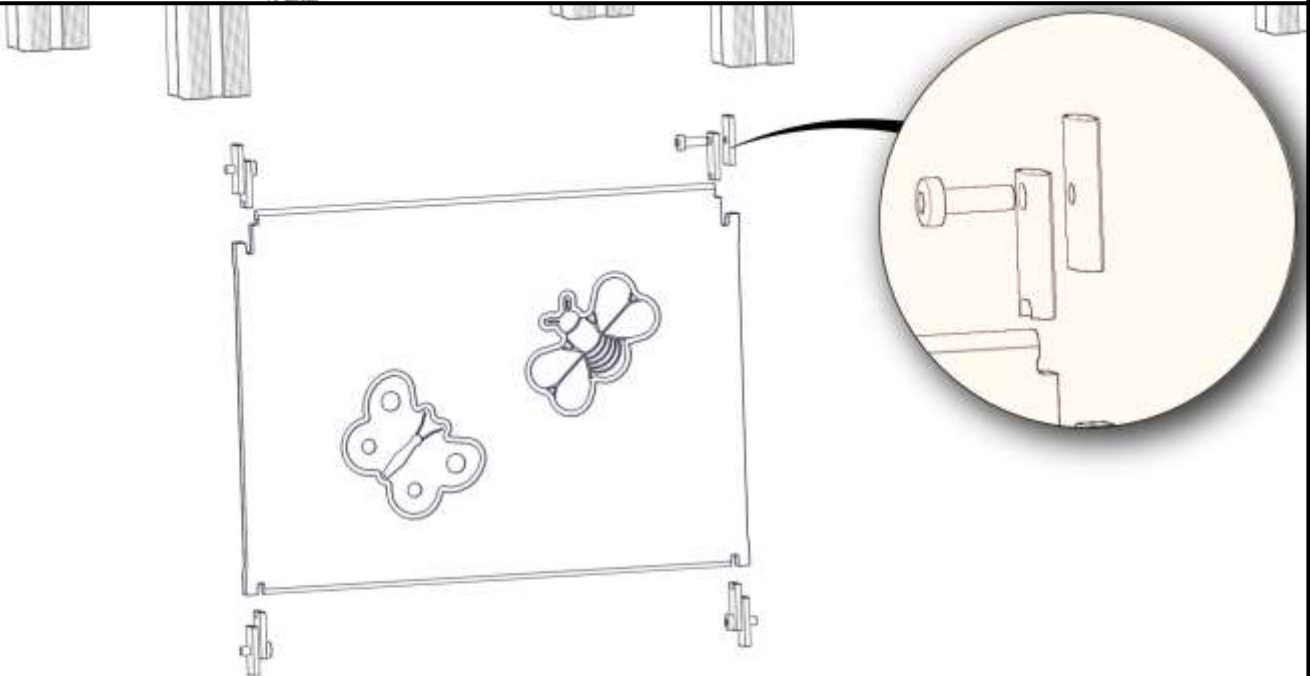
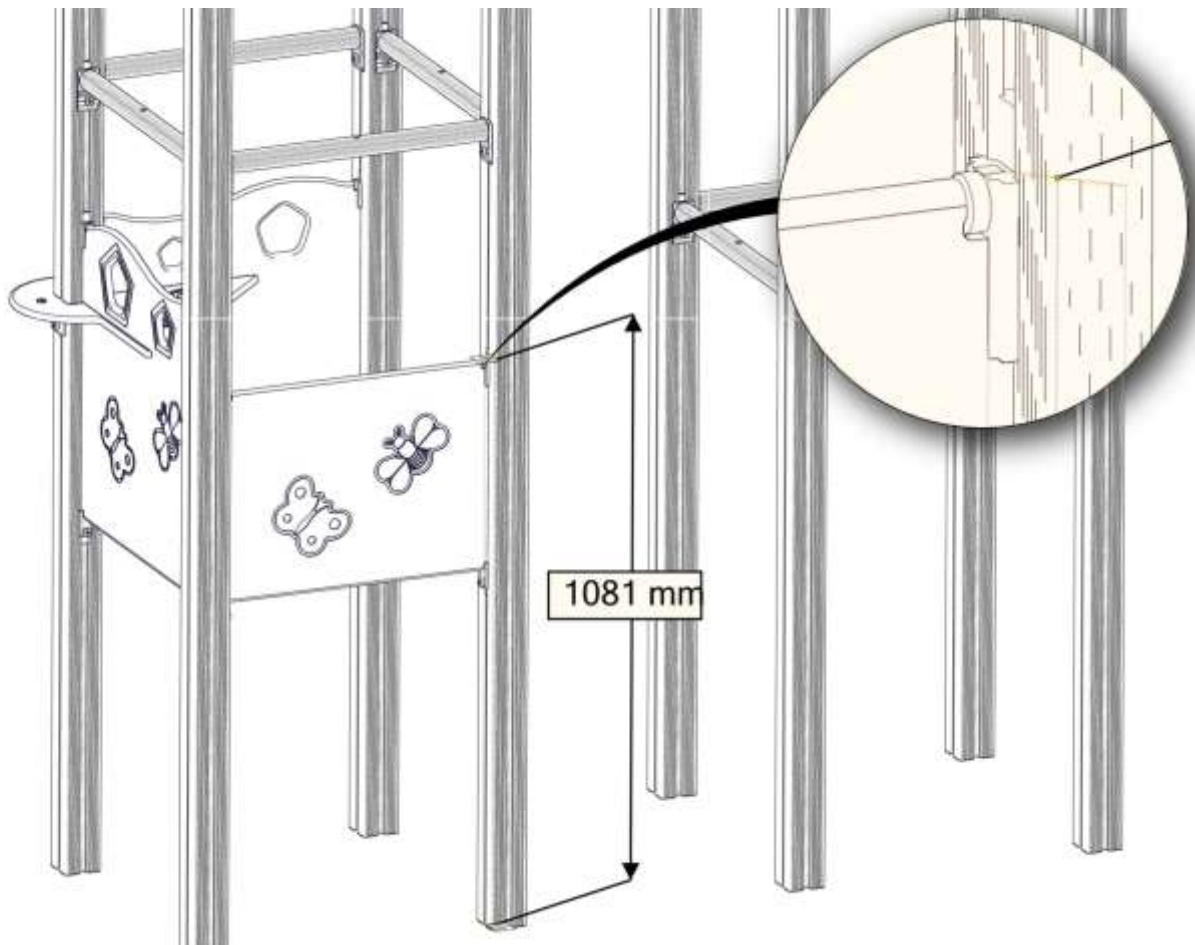

BOM ID	Name	SW Configuration	Artnr (config)	Qty
5	TorxM8-1	TXM8x25	04-000-025	4
6	brikke_SFA5116Special-1	12mm	04-060-041	4
7	brikke_SFA5116-1	50_1T	04-060-050	4
8	VeggMini520x400-1	STD	07-510-110	1

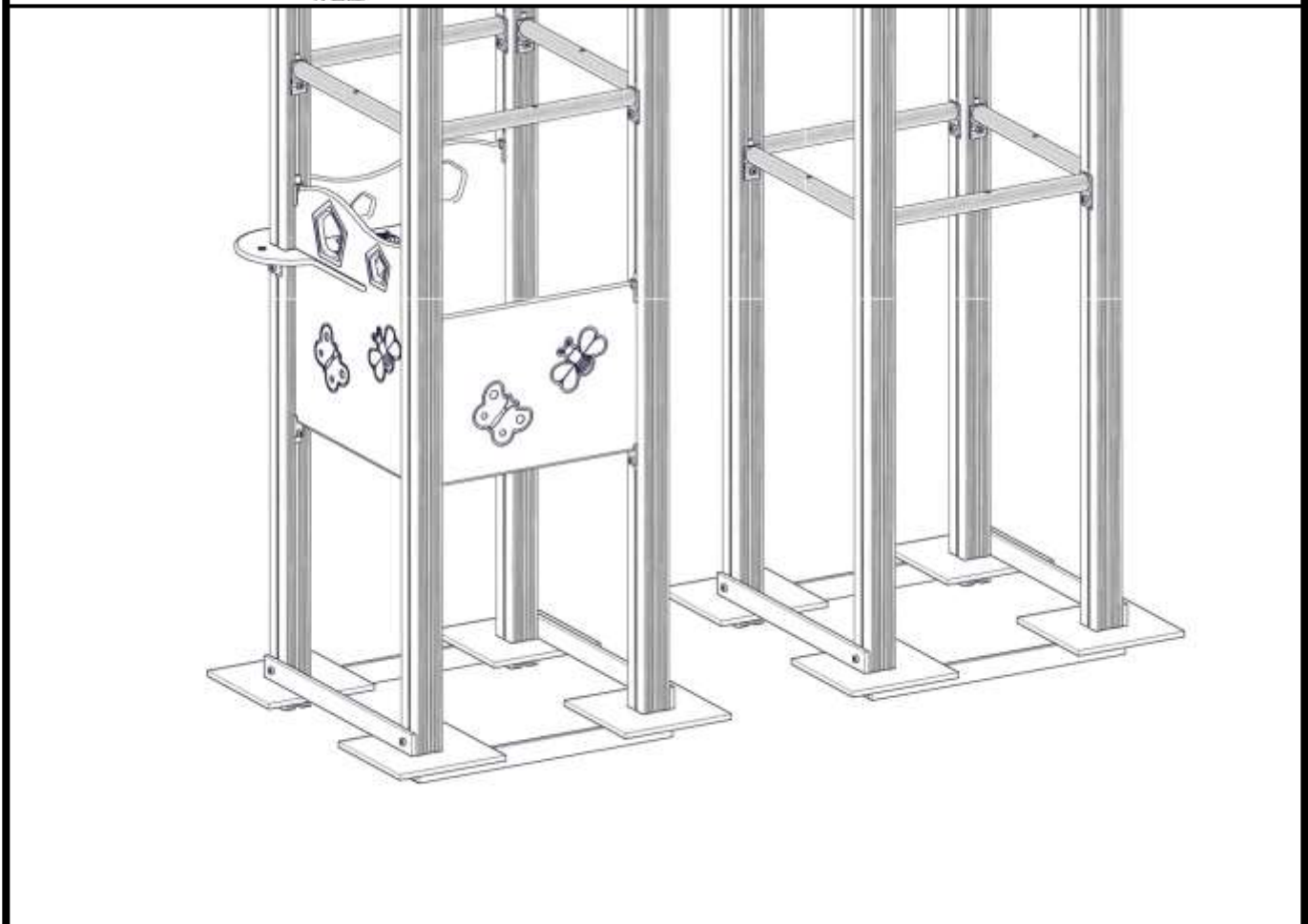
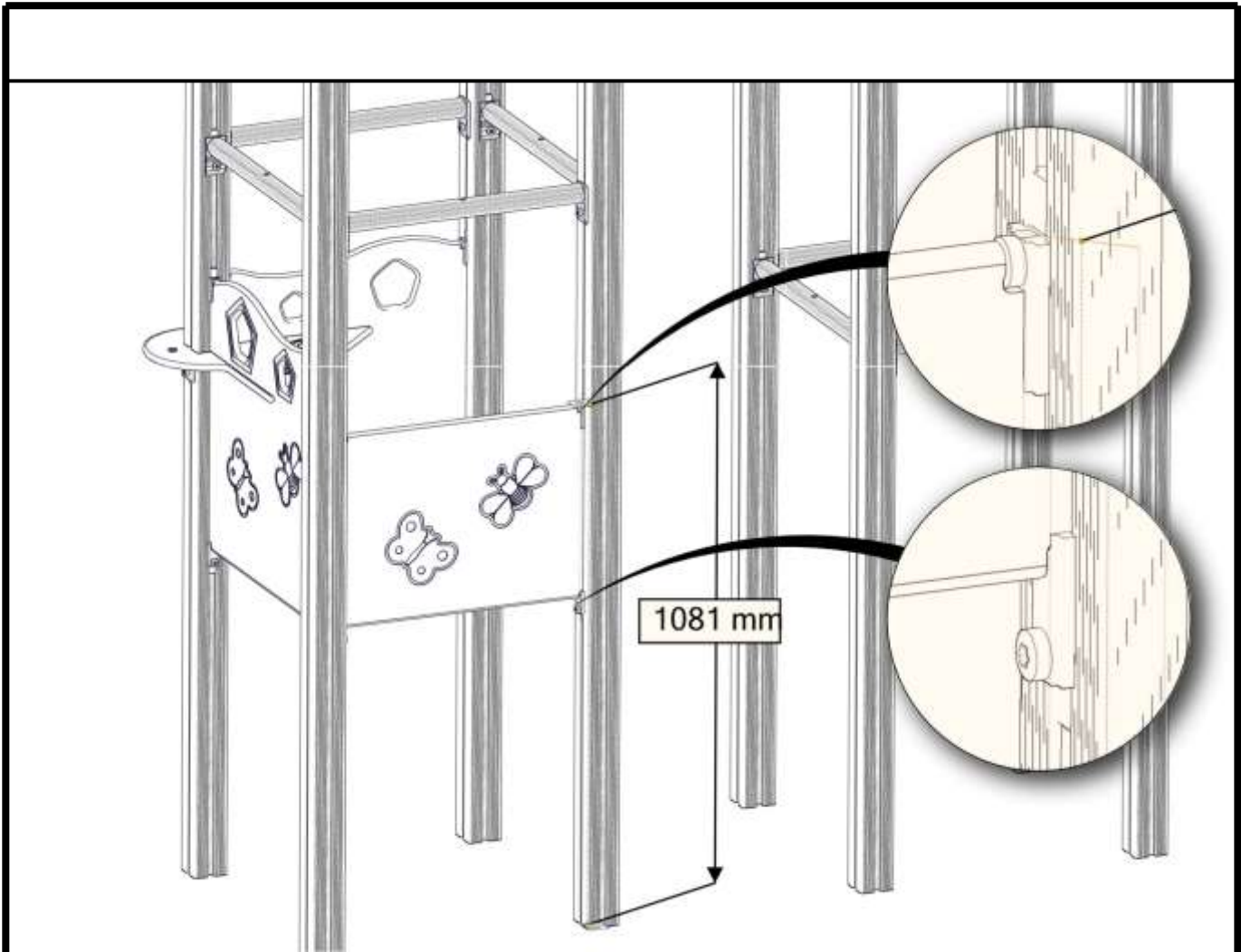

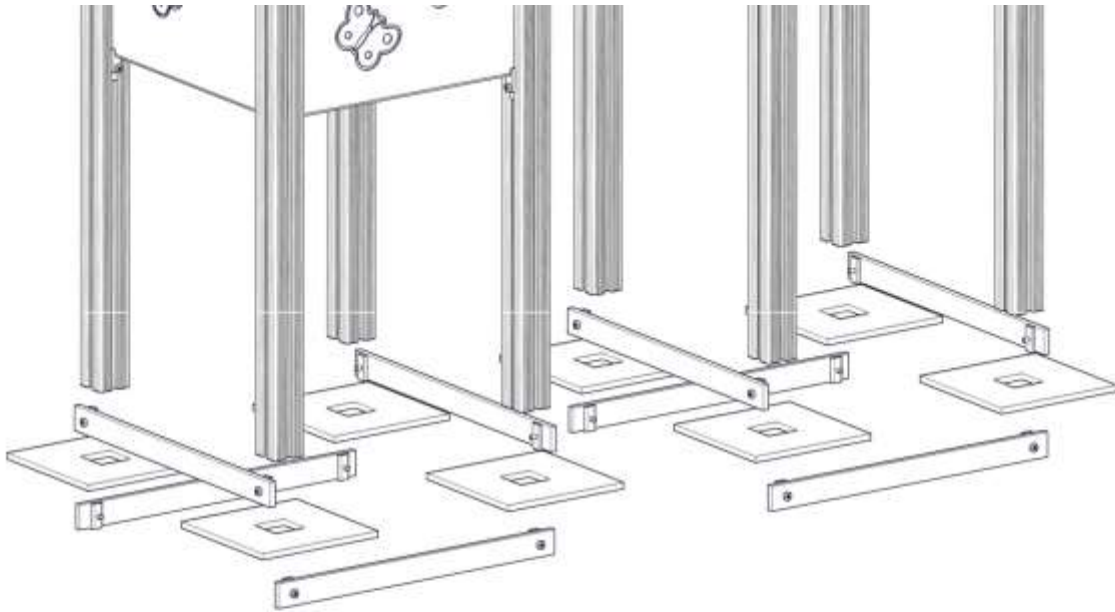

BOM ID	Name	SW Configuration	Artnr (config)	Qty
1	Torxm8-	TXM8x35	04-000-035	16
2	brikke_SFA5116-	50_1T	04-060-050	16
3	minifun_sprosse-1	660	07-510-200	8
4	minifunSkive-	Default	07-510-201	8



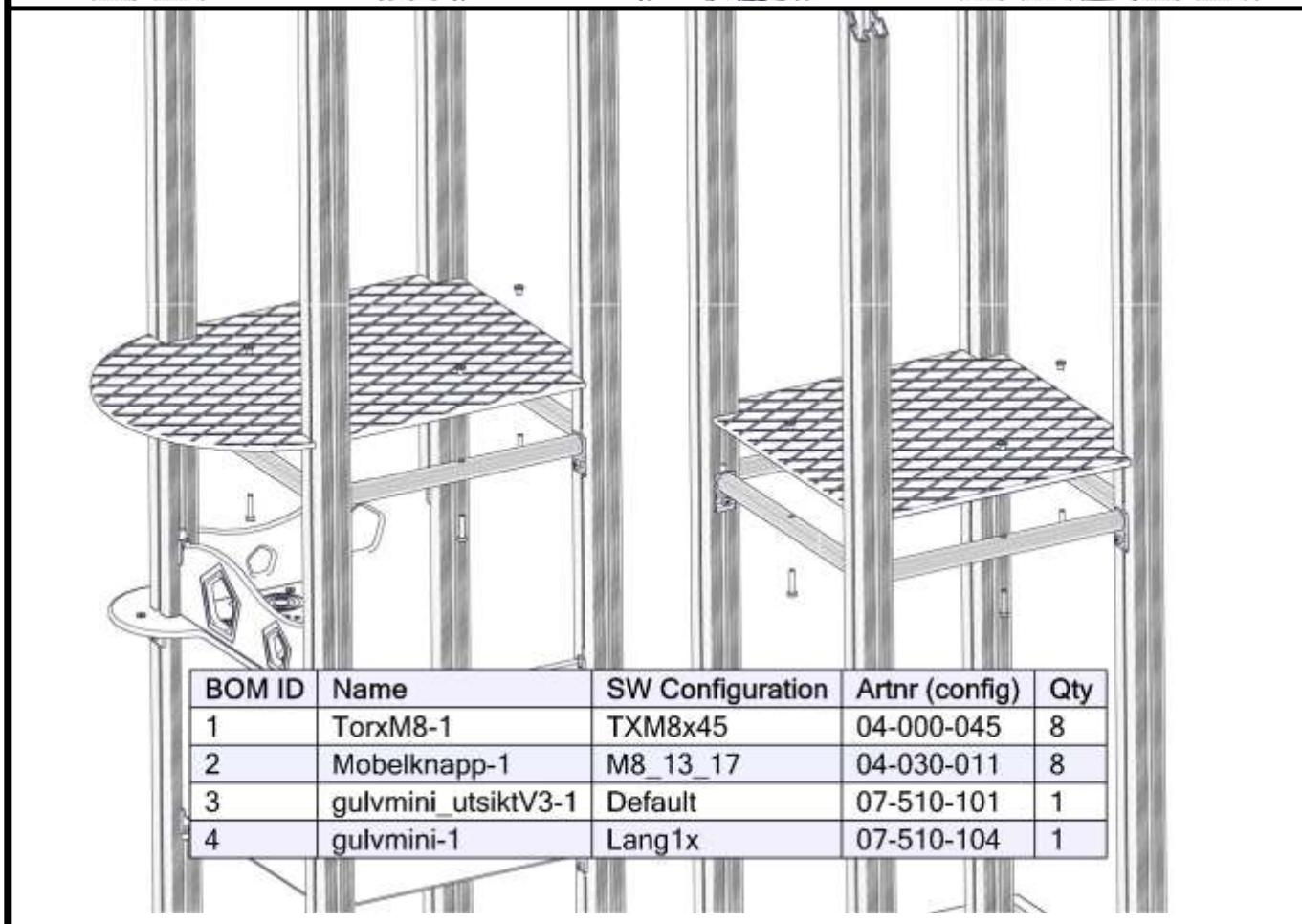
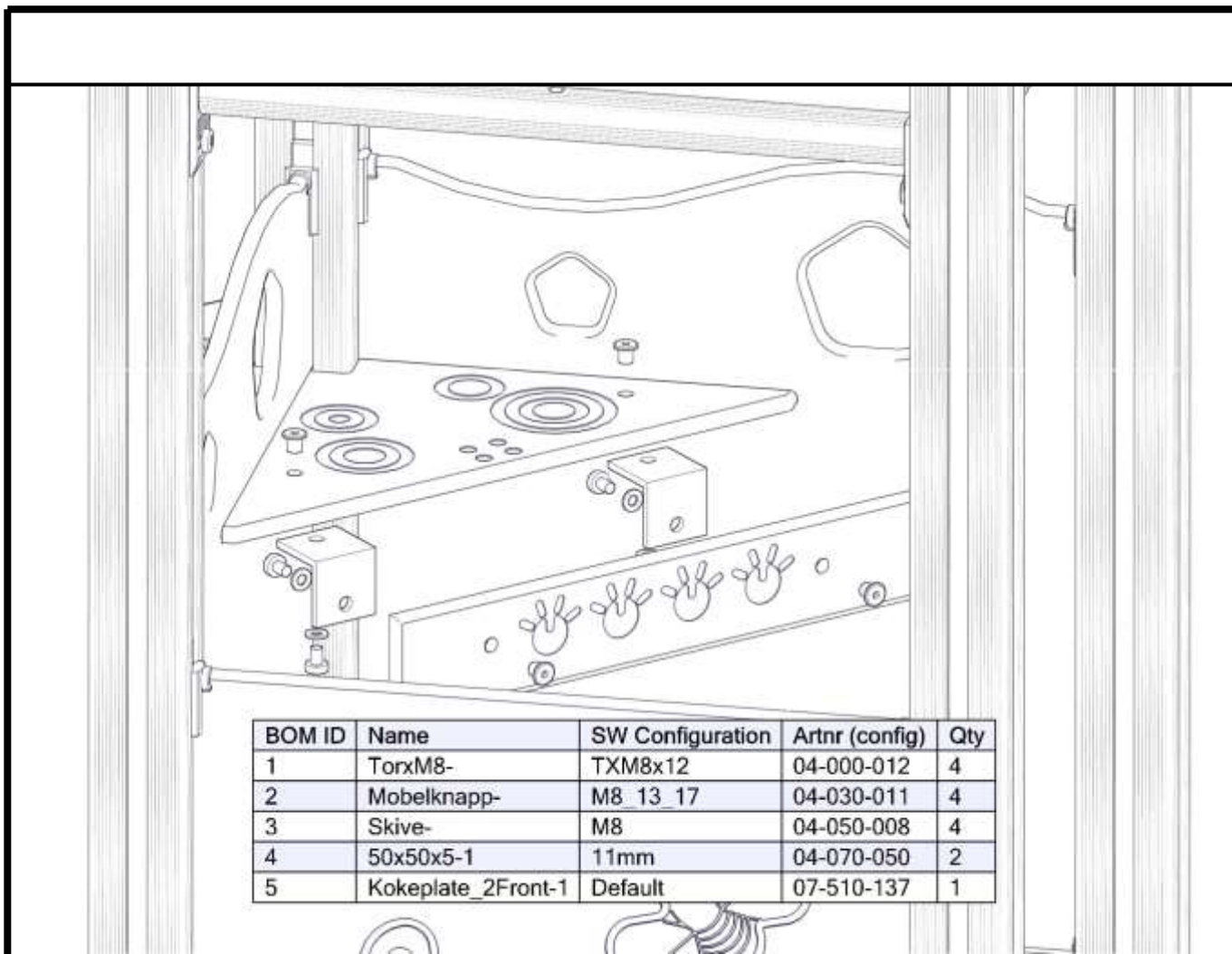

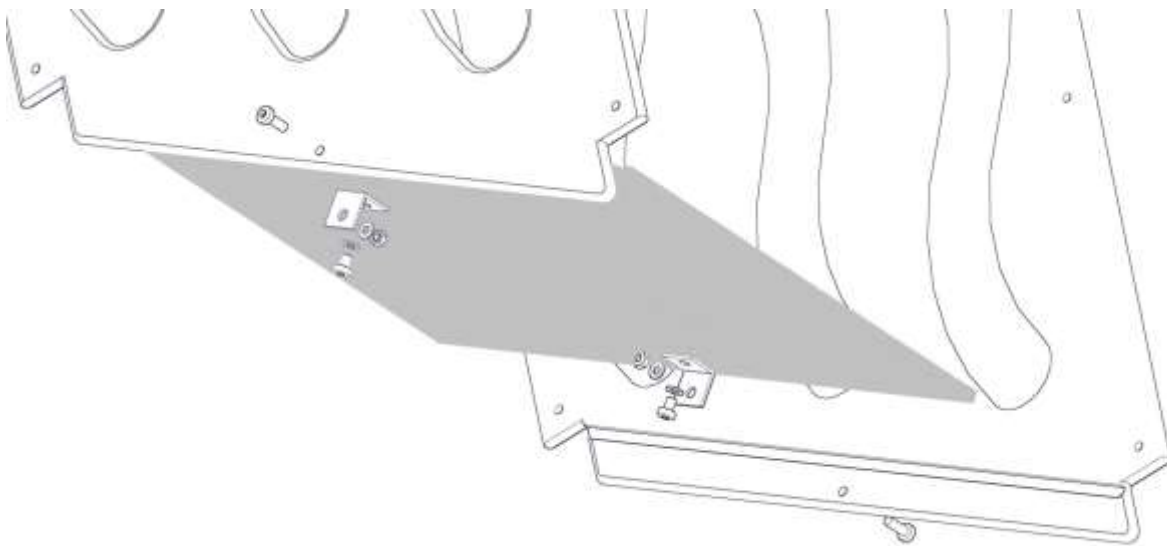
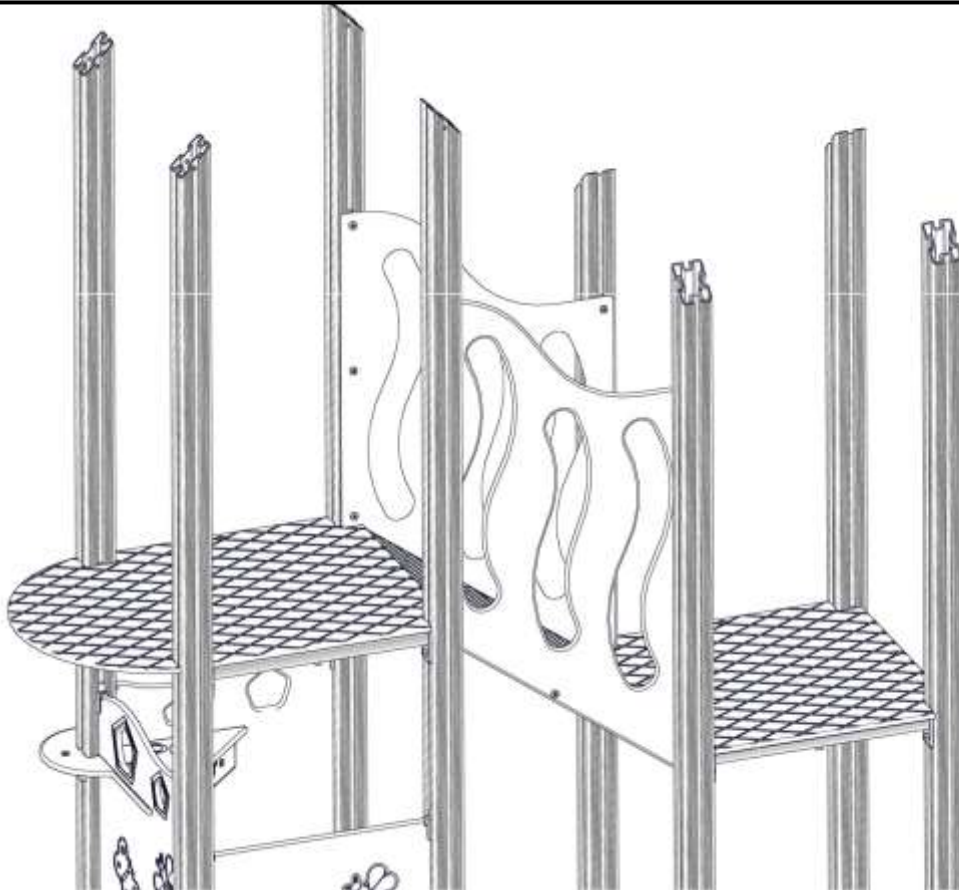

BOM ID	Name	SW Configuration	Artnr (config)	Qty
1	Torxm8-	TXM8x12	04-000-012	2
2	Torxm8-	TXM8x25	04-000-025	2
3	Mobelknapp-	M8_13_17	04-030-011	2
4	mutter M8-	M8_Borg	04-040-008	2
5	Skive-	M8	04-050-008	4
6	35x35x3-	11mm	04-070-036	2
7	Rekkverk_skraplate-1	Default	07-510-321	1
8	Rekkverk_skraplate_mirror-1	Default	07-510-322	1
9	Skra_plato-1	Default	07-510-323	1

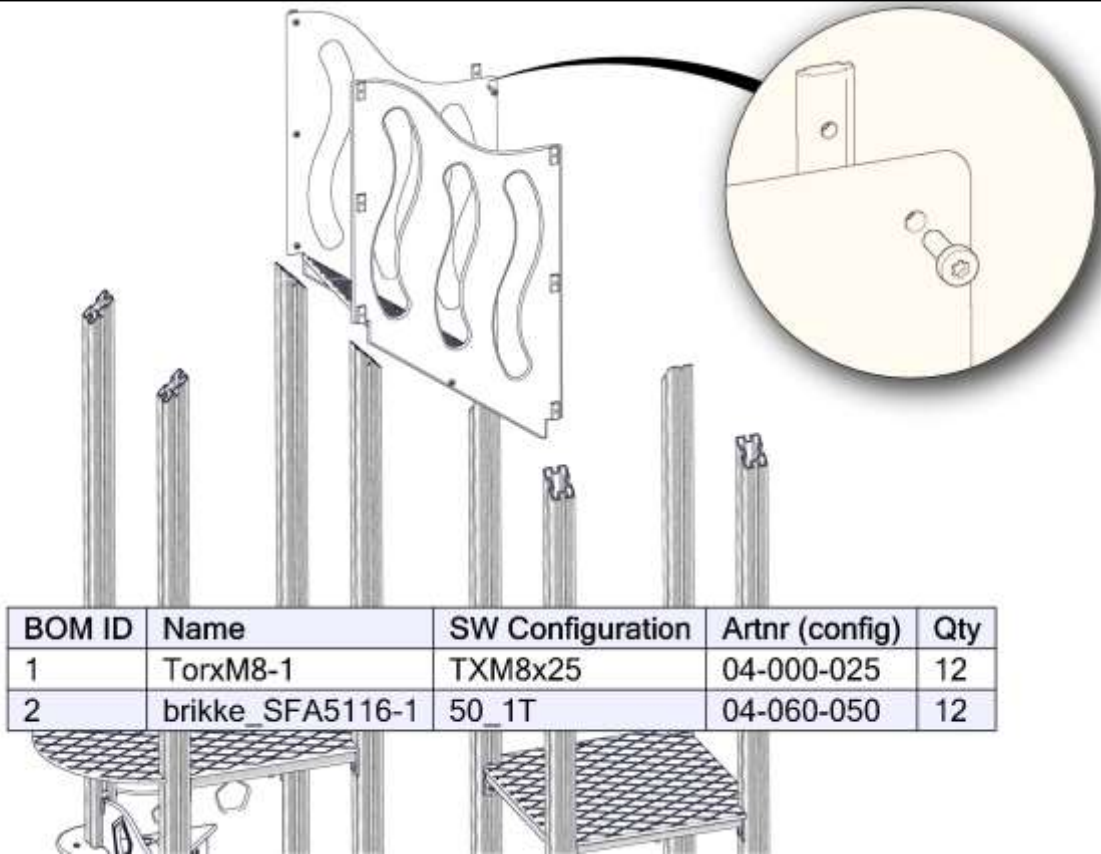

BOM ID	Name	SW Configuration	Artnr (config)	Qty
1	TorxM8-1	TXM8x25	04-000-025	12
2	brikke_SFA5116-1	50_1T	04-060-050	12

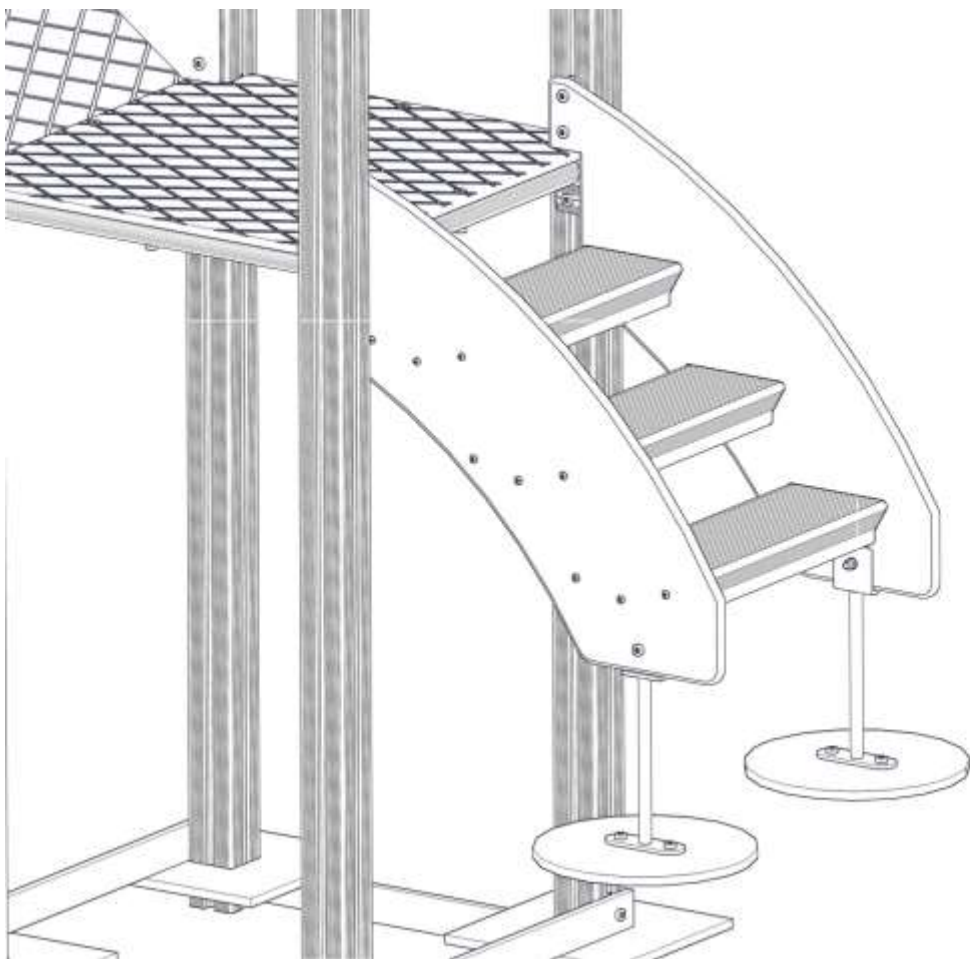

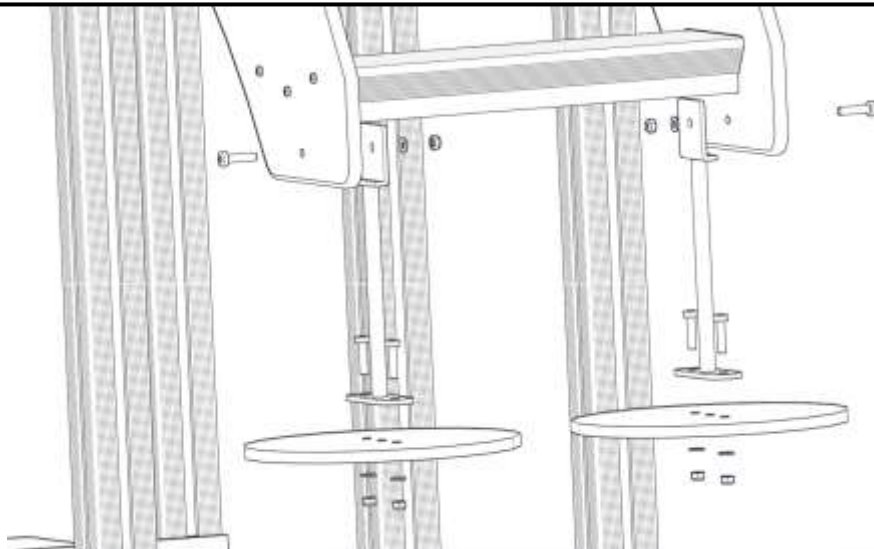

BOM ID	Name	SW Configuration	Artnr (config)	Qty
1	Fundament_platte_2H-1	Hoh80	00-003-106	2
2	Stalforankring-1	liten	00-100-312	2
3	TorxM8-	TXM8x35	04-000-035	6
4	mutter_M8-	M8_Borg	04-040-008	6
5	Skive-	M8	04-050-008	6

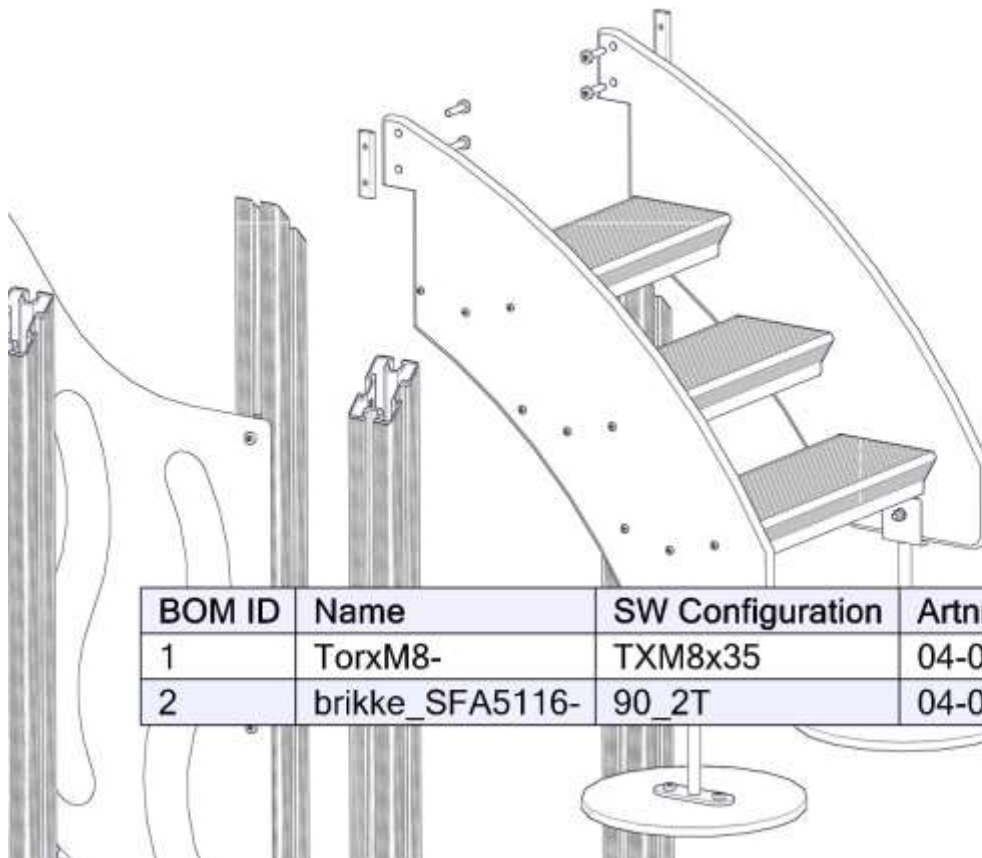

BOM ID	Name	SW Configuration	Artnr (config)	Qty
1	TorxM8-	TXM8x35	04-000-035	4
2	brikke_SFA5116-	90_2T	04-060-090	2

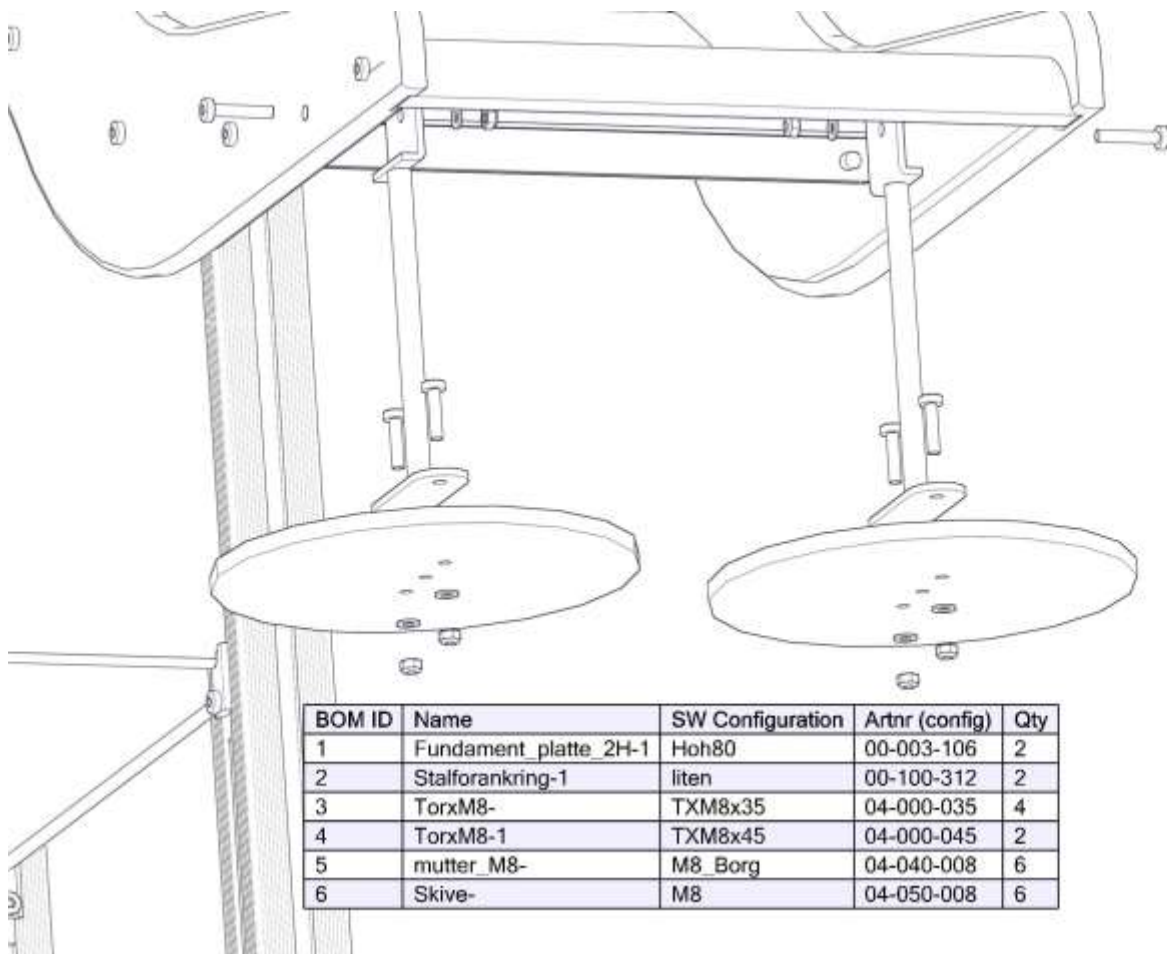
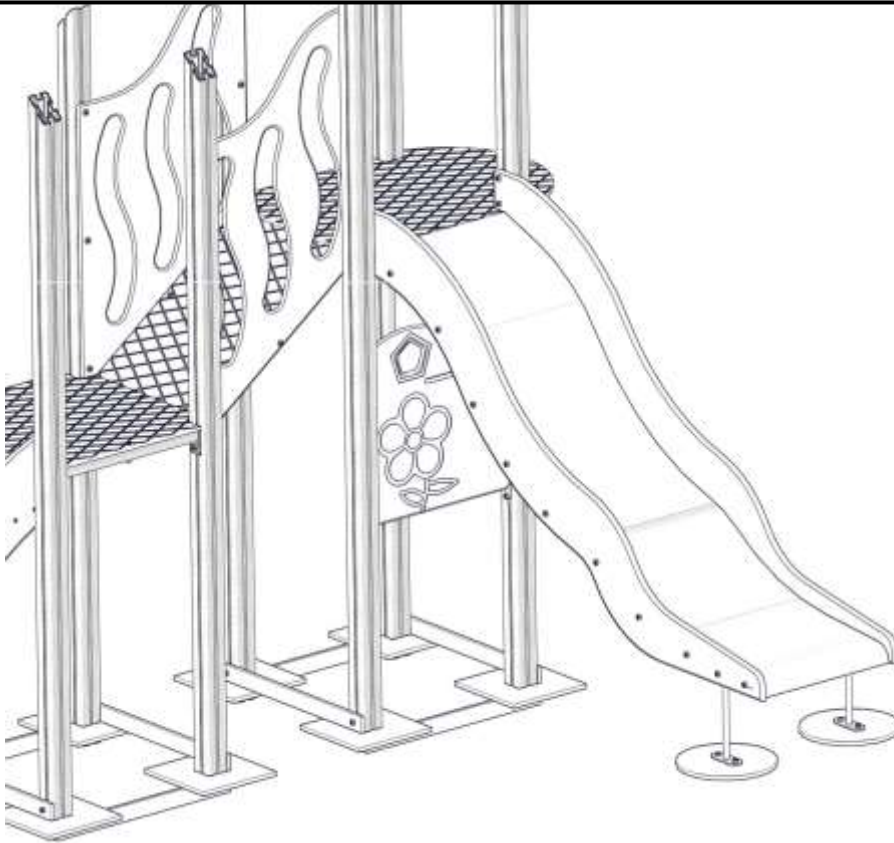



BOM ID	Name	SW Configuration	Artnr (config)	Qty
1	TorxM8-	TXM8x35	04-000-035	4
2	brikke_SFA5116-	120_3T	04-060-120	2

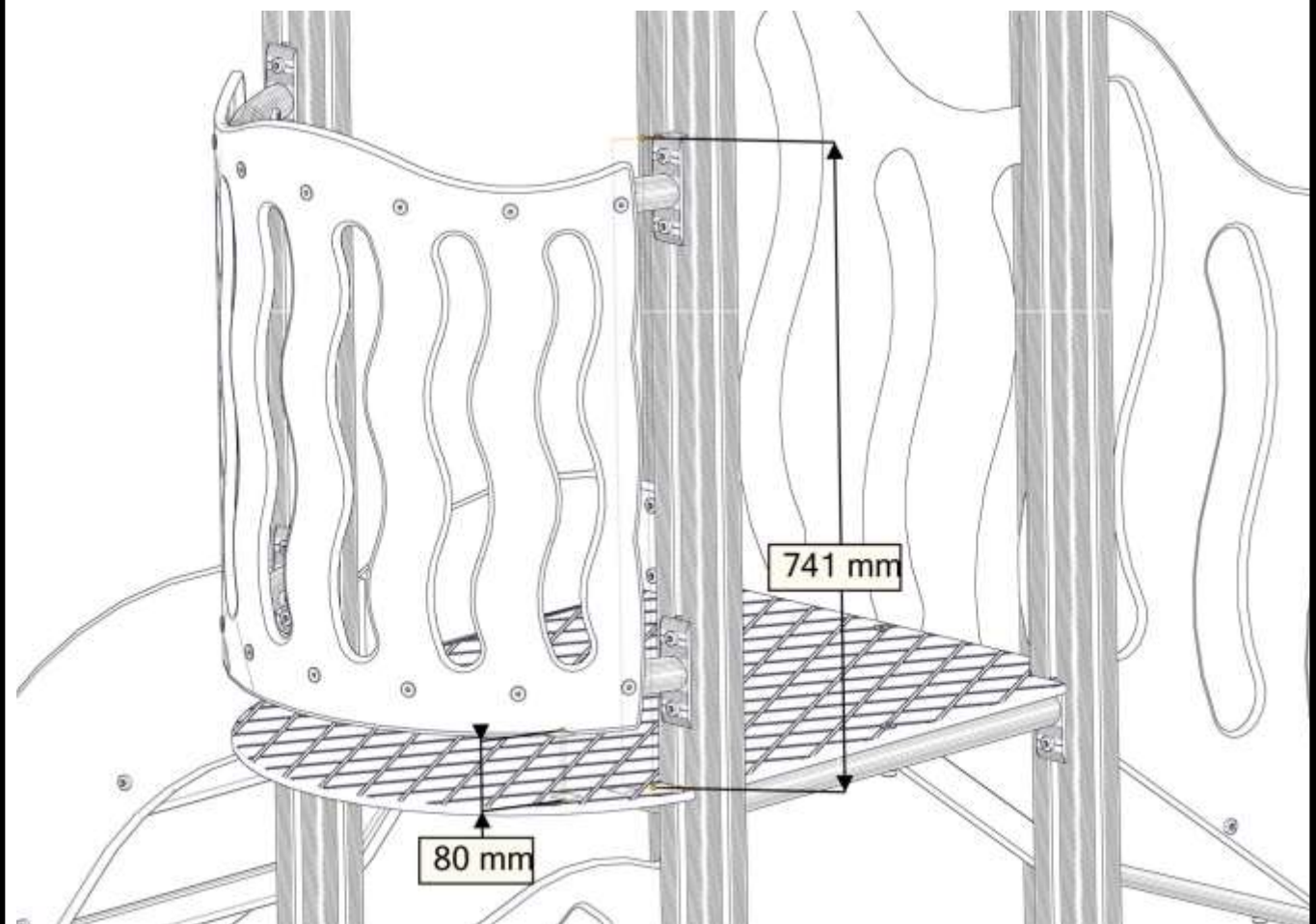

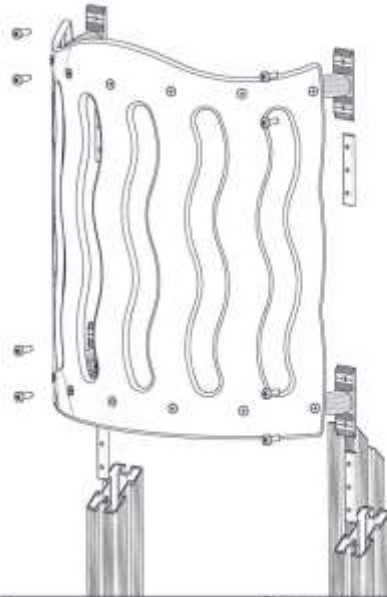

BOM ID	Name	SW Configuration	Artnr (config)	Qty
1	TorxM8-	TXM8x25	04-000-025	8
2	brikke_SFA5116-1	120_3T	04-060-120	4
3	HDPE_Utsikt_V3-1	Default	07-510-134	1

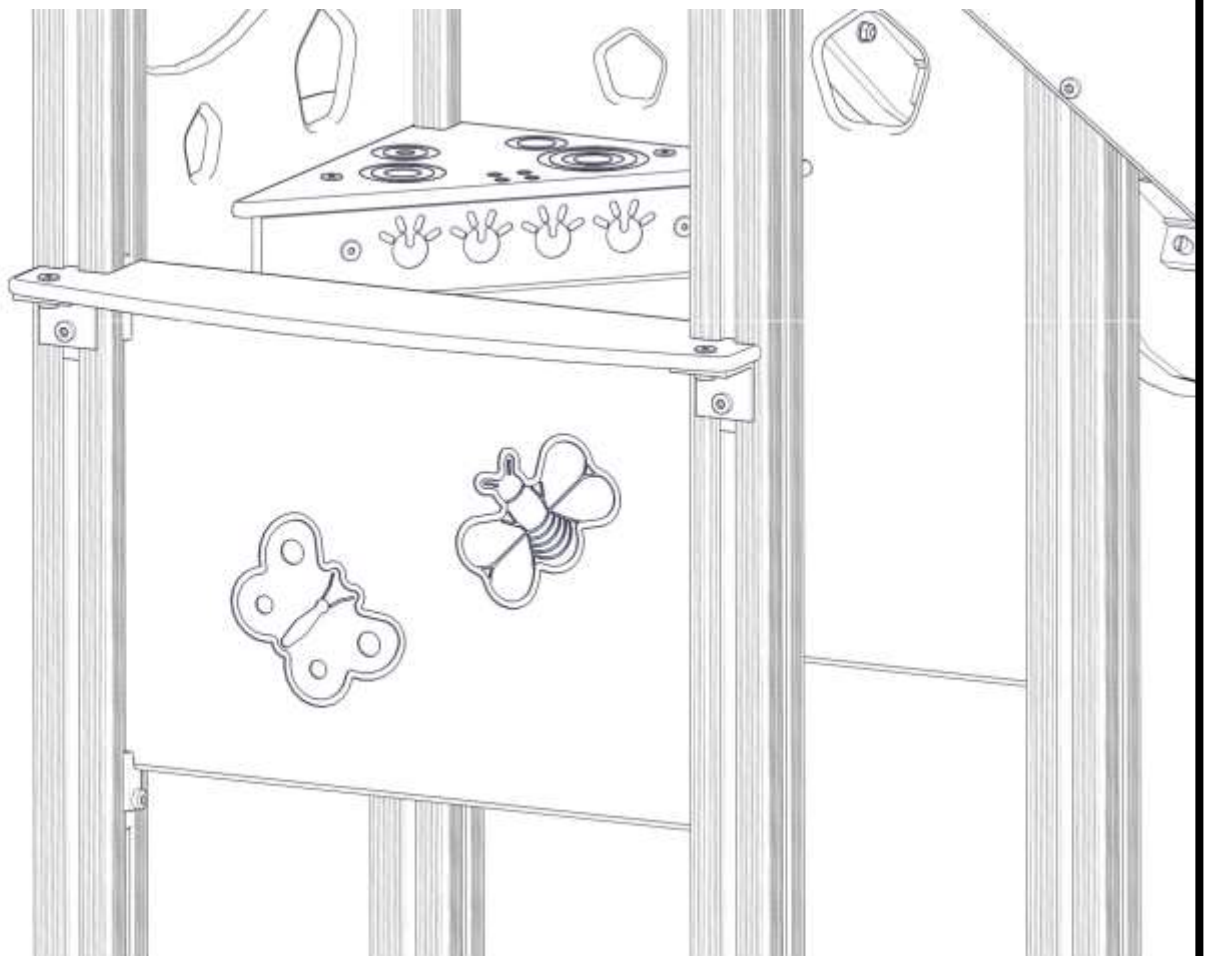

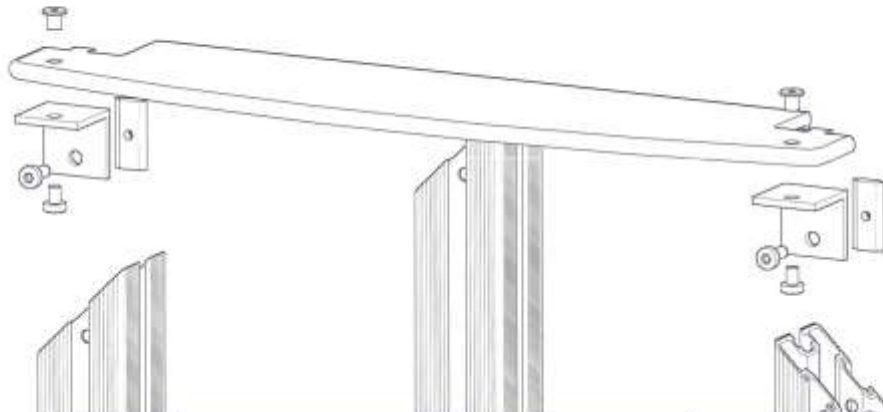

BOM ID	Name	SW Configuration	Artnr (config)	Qty
1	TorxM8-1	TXM8x12	04-000-012	2
2	TorxM8-2	TXM8x20	04-000-020	2
3	Mobelknapp-1	M8_13_17	04-030-011	2
4	brikke_SFA5116-1	50_1T	04-060-050	2
5	50x50x5-1	11mm	04-070-050	2
6	Buttikdisk520-1	Default	07-510-130	1

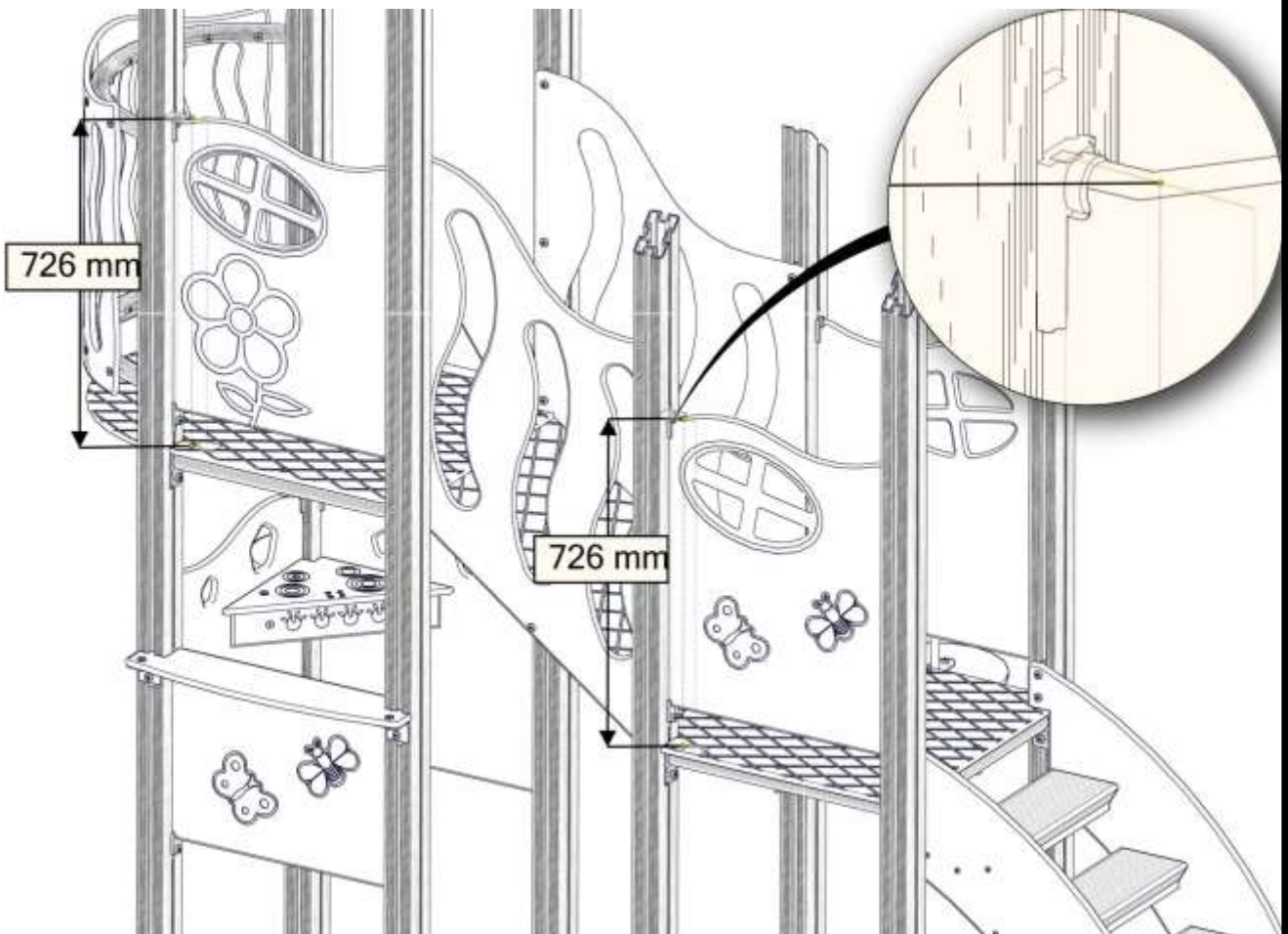

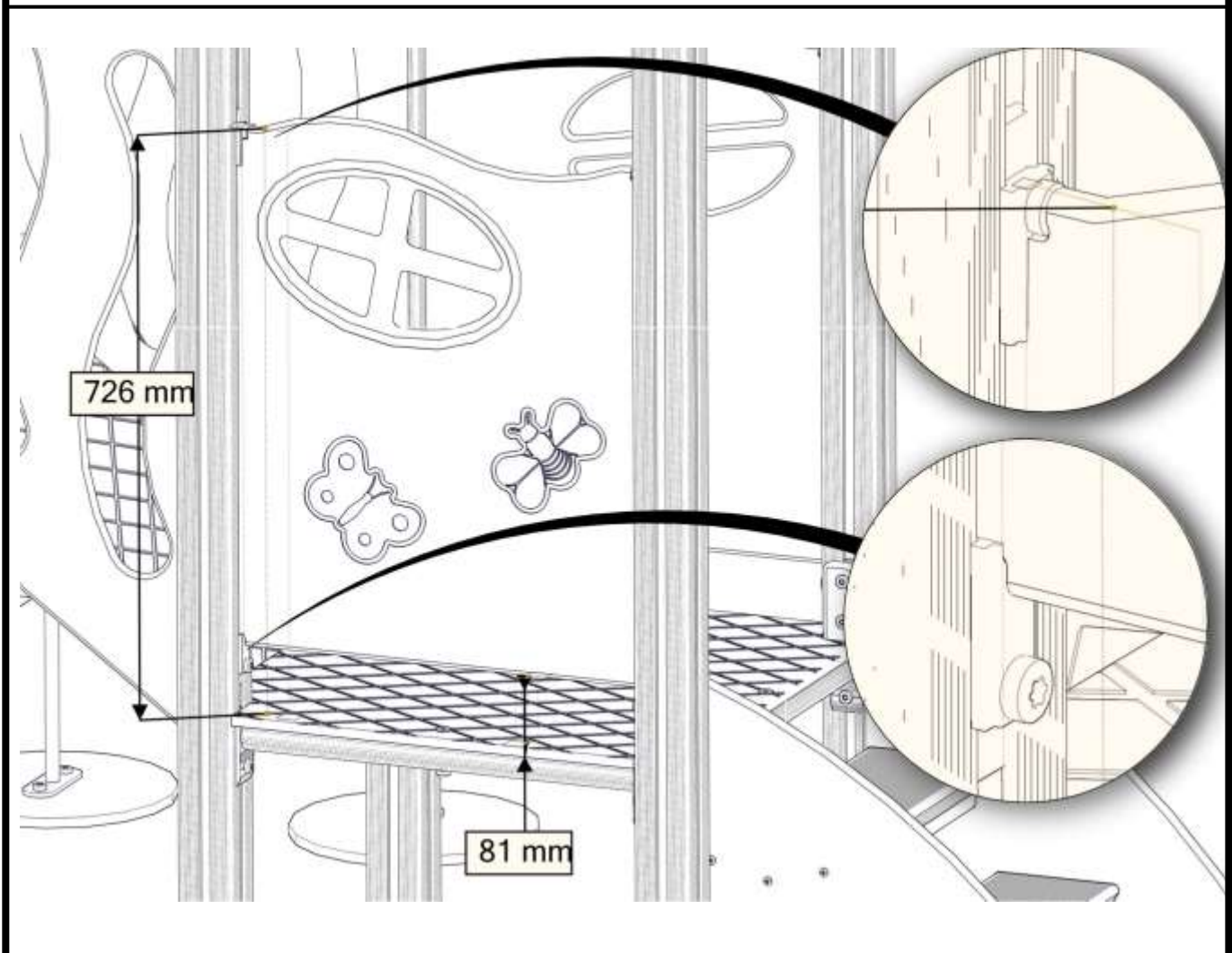
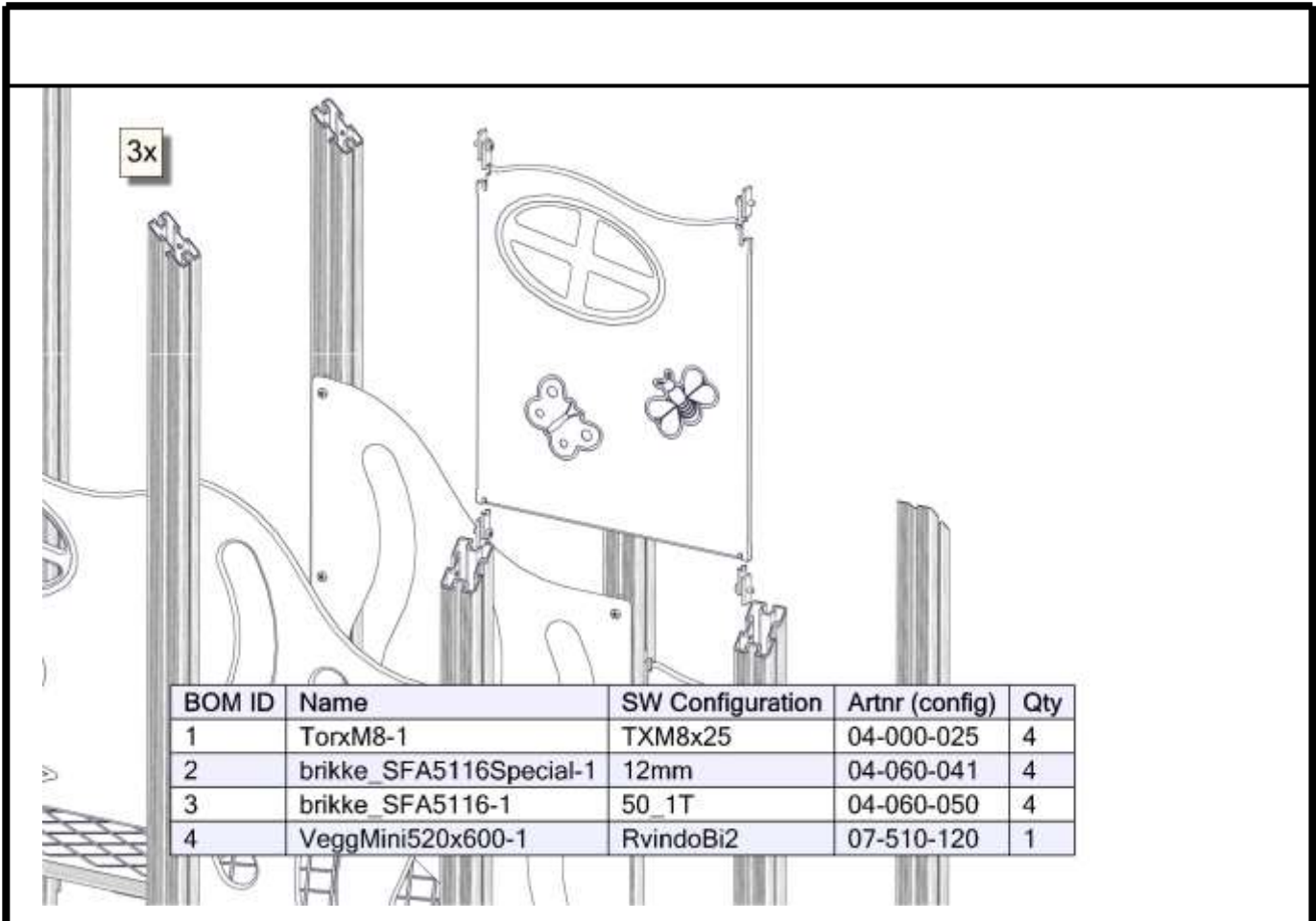

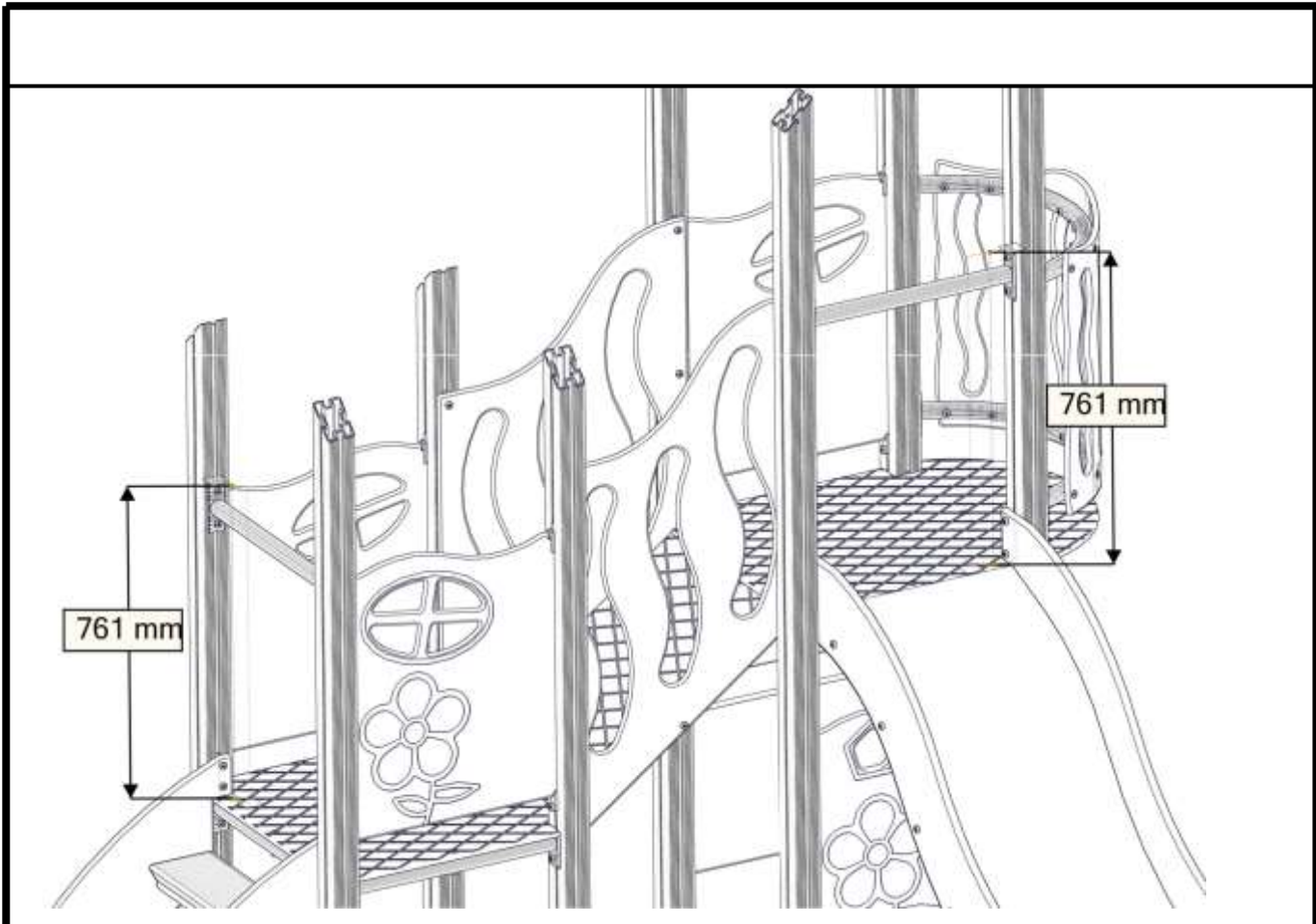

2x

An exploded view diagram of a horizontal beam assembly. The main component is a long horizontal beam. It is shown with two mounting brackets, one on each end. Each bracket has two holes for bolts. The diagram shows the beam being inserted into the brackets. A small '2x' label is in the top left corner.

BOM ID	Name	SW Configuration	Artnr (config)	Qty
1	Torxm8-	TXM8x25	04-000-025	4
2	brikke_SFA5116-	120_3T	04-060-120	2
3	Sperror_MINI508-1	520	07-510-160	1

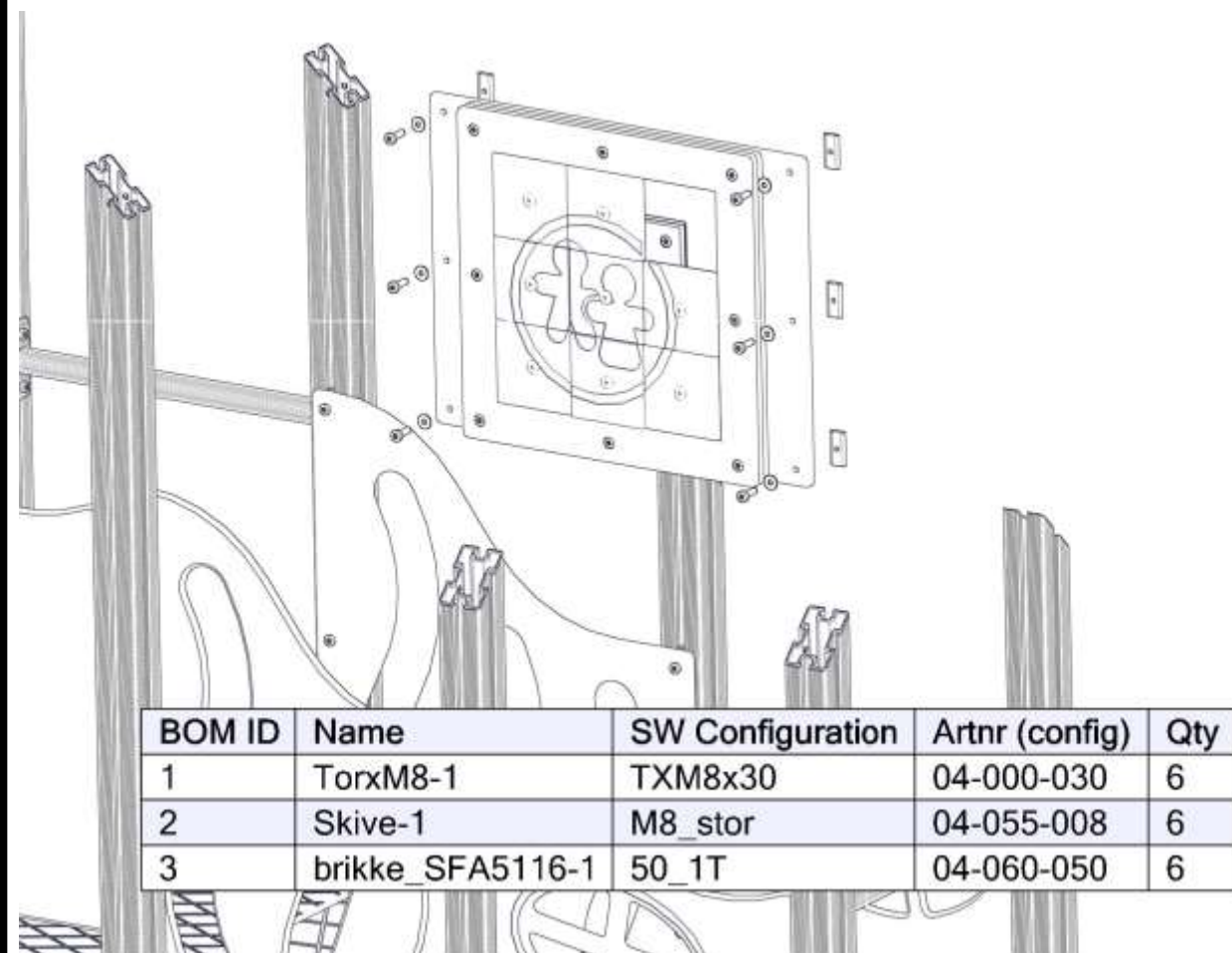
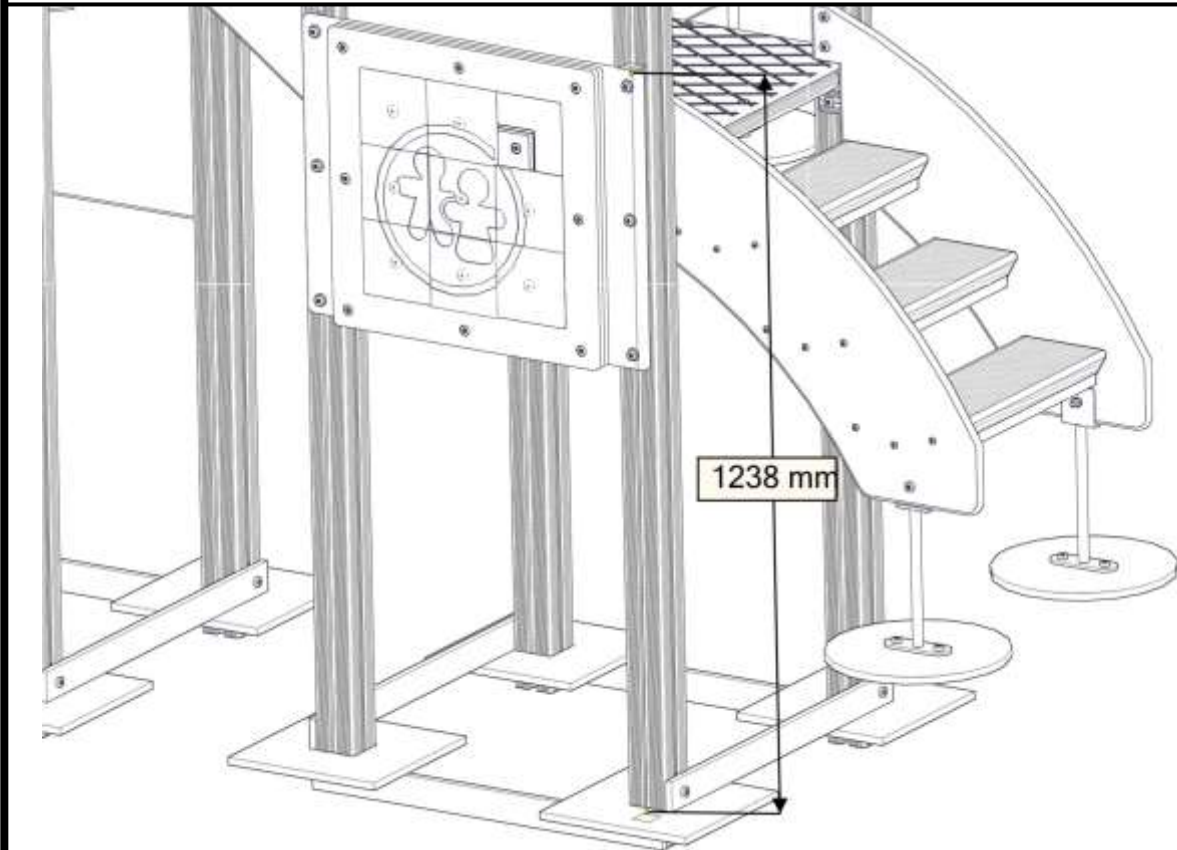

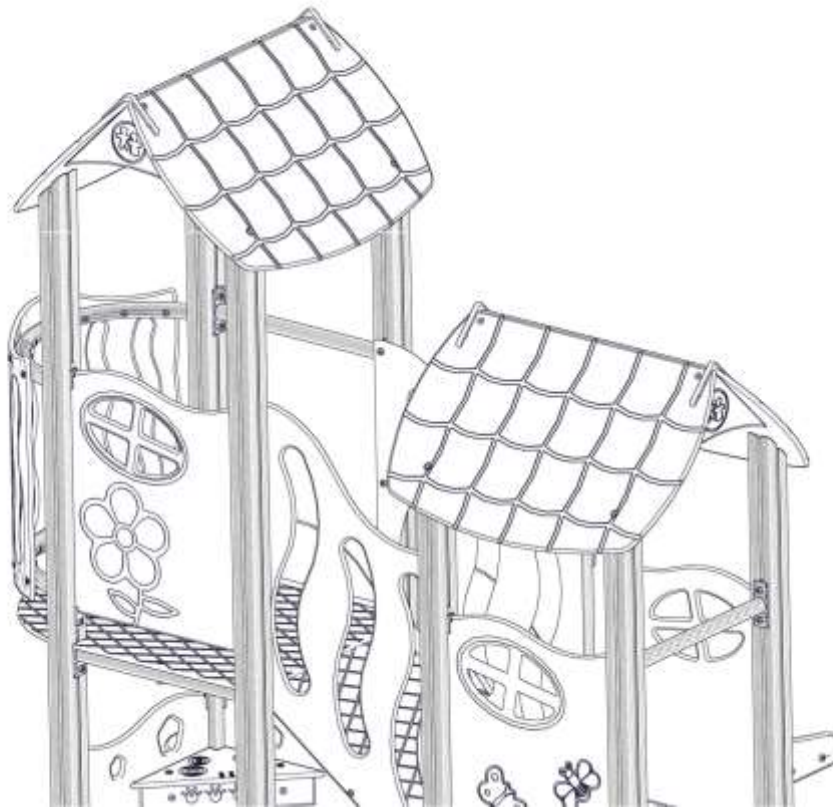

2x

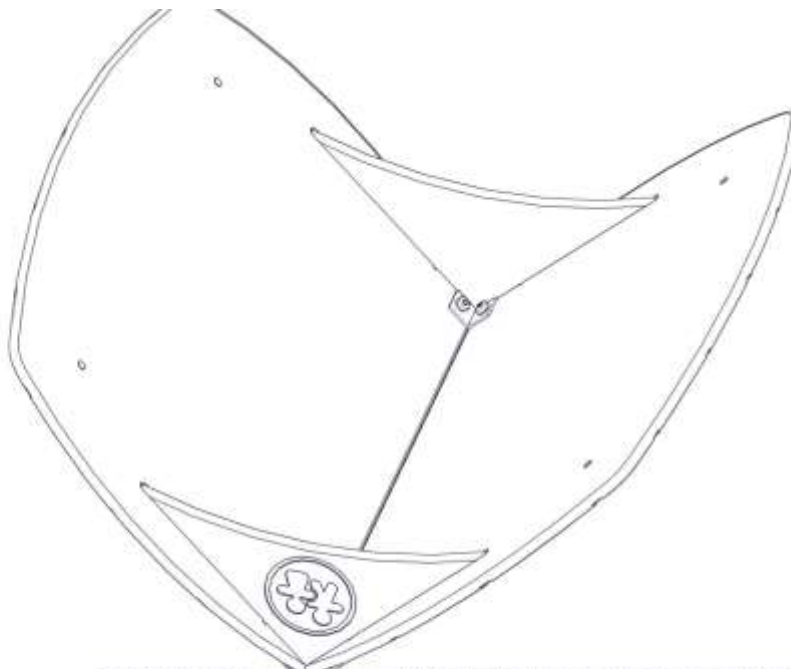

BOM ID	Name	SW Configuration	Artnr (config)	Qty
1	TorxM8-	TXM8x12	04-000-012	4
2	Mobelknapp-	M8_13_17	04-030-011	4
3	Skive-	M8	04-050-008	4
4	35x35x3-1	11mm	04-070-036	2
5	Tak_Miniserie2011-	rod	07-510-105	2
6	Gavelplatemini2011-	Rod	07-510-106	2

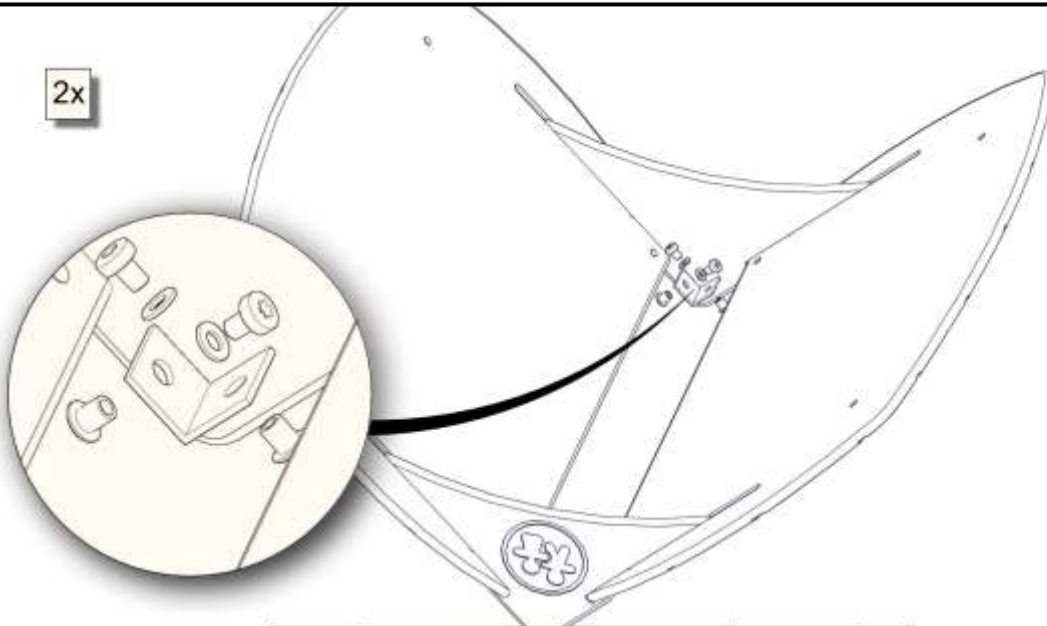



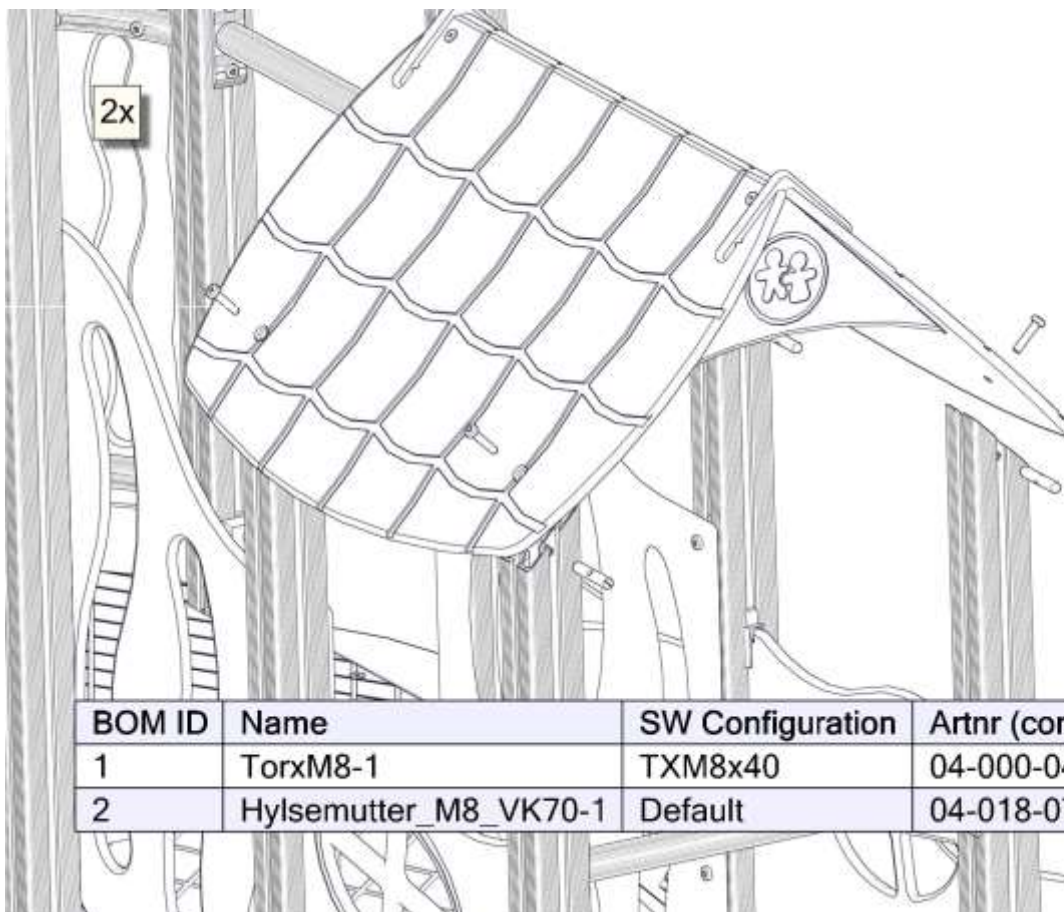





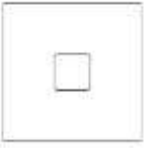

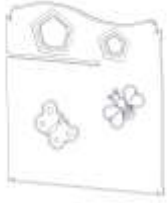

BOM ID	Name	SW Configuration	Artnr (config)	Qty
1	TorxM8-	TXM8x12	04-000-012	4
2	Mobelknapp-	M8 13 17	04-030-011	4
3	Skive-	M8	04-050-008	4
4	35x35x3-1	11mm	04-070-036	2
5	Tak Miniserie2011-	rod	07-510-105	2
6	Gavelplatemini2011-	Rod	07-510-106	2



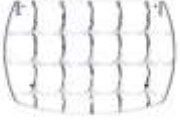







BOM ID	Name	SW Configuration	Artnr (config)	Qty
1	TorxM8-1	TXM8x40	04-000-040	4
2	Hylsemutter_M8_VK70-1	Default	04-018-070	4

Før utstyret tas i bruk / Before play begins / Innan lekredskapet tas i bruk	
N	<ul style="list-style-type: none"> ● Påse at fallunderlag er utlagt i henhold til gjeldende regler eller vår anbefaling ● Fjern alle monteringshjelpemidler (rester av betong, planker, paller, plast, og lignende) ● Før utstyret tas i bruk, burde man sjekke at det ikke er fare for at anorakksnorer og lignende som kan hekte seg fast noen steder på lekeapparatet. (Vedlagte snor med dobbe (kneledd) kan brukes til å sjekke at dette er i orden. Se vedlagte veiledning for bruk av denne. Dette gjøres for å oppdage eventuelle feilmonteringer.?) ● NB! Bør stå i 2-3 dager før bruk
EN	<ul style="list-style-type: none"> ● Make sure the area and depth of safer surfacing are according to the current standard, or to the manufacturer's recommendation ● Make sure all tools and surplus materials are removed before play begins ● PS! When complete, allow 2-3 days for the concrete to set before use
S	<ul style="list-style-type: none"> ● Kontrollera att fallunderlag är utlagt enligt gällande regler eller vårt rekommendation ● Ta bort alla monteringshjälpmedel (rester av betong, plankor, pallar, plast och liknande) ● Innan lekredskapet används, kontrollera att anoracksnoddar eller kläder/delar av kläder eller liknande inte kan fastna i några delar på redskapet. (Den bipackade "knävringen" kan man med fördel användas för denna kontroll. ● Detta görs för att upptäcka eventuella felmonteringar.)

komponenter		Sign. _____.
	VK70 2200-600 skrå 07-510-154	4
	VK70 1700-600 Skrå 07-510-156	4
	Mini fundament skive 07-510-201	8
	Minisprosse fund L=660 07-510-200	8
	Vegg 520x600 07-510-120	2
	Vegg 520x600 07-510-120	1
	Vegg 520x520 07-510-124 Spor venstre	1
	Vegg 520x520 07-510-123 Spor høyre	1
	Vegg 520x400 07-510-110	1
	Gulv Mini 520 07-510-104 LANG på 1 side	1
	Sperrerør 520 07-510-160	2
	Sperrerør gulv 07-510-161	8
	Produktmerking	

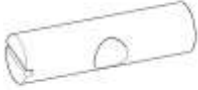
komponenter		Sign. _____
	Utsikt på sper- rerør 1 07-510-134	Gulv Utsikt 1 05-510-101
	Tak mini 4 07-510-105	GavelplateMini 4 07-510-106
	Skrå plato venstre vegg 1 07-510-321	Skrå plato Høyre 1 vegg 07-510-322
	Skrå plato 1 07-510-323	Trapp 550 1 01-290-090
	Rutsjebane 1 07-510-310	Søve Slide 1 25-100-020
	Kokeplate rund 1 stolpe 07-510-136	Butikkdiskk 1 07-510-130
	Kokeplate front 1 07-510-135	

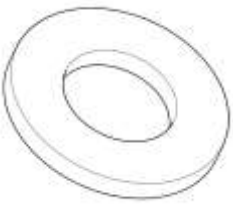
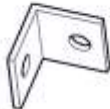
komponenter		Sign. _____				
	Torx M8x12 04-000-012	14		Brikke 50-1T 04-060-050	62	
	Torx M8x20 04-000-020	4			Brikke 120-3T 04-060-120	10
	Torx M8x25 04-000-025	70			Brikke 90-2T 04-060-090	2
	Torx M8x30 04-000-030	10		Spesialbrikke 04-060-041	24	
	Torx M8x35 04-000-035	30			Låsemutter M8 04-040-008	14
	Torx M8x40 04-000-040	8				Stålforankring 00-100-312
	Torx M8x45 04-000-045	10				
	Møbelknapp M8x13x17 04-030-011	26		Hylsemutter M8 12-70 04-018-070	8	
				Fundamentplate 00-003-106	4	
	Skive M8 04-050-008	34		Vinkel 35x35x35 04-070-036	6	
				Vinkel 50x50x50 04-070-050 11mm	6	