

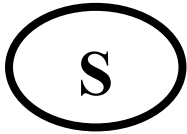

Monteringsanvisning



Assembly Instructions



Monteringsanvisning

Produkt nr. / Product no. / Produkt nr.

25-200-095

Ordr. nr. _____

Dato. _____

Sign. _____



Søve Lekemiljø AS

3830 Ulefoss - Norway

Tlf: +47 35 94 65 65

www.sove.no



Søve AB

Fabriksgatan 7

412 50 Göteborg

Phone: +46 (0)31 773 97 00

www.sove.se

Monteringstips / Assembly Advice / Monteringsstips

N

- Les monteringsanvisningen nøye før montering.
- Monter elementene i rekkefølgen som vist.
- Boltene bør ikke skrues for hardt til før alt er montert, vatret og loddet. Skru så boltene til.
- NB! Ved bruk av drill, kan boltene ryke.
- På grunn av at solen kan gjøre rutsjeplaten veldig varm, bør rutsjebanens utløp vende mot nord-øst eller nord-vest.
- Er lekeutstyret plassert i naturlige ferdselstraséer må området sikres mot spontan gjennomgang.
- Innspringningshinder bør vurderes rundt lekeapparater hvor det er stor bevegelse, f.eks.
 - ved huskestativ.
- Det bør være fritt innsyn til lekeutstyr som er beregnet for barn under 3 år.

NB! Under monteringsarbeidet må utstyr, som ikke er forankret forsvarlig i bakken, avstives slik at det ikke velte. Området må avstenges under oppsettelse av apparatene med sperrebånd eller lignende.

UK

- Read the instruction carefully before assembling the play unit.
- Assemble the components in the sequence shown in these instructions.
- Fixings must not be fully tightened during assembly. Before casting the foundations, the structure must be level and plumb, at which point all fixings are tightened.
- PS! If use of drill, the bolts may be wrecked.
- Avoid positioning the slide facing due south because of overheating – ideal positions are facing north-east or north-west.
- Secure the construction-area to prevent people from walking through it.
- Consider installing barriers around play-equipment which gives rise to a lot of activity – i.e. swings.
- Ensure that clear vision is possible across the play area so that supervision is possible from any position, particularly where children under 3 years of age will be playing.

NB! During assembly of the equipment, ensure that all structures are securely propped, especially when left overnight. Also ensure that equipment is supported whilst concrete foundations are setting and enclose the area securely to prevent access.

Monteringstips / Assembly Advice / Monteringsstips









S

- Läs monteringsanvisningen noga före montering.
 - Montera delarna i den ordningen som anvisas
 - Skruvarna bör inte skruvas för hårt tills allt är monterat, i våg och lodat.
- OBS! Används elektrisk skruvdragare, kan bulten gå sönder. Hårdra därför manuellt!
- Solen kan göra att rutchbanan blir väldigt varm. Banans nedfart rekommenderas att vändas i norrlig riktning
 - Om lekplatsen placeras vid en gångväg mm bör området säkras mot genomfart av gående och cyklister.
 - Inspringningshinder bör placeras runt lekutrustning med stor rörelse, t ex, gungställning.
 - Det bör vara fri insyn till lekutrustning beräknat till barn under 3 år.

OBS! Under monteringsarbete bör utrustningen som inte ska förankras i marken, ställs så att den inte kan välta.

Området måste spärras när lekutrustningen byggs upp, med avspärrningsband eller liknande.

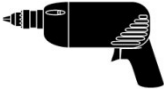
Nødvendig verktøy / Tools required / Nödvändiga verktyg

<p>(N)</p> <p>(UK)</p> <p>(S)</p>	<p>(A)</p> 	<p>(B)</p>  <p>Torx Nr 45 High quality</p>	<p>(C)</p> <p>5 mm 6 mm</p> 	<p>(D)</p> 	<p>(E)</p> 
		<p>Metermål Metric measure Tumstoc</p> 	<p>16 V</p> 	<p>Merkebånd Mark ribbon Märkeband</p> 	<p>13 + 17mm</p> 

Nødvendig antall personer / Number of persons required / Lämpligt antal personer





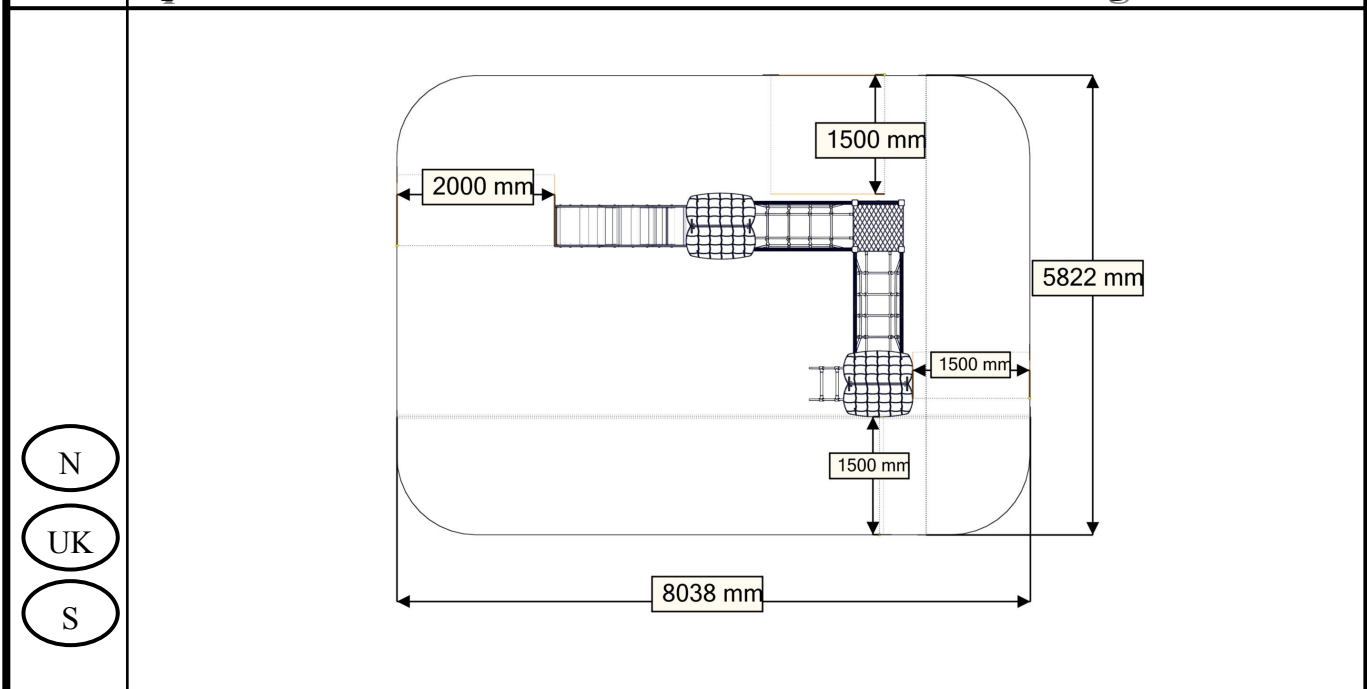



Anbefalt arealbehov ved montering / Recommended working space / Rekommenderad arealbehov vid montering

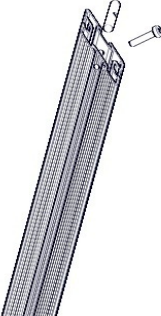



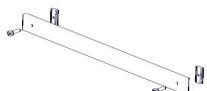

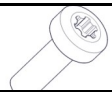
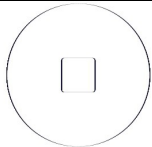





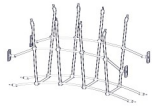

Boltepakker for / Boltpackage for / Bultpaket för

Sign. _____

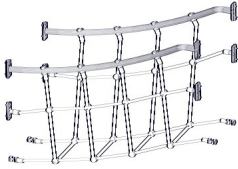
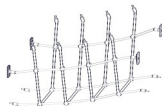
Stolpe 70x70 skrå	Ant= 8	Navn	Artnr/dimensjon	Ant	Lev
		VK70 1700-600 (1)	07-510-156	4	
		VK70 2100-600(1)	07-510-158	4	
		Skrå Brikke på stolpe!			
		Torx M8x40 (1)	04-000-040	8	
		Hullsemutter (1) VK70	04-018-070	8	
Stolpe 70x70	Ant= 4	Navn	Artnr/dimensjon	Ant	Lev
		VK70 1400-600 (1) Brikke på stolpe!	07-510-157	4	
Endelokk 70x70	Ant= 2	Navn	Artnr/dimensjon	Ant	Lev
		Endelokk70x70 (1)	00-400-996	4	
FundamentMini 660	Ant= 12	Navn	Artnr/dimensjon	Ant	Lev
		miniSprosse 660 (1)	07-510-200	12	
		Brikke 50_1T (2)	04-060-040	24	
		Torx M8x35 (2)	04-000-035	24	
FundamentSkive	Ant= 12	Navn	Artnr/dimensjon	Ant	Lev
		Skive (1)	07-510-201	12	













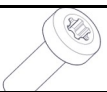

Boltepakker for / Boltpackage for / Bultpaket för

Sign. _____

Nettbro rett 07-510-174	Ant= 1	Navn	Artnr/dimensjon	Ant	Lev
		Nett (1) INKL. beslag	07-510-174	1	
		Rør bue(2)	07-510-164	2	
		Brikke120 3T(8)	04-060-120	8	
		Torx M8x25(16)	04-000-025	16	
		Saddelwasher 38mm (24)	04-210-010	24	
		Møbelknapp (12)	04-030-025	12	
Nettbro skrå 07-510-175	Ant= 1	Navn	Artnr/dimensjon	Ant	Lev
		Nett (1) INKL. beslag	07-510-175	1	
		Rør skrå(2)	07-510-166	2	
		Brikke120 3T(8)	04-060-120	8	
		Torx M8x25(16)	04-000-025	16	
		Saddelwasher 38mm (24)	04-210-010	24	
		Møbelknapp (12)	04-030-025	12	











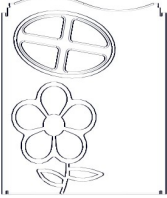
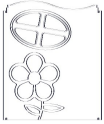

Boltepakker for / Boltpackage for / Bultpaket för

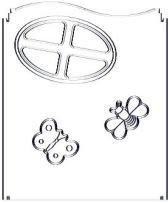
Sign. _____

Sperrerør 520	Ant= 4	Navn	Artnr/dimensjon	Ant	Lev
		Sperrerør 520 (1)	07-510-160	4	
		Brikke 120_3T (2)	04-060-120	8	
		Torx M8x25 (2)	04-000-025	16	
Sperrerør 520 gulv	Ant= 7	Navn	Artnr/dimensjon	Ant	Lev
		Sperrerør 520 (1)	07-510-161	7	
		Brikke 90_2T (2)	04-060-090	0 På stolpe	
		Torx M8x25 (2)	04-000-025	14	
Sperrerør 520 gulv 2 hull 300	Ant= 4	Navn	Artnr/dimensjon	Ant	Lev
		Sperrerør 520 (1) For rung	07-510-162	4	
		Brikke 90_2T (2)	04-060-090	0 På stolpe	
		Torx M8x25 (2)	04-000-025	8	
Sperrerør 520 gulv Hull for RUNG 400	Ant= 1	Navn	Artnr/dimensjon	Ant	Lev
		Sperrerør 520 (1) For rung	07-510-163	1	
		Brikke 90_2T (2)	04-060-090	0 På stolpe	
		Torx M8x25 (2)	04-000-025	2	







Boltepakker for / Boltpackage for / Bultpaket för

Sign. _____

Vegge 520x600 Vindo bloms	Ant= 3	Navn	Artnr/dimensjon	Ant	Lev
		Vegge520x600 (1) Vindu blom	07-510-420	3	
		Brikkespesial(4)	04-060-042	12	
		Brikke(4)	04-060-040	12	
		Torx M8x25(4)	04-000-025	12	
Vegge 520x600 Vindo bi	Ant= 2	Navn	Artnr/dimensjon	Ant	Lev
		Vegge520x600 (1) Vindu bi	07-510-420	2	
		Brikkespesial(4)	04-060-042	8	
		Brikke(4)	04-060-040	8	
		Torx M8x25(4)	04-000-025	8	
Gulv mini	Ant= 3	Navn	Artnr/dimensjon	Ant	Lev
		Gulv Mini 520(1)	07-510-102	3	
		Møbelknapp (4)	04-030-011	11	
		Torx M8x45 (4)	04-000-045	11	









Boltepakker for / Boltpackage for / Bultpaket för

Sign. _____

Tak	Ant= 2	Navn	Artnr/dimensjon	Ant	Lev
		Tak mini (2)	07-510-405	4	
		Gavelplate(2)	07-510-406	4	
		Vinkel 35x35x3(2) 11mm	04-070-036	4	
		Møbelknapp	04-030-011	8	
		Torx M8x12(4)	04-000-012	8	
		Skive M8 (4)	04-050-008	8	











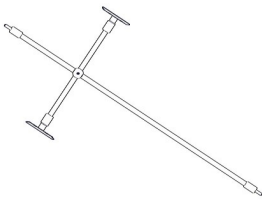

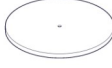
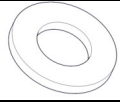

Boltepakker for / Boltpackage for / Bultpaket för

Sign. _____

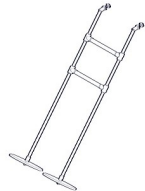
Rutsjebane 950 07-510-310	Ant= 1	Navn	Artnr/dimensjon	Ant	Lev
		Rutsjebane	07-510-310	1	
		Brikke120 3T(5)	04-060-120	2	
		Torx M8x35(4) Torx M8x45(2) Torzx M8x30(4)	04-000-035 04-000-045 04-000-030	4 2 4	
		Fundamentskive(2) 2H 80	00-003-106	2	
		Skive M8(2)	04-050-008	4	
		Mutter M8(2)	04-040-008	6	
		Stålforankering(2)	00-100-310	2	

Boltepakker for / Boltpackage for / Bultpaket för

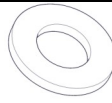
Sign. _____

PolyTreppe 550 07-510-177	Ant= 1	Navn	Artnr/dimensjon	Ant	Lev
		StigTrinn 950 (1) INKL beslag	07-510-177	1	
		Saddelwasher 38mm (1)	04-210-010	1	
		Brikke 120_3T (2)	04-060-120	2	
		Torx M8x20 (2)	04-000-020	4	
		Møbelknapp (1)	04-030-011	1	
		Fundamentskive	00-003-103	1	
		Skive M8	04-050-008	1	
		Låsemutter M8	04-040-008	1	
Stigtrinn	Ant= 1	Navn	Artnr/dimensjon	Ant	Lev
		StigTrinn 400 (1)	07-510-170	1	
		Saddelwasher 38mm (4)	04-210-010	4	
		Møbelknapp (2)	04-030-025	2	
		Fundamentskive	00-003-103	2	
		Skive M8	04-050-008	2	
		Låsemutter M8	04-040-008	2	

Fundamentering med betong / Foundation concrete / Förankring med betong

(N)	Støtsand		(N)	(UK)	(S)
(UK)	Safer surface		Bakkenivå	Ground level	Marknivå
(S)	Stridsan		↓	Ref NS-EN 177	
(N)	Komprimert masse.	betong			
(UK)	Compressed mass.	concrete			
(S)	Komprimerad massa.	betong			

Fundamentering uten betong / Foundation without concrete / Förankring utan betong

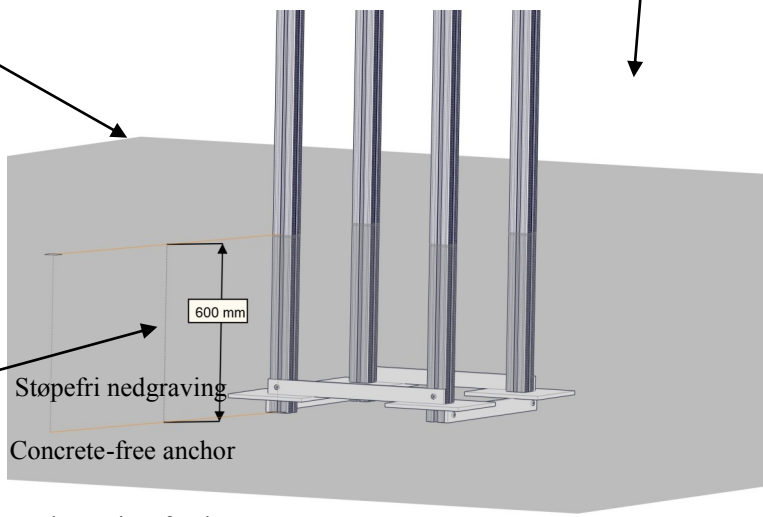
(N)	Støtsand		(N)	(UK)	(S)
(UK)	Safer surface		Bakkenivå	Ground level	Marknivå
(S)	Stridsan		↓	Ref NS-EN 1177	
(N)	Komprimert masse	Støpefri nedgraving			
(UK)	Compressed mass	Concrete-free anchor			
(S)	Komprimerad massa	Nedgravningsfundament			

(N)	Alle mål er oppgitt i millimeter
(UK)	Scale measured in mm
(S)	Alla mått är i millimeter.

Fundamentering klatrenett / Foundation nets / Förankring klätternät

- N** For klatrenett
- UK** For climbing net
- S** För klätternät

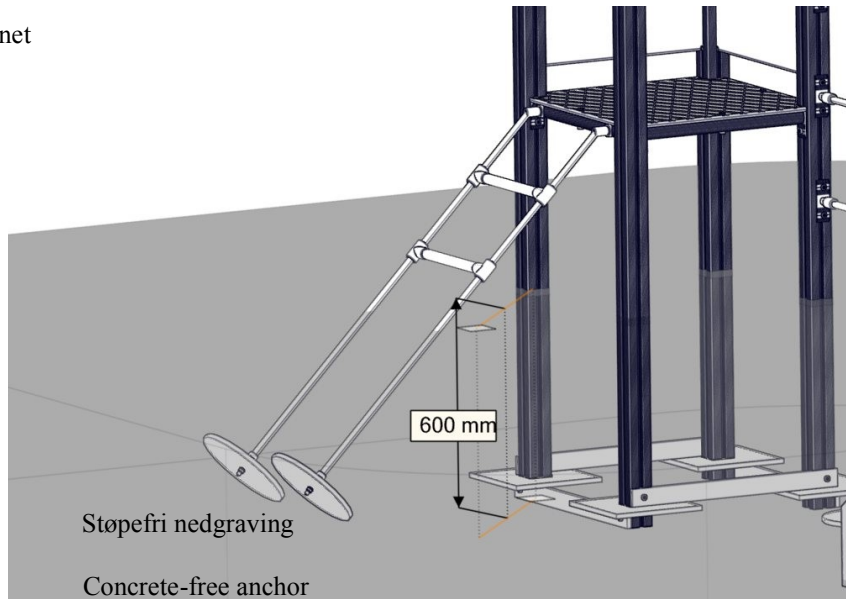

- N** Komprimert masse
 - UK** Compressed mass
 - S** Komprimerad massa
- Nedgravningsfundament

- N** Dybde for støping og forankring
- UK** Depth for foundations
- S** Djup för gjutning och markförankring

- N** Alle mål er oppgitt i millimeter
- UK** Scale measured in mm
- S** Alla mått är i millimeter.

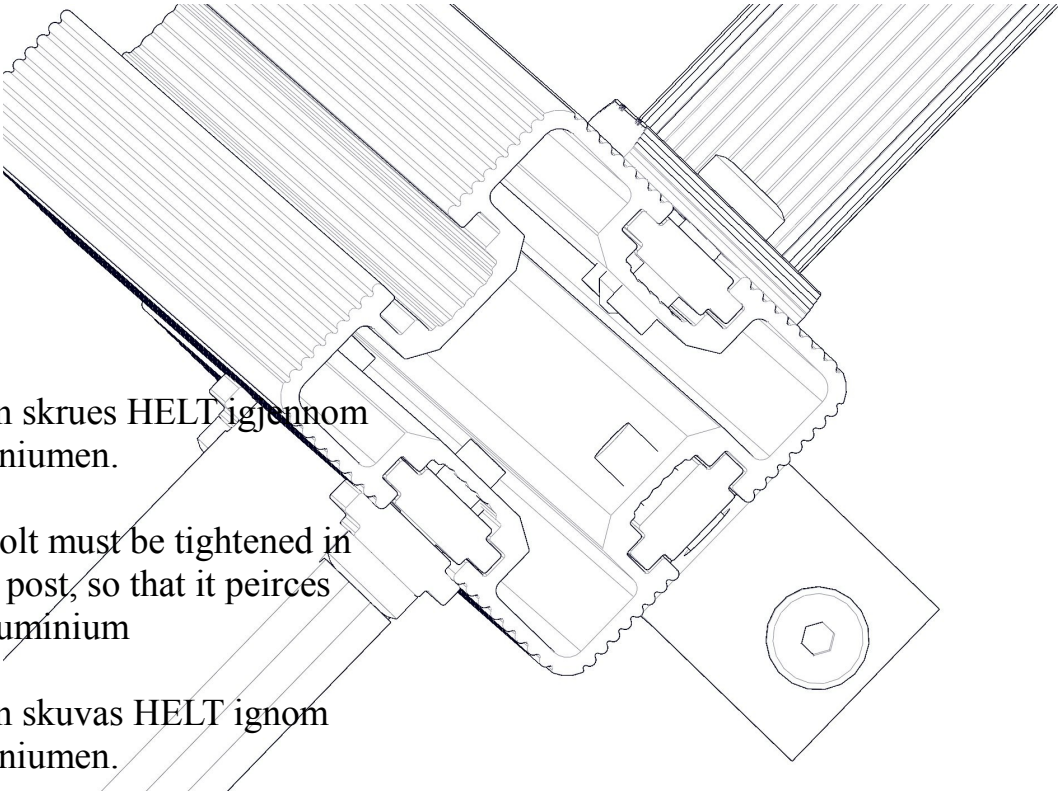
<p data-bbox="124 1559 220 1626">N</p> <p data-bbox="124 1693 220 1760">UK</p> <p data-bbox="124 1850 220 1917">S</p>	 <p data-bbox="240 1585 703 1666">Bolten skrues HELT igjennom aluminiumen.</p> <p data-bbox="240 1715 687 1841">The bolt must be tightened in to the post, so that it peircés the aluminium</p> <p data-bbox="240 1890 663 1971">Bulten skivas HELT ignom aluminiumen.</p>

Fallhøyder / Free height of fall / Fallhöjder

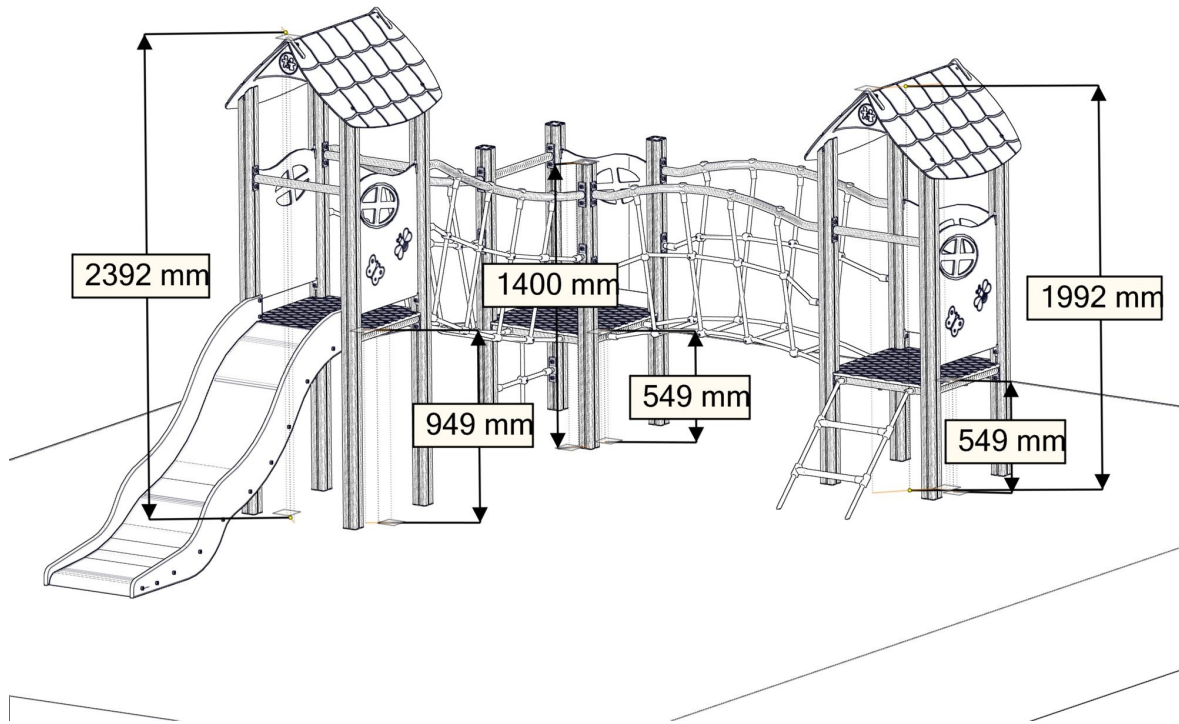

Sikkerhetszone / Safety zone / Säkerhetszon

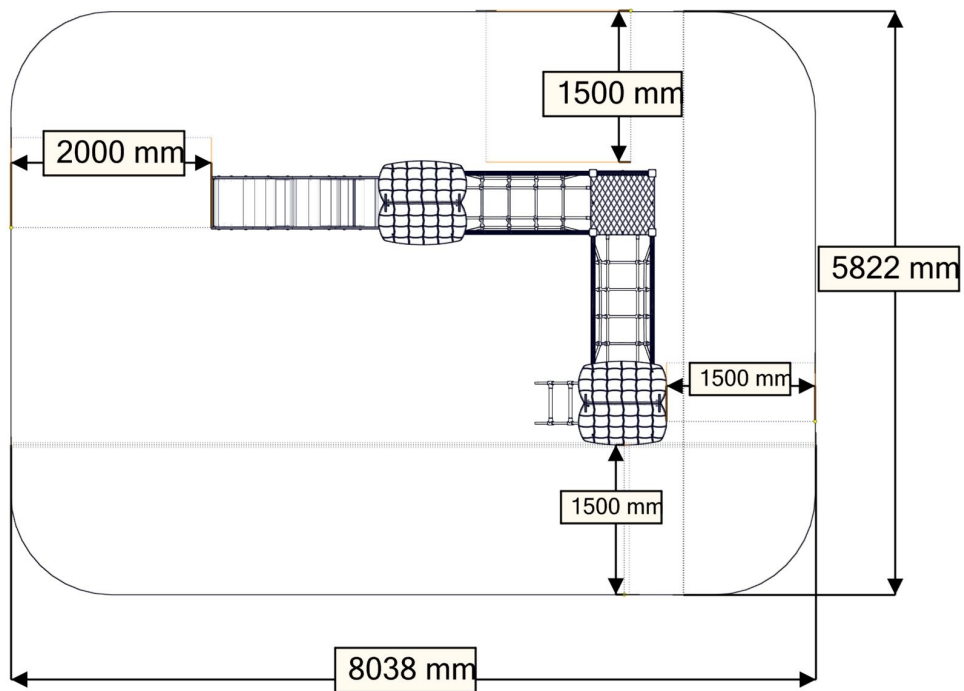

Plassering av forankringer / Ground plan / Placering av förankringar

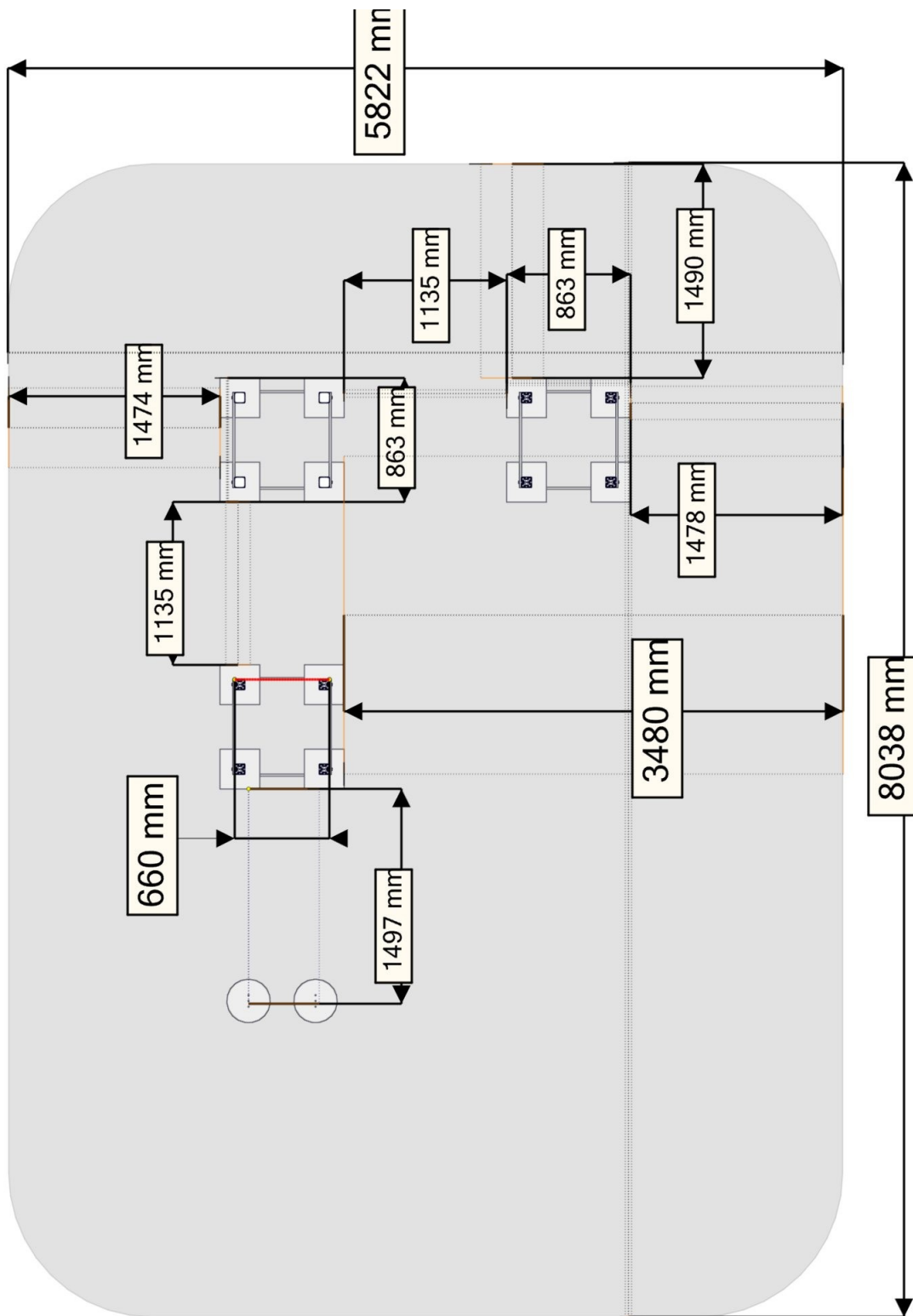

N

Alle mål er oppgitt i millimeter

UK

Scale measured in mm

S

Alla mått är i millimeter.

Montering av lekeapparatet / Assembly instructions / Montering av lekredskapet

Montasje hos Søve 25-200-090

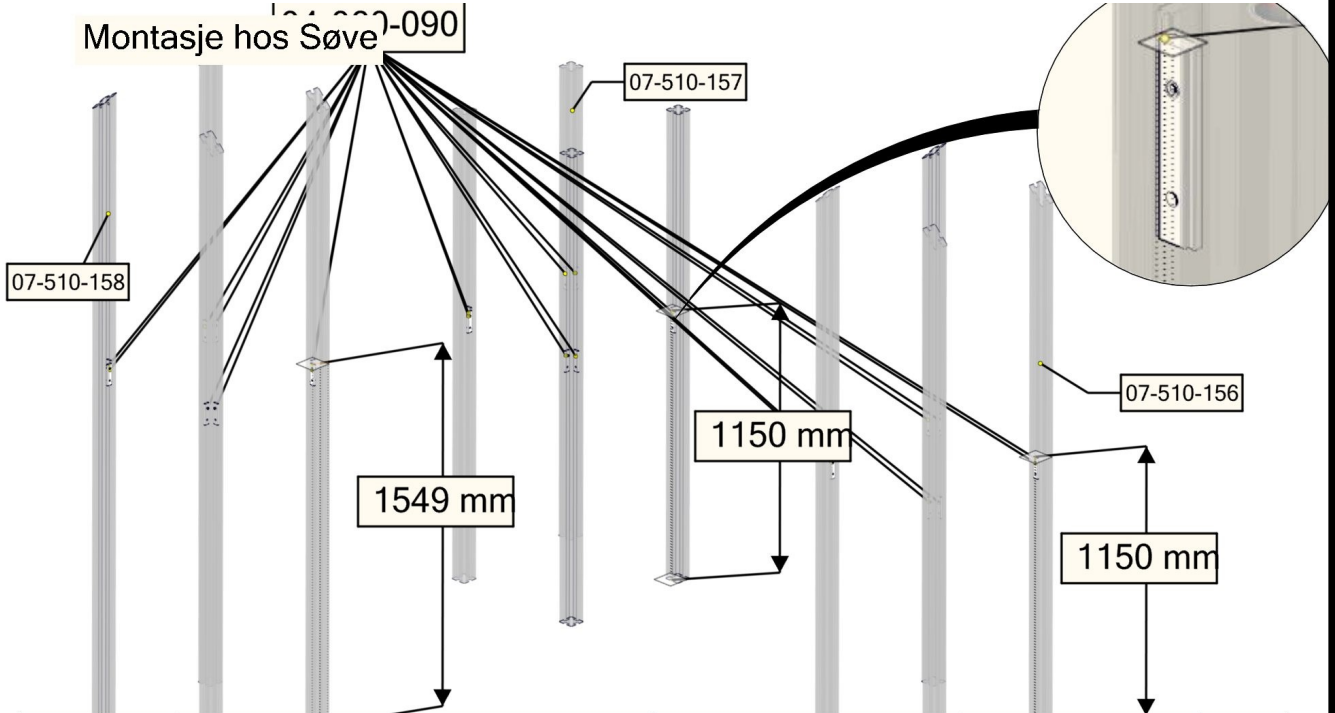

BOM ID	Name	SW Configuration	Artnr (config)	Qty
1	VK70_SFA5123_miniSkra-1	1700-600	07-510-156	4
2	VK70_SFA5123_miniserie-1	1400-600	07-510-157	4
3	VK70_SFA5123_miniSkra-1	2100-600	07-510-158	4

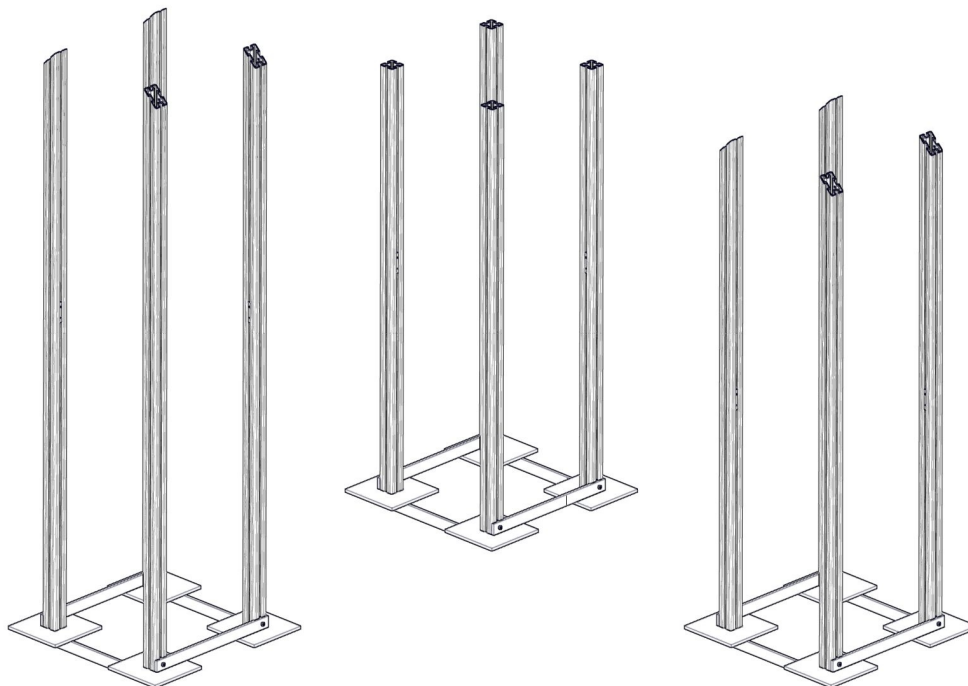

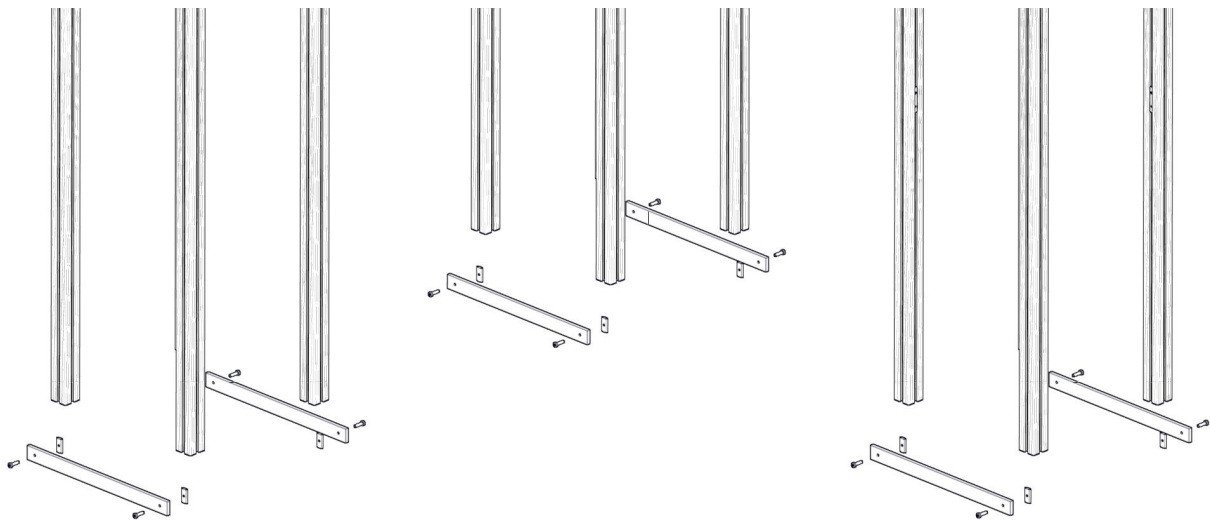

BOM ID	Name	SW Configuration	Artnr (config)	Qty
1	TorxM8-	TXM8x35	04-000-035	12
2	brikke_SFA5116-	50_1T	04-060-040	12
3	minifun_sprosse-1	660	07-510-200	6

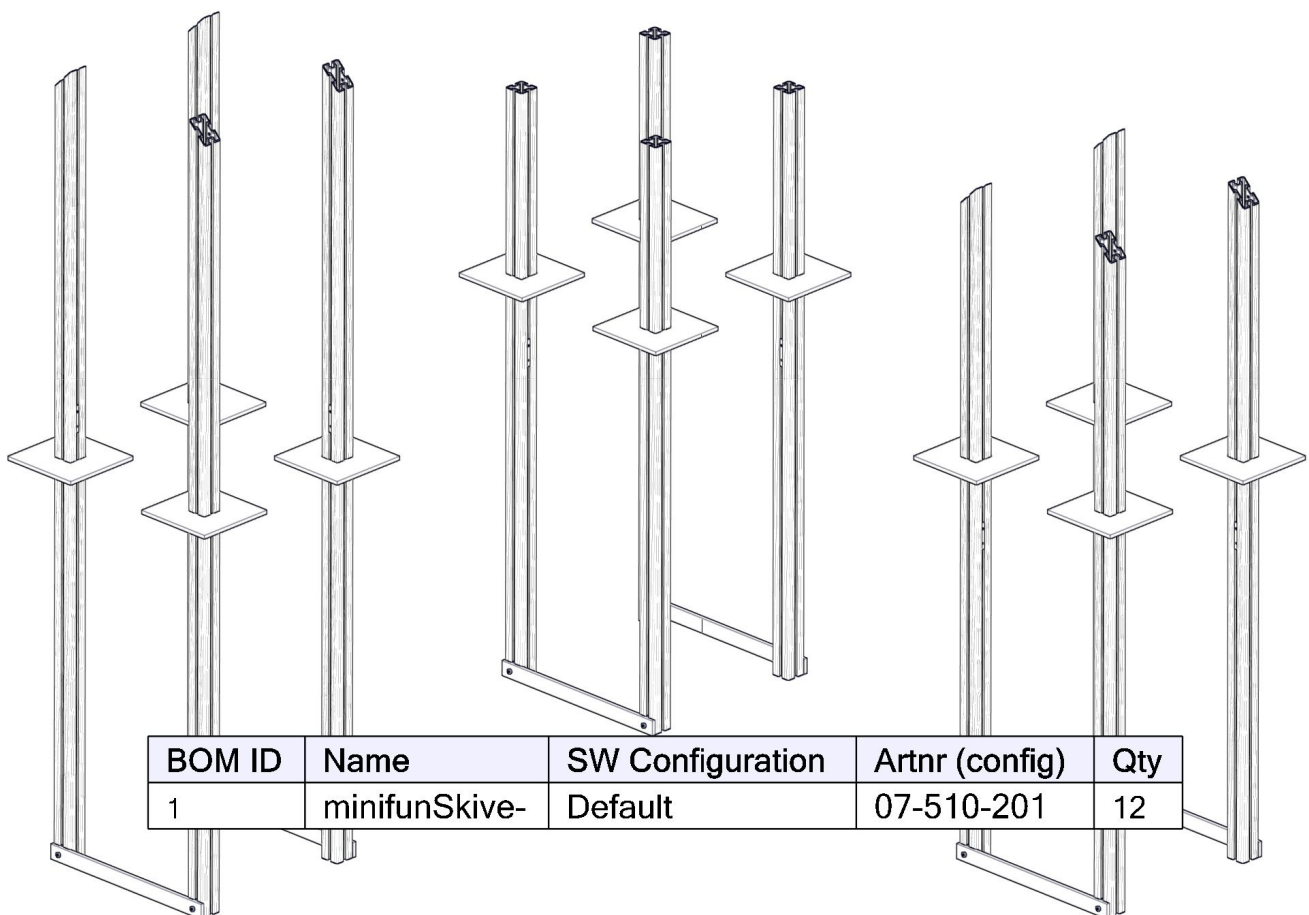

BOM ID	Name	SW Configuration	Artnr (config)	Qty
1	minifunSkive-	Default	07-510-201	12

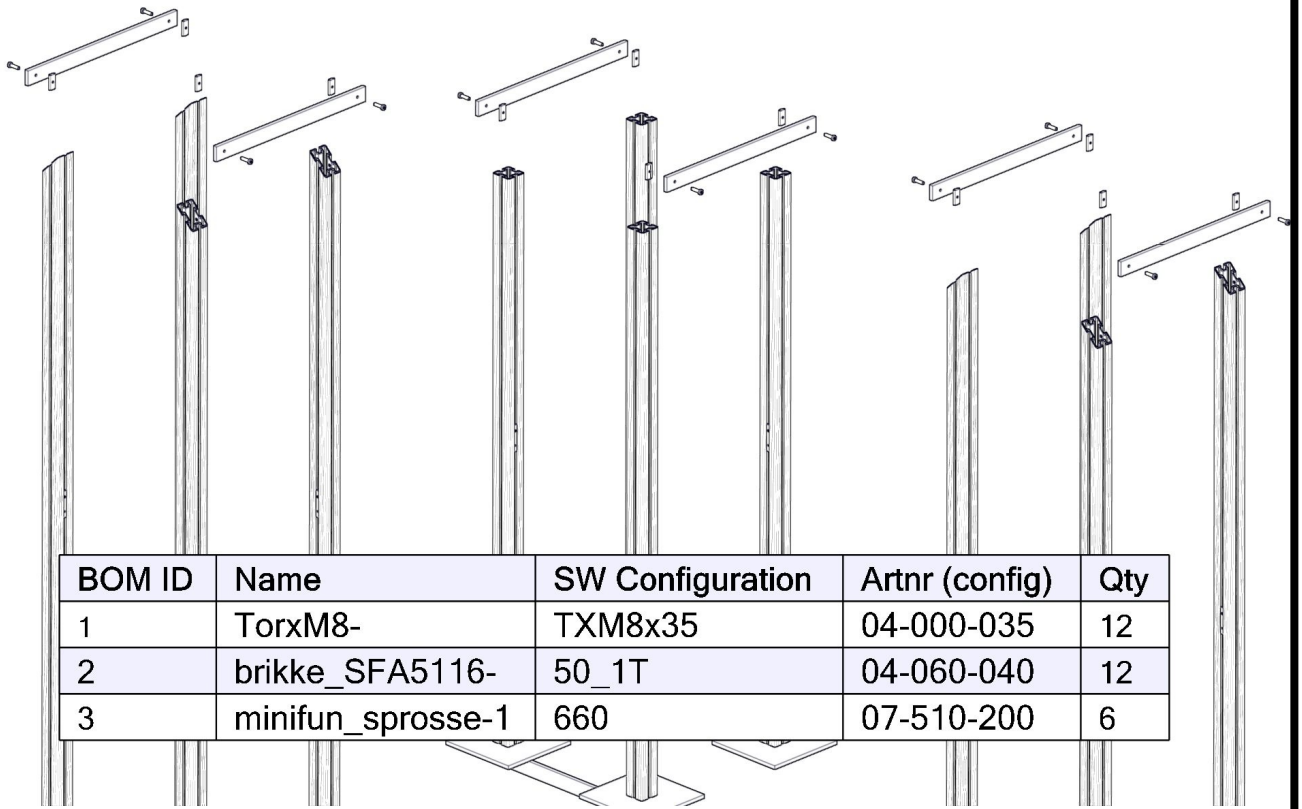

BOM ID	Name	SW Configuration	Artnr (config)	Qty
1	TorxM8-	TXM8x35	04-000-035	12
2	brikke_SFA5116-	50_1T	04-060-040	12
3	minifun_sprosse-1	660	07-510-200	6

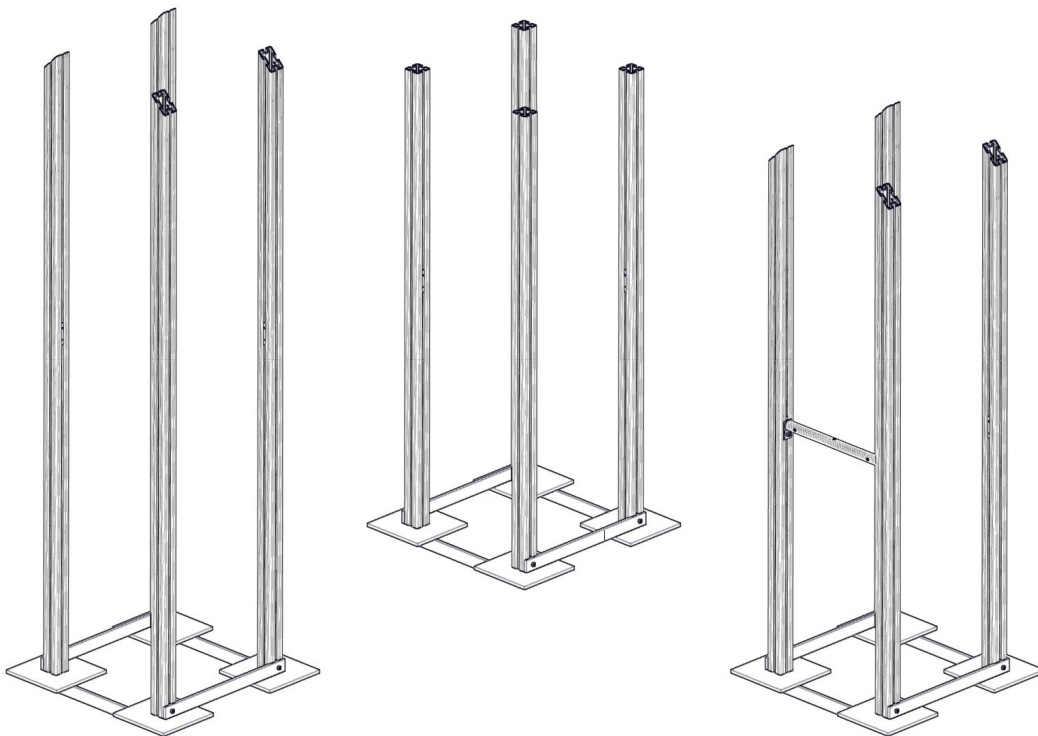

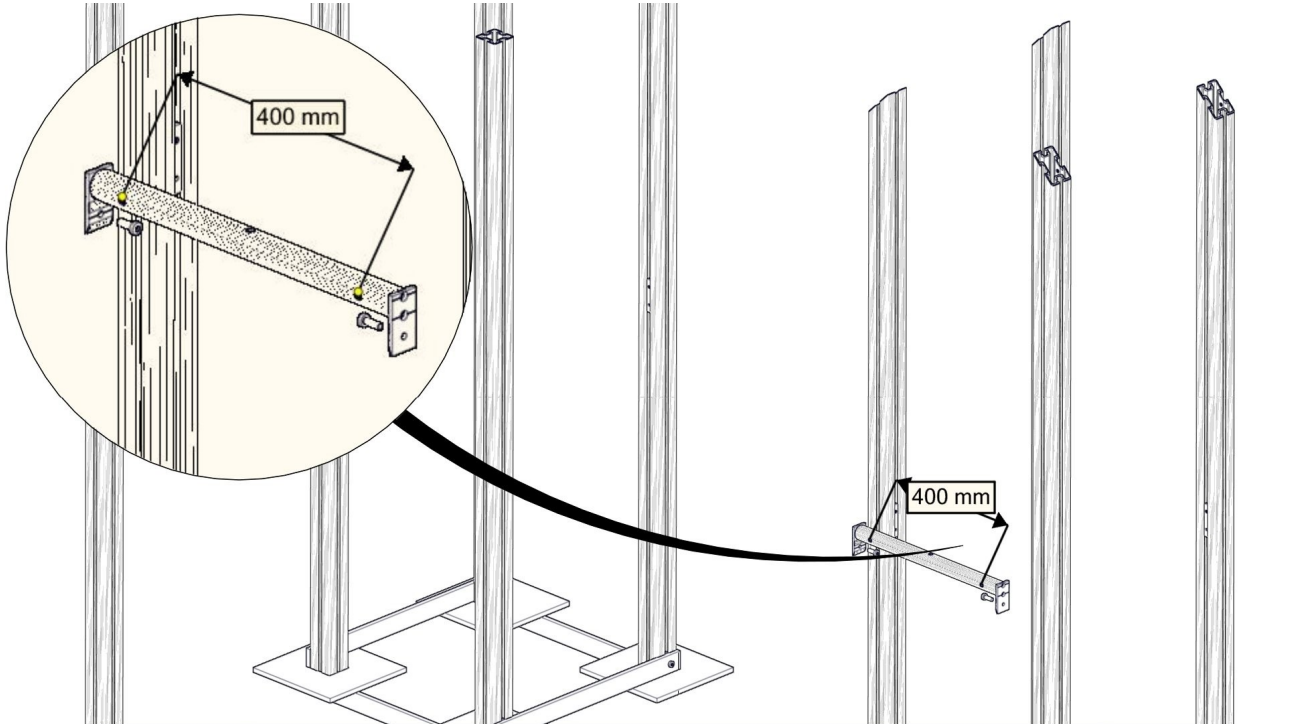

BOM ID	Name	SW Configuration	Artnr (config)	Qty
1	Torxm8-	TXM8x25	04-000-025	2
2	Sperror_MINI508-1	GulvHor_Rung	07-510-163	1

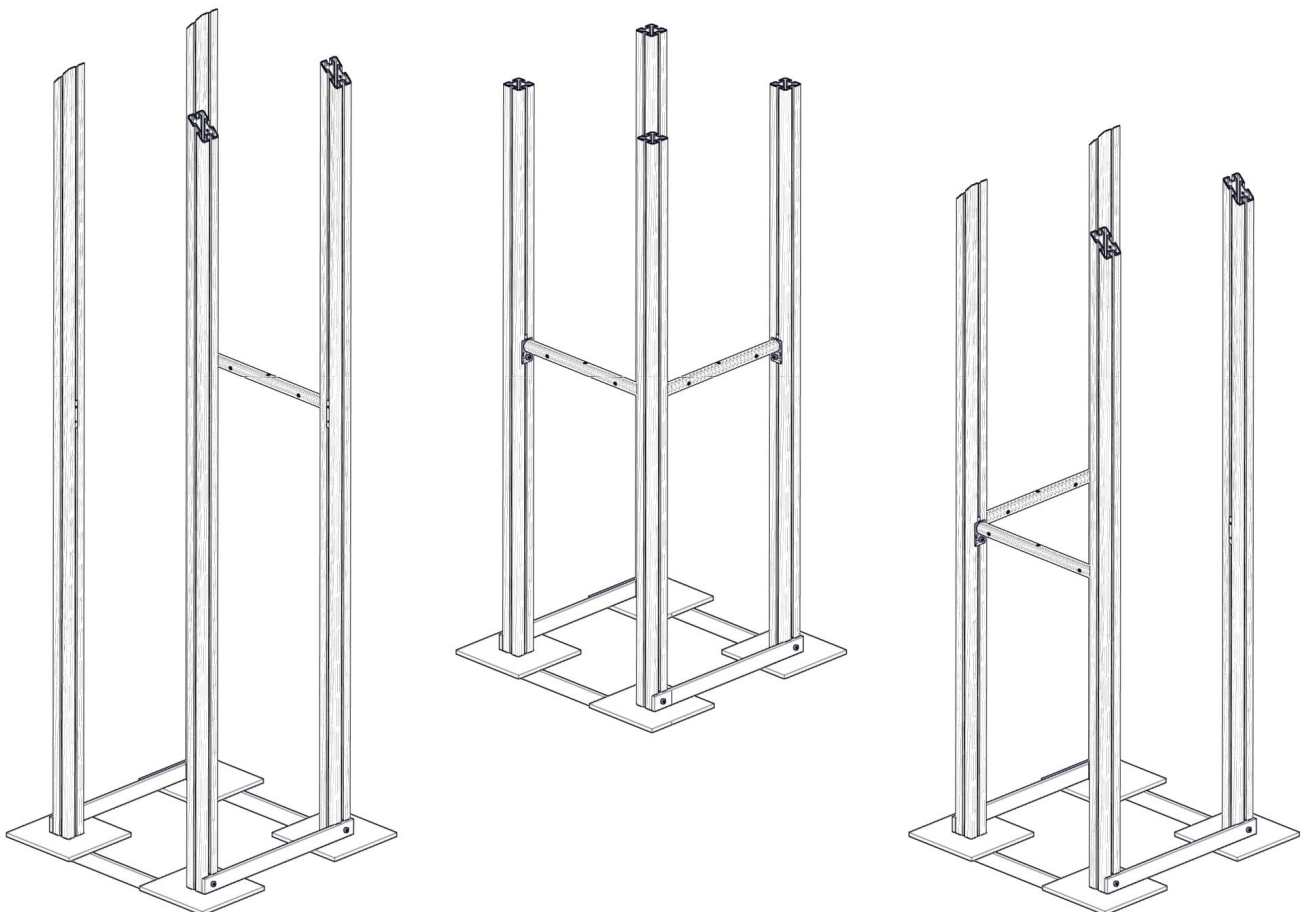

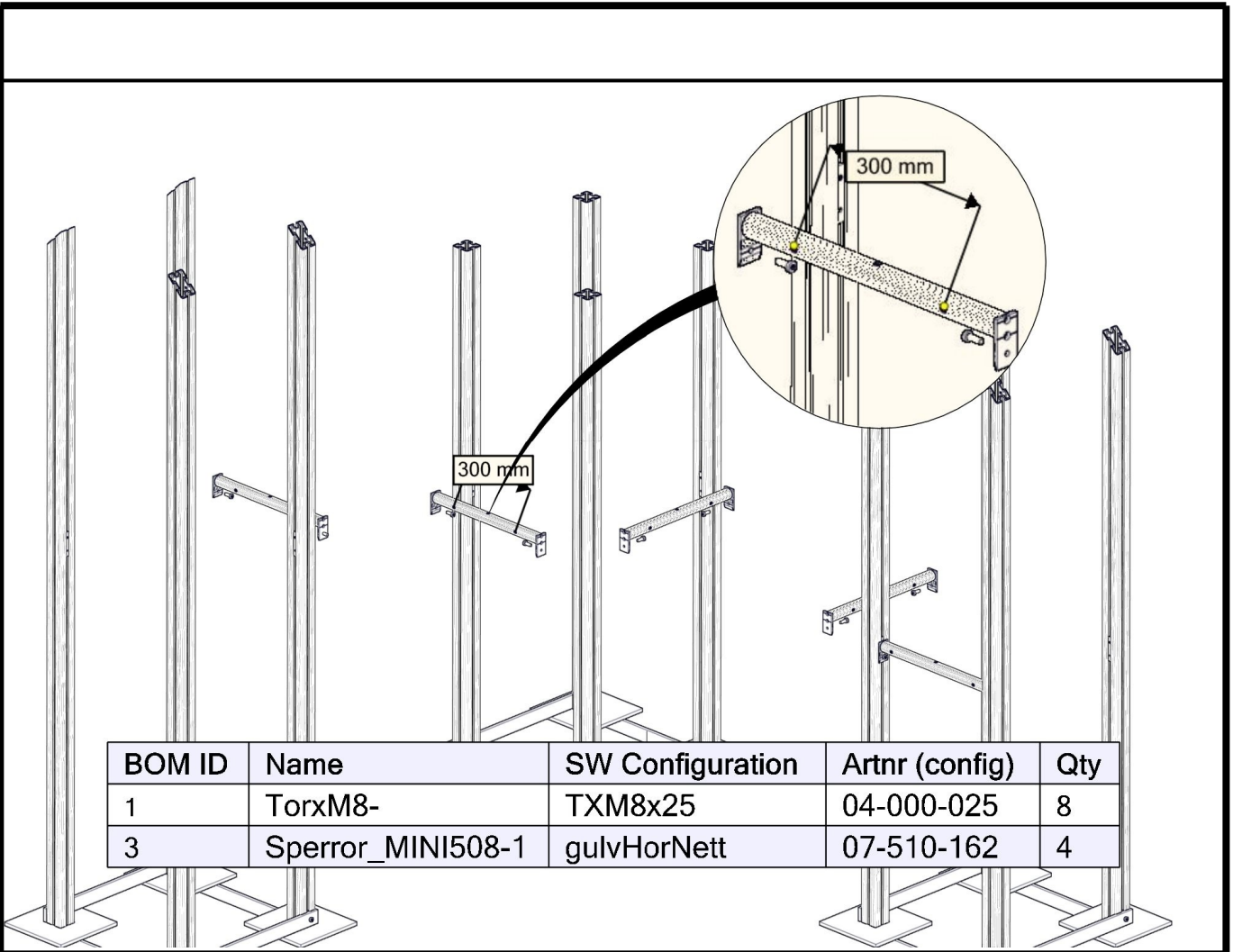

BOM ID	Name	SW Configuration	Artnr (config)	Qty
1	TorxM8-	TXM8x25	04-000-025	8
3	Sperror_MINI508-1	gulvHorNett	07-510-162	4

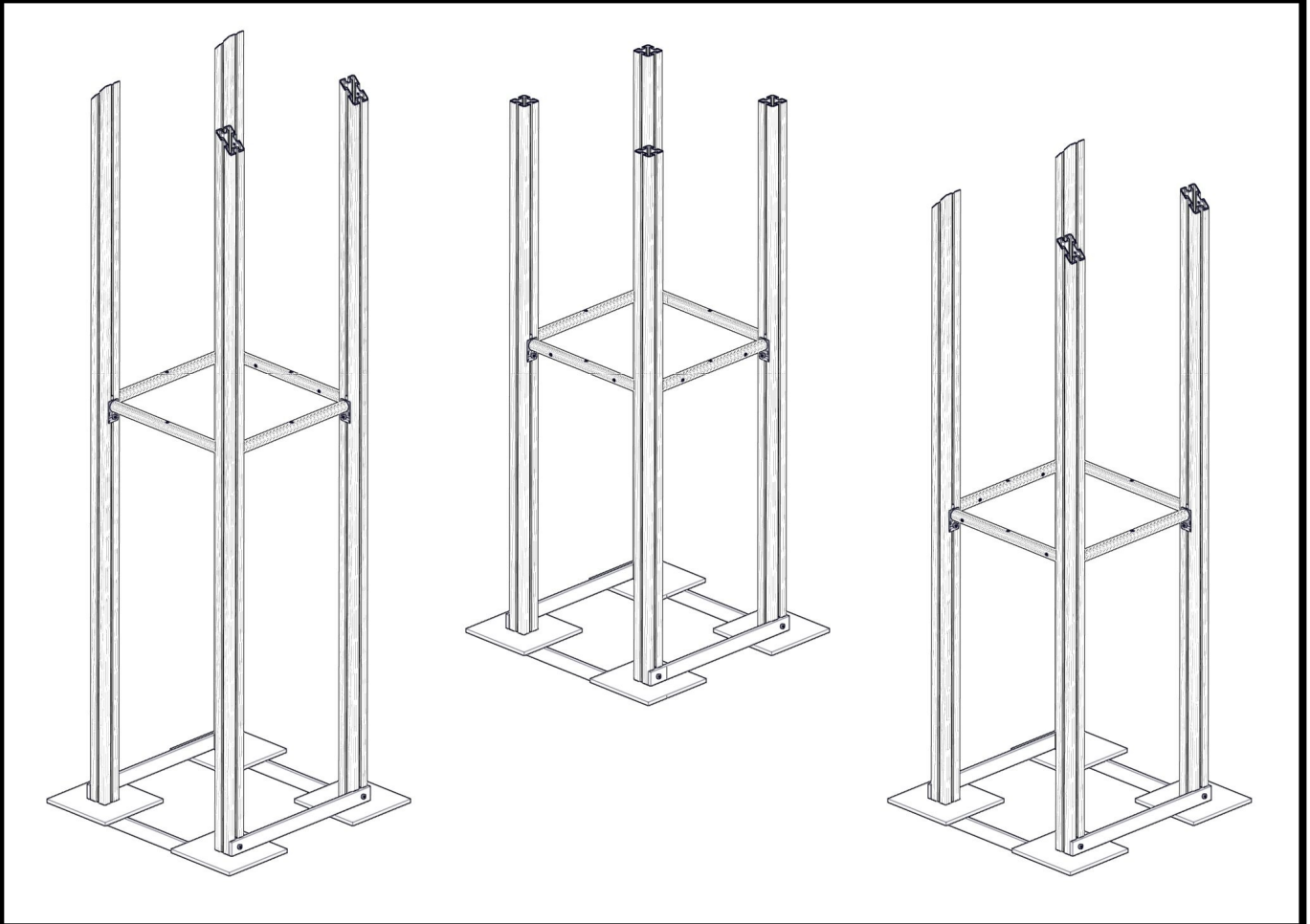

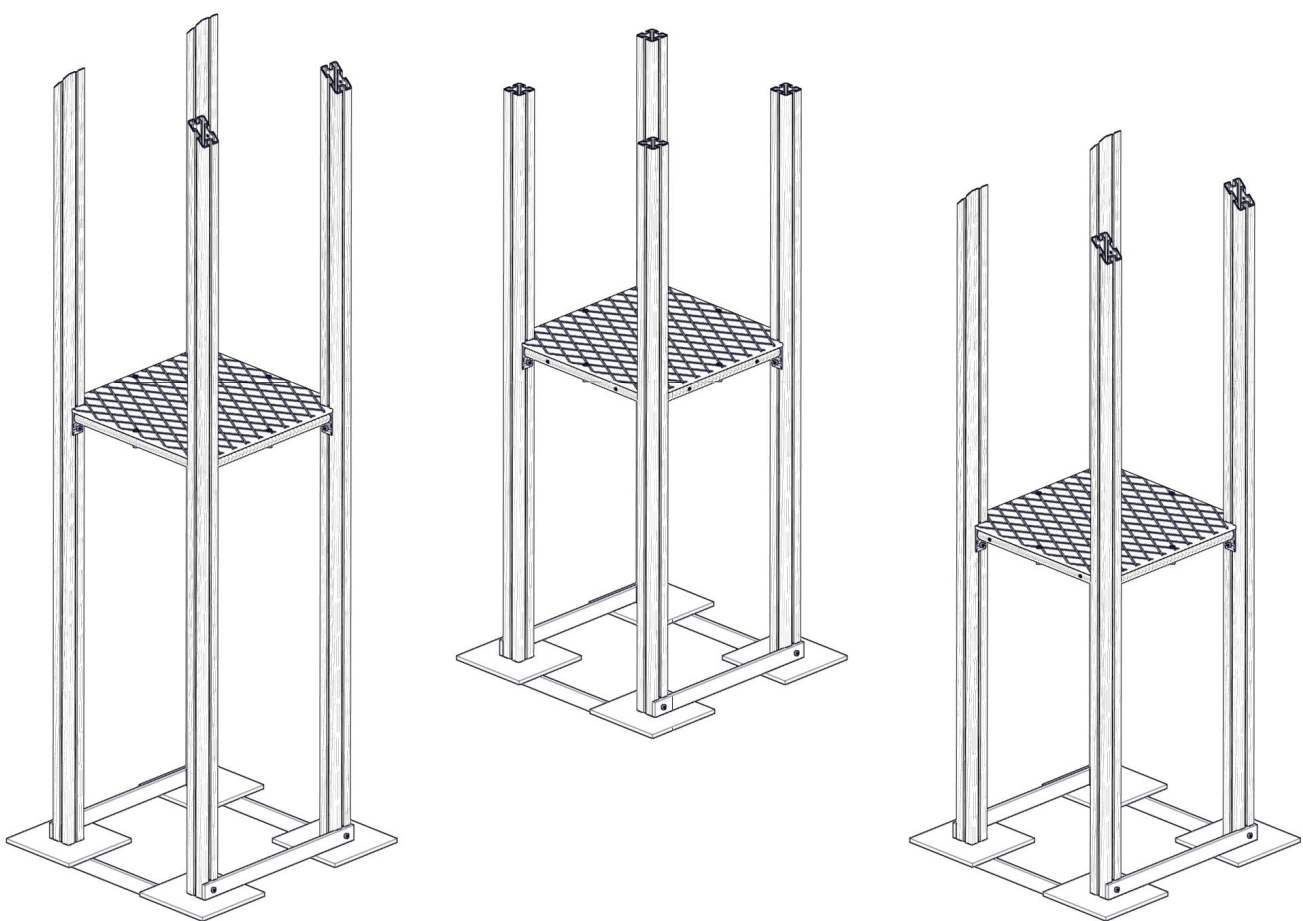
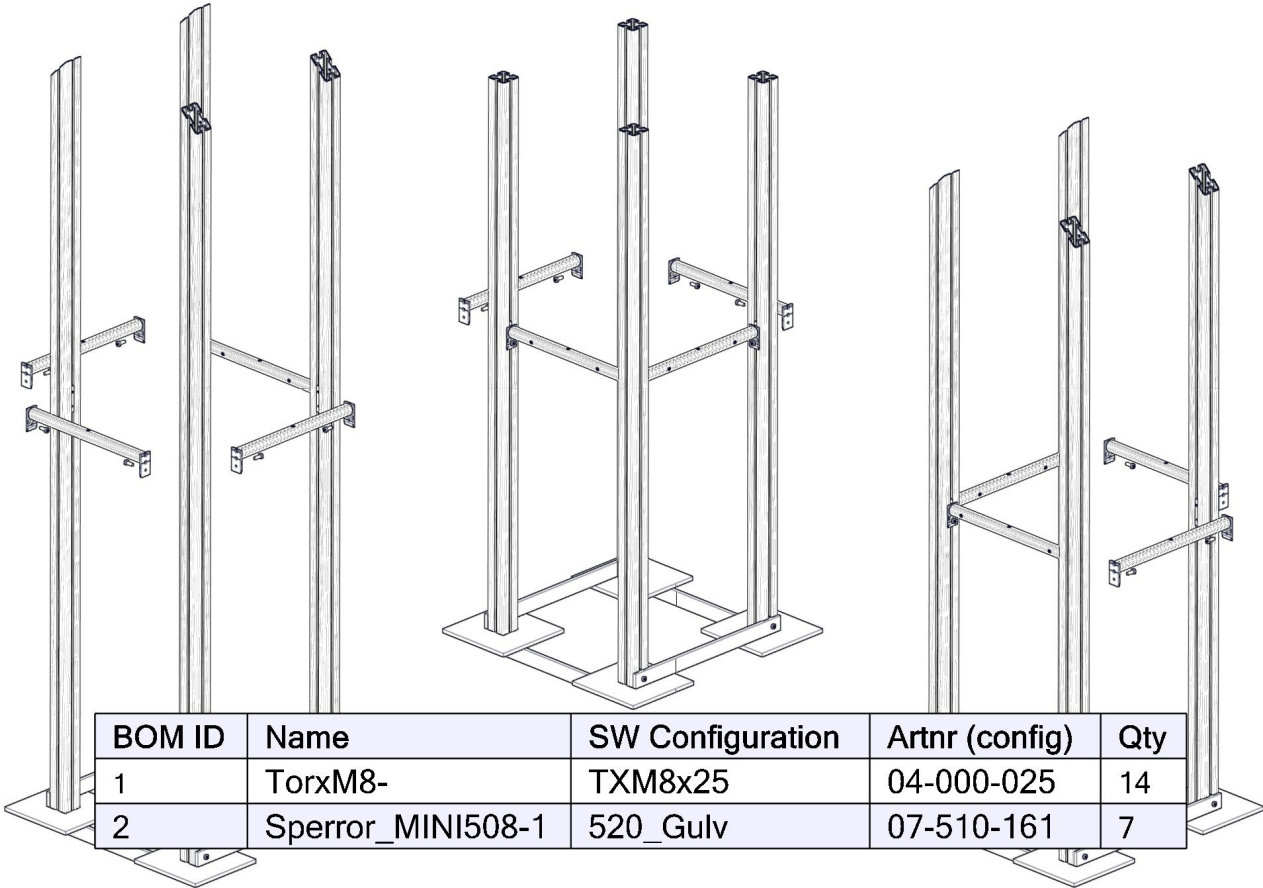

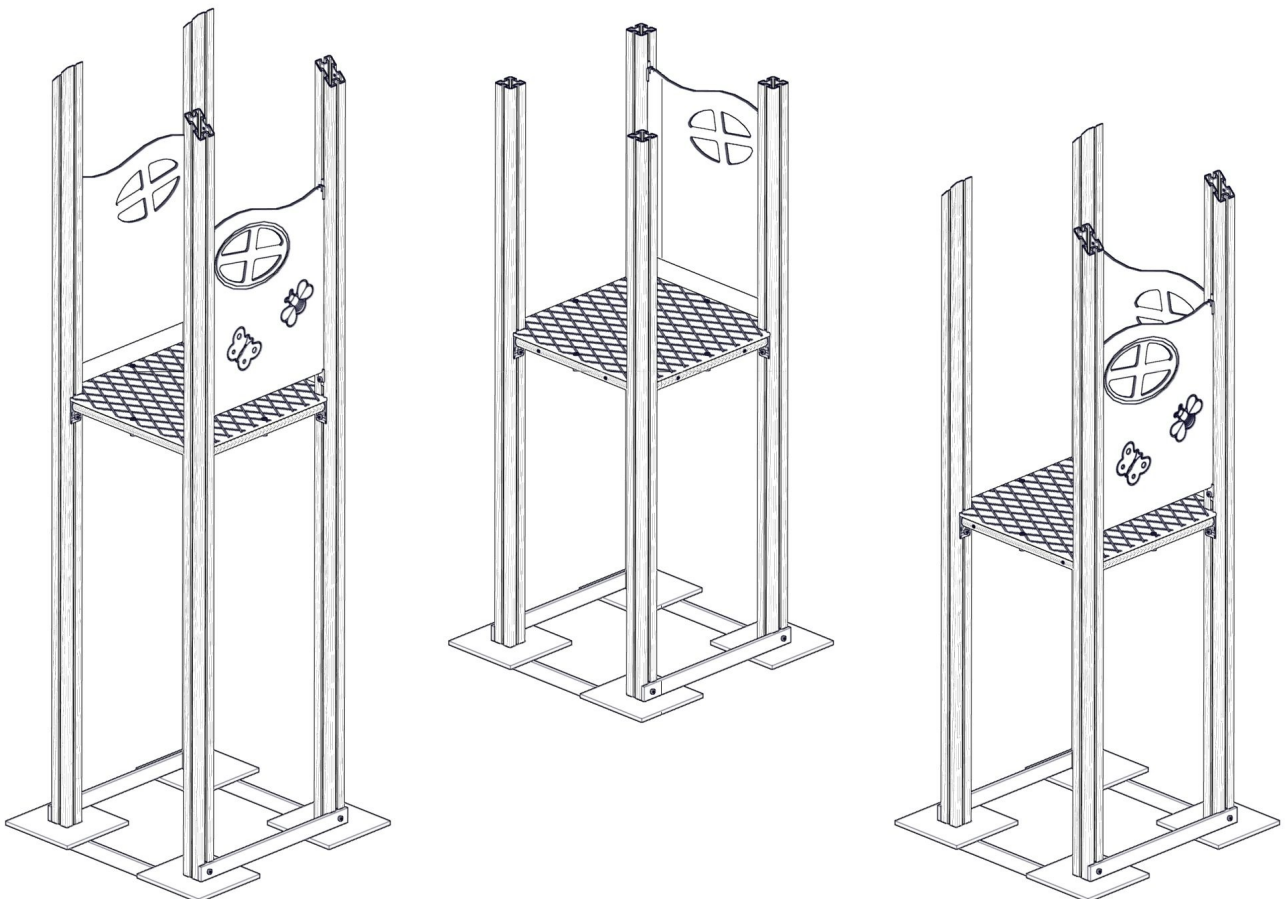
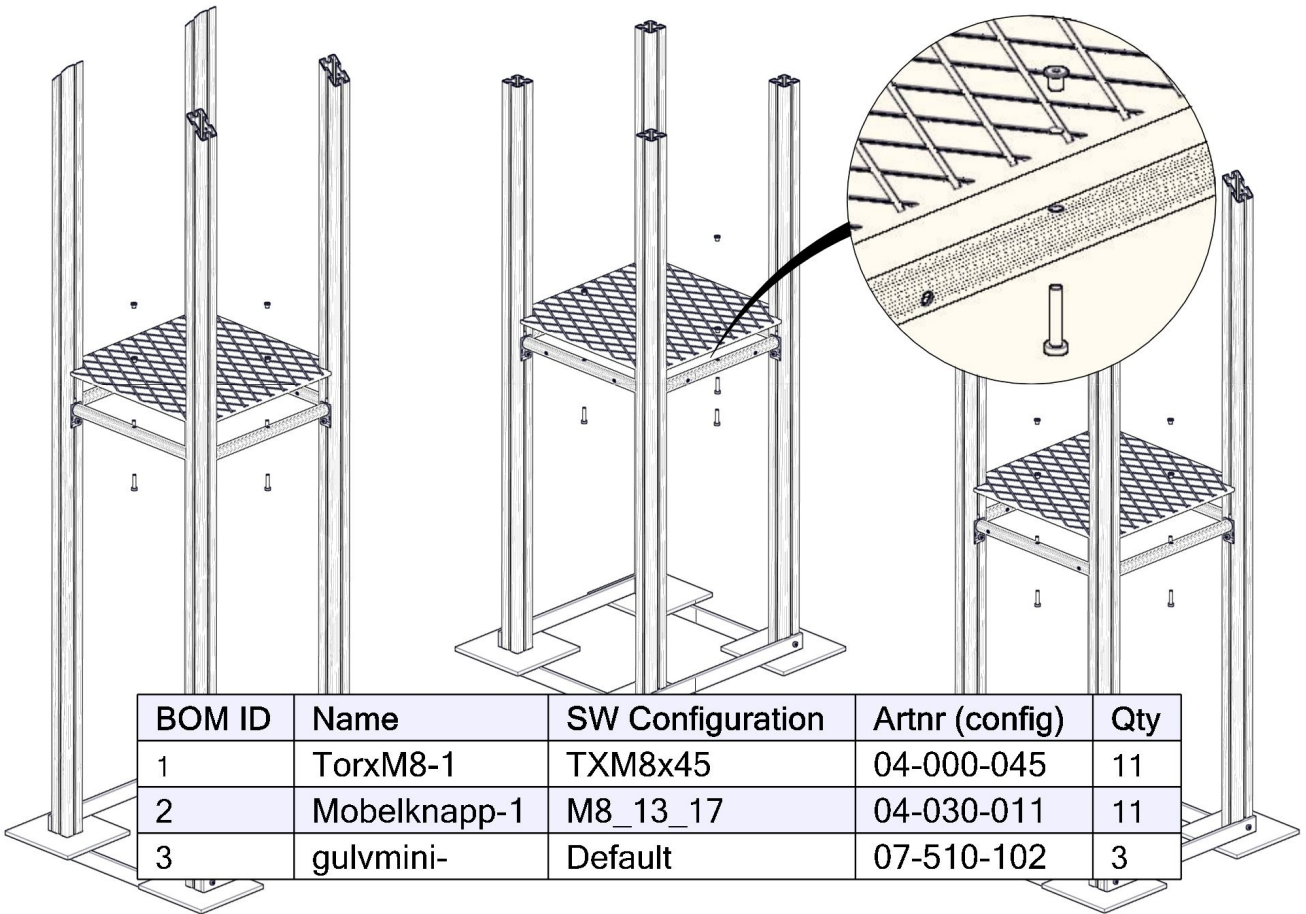

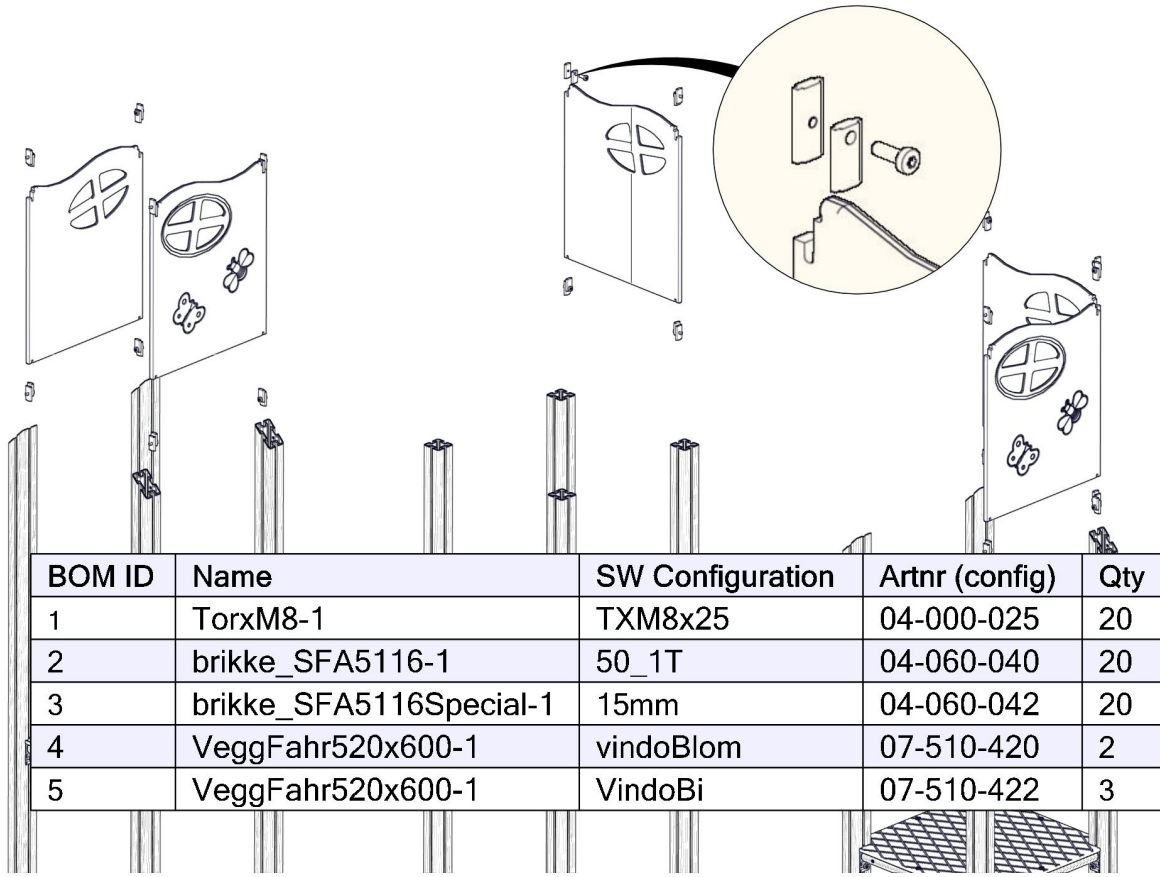

BOM ID	Name	SW Configuration	Artnr (config)	Qty
1	TorxM8-1	TXM8x25	04-000-025	20
2	brikke_SFA5116-1	50_1T	04-060-040	20
3	brikke_SFA5116Special-1	15mm	04-060-042	20
4	VeggFahr520x600-1	vindoBlom	07-510-420	2
5	VeggFahr520x600-1	VindoBi	07-510-422	3

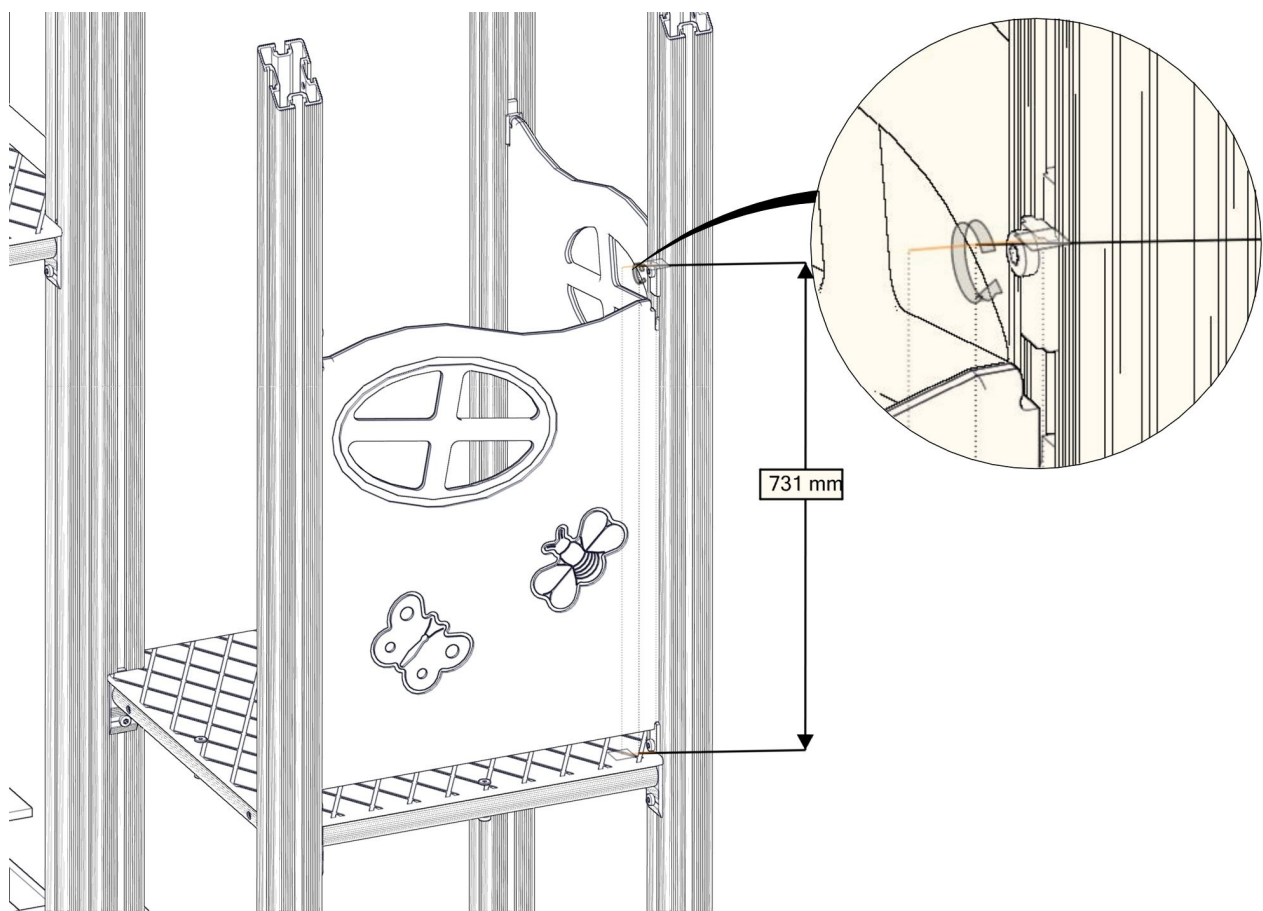

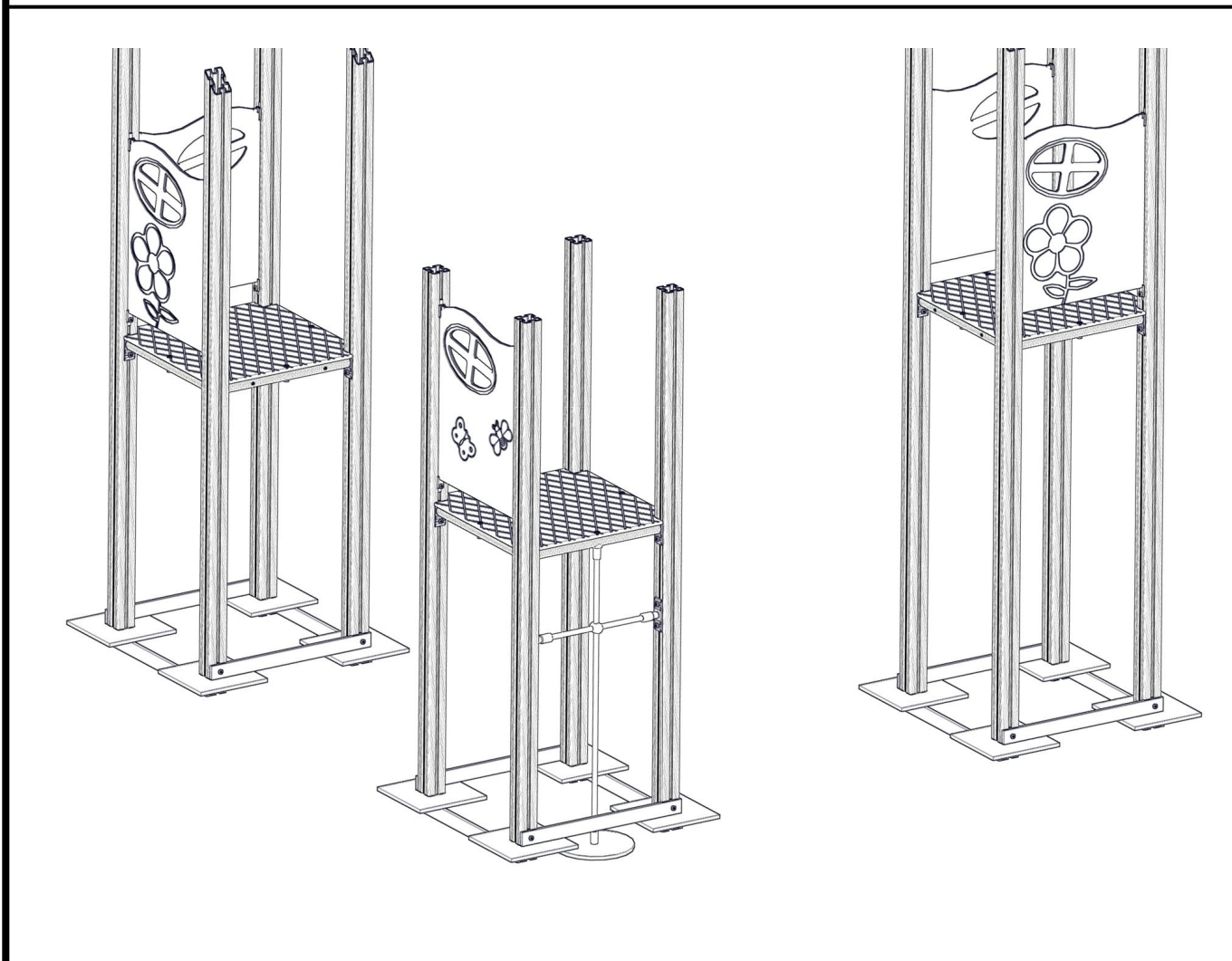
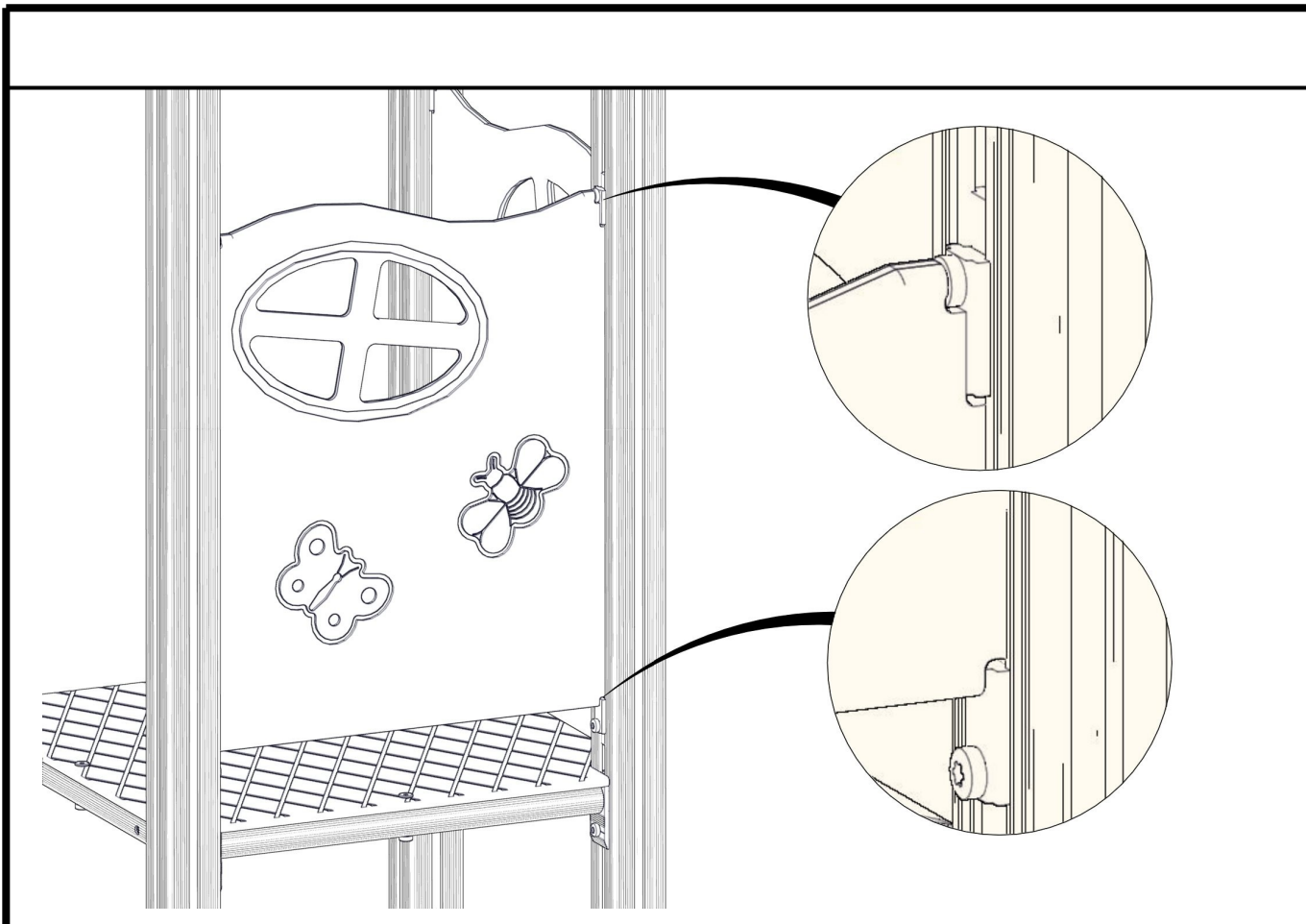

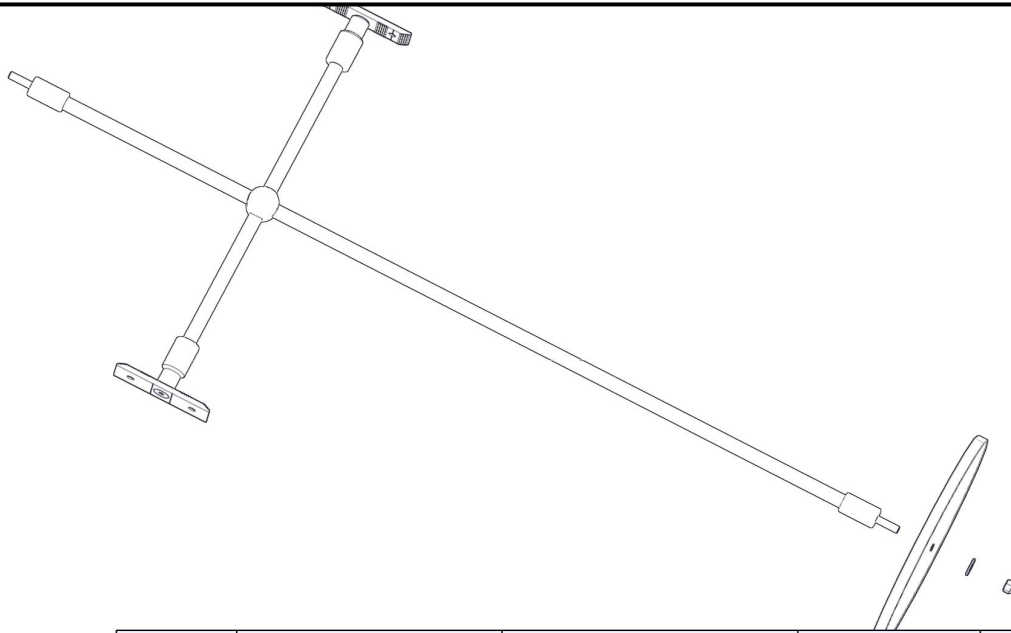

BOM ID	Name	SW Configuration	Artnr (config)	Qty
1	Fundament_platte-1	Default	00-003-103	1
2	mutter_M8-1	M8_Borg	04-040-008	1
3	Skive-1	M8_stor	04-055-008	1
4	Trepp550-1	Default<As Machined>	07-510-177	1

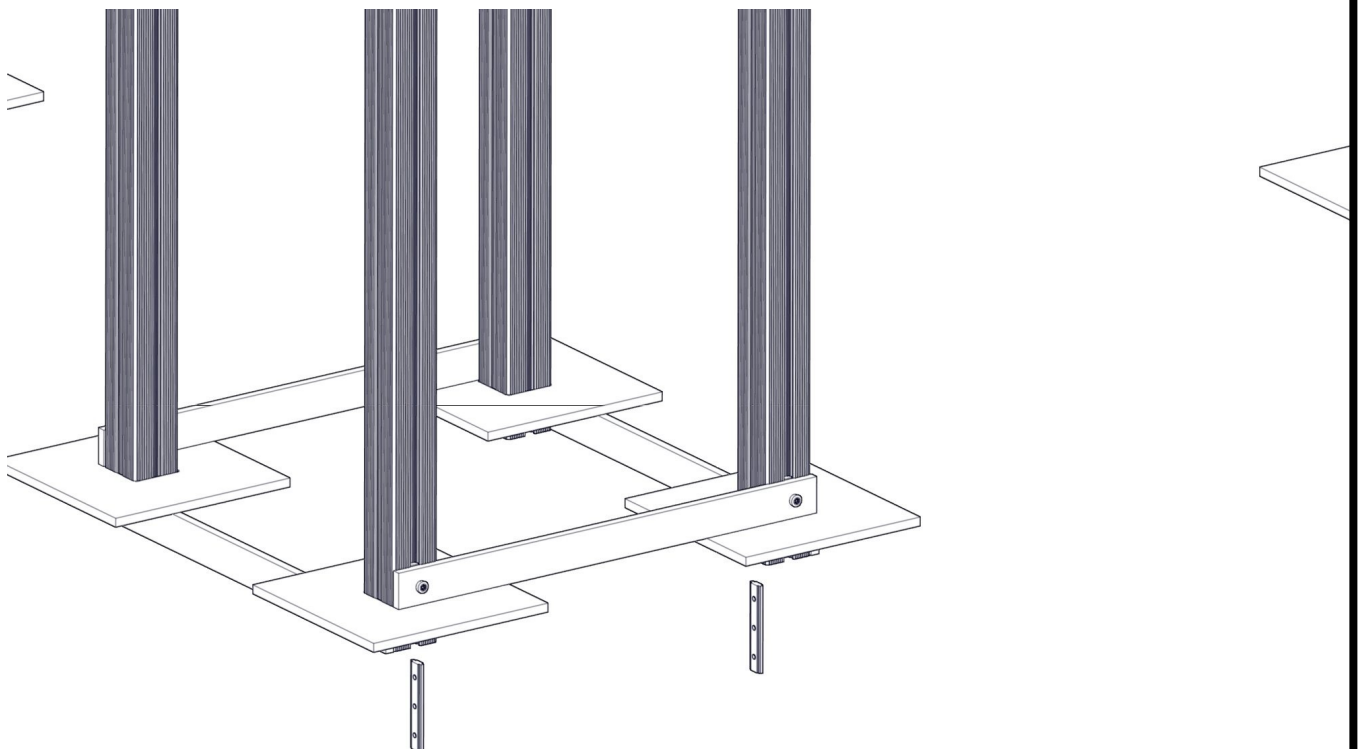

BOM ID	Name	SW Configuration	Artnr (config)	Qty
1	brikke_SFA5116-	120_2T	04-060-120	2

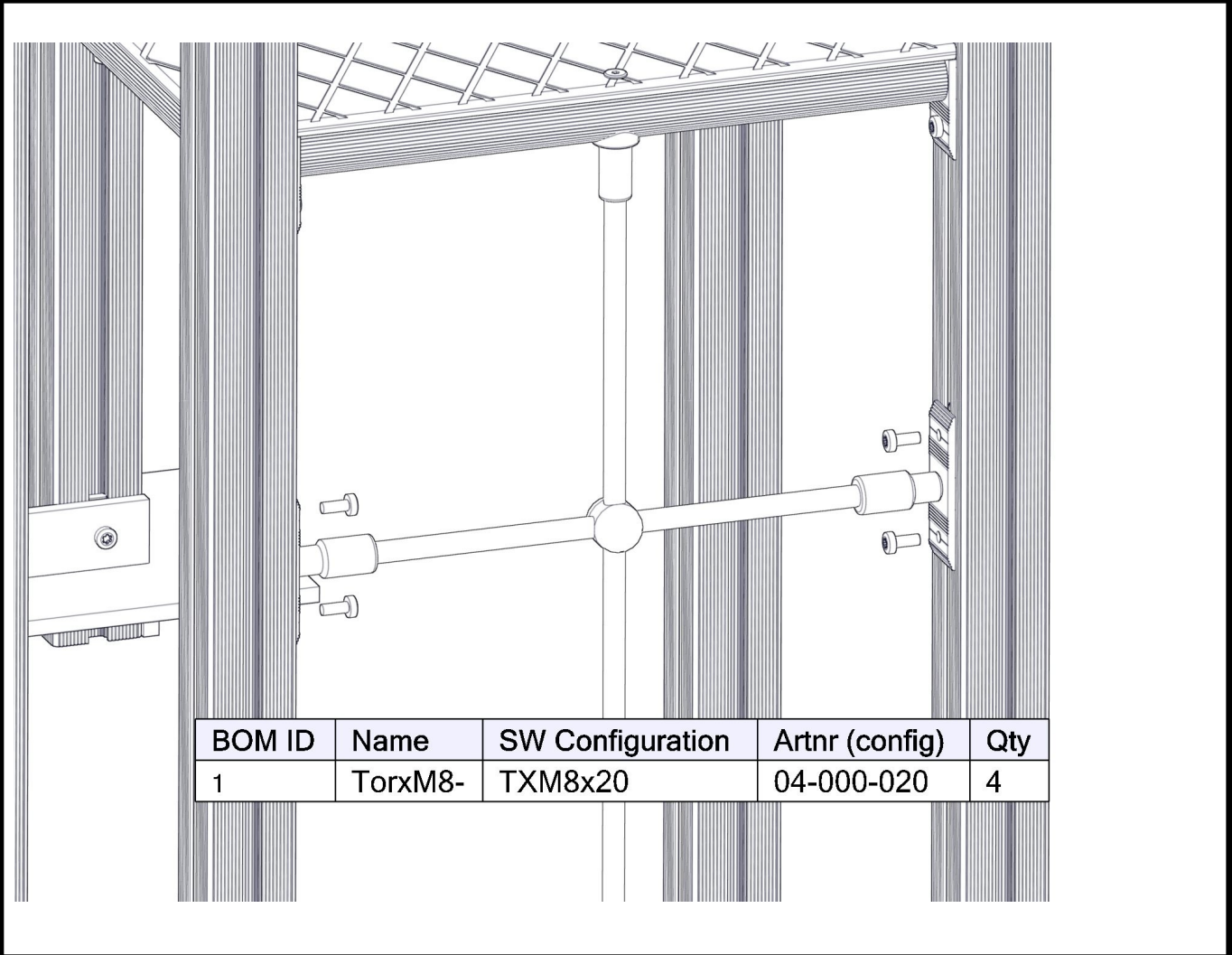
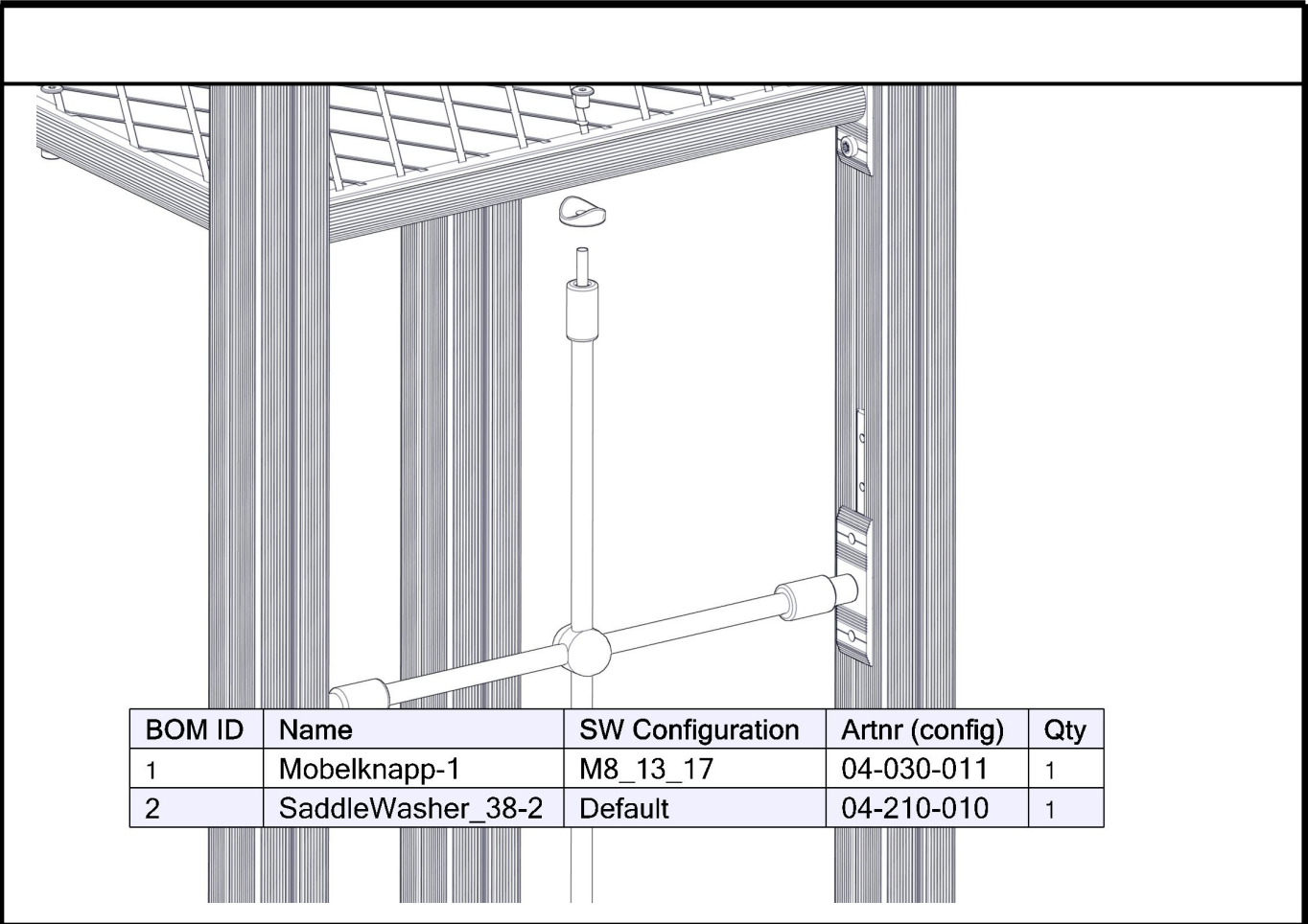

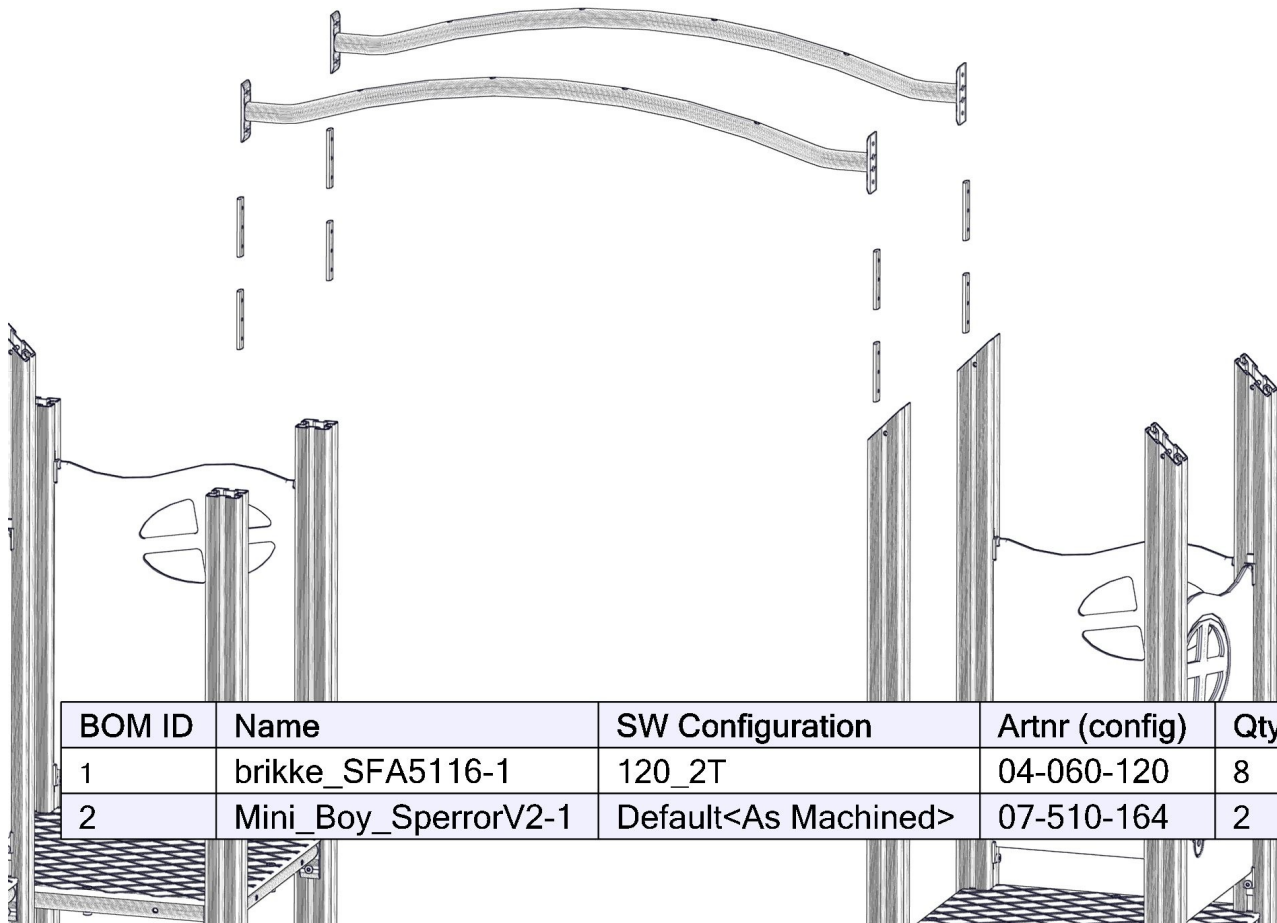

BOM ID	Name	SW Configuration	Artnr (config)	Qty
1	brikke_SFA5116-1	120_2T	04-060-120	8
2	Mini_Boy_SperrorV2-1	Default<As Machined>	07-510-164	2

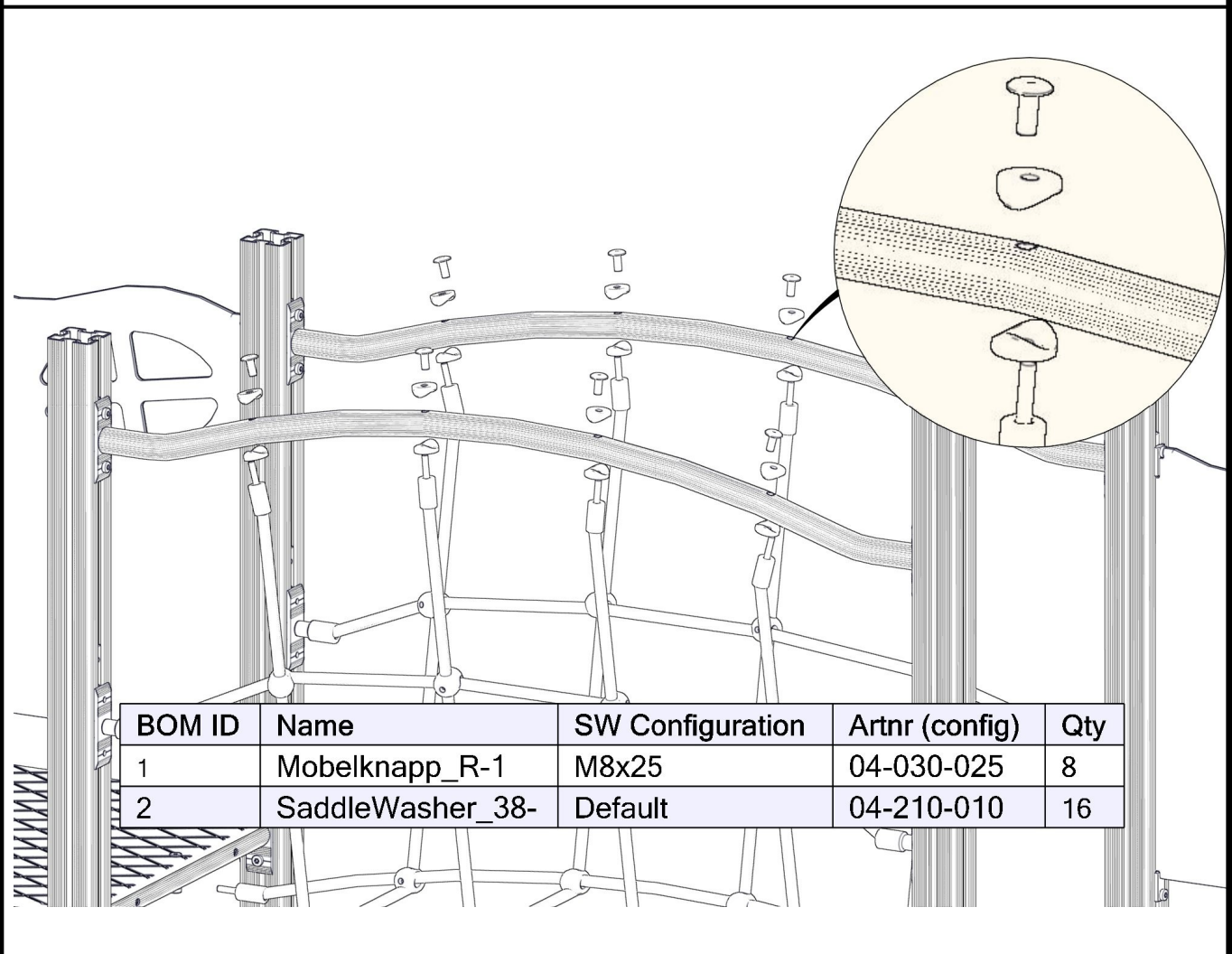
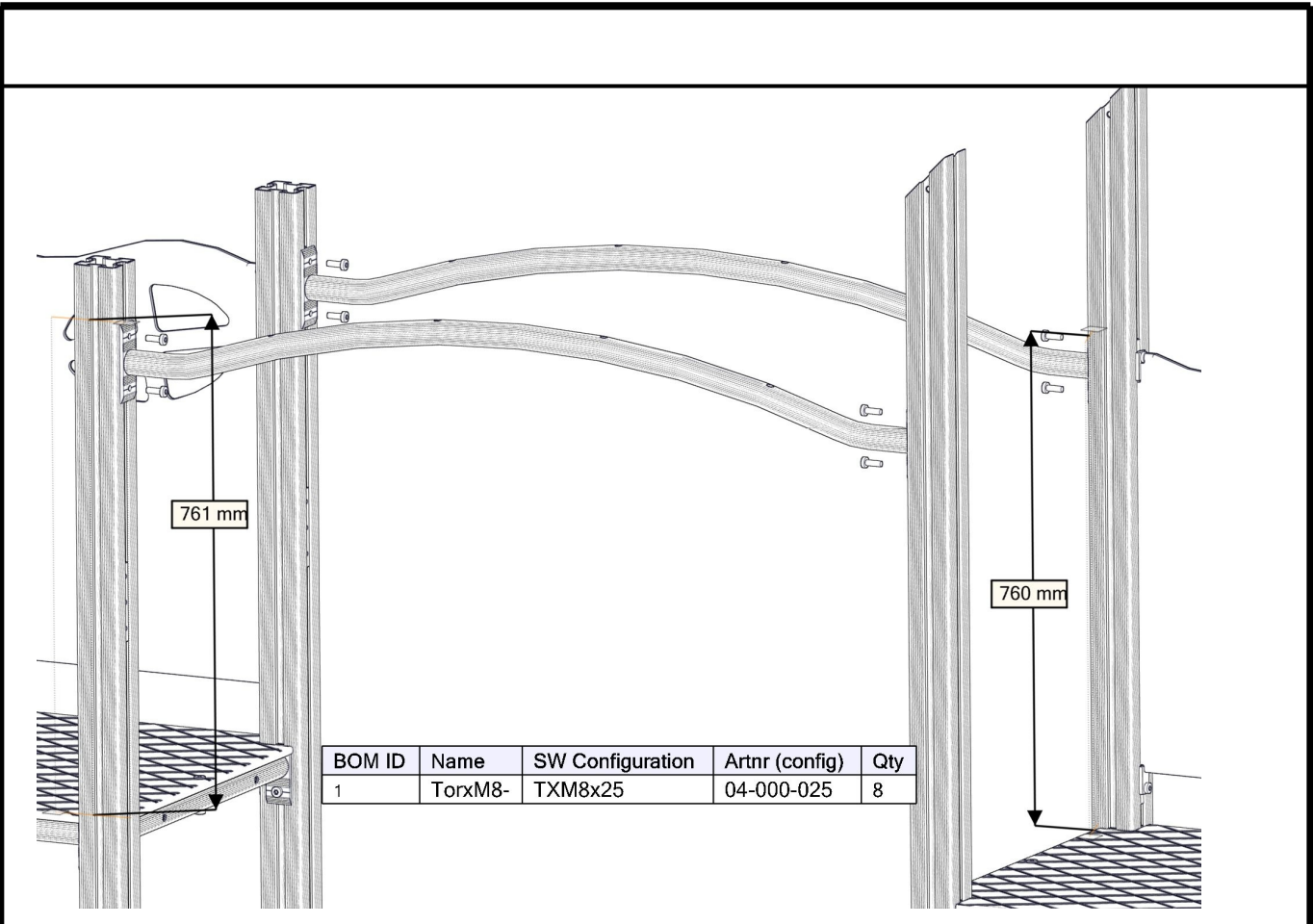

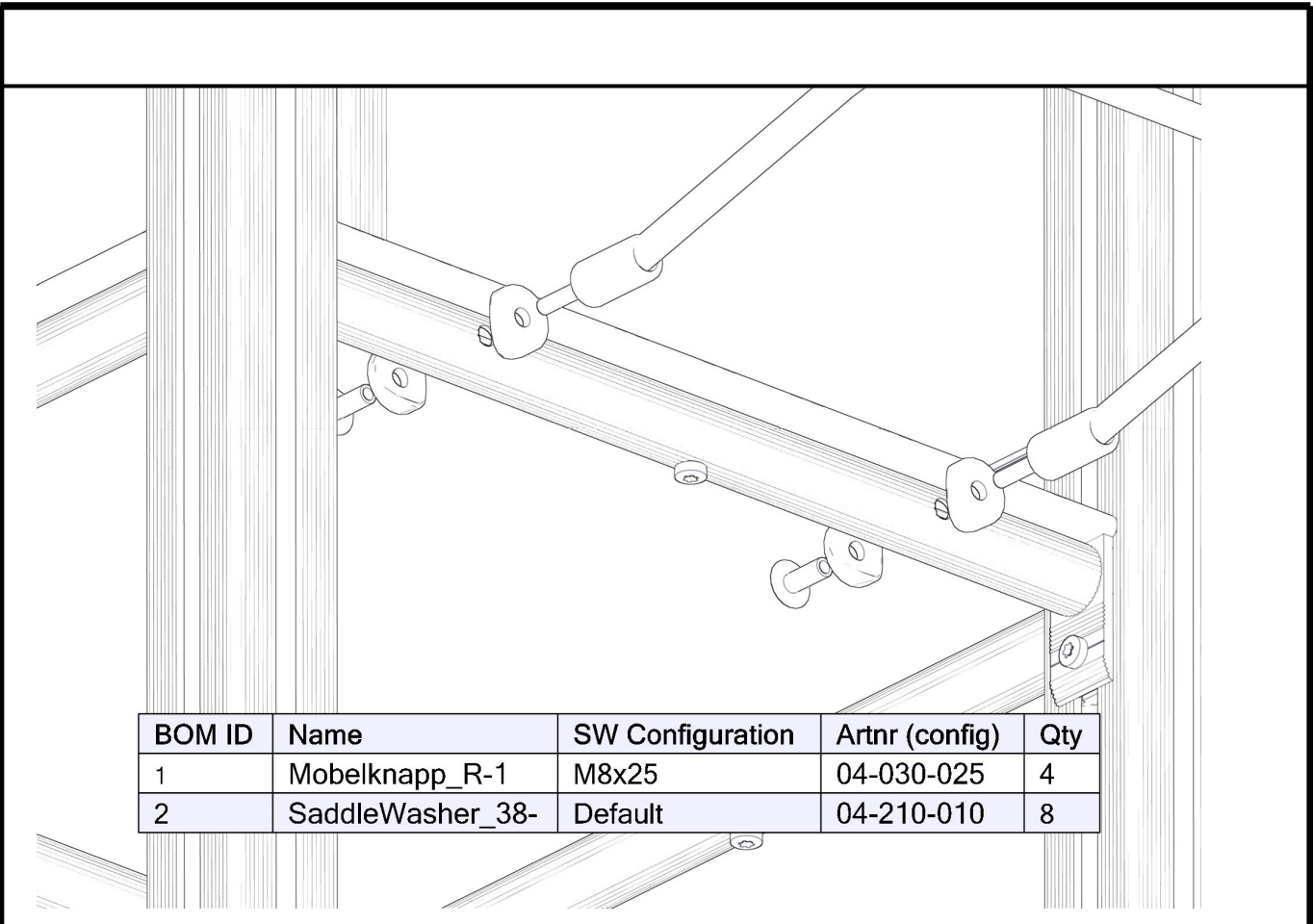

BOM ID	Name	SW Configuration	Artnr (config)	Qty
1	Mobelknapp_R-1	M8x25	04-030-025	4
2	SaddleWasher_38-	Default	04-210-010	8

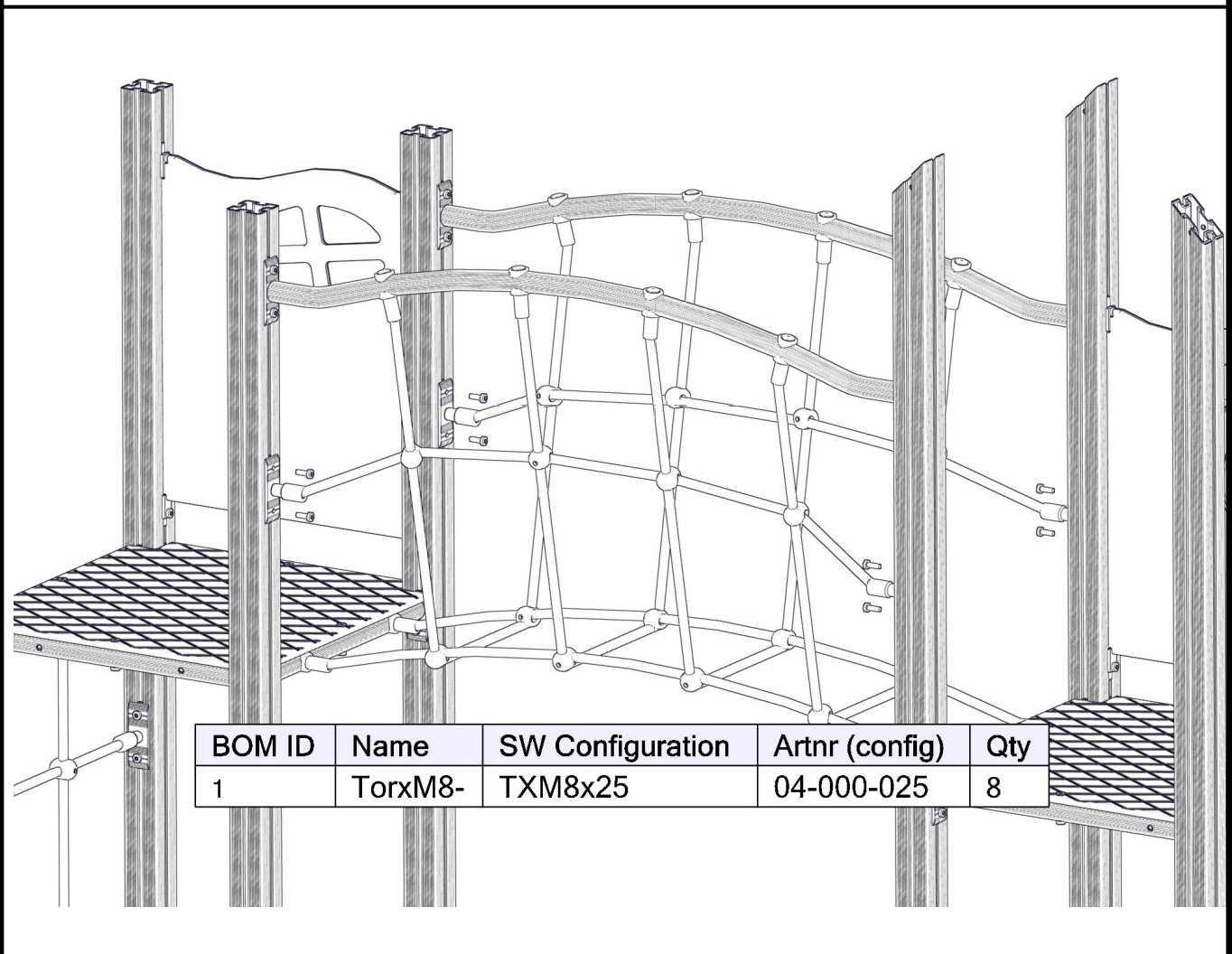

BOM ID	Name	SW Configuration	Artnr (config)	Qty
1	Torxm8-	TXM8x25	04-000-025	8

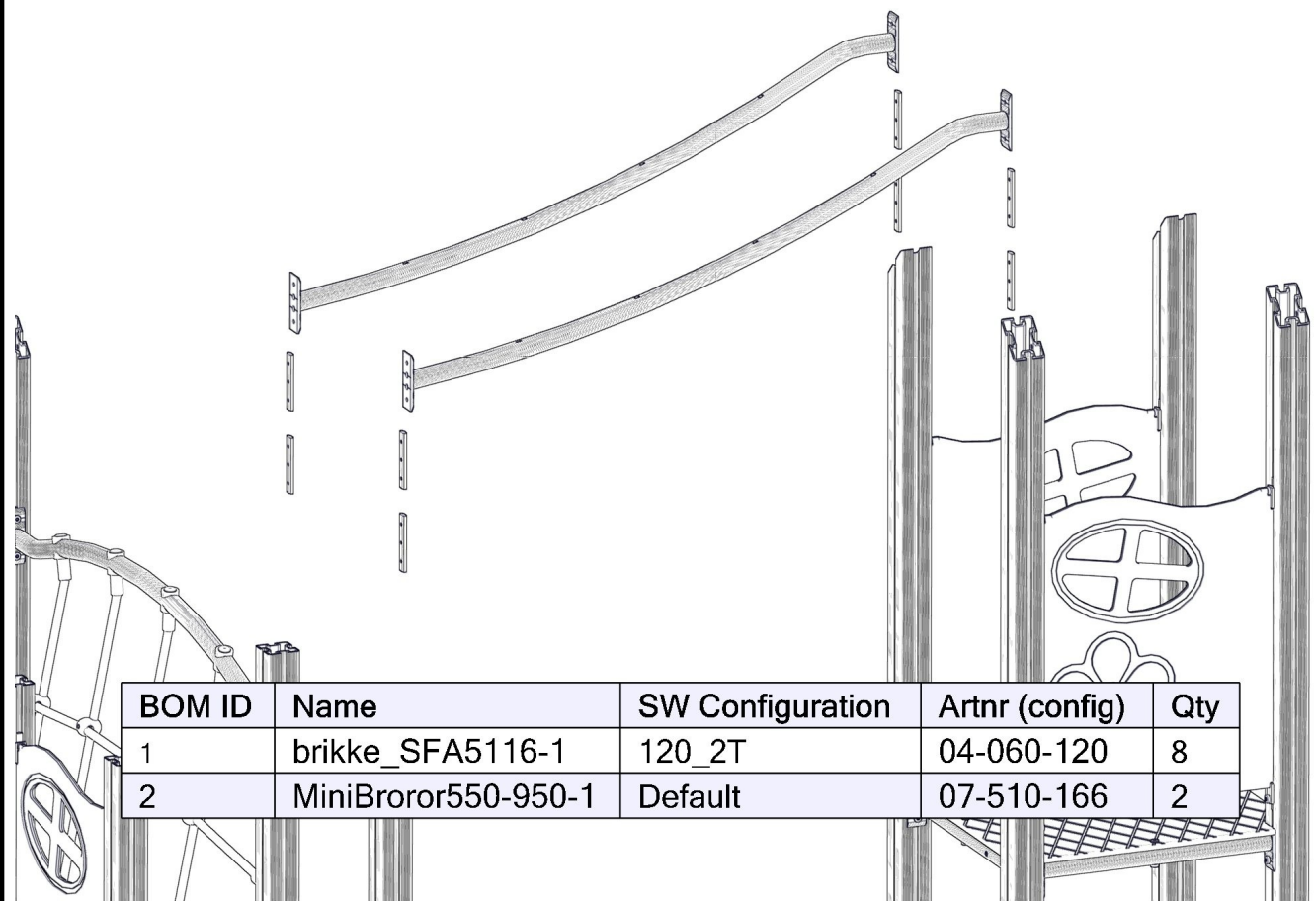

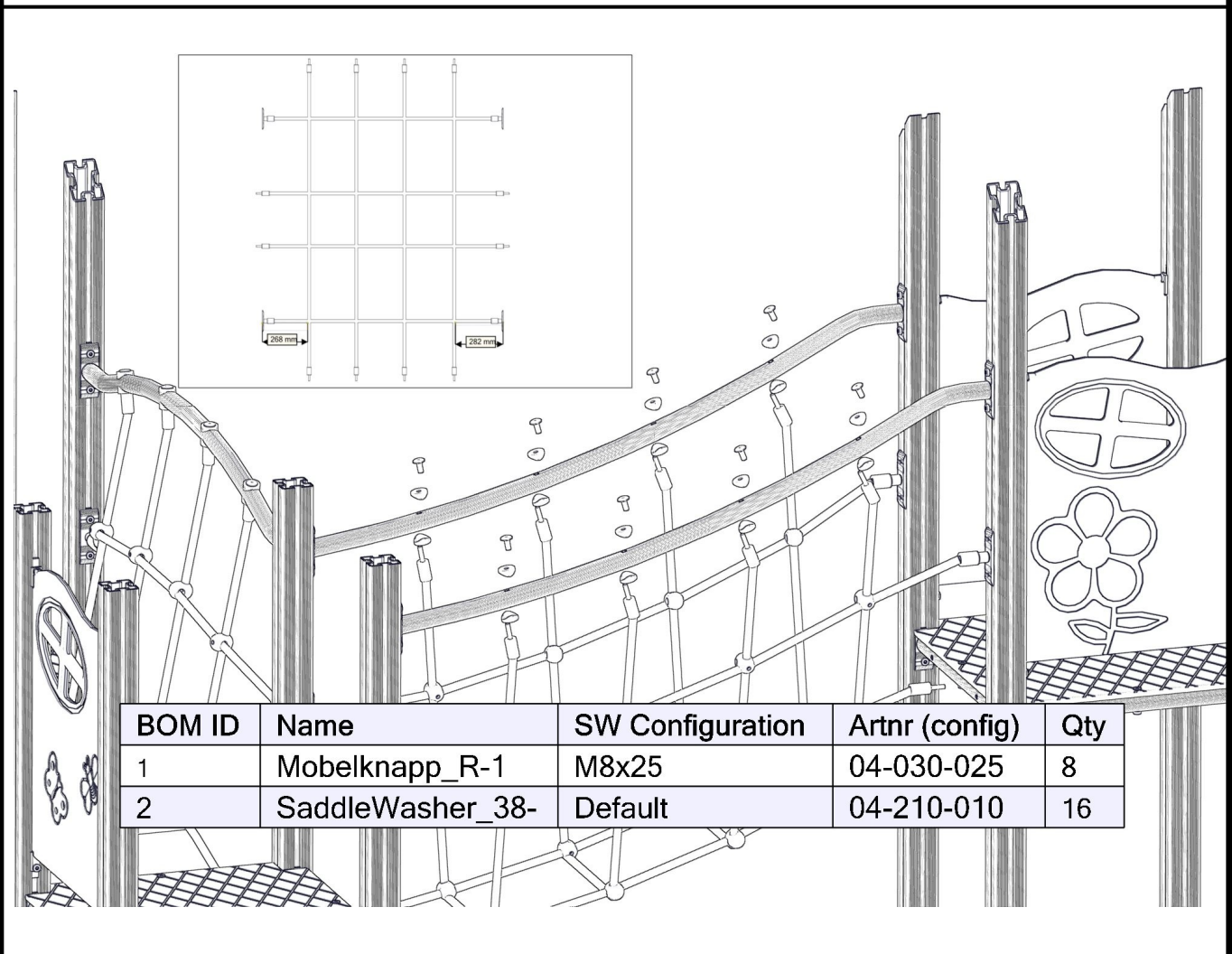
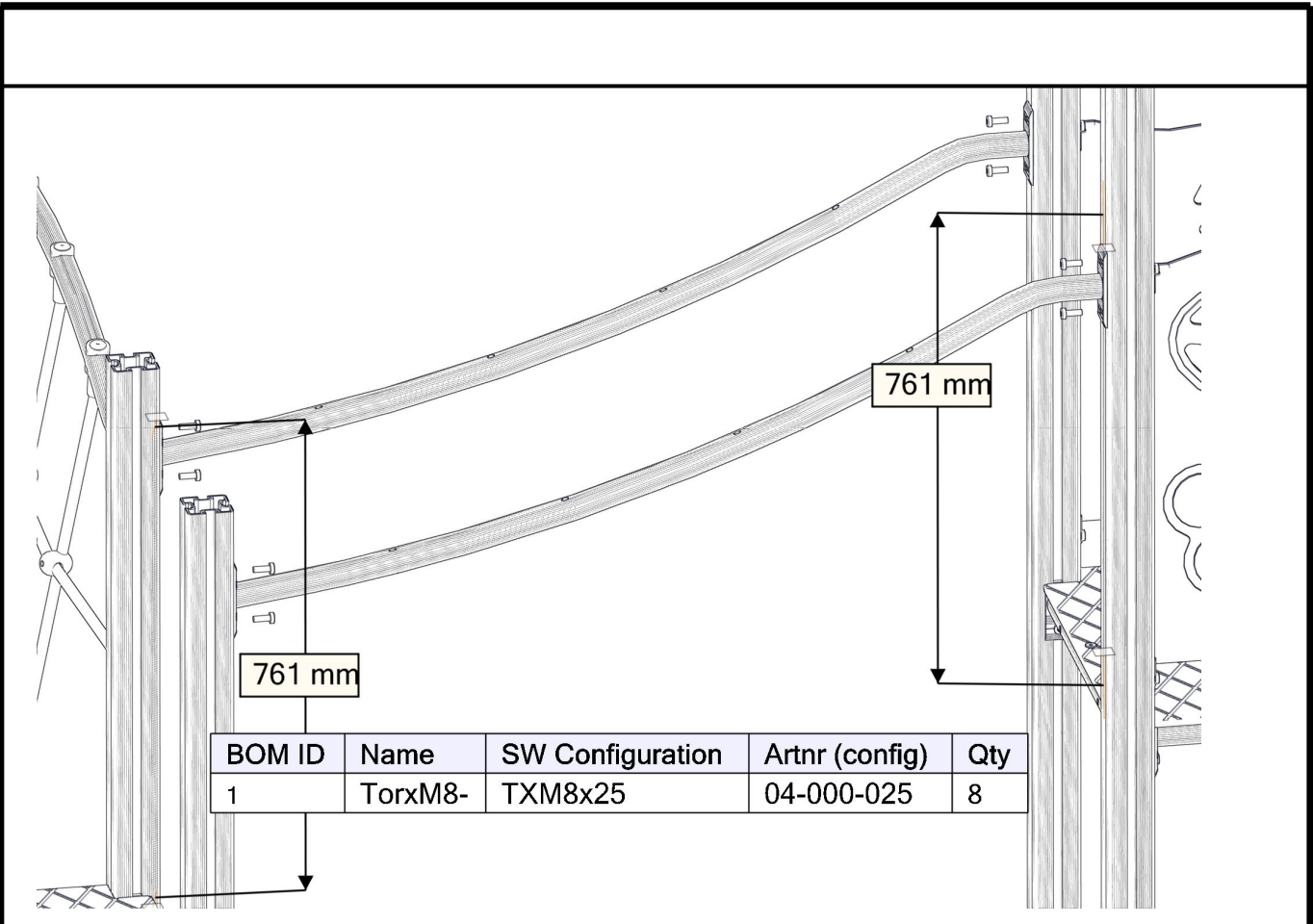

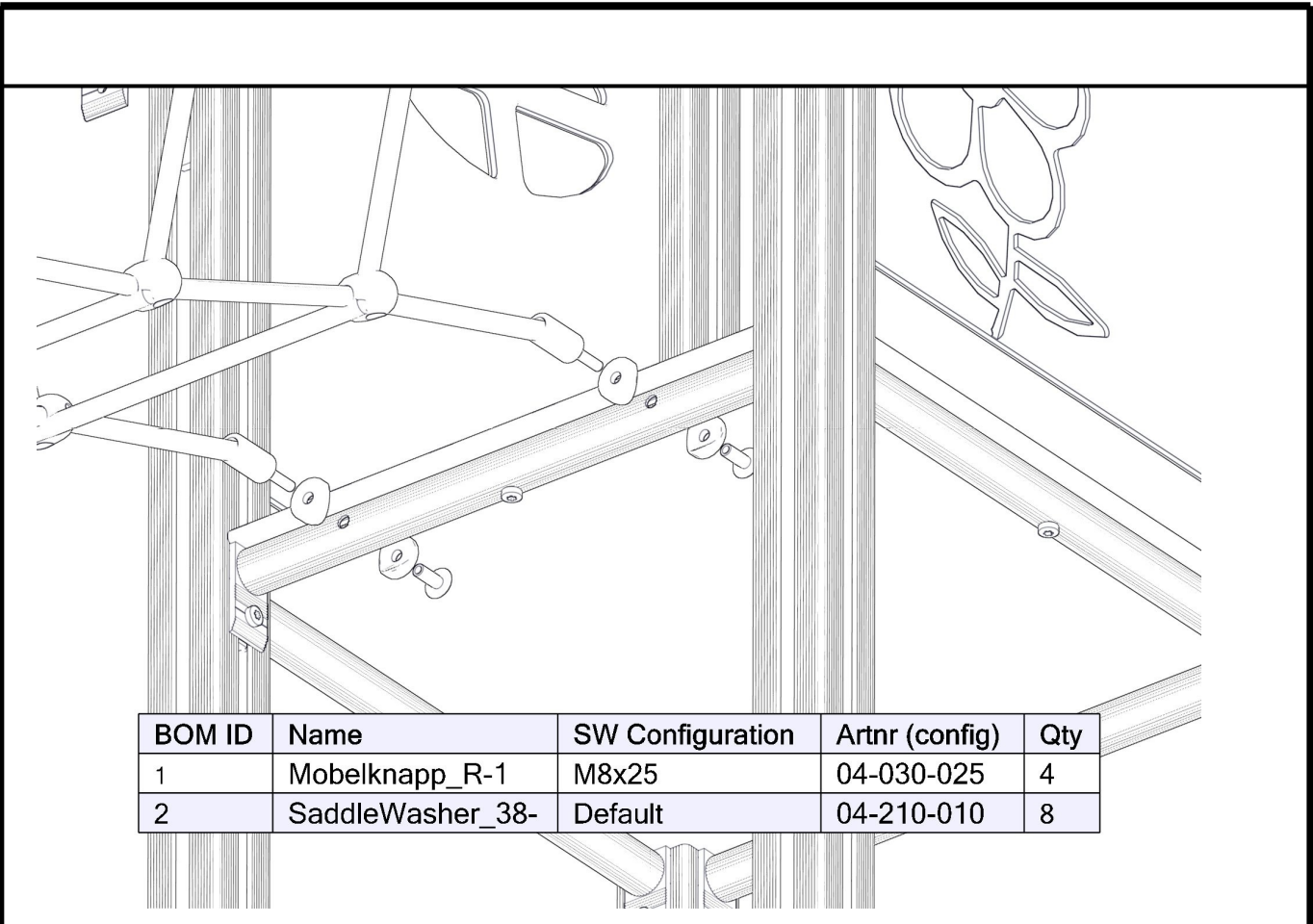

BOM ID	Name	SW Configuration	Artnr (config)	Qty
1	Mobelknapp_R-1	M8x25	04-030-025	4
2	SaddleWasher_38-	Default	04-210-010	8

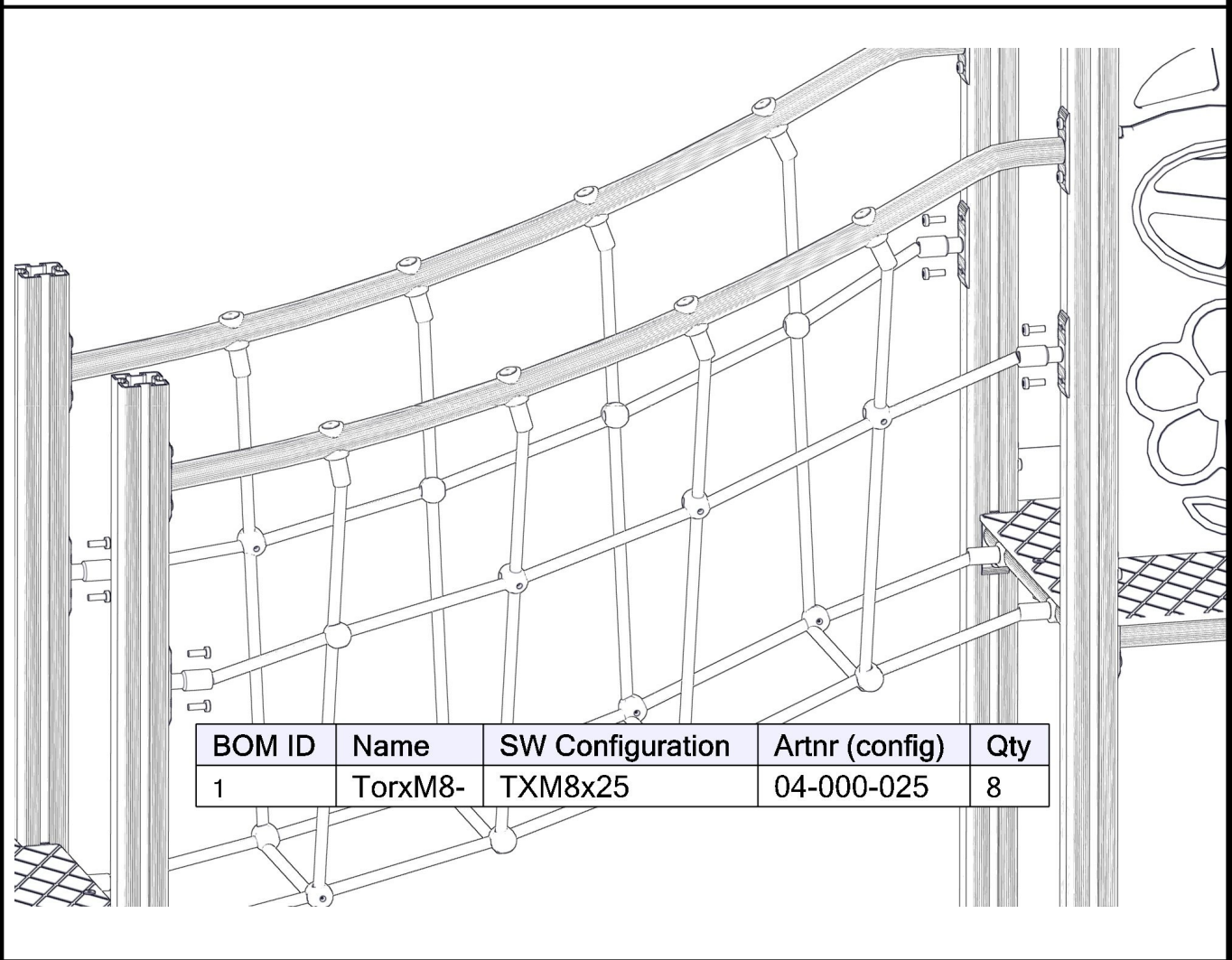

BOM ID	Name	SW Configuration	Artnr (config)	Qty
1	Torxm8-	TXM8x25	04-000-025	8

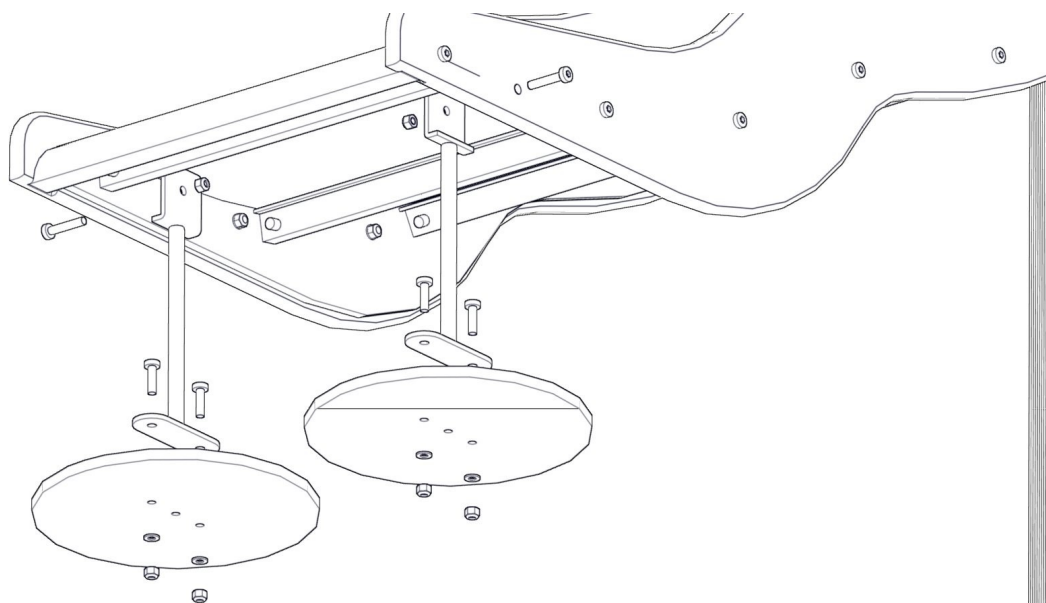
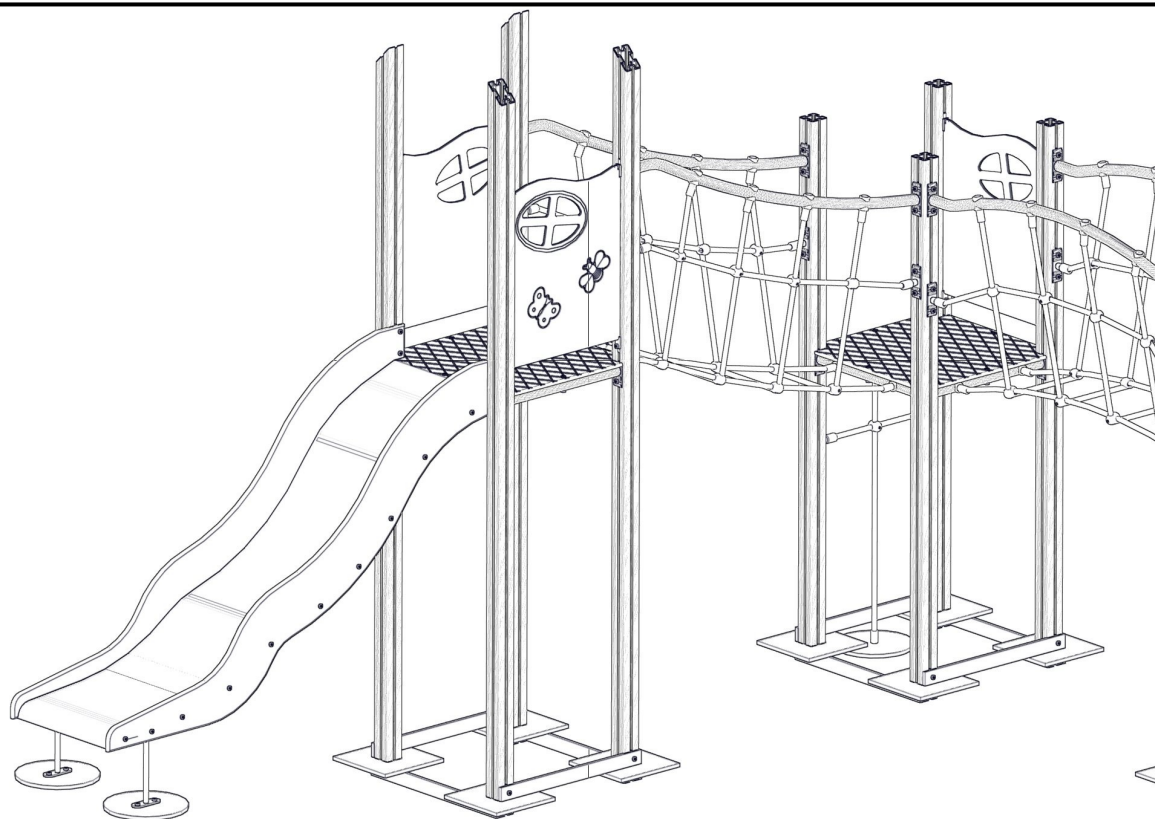

BOM ID	Name	SW Configuration	Artnr (config)	Qty
1	Fundament_platte_2H-	Hoh80	00-003-106	2
2	Steun-	liten	00-100-310	2
3	TorxM8-1	TXM8x30	04-000-030	4
4	TorxM8-	TXM8x45	04-000-045	2
5	mutter_M8-	M8_Borg	04-040-008	6
6	Skive-1	M8	04-050-008	4

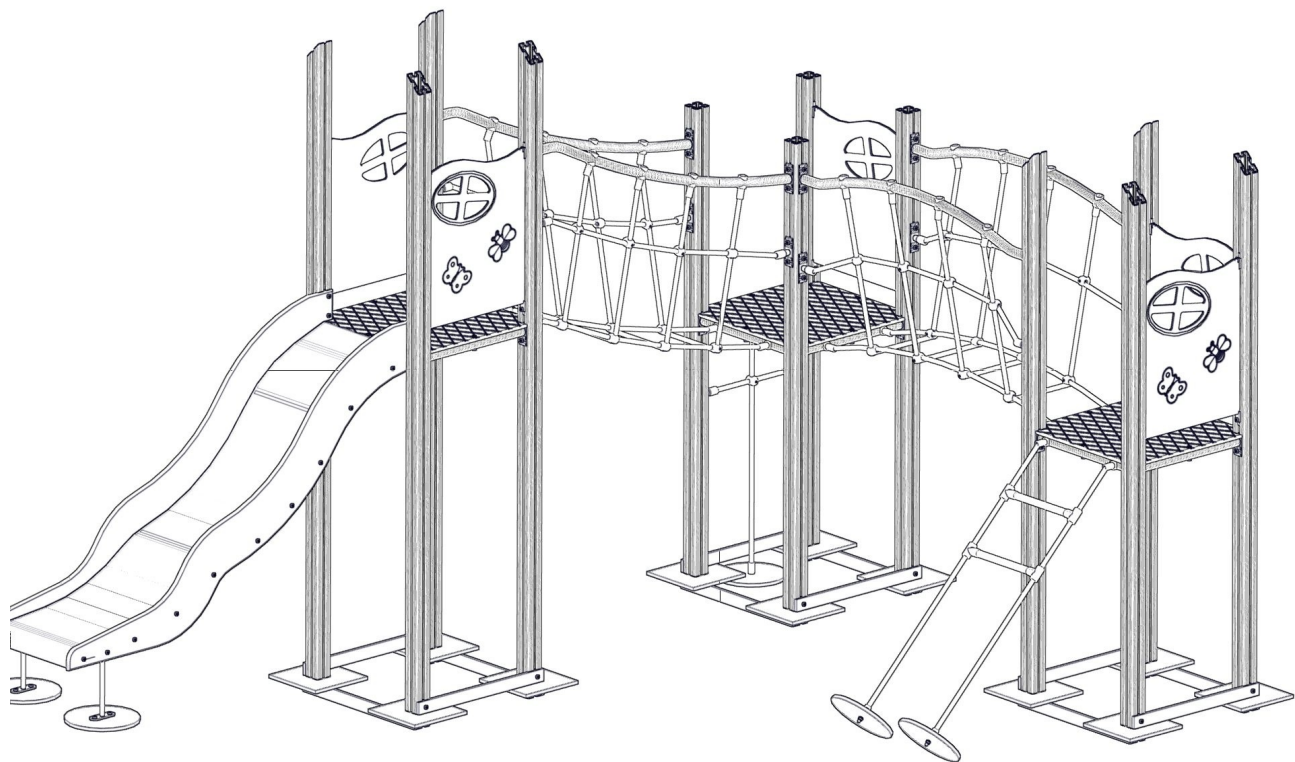
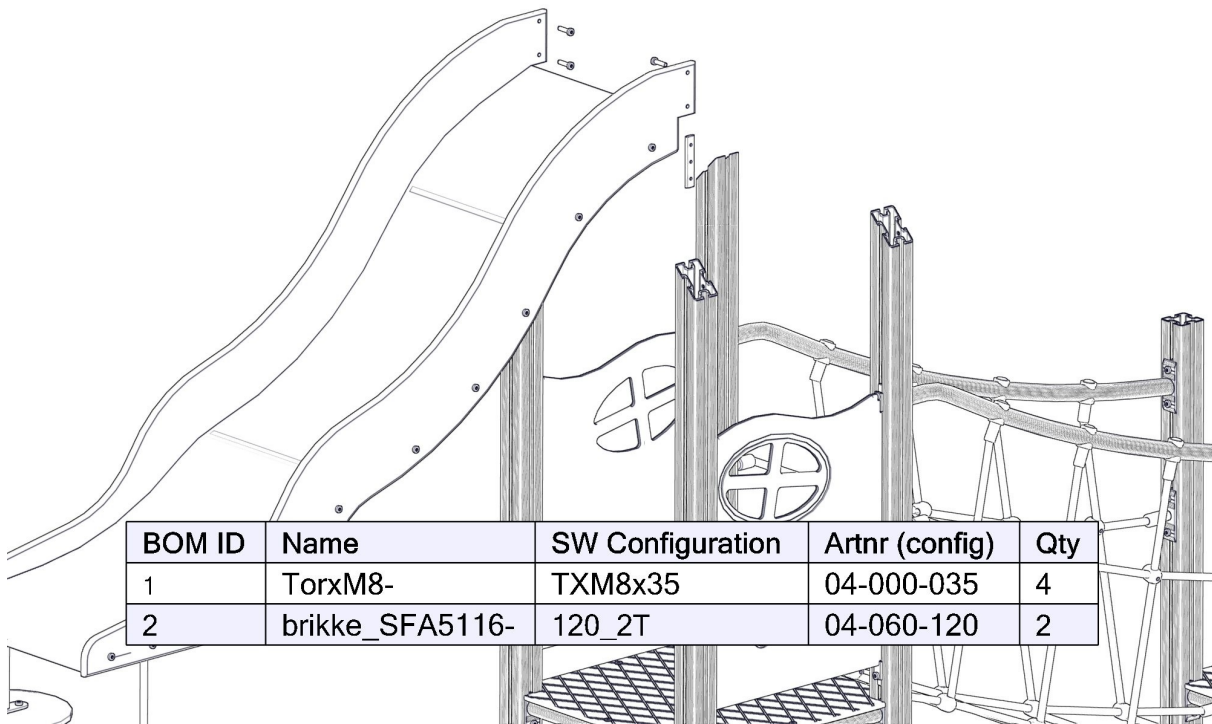

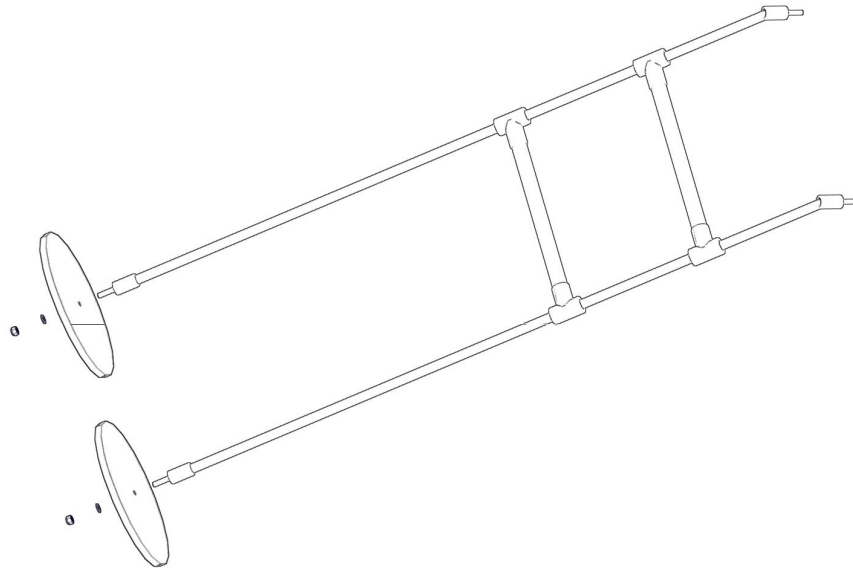

BOM ID	Name	SW Configuration	Artnr (config)	Qty
1	Fundament_platte-	Default	00-003-103	2
2	mutter_M8-	M8_Borg	04-040-008	2
3	Skive-	M8	04-050-008	2
4	RungTauV2-1	Default<As Machined>	07-510-170	1

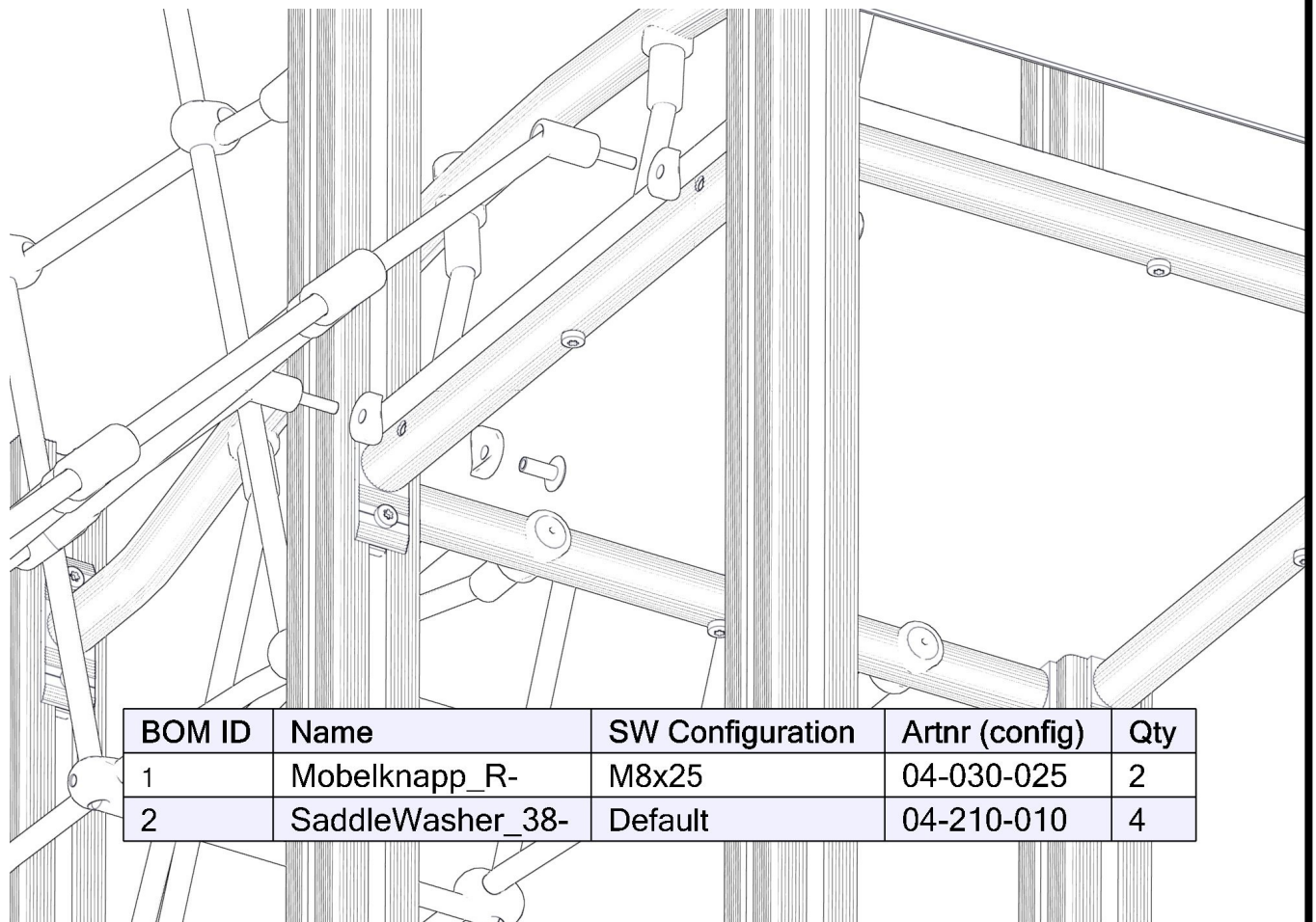

BOM ID	Name	SW Configuration	Artnr (config)	Qty
1	Mobelknapp_R-	M8x25	04-030-025	2
2	SaddleWasher_38-	Default	04-210-010	4

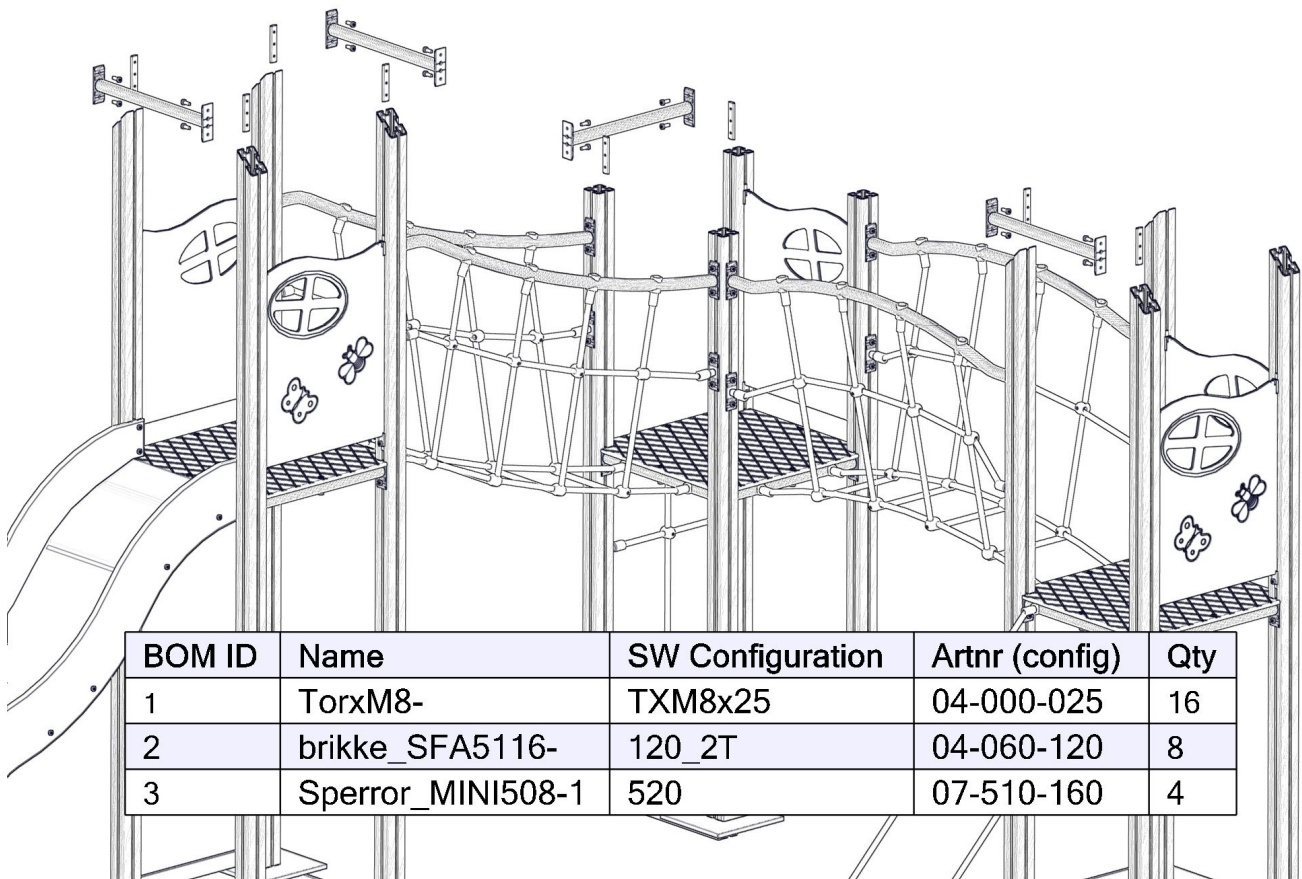

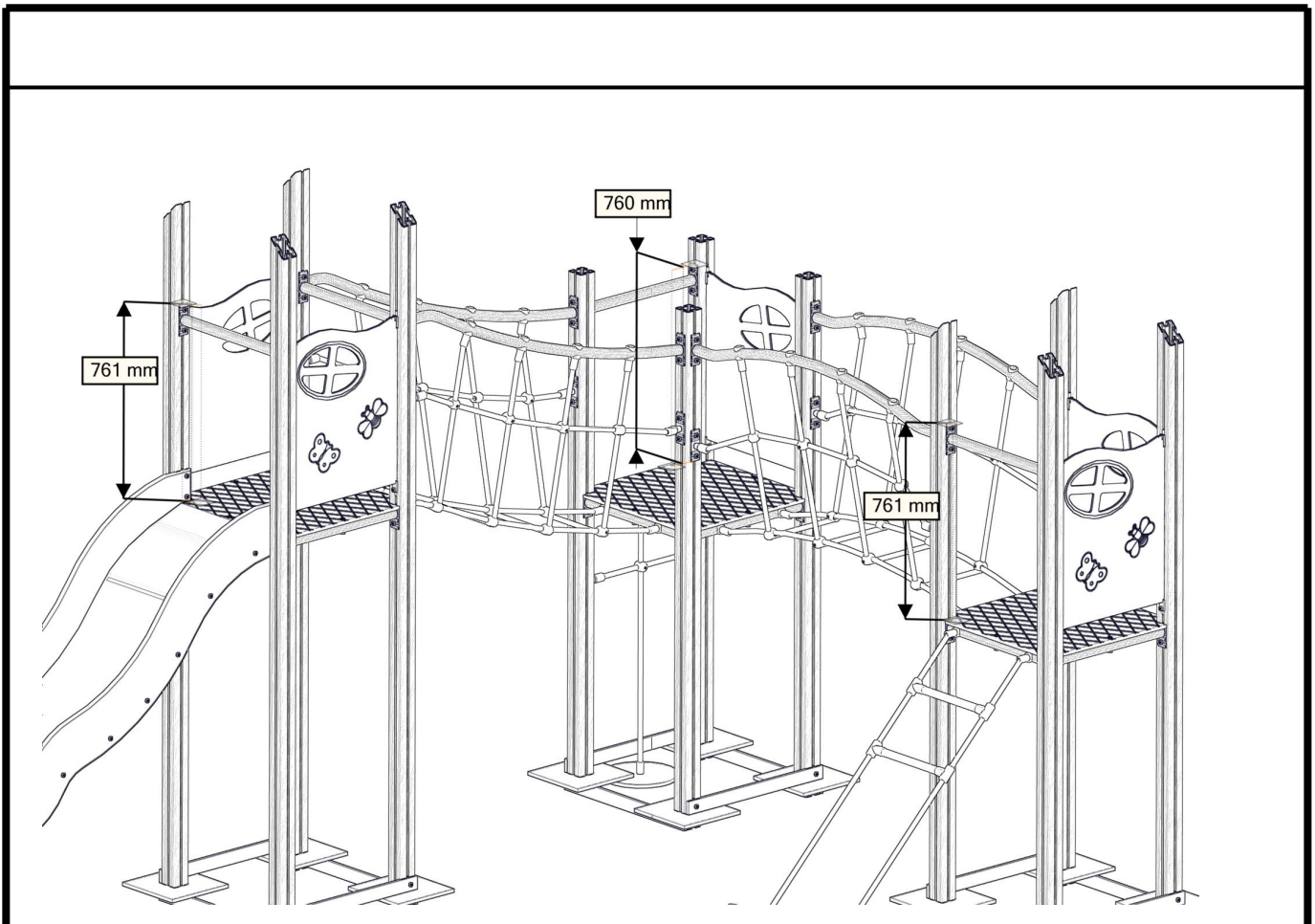

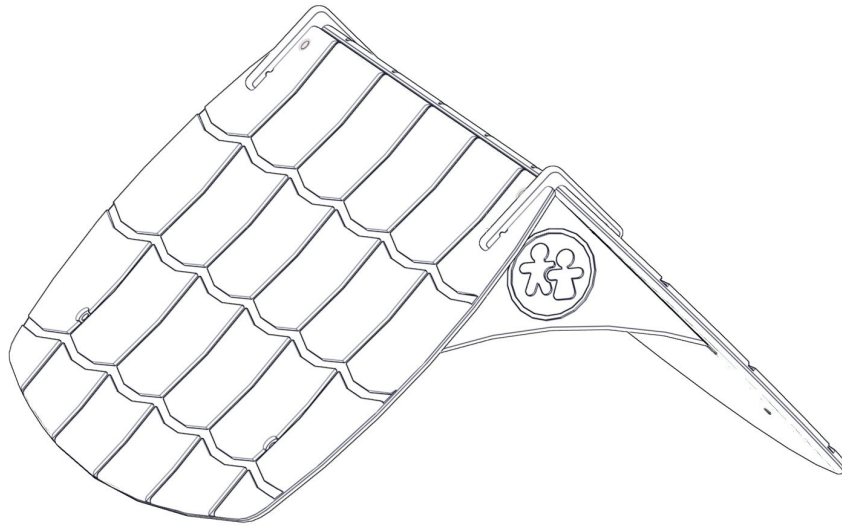

2x

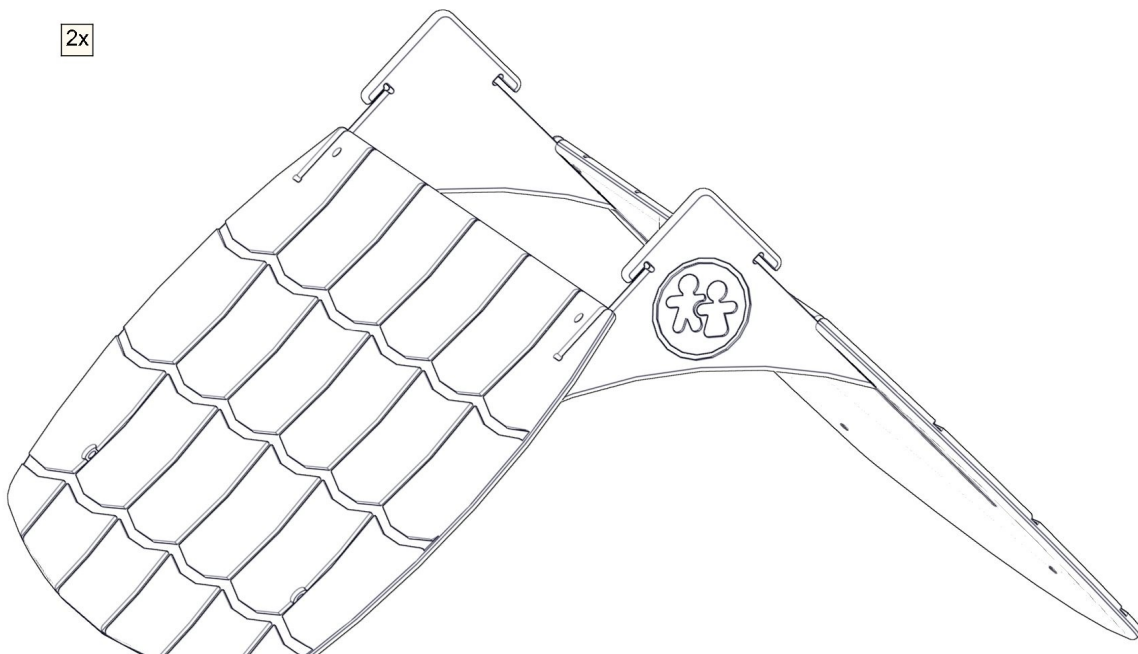

BOM ID	Name	SW Configuration	Artnr (config)	Qty
1	TakFahr_Miniserie2011-	STD	07-510-405	2
2	GavelplateFahrMini2011-	HPL_gul	07-510-406	2

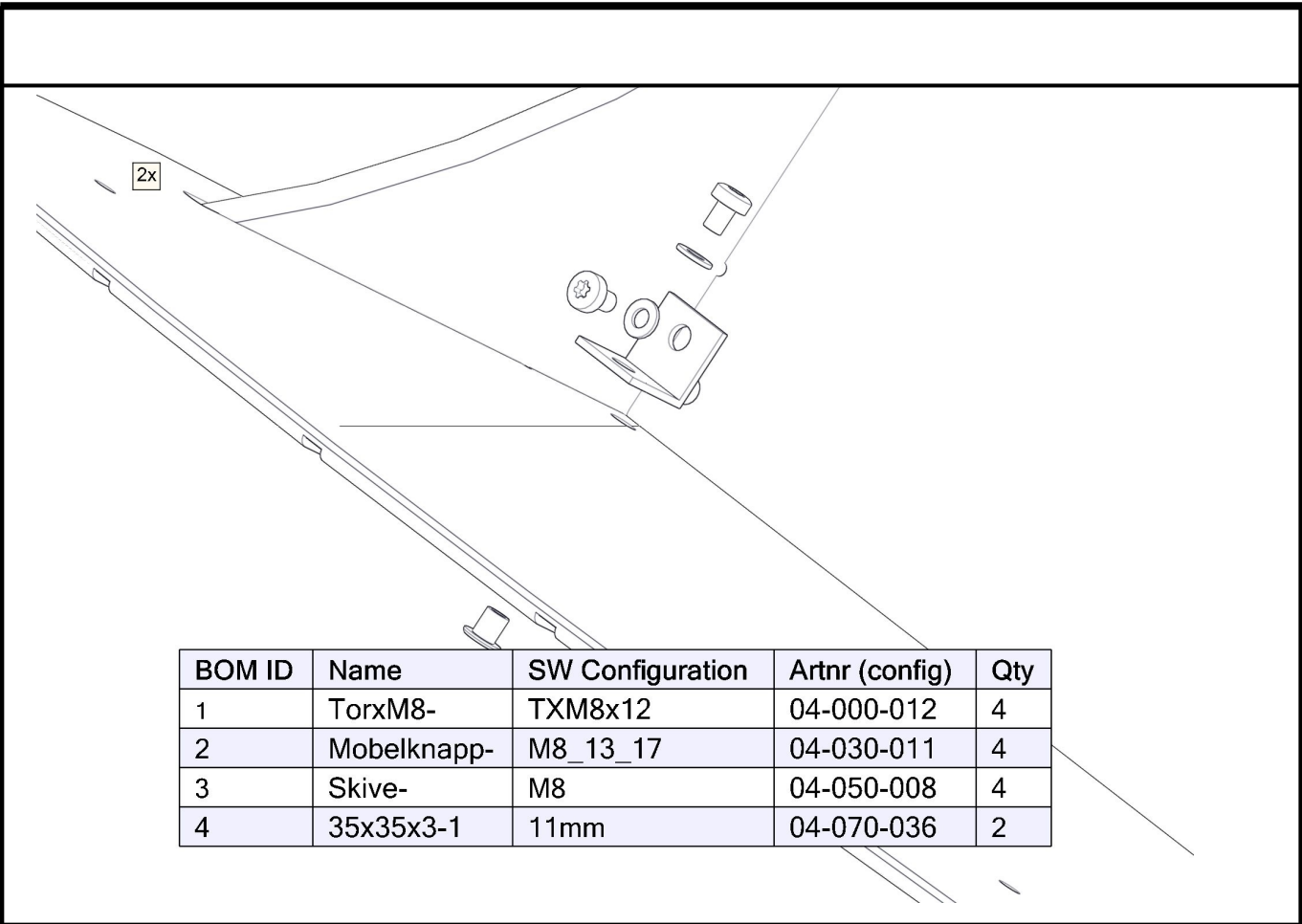

BOM ID	Name	SW Configuration	Artnr (config)	Qty
1	TorxM8-	TXM8x12	04-000-012	4
2	Mobelknapp-	M8_13_17	04-030-011	4
3	Skive-	M8	04-050-008	4
4	35x35x3-1	11mm	04-070-036	2

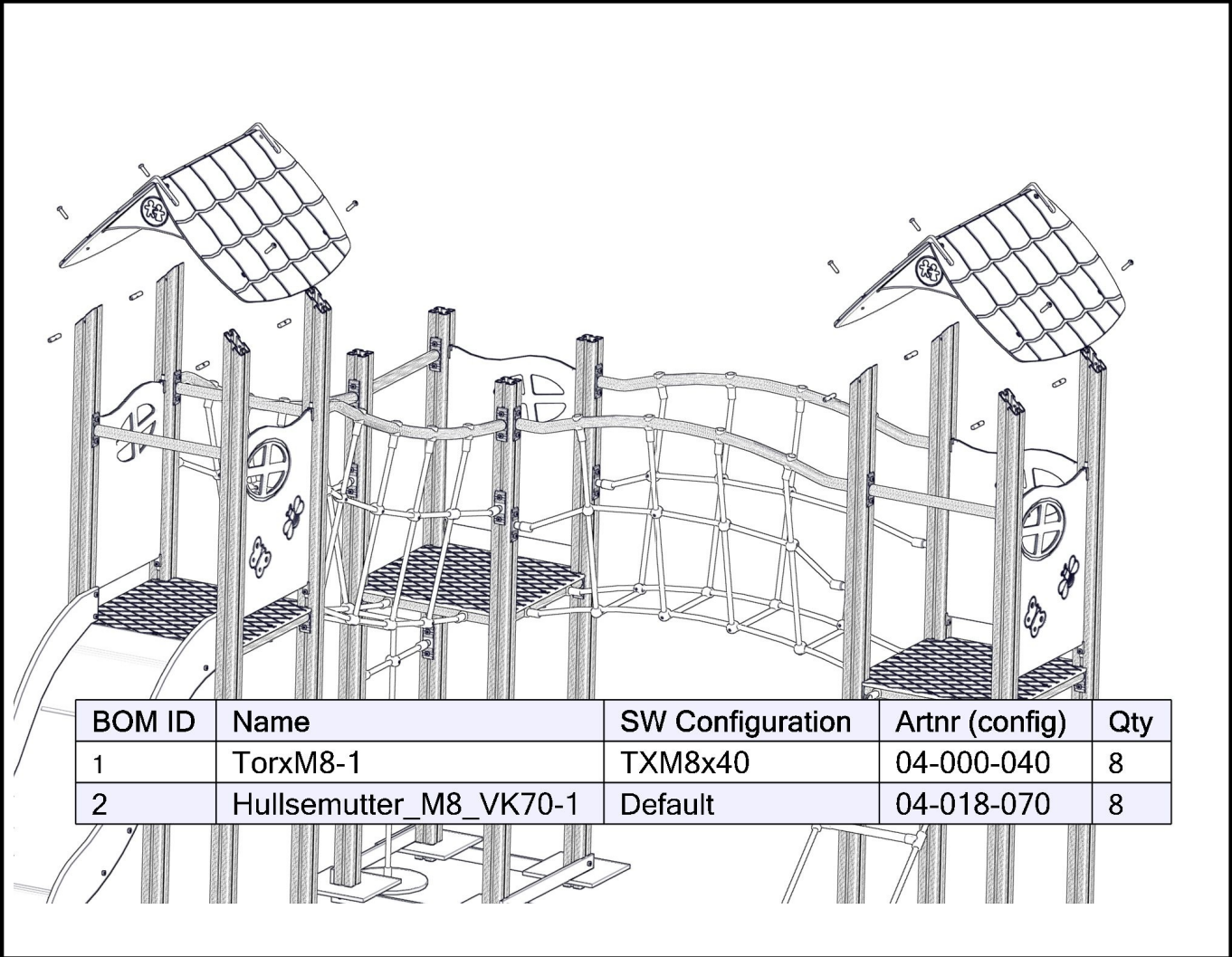

BOM ID	Name	SW Configuration	Artnr (config)	Qty
1	TorxM8-1	TXM8x40	04-000-040	8
2	Hullsemutter_M8_VK70-1	Default	04-018-070	8

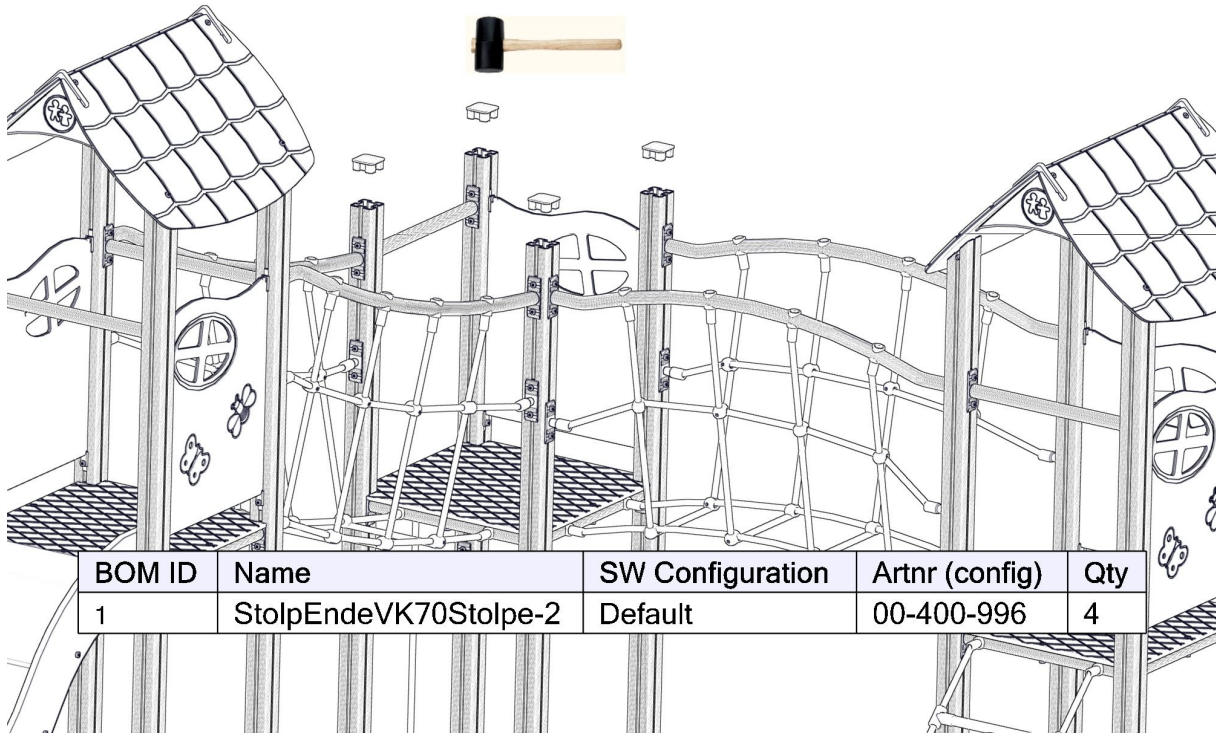

Før utstyret tas i bruk / Before play begins / Innan lekredskapet tas i bruk	
N	<ul style="list-style-type: none"> • Påse at fallunderlag er utlagt i henhold til gjeldende regler eller vår anbefaling • Fjern alle monteringshjelpemidler (rester av betong, planker, paller, plast, og lignende) • Før utstyret tas i bruk, burde man sjekke at det ikke er fare for at anorakksnorer og lignende som kan hekte seg fast noen steder på lekeapparatet. (Vedlagte snor med dobbe (kneledd) kan brukes til å sjekke at dette er i orden. Se vedlagte veiledning for bruk av denne. Dette gjøres for å oppdage eventuelle feilmonteringer.?) • NB! Bør stå i 2-3 dager før bruk
UK	<ul style="list-style-type: none"> • Make sure the area and depth of safer surfacing are according to the current standard, or to the manufacturer's recommendation • Make sure all tools and surplus materials are removed before play begins • PS! When complete, allow 2-3 days for the concrete to set before use
S	<ul style="list-style-type: none"> • Kontrollera att fallunderlag är utlagt enligt gällande regler eller vårt rekomenation • Ta bort alla monteringshjälpmedel (rester av betong, plankor, pallar, plast och liknande) • Innan lekredskapet används, kontrollera att anoracksnoddar eller kläder/delar av kläder eller liknande inte kan fastna i några delar på redskapet. (Den bipackade "knävringen" kan man med fördel användas för denna kontroll. • Detta görs för att upptäcka eventuella felmonteringar.)