

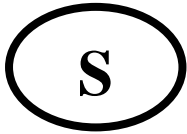

**Monteringsanvisning**



**Assembly Instructions**



**Monteringsanvisning**

Produkt nr. / Product no. / Produkt nr.

**25-200-100**

Ordr. nr. \_\_\_\_\_

Dato. \_\_\_\_\_

Sign. \_\_\_\_\_



**Søve Lekemiljø AS**

3830 Ulefoss - Norway

Tlf: +47 35 94 65 65

[www.ove.no](http://www.ove.no)



**Søve AB**

Fabriksgatan 7

412 50 Göteborg

Phone: +46 (0)31 773 97 00

[www.ove.se](http://www.ove.se)

## Monteringstips / Assembly Advice / Monteringsstips

N

- Les monteringsanvisningen nøye før montering.
- Monter elementene i rekkefølgen som vist.
- Boltene bør ikke skrues for hardt til før alt er montert, vatret og loddet. Skru så boltene til.
- NB! Ved bruk av drill, kan boltene ryke.
- På grunn av at solen kan gjøre rutsjeflaten veldig varm, bør rutsjebanens utløp vende mot nord-øst eller nord-vest.
- Er lekeutstyret plassert i naturlige ferdselstraséer må området sikres mot spontan gjennomgang.
- Innspringningshinder bør vurderes rundt lekeapparater hvor det er stor bevegelse, f.eks.
  - ved huskestativ.
- Det bør være fritt innsyn til lekeutstyr som er beregnet for barn under 3 år.

**NB! Under monteringsarbeidet må utstyr, som ikke er forankret forsvarlig i bakken, avstives slik at det ikke velte. Området må avstenges under oppsettelse av apparatene med sperrebånd eller lignende.**

UK

- Read the instruction carefully before assembling the play unit.
- Assemble the components in the sequence shown in these instructions.
- Fixings must not be fully tightened during assembly. Before casting the foundations, the structure must be level and plumb, at which point all fixings are tightened.
- PS! If use of drill, the bolts may be wrecked.
- Avoid positioning the slide facing due south because of overheating – ideal positions are facing north-east or north-west.
- Secure the construction-area to prevent people from walking through it.
- Consider installing barriers around play-equipment which gives rise to a lot of activity – i.e. swings.
- Ensure that clear vision is possible across the play area so that supervision is possible from any position, particularly where children under 3 years of age will be playing.

**NB! During assembly of the equipment, ensure that all structures are securely propped, especially when left overnight. Also ensure that equipment is supported whilst concrete foundations are setting and enclose the area securely to prevent access.**

**Monteringstips / Assembly Advice / Monteringsstips**











S

- Läs monteringsanvisningen noga före montering.
  - Montera delarna i den ordningen som anvisas
  - Skruvarna bör inte skruvas för hårt tills allt är monterat, i våg och lodat.
- OBS! Används elektrisk skruvdragare, kan bulten gå sönder. Hårdra därför manuellt!
- Solen kan göra att rutchbanan blir väldigt varm. Banans nedfart rekommenderas att vändas i norrlig riktning
  - Om lekplatsen placeras vid en gångväg mm bör området säkras mot genomfart av gående och cyklister.
  - Inspringningshinder bör placeras runt lekutrustning med stor rörelse, t ex, gungställning.
  - Det bör vara fri insyn till lekutrustning beräknat till barn under 3 år.

**OBS! Under monteringsarbete bör utrustningen som inte ska förankras i marken, ställs så att den inte kan välta.**

**Området måste spärras när lekutrustningen byggs upp, med avspärrningsband eller liknande.**

**Nødvendig verktøy / Tools required / Nödvändiga verktyg**

<p>(N)</p> <p>(UK)</p> <p>(S)</p>	<p>(A)</p> 	<p>(B)</p>  <p>Torx Nr 45 High quality</p>	<p>(C)</p> <p>5 mm 6 mm</p> 	<p>(D)</p> 	<p>(E)</p> 
		<p>Metermål Metric measure Tumstoc</p> 	<p>16 V</p> 	<p>Merkebånd Mark ribbon Märkeband</p> 	<p>13 + 17mm</p> 

**Nødvendig antall personer / Number of persons required / Lämpligt antal personer**





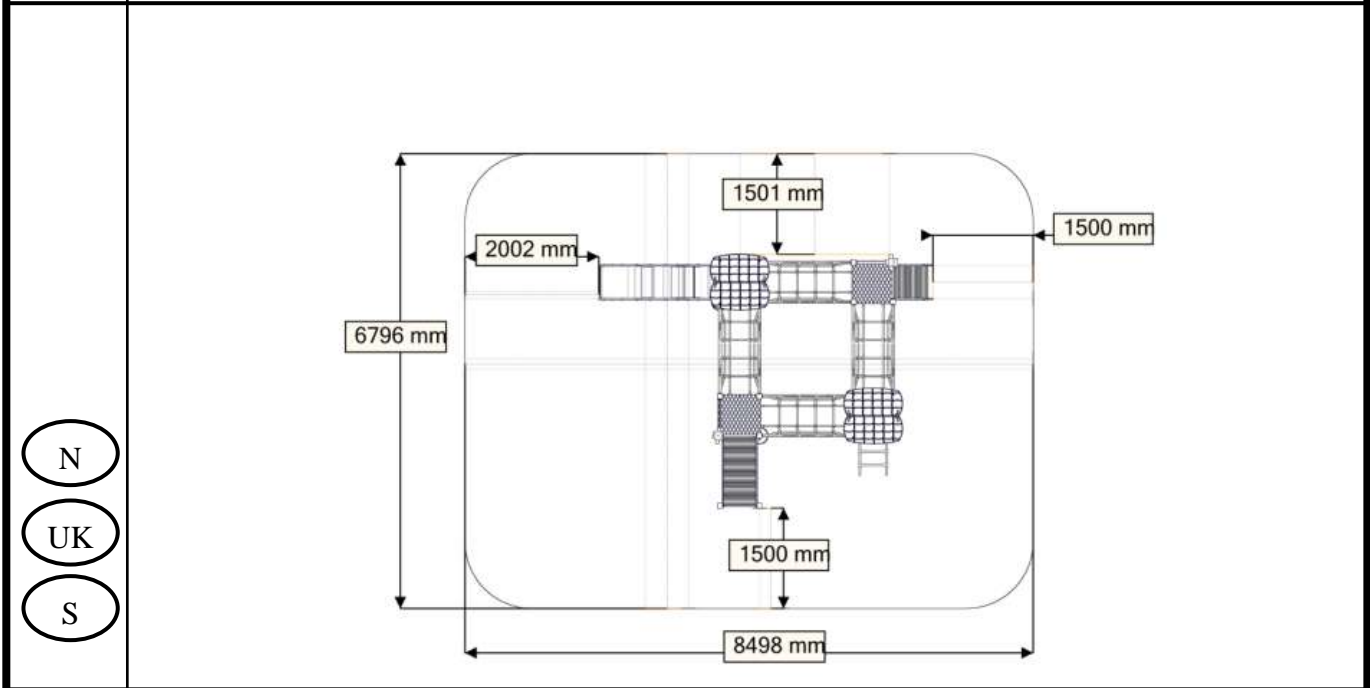







**Anbefalt arealbehov ved montering / Recommended working space / Rekommenderad arealbehov vid montering**

















**Boltepakker for / Boltpackage for / Bultpaket för**

Sign. \_\_\_\_\_

<b>Stolpe 70x70 skrå</b>	<b>Ant= 8</b>	<b>Navn</b>	<b>Artnr/dimensjon</b>	<b>Ant</b>	<b>Lev</b>
		VK70 2100-600 (1) Skrå VK70 1700-600(1) Brikke på stolpe!	07-510-158	4	
		Torx M8x40 (1)	04-000-040	8	
		Hullsemutter (1) VK70	04-018-070	8	
<b>Stolpe 70x70</b>	<b>Ant= 8</b>	<b>Navn</b>	<b>Artnr/dimensjon</b>	<b>Ant</b>	<b>Lev</b>
		VK70 1400-600 (1) Brikke på stolpe!	07-510-157	4	
		VK70 1800-600 (1) Brikke på stolpe!	07-510-150	4	
		VK70 800-600 (1)	07-510-455	2	
<b>Endelukk 70x70</b>	<b>Ant= 10</b>	<b>Navn</b>	<b>Artnr/dimensjon</b>	<b>Ant</b>	<b>Lev</b>
		Endelukk70x70 (1)	00-400-996	10	
<b>FundamentMini 660</b>	<b>Ant= 18</b>	<b>Navn</b>	<b>Artnr/dimensjon</b>	<b>Ant</b>	<b>Lev</b>
		miniSprosse 660 (1)	07-510-200	18	
		Brikke 50_1T (2)	04-060-040	36	
		Torx M8x35 (2)	04-000-035	36	
<b>FundamentSkive</b>	<b>Ant= 18</b>	<b>Navn</b>	<b>Artnr/dimensjon</b>	<b>Ant</b>	<b>Lev</b>
		Skive (1)	07-510-201	18	











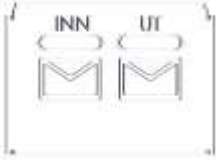

**Boltepakker for / Boltpackage for / Bultpaket för**

Sign. \_\_\_\_\_.

<b>Vegge 520x600 Vindo bloms</b>	<b>Ant= 1</b>	<b>Navn</b>	<b>Artnr/dimensjon</b>	<b>Ant</b>	<b>Lev</b>
		Vegge520x600 (1) Vindu blom	07-510-120	1	
		Brikkespesial(4)	04-060-041	4	
		Brikke(4)	04-060-040	4	
		Torx M8x25(4)	04-000-025	4	
<b>Vegge 520x600 Vindo Bi</b>	<b>Ant= 2</b>	<b>Navn</b>	<b>Artnr/dimensjon</b>	<b>Ant</b>	<b>Lev</b>
		Vegge520x600 (1) Vindu bi/ Sommerfulg	07-510-120	2	
		Brikkespesial(4)	04-060-041	8	
		Brikke(4)	04-060-040	8	
		Torx M8x25(4)	04-000-025	8	
<b>Vegge 520x400 Sommerfugl / bie</b>	<b>Ant= 1</b>	<b>Navn</b>	<b>Artnr/dimensjon</b>	<b>Ant</b>	<b>Lev</b>
		Vegge520x400 (1) Sommerfugl/bie	07-510-110	1	
		Brikkespesial(4)	04-060-041	4	
		Brikke(4)	04-060-040	4	
		Torx M8x25(4)	04-000-025	4	



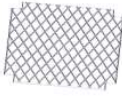











**Boltepakker for / Boltpackage for / Bultpaket för**

Sign. \_\_\_\_\_.

<b>Vegge 520x400 spor Sommerfugl/bie</b>	<b>Ant= 4</b>	<b>Navn</b>	<b>Artnr/dimensjon</b>	<b>Ant</b>	<b>Lev</b>
		Vegge520x400(1) Sommerfugl /bie Med spor	07-510-112	4	
		Brikkespesial(4)	04-060-041	16	
		Brikke(4)	04-060-040	16	
		Torx M8x25(4)	04-000-025	16	
<b>Vegge 520x400 Postkasse</b>	<b>Ant= 1</b>	<b>Navn</b>	<b>Artnr/dimensjon</b>	<b>Ant</b>	<b>Lev</b>
		Vegge520x400(1) Postkasse	07-510-111	1	
		Brikkespesial(4)	04-060-041	4	
		Brikke(4)	04-060-040	4	
		Torx M8x25(4)	04-000-025	4	
<b>Gulv mini</b>	<b>Ant= 4</b>	<b>Navn</b>	<b>Artnr/dimensjon</b>	<b>Ant</b>	<b>Lev</b>
		Gulv Mini 520(1)	07-510-102	4	
		Møbelknapp (4)	04-030-011	16	
		Torx M8x45 (4)	04-000-045	16	

**Boltepakker for / Boltpackage for / Bultpaket för**

Sign. \_\_\_\_\_.

Sete rund stolpe	Ant= 2	Navn	Artnr/dimensjon	Ant	Lev
		Sete rund stolpe	07-510-132	2	
		Vinkel 35x35x3(2) 11mm	04-070-036	4	
		Møbelknapp(2)	04-030-011	4	
		Brikke 501T(2)	04-060-040	4	
		Torx M8x12 (2) Torx M8x20 (2)	04-000-012 04-000-020	4 4	
		Skive M8 (2)	04-050-008	4	
Buttikdisk	Ant= 1	Navn	Artnr/dimensjon	Ant	Lev
		Buttikdiskk	07-510-130	1	
		Vinkel 50x50x4(2) 11mm	04-070-050	2	
		Møbelknapp(2)	04-030-011	2	
		Brikke 501T(2)	04-060-040	2	
		Torx M8x12 (2) Torx M8x20 (2)	04-000-012 04-000-020	2 2	
		Skive M8 (2)	04-050-008	2	











**Boltepakker for / Boltpackage for / Bultpaket för**

Sign. \_\_\_\_\_

<b>Sperrerør 520</b>	<b>Ant= 5</b>	<b>Navn</b>	<b>Artnr/dimensjon</b>	<b>Ant</b>	<b>Lev</b>
		Sperrerør 520 (1)	07-510-160	5	
		Brikke 120_3T (2)	04-060-120	10	
		Torx M8x25 (4)	04-000-025	20	
<b>Sperrerør 520 gulv</b>	<b>Ant= 7</b>	<b>Navn</b>	<b>Artnr/dimensjon</b>	<b>Ant</b>	<b>Lev</b>
		Sperrerør 520 (1)	07-510-161	7	
		Brikke 90_2T (2)	04-060-090	0 På stolpe	
		Torx M8x25 (2)	04-000-025	14	
<b>Sperrerør 520 gulv 2 hull 300</b>	<b>Ant= 8</b>	<b>Navn</b>	<b>Artnr/dimensjon</b>	<b>Ant</b>	<b>Lev</b>
		Sperrerør 520 (1) For brua	07-510-162	8	
		Brikke 90_2T (2)	04-060-090	0 På stolpe	
		Torx M8x25 (2)	04-000-025	16	
<b>Sperrerør 520 gulv Hull for RUNG 400</b>	<b>Ant= 1</b>	<b>Navn</b>	<b>Artnr/dimensjon</b>	<b>Ant</b>	<b>Lev</b>
		Sperrerør 520 (1) For rung	07-510-163	1	
		Brikke 90_2T (2)	04-060-090	0 På stolpe	
		Torx M8x25 (2)	04-000-025	2	









**Boltepakker for / Boltpackage for / Bultpaket för**

Sign. \_\_\_\_\_.

<b>Rutsjebane 950 07-510-310</b>	<b>Ant= 1</b>	<b>Navn</b>	<b>Artnr/dimensjon</b>	<b>Ant</b>	<b>Lev</b>
		Rutsjebane	07-510-310	1	
		Brikke120 3T(5)	04-060-120	2	
		Torx M8x35(4)	04-000-035	4	
		Torx M8x45(2)	04-000-045	2	
		Torzx M8x30(4)	04-000-030	4	
		Fundamentskive(2) 2H 80	00-003-106	2	
		Skive M8(2)	04-050-008	4	
		Mutter M8(2)	04-040-008	6	
	Stålforankering(2)	00-100-310	2		















**Boltepakker for / Boltpackage for / Bultpaket för**

Sign. \_\_\_\_\_.

Trappe 550 07-510???	Ant= 1	Navn	Artnr/dimensjon	Ant	Lev
		Rutsjebane	01-290-090	1	
		Brikke90 3T(5)	04-060-090	2	
		Torx M8x35(4)	04-000-035	10	
		Fundamentskive(2) 2H 80	00-003-106	2	
		Skive M8(2)	04-050-008	6	
		Mutter M8(2)	04-040-008	6	
		Stålforankering(2)	00-100-310	2	











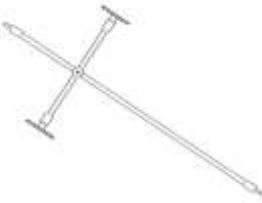





**Boltepakker for / Boltpackage for / Bultpaket för**

Sign. \_\_\_\_\_.

<b>Nettbro skrå 07-510-175</b>	<b>Ant= 2</b>	<b>Navn</b>	<b>Artnr/dimensjon</b>	<b>Ant</b>	<b>Lev</b>
		Nett (1) INKL. beslag	07-510-175	2	
		Rør skrå(2)	07-510-166	4	
		Brikke120 3T(8)	04-060-120	16	
		Torx M8x25(16)	04-000-025	32	
		Saddelwasher 38mm (24)	04-210-010	48	
		Møbelknapp (12)	04-030-025	24	
<b>Nettbro rett 07-510-174</b>	<b>Ant= 2</b>	<b>Navn</b>	<b>Artnr/dimensjon</b>	<b>Ant</b>	<b>Lev</b>
		Nett (1) INKL. beslag	07-510-174	2	
		Rør bue(2)	07-510-164	4	
		Brikke120 3T(8)	04-060-120	16	
		Torx M8x25(16)	04-000-025	32	
		Saddelwasher 38mm (24)	04-210-010	48	
		Møbelknapp (12)	04-030-025	24	











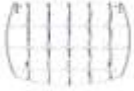

**Boltepakker for / Boltpackage for / Bultpaket för**

Sign. \_\_\_\_\_.

<b>PolyTreppe 550 07-510-177</b>	<b>Ant= 1</b>	<b>Navn</b>	<b>Artnr/dimensjon</b>	<b>Ant</b>	<b>Lev</b>
		StigTrinn 950 (1) INKL beslag	07-510-177	1	
		Saddelwasher 38mm (1)	04-210-010	1	
		Brikke 120_3T (2)	04-060-120	2	
		Torx M8x20 (2)	04-000-020	4	
		Møbelknapp (1)	04-030-011	1	
		Fundamentskive	00-003-103	1	
		Skive M8	04-050-008	1	
		Låsemutter M8	04-040-008	1	
<b>Stigtrinn</b>	<b>Ant= 1</b>	<b>Navn</b>	<b>Artnr/dimensjon</b>	<b>Ant</b>	<b>Lev</b>
		StigTrinn 400 (1)	07-510-170	1	
		Saddelwasher 38mm (4)	04-210-010	4	
		Møbelknapp (2)	04-030-025	2	
		Fundamentskive	00-003-103	2	
		Skive M8	04-050-008	2	
		Låsemutter M8	04-040-008	2	

**Boltepakker for / Boltpackage for / Bultpaket för**

Sign. \_\_\_\_\_.

Tak	Ant= 2	Navn	Artnr/dimensjon	Ant	Lev
		Tak mini (2)	07-510-105	4	
		Gavelplate(2)	07-510-106	4	
		Vinkel 35x35x3(2) 11mm	04-070-036	4	
		Møbelknapp	04-030-011	8	
		Torx M8x12(4)	04-000-012	8	
		Skive M8 (4)	04-050-008	8	
Trapp 950	Ant= 1	Navn	Artnr/dimensjon	Ant	Lev
		Trapp 950	07-510-451	1	
		Rekkverk trappa	07-510-454	2	
		Brikke 50 1T	04-060-040	16	
		Brikke 90 2T	04-060-090	2	
		Torx M8x35	04-000-035	20	

**Fundamentering med betong / Foundation concrete / Förankring med betong**

(N)	Støtsand		(N)	(UK)	(S)
(UK)	Safer surface		Bakkenivå	Ground level	Marknivå
(S)	Stridsan		↓	Ref NS-EN 177	
(N)	Komprimert masse.	betong			
(UK)	Compressed mass.	concrete			
(S)	Komprimerad massa.	betong			

**Fundamentering uten betong / Foundation without concrete / Förankring utan betong**

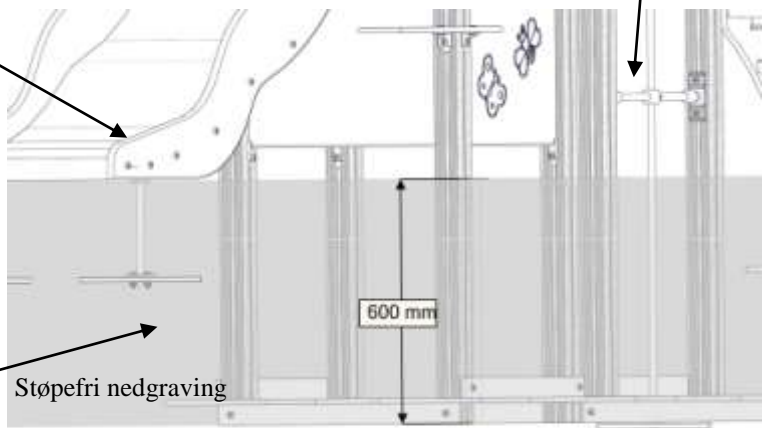
(N)	Støtsand		(N)	(UK)	(S)
(UK)	Safer surface		Bakkenivå	Ground level	Marknivå
(S)	Stridsan		↓	Ref NS-EN 1177	
(N)	Komprimert masse	Støpefri nedgraving			
(UK)	Compressed mass	Concrete-free anchor			
(S)	Komprimerad massa	Nedgrävningfundament			

(N)	Alle mål er oppgitt i millimeter
(UK)	Scale measured in mm
(S)	Alla mått är i millimeter.

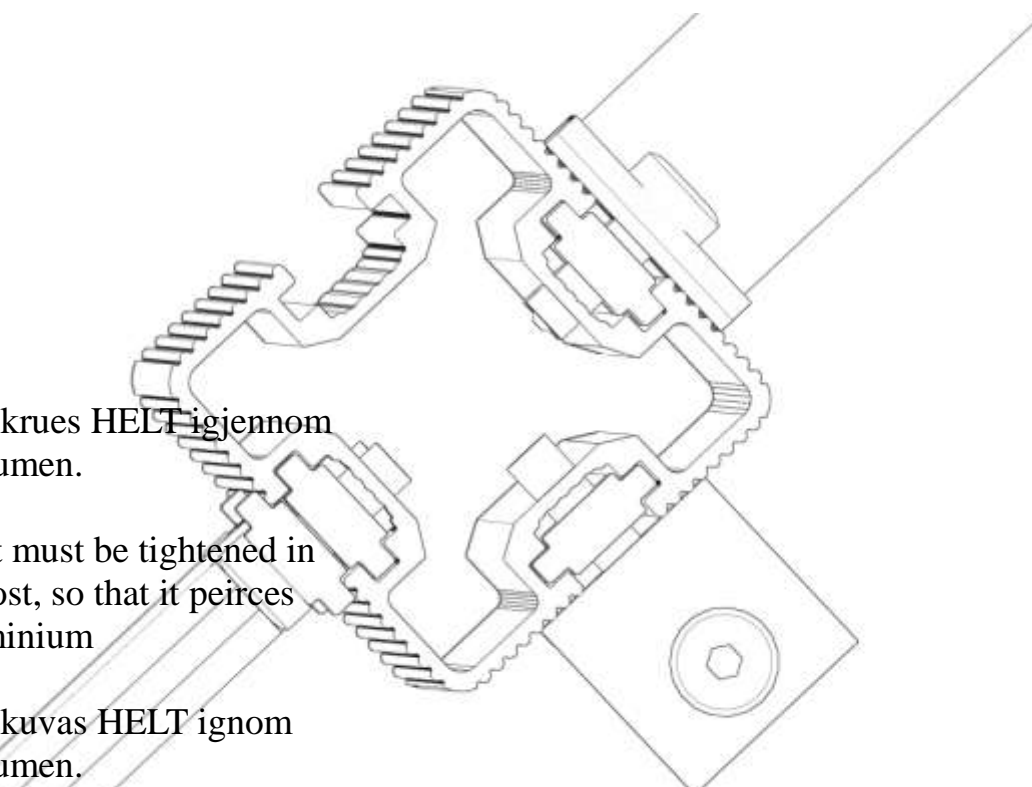
<p data-bbox="124 1559 220 1621">N</p> <p data-bbox="124 1693 220 1756">UK</p> <p data-bbox="124 1850 220 1912">S</p>	 <p data-bbox="240 1585 703 1666">Bolten skrues HELT igjennom aluminiumen.</p> <p data-bbox="240 1715 687 1836">The bolt must be tightened in to the post, so that it peirces the aluminium</p> <p data-bbox="240 1886 663 1966">Bulten skruvas HELT ignom aluminiumen.</p>



**Fallhøyder / Free height of fall / Fallhöjder**

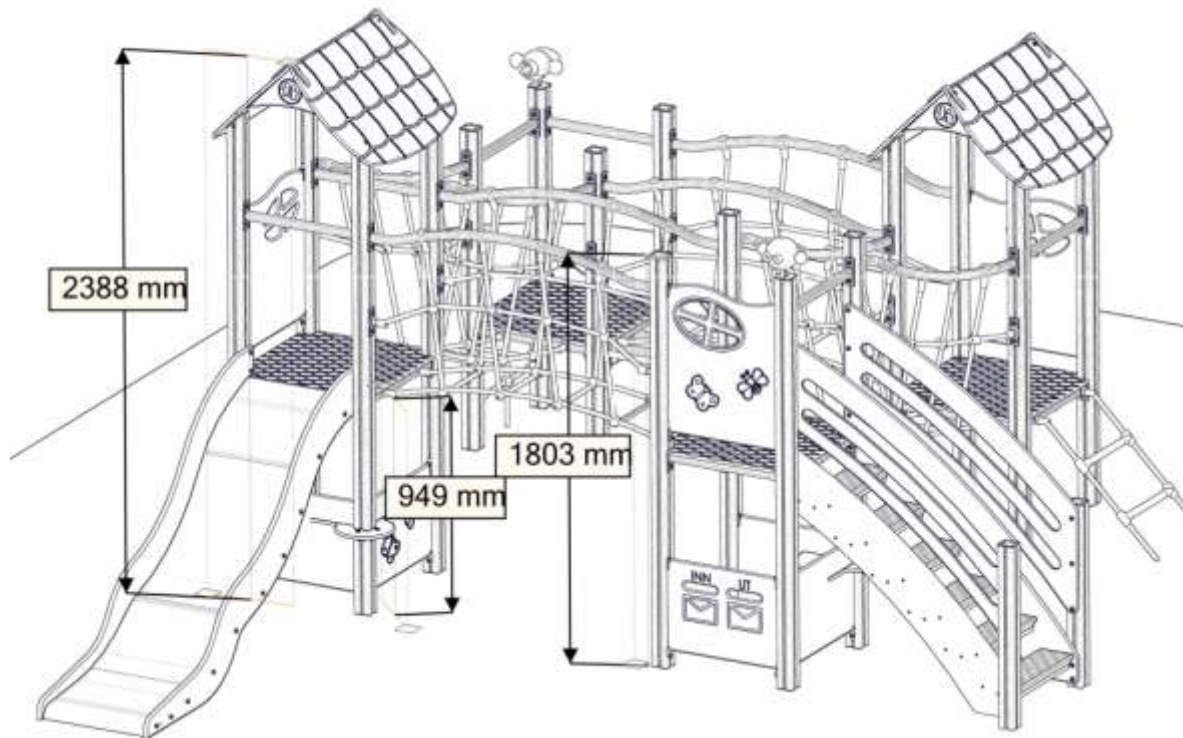

**Sikkerhetszone / Safety zone / Säkerhetszon**

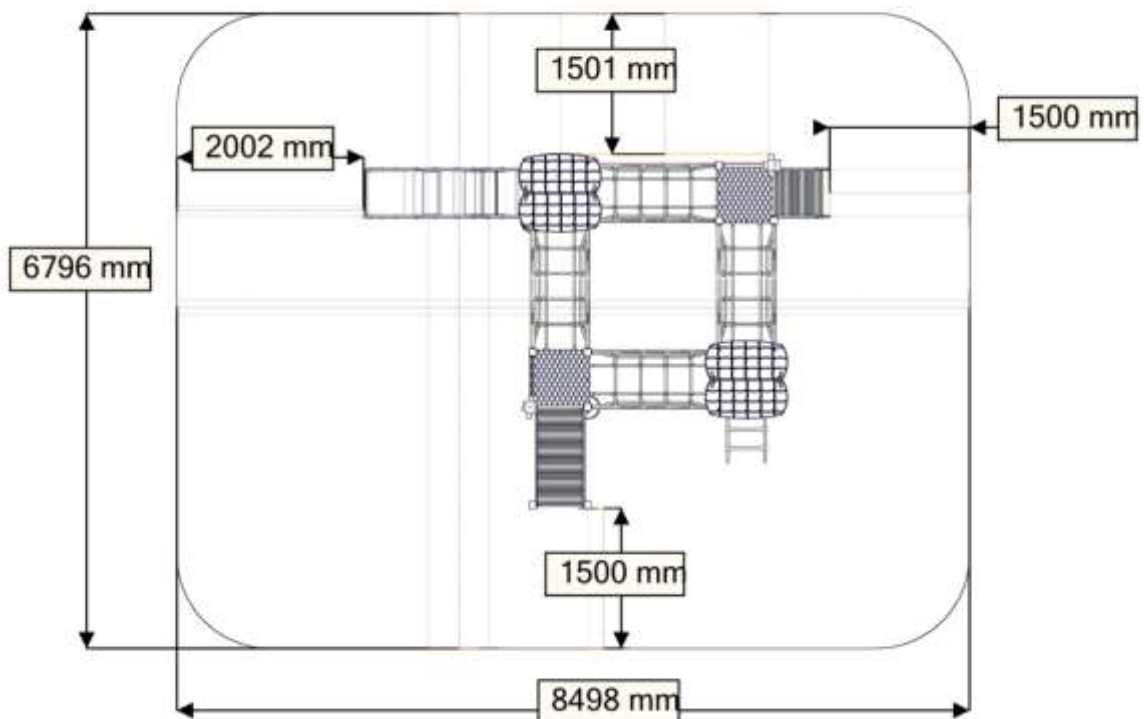

**Plassering av forankringer / Ground plan / Placering av förankringar**

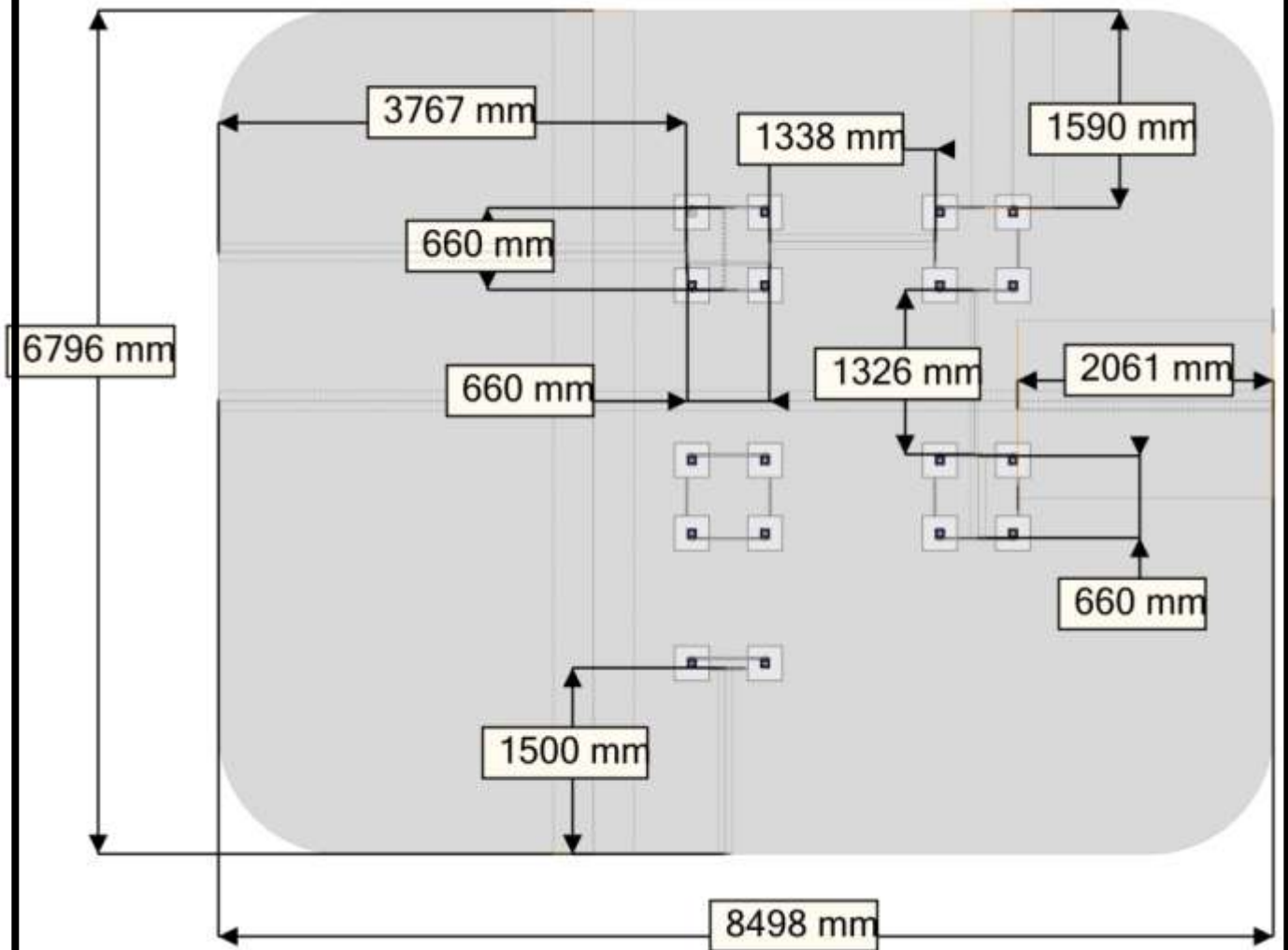

N

Alle mål er oppgitt i millimeter

UK

Scale measured in mm

S

Alla mått är i millimeter.

## Montering av lekeapparatet / Assembly instructions / Montering av lekredskapet

Brikke montert hos Søve

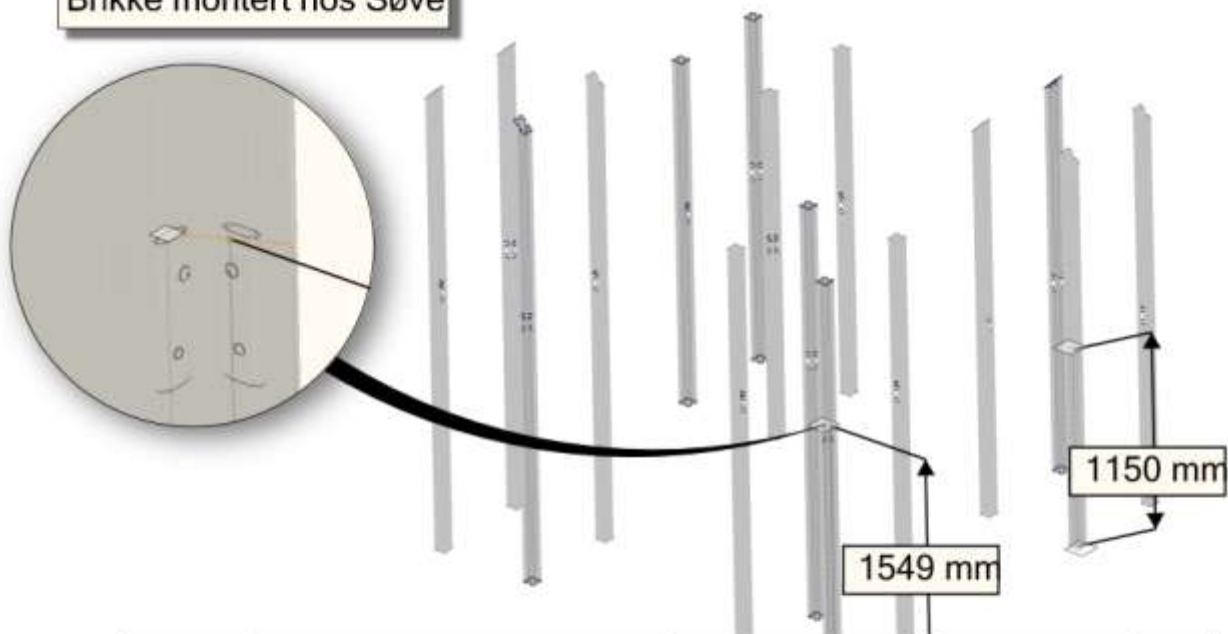

BOM ID	Name	SW Configuration	Artnr (config)	Qty
1	VK70_SFA5123_miniserie-1	1800-600	07-510-150	4
2	VK70_SFA5123_miniSkra-1	1700-600	07-510-156	4
3	VK70_SFA5123_miniserie-1	1400-600	07-510-157	4
4	VK70_SFA5123_miniSkra-1	2100-600	07-510-158	4



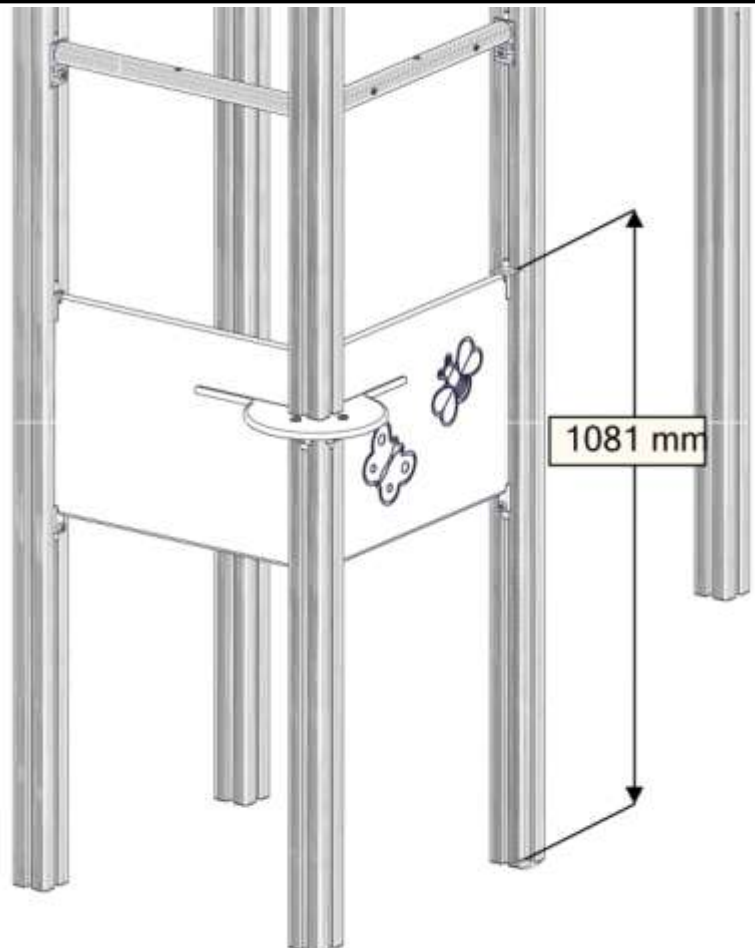
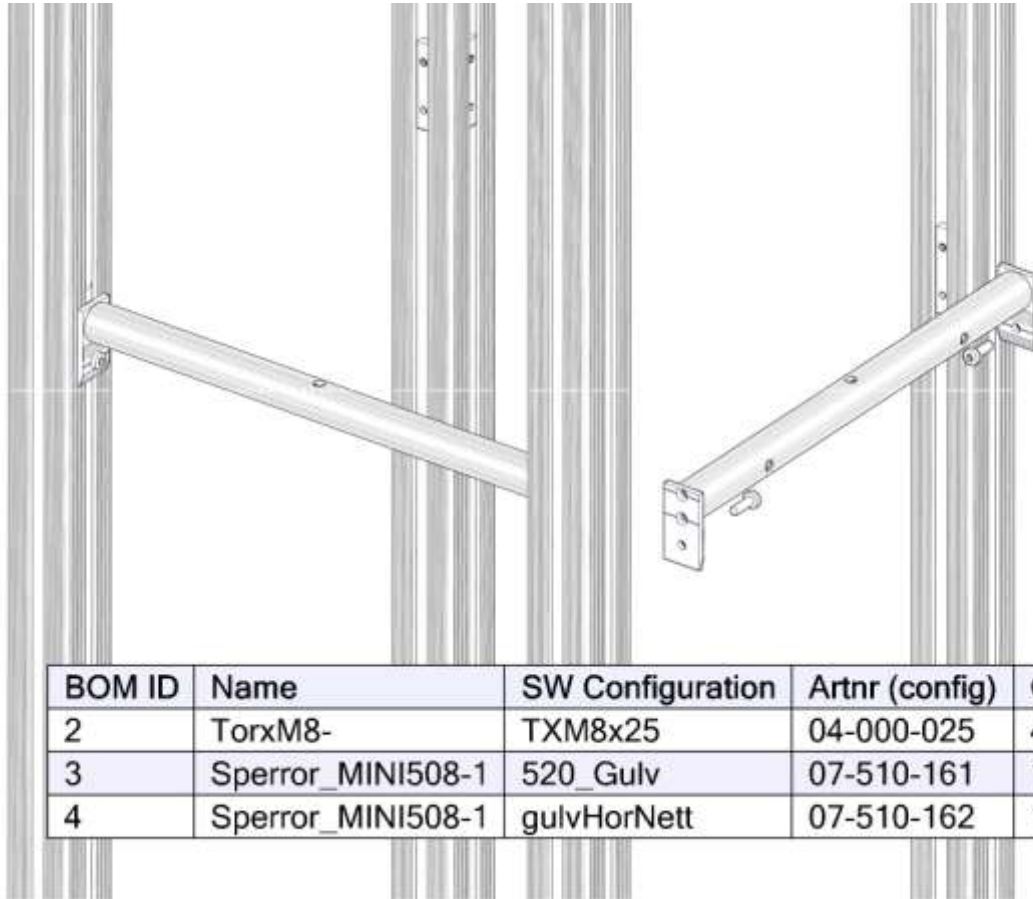

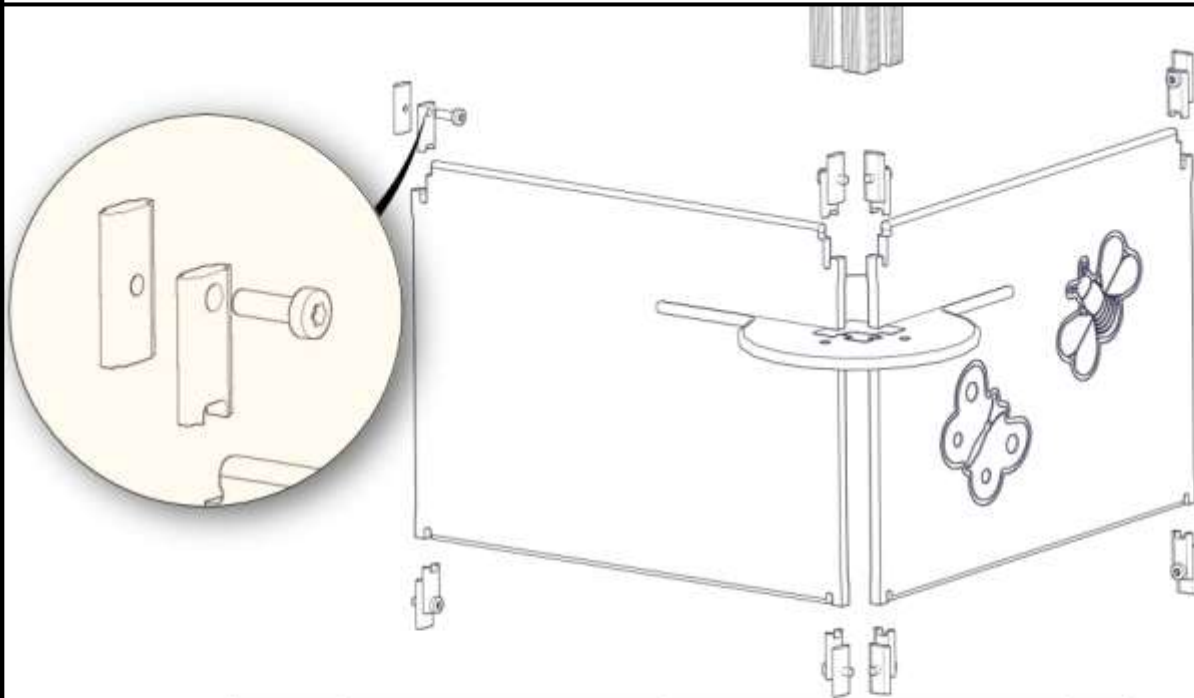

BOM ID	Name	SW Configuration	Artnr (config)	Qty
1	TorxM8-1	TXM8x25	04-000-025	8
2	brikke_SFA5116Special-1	12mm	04-060-041	8
3	brikke_SFA5116-1	50_1T	04-060-050	8
4	VeggMini520x400-1	Med_Spor	07-510-112	2
5	SeteRundStolpe-1	Stor	07-510-132	1

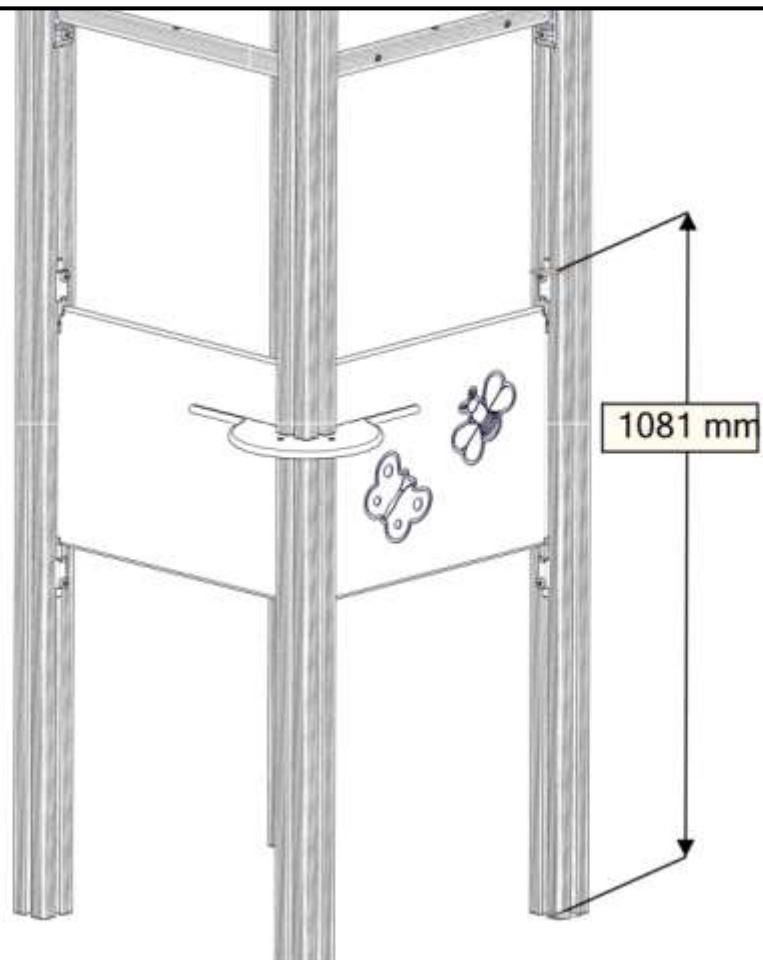

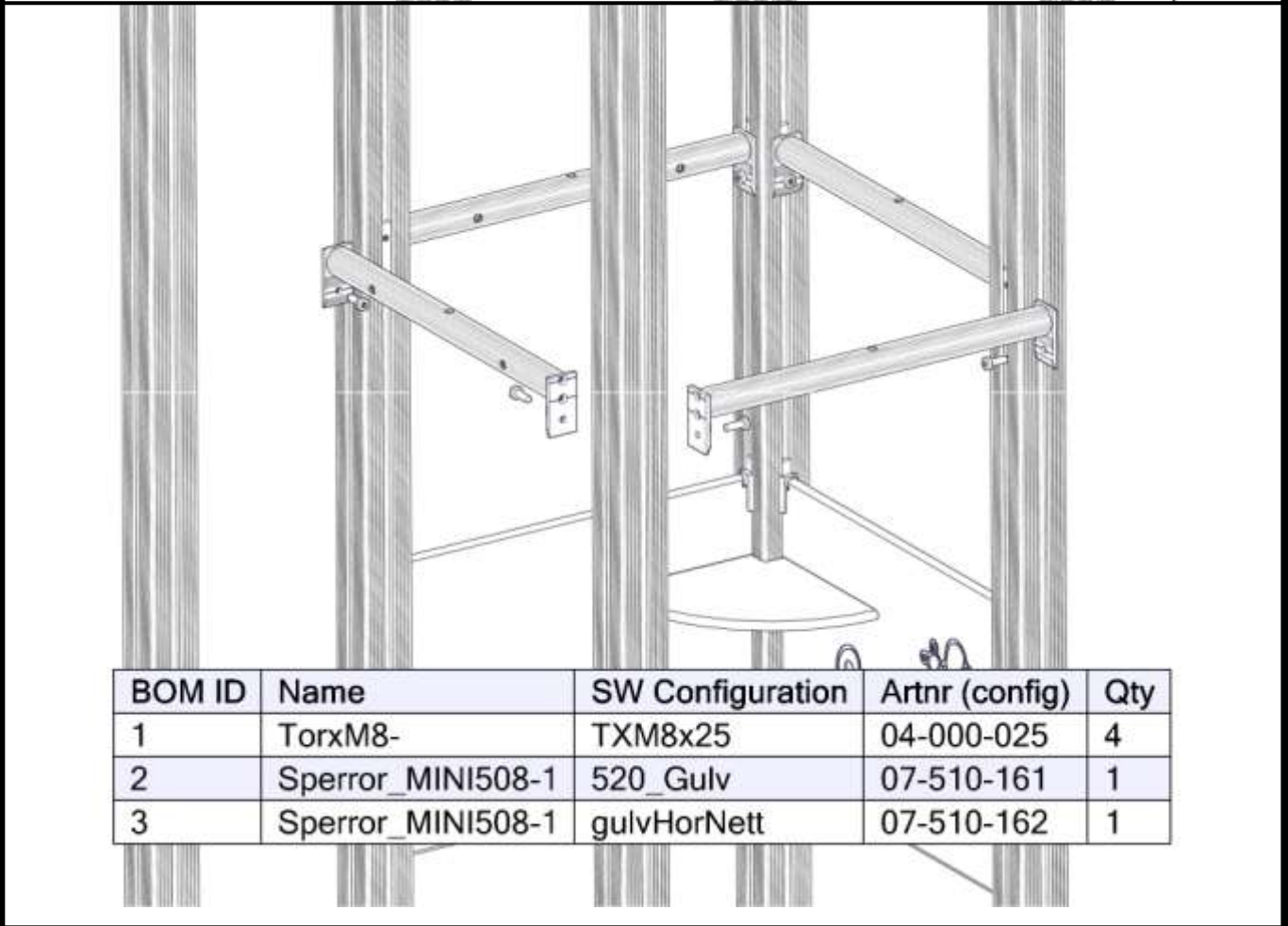
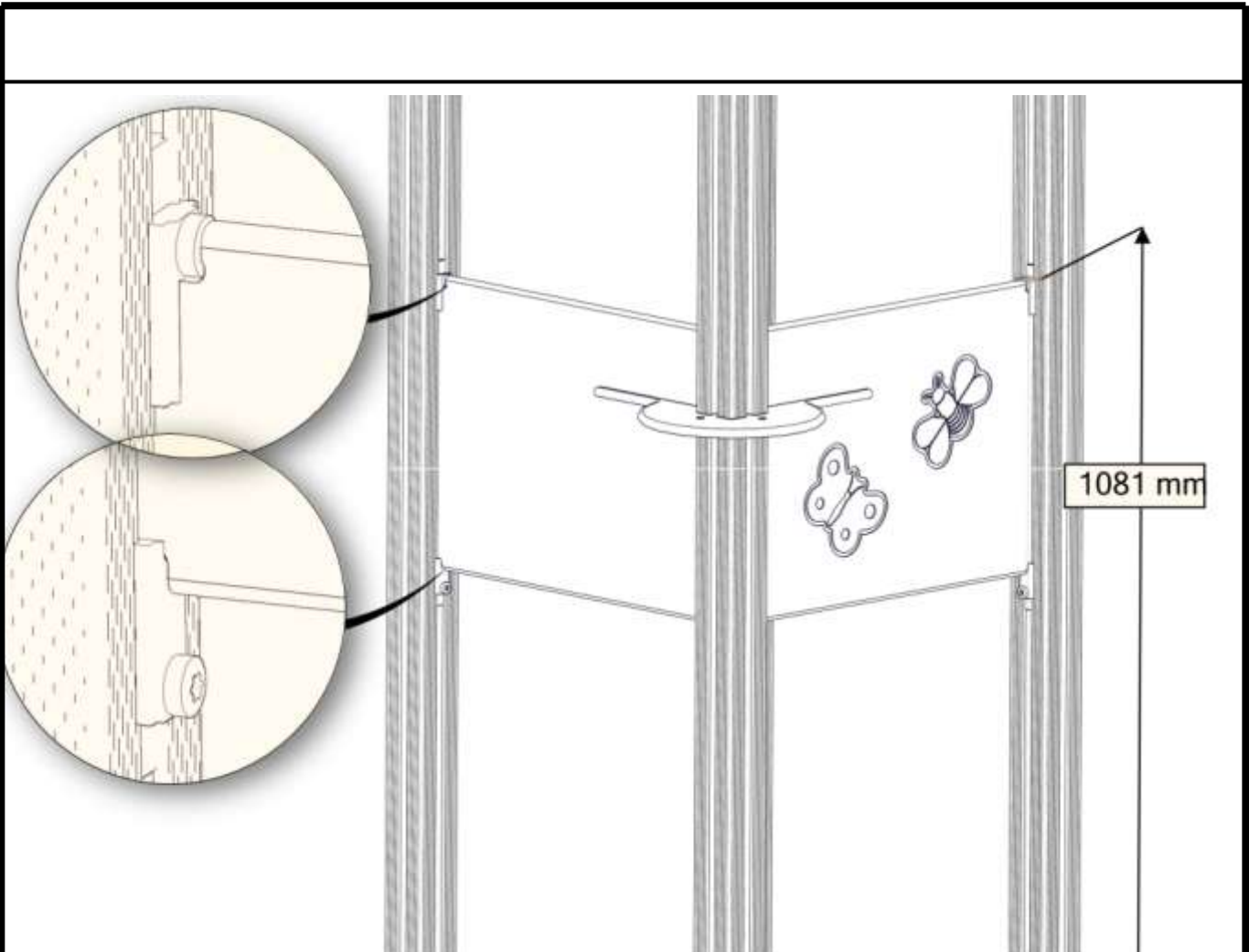

BOM ID	Name	SW Configuration	Artnr (config)	Qty
1	Torxm8-	TXM8x25	04-000-025	4
2	Sperror_MINI508-1	520_Gulv	07-510-161	1
3	Sperror_MINI508-1	gulvHorNett	07-510-162	1

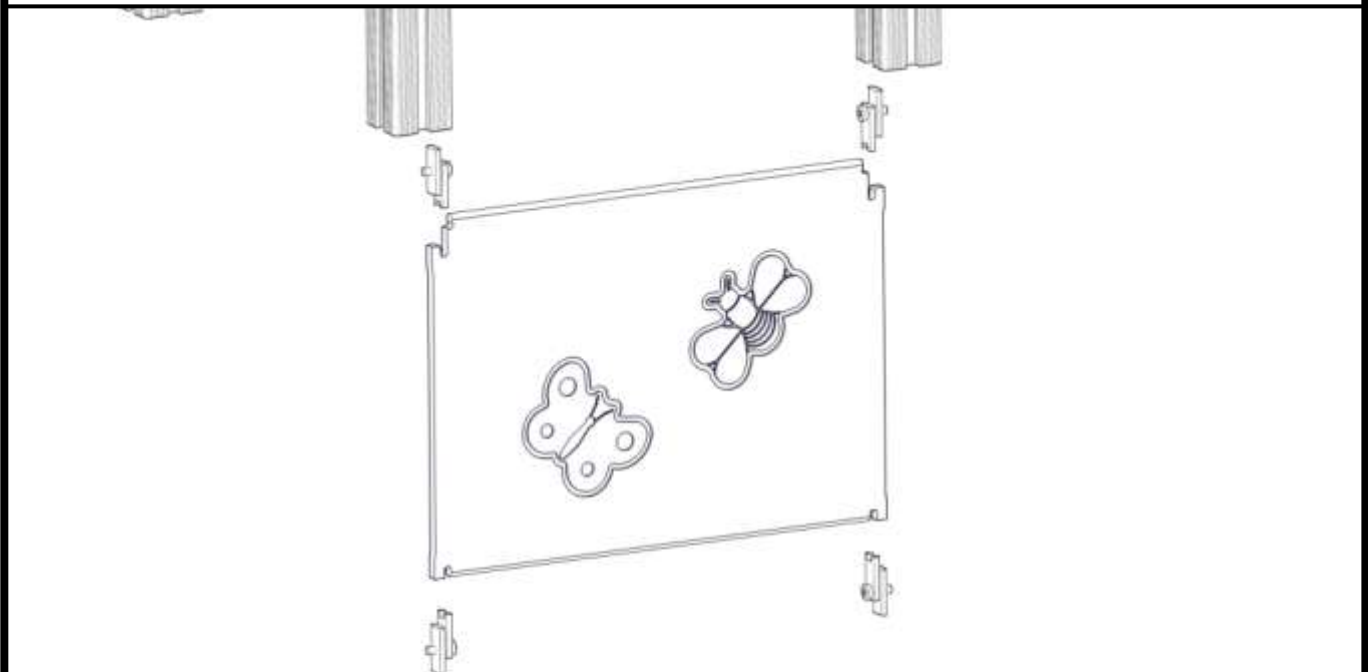
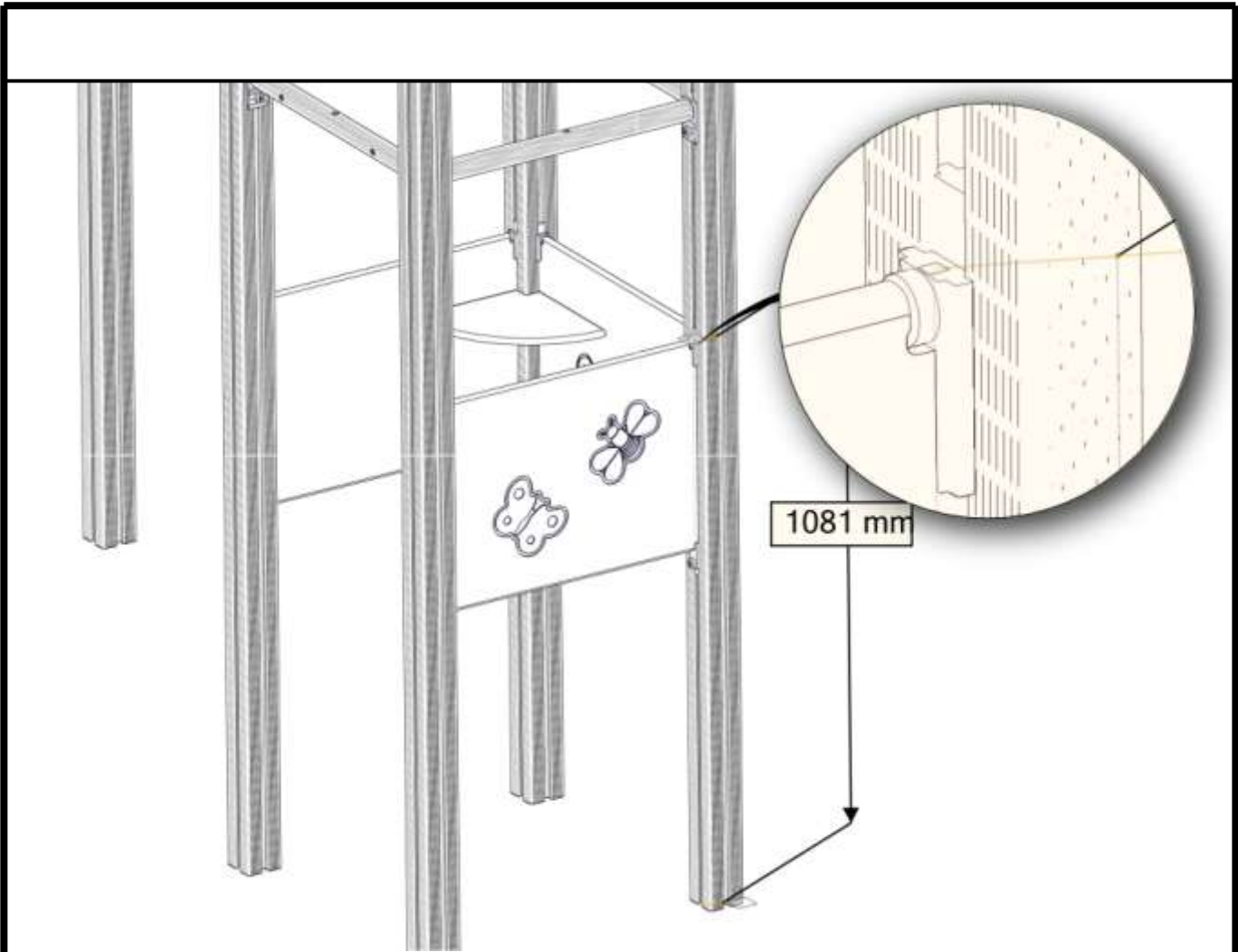

BOM ID	Name	SW Configuration	Artnr (config)	Qty
1	TorxM8-1	TXM8x25	04-000-025	4
2	brikke_SFA5116Special-1	12mm	04-060-041	4
3	brikke_SFA5116-1	50_1T	04-060-050	4
4	VeggMini520x400-1	STD	07-510-110	1

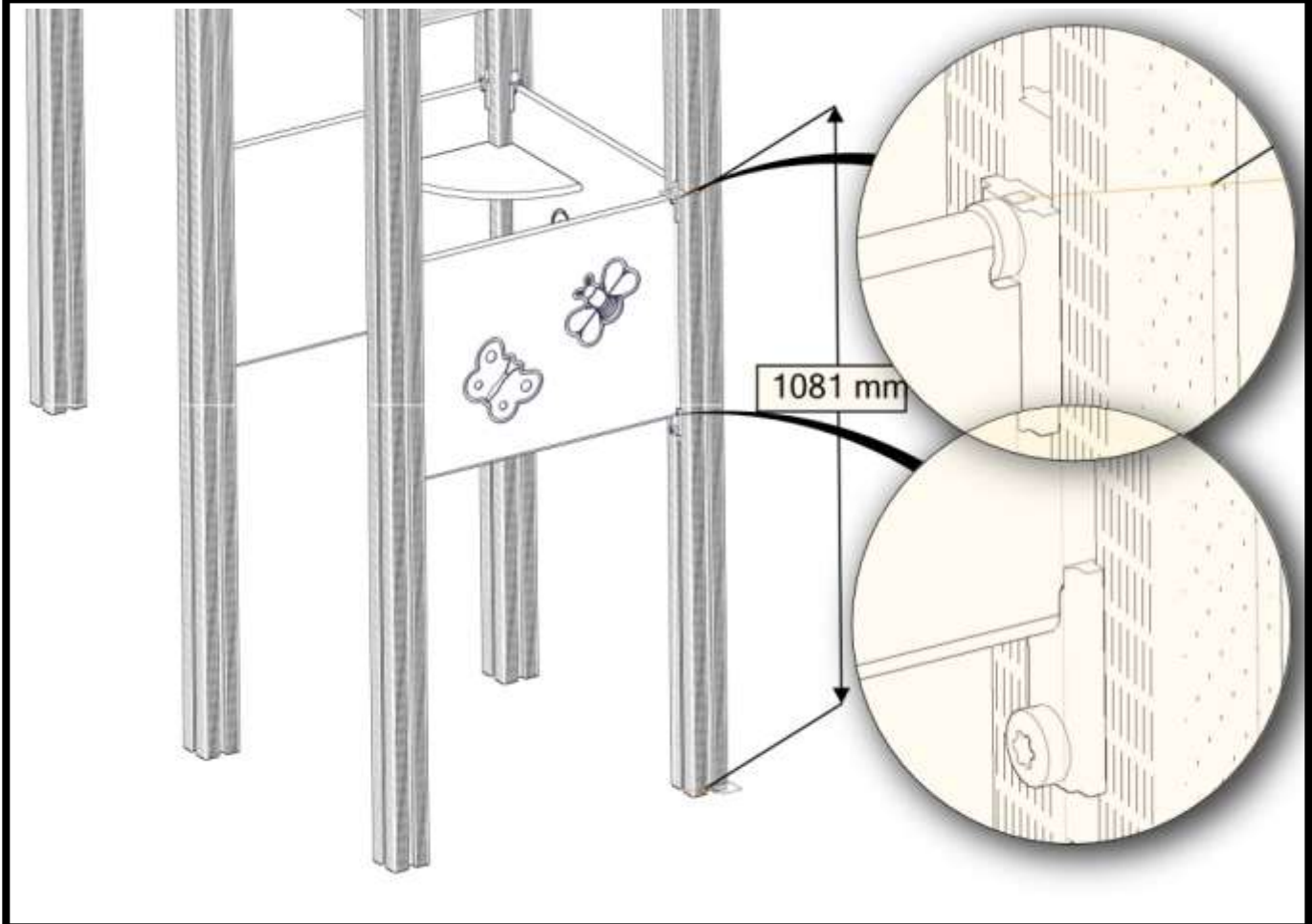
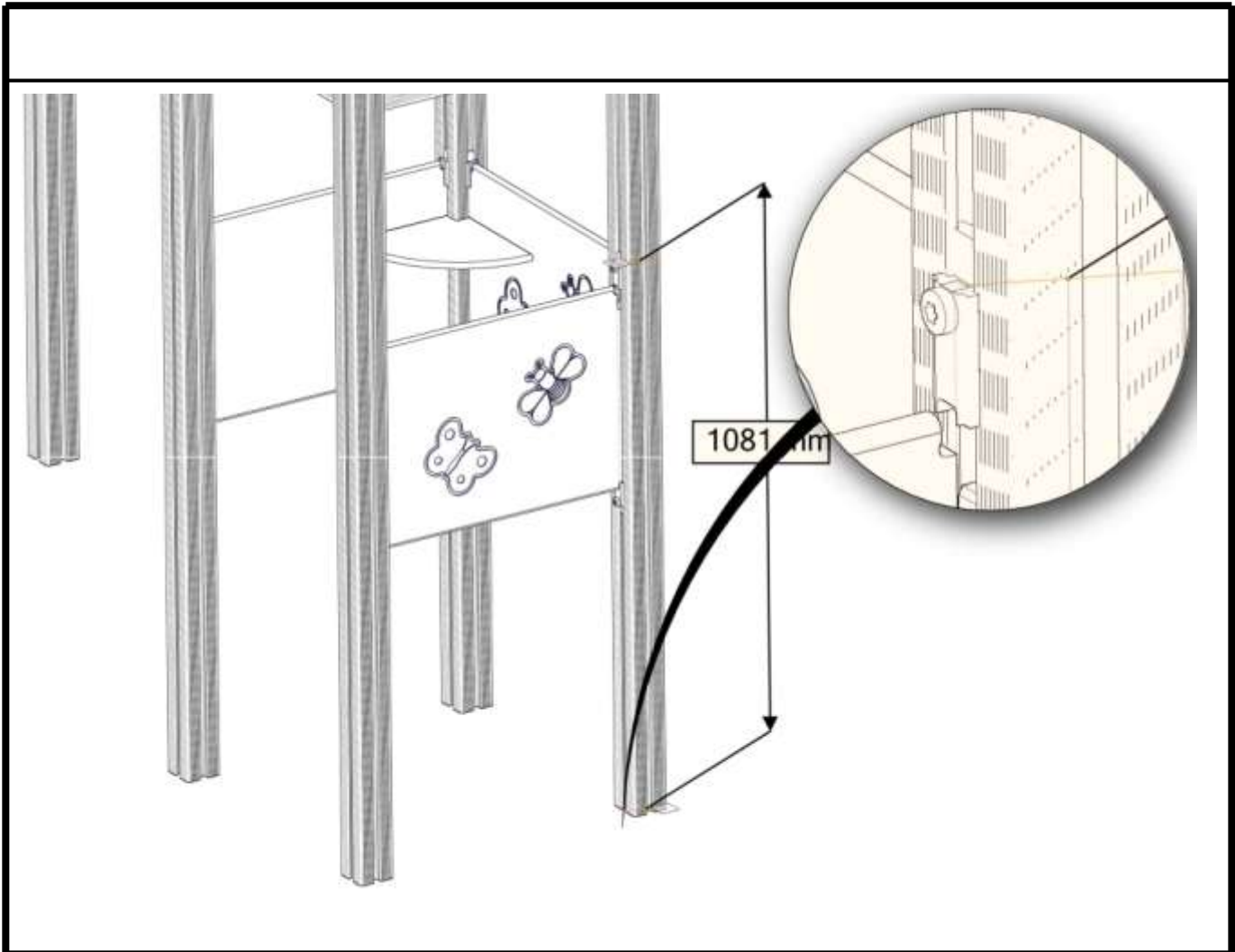



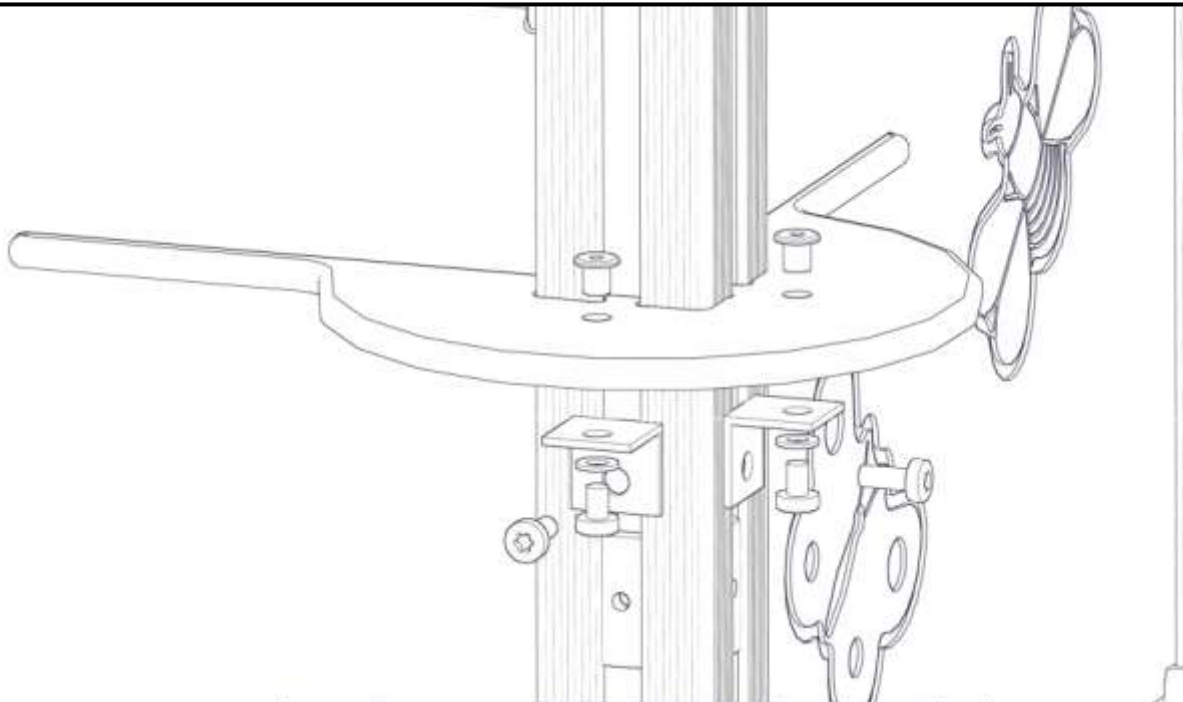

BOM ID	Name	SW Configuration	Artnr (config)	Qty
1	TorxM8-1	TXM8x12	04-000-012	2
2	TorxM8-2	TXM8x20	04-000-020	2
3	Mobelknapp-1	M8 13_17	04-030-011	2
4	Skive-1	M8	04-050-008	2
5	brikke_SFA5116-1	50_1T	04-060-050	2
6	35x35x3-1	11mm	04-070-036	2

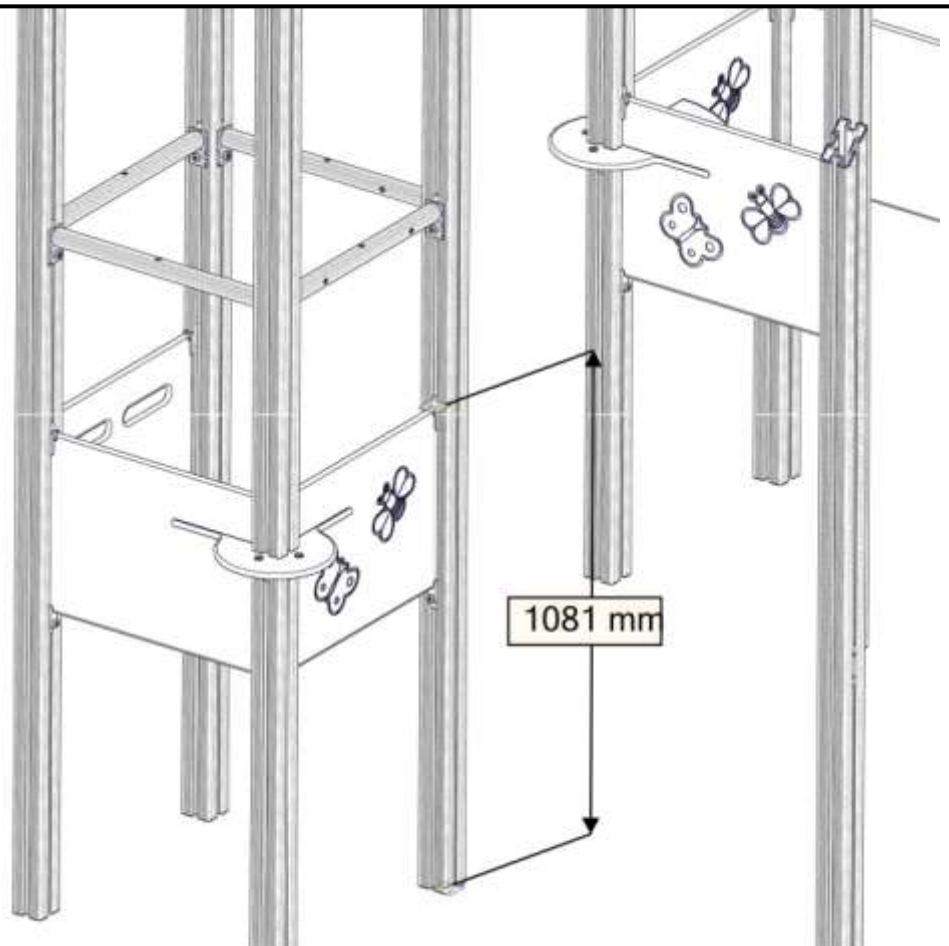

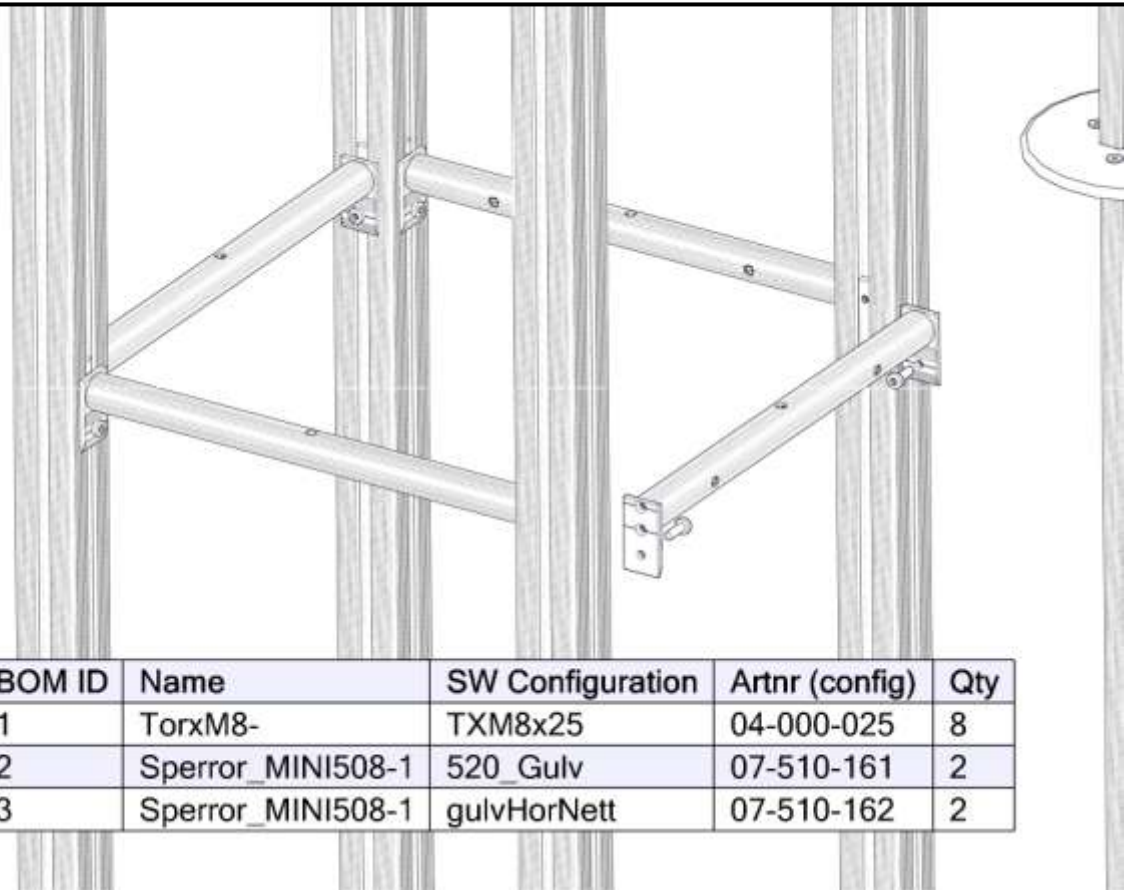

BOM ID	Name	SW Configuration	Artnr (config)	Qty
1	Torxm8-	TXM8x25	04-000-025	8
2	Sperror_MINI508-1	520_Gulv	07-510-161	2
3	Sperror_MINI508-1	gulvHorNett	07-510-162	2

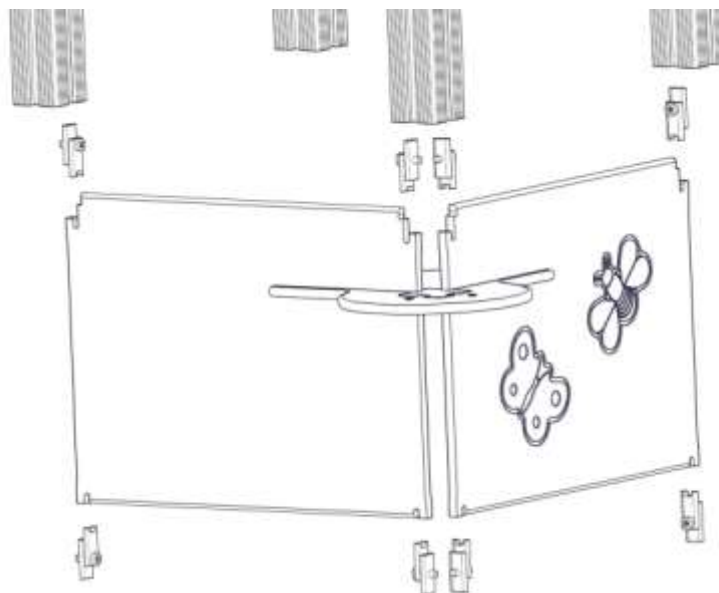

BOM ID	Name	SW Configuration	Artnr (config)	Qty
1	Torxm8-1	TXM8x25	04-000-025	8
2	brikke SFA5116Special-1	12mm	04-060-041	8
3	brikke SFA5116-1	50_1T	04-060-050	8
4	VeggMini520x400-1	Med_Spor	07-510-112	2
5	SeteRundStolpe-1	Stor	07-510-132	1

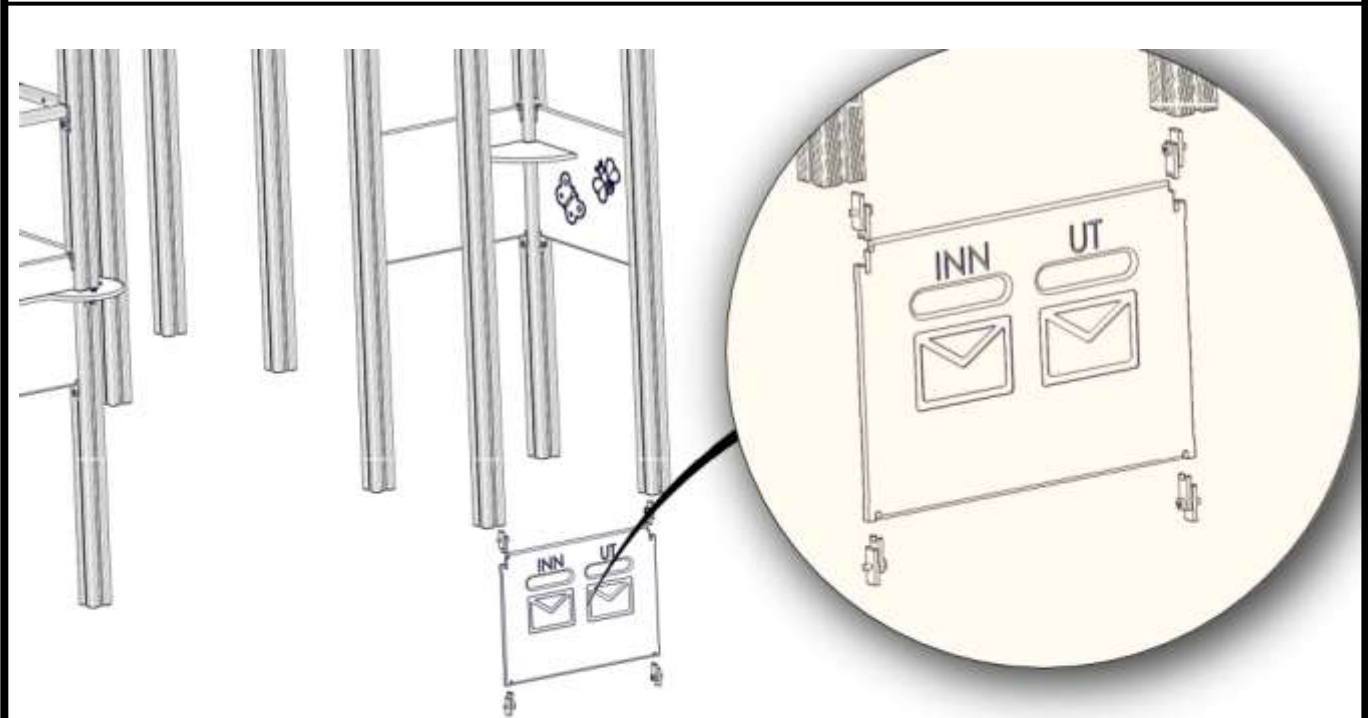
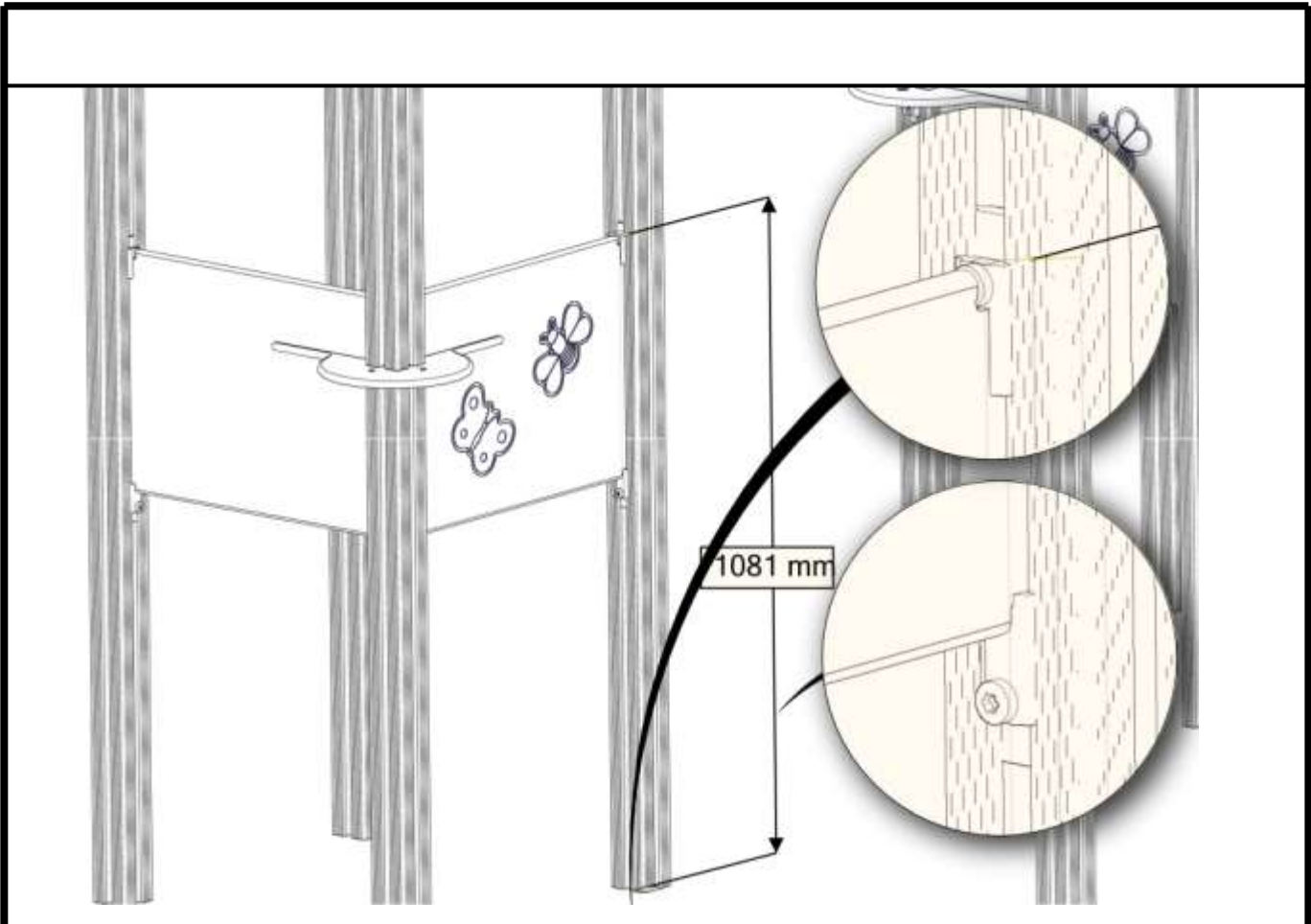

BOM ID	Name	SW Configuration	Artnr (config)	Qty
1	TorxM8-1	TXM8x25	04-000-025	4
2	brikke_SFA5116Special-1	12mm	04-060-041	4
3	brikke_SFA5116-1	50_1T	04-060-050	4
4	VeggMini520x400-1	Postkase	07-510-111	1

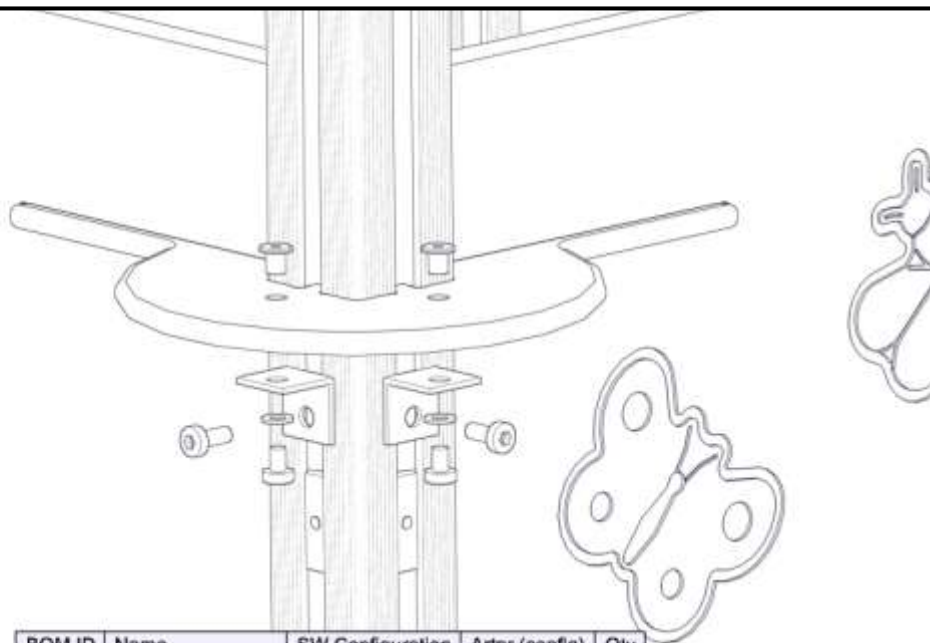

BOM ID	Name	SW Configuration	Artnr (config)	Qty
1	TorxM8-1	TXM8x12	04-000-012	2
2	TorxM8-2	TXM8x20	04-000-020	2
3	Mobelknapp-1	M8 13 17	04-030-011	2
4	Skive-1	M8	04-050-008	2
5	brikke SFA5116-1	50 1T	04-060-050	2
6	35x35x3-1	11mm	04-070-036	2

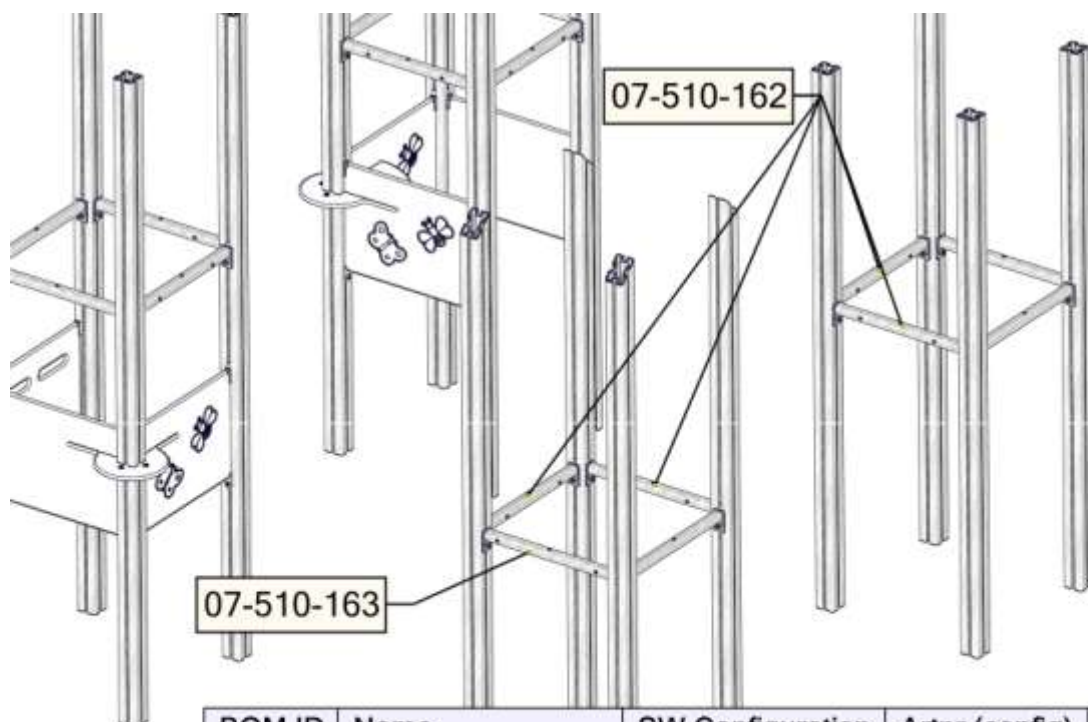

BOM ID	Name	SW Configuration	Artnr (config)	Qty
1	TorxM8-	TXM8x25	04-000-025	16
2	Sperror_MINI508-1	520_Gulv	07-510-161	3
3	Sperror_MINI508-1	gulvHorNett	07-510-162	4
4	Sperror_MINI508-1	GulvHor_Rung	07-510-163	1

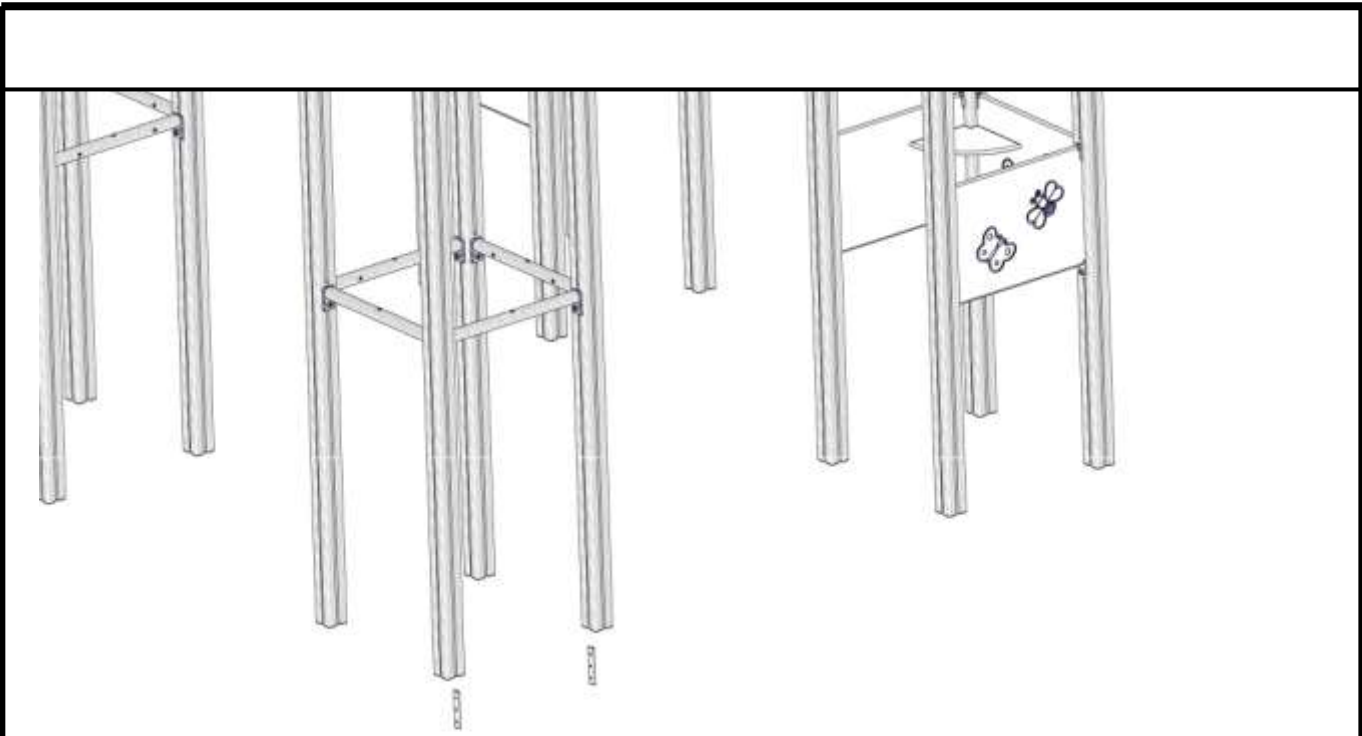

BOM ID	Name	SW Configuration	Artnr (config)	Qty
1	brikke_SFA5116-	120_3T	04-060-120	2

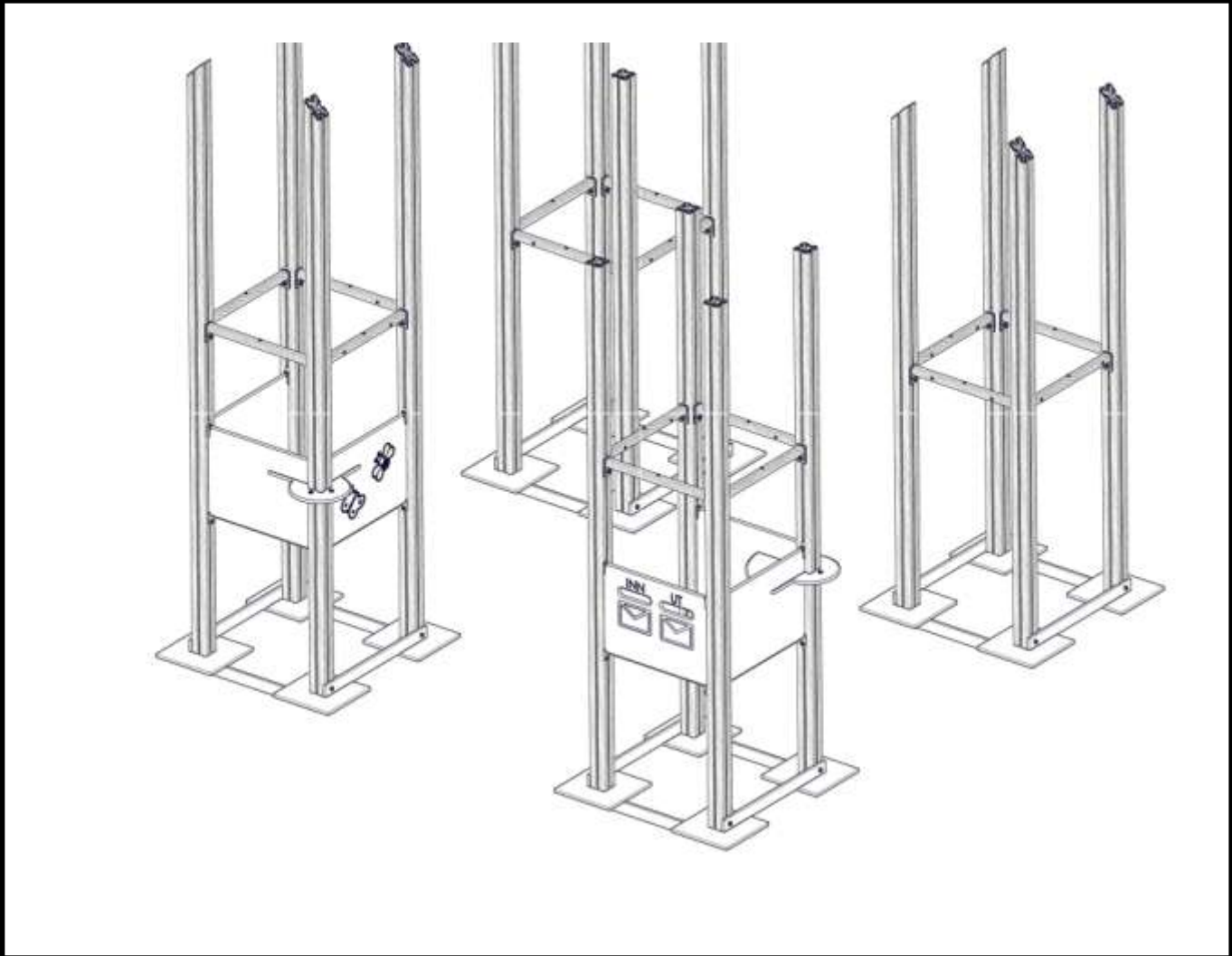

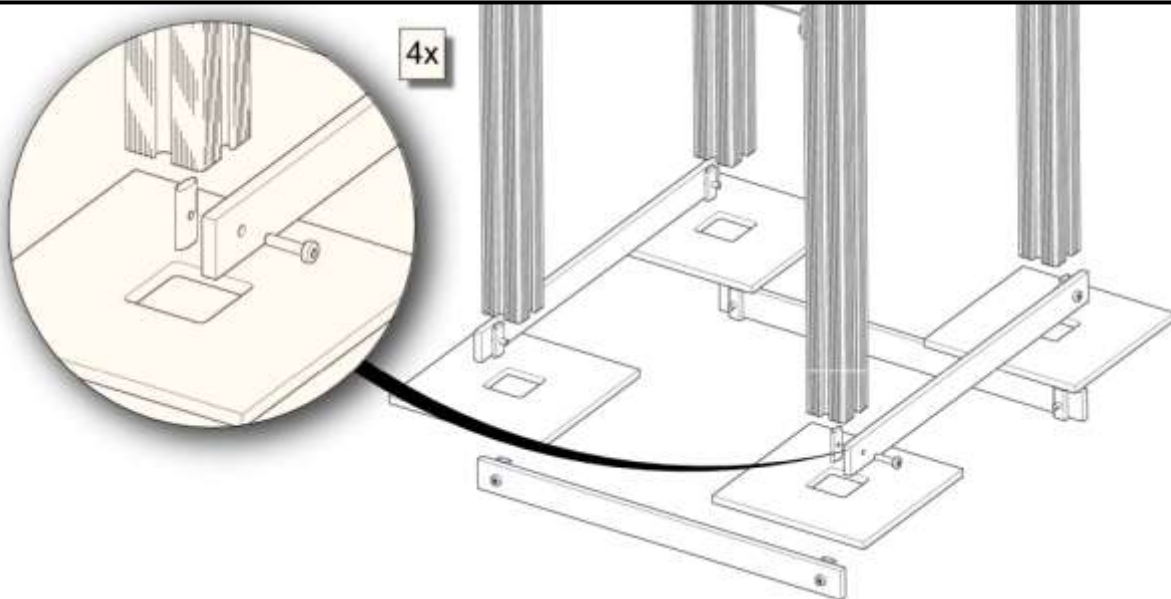

BOM ID	Name	SW Configuration	Artnr (config)	Qty
1	Torxm8-	TXM8x35	04-000-035	8
2	brikke_SFA5116-	50_1T	04-060-050	8
3	minifun_sprosse-1	660	07-510-200	4
4	minifunSkive-	Default	07-510-201	4

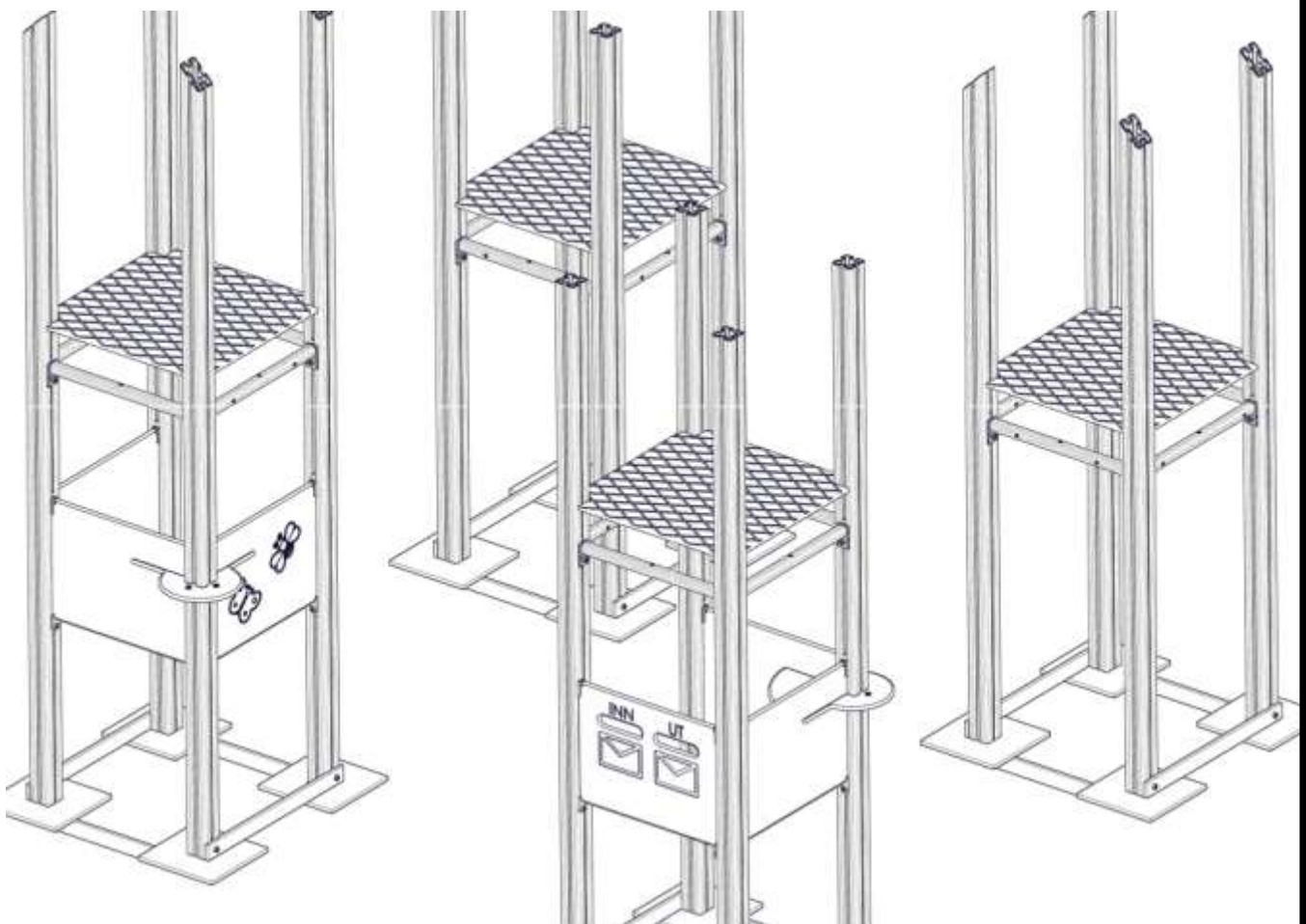

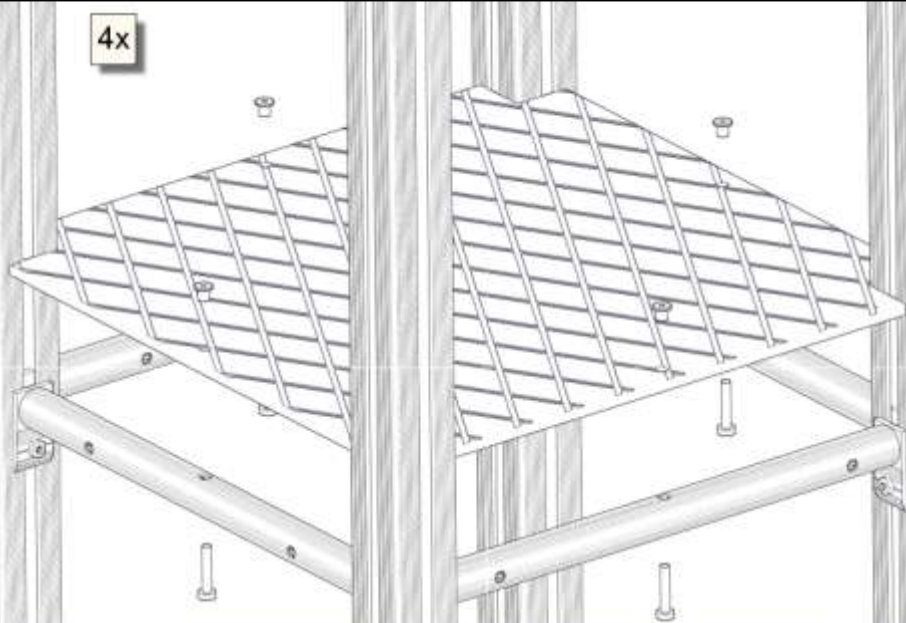

BOM ID	Name	SW Configuration	Artnr (config)	Qty
1	Torxm8-1	TXM8x45	04-000-045	4
2	Mobelknapp-1	M8_13_17	04-030-011	4
3	gulvmini-2	Default	07-510-102	1

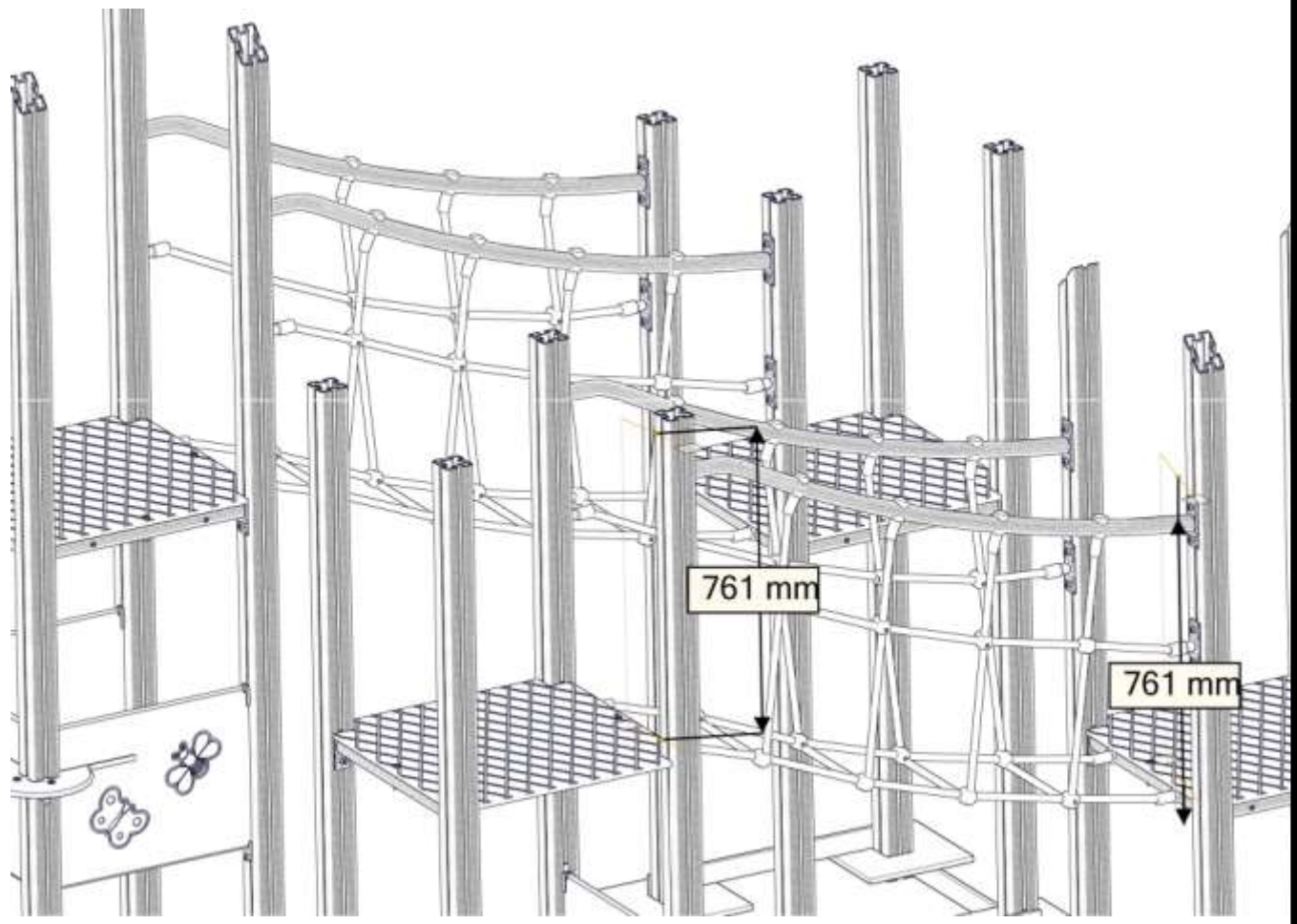

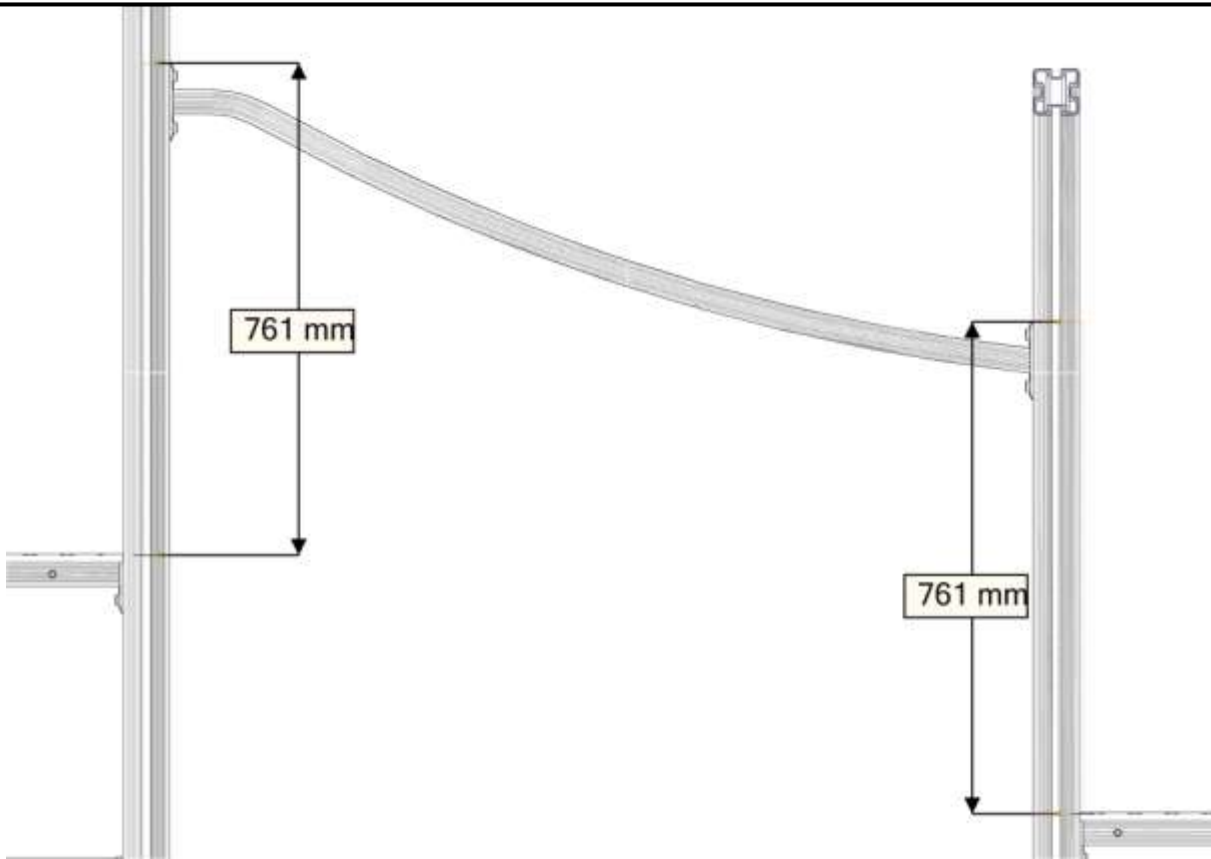

4x

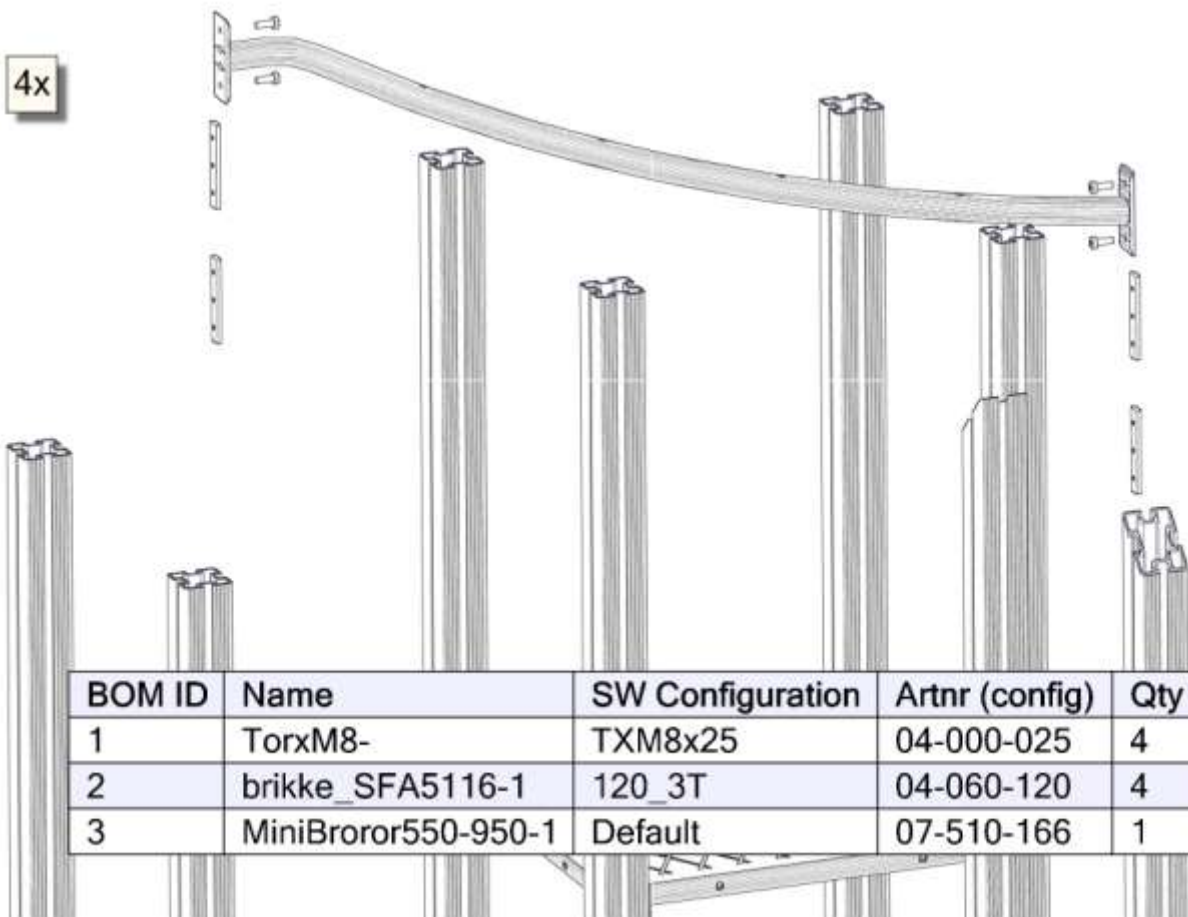

BOM ID	Name	SW Configuration	Artnr (config)	Qty
1	Torxm8-	TXM8x25	04-000-025	4
2	brikke_SFA5116-1	120_3T	04-060-120	4
3	MiniBroror550-950-1	Default	07-510-166	1



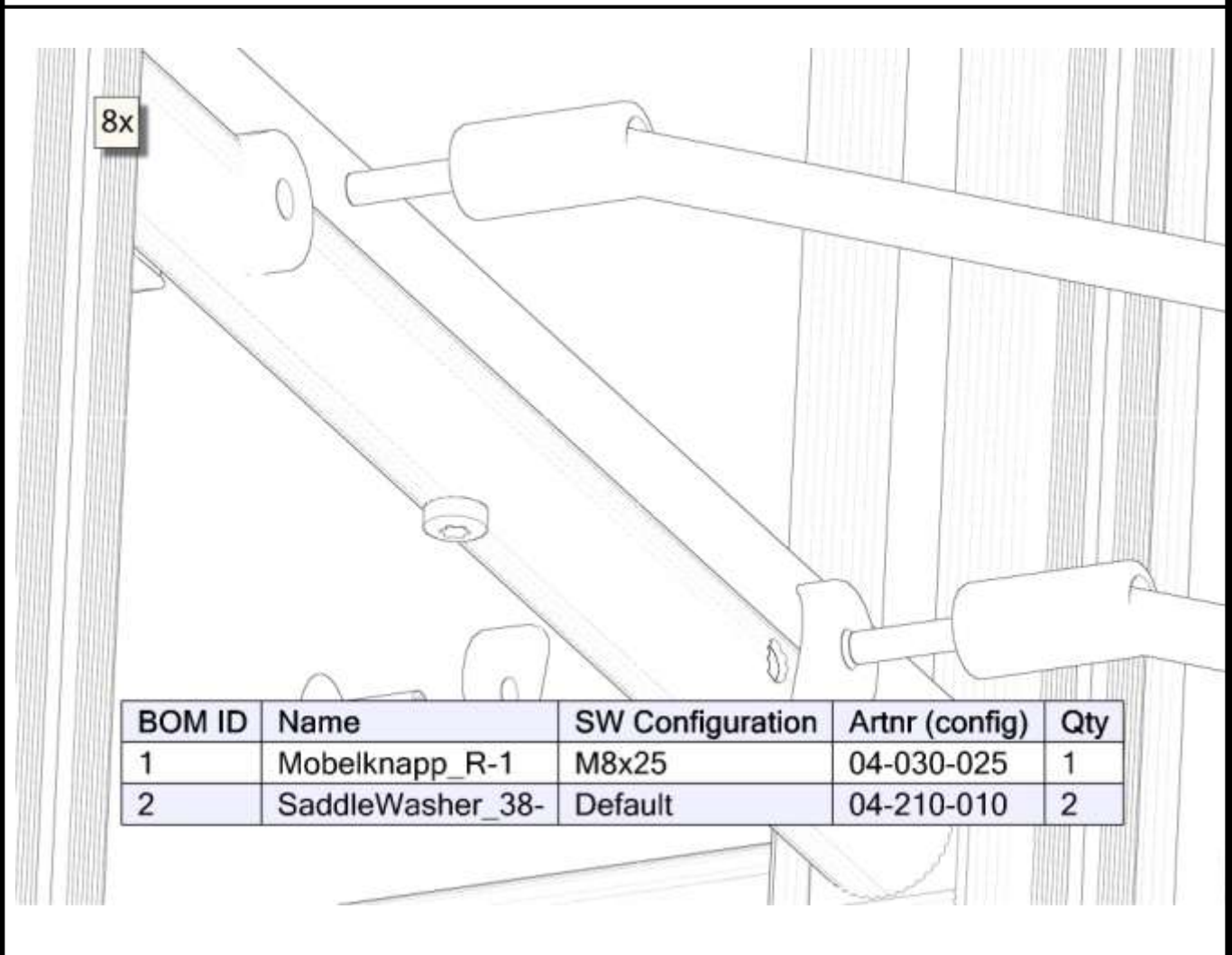
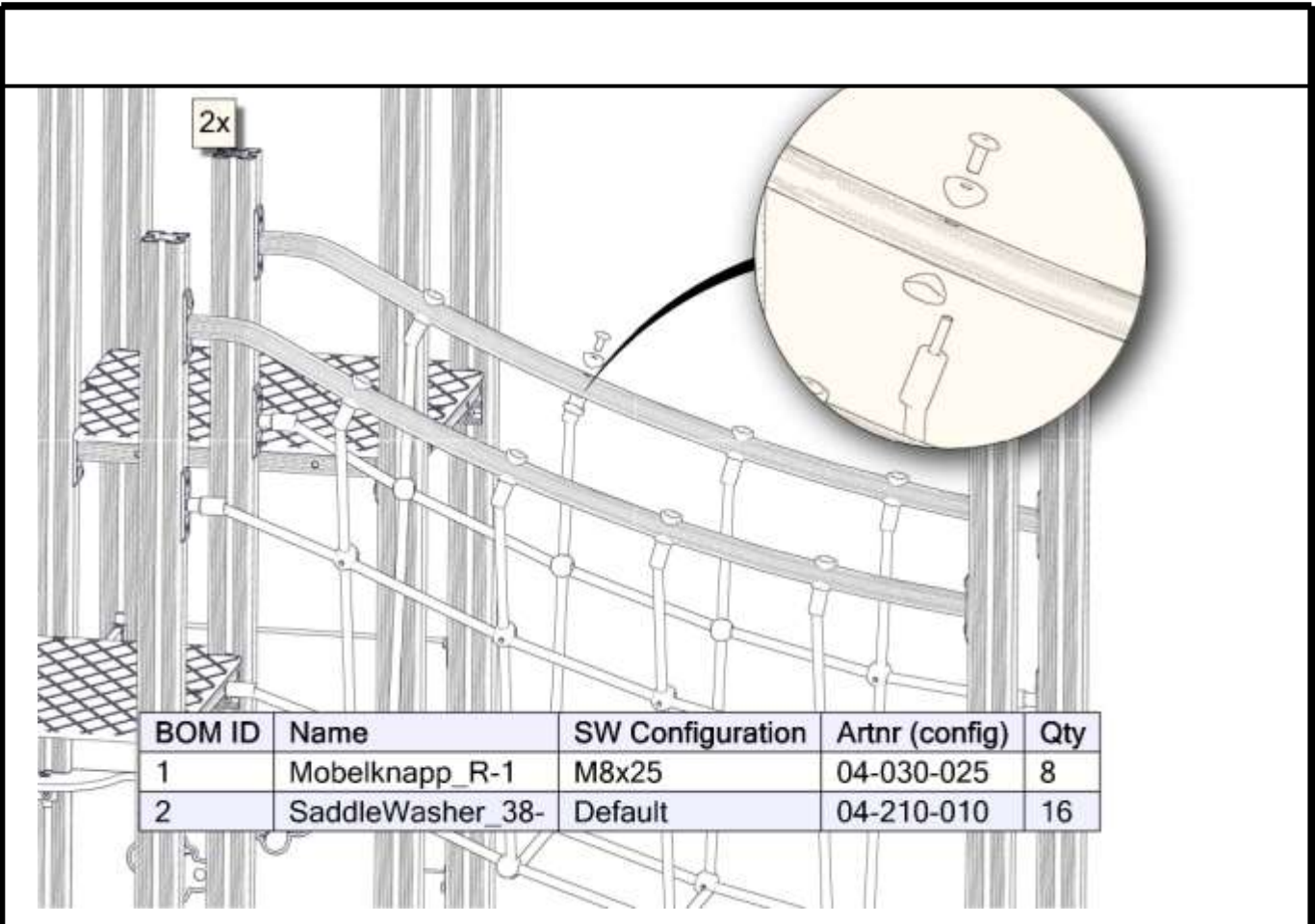

8x

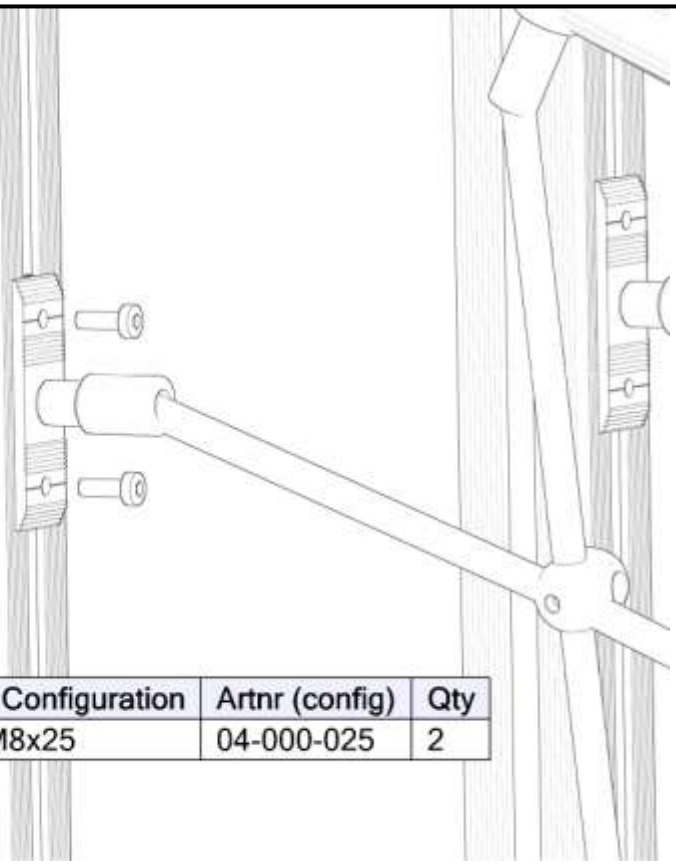

BOM ID	Name	SW Configuration	Artnr (config)	Qty
1	TorxM8-	TXM8x25	04-000-025	2

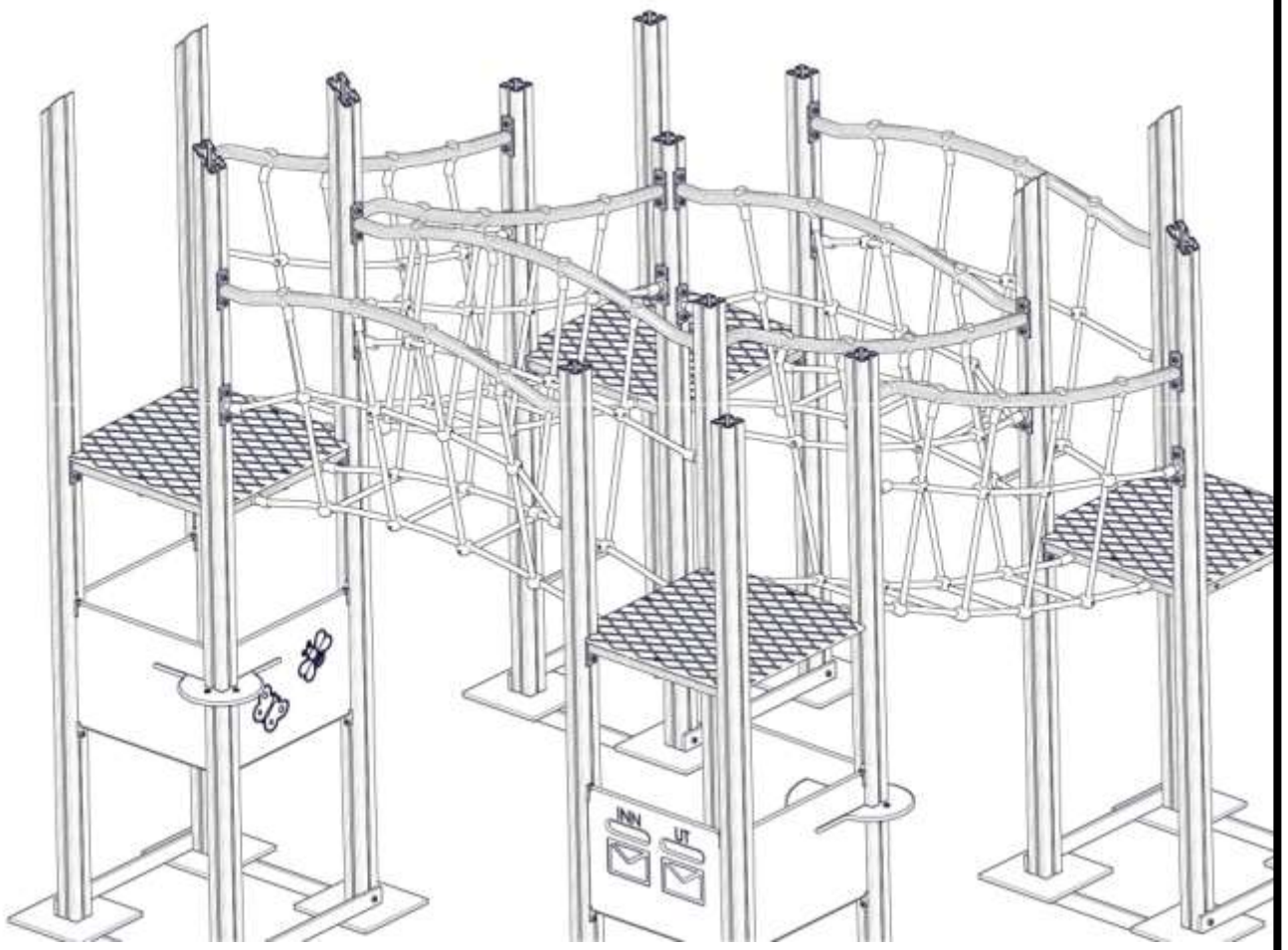

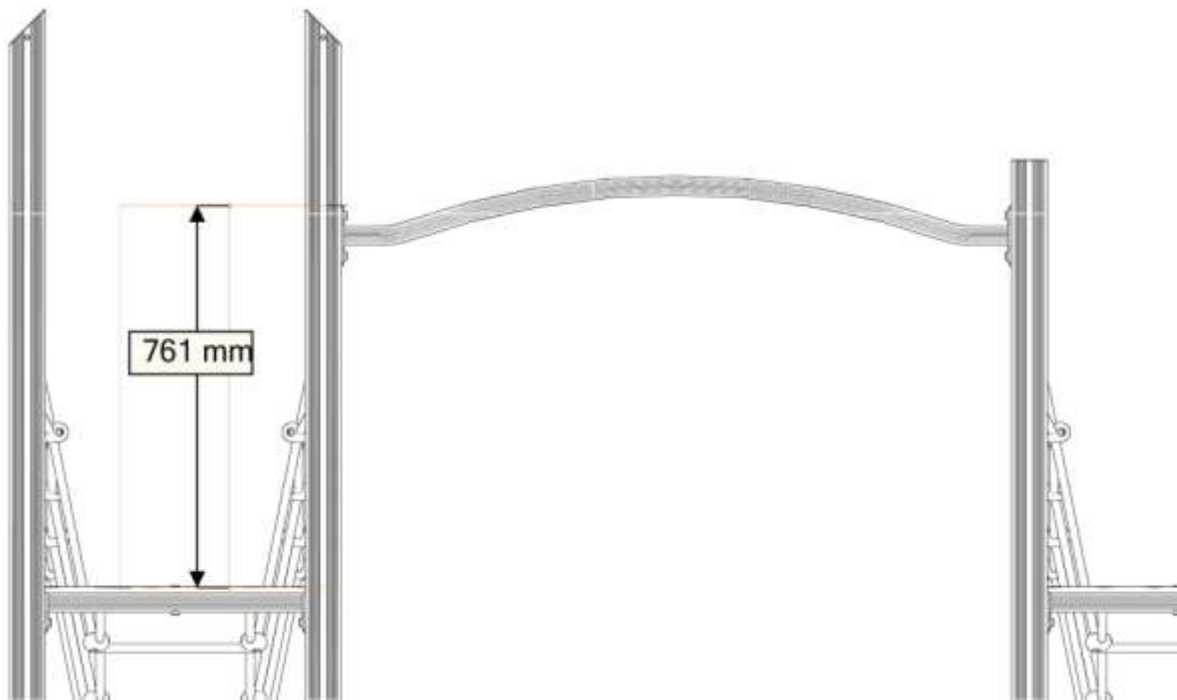

4x

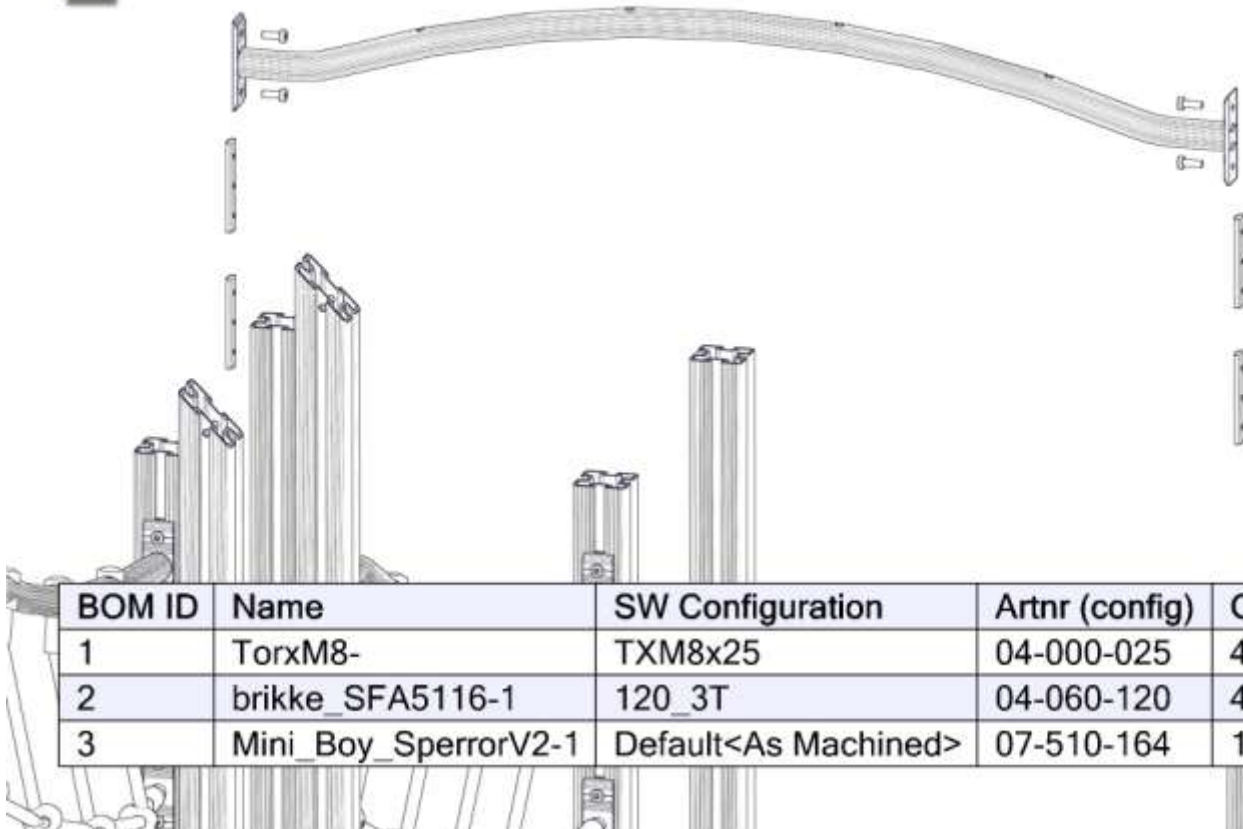

BOM ID	Name	SW Configuration	Artnr (config)	Qty
1	TorxM8-	TXM8x25	04-000-025	4
2	brikke_SFA5116-1	120_3T	04-060-120	4
3	Mini_Boy_SperrorV2-1	Default<As Machined>	07-510-164	1

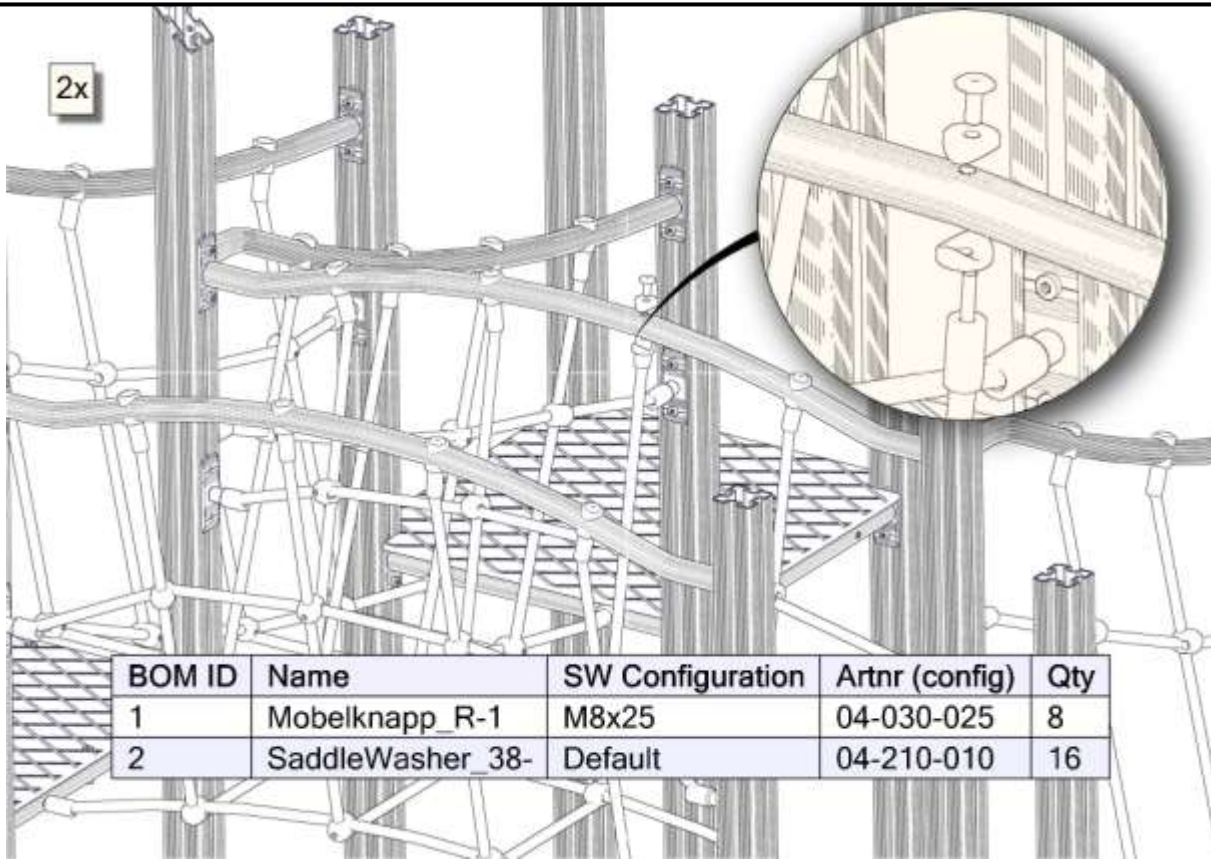

BOM ID	Name	SW Configuration	Artnr (config)	Qty
1	Mobelknapp_R-1	M8x25	04-030-025	8
2	SaddleWasher_38-	Default	04-210-010	16

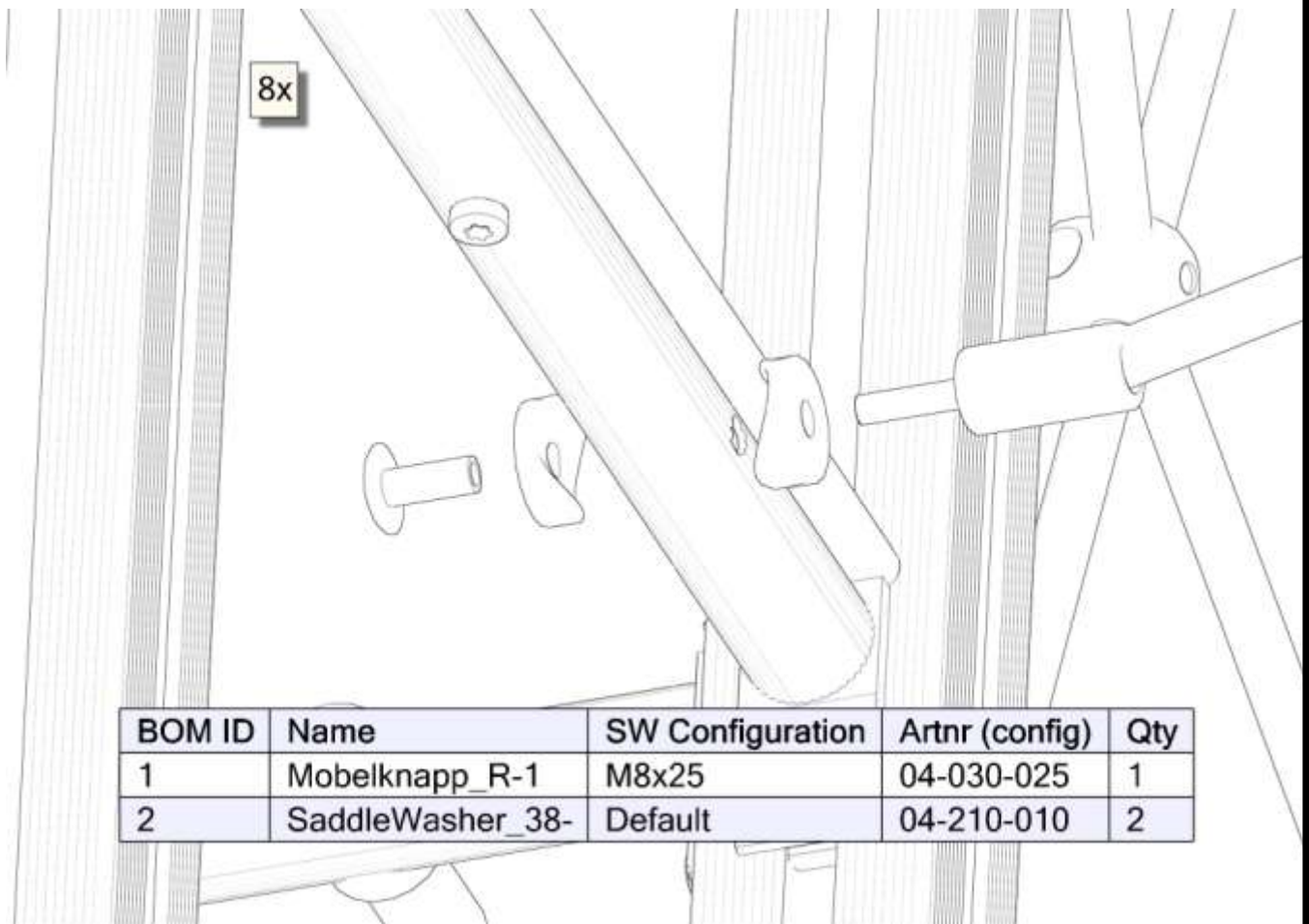

BOM ID	Name	SW Configuration	Artnr (config)	Qty
1	Mobelknapp_R-1	M8x25	04-030-025	1
2	SaddleWasher_38-	Default	04-210-010	2

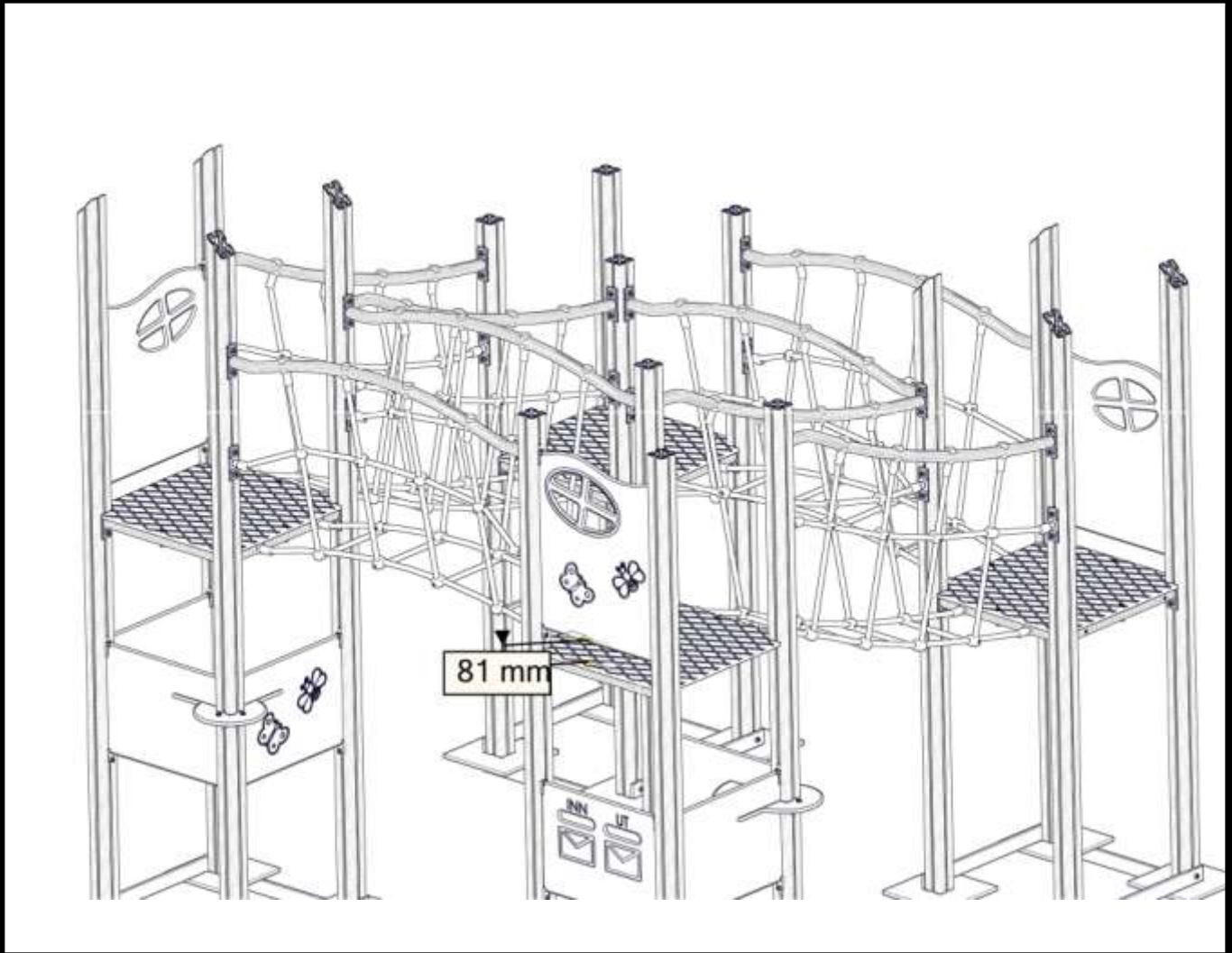
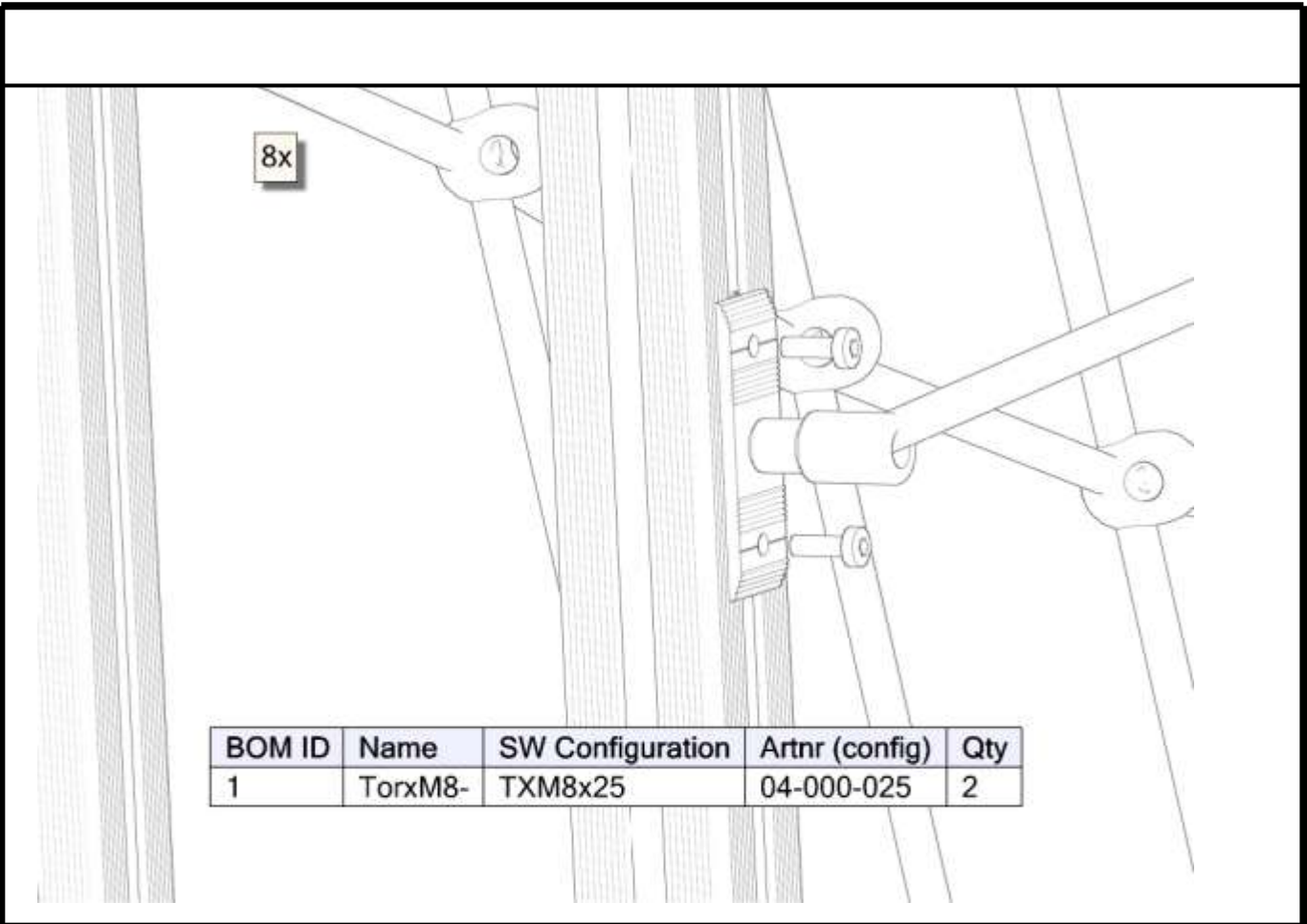

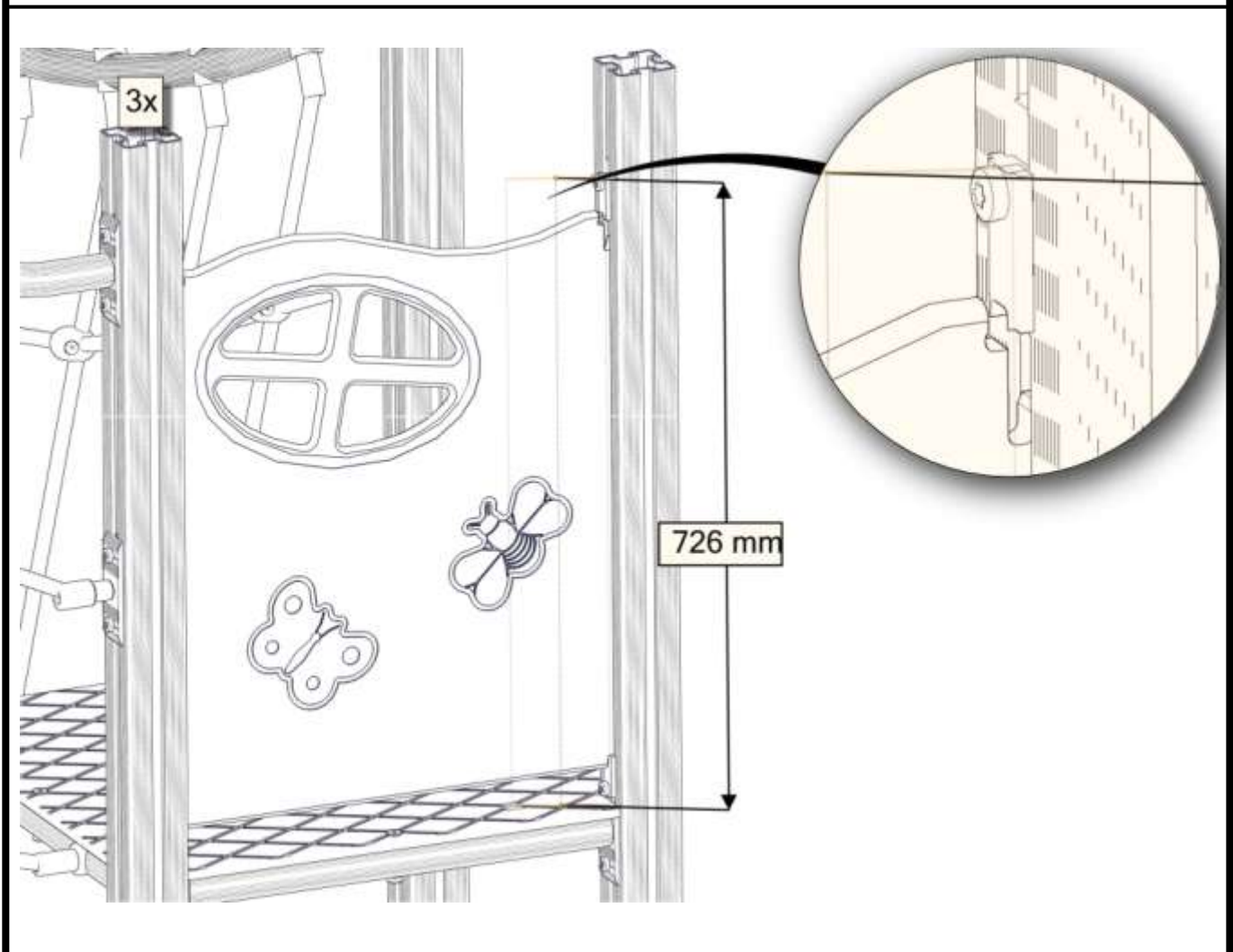
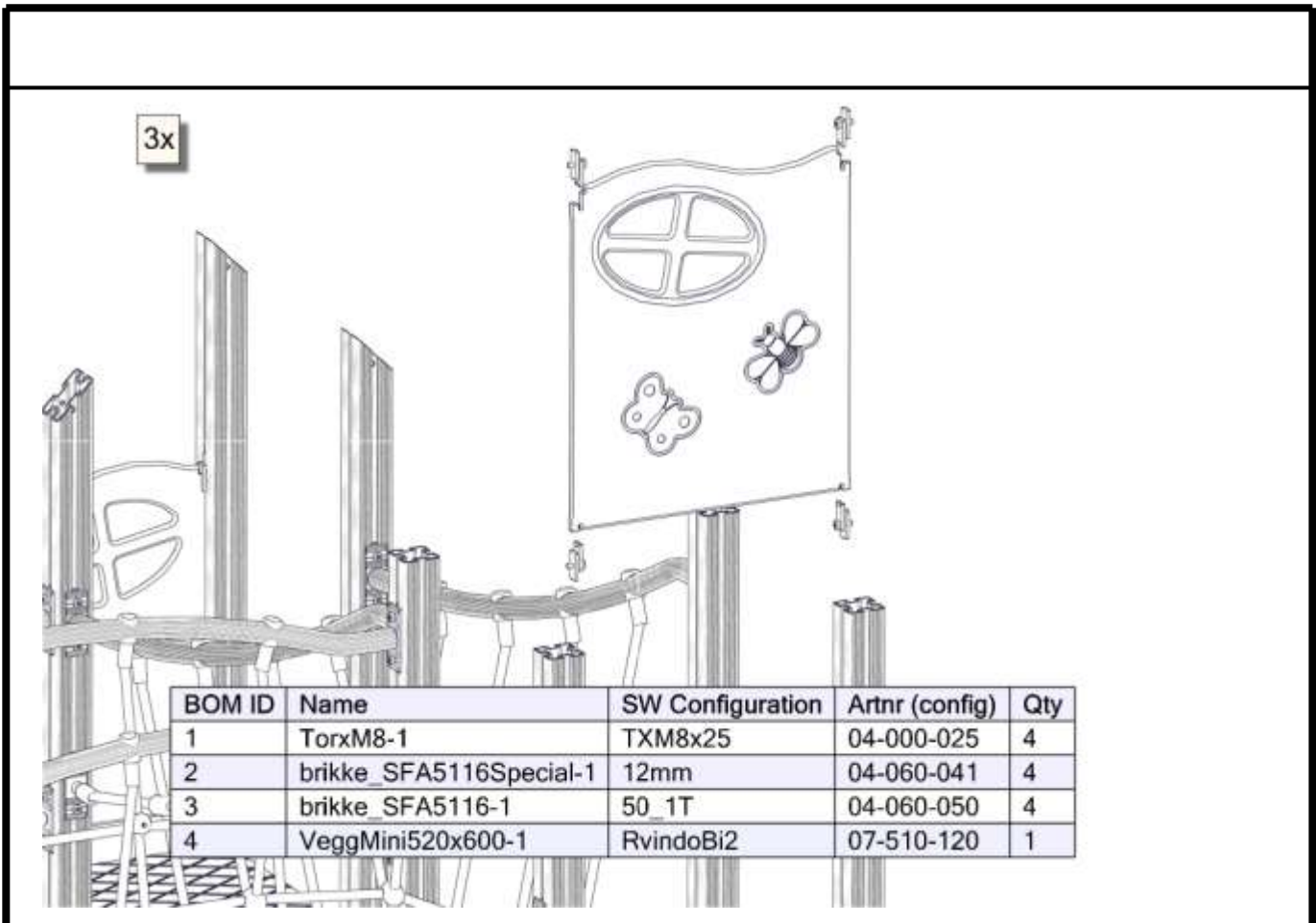

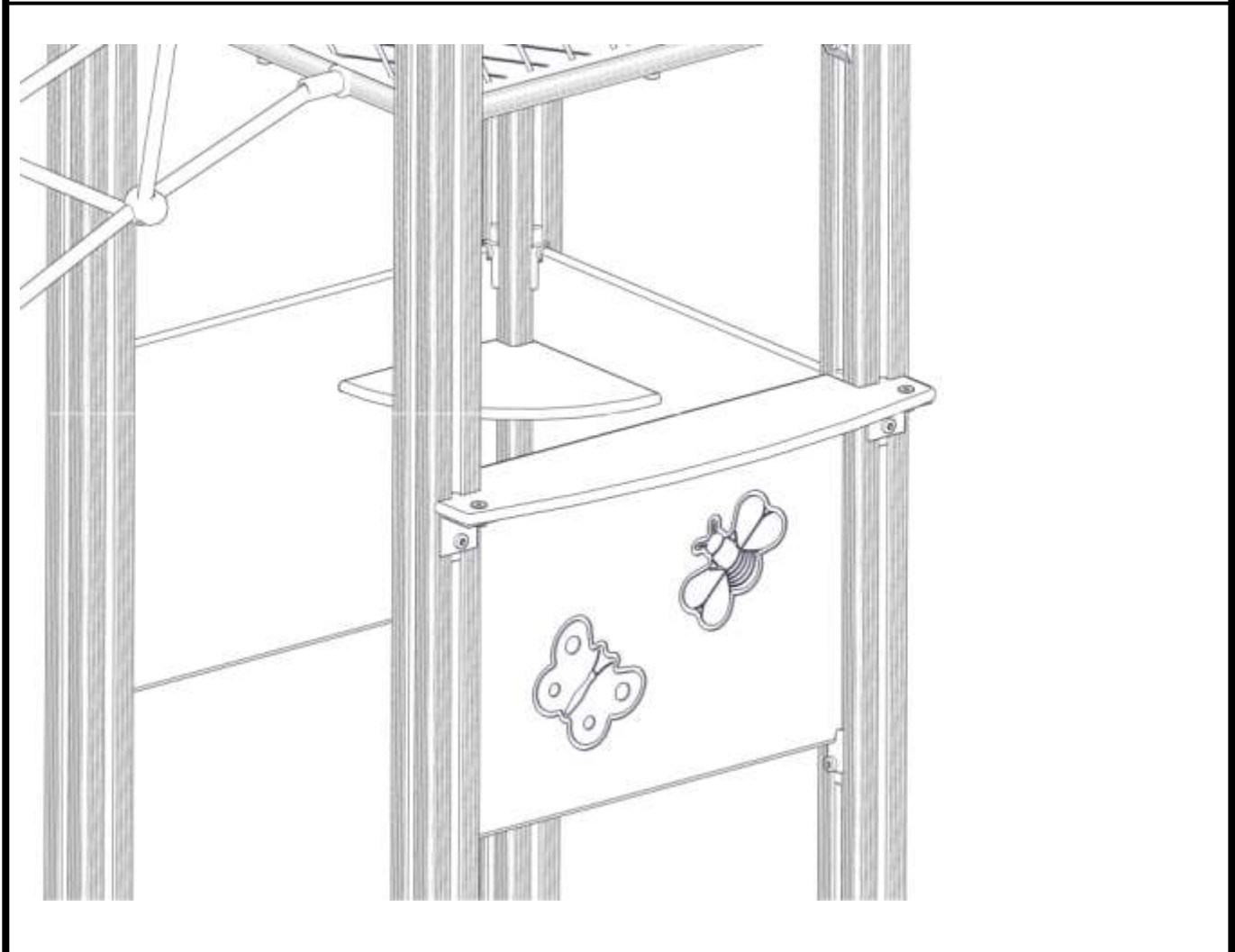
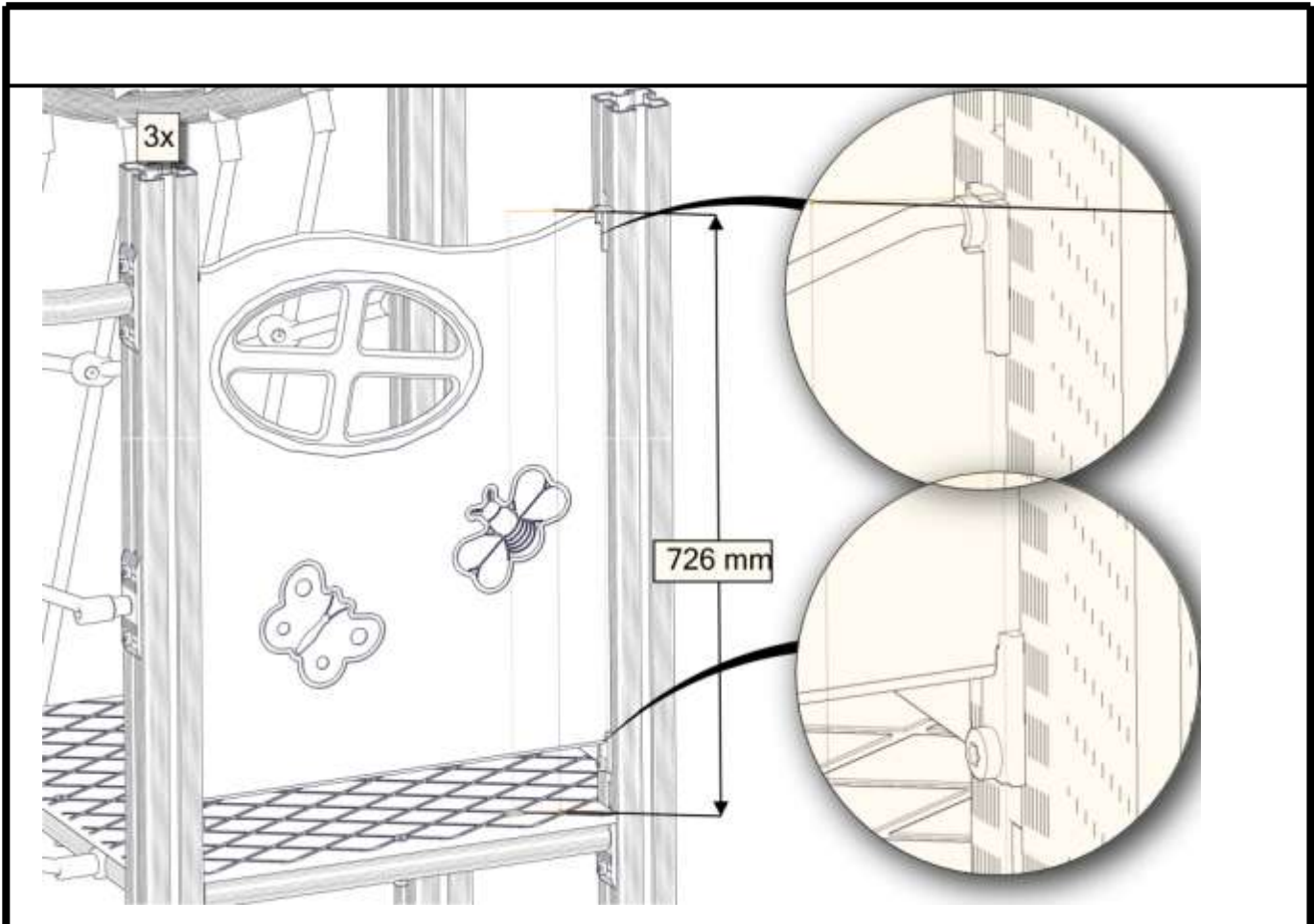

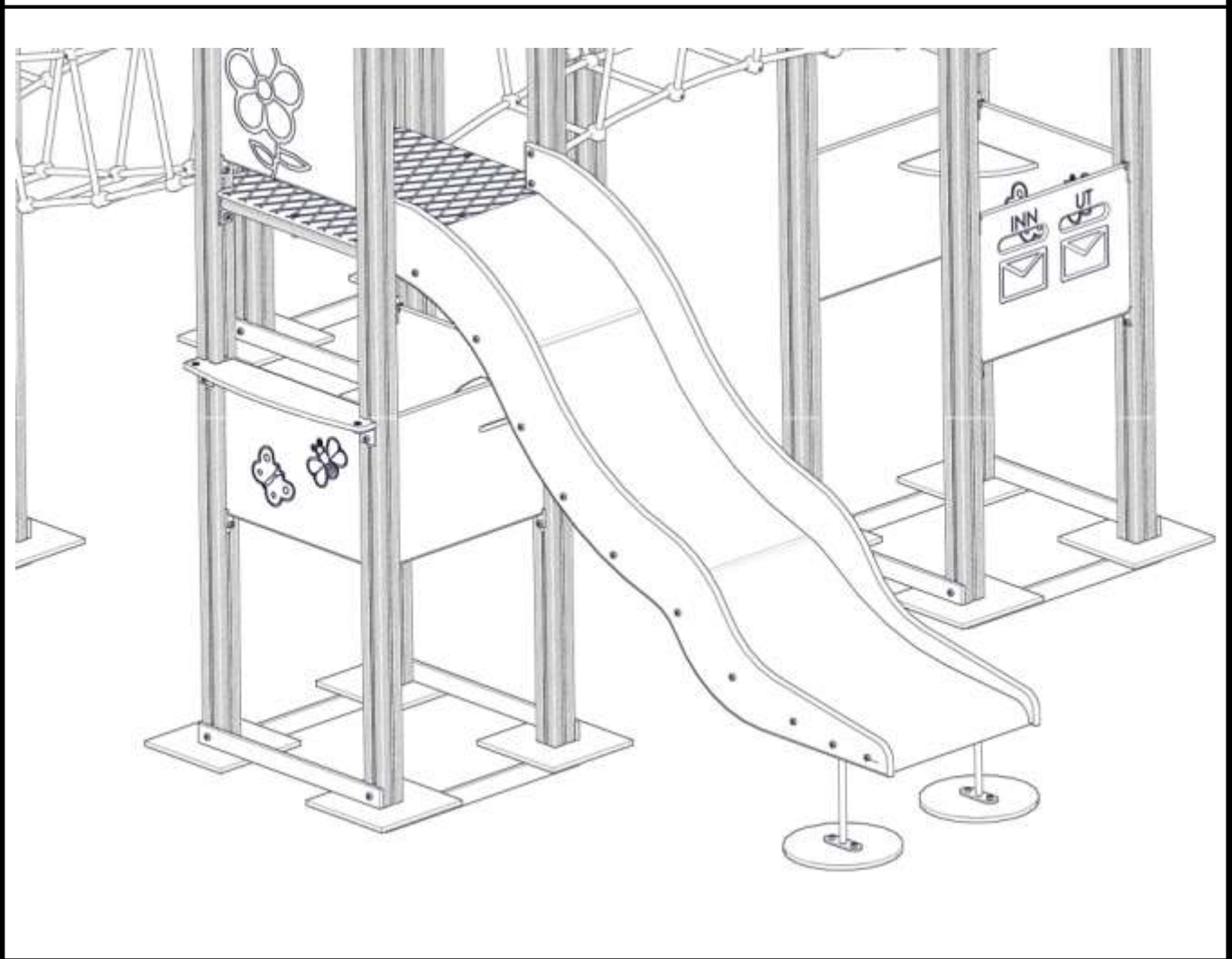
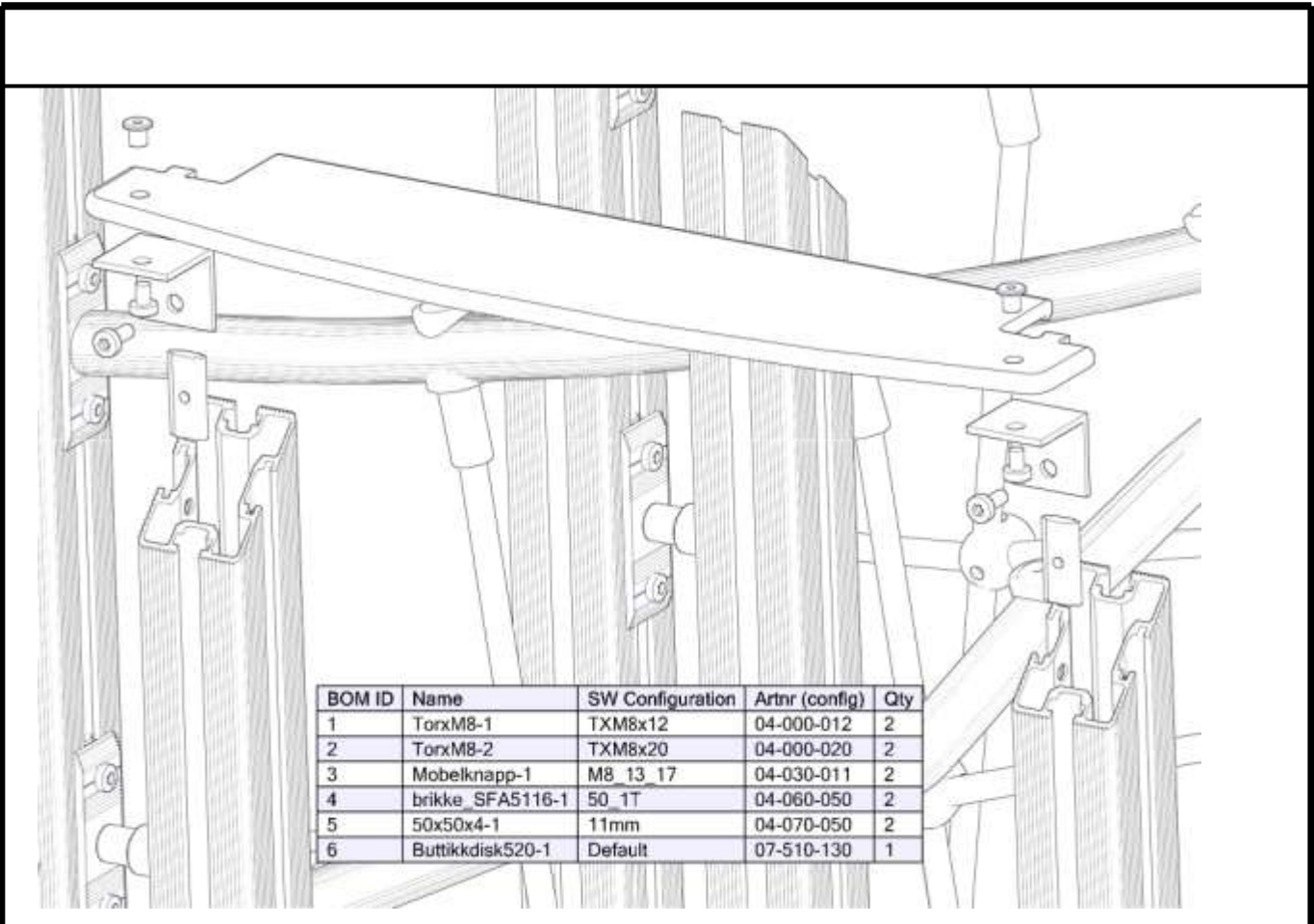



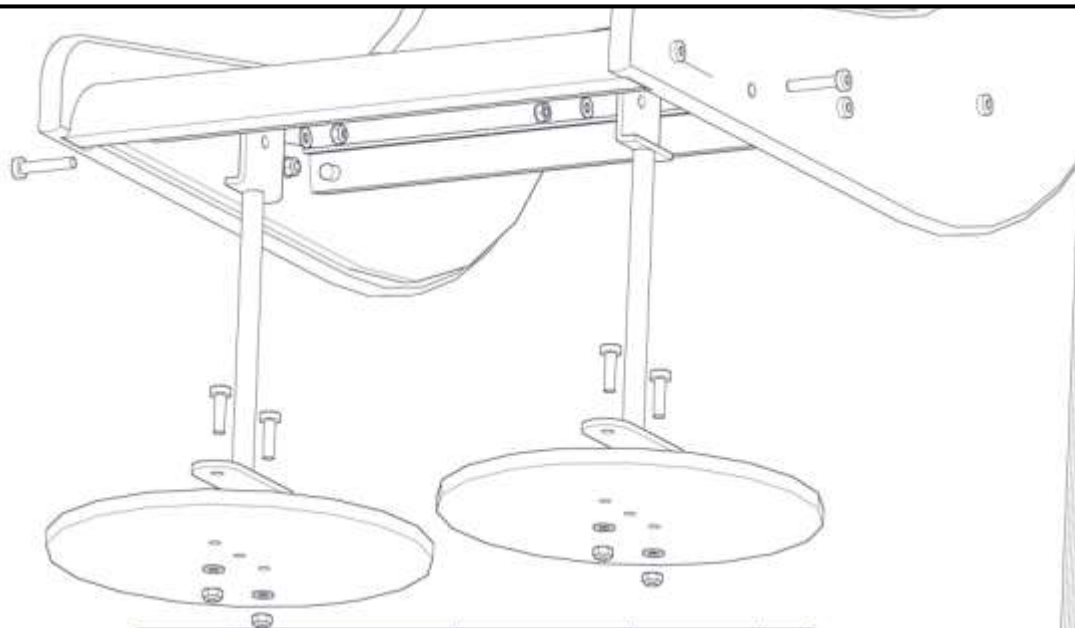

BOM ID	Name	SW Configuration	Artnr (config)	Qty
1	Fundament platte 2H-1	Hoh80	00-003-106	2
2	Stalforankring-1	liten	00-100-312	2
3	Torxm8-	TXM8x30	04-000-030	4
4	Torxm8-1	TXM8x45	04-000-045	2
5	mutter M8-	M8 Borg	04-040-008	6
6	Skive-	M8	04-050-008	6

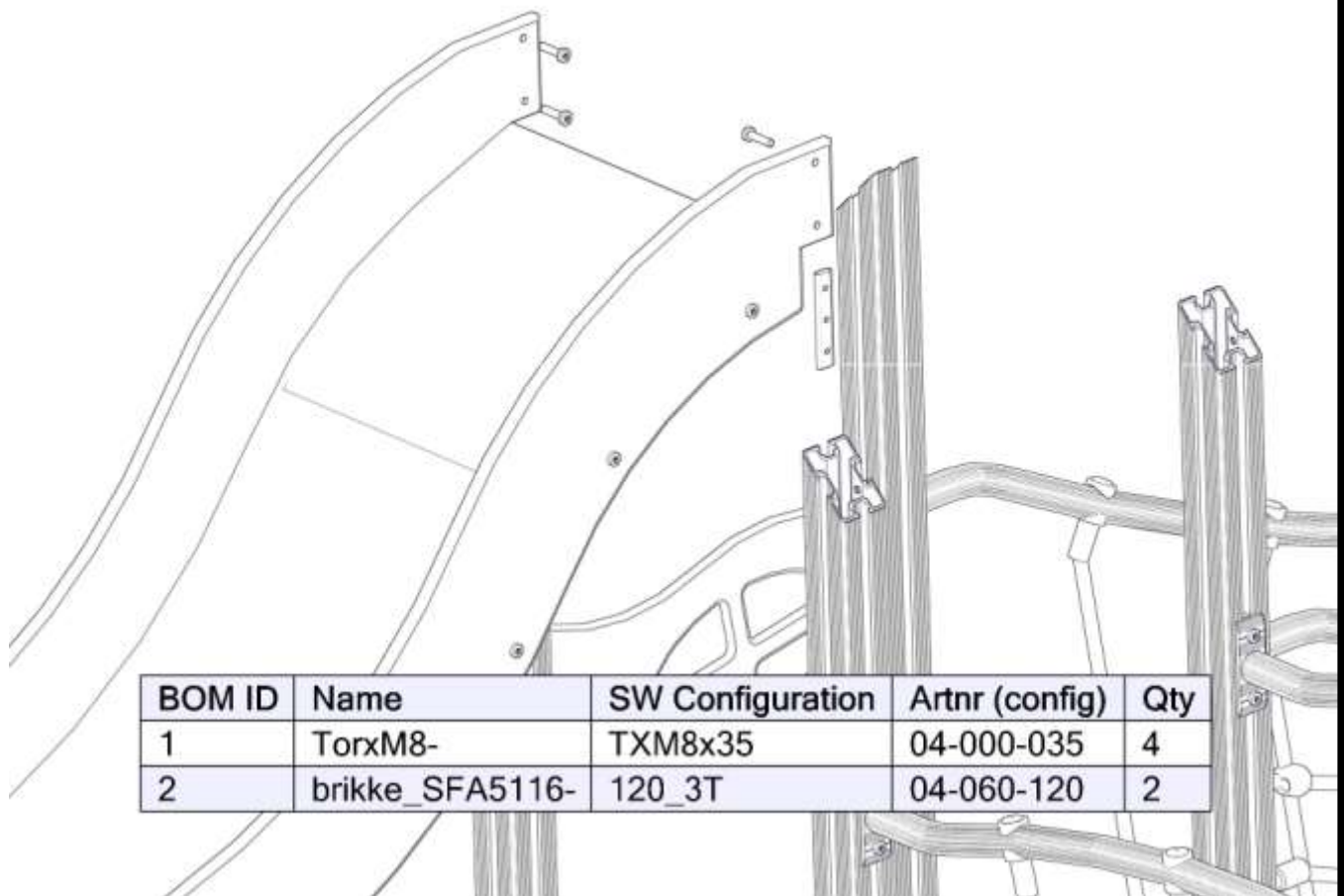

BOM ID	Name	SW Configuration	Artnr (config)	Qty
1	Torxm8-	TXM8x35	04-000-035	4
2	brikke_SFA5116-	120_3T	04-060-120	2

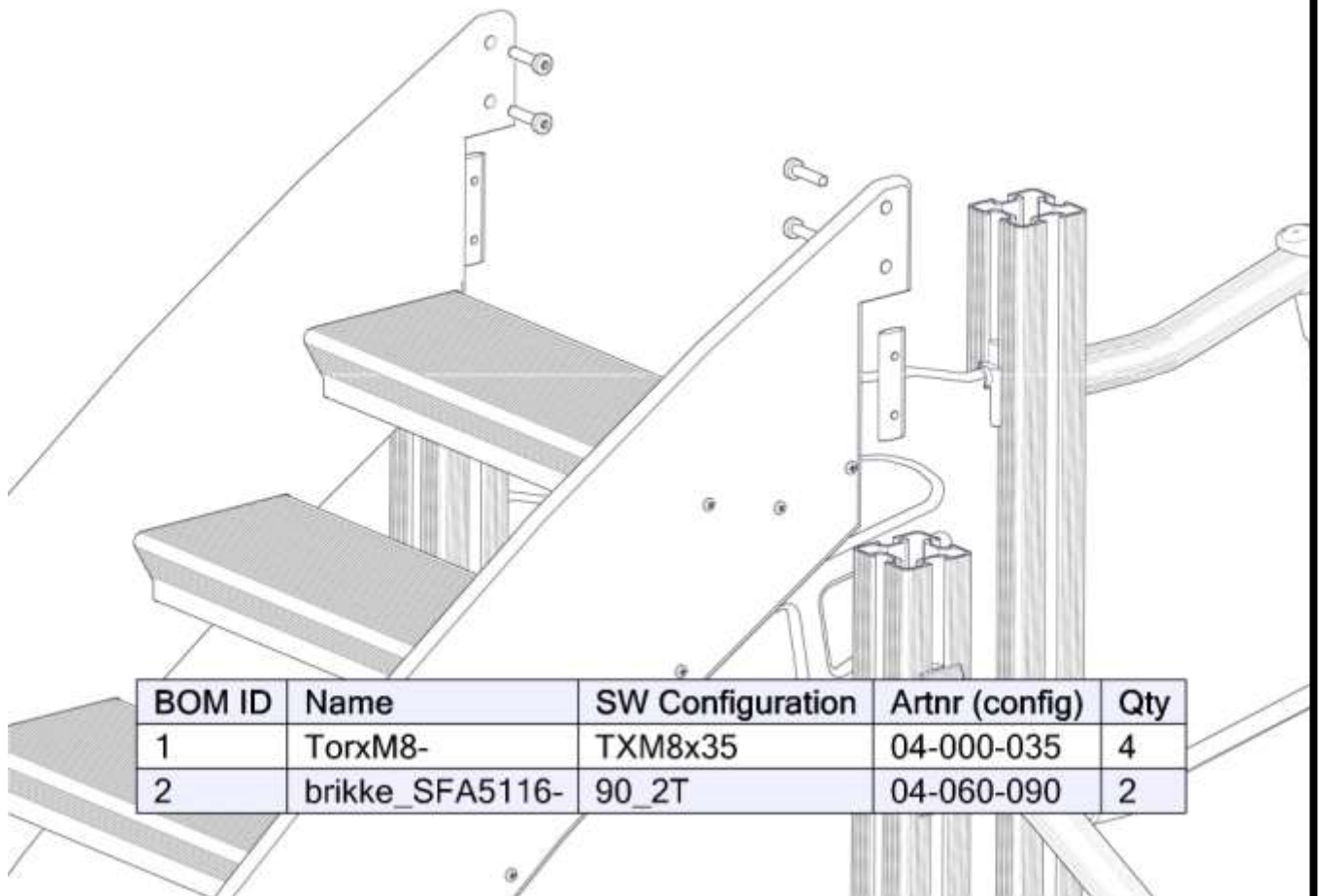
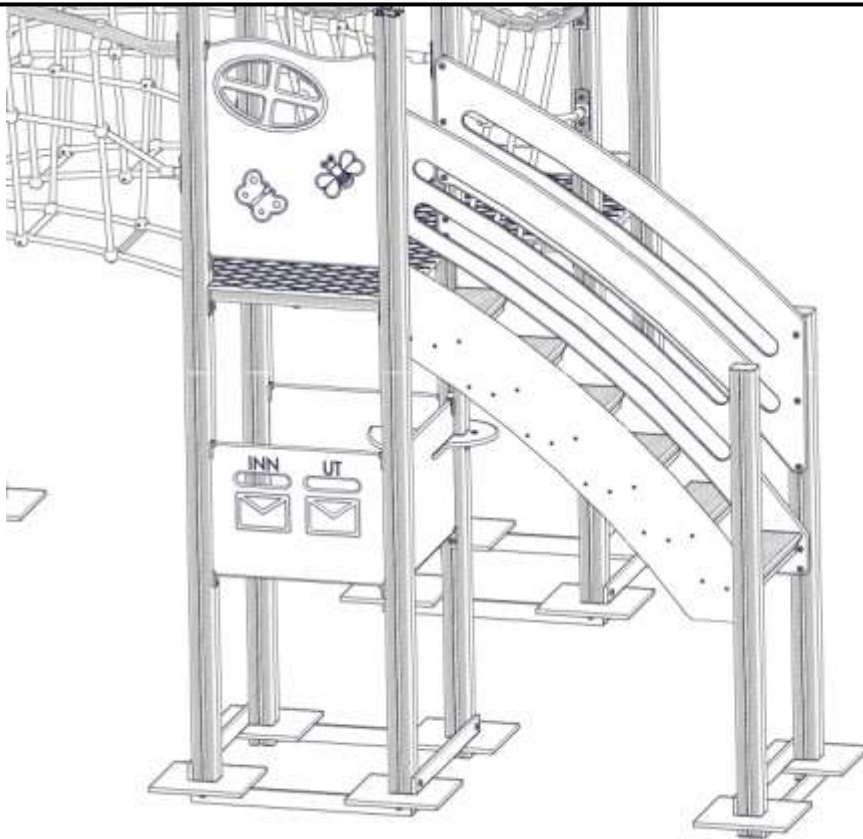

BOM ID	Name	SW Configuration	Artnr (config)	Qty
1	TorxM8-	TXM8x35	04-000-035	4
2	brikke_SFA5116-	90_2T	04-060-090	2

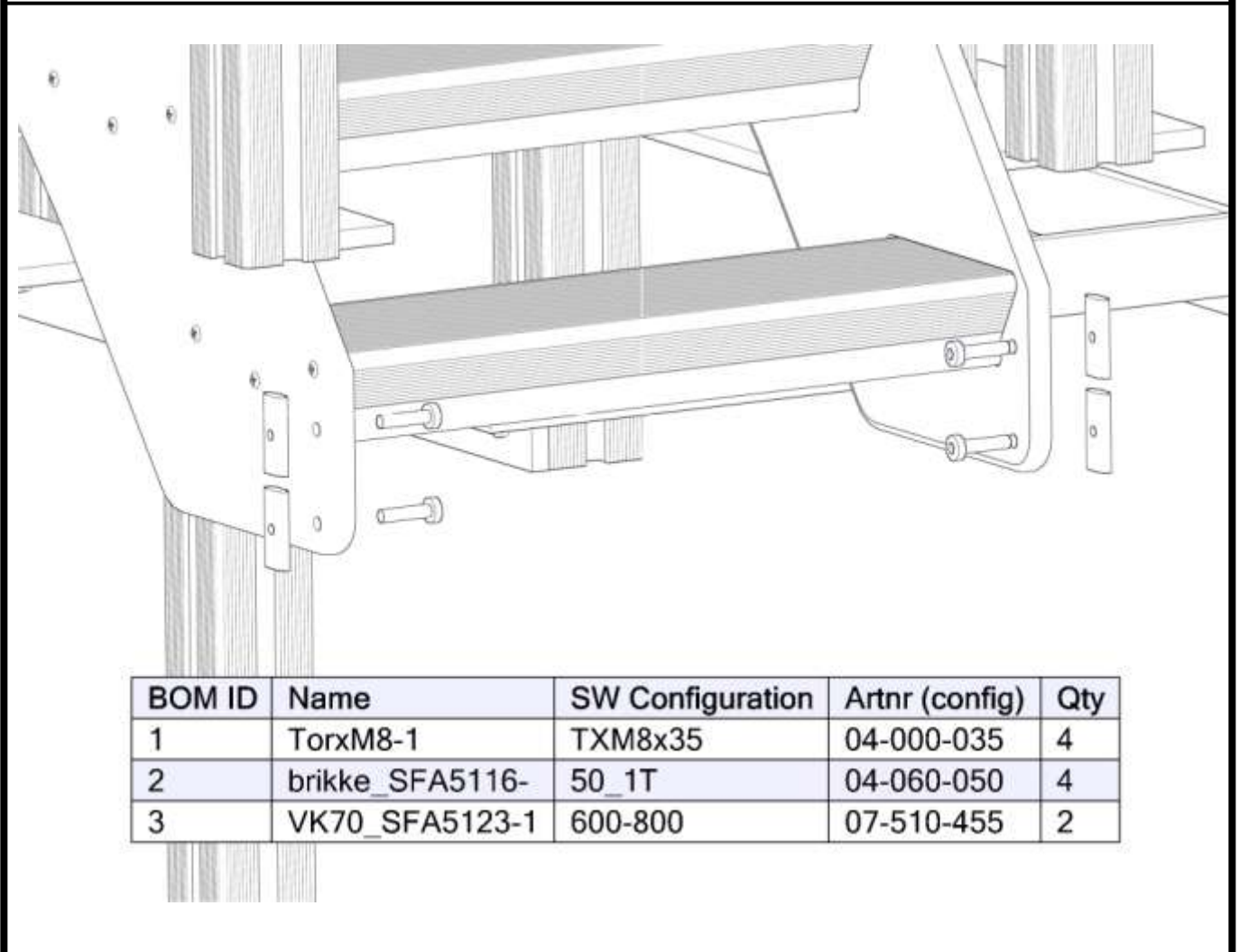
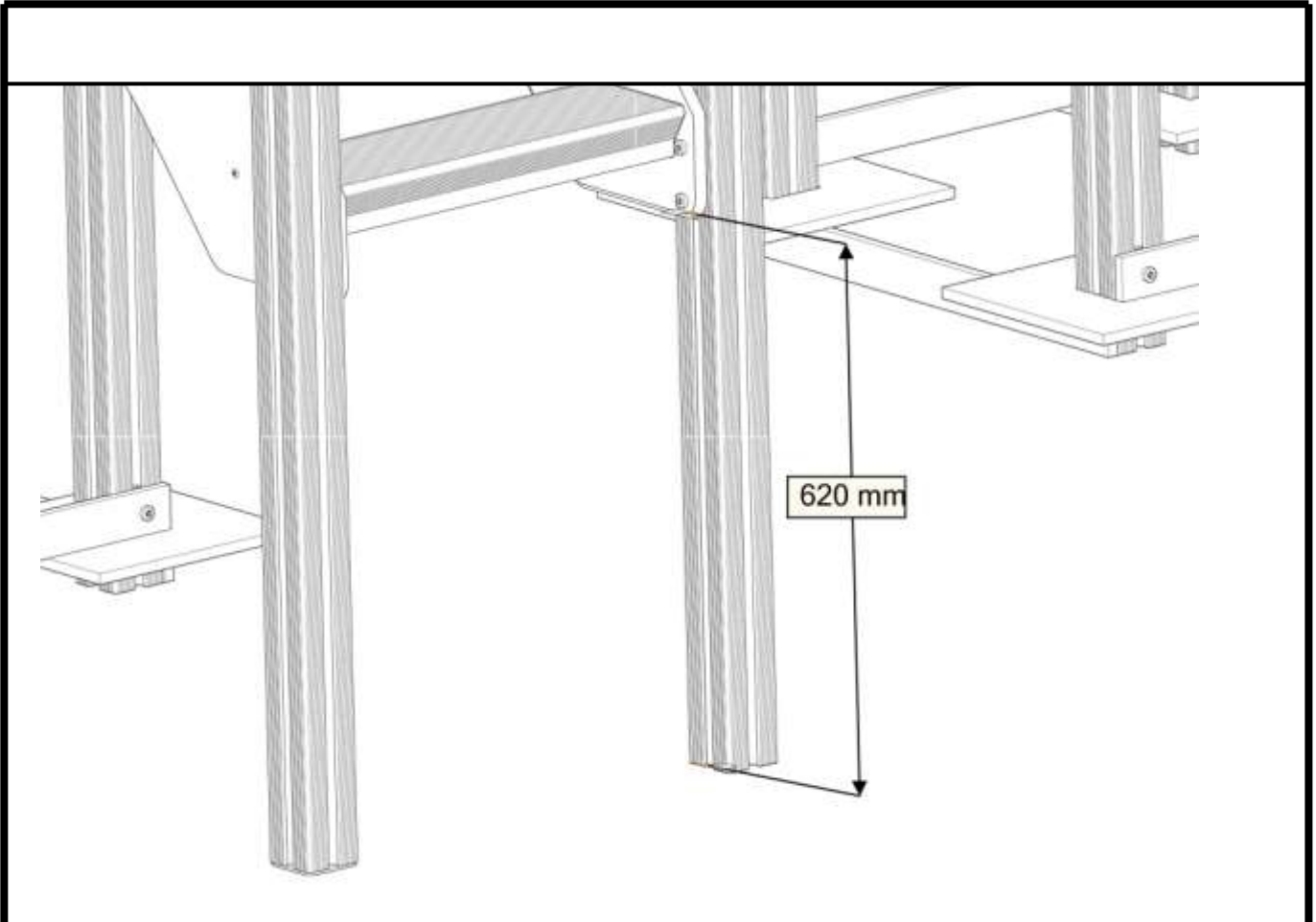

BOM ID	Name	SW Configuration	Artnr (config)	Qty
1	TorxM8-1	TXM8x35	04-000-035	4
2	brikke_SFA5116-	50_1T	04-060-050	4
3	VK70_SFA5123-1	600-800	07-510-455	2

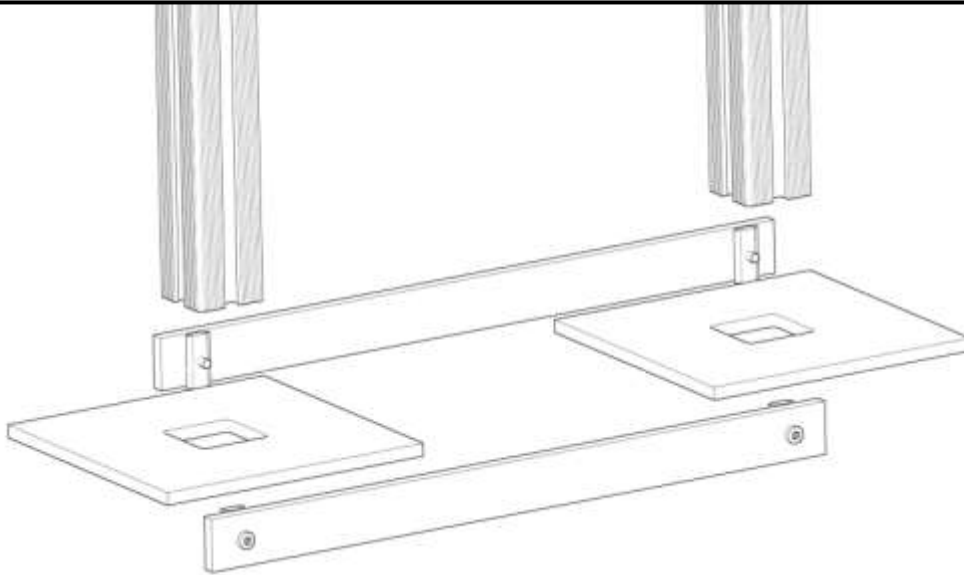

BOM ID	Name	SW Configuration	Artnr (config)	Qty
1	Torxm8-	TXM8x35	04-000-035	4
2	brikke_SFA5116-	50_1T	04-060-050	4
3	minifun_sprosse-1	660	07-510-200	2
4	minifunSkive-	Default	07-510-201	2

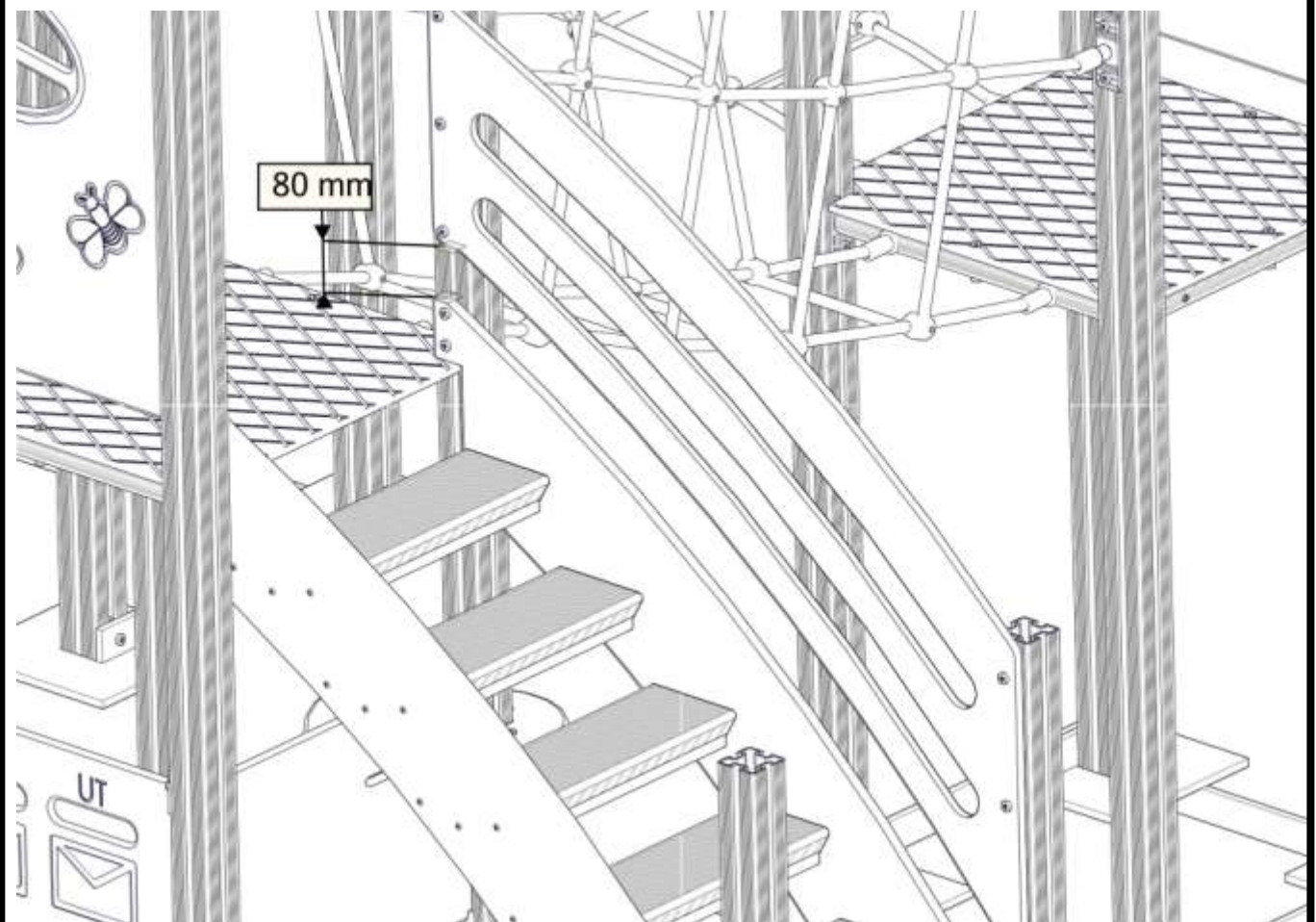

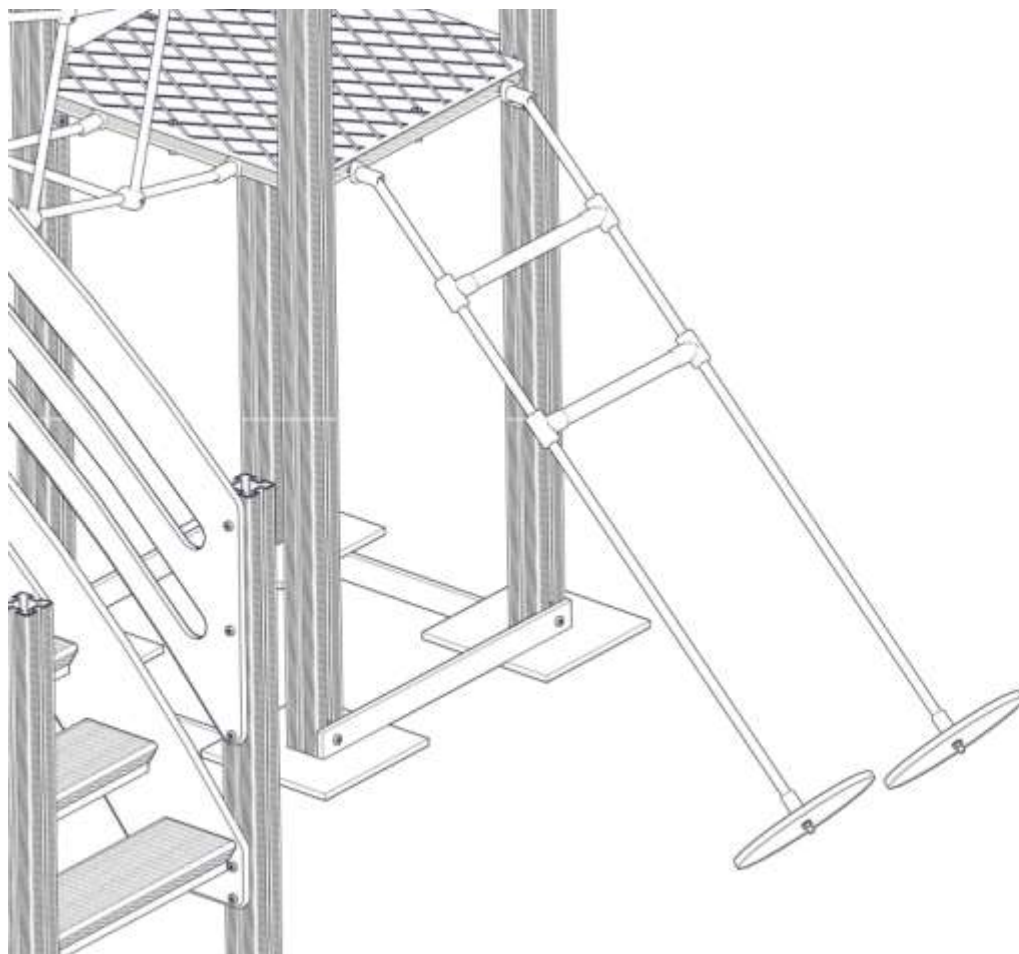
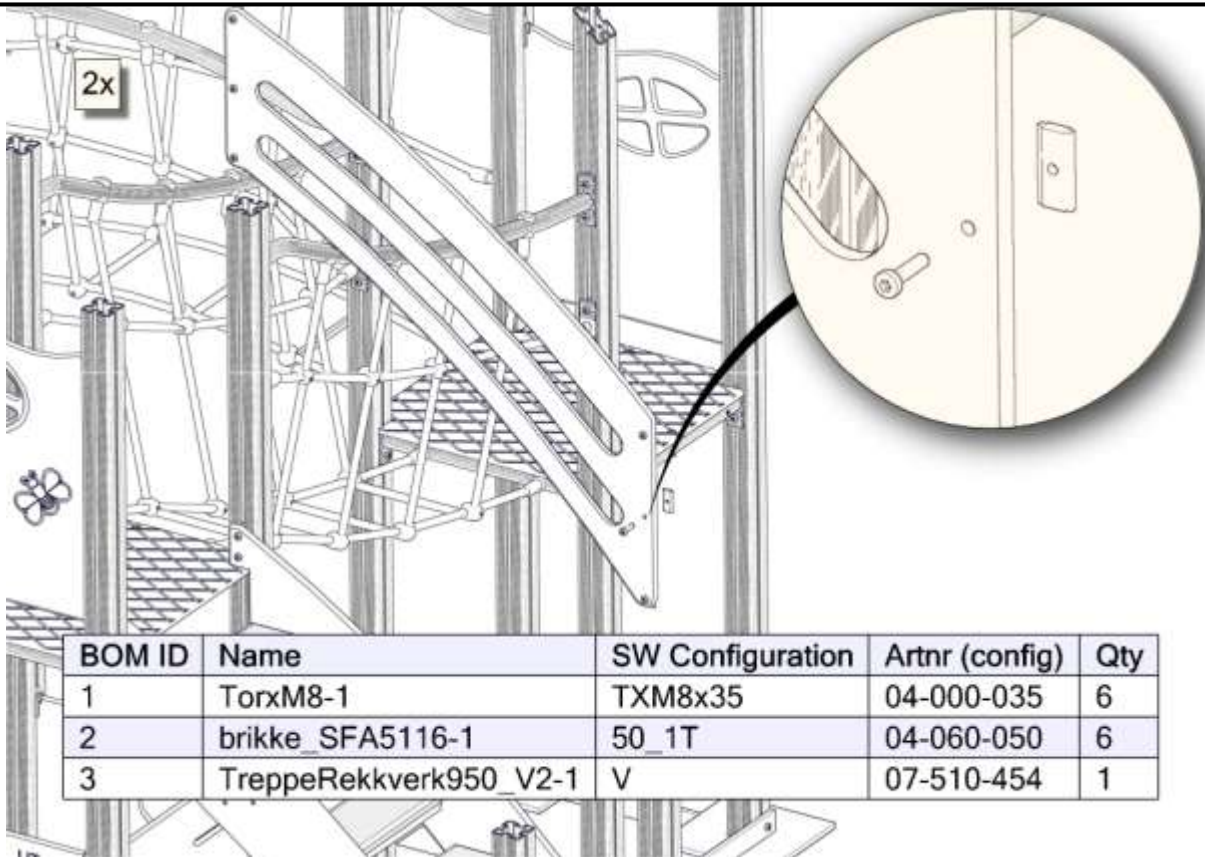

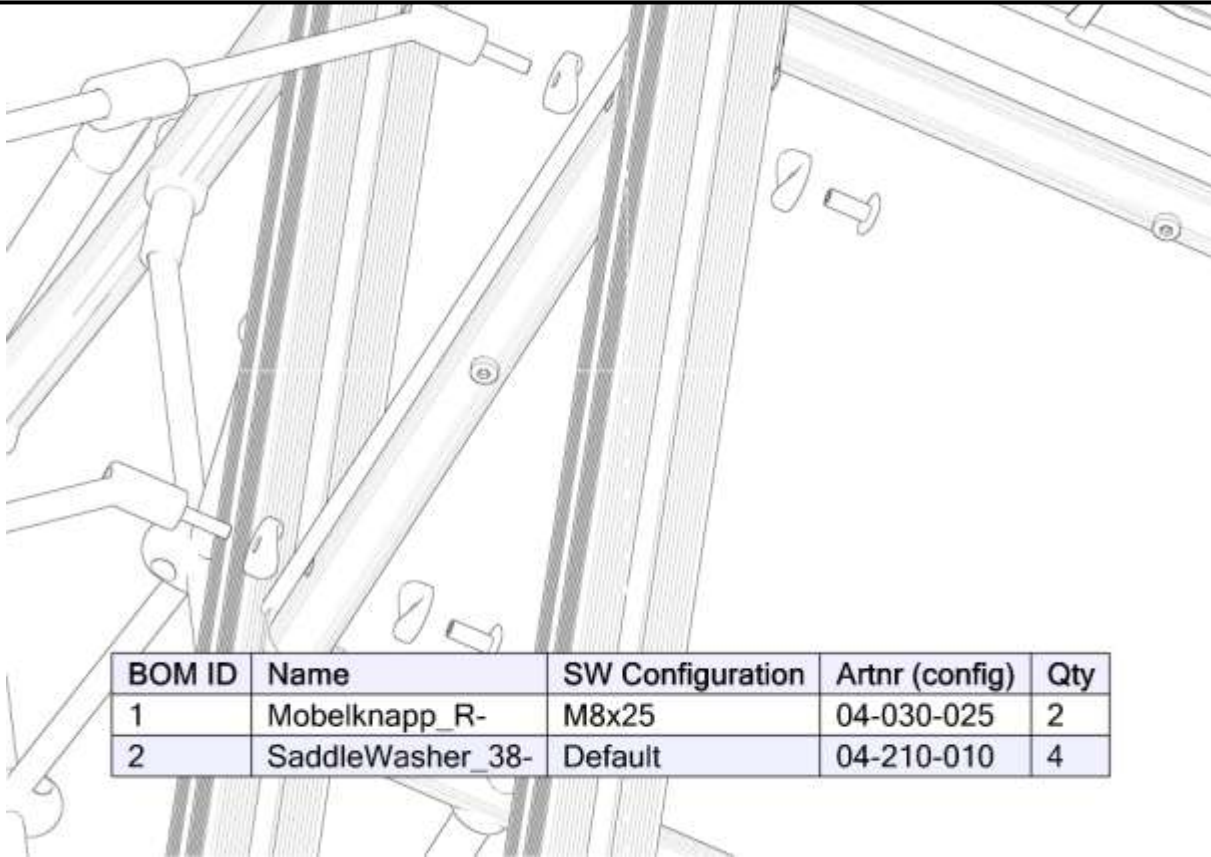

BOM ID	Name	SW Configuration	Artnr (config)	Qty
1	Mobelknapp_R-	M8x25	04-030-025	2
2	SaddleWasher_38-	Default	04-210-010	4

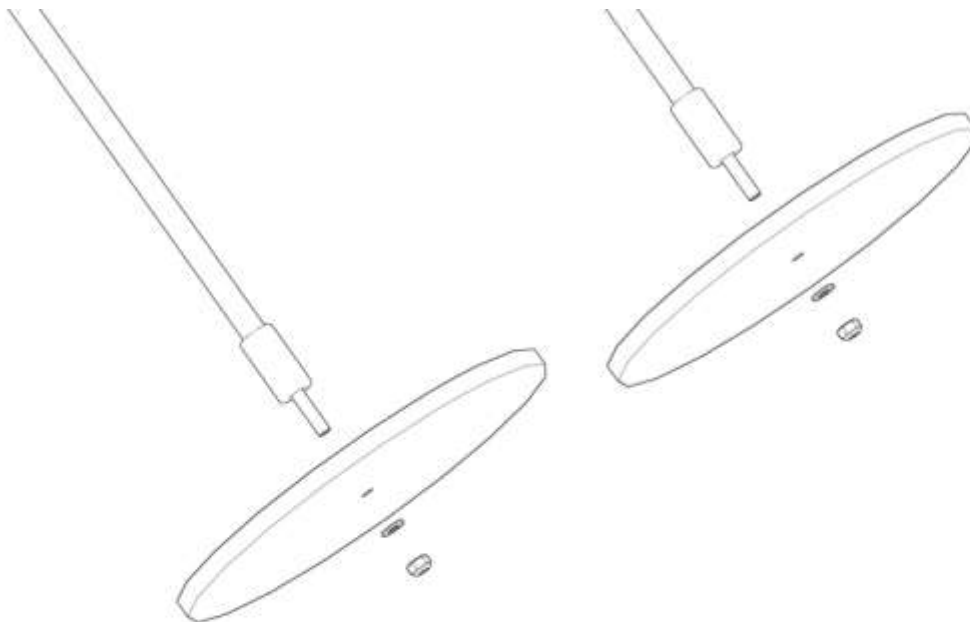

BOM ID	Name	SW Configuration	Artnr (config)	Qty
1	Fundament_platte-	Default	00-003-103	2
2	mutter_M8-	M8_Borg	04-040-008	2
3	Skive-	M8	04-050-008	2

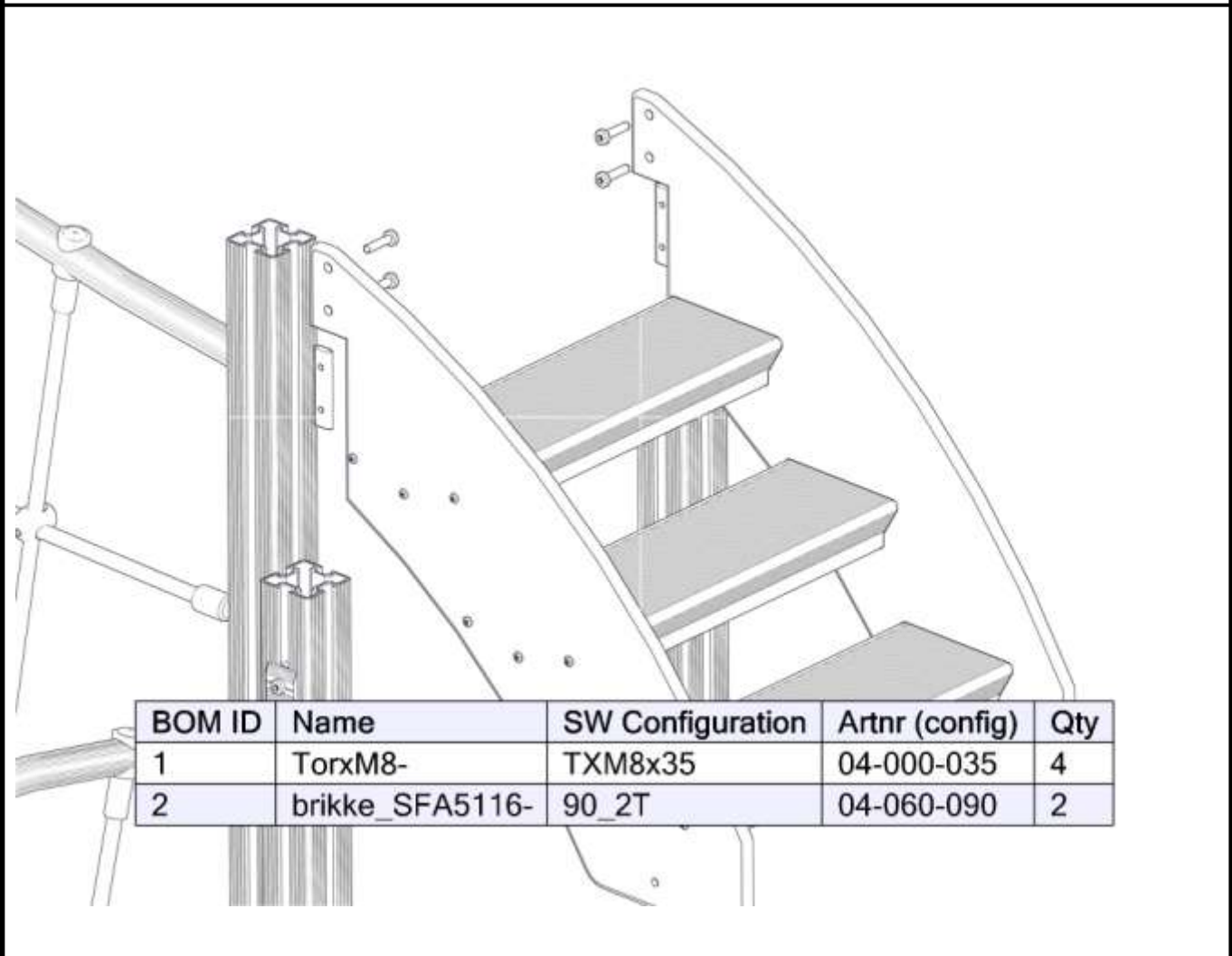
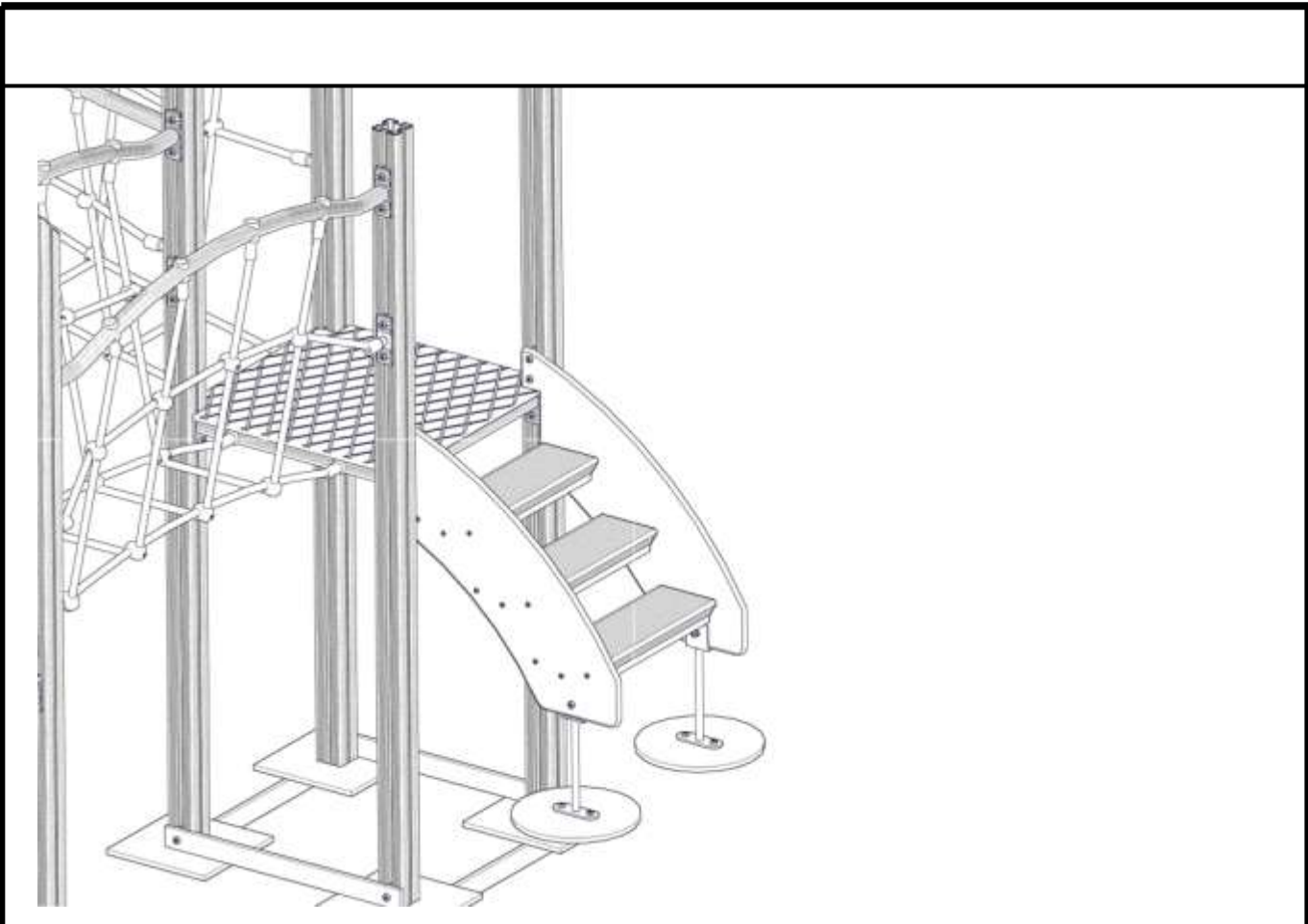

BOM ID	Name	SW Configuration	Artnr (config)	Qty
1	TorxM8-	TXM8x35	04-000-035	4
2	brikke_SFA5116-	90_2T	04-060-090	2

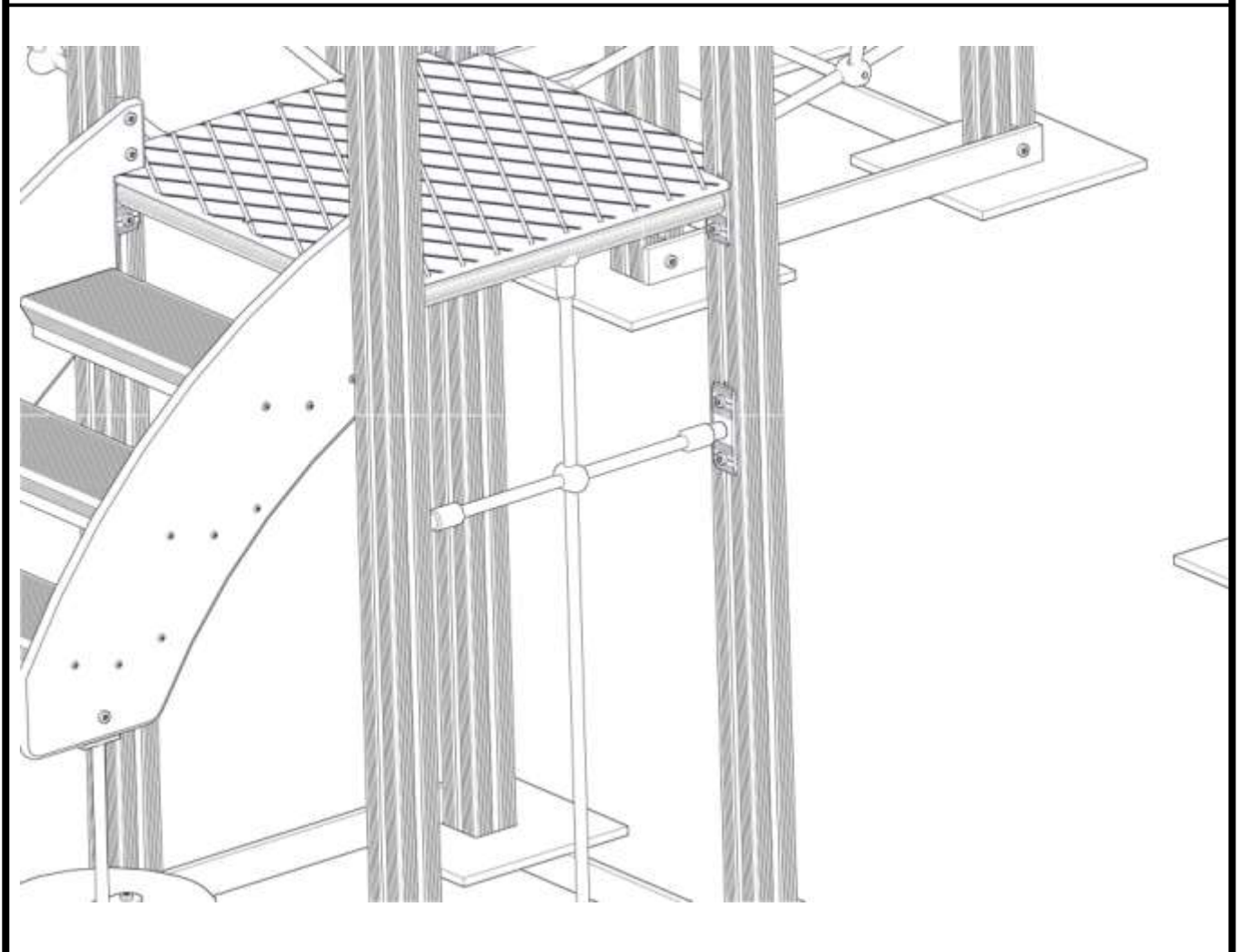
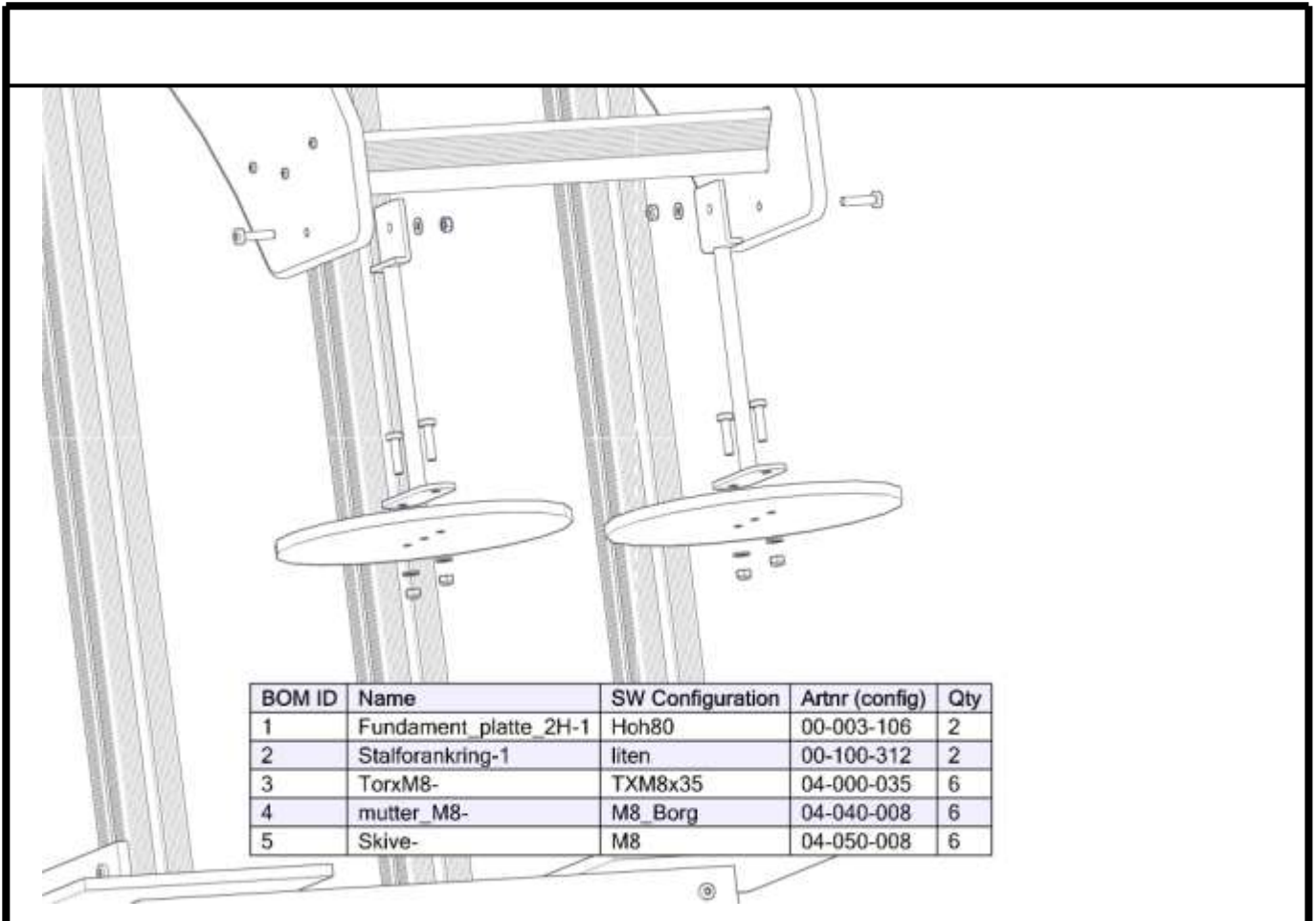



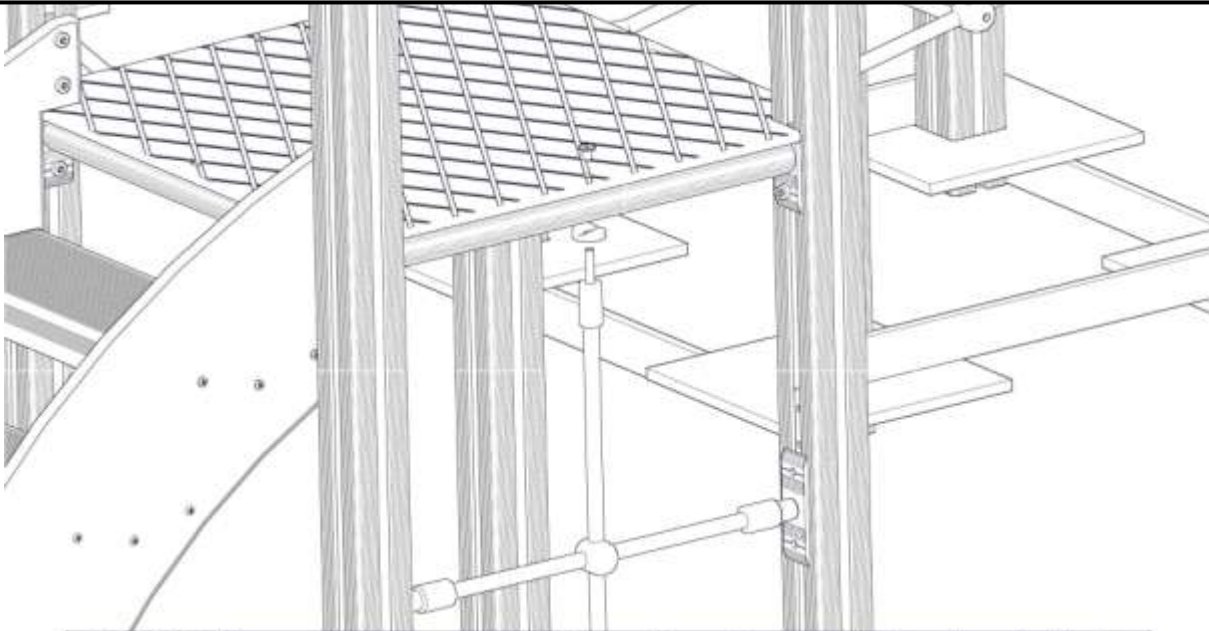

BOM ID	Name	SW Configuration	Artnr (config)	Qty
1	Mobelknapp-1	M8_13_17	04-030-011	1
2	SaddleWasher_38-2	Default	04-210-010	1
3	Trepp550-1	Default<As Machined>	07-510-177	1

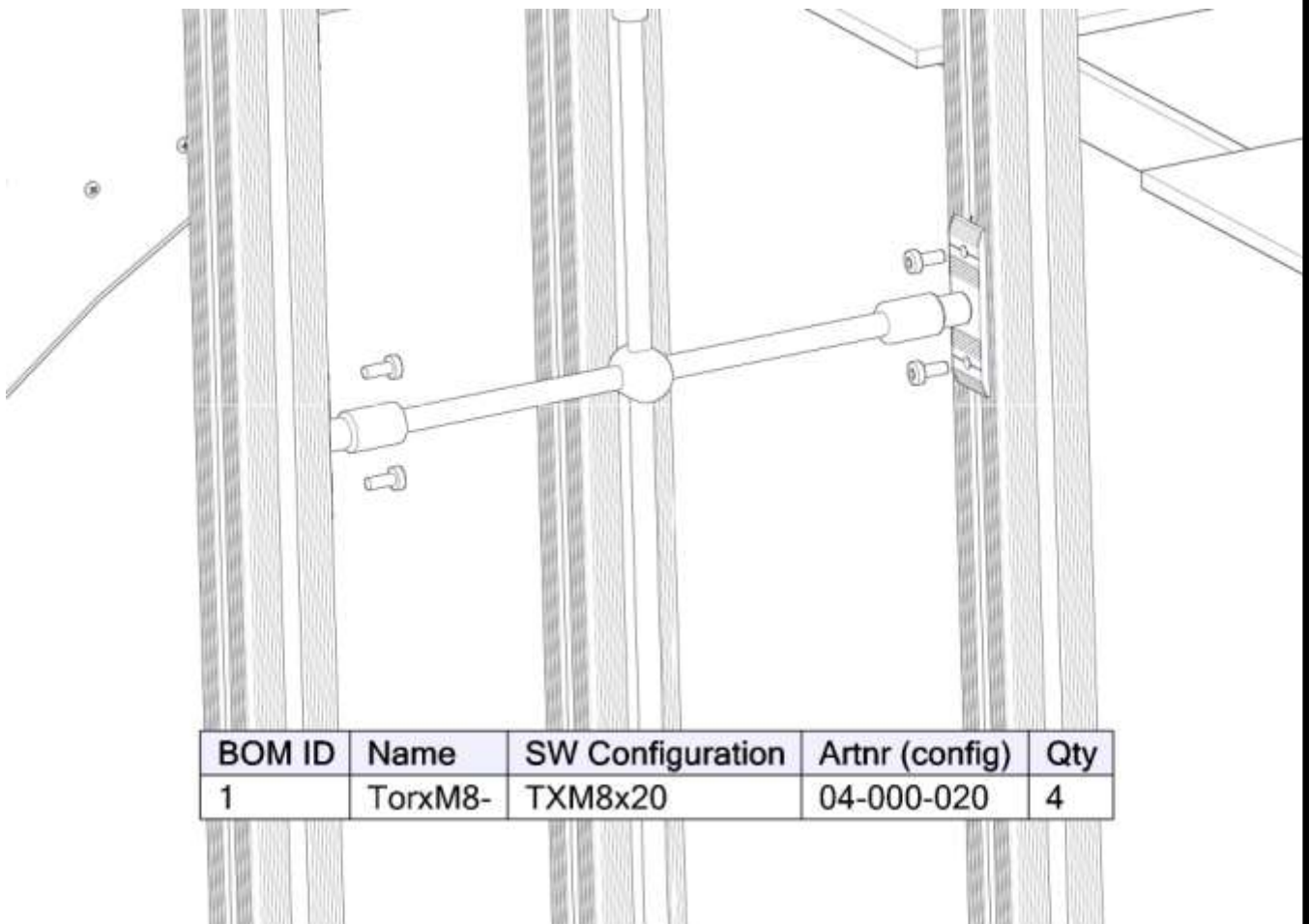

BOM ID	Name	SW Configuration	Artnr (config)	Qty
1	TorxM8-	TXM8x20	04-000-020	4

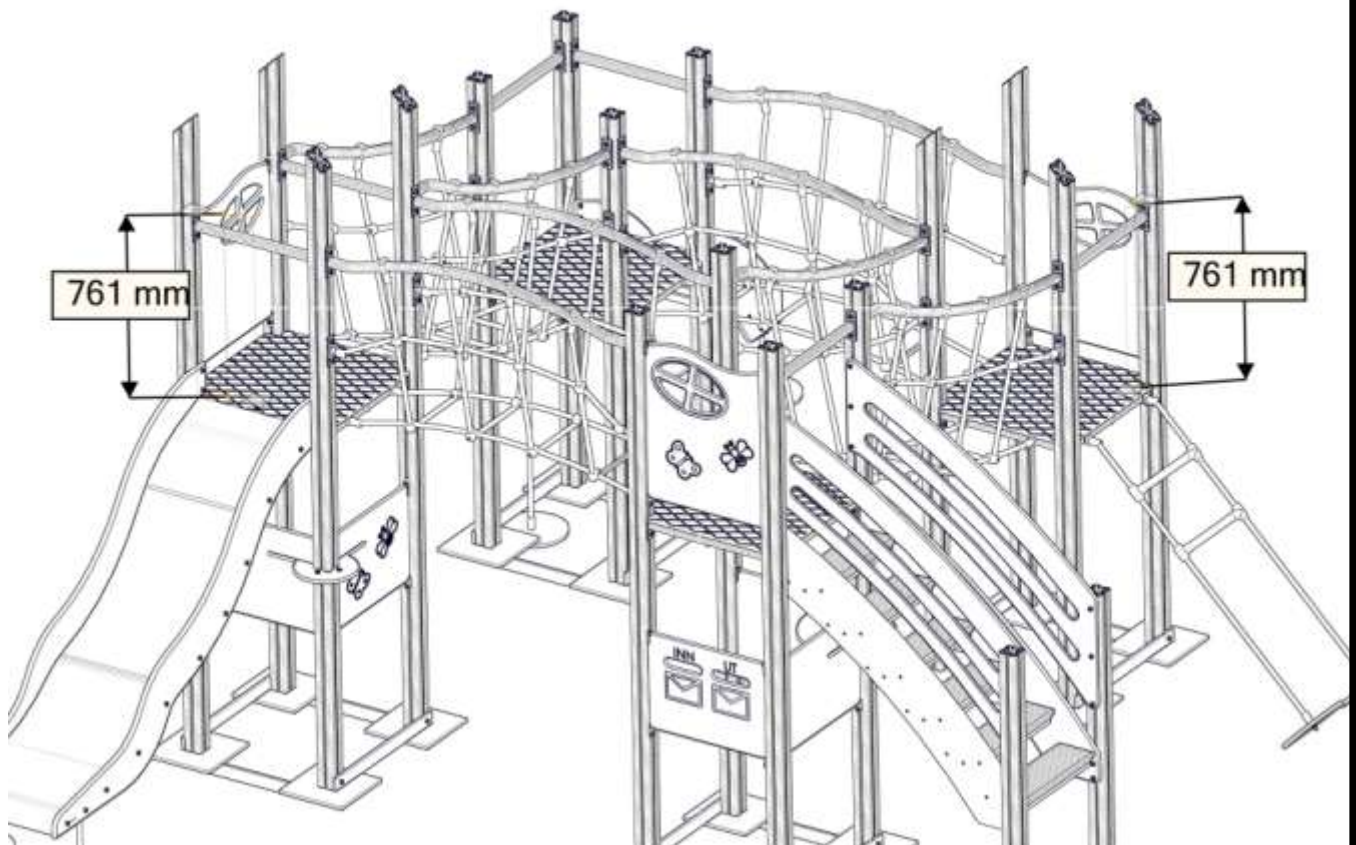
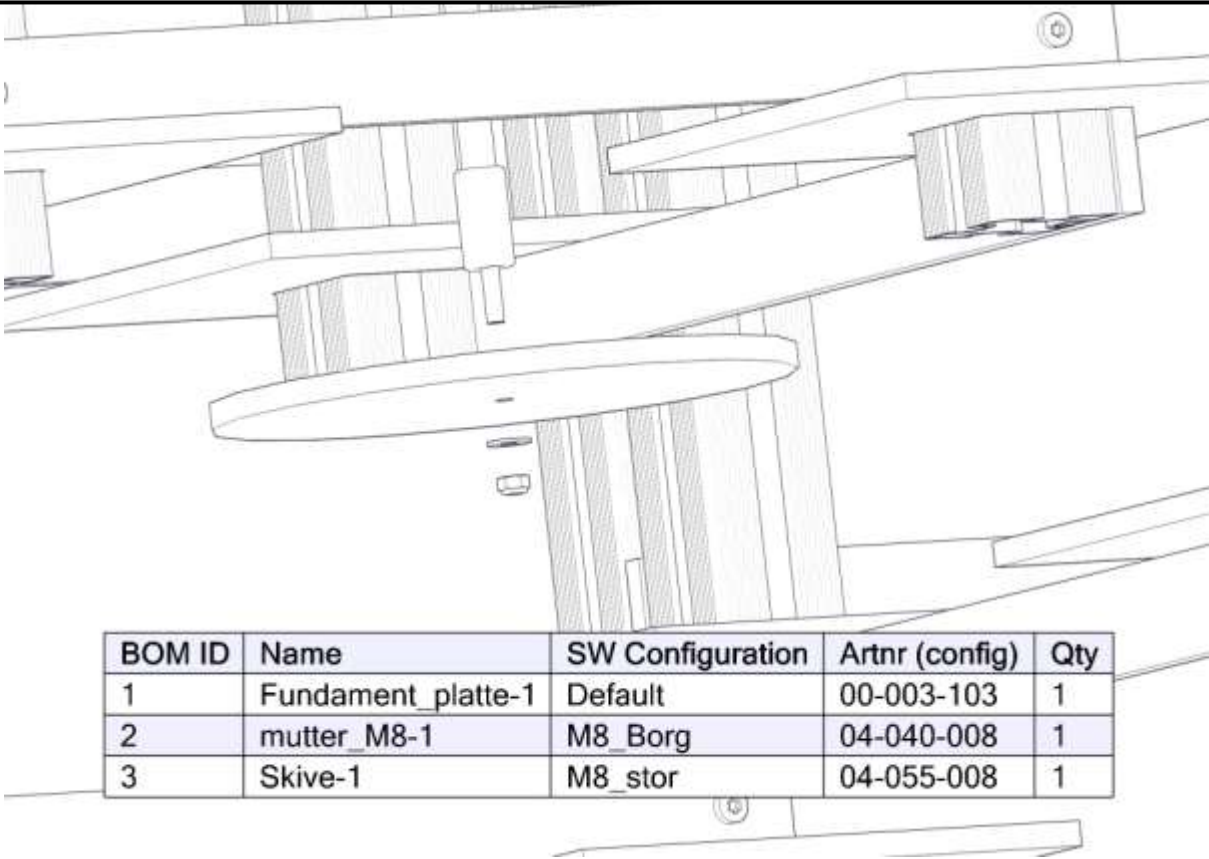

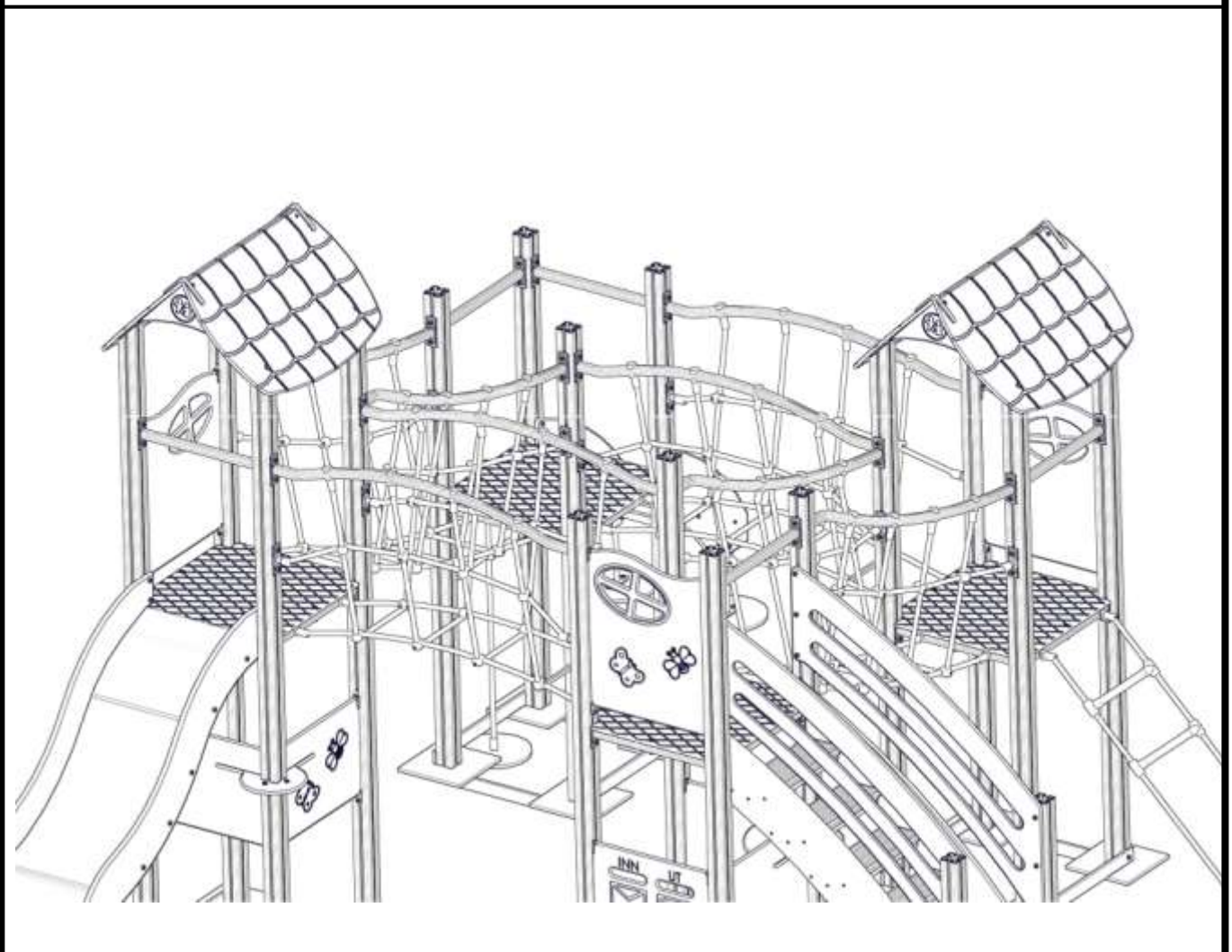
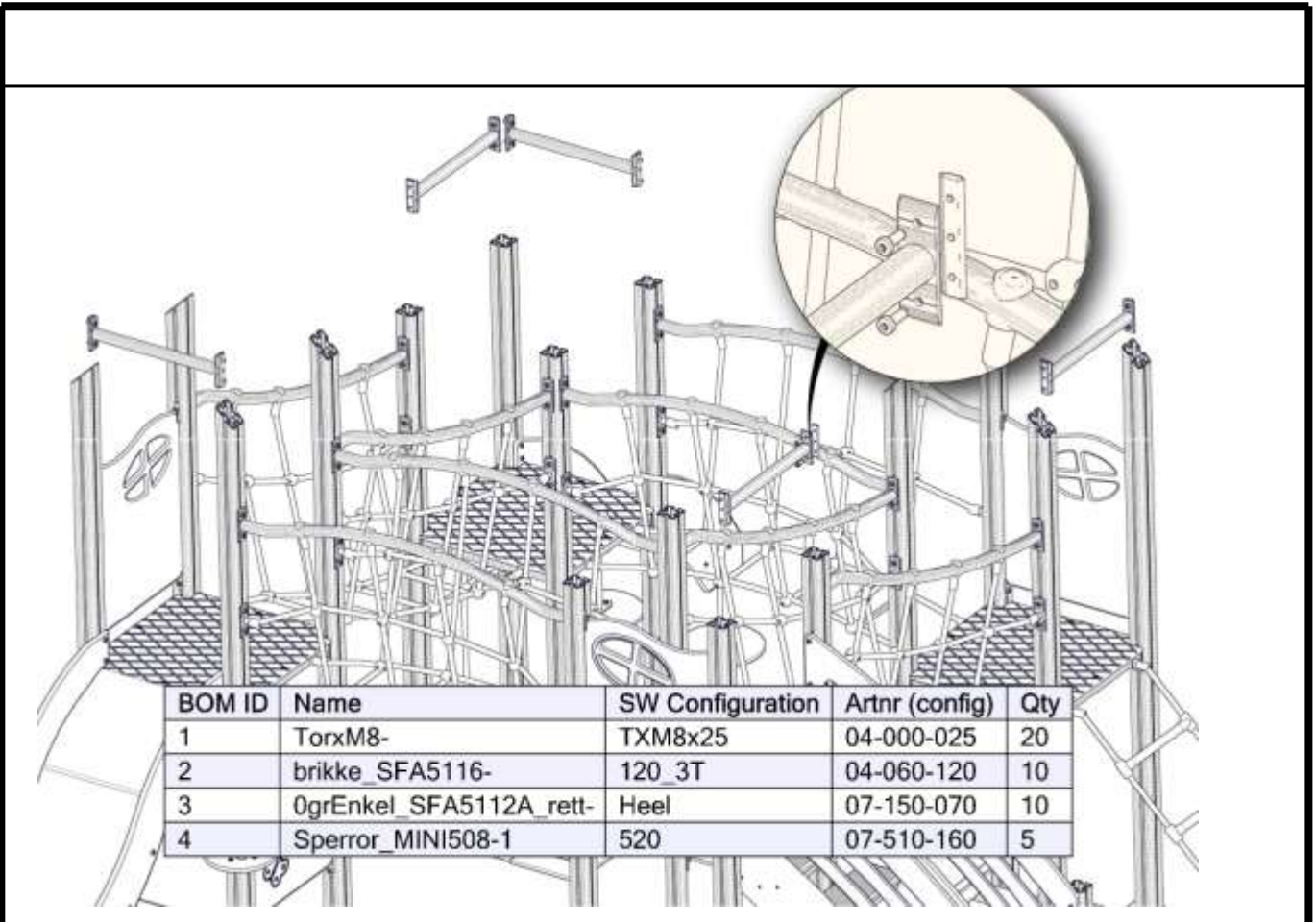

2x

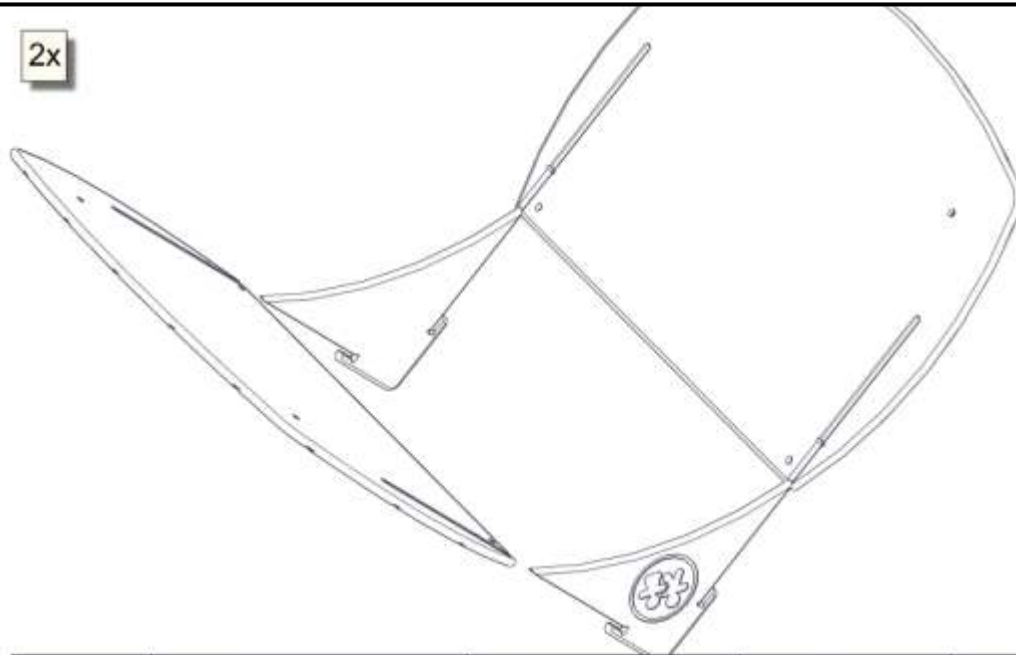

BOM ID	Name	SW Configuration	Artnr (config)	Qty
5	Tak_Miniserie2011-	rod	07-510-105	2
6	Gavelplatemini2011-	Rod	07-510-106	2

4x

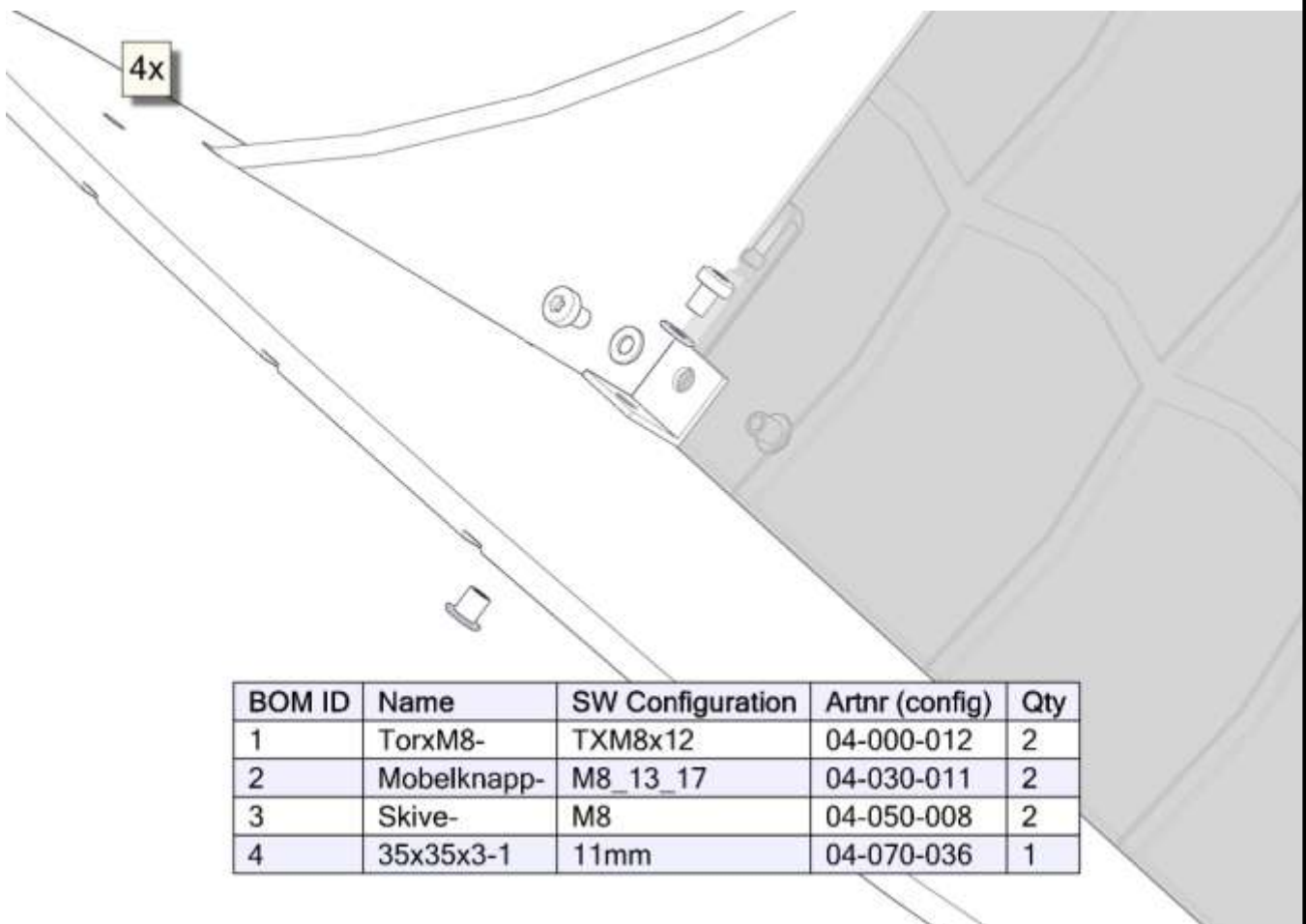

BOM ID	Name	SW Configuration	Artnr (config)	Qty
1	Torxm8-	TXM8x12	04-000-012	2
2	Mobelknapp-	M8_13_17	04-030-011	2
3	Skive-	M8	04-050-008	2
4	35x35x3-1	11mm	04-070-036	1

2x

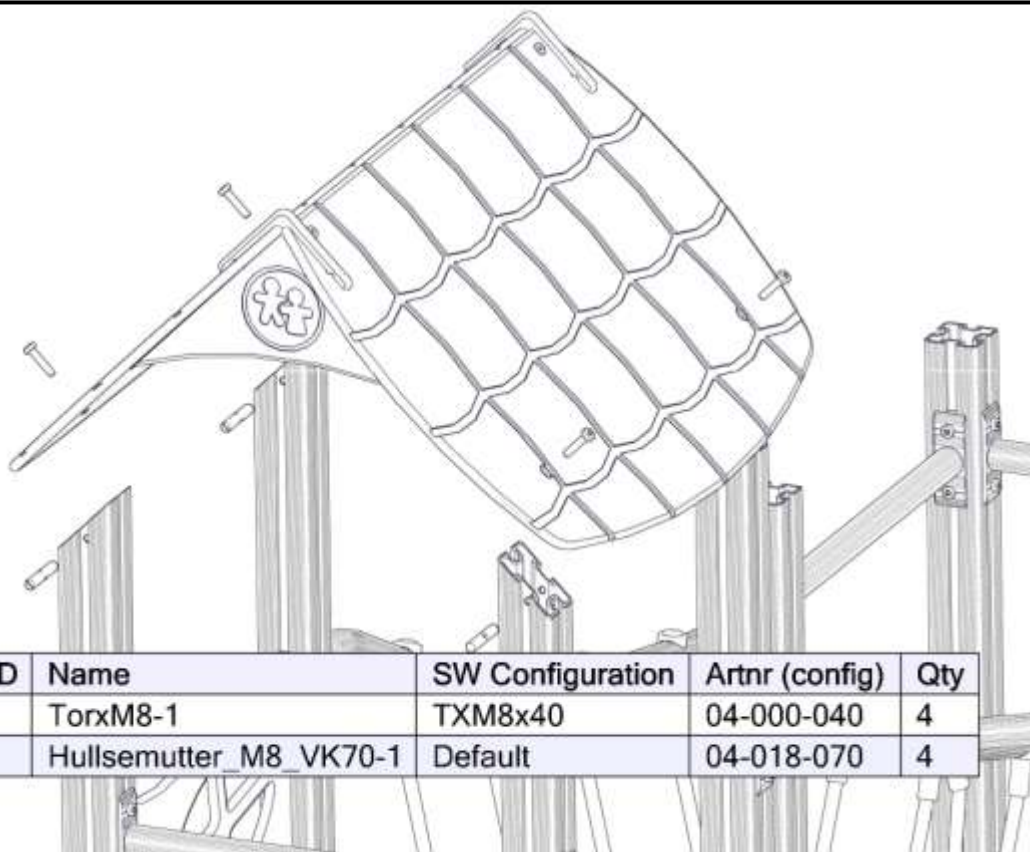

BOM ID	Name	SW Configuration	Artnr (config)	Qty
1	Torxm8-1	TXM8x40	04-000-040	4
2	Hullsemutter_M8_VK70-1	Default	04-018-070	4

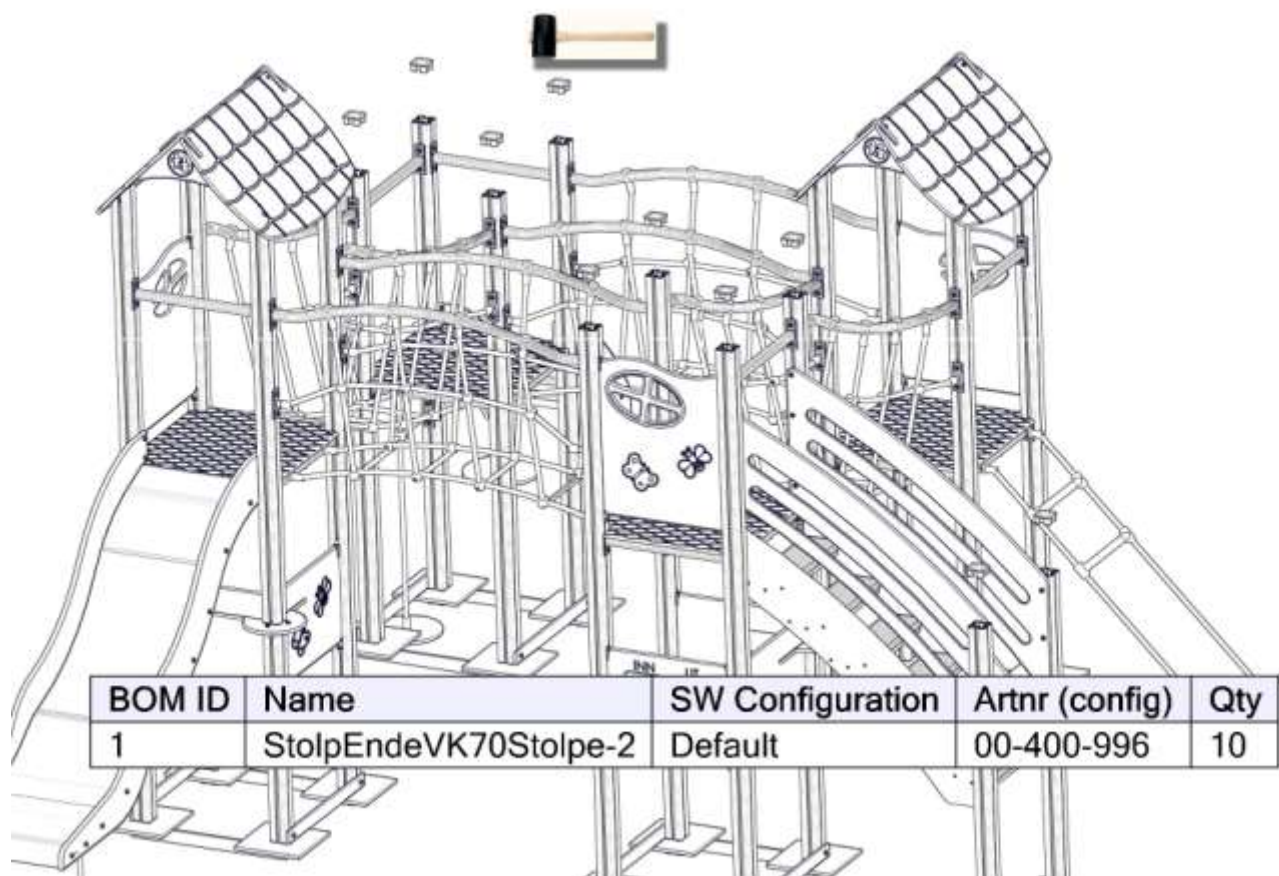

BOM ID	Name	SW Configuration	Artnr (config)	Qty
1	StolpEndeVK70Stolpe-2	Default	00-400-996	10

<b>Før utstyret tas i bruk / Before play begins / Innan lekredskapet tas i bruk</b>	
N	<ul style="list-style-type: none"> <li>• Påse at fallunderlag er utlagt i henhold til gjeldende regler eller vår anbefaling</li> <li>• Fjern alle monteringshjelpemidler ( rester av betong, planker, paller, plast, og lignende)</li> <li>• Før utstyret tas i bruk, burde man sjekke at det ikke er fare for at anorakksnorer og lignende som kan hekte seg fast noen steder på lekeapparatet. (Vedlagte snor med dobbe (kneledd) kan brukes til å sjekke at dette er i orden. Se vedlagte veiledning for bruk av denne. Dette gjøres for å oppdage eventuelle feilmonteringer.?)</li> <li>• NB! Bør stå i 2-3 dager før bruk</li> </ul>
UK	<ul style="list-style-type: none"> <li>• Make sure the area and depth of safer surfacing are according to the current standard, or to the manufacturer's recommendation</li> <li>• Make sure all tools and surplus materials are removed before play begins</li> <li>• PS! When complete, allow 2-3 days for the concrete to set before use</li> </ul>
S	<ul style="list-style-type: none"> <li>• Kontrollera att fallunderlag är utlagt enligt gällande regler eller vårt rekomenation</li> <li>• Ta bort alla monteringshjälpmedel (rester av betong, plankor, pallar, plast och liknande)</li> <li>• Innan lekredskapet används, kontrollera att anoracksnoddar eller kläder/delar av kläder eller liknande inte kan fastna i några delar på redskapet. (Den bipackade "knävringen" kan man med fördel användas för denna kontroll.</li> <li>• Detta görs för att upptäcka eventuella felmonteringar.)</li> </ul>