



**Monteringsanvisning**



**Assembly Instructions**



**Monteringsanvisning**

Produkt nr. / Product no. / Produkt nr.

**25-200-120**

Ordr. nr. \_\_\_\_\_

Dato. \_\_\_\_\_

Sign. \_\_\_\_\_

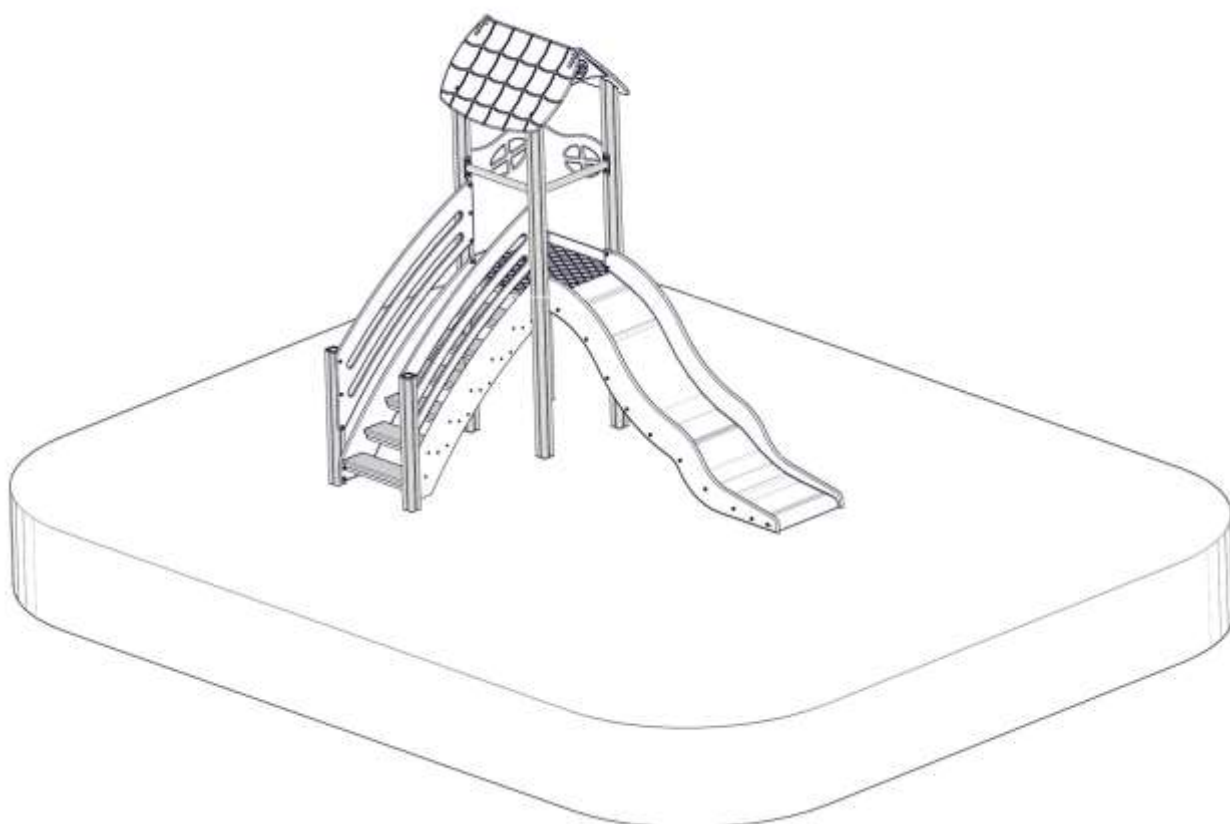

Søve AS  
Grønnvoldveien 290  
3830 Ulefoss - Norway  
Tlf: +47 35 94 65 65



Søve AB  
EA Rosengrens gatan 32  
421 31 Västra Frölunda  
Phone: +46 (0)31 773 97 00  
[www.sove.se](http://www.sove.se)

## Monteringstips / Assembly Advice / Monteringsstips

**N**

- Les monteringsanvisningen nøye før montering.
- Monter elementene i rekkefølgen som vist.
- Boltene bør ikke skrues for hardt til før alt er montert, vatret og loddet. Skru så boltene til.
- NB! Ved bruk av drill, kan boltene ryke.
- På grunn av at solen kan gjøre rutsjeflaten veldig varm, bør rutsjebanens utløp vende mot nord-øst eller nord-vest.
- Er lekeutstyret plassert i naturlige ferdselstraséer må området sikres mot gjennomgang.
- Innspringningshinder bør vurderes rundt lekeapparater hvor det er stor bevegelse, f.eks. ved huskestativ.
- Det bør være fritt innsyn til lekeutstyr som er beregnet for barn under 3 år.

**NB! Under monteringsarbeidet må utstyr, som ikke er forankret forsvarlig i bakken, sikres slik at det ikke velte.**

**Området må avstenges under montering av apparatene med sperrebånd eller lignende.**

**EN**

- Read the instruction carefully before assembling the play unit..
- Assemble the components in the sequence shown in these instructions.
- Fixings must not be fully tightened during assembly. Before casting the foundations, the structure must be level and plumb, at which point all fixings are tightened.
- PS! If use of drill, the bolts may be wrecked.
- Avoid positioning the slide facing due south because of overheating – ideal positions are facing north-east or north-west.
- Secure the construction-area to prevent people from walking through it.
- Consider installing barriers around play-equipment which gives rise to a lot of activity – i.e.swings.
- Ensure that clear vision is possible across the play area so that supervision is possible from any position, particularly where children under 3 years of age will be playing.

**NB! During assembly of the equipment, ensure that all structures are securely propped, especially when left overnight. Also ensure that equipment is supported whilst concrete foundations are setting and enclose the area securely to prevent access.**

**Monteringstips / Assembly Advice / Monteringsstips****S**

- Läs monteringsanvisningen noga före montering.
- Montera delarna i den ordningen som anvisas
- Skruvarna bör inte skruvas för hårt tills allt är monterat, i våg och lodat.











OBS! Används elektrisk skruvdragare, kan bulten gå sönder. Hårdra därför manuellt!

- Solen kan göra att rutchbanan blir väldigt varm. Banans nedfart rekommenderas att vändas i norrlig riktning
- Om lekplatsen placeras vid en gångväg mm bör området säkras mot genomfart av gående och cyklister.
- Inspjningshinder bör placeras runt lekutrustning med stor rörelse, t ex, gungställning.
- Det bör vara fri insyn till lekutrustning beräknat till barn under 3 år.

**OBS! Under monteringsarbete bör utrustningen som inte ska förankras i marken, ställs så att den inte kan välta.**

**Området måste spärras när lekutrustningen byggs upp, med avspärrningsband eller liknande.**

**Nødvendig verktøy / Tools required / Nödvändiga verktyg**

<p>(N)</p> <p>(EN)</p> <p>(S)</p>	<p>(A)</p> 	<p>(B)</p>  <p>Torx Nr 45 High quality</p>	<p>(C)</p> <p>5 mm 6 mm</p> 	<p>(D)</p> 	<p>(E)</p> 
		<p>Metermål Metric measure Tumstock</p> 	<p>16 V</p> 	<p>Merkeband Mark ribbon Märkeband</p> 	<p>13 + 17mm</p> 

**Nødvendig antall personer / Number of persons required / Rekommenderad antal personer**





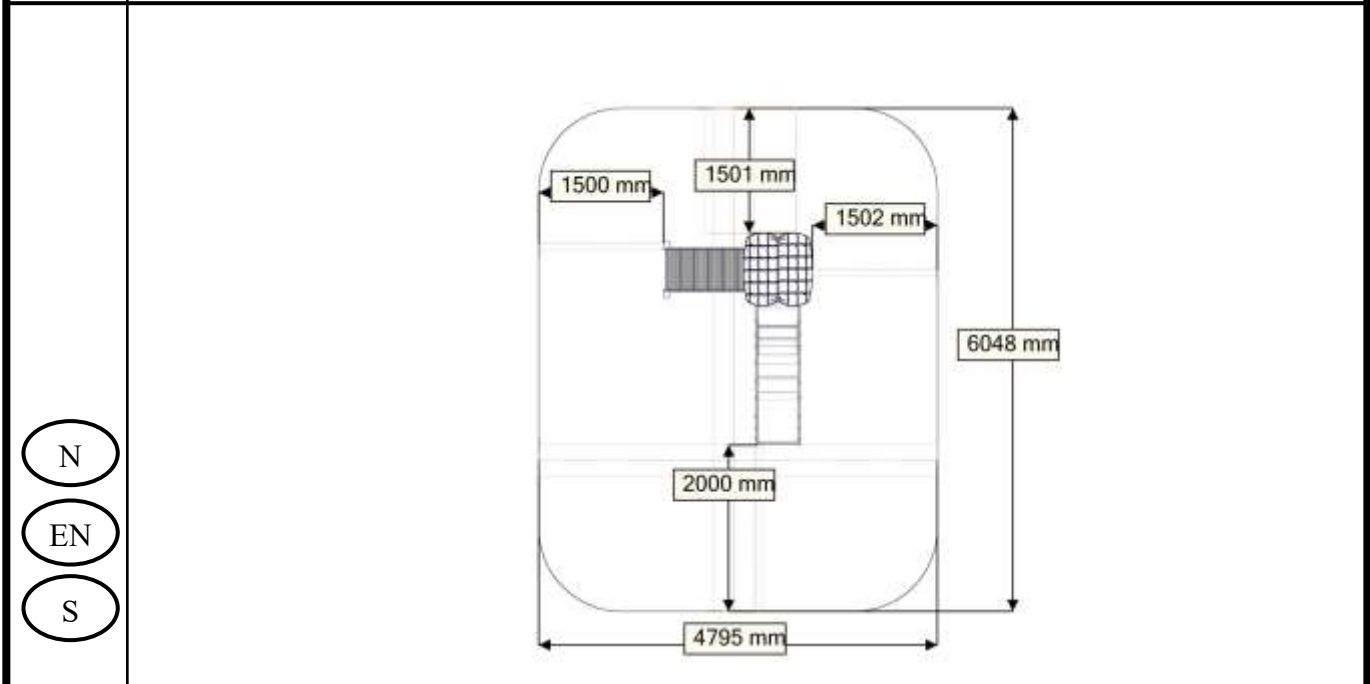





**Anbefalt arealbehov ved montering / Recommended working space / Rekommenderad arealbehov vid montering**

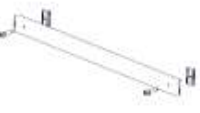

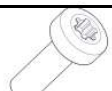

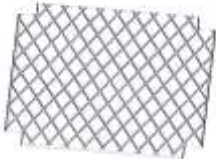
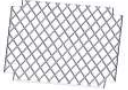











**Boltepakker for / Boltpackage for / Bultpaket för**

Sign. \_\_\_\_\_

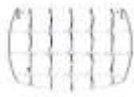
<b>Stolpe 70x70 skrå</b>	<b>Ant= 4</b>	<b>Navn</b>	<b>Artnr/dimensjon</b>	<b>Ant</b>	<b>Lev</b>
		VK70 2100-600 (1) Skrå Brikke på stolpe!	07-510-158	4	
		Torx M8x40 (1)	04-000-040	4	
		Hullsemutter (1) VK70	04-018-070	4	
<b>FundamentMini 660</b>	<b>Ant= 4</b>	<b>Navn</b>	<b>Artnr/dimensjon</b>	<b>Ant</b>	<b>Lev</b>
		miniSprosse 660 (1)	07-510-200	4	
		Brikke 50_1T (2)	04-060-040	8	
		Torx M8x35 (2)	04-000-035	8	
<b>FundamentSkive</b>	<b>Ant= 4</b>	<b>Navn</b>	<b>Artnr/dimensjon</b>	<b>Ant</b>	<b>Lev</b>
		Skive (1)	07-510-201	4	
<b>Gulv mini</b>	<b>Ant= 1</b>	<b>Navn</b>	<b>Artnr/dimensjon</b>	<b>Ant</b>	<b>Lev</b>
		Gulv Mini 520(1)	07-510-102	1	
		Møbelknapp (4)	04-030-011	4	
		Torx M8x45 (4)	04-000-045	4	











**Boltepakker for / Boltpackage for / Bultpaket för**

Sign. \_\_\_\_\_.

<b>Sperrerør 520</b>	<b>Ant= 2</b>	<b>Navn</b>	<b>Artnr/dimensjon</b>	<b>Ant</b>	<b>Lev</b>
		Sperrerør 520 (1)	07-510-160	2	
		Brikke 120_3T (2)	04-060-120	4	
		Torx M8x25 (4)	04-000-025	8	
<b>Sperrerør 520 gulv</b>	<b>Ant= 4</b>	<b>Navn</b>	<b>Artnr/dimensjon</b>	<b>Ant</b>	<b>Lev</b>
		Sperrerør 520 (1)	07-510-161	4	
		Brikke 90_2T (2)	04-060-090	0 På stolpe	
		Torx M8x25 (2)	04-000-025	8	
<b>Tak</b>	<b>Ant= 1</b>	<b>Navn</b>	<b>Artnr/dimensjon</b>	<b>Ant</b>	<b>Lev</b>
		Tak mini (2)	07-510-105	2	
		Gavelplate(2)	07-510-106	2	
		Vinkel 35x35x3(2) 11mm	04-070-036	2	
		Møbelknapp	04-030-011	4	
		Torx M8x12(4)	04-000-012	4	
		Skive M8 (4)	04-050-008	4	

**Boltepakker for / Boltpackage for / Bultpaket för**











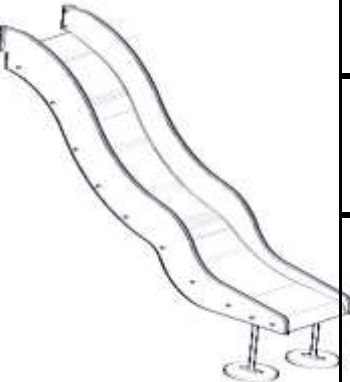

Sign. \_\_\_\_\_.

<b>Vegge 520x600 Vindo bloms</b>	<b>Ant= 1</b>	<b>Navn</b>	<b>Artnr/dimensjon</b>	<b>Ant</b>	<b>Lev</b>
		Vegge520x600 (1) Vindu blom	07-510-120	1	
		Brikkespesial(4)	04-060-041	4	
		Brikke(4)	04-060-040	4	
		Torx M8x25(4)	04-000-025	4	
<b>Vegge 520x600 Vindo Bi</b>	<b>Ant= 1</b>	<b>Navn</b>	<b>Artnr/dimensjon</b>	<b>Ant</b>	<b>Lev</b>
		Vegge520x600 (1) Vindu bi/ Sommerfulg	07-510-120	1	
		Brikkespesial(4)	04-060-041	4	
		Brikke(4)	04-060-040	4	
		Torx M8x25(4)	04-000-025	4	



**Boltepakker for / Boltpackage for / Bultpaket för**













Sign. \_\_\_\_\_

<b>Rutsjebane 950 07-510-310</b>	<b>Ant= 1</b>	<b>Navn</b>	<b>Artnr/dimensjon</b>	<b>Ant</b>	<b>Lev</b>
		Rutsjebane	07-510-310	1	
		Brikke120 3T(5)	04-060-120	2	
		Torx M8x35(4)	04-000-035	4	
		Torx M8x45(2)	04-000-045	2	
		Torzx M8x30(4)	04-000-030	4	
		Fundamentskive(2) 2H 80	00-003-106	2	
		Skive M8(2)	04-050-008	4	
		Mutter M8(2)	04-040-008	6	
	Stålforankring(2)	00-100-310	2		
<b>Produktmerke</b>	<b>Ant= 1</b>	<b>Navn</b>	<b>Artnr/dimensjon</b>	<b>Ant</b>	<b>Lev</b>
		0gr 150_2H (1) Med Produktmerke	07-500-500	1	
		Brikke 150_2T(1)	04-060-151	1	
		Torx M8x35 (2)	04-000-035	2	



**Boltepakker for / Boltpackage for / Bultpaket för**

Sign. \_\_\_\_\_

<b>Stolpe 70x70</b>	<b>Ant= 2</b>	<b>Navn</b>	<b>Artnr/dimensjon</b>	<b>Ant</b>	<b>Lev</b>
		VK70x70 (1) 600-800=1400	07-510-455	2	
		Stolpende	00-400-996	2	
<b>FundamentMini 660</b>	<b>Ant= 2</b>	<b>Navn</b>	<b>Artnr/dimensjon</b>	<b>Ant</b>	<b>Lev</b>
		miniSprosse 660 (1)	07-510-200	2	
		Brikke 50_1T (2)	04-060-040	4	
		Torx M8x35 (2)	04-000-035	4	
<b>FundamentSkive</b>	<b>Ant= 2</b>	<b>Navn</b>	<b>Artnr/dimensjon</b>	<b>Ant</b>	<b>Lev</b>
		Skive (1)	07-510-201	2	
<b>Trapp 950</b>	<b>Ant= 1</b>	<b>Navn</b>	<b>Artnr/dimensjon</b>	<b>Ant</b>	<b>Lev</b>
		Trapp 950	07-510-451	1	
		Rekkverk trappa	07-510-454	2	
		Brikke 50 1T	04-060-040	16	
		Brikke 90 2T	04-060-090	2	
		Torx M8x35	04-000-035	20	

**Fundamentering med betong / Foundation concrete / Förankring med betong**

(N)	Støtsand		(N)	(UK)	(S)
(EN)	Safer surface		Bakkenivå	Ground level	Marknivå
(S)	Stridsan		↓ Ref NS-EN 177		
(N)	Komprimert masse.	betong			
(EN)	Compressed mass.	concrete			
(S)	Komprimerad massa.	betong			

**Fundamentering uten betong / Foundation without concrete / Förankring utan betong**

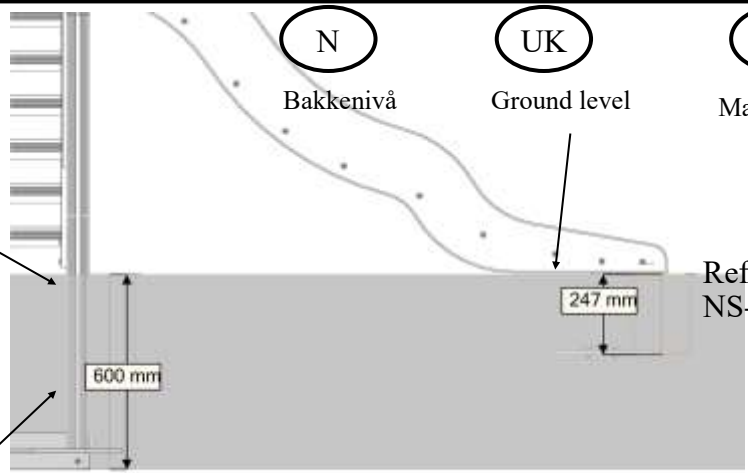
(N)	Støtsand		(N)	(UK)	(S)
(EN)	Safer surface		Bakkenivå	Ground level	Marknivå
(S)	Stridsan		↓ Ref NS-EN 1177		
(N)	Komprimert masse	Støpefri nedgraving			
(EN)	Compressed mass	Concrete-free anchor			
(S)	Komprimerad massa	Nedgravningsfundament			

(N)	Alle mål er oppgitt i millimeter
(EN)	Scale measured in mm
(S)	Alla mått är i millimeter.

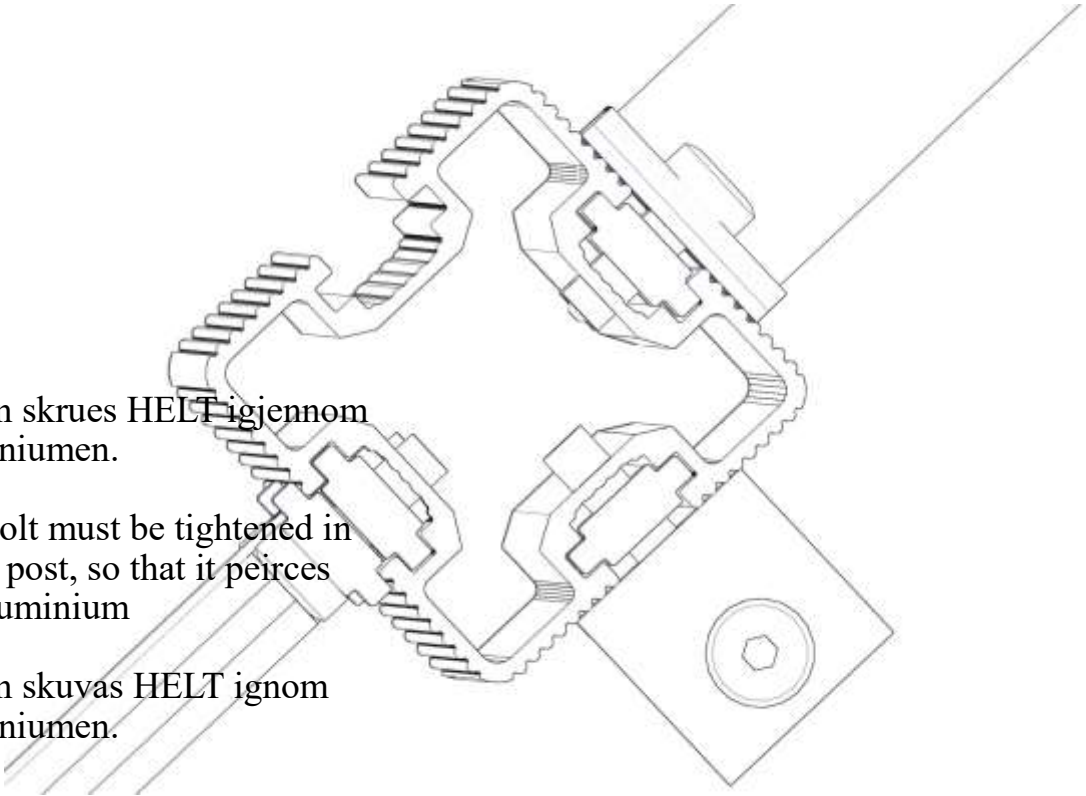
<p>(N) Bolten skrues HELT igjennom aluminiumen.</p> <p>(EN) The bolt must be tightened in to the post, so that it peirces the aluminium</p> <p>(S) Bulten skuyas HELT ignom aluminiumen.</p>	

**Fallhøyder / Free height of fall / Fallhöjder**

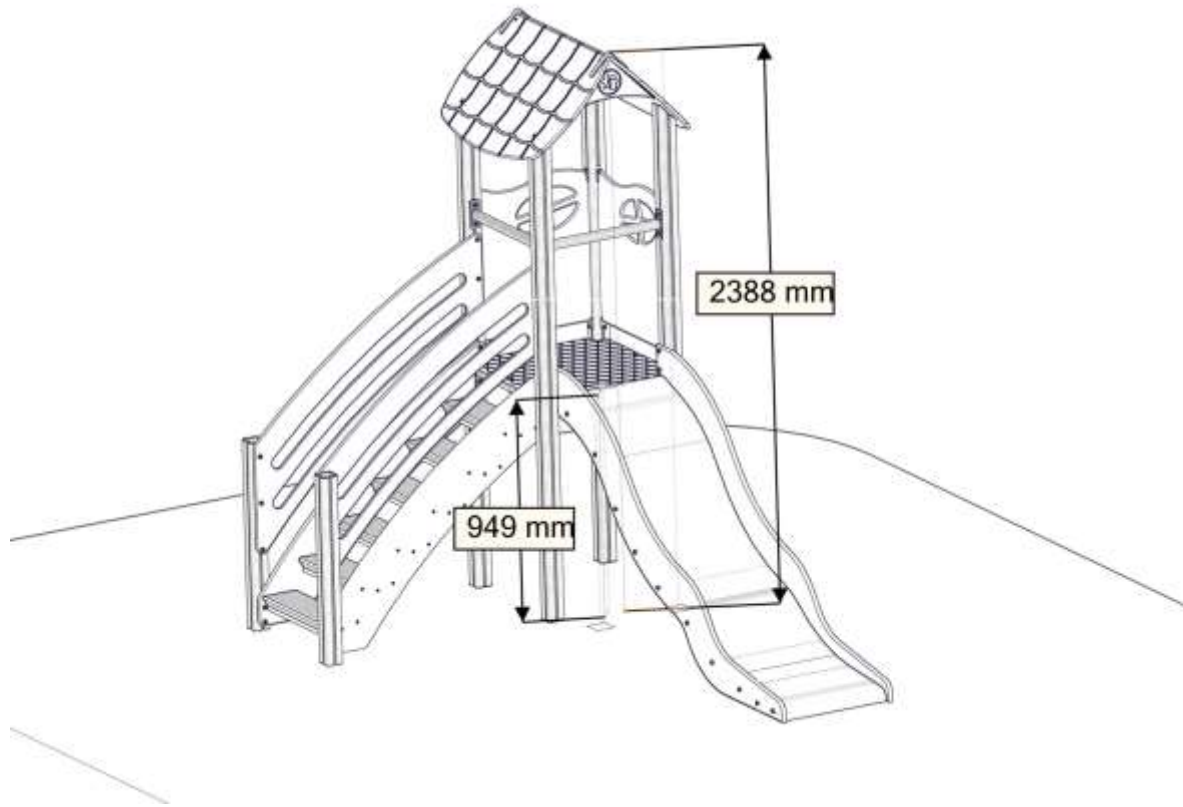

**Sikkerhetszone / Safety zone / Säkerhetszon**

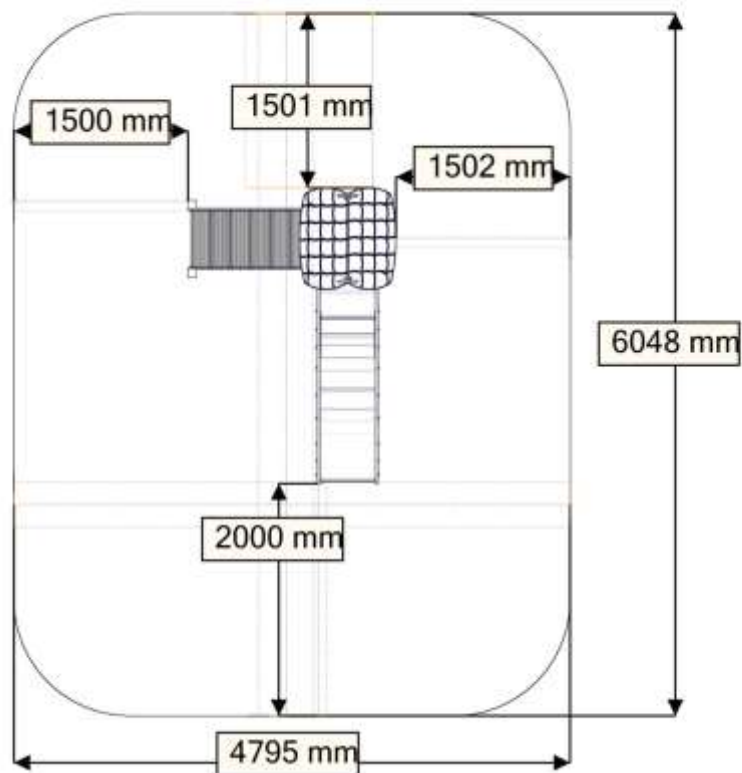

**Plassering av forankringer / Ground plan / Placering av förankringar**

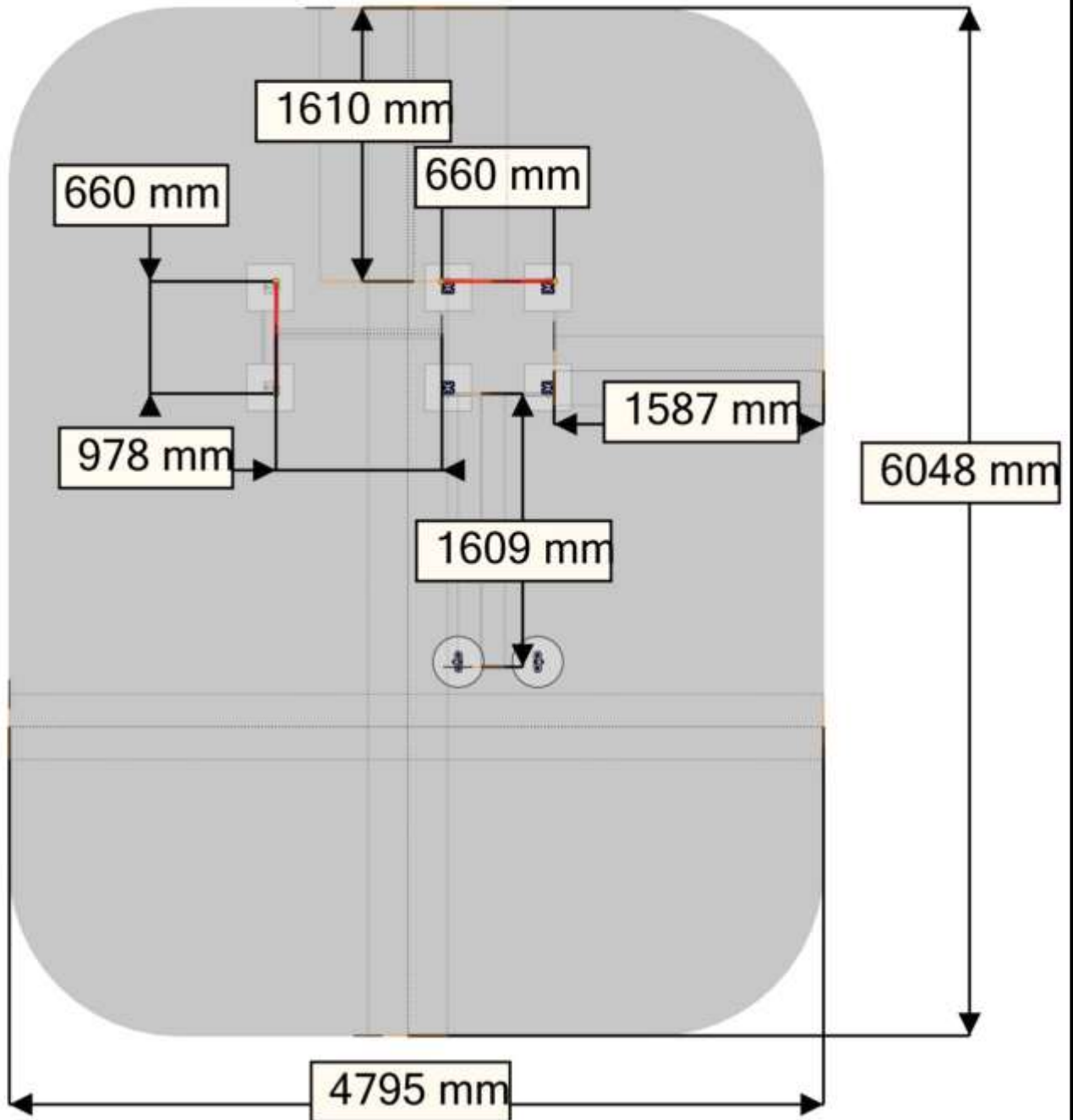

N

Alle mål er oppgitt i millimeter

UK

Scale measured in mm

S

Alla mått är i millimeter.

## Montering av lekeapparatet / Assembly instructions / Montering av lekredskapet

Montasje hos Søve

04-060-090

1550 mm

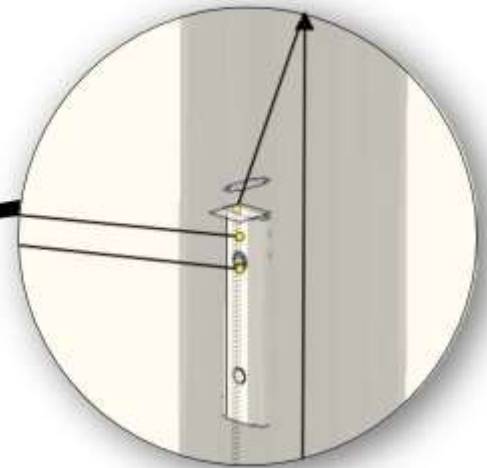

BOM ID	Name	SW Configuration	Artnr (config)	Qty
1	VK70_SFA5123_miniSkra-1	2100-600	07-510-158	4



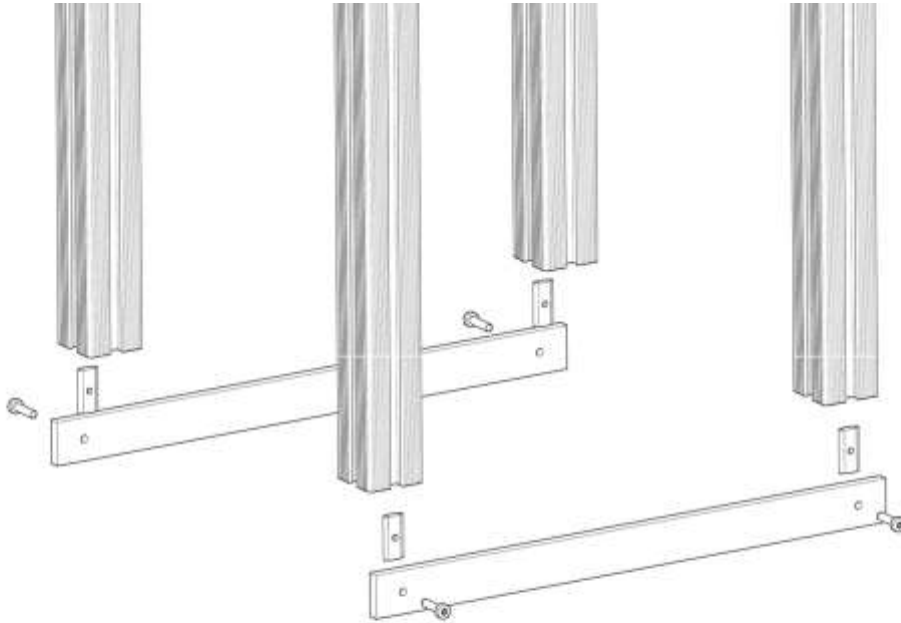

BOM ID	Name	SW Configuration	Artnr (config)	Qty
1	TorxM8-	TXM8x35	04-000-035	4
2	brikke_SFA5116-	50_1T	04-060-050	4
3	minifun_sprosse-1	660	07-510-200	2

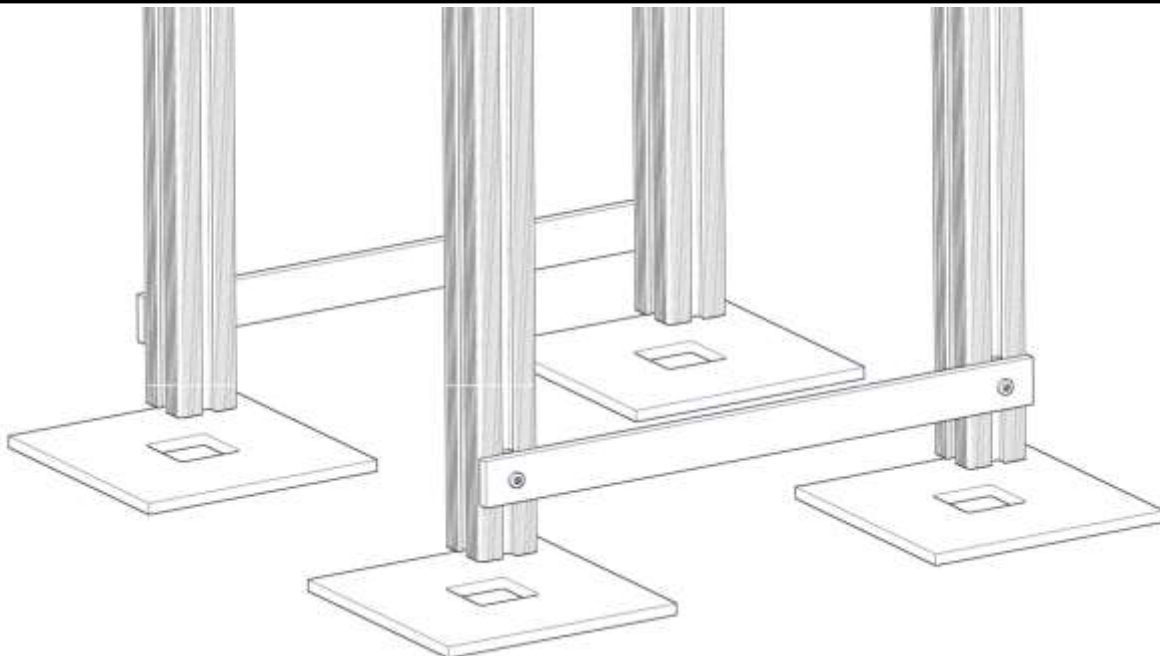

BOM ID	Name	SW Configuration	Artnr (config)	Qty
1	minifunSkive-	Default	07-510-201	4



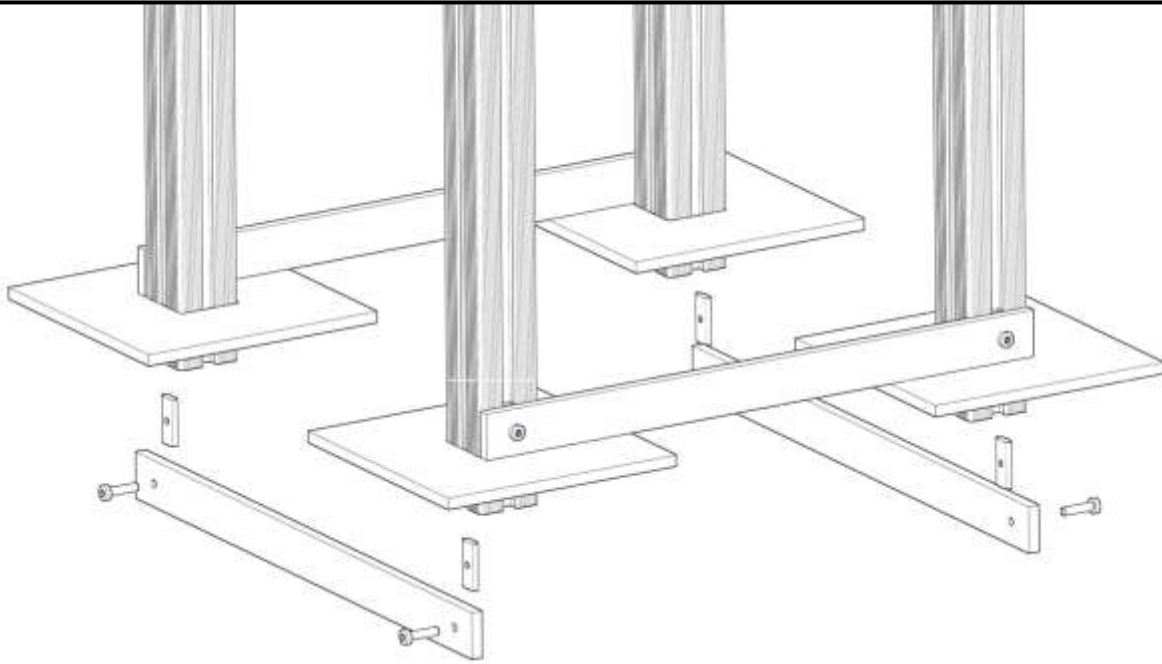

BOM ID	Name	SW Configuration	Artnr (config)	Qty
1	TorxM8-	TXM8x35	04-000-035	4
2	brikke_SFA5116-	50_1T	04-060-050	4
3	minifun_sprosse-1	660	07-510-200	2

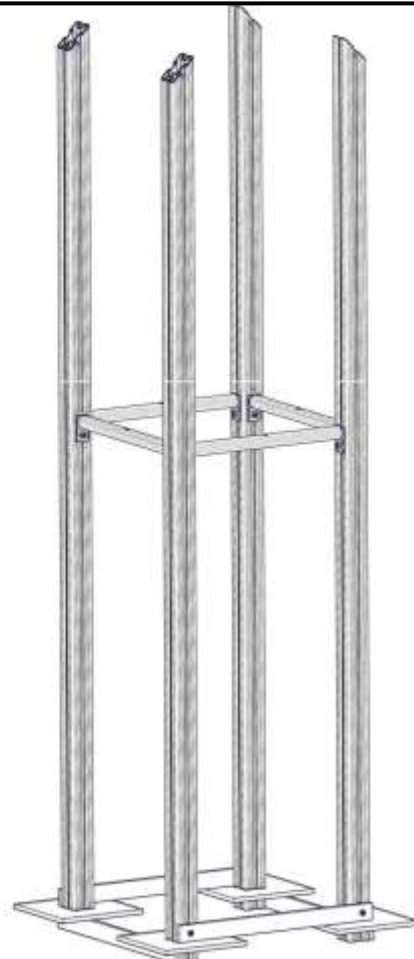



BOM ID	Name	SW Configuration	Artnr (config)	Qty
1	TorxM8-	TXM8x25	04-000-025	8
2	Sperror_MINI508-1	520_Gulv	07-510-161	4



BOM ID	Name	SW Configuration	Artnr (config)	Qty
1	gulvmini-1	Default	07-510-102	1

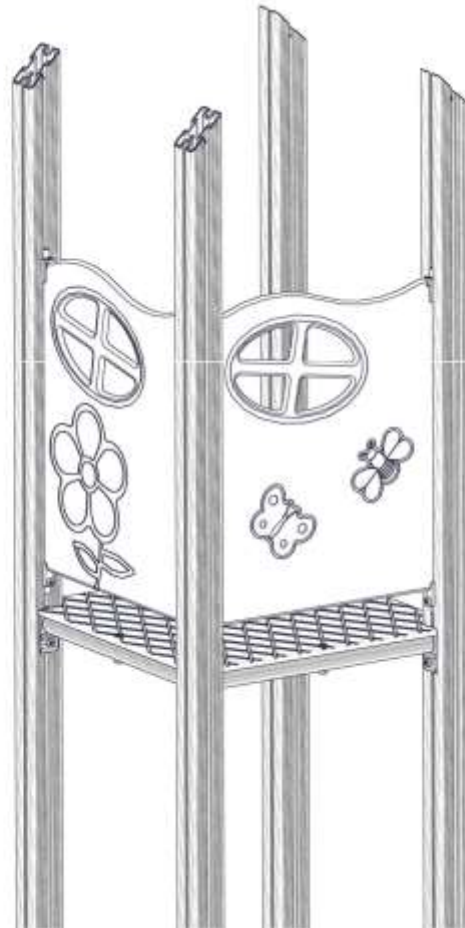
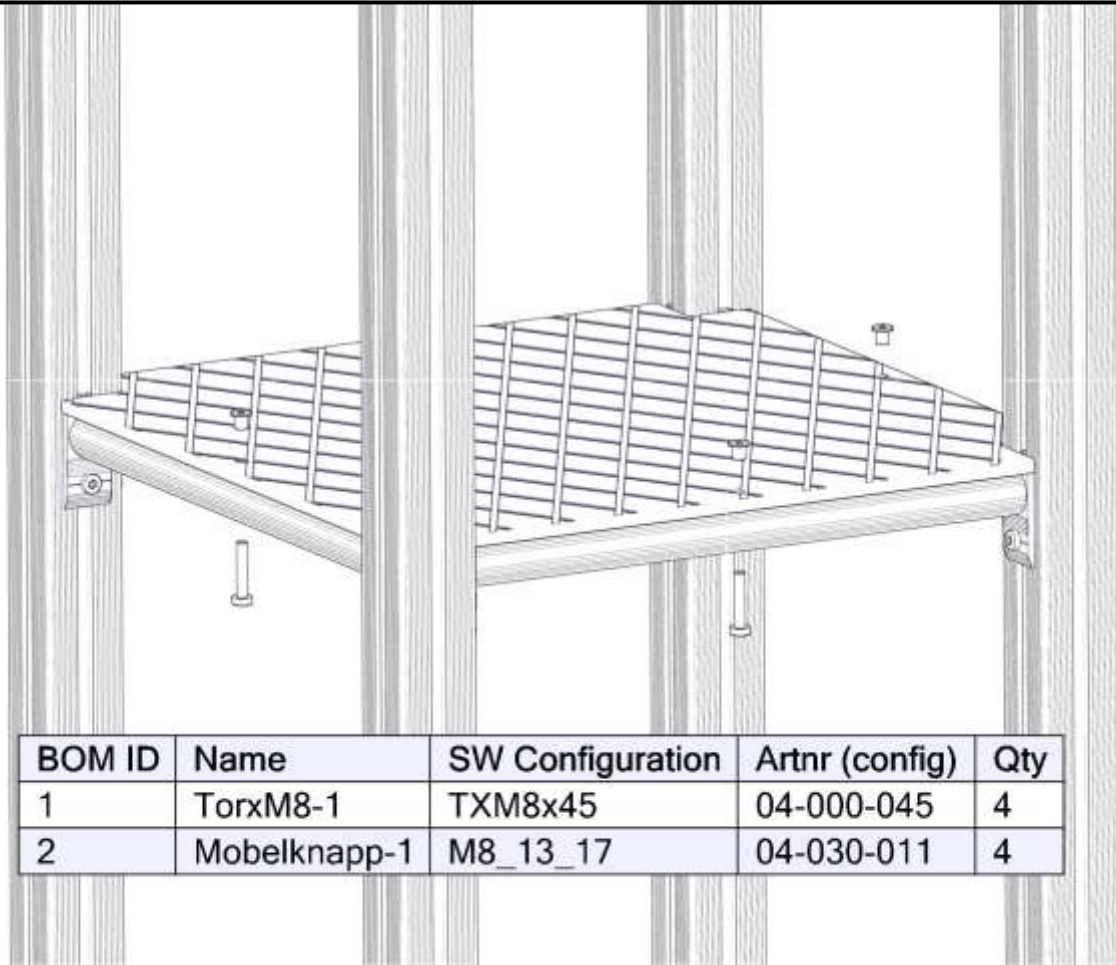

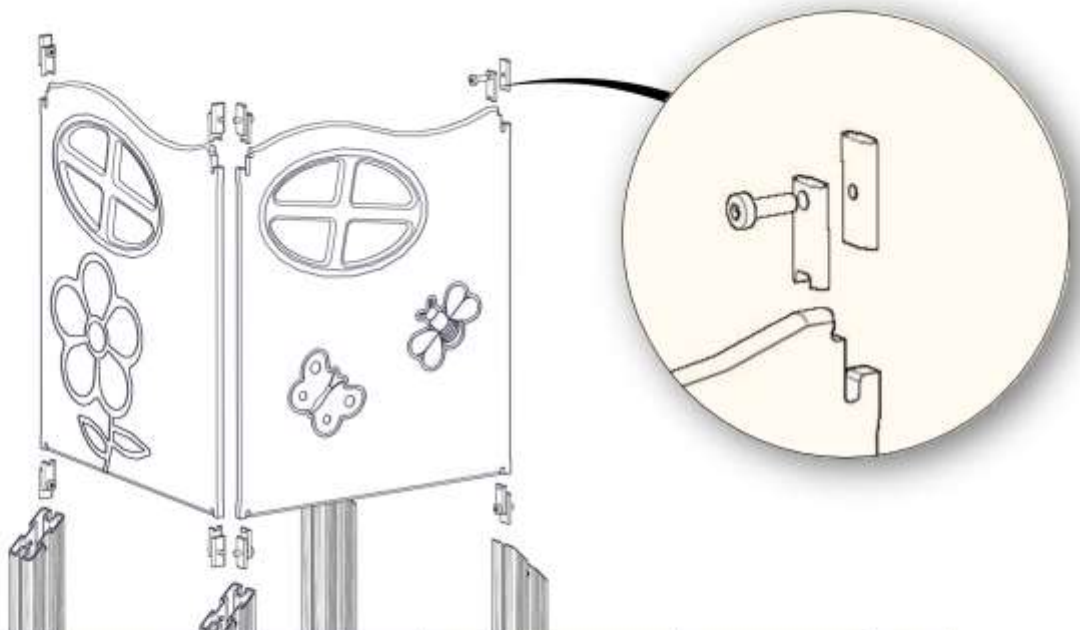

BOM ID	Name	SW Configuration	Artnr (config)	Qty
1	Torxm8-1	TXM8x25	04-000-025	8
2	brikke_SFA5116Special-1	12mm	04-060-041	8
3	brikke_SFA5116-1	50_1T	04-060-050	8
4	VeggMini520x600-1	R	07-510-120	2

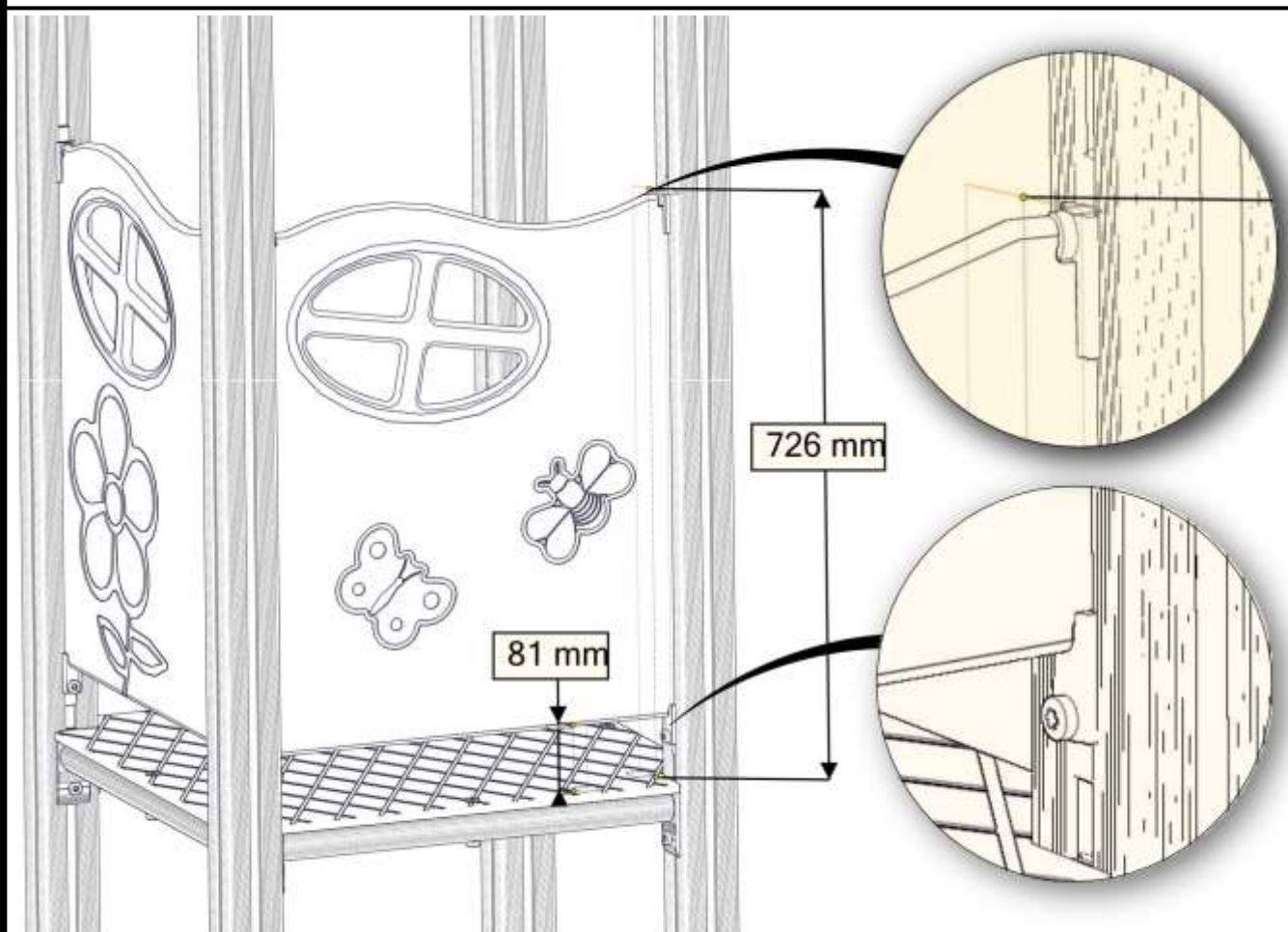

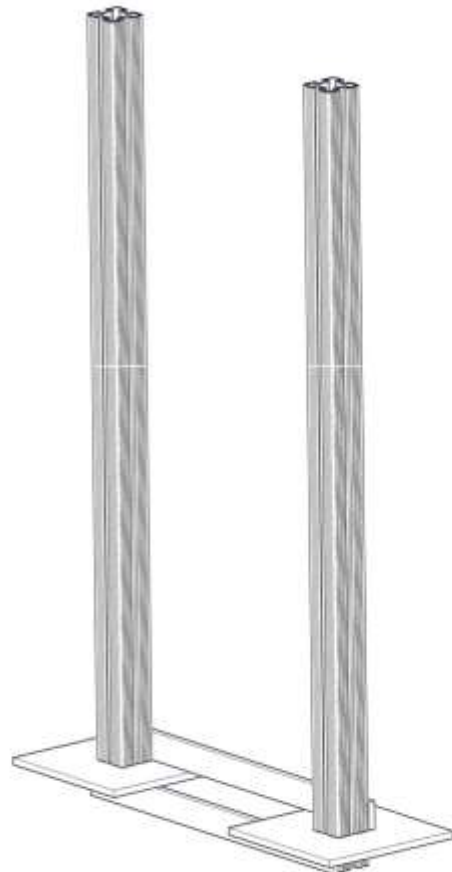
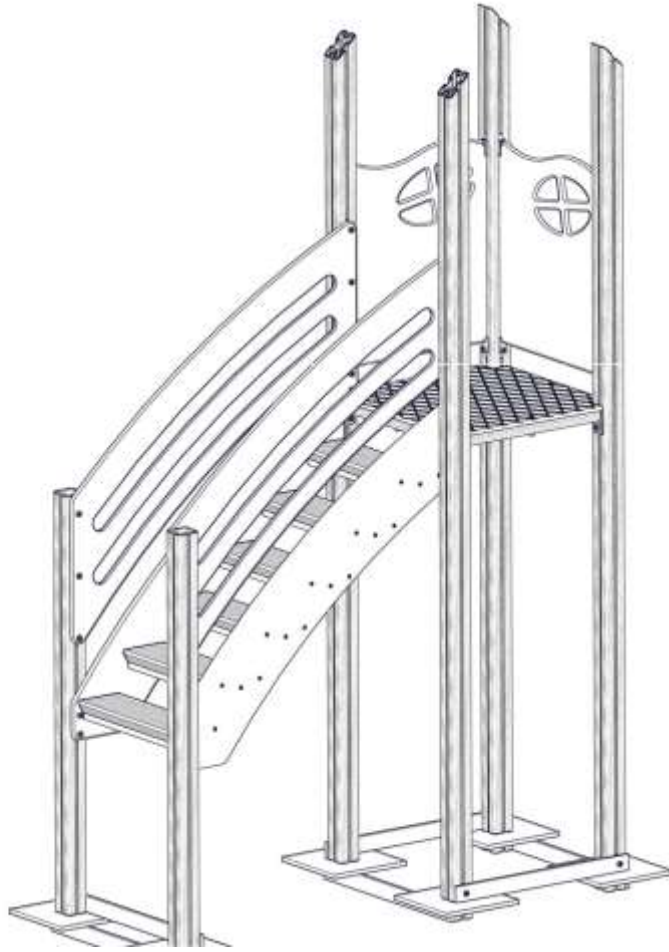



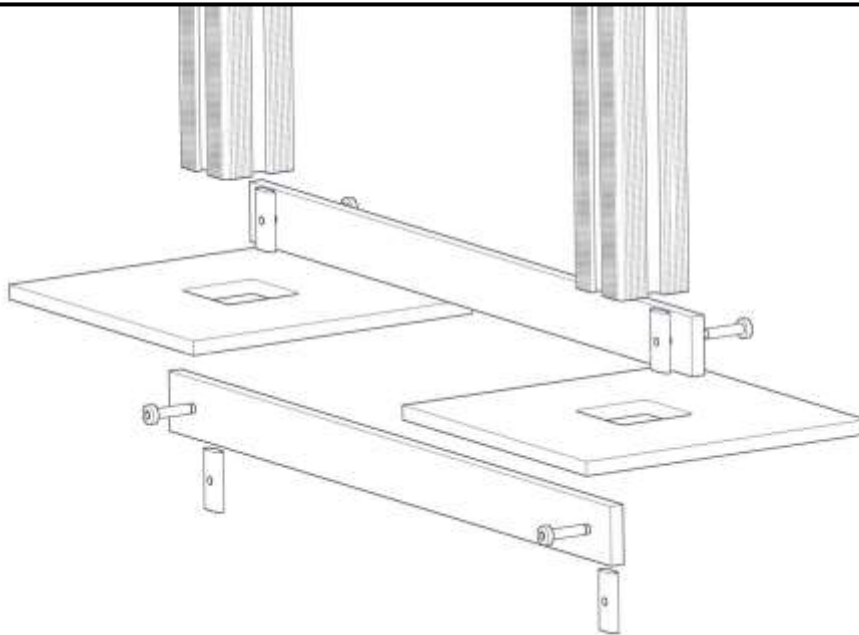

BOM ID	Name	SW Configuration	Artnr (config)	Qty
1	TorxM8-	TXM8x35	04-000-035	4
2	brikke_SFA5116-	50_1T	04-060-050	4
3	minifun_sprosse-1	660	07-510-200	2
4	minifunSkive-	Default	07-510-201	2

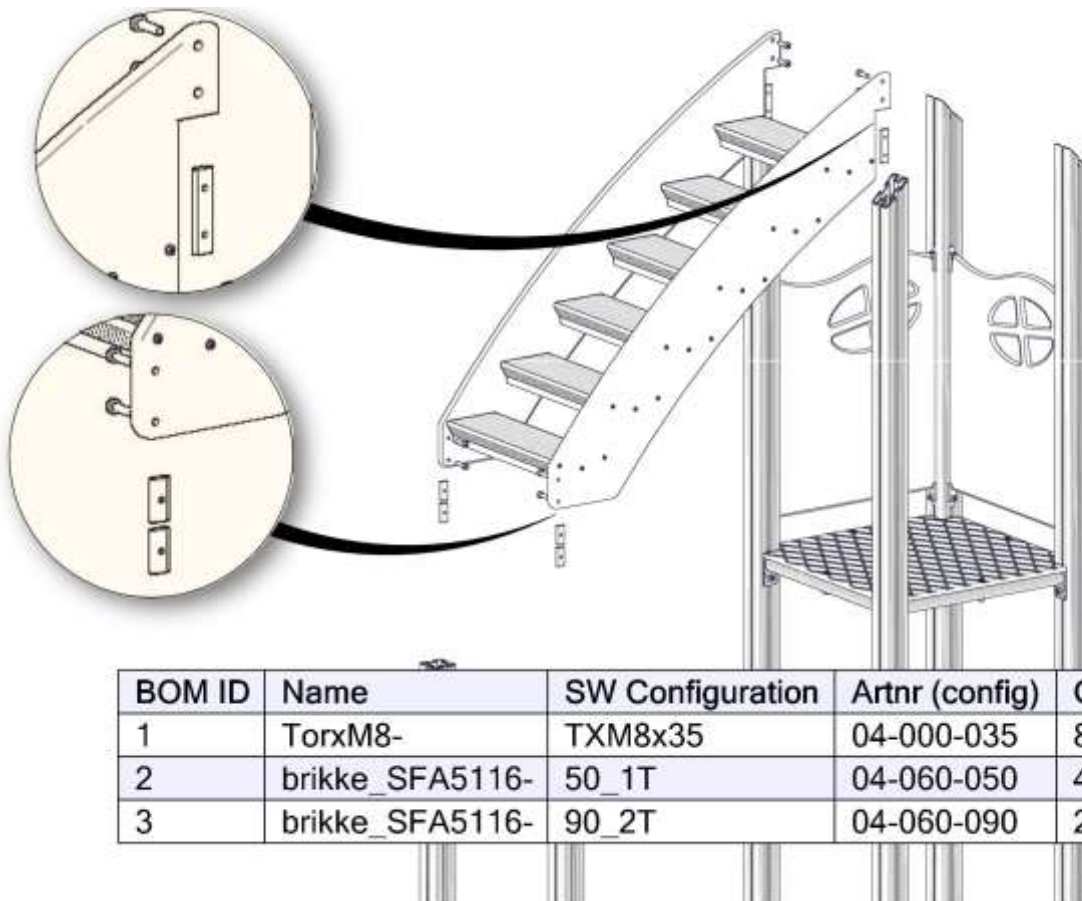

BOM ID	Name	SW Configuration	Artnr (config)	Qty
1	TorxM8-	TXM8x35	04-000-035	8
2	brikke_SFA5116-	50_1T	04-060-050	4
3	brikke_SFA5116-	90_2T	04-060-090	2

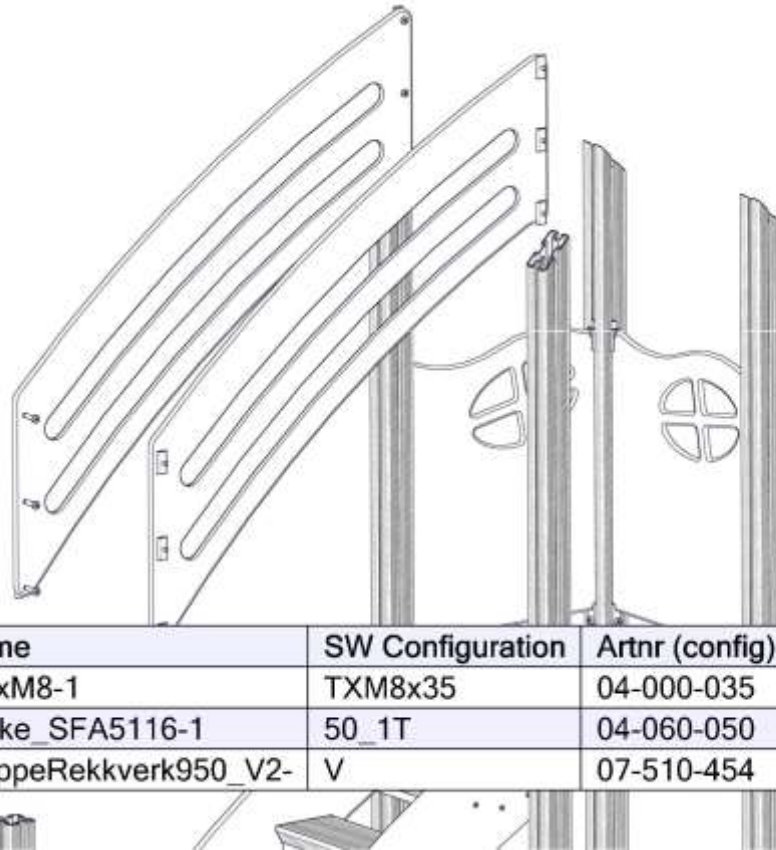

BOM ID	Name	SW Configuration	Artnr (config)	Qty
1	TorxM8-1	TXM8x35	04-000-035	12
2	brikke_SFA5116-1	50_1T	04-060-050	12
3	TreppeRekkverk950_V2-	V	07-510-454	2

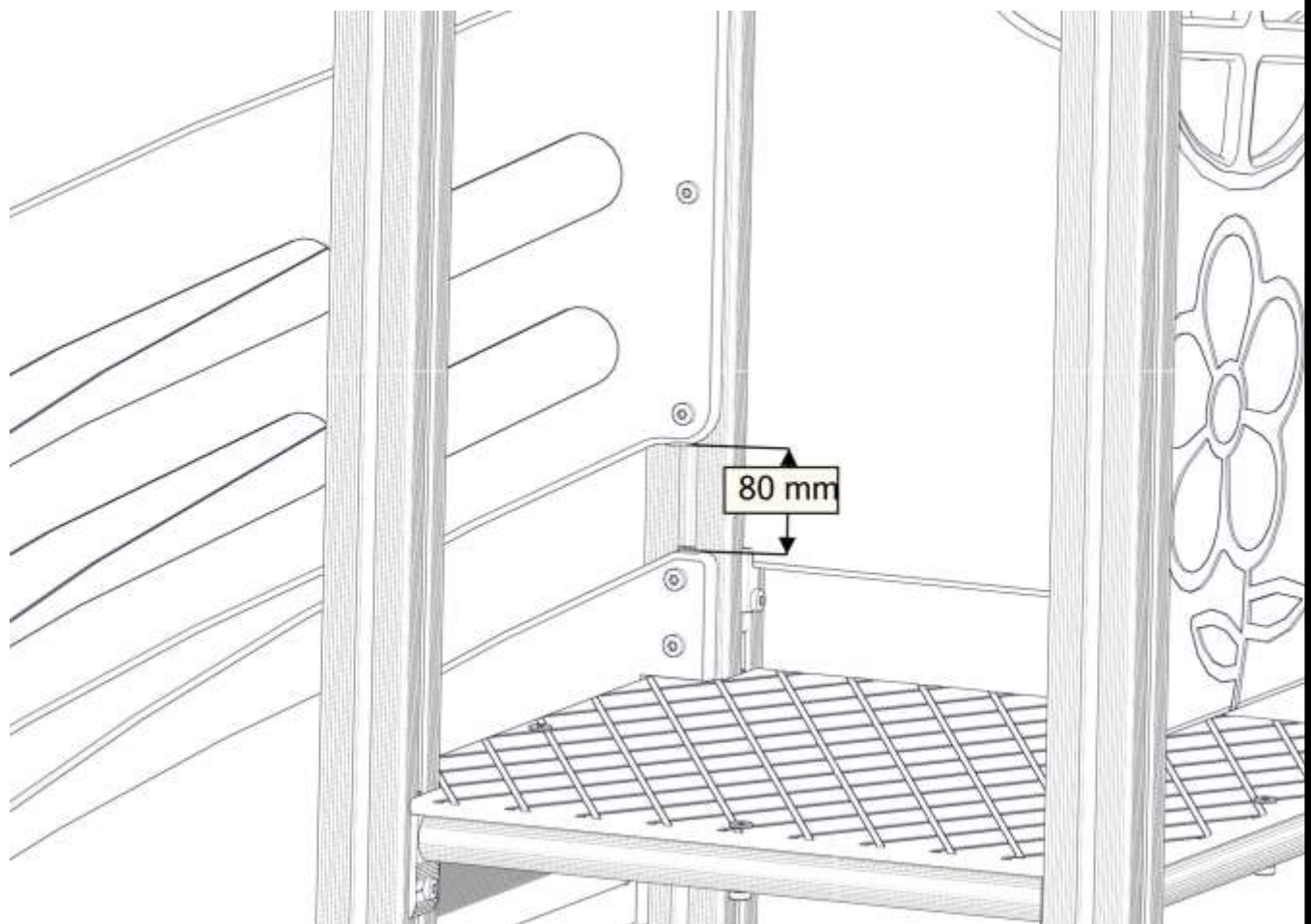



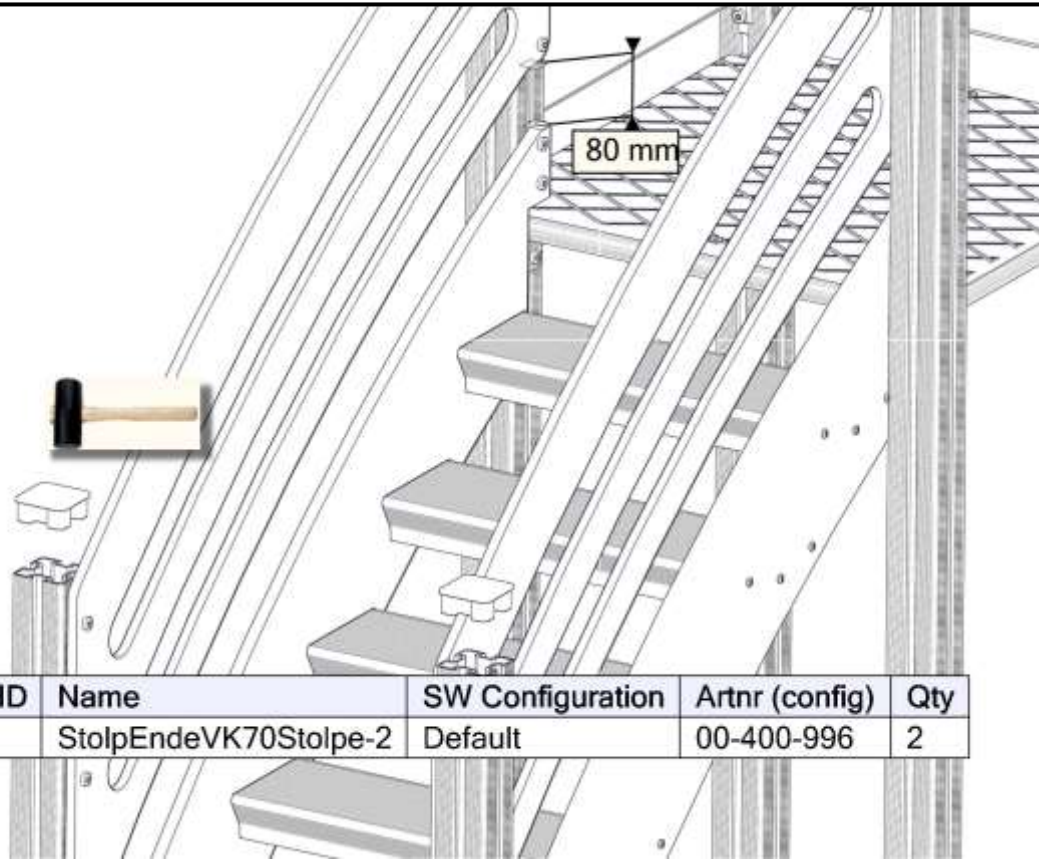

BOM ID	Name	SW Configuration	Artnr (config)	Qty
1	StolpEndeVK70Stolpe-2	Default	00-400-996	2

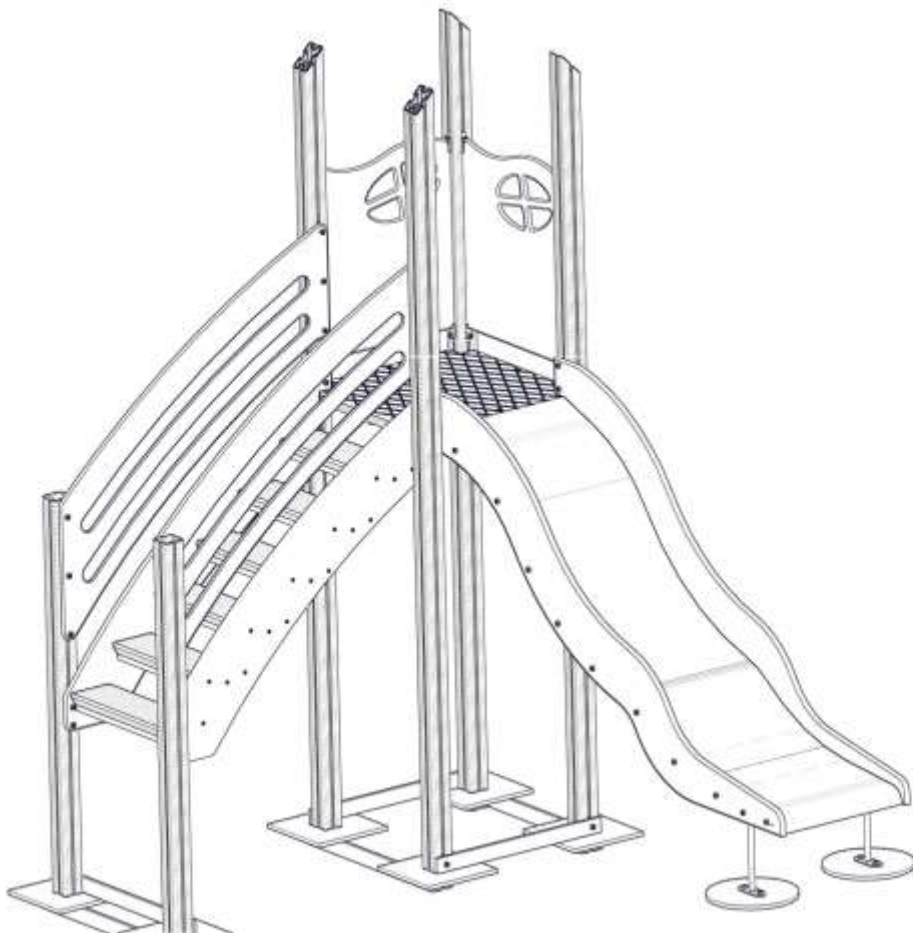

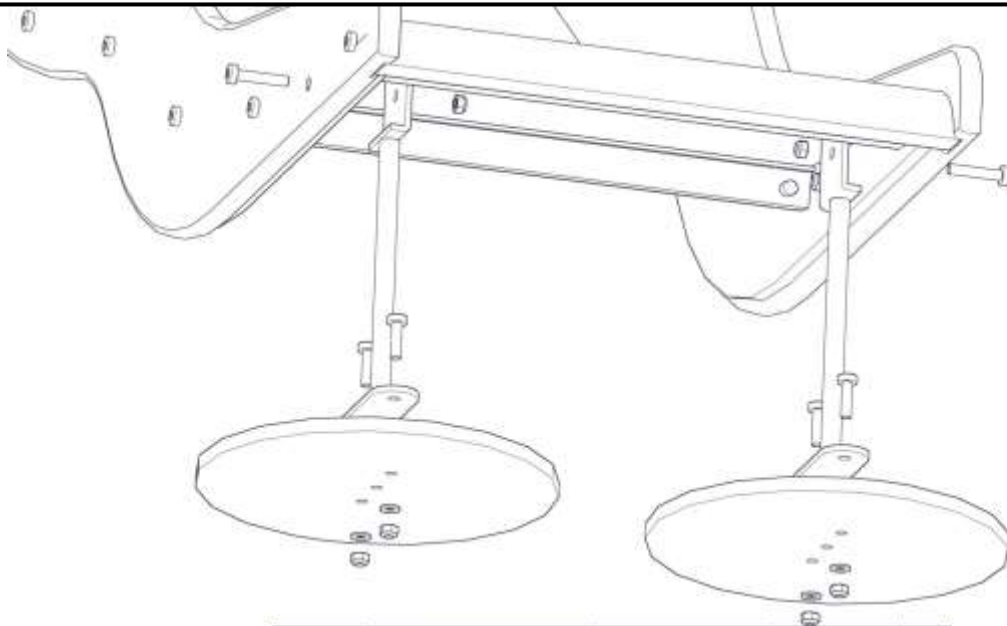

BOM ID	Name	SW Configuration	Artnr (config)	Qty
1	Fundament platte 2H-1	Hoh80	00-003-106	2
2	Steun-1	liten	00-100-310	2
3	Torxm8-	TXM8x30	04-000-030	4
4	Torxm8-1	TXM8x45	04-000-045	2
5	mutter M8-	M8 Borg	04-040-008	6
6	Skive-	M8	04-050-008	4

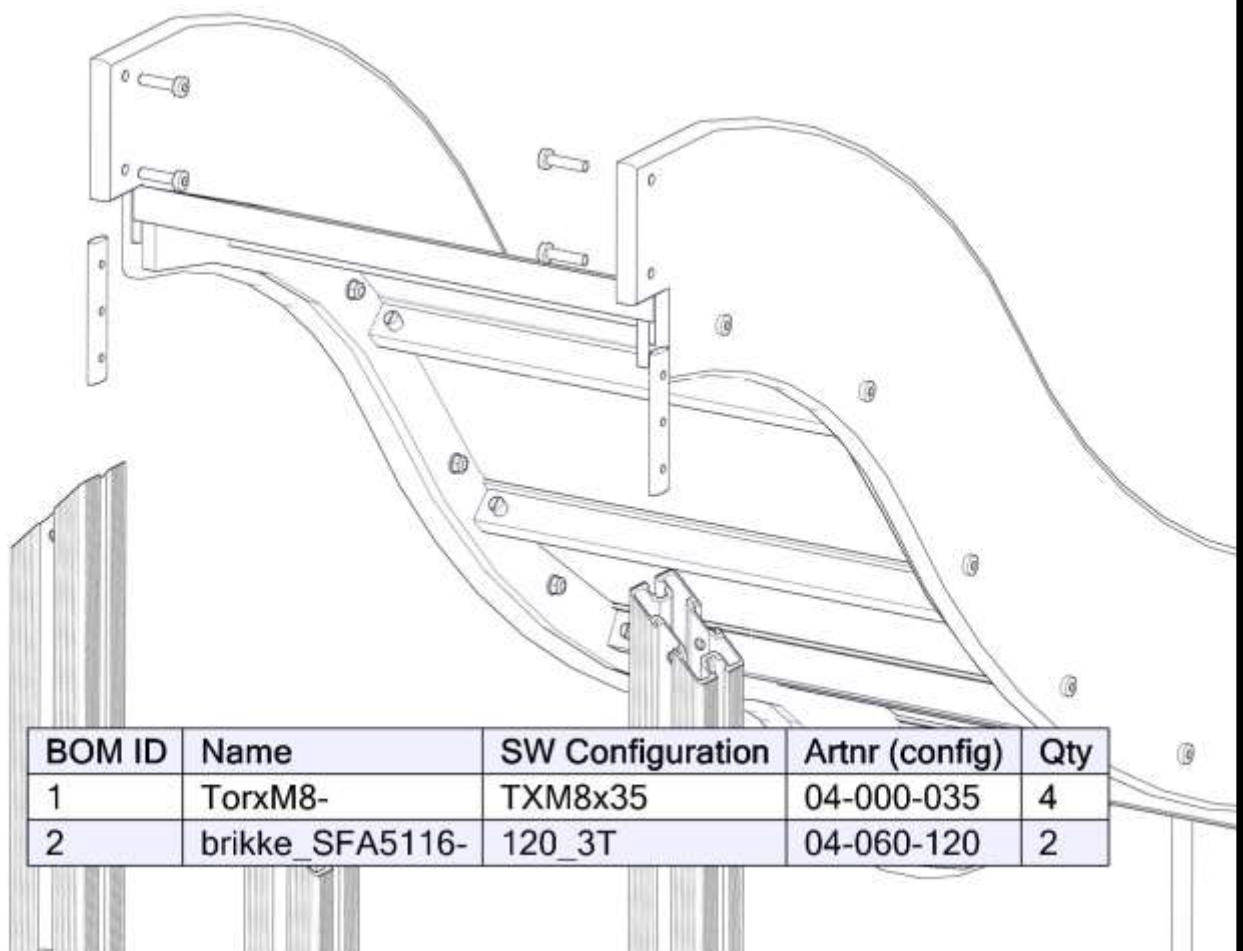

BOM ID	Name	SW Configuration	Artnr (config)	Qty
1	Torxm8-	TXM8x35	04-000-035	4
2	brikke_SFA5116-	120_3T	04-060-120	2

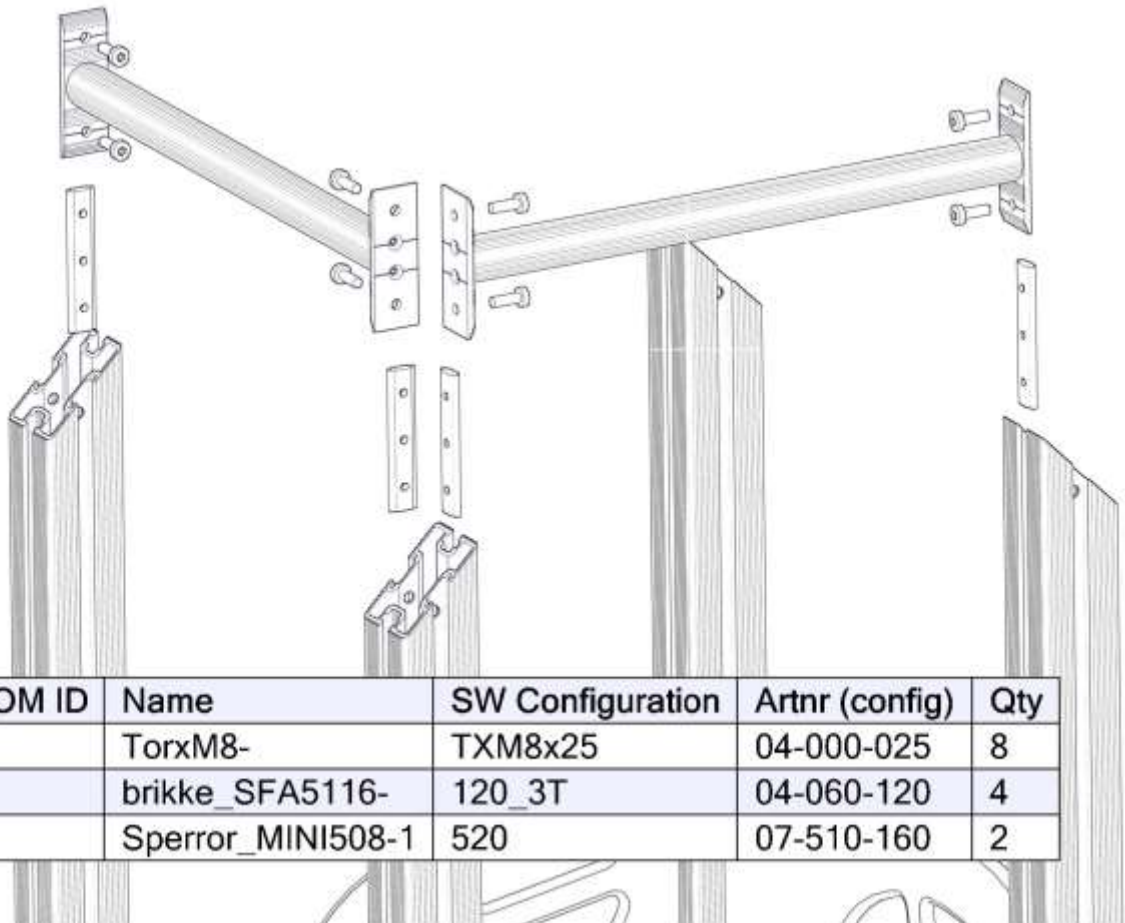
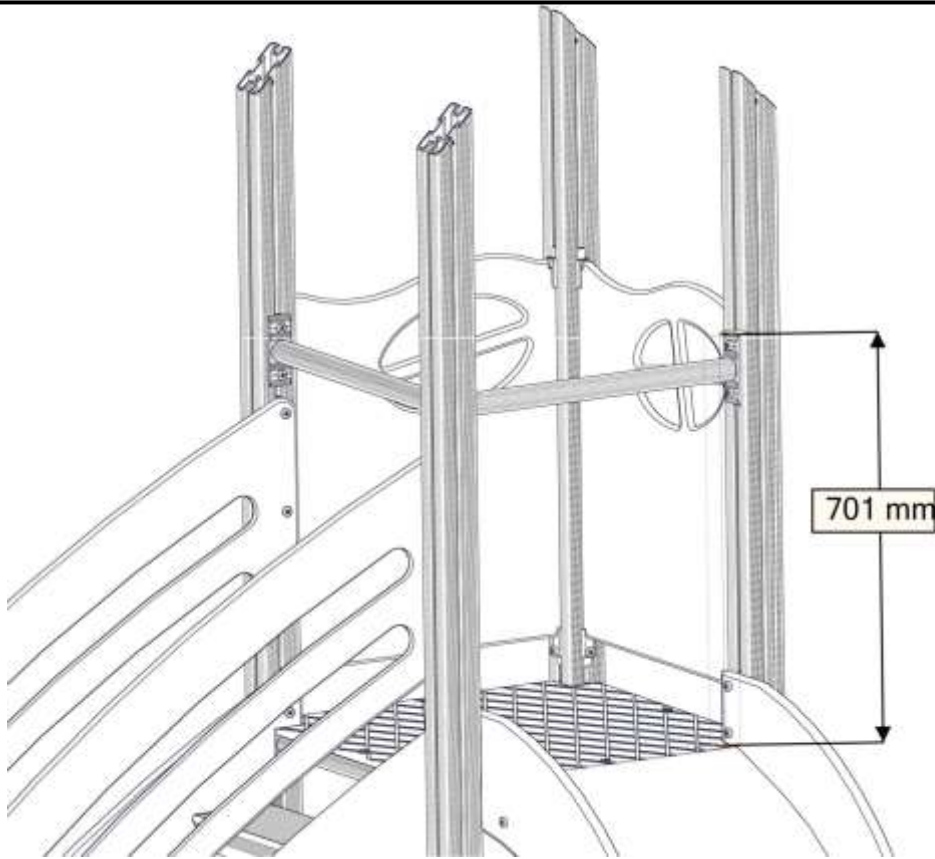

BOM ID	Name	SW Configuration	Artnr (config)	Qty
1	TorxM8-	TXM8x25	04-000-025	8
2	brikke_SFA5116-	120_3T	04-060-120	4
3	Sperror_MINI508-1	520	07-510-160	2

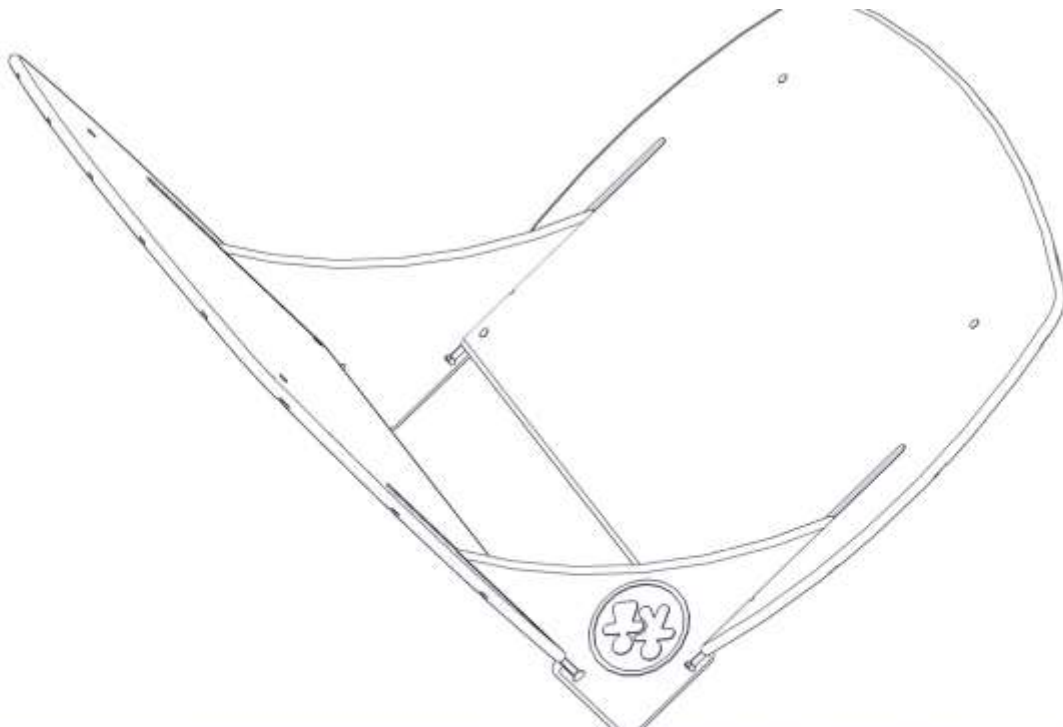
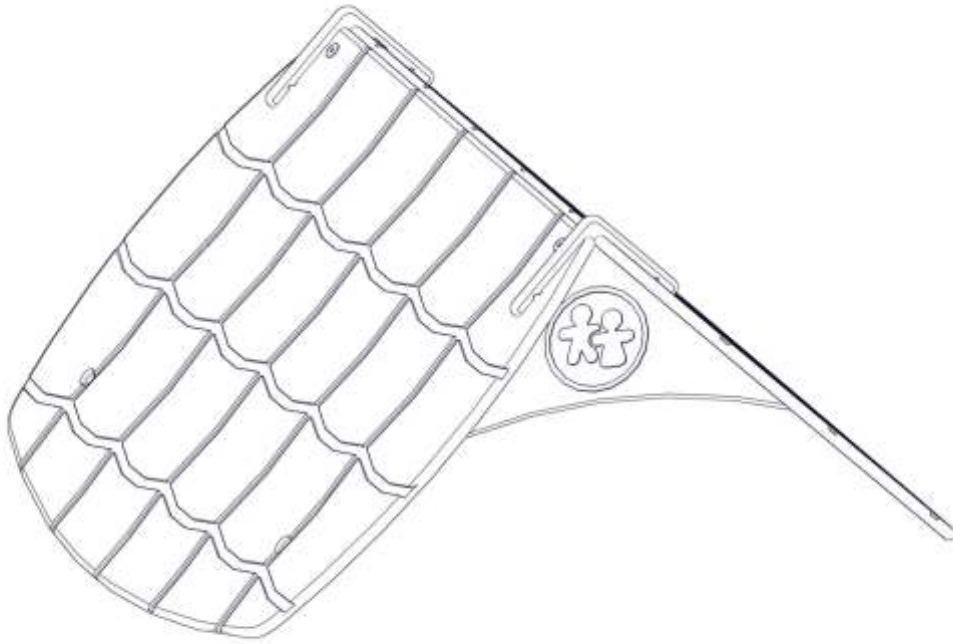

BOM ID	Name	SW Configuration	Artnr (config)	Qty
1	Tak_Miniserie2011-	rod	07-510-105	2
2	Gavelplatemini2011-	Rod	07-510-106	2







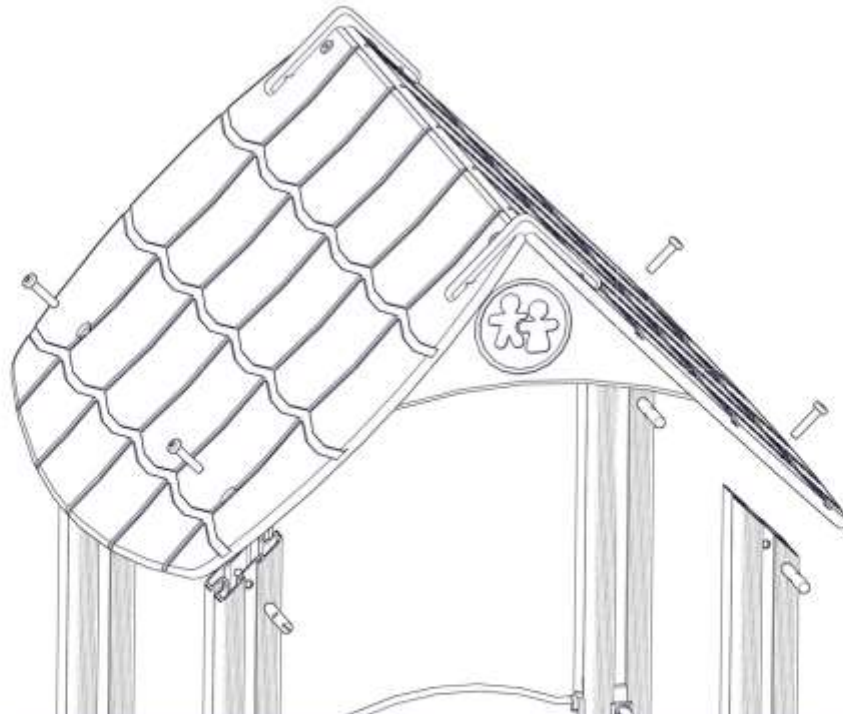





BOM ID	Name	SW Configuration	Artnr (config)	Qty
1	Torxm8-	TXM8x12	04-000-012	4
2	Mobelknapp-	M8_13_17	04-030-011	4
3	Skive-	M8	04-050-008	4
4	35x35x3-1	11mm	04-070-036	2

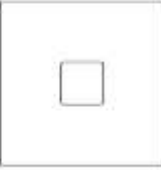











BOM ID	Name	SW Configuration	Artnr (config)	Qty
1	Torxm8-1	TXM8x40	04-000-040	4
2	Hullsemutter_M8_VK70-1	Default	04-018-070	4

<b>Før utstyret tas i bruk / Before play begins / Innan lekredskapet tas i bruk</b>	
<b>N</b>	<ul style="list-style-type: none"> <li>● Påse at fallunderlag er utlagt i henhold til gjeldende regler eller vår anbefaling</li> <li>● Fjern alle monteringshjelpemidler ( rester av betong, planker, paller, plast, og lignende)</li> <li>● Før utstyret tas i bruk, burde man sjekke at det ikke er fare for at anorakksnorer og lignende som kan hekte seg fast noen steder på lekeapparatet. (Vedlagte snor med dobbe (kneledd) kan brukes til å sjekke at dette er i orden. Se vedlagte veiledning for bruk av denne. Dette gjøres for å oppdage eventuelle feilmonteringer.?)</li> <li>● NB! Bor stå i 2-3 dager før bruk</li> </ul>
<b>EN</b>	<ul style="list-style-type: none"> <li>● Make sure the area and depth of safer surfacing are according to the current standard, or to the manufacturer's recommendation</li> <li>● Make sure all tools and surplus materials are removed before play begins</li> <li>● PS! When complete, allow 2-3 days for the concrete to set before use</li> </ul>
<b>S</b>	<ul style="list-style-type: none"> <li>● Kontrollera att fallunderlag är utlagt enligt gällande regler eller vårt rekommendation</li> <li>● Ta bort alla monteringshjälpmedel (rester av betong, plankor, pallar, plast och liknande)</li> <li>● Innan lekredskapet används, kontrollera att anoracksnoddar eller kläder/delar av kläder eller liknande inte kan fastna i några delar på redskapet. (Den bipackade "knävringen" kan man med fördel användas för denna kontroll.</li> <li>● Detta görs för att upptäcka eventuella felmonteringar.)</li> </ul>

<b>Boltepakker for / Boltpackage for / Bultpaket för</b>			Sign. _____
	VK70 skrå 2100-600 07-510-158	<b>4</b>	Sperrerør 520 07-510-160
	Minisprosse 07-510-200	<b>6</b>	Sperrerør gulv 07-510-161
	FunminiSkive 07-510-201	<b>6</b>	VK70 600-800 07-510-455
	Rutsjebane 07-510-305	<b>1</b>	Gulv 520 07-510-102
	Vegg 520x600 07-510-120	<b>1</b>	Vegg 520x600 07-510-120
	Tak mini 07-510-105	<b>2</b>	Gavelplate 07-510-106
	Ende lokk 00-400-996	<b>2</b>	Trapp 950 07-510-451
	Rekkverk trapp 07-510-454	<b>2</b>	Produktmerke 07-500-500



<b>Boltepakker for / Boltpackage for / Bultpaket för</b>			Sign. _____.		
	Torx M8x12 04-000-012	<b>4</b>		Brikke 50-1T 04-060-050	<b>36</b>
	Torx M8x25 04-000-025	<b>24</b>		Brikke 90-2T 04-060-090	<b>2</b>
	Torx M8x30 04-000-030	<b>4</b>			Brikke 120-3T 04-060-120
	Torx M8x35 04-000-035	<b>36</b>			
	Torx M8x40 04-000-040	<b>4</b>	BrikkeSpesial 04-060-041		<b>8</b>
	Torx M8x45 04-000-045	<b>6</b>			
	Hylsemutter 04-018-070	<b>4</b>		Møbelknapp 04-030-011	<b>8</b>
	Vinkel 35x35x35x3 04-070-036	<b>2</b>		Skive M8 04-050-008	<b>8</b>
	Låsemutter M8 04-040-008	<b>6</b>		Fundament skive 00-003-106	<b>2</b>
				Stålforankring 00-100-310	<b>2</b>