

N

Monteringsanvisning

EN

Assembly Instructions

S

Monteringsanvisning

Produkt nr. / Product no. / Produkt nr.

25-200-130

Ord. nr. _____

Dato. _____

Sign. _____

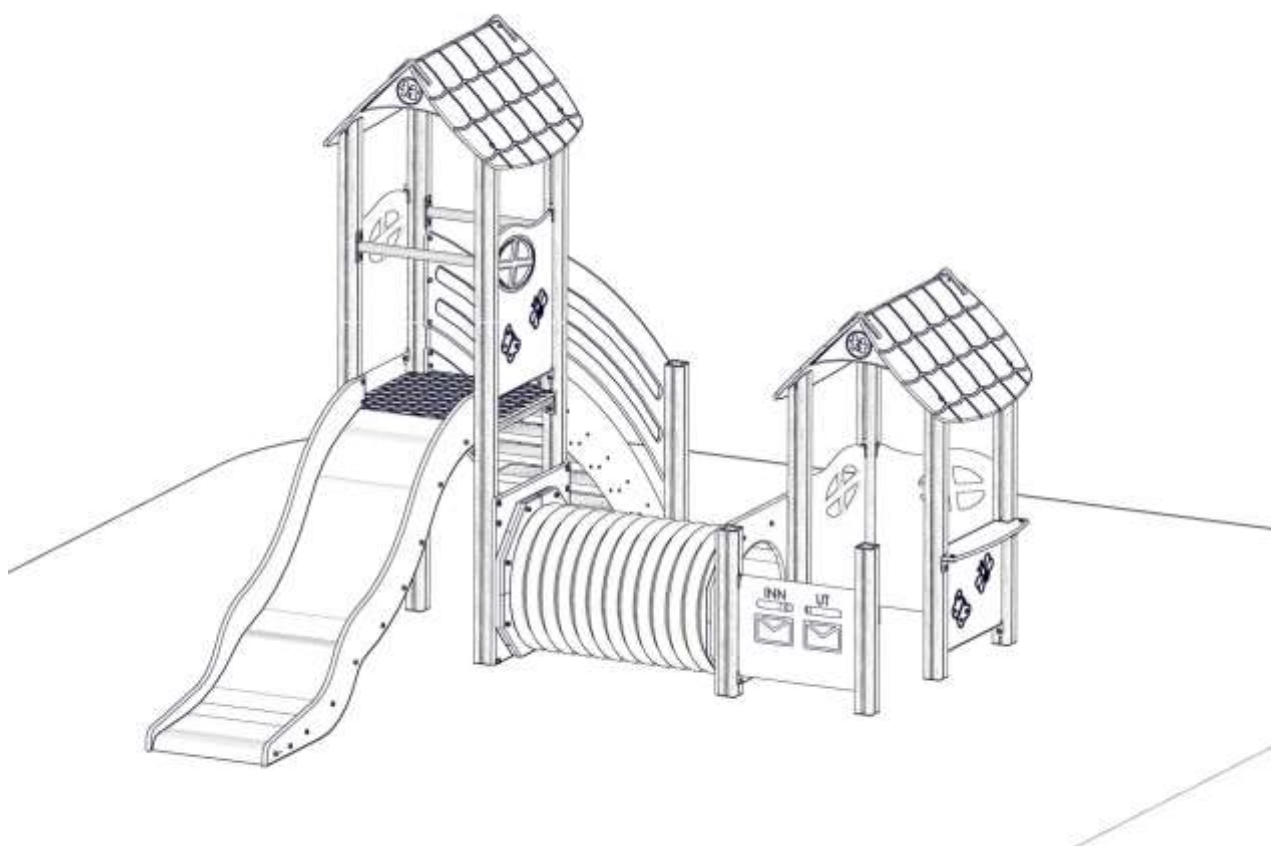

Søve AS
Grønnvoldveien 290
3830 Ulefoss - Norway
Tlf: +47 35 94 65 65



Søve AB
EA Rosengrensgatan 32
421 31 Västra Frölunda
Phone: +46 (0)31 773 97 00
www.sove.se

Monteringstips / Assembly Advice / Monteringsstips

N

- Les monteringsanvisningen nøye før montering.
- Monter elementene i rekkefølgen som vist.
- Boltene bør ikke skrues for hardt til før alt er montert, vatret og loddet. Skru så boltene til.
- NB! Ved bruk av drill, kan boltene ryke.
- Er lekeutstyret plassert i naturlige ferdselstraséer må området sikres mot gjennomgang.
- Innspringningshinder bør vurderes rundt lekeapparater hvor det er stor bevegelse, f.eks. ved huskestativ.
- Det bør være fritt innsyn til lekeutstyr som er beregnet for barn under 3 år.

NB! Under monteringsarbeidet må utstyr, som ikke er forankret forsvarlig i bakken, sikres slik at det ikke velte.

Området må avstenges under montering av apparatene med sperrebånd eller lignende.

EN

- Read the instruction carefully before assembling the play unit..
- Assemble the components in the sequence shown in these instructions.
- Fixings must not be fully tightened during assembly. Before casting the foundations, the structure must be level and plumb, at which point all fixings are tightened.
- PS! If use of drill, the bolts may be wrecked.
- Secure the construction-area to prevent people from walking through it.
- Consider installing barriers around play-equipment which gives rise to a lot of activity – i.e.swings.
- Ensure that clear vision is possible across the play area so that supervision is possible from any position, particularly where children under 3 years of age will be playing.

NB! During assembly of the equipment, ensure that all structures are securely propped, especially when left overnight. Also ensure that equipment is supported whilst concrete foundations are setting and enclose the area securely to prevent access.

Monteringstips / Assembly Advice / Monteringsstips

S

- Läs monteringsanvisningen noga före montering.
- Montera delarna i den ordningen som anvisas
- Skruvarna bör inte skruvas för hårt tills allt är monterat, i våg och lodat.











OBS! Används elektrisk skruvdragare, kan bulten gå sönder. Hårddra därför manuellt!

- Om lekplatsen placeras vid en gångväg mm bör området säkras mot genomfart av gående och cyklister.
- Inspringningshinder bör placeras runt lekutrustning med stor rörelse, t ex, gungställning.
- Det bör vara fri insyn till lekutrustning beräknat till barn under 3 år.

OBS! Under monteringsarbete bör utrustningen som inte ska förankras i marken, ställs så att den inte kan välta.

Området måste spärras när lekutrustningen byggs upp, med avspärrningsband eller liknande.

Nødvendig verktøy / Tools required / Nödvändiga verktyg

<p>(N)</p> <p>(UK)</p> <p>(S)</p>	<p>(A)</p> 	<p>(B)</p>  <p>Torx Nr 45 High quality</p>	<p>(C)</p> <p>5 mm 6 mm</p> 	<p>(D)</p> 	<p>(E)</p> 
		<p>Metermål Metric measure Tumstoc</p> 	<p>16 V</p> 	<p>Merkebånd Mark ribbon Märkeband</p> 	<p>13 + 17mm</p> 

Nødvendig antall personer / Number of persons required / Lämpligt antal personer





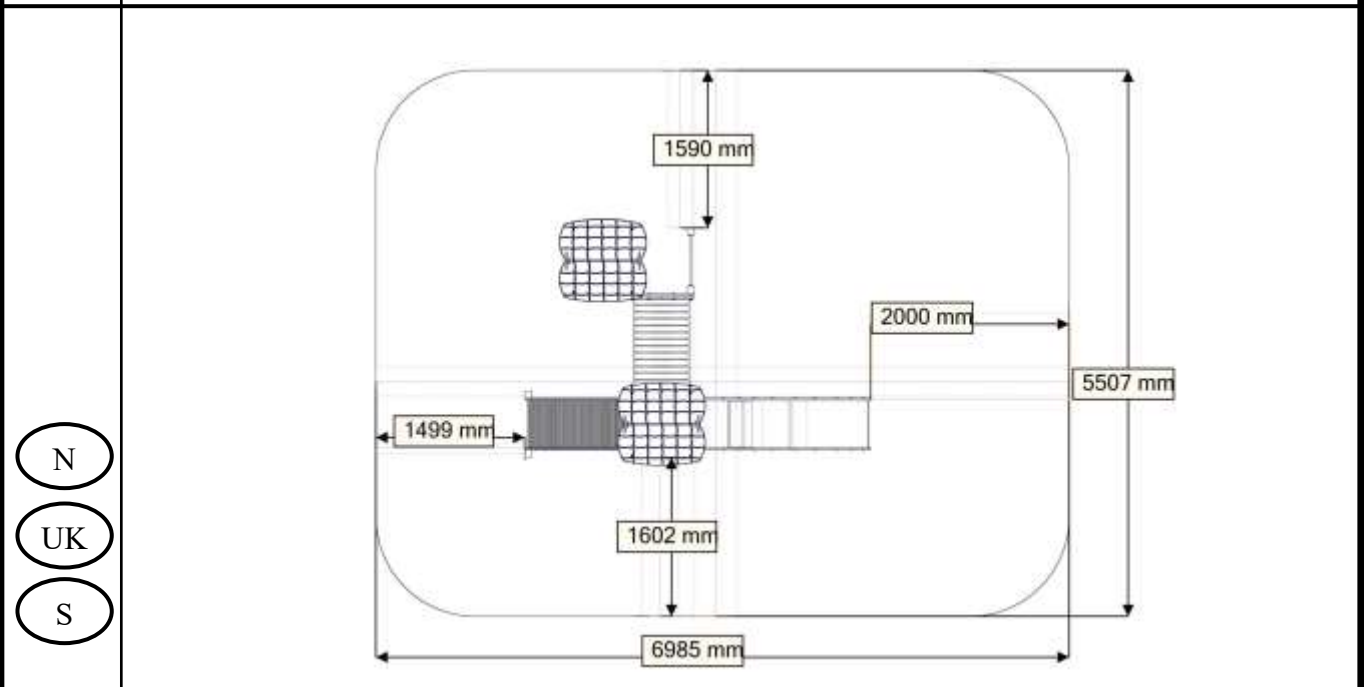



















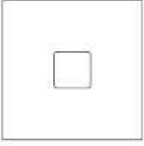

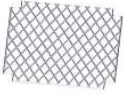

Anbefalt arealbehov ved montering / Recommended working space / Rekommenderad arealbehov vid montering



Boltepakker for / Boltpackage for / Bultpaket för















Sign. _____

Stolpe 70x70 skrå	Ant= 8	Navn	Artnr/dimensjon	Ant	Lev
		VK70 2100-600 (1) Skrå Brikke på stolpe! VK70 1150-600(1)	07-510-158 07-510-156	4 4	
		Torx M8x40 (1)	04-000-040	8	
		Hullsemutter (1) VK70	04-018-070	8	
Stolpe70x70:	Ant= 2	Navn	Artnr/dimensjon	Ant	Lev
		VK70 660-600 (1)	07-510-150	2	
Endelokk 70x70	Ant= 2	Navn	Artnr/dimensjon	Ant	Lev
		Endelokk70x70 (1)	00-400-996	2	
FundamentMini 1250	Ant= 2	Navn	Artnr/dimensjon	Ant	Lev
		miniSprosse 1250 (1)	07-510-202	2	
		Brikke 50_1T (3)	04-060-040	6	
		Torx M8x35 (3)	04-000-035	6	
FundamentMini 660	Ant= 7	Navn	Artnr/dimensjon	Ant	Lev
		miniSprosse 660 (1)	07-510-200	7	
		Brikke 50_1T (2)	04-060-040	14	
		Torx M8x35 (2)	04-000-035	14	

Boltepakker for / Boltpackage for / Bultpaket för						Sign. _____
FundamentSkive	Ant= 10	Navn	Artnr/dimensjon	Ant	Lev	
		Skive (1)	07-510-201	10		
Gulv mini	Ant= 1	Navn	Artnr/dimensjon	Ant	Lev	
		Gulv Mini 520(1)	07-510-102	1		
		Møbelknapp (4)	04-030-011	4		
		Torx M8x45 (4)	04-000-045	4		
Vegge 520x400 Postkasse	Ant= 1	Navn	Artnr/dimensjon	Ant	Lev	
		Vegge520x400(1) Postkasse	07-510-111	1		
		Brikkespesial(4)	04-060-041	4		
		Brikke(4)	04-060-040	4		
		Torx M8x25(4)	04-000-025	4		
Vegge 520x400 Sommerfugl / bie	Ant= 1	Navn	Artnr/dimensjon	Ant	Lev	
		Vegge520x400 (1) Sommerfugl/bi	07-510-110	1		
		Brikkespesial(4)	04-060-041	4		
		Brikke(4)	04-060-040	4		
		Torx M8x25(4)	04-000-025	4		

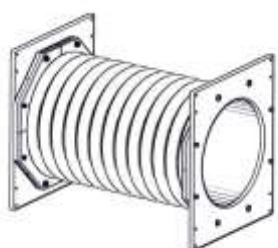
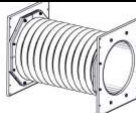













Boltepakker for / Boltpackage for / Bultpaket för

Sign. _____

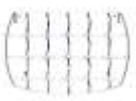
Vegge 520x600 Vindo bloms	Ant= 2	Navn	Artnr/dimensjon	Ant	Lev
		Vegge520x600 (1) Vindu blom	07-510-120	2	
		Brikkespesial(4)	04-060-041	8	
		Brikke(4)	04-060-040	8	
		Torx M8x25(4)	04-000-025	8	
Vegge 520x600 Vindo Bi	Ant= 2	Navn	Artnr/dimensjon	Ant	Lev
		Vegge520x600 (1) Vindu bi/ Sommerfulg	07-510-120	2	
		Brikkespesial(4)	04-060-041	8	
		Brikke(4)	04-060-040	8	
		Torx M8x25(4)	04-000-025	8	
Tunnel 500 L=1000	Ant= 1	Navn	Artnr/dimensjon	Ant	Lev
		Tunell	07-510-481	1	
		Brikke 120 3T(8)	04-060-041	8	
		Torx M8x35 (16)	04-060-040	16	
		Skive M8 (16)	04-050-008	16	









Boltepakker for / Boltpackage for / Bultpaket för

Sign. _____.

Sperrerør 520	Ant= 2	Navn	Artnr/dimensjon	Ant	Lev
		Sperrerør 520 (1)	07-510-160	2	
		Brikke 120_3T (2)	04-060-120	4	
		Torx M8x25 (4)	04-000-025	8	
Sperrerør 520 gulv	Ant= 4	Navn	Artnr/dimensjon	Ant	Lev
		Sperrerør 520 (1)	07-510-161	4	
		Brikke 90_2T (2)	04-060-090	0 På stolpe	
		Torx M8x25 (2)	04-000-025	8	
Tak	Ant= 2	Navn	Artnr/dimensjon	Ant	Lev
		Tak mini (2)	07-510-105	4	
		Gavelplate(2)	07-510-106	4	
		Vinkel 35x35x3(2) 11mm	04-070-036	4	
		Møbelknapp	04-030-011	8	
		Torx M8x12(4)	04-000-012	8	
		Skive M8 (4)	04-050-008	8	













Boltepakker for / Boltpackage for / Bultpaket för

Sign. _____

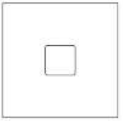
Rutsjebane 950 07-510-310	Ant= 1	Navn	Artnr/dimensjon	Ant	Lev
		Rutsjebane	07-510-310	1	
		Brikke120 3T(5)	04-060-120	2	
		Torx M8x35(4)	04-000-035	4	
		Torx M8x45(2)	04-000-045	2	
		Torzx M8x30(4)	04-000-030	4	
		Fundamentskive(2) 2H 80	00-003-106	2	
		Skive M8(2)	04-050-008	4	
		Mutter M8(2)	04-040-008	6	
	Stålforankering(2)	00-100-310	2		









Boltepakker for / Boltpackage for / Bultpaket för

Sign. _____

Stolpe 70x70	Ant= 2	Navn	Artnr/dimensjon	Ant	Lev
		VK70x70 (1) 600-800=1400	07-510-455	2	
		Stolpende	00-400-996	2	
FundamentMini 660	Ant= 2	Navn	Artnr/dimensjon	Ant	Lev
		miniSprosse 660 (1)	07-510-200	2	
		Brikke 50_1T (2)	04-060-040	4	
		Torx M8x35 (2)	04-000-035	4	
FundamentSkive	Ant= 2	Navn	Artnr/dimensjon	Ant	Lev
		Skive (1)	07-510-201	2	
Trapp 950	Ant= 1	Navn	Artnr/dimensjon	Ant	Lev
		Trapp 950	07-510-451	1	
		Rekkverk trappa	07-510-454	2	
		Brikke 50 1T	04-060-050	16	
		Brikke 90 2T	04-060-090	2	
		Torx M8x35	04-000-035	20	

Boltepakker for / Boltpackage for / Bultpaket för

Sign. _____.

Buttikkdisk	Ant= 1	Navn	Artnr/dimensjon	Ant	Lev
		Butikkdiskk	07-510-130	1	
		Vinkel 50x50x4(2) 11mm	04-070-050	2	
		Møbelknapp(2)	04-030-011	2	
		Brikke 501T(2)	04-060-040	2	
		Torx M8x12 (2) Torx M8x20 (2)	04-000-012 04-000-020	2 2	
		Skive M8 (2)	04-050-008	2	
Produktmerke	Ant= 1	Navn	Artnr/dimensjon	Ant	Lev
		Produktmerking Hos Søve	25-200-090	1	

Fundamentering med betong / Foundation concrete / Förankring med betong

(N)	Støtsand		(N)	(UK)	(S)
(UK)	Safer surface		Bakkenivå	Ground level	Marknivå
(S)	Stridsan				Ref NS-EN 177
(N)	Komprimert masse.	betong			
(UK)	Compressed mass.	concrete			
(S)	Komprimerad massa.	betong			

Fundamentering uten betong / Foundation without concrete / Förankring utan betong

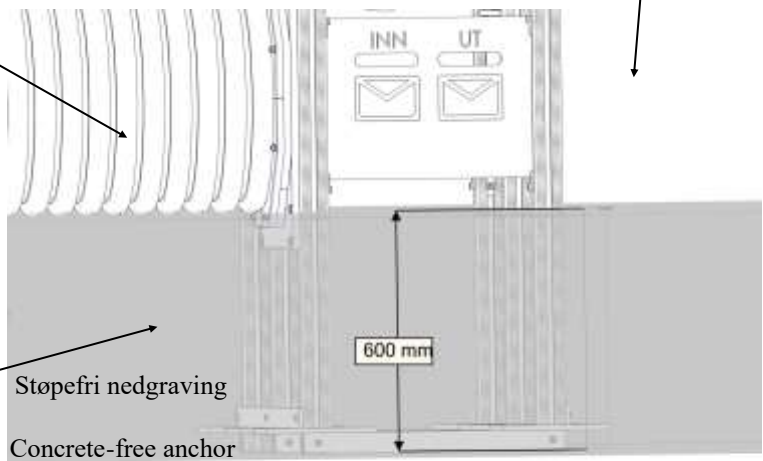
(N)	Støtsand		(N)	(UK)	(S)
(UK)	Safer surface		Bakkenivå	Ground level	Marknivå
(S)	Stridsan				Ref NS-EN 1177
(N)	Komprimert masse	Støpefri nedgraving			
(UK)	Compressed mass	Concrete-free anchor			
(S)	Komprimerad massa	Nedgrävningfundament			

(N)	Alle mål er oppgitt i millimeter
(UK)	Scale measured in mm
(S)	Alla mått är i millimeter.

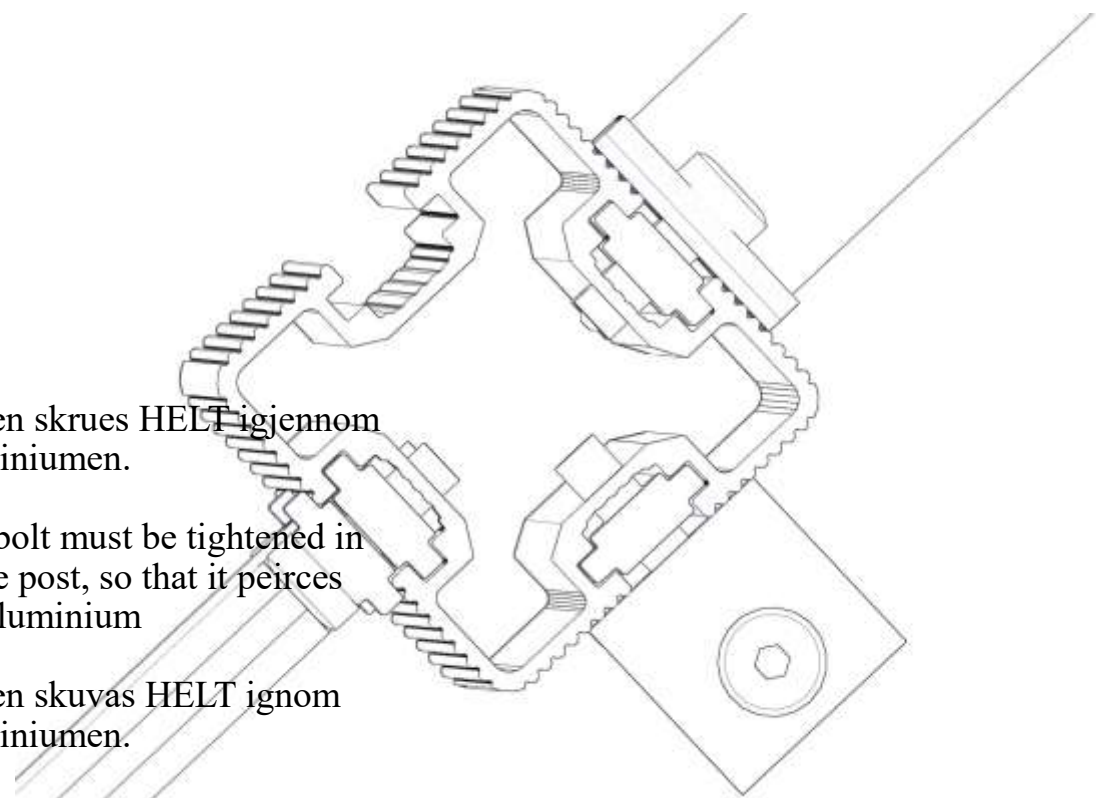
<p data-bbox="124 1556 220 1624">N</p> <p data-bbox="124 1691 220 1758">UK</p> <p data-bbox="124 1848 220 1915">S</p>	 <p data-bbox="239 1579 702 1668">Bolten skrues HELT igjennom aluminiumen.</p> <p data-bbox="239 1691 686 1825">The bolt must be tightened in to the post, so that it peirces the aluminium</p> <p data-bbox="239 1848 662 1937">Bulten skivas HELT ignom aluminiumen.</p>

Fallhøyder / Free height of fall / Fallhöjder

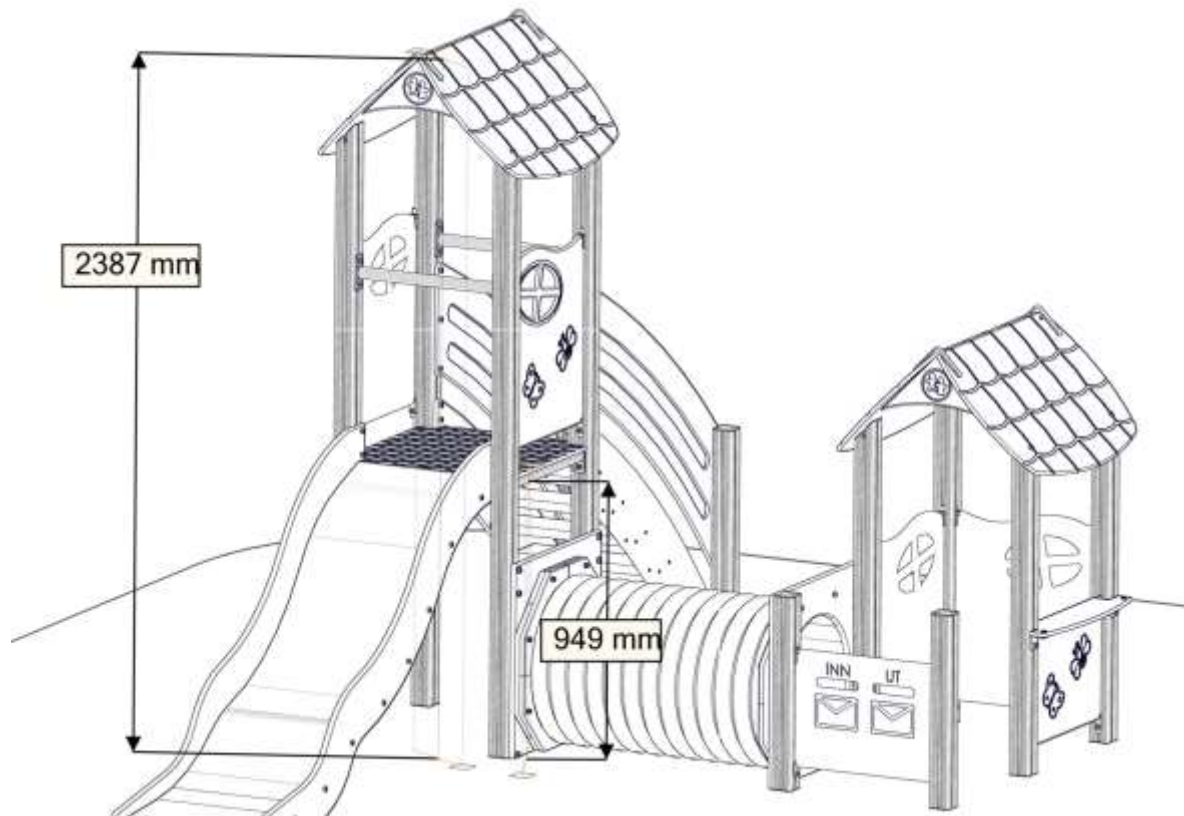

Sikkerhetszone / Safety zone / Säkerhetszon

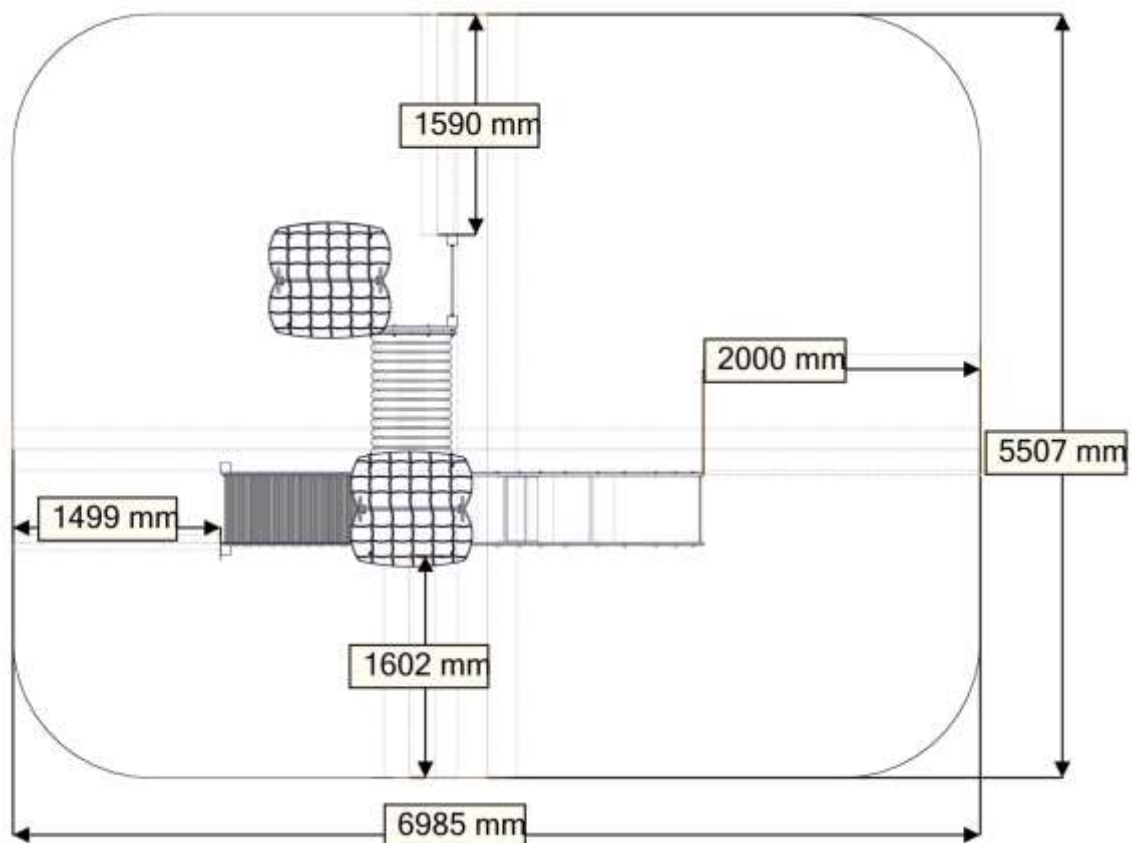

Plassering av forankringer / Ground plan / Placering av förankringar

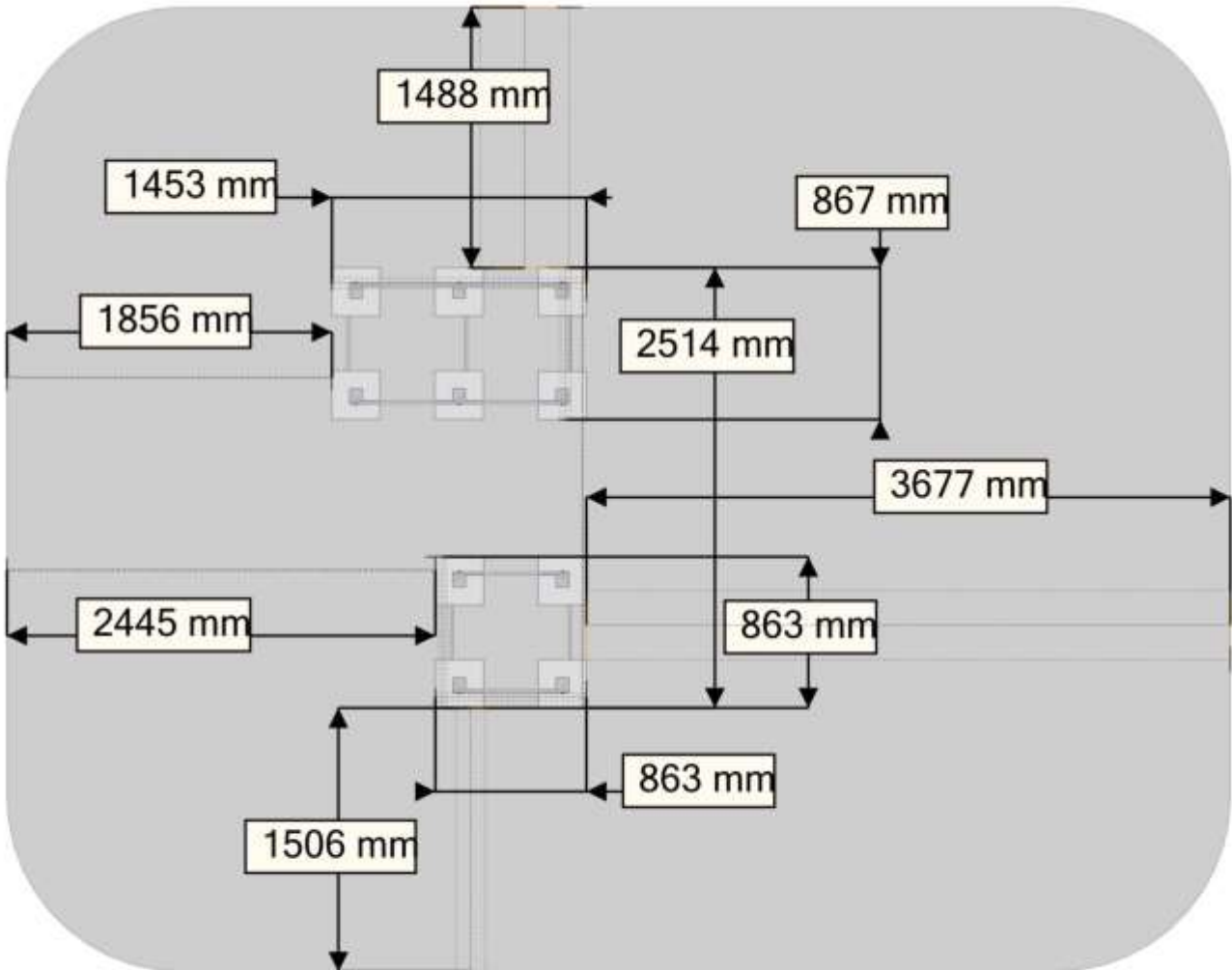

N

Alle mål er oppgitt i millimeter

UK

Scale measured in mm

S

Alla mått är i millimeter.

Montering av lekeapparatet / Assembly instructions / Montering av lekredskapet

Brikke montert hos Søve

04-060-090

1549 mm

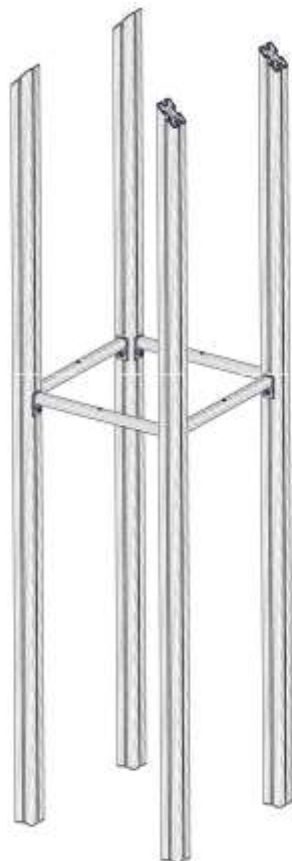
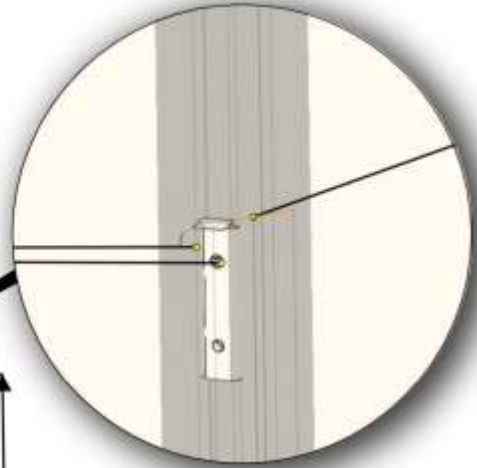

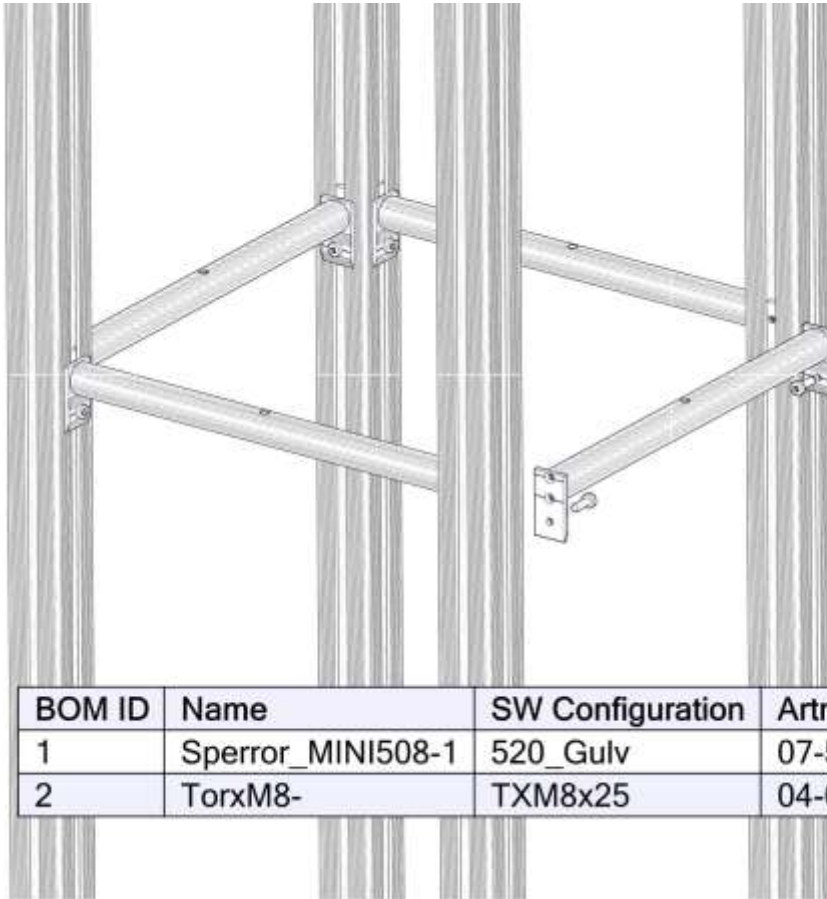

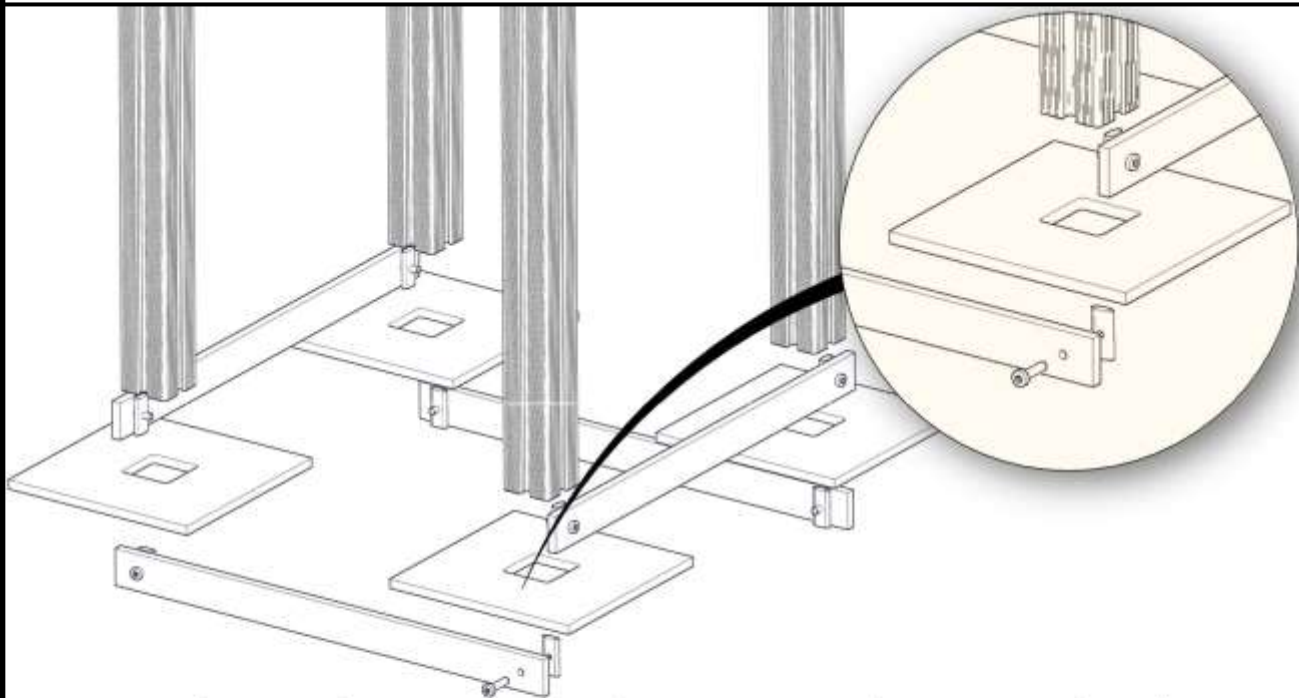

BOM ID	Name	SW Configuration	Artnr (config)	Qty
1	brikke_SFA5116-	50_1T	04-060-050	8
2	minifun_sprosse-1	660	07-510-200	4
3	minifunSkive-	Default	07-510-201	4
4	TorxM8-	TXM8x35	04-000-035	8

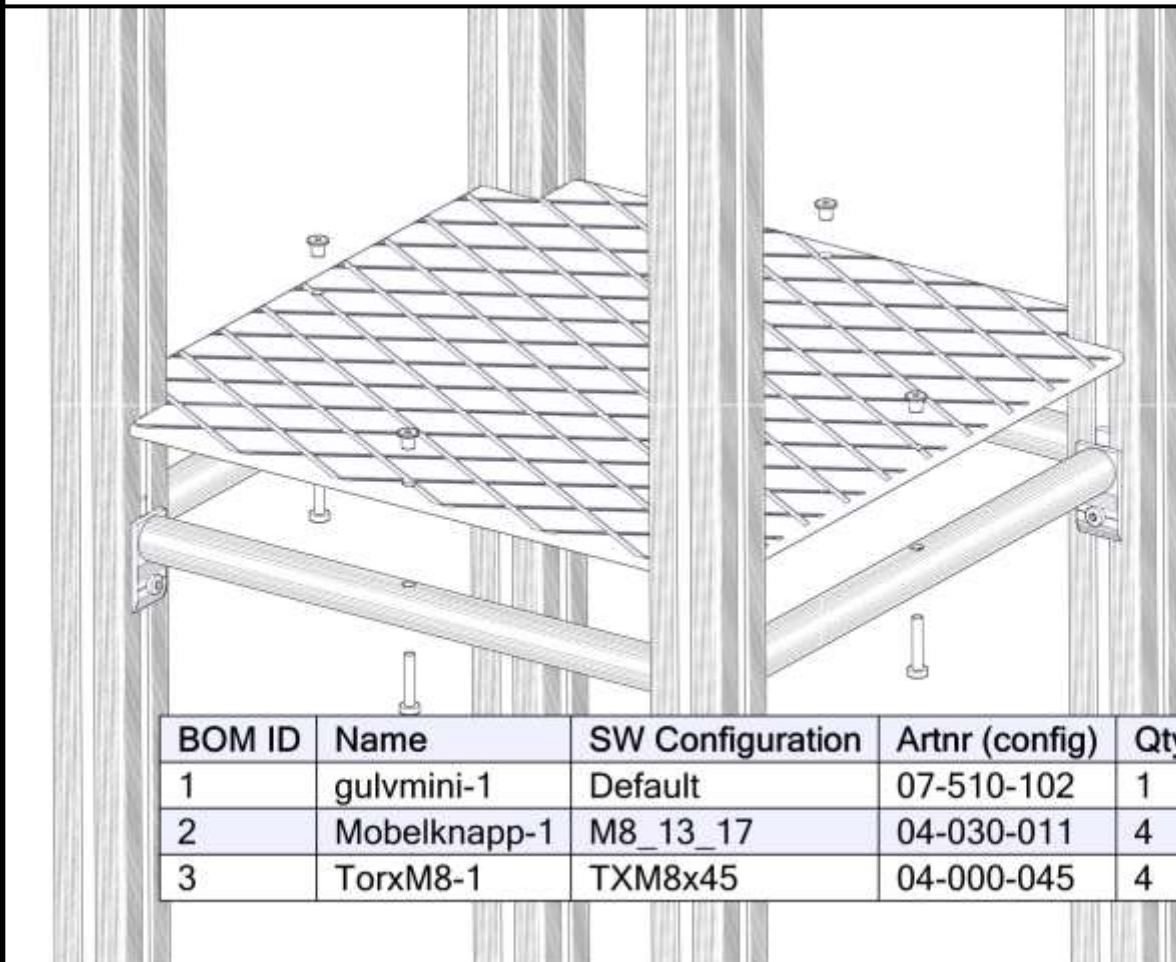

BOM ID	Name	SW Configuration	Artnr (config)	Qty
1	gulvmini-1	Default	07-510-102	1
2	Mobelknapp-1	M8_13_17	04-030-011	4
3	TorxM8-1	TXM8x45	04-000-045	4

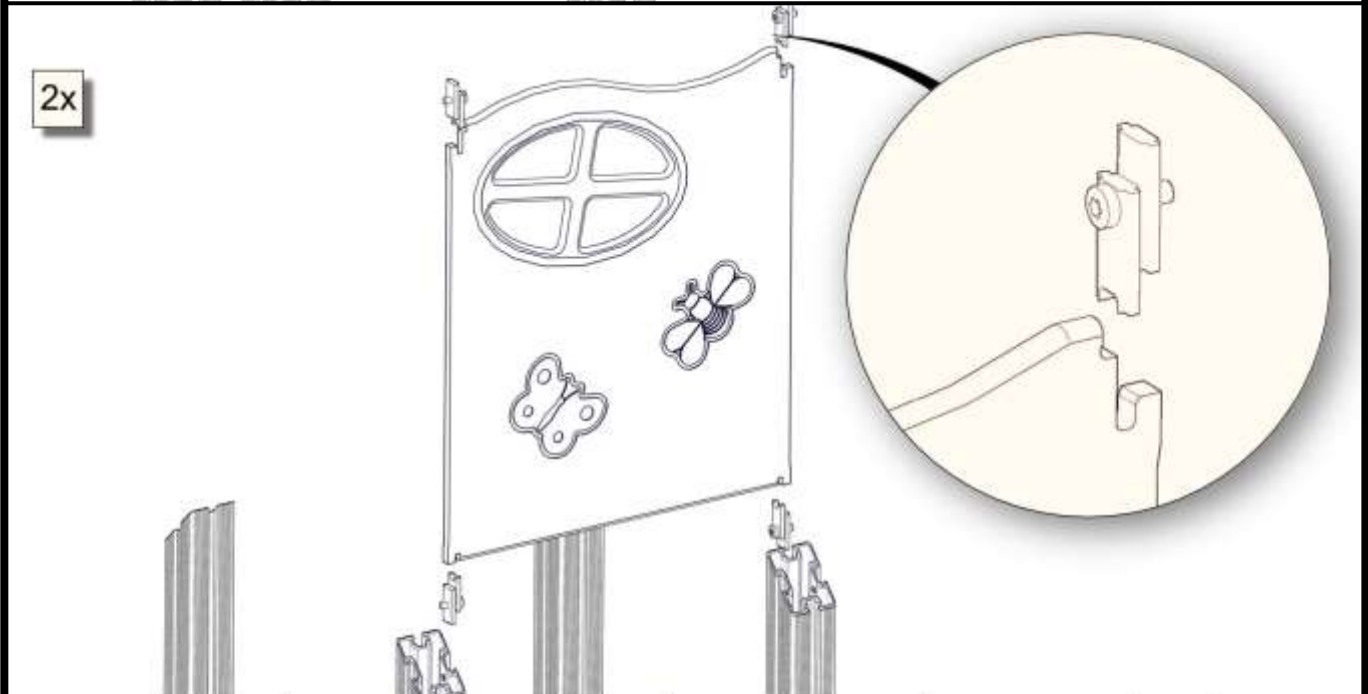
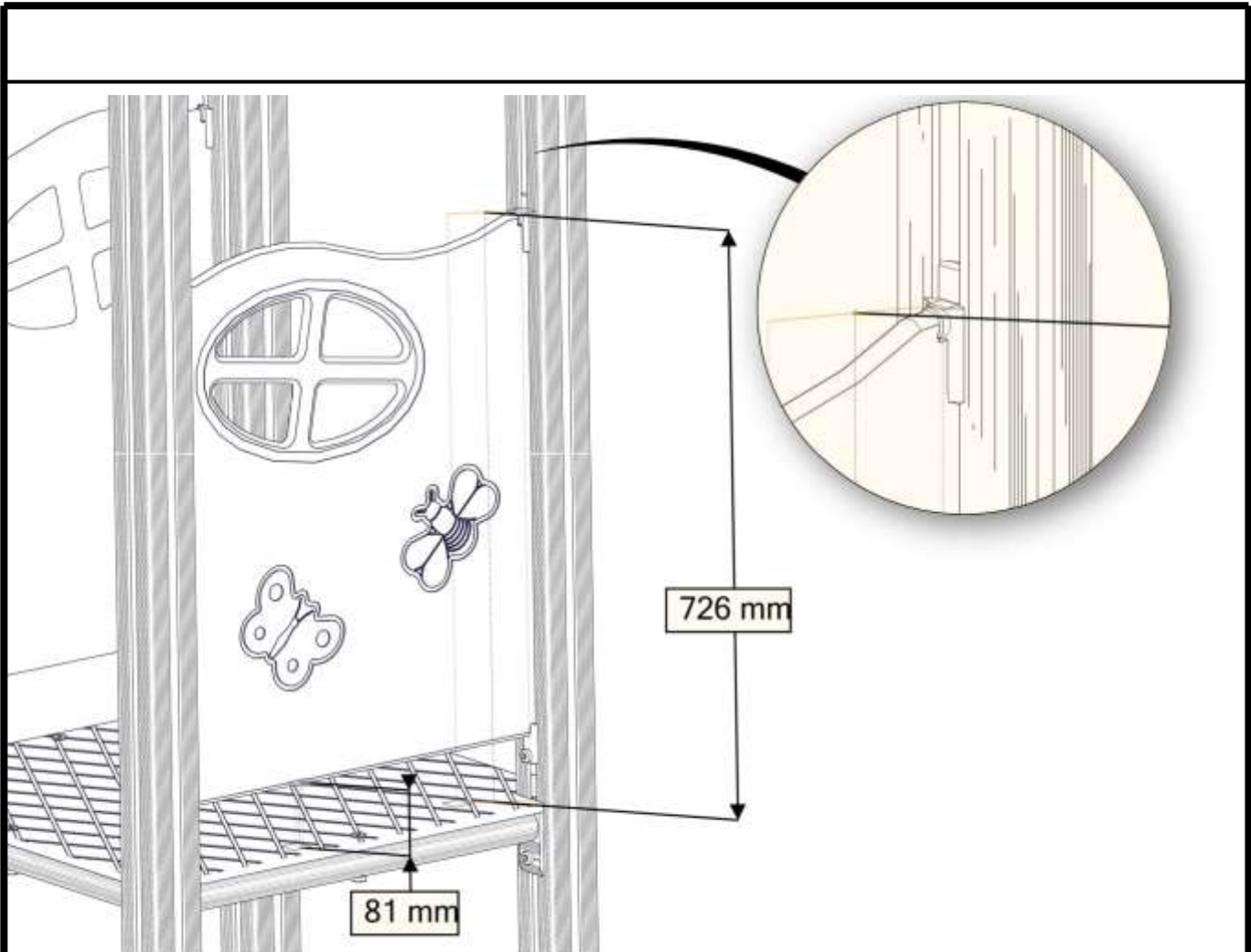

BOM ID	Name	SW Configuration	Artnr (config)	Qty
1	brikke_SFA5116-1	50_1T	04-060-050	4
2	brikke_SFA5116Special-1	12mm	04-060-041	4
3	TorxM8-1	TXM8x25	04-000-025	4
4	VeggMini520x600-1	RvindoBi2	07-510-120	1

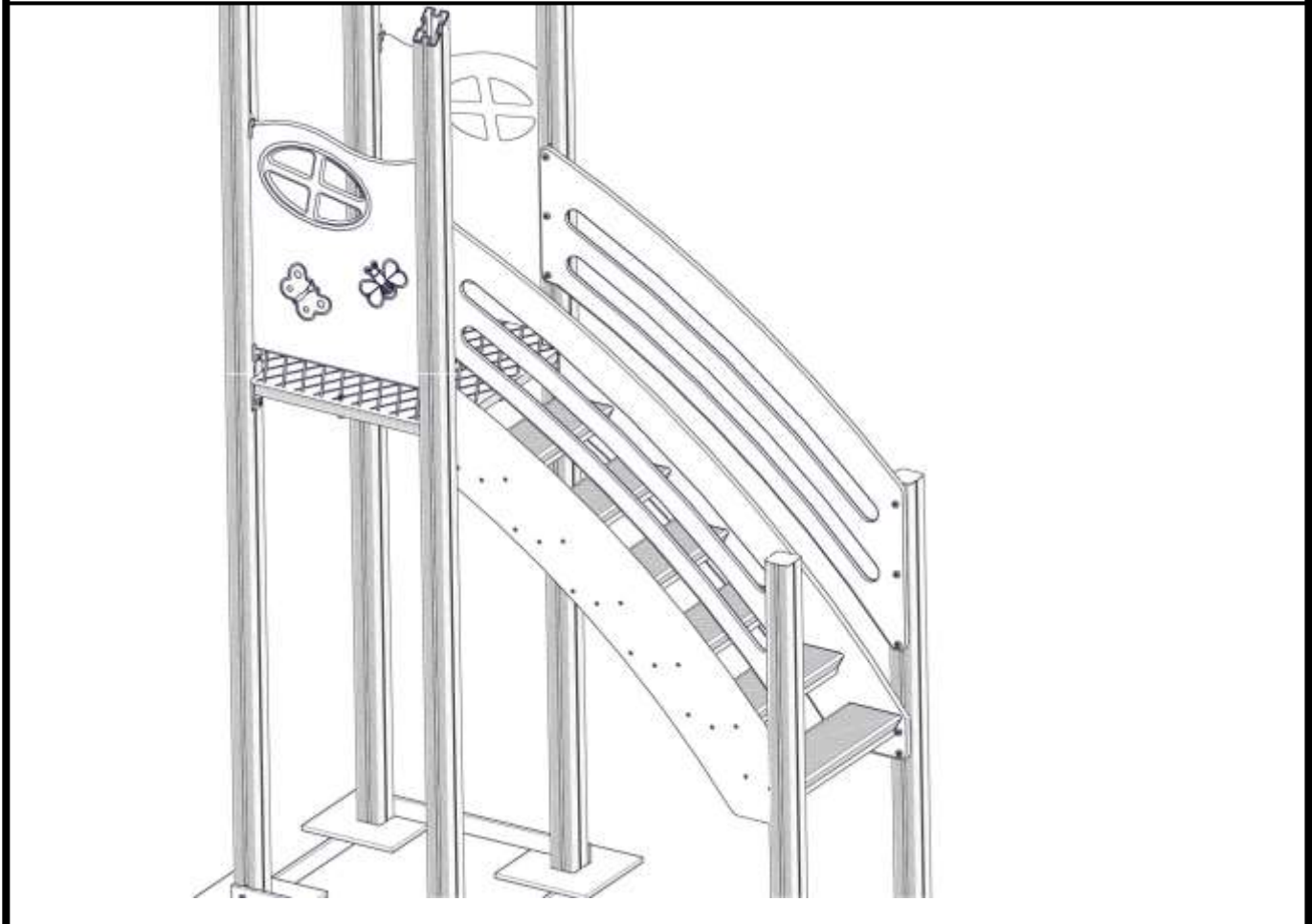
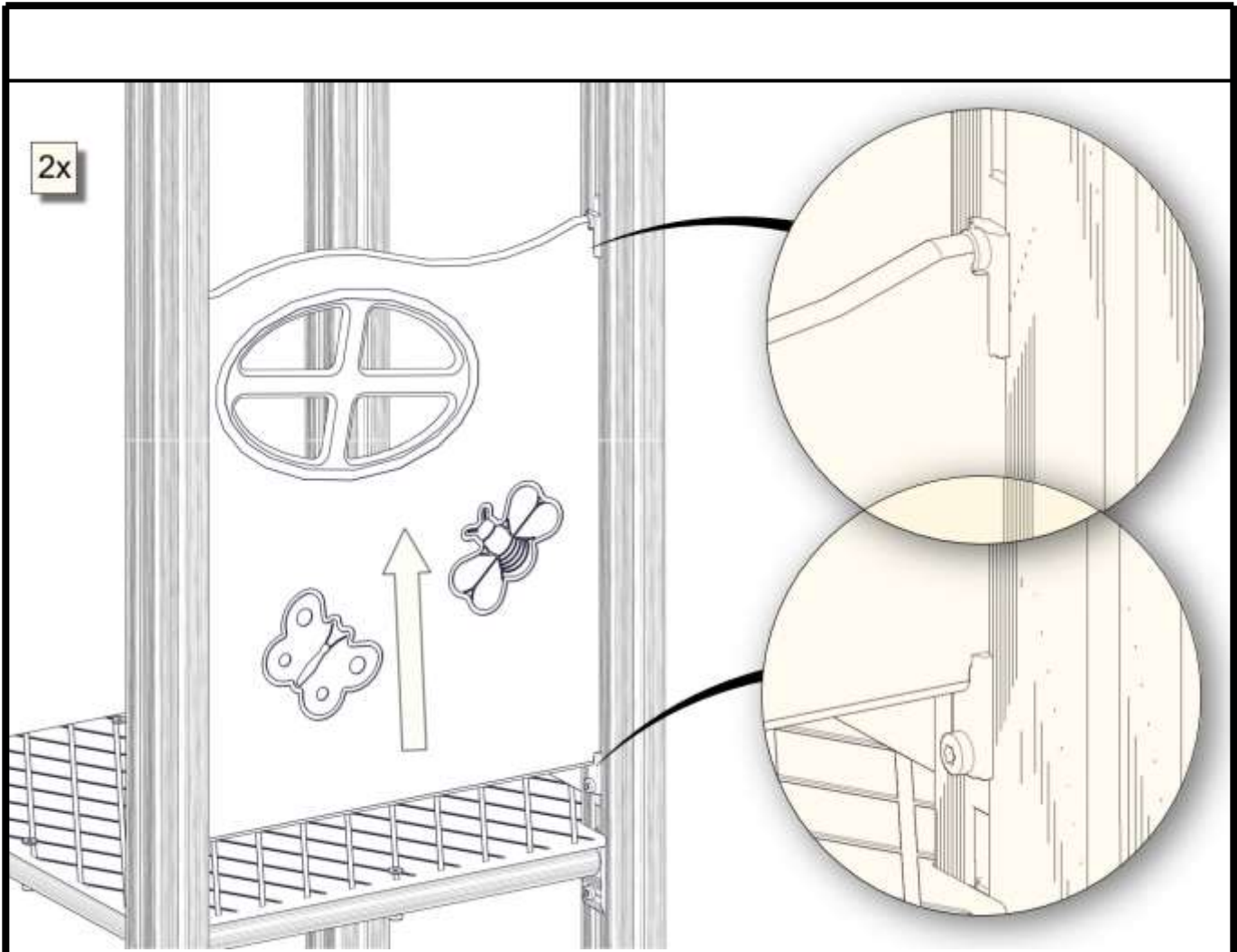

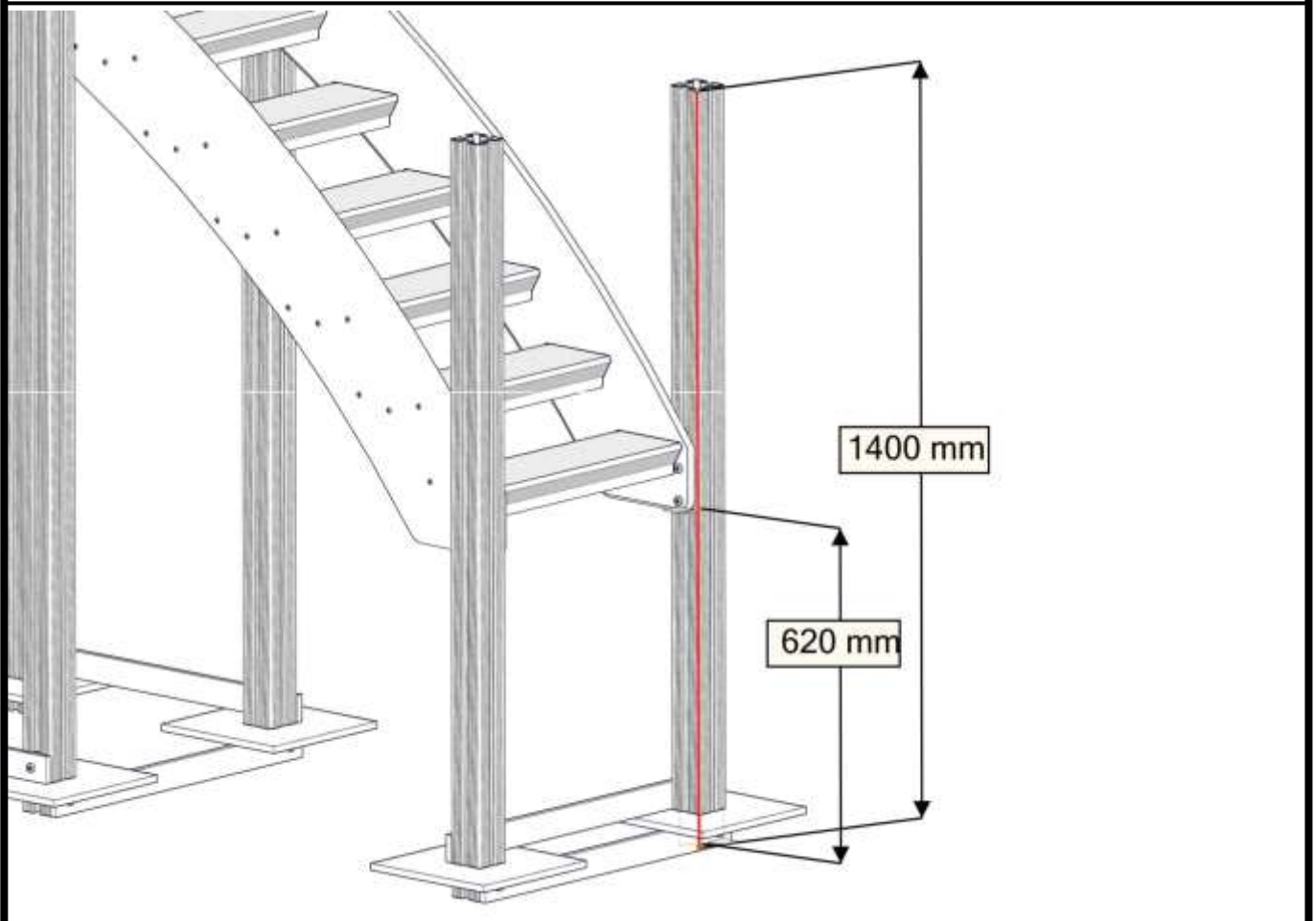
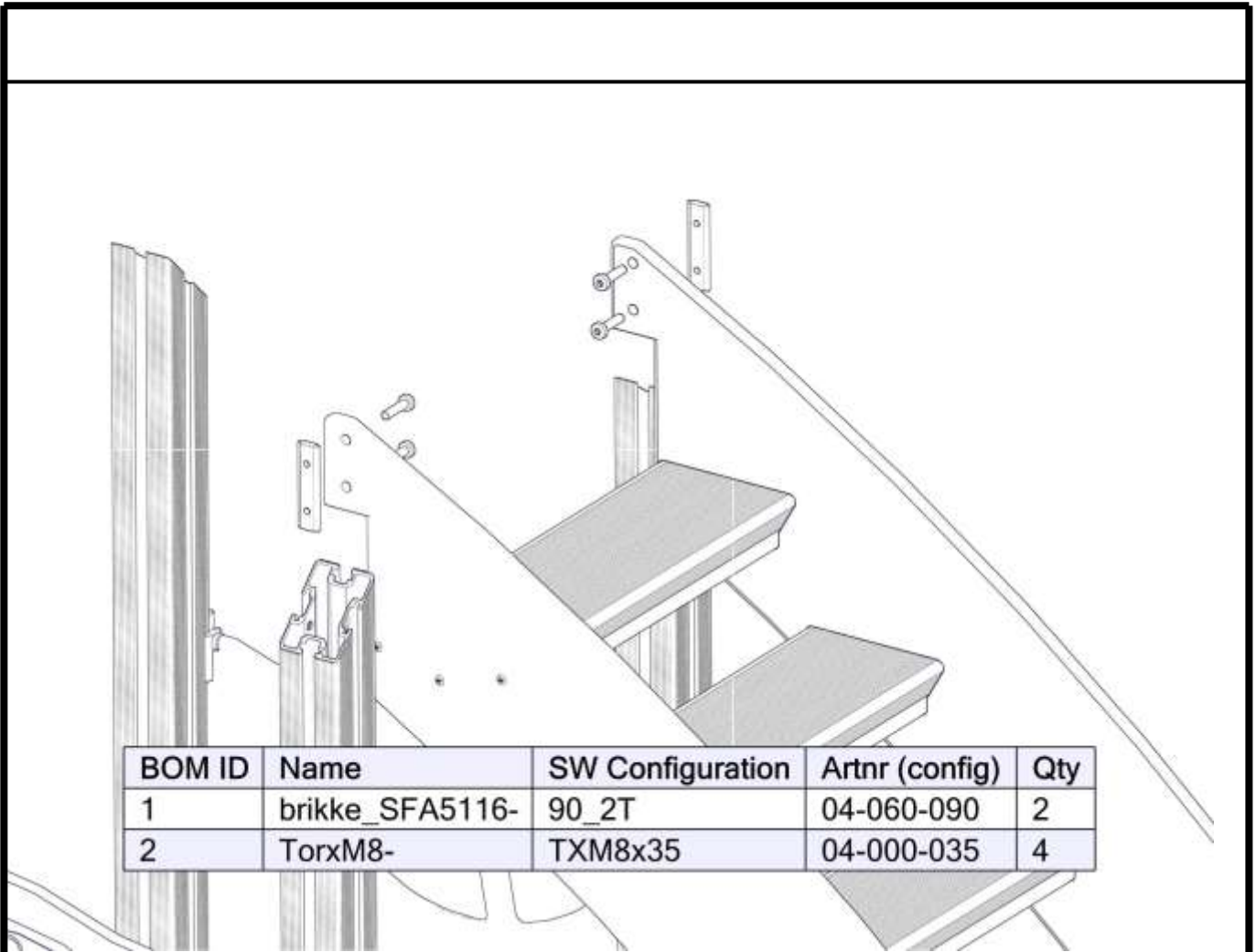

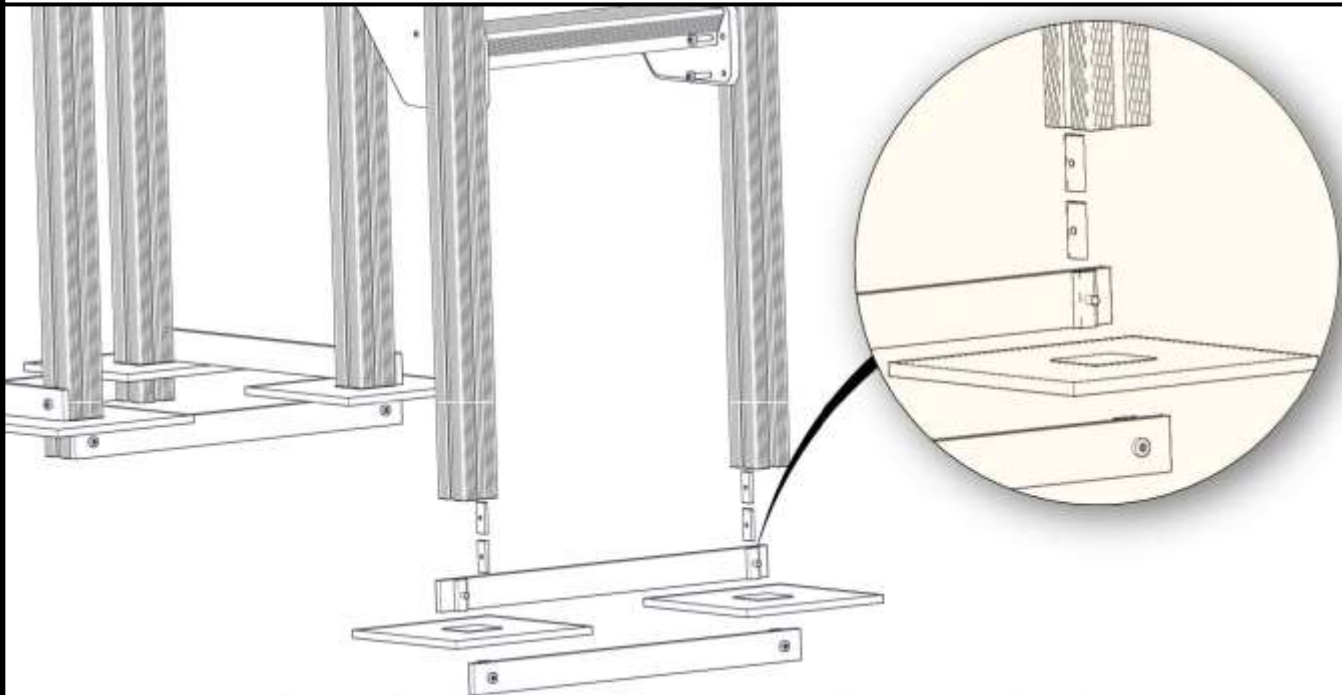

BOM ID	Name	SW Configuration	Artnr (config)	Qty
1	TorxM8-	TXM8x35	04-000-035	8
2	brikke_SFA5116-	50_1T	04-060-050	8
3	minifun_sprosse-1	660	07-510-200	2
4	minifunSkive-	Default	07-510-201	2
5	VK70_SFA5123-1	600-800	07-510-455	2

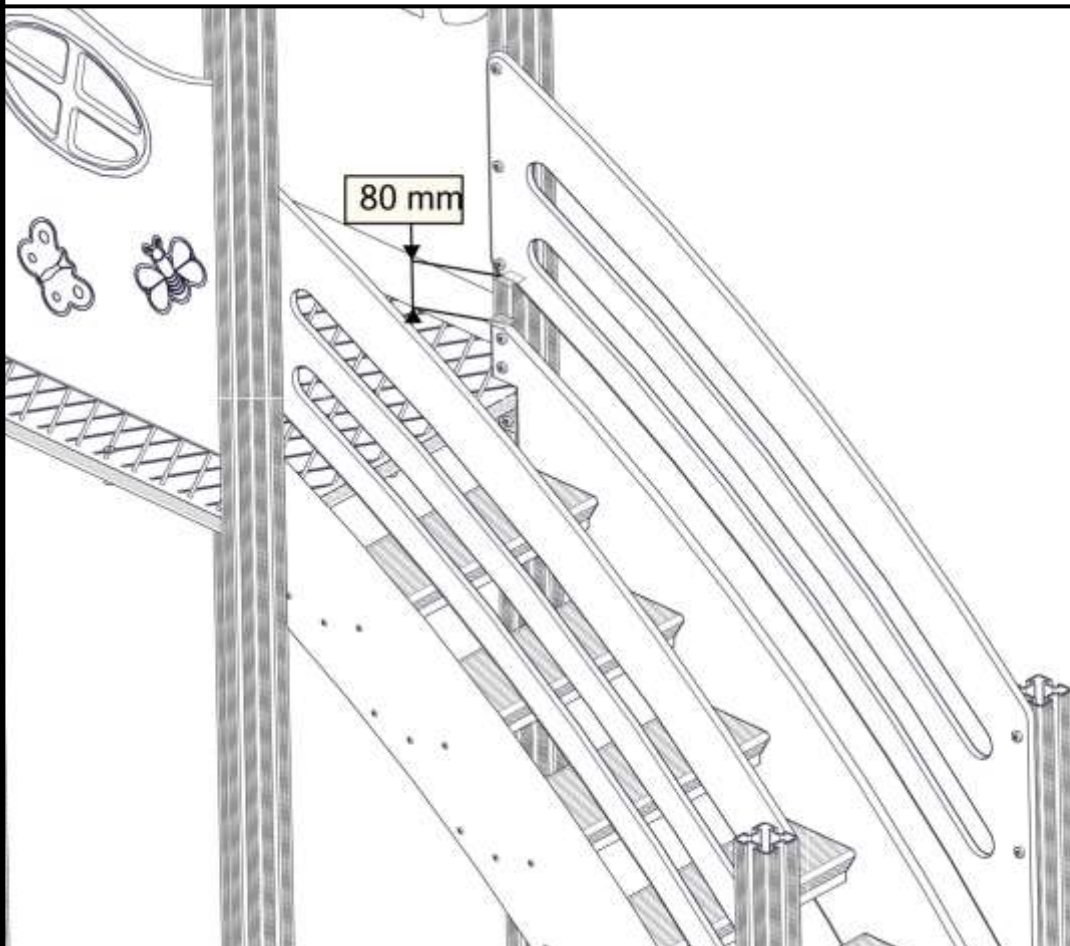

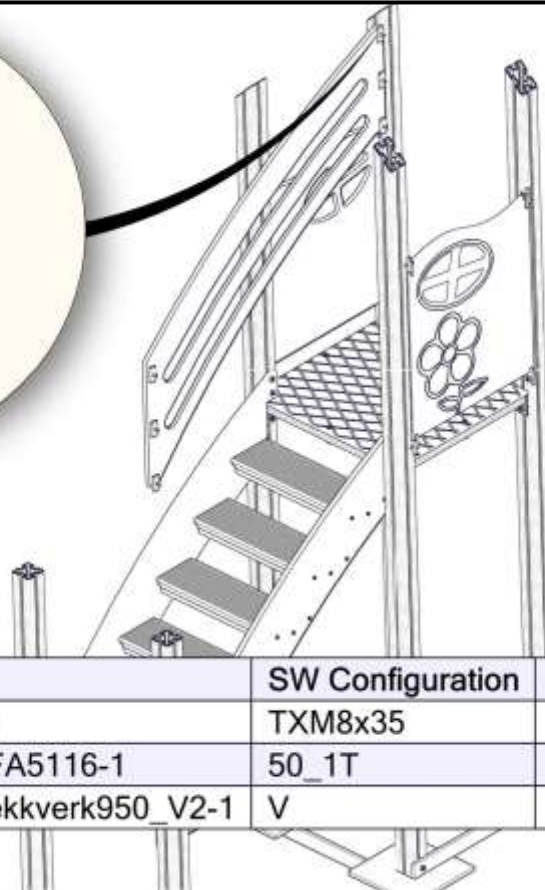
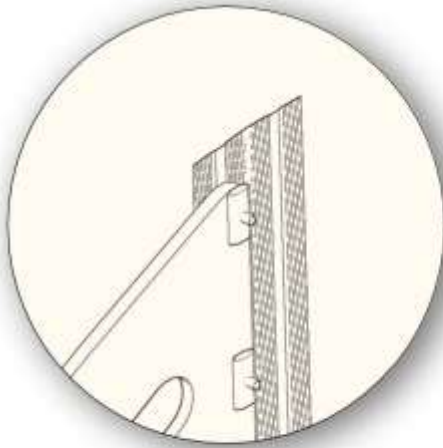

BOM ID	Name	SW Configuration	Artnr (config)	Qty
1	TorxM8-1	TXM8x35	04-000-035	6
2	brikke_SFA5116-1	50_1T	04-060-050	6
3	TreppeRekkverk950_V2-1	V	07-510-454	1

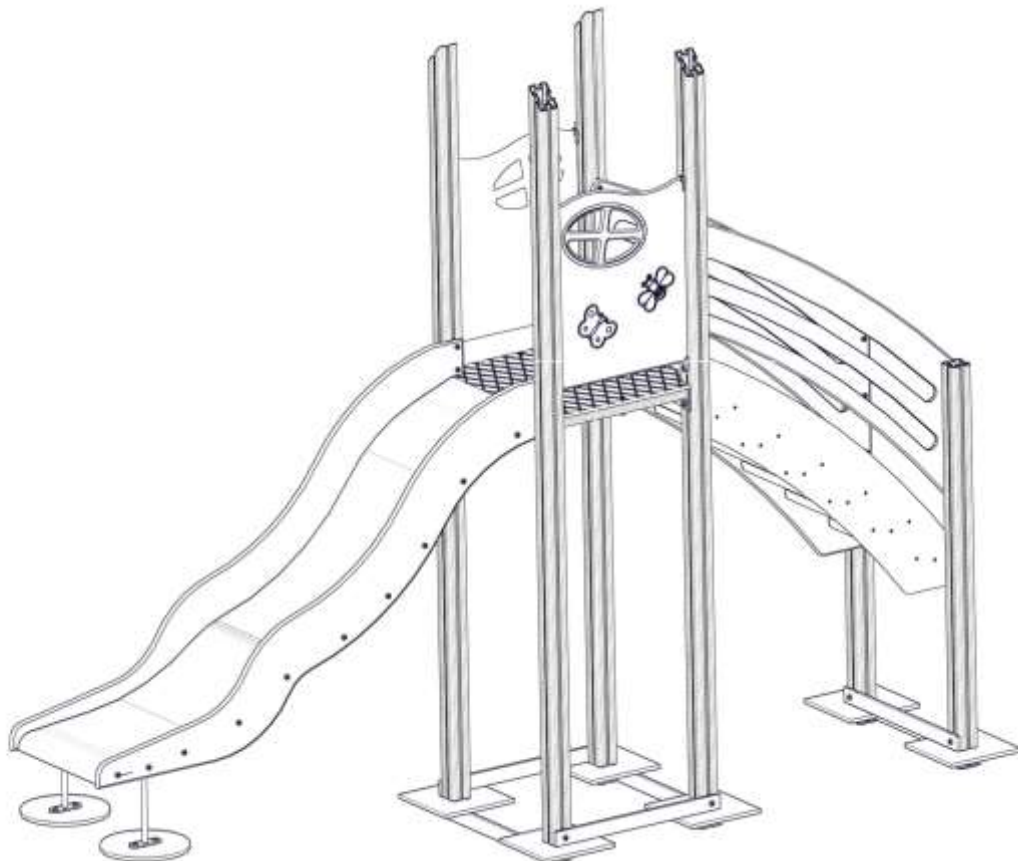

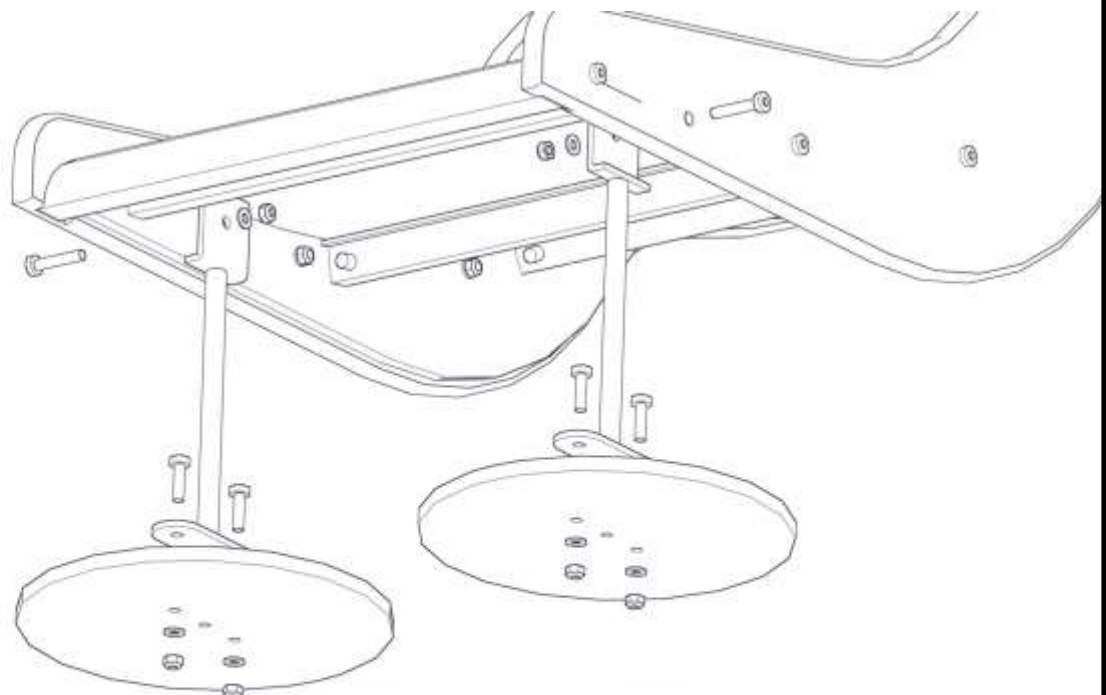
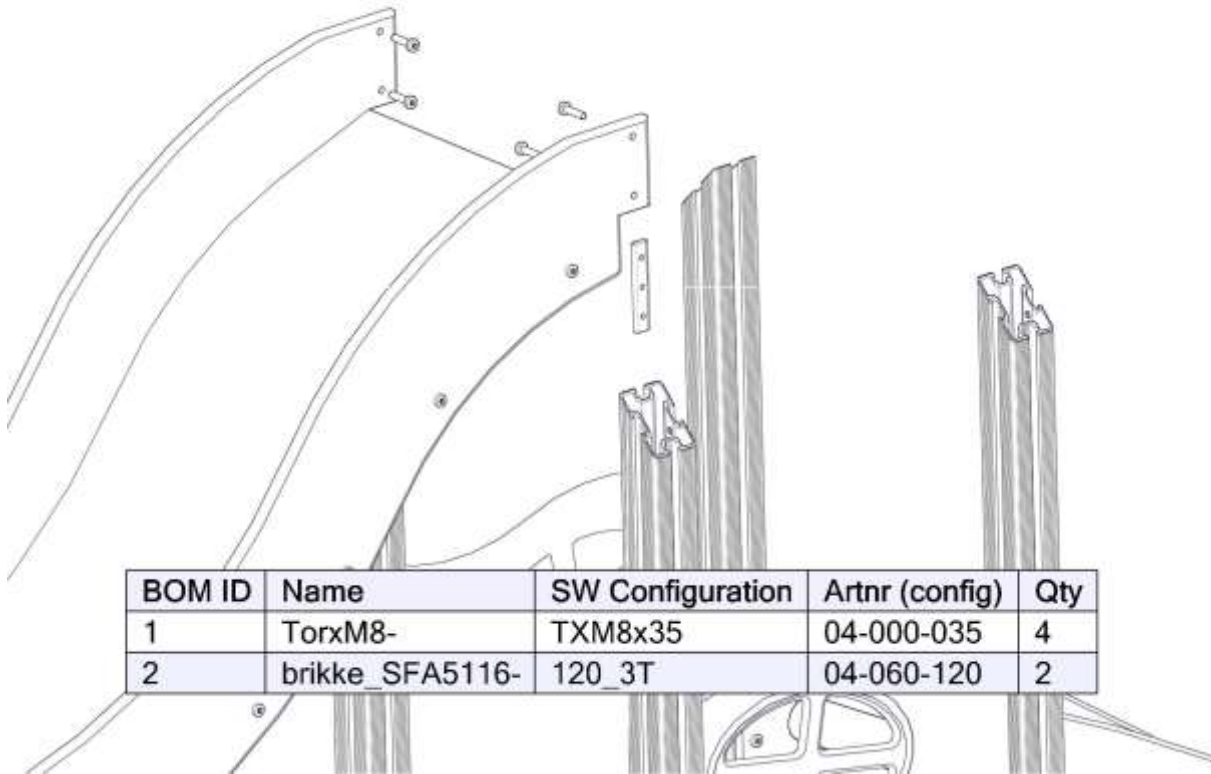

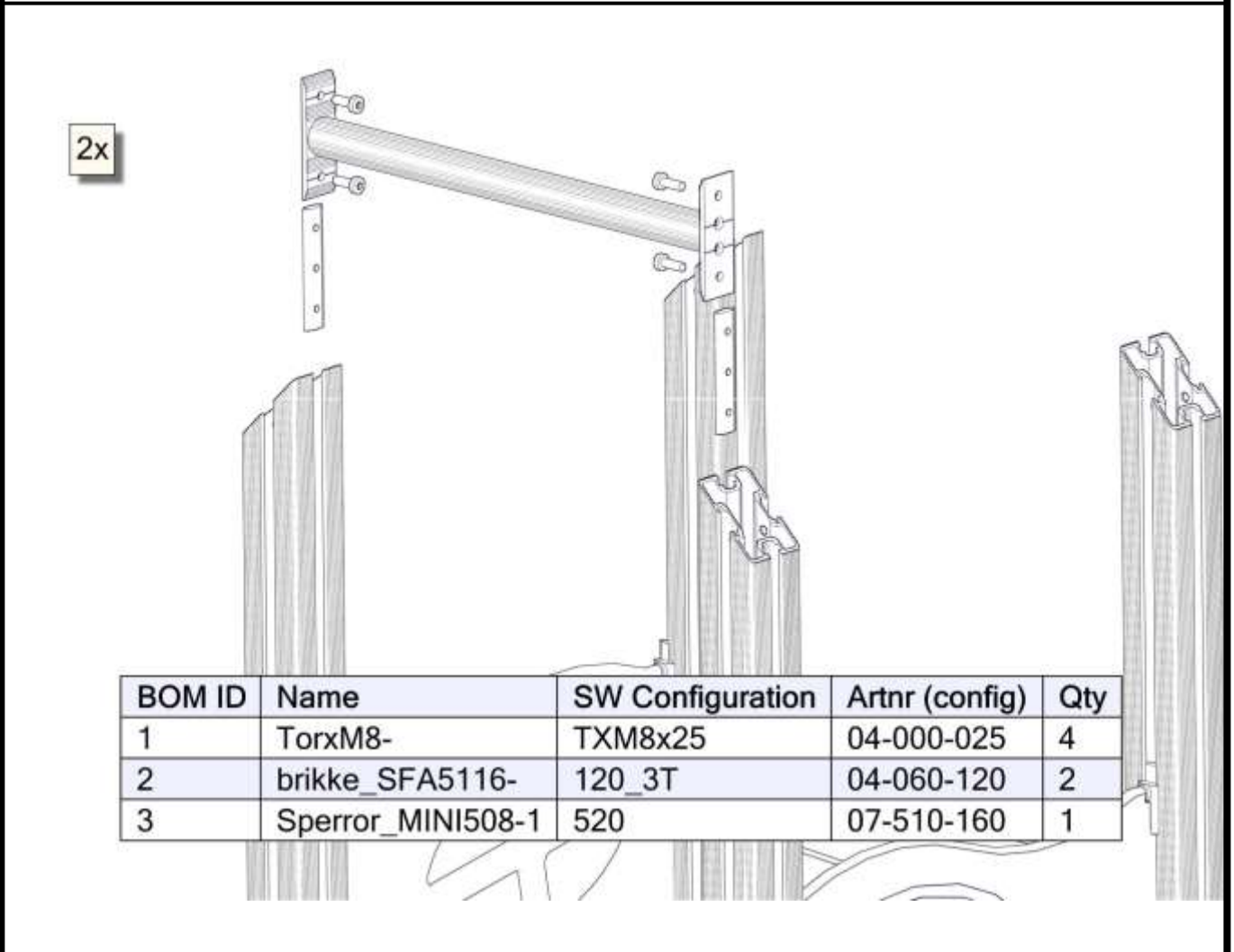
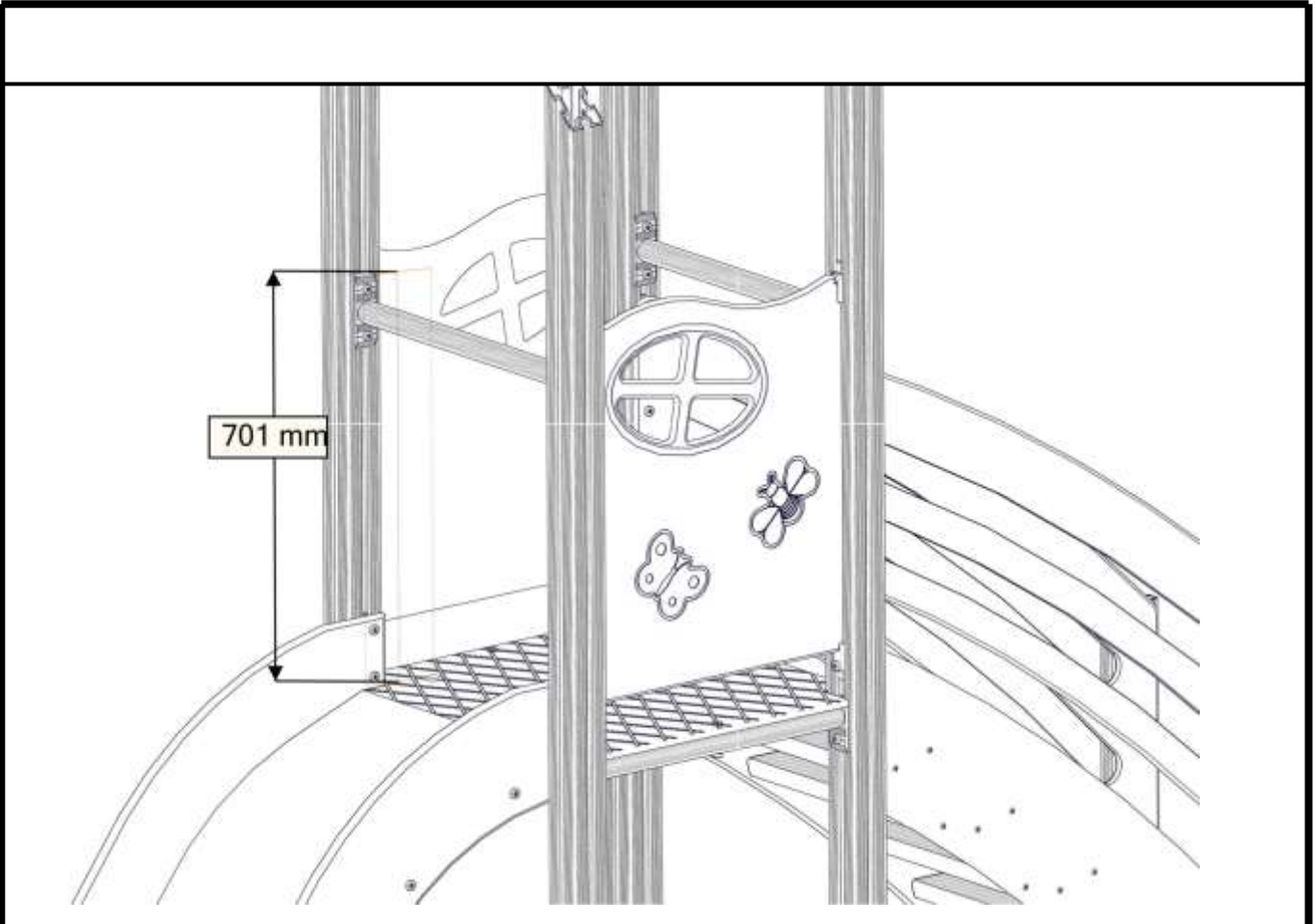

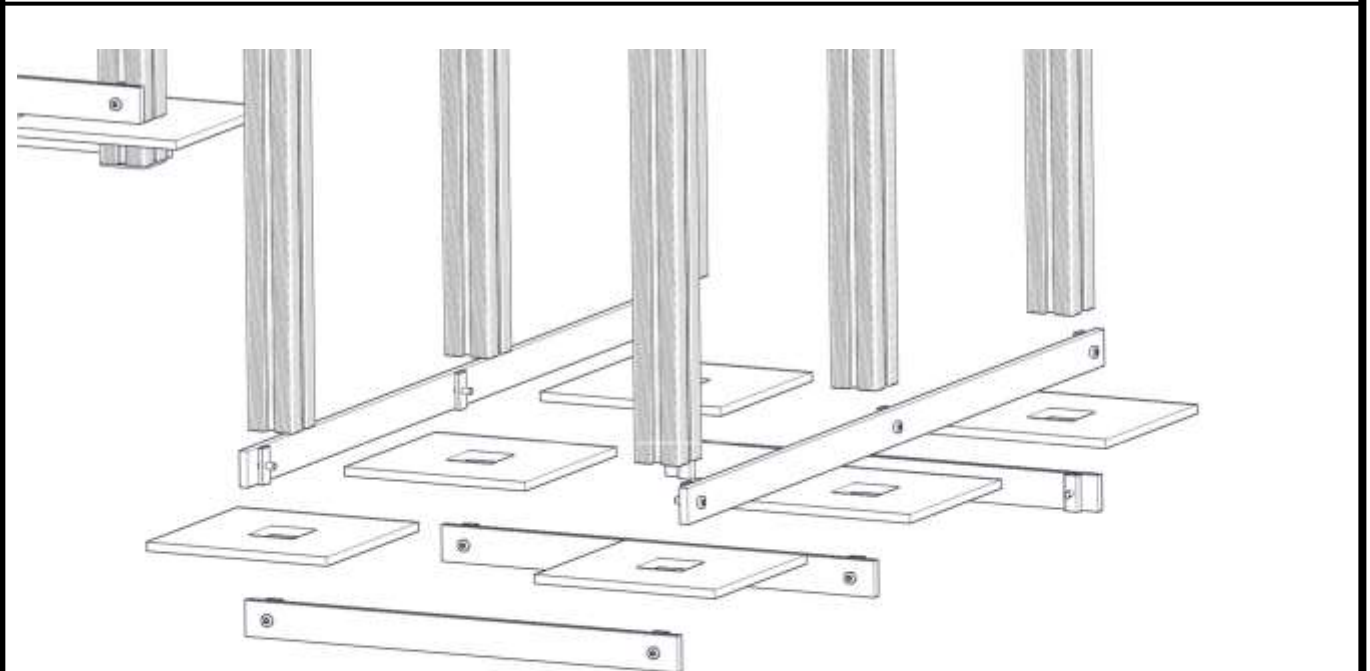
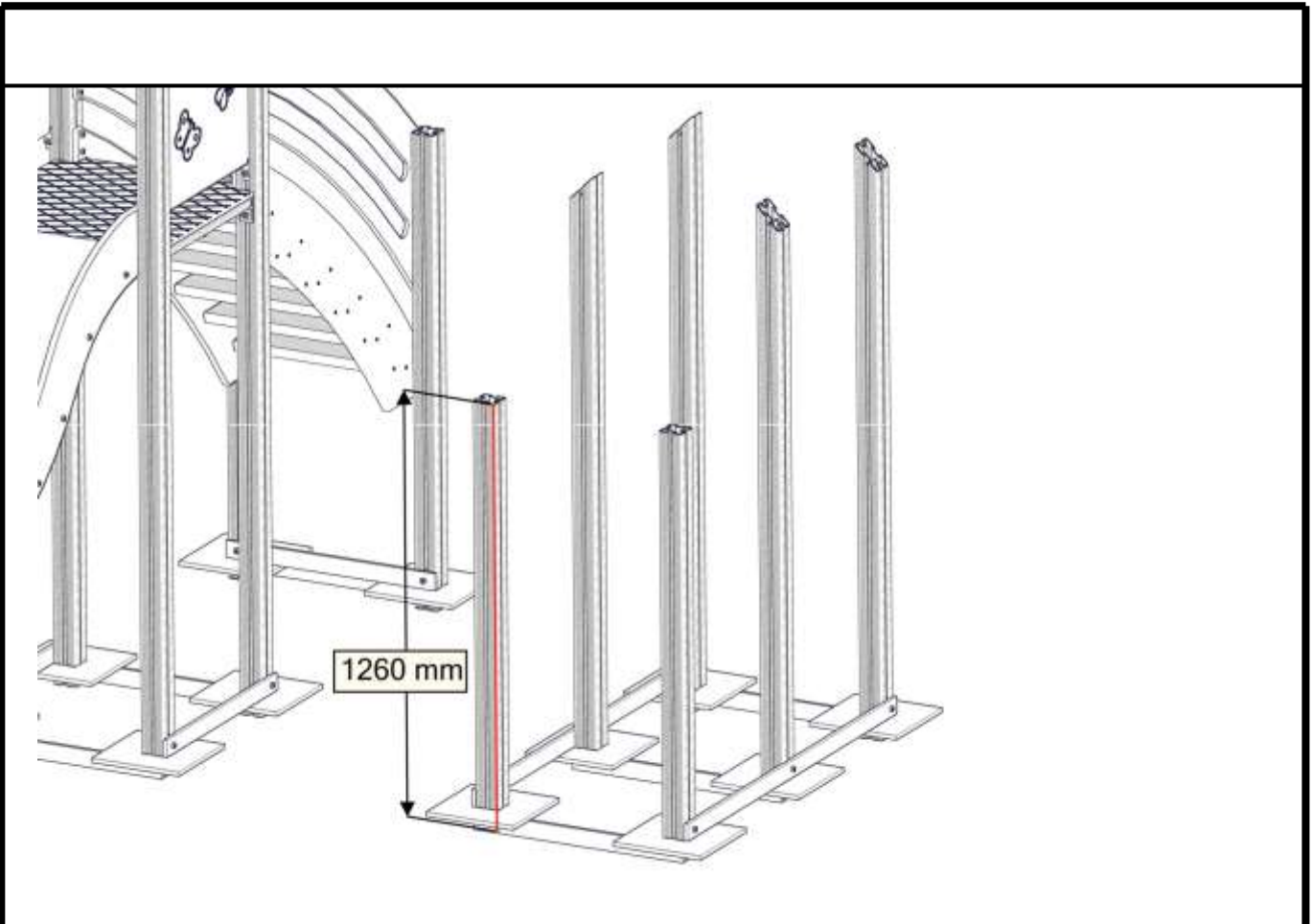

BOM ID	Name	SW Configuration	Artnr (config)	Qty
1	TorxM8-	TXM8x35	04-000-035	12
2	brikke_SFA5116-	50_1T	04-060-050	12
3	minifun_sprosse-1	660	07-510-200	3
4	minifunSkive-	Default	07-510-201	6
5	minifun_sprosse-1	1250	07-510-202	2

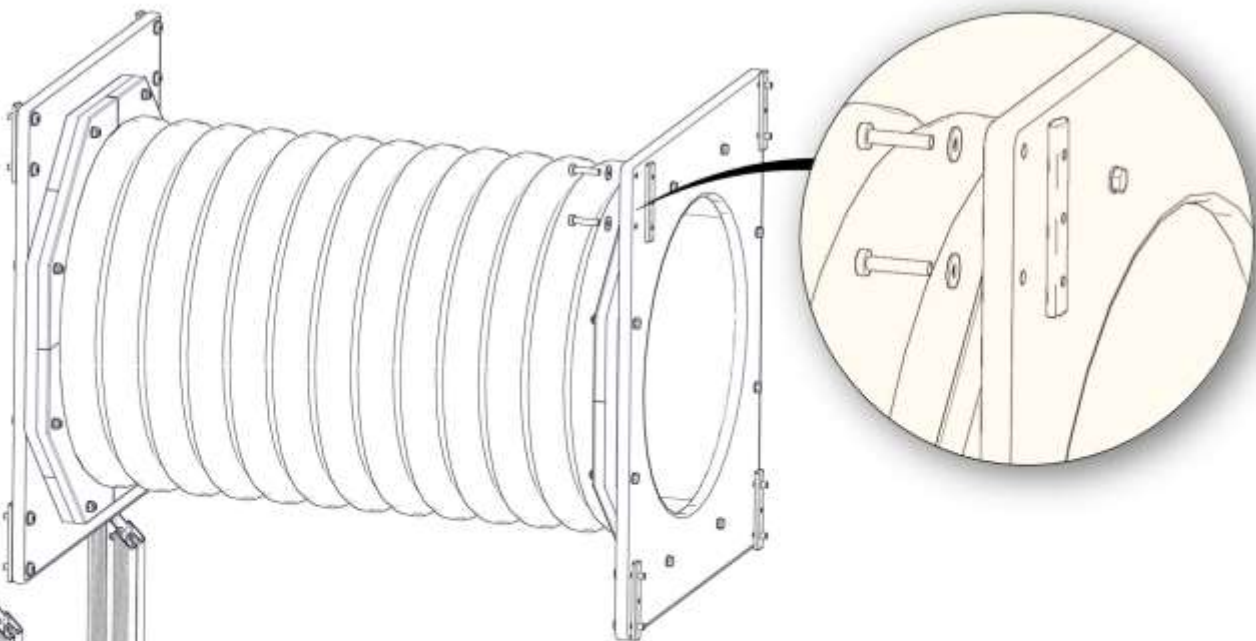
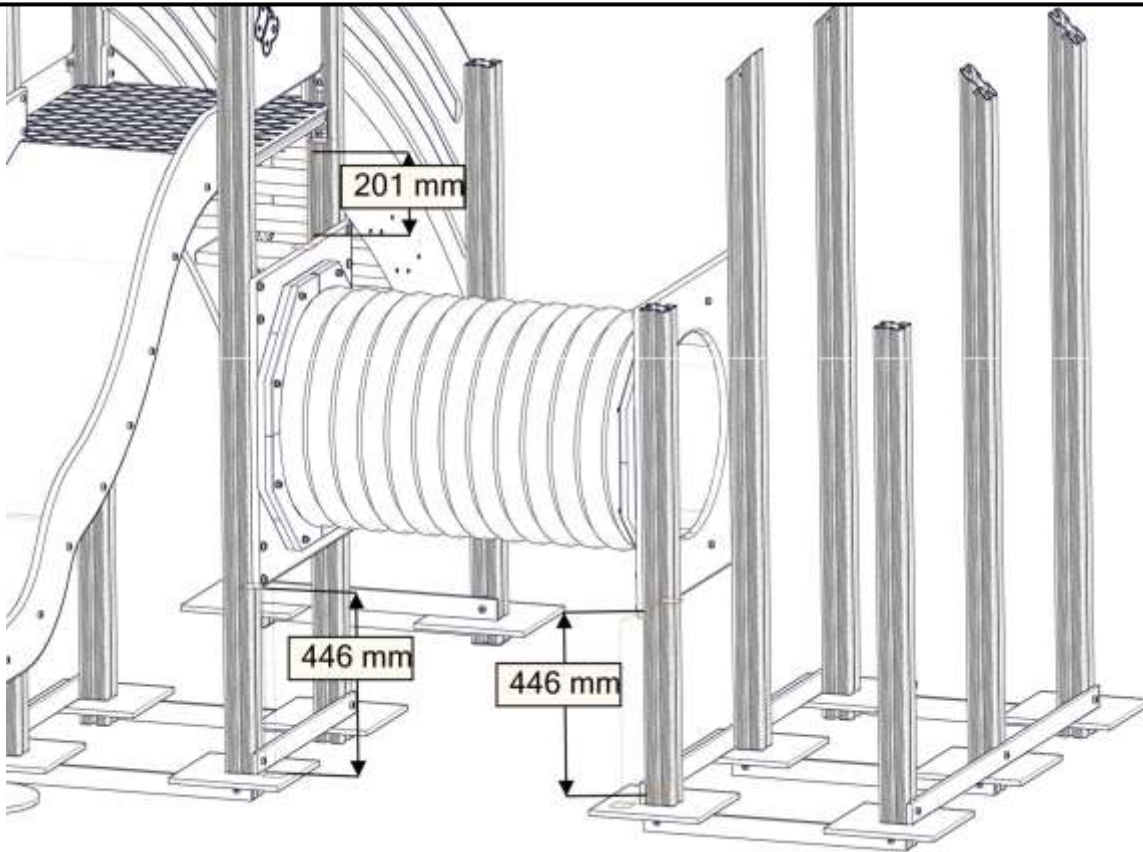

BOM ID	Name	SW Configuration	Artnr (config)	Qty
1	Torxm8-	TXM8x40	04-000-040	16
2	Skive-	M8_stor	04-055-008	16
3	brikke_SFA5116-1	120_3T	04-060-120	8

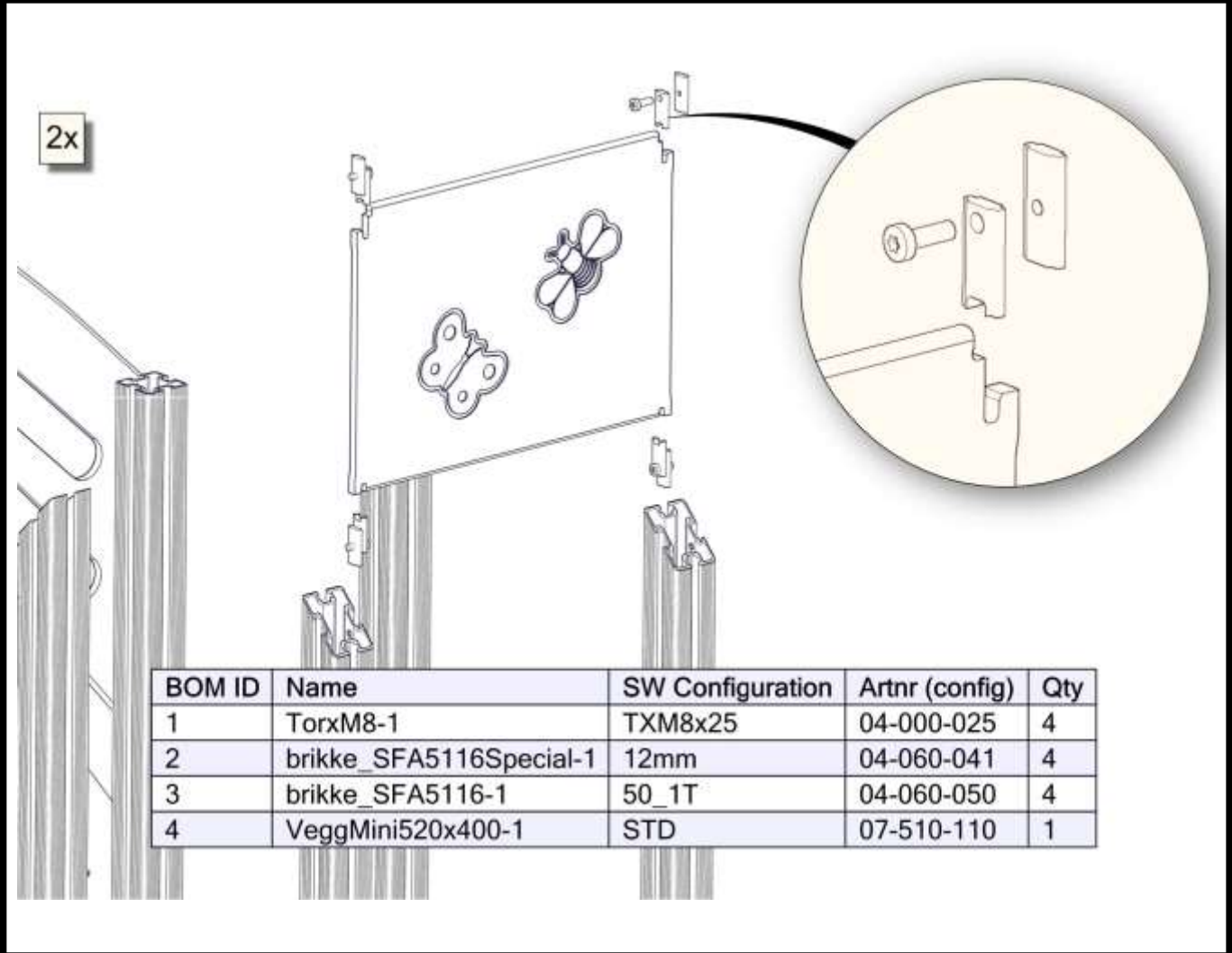
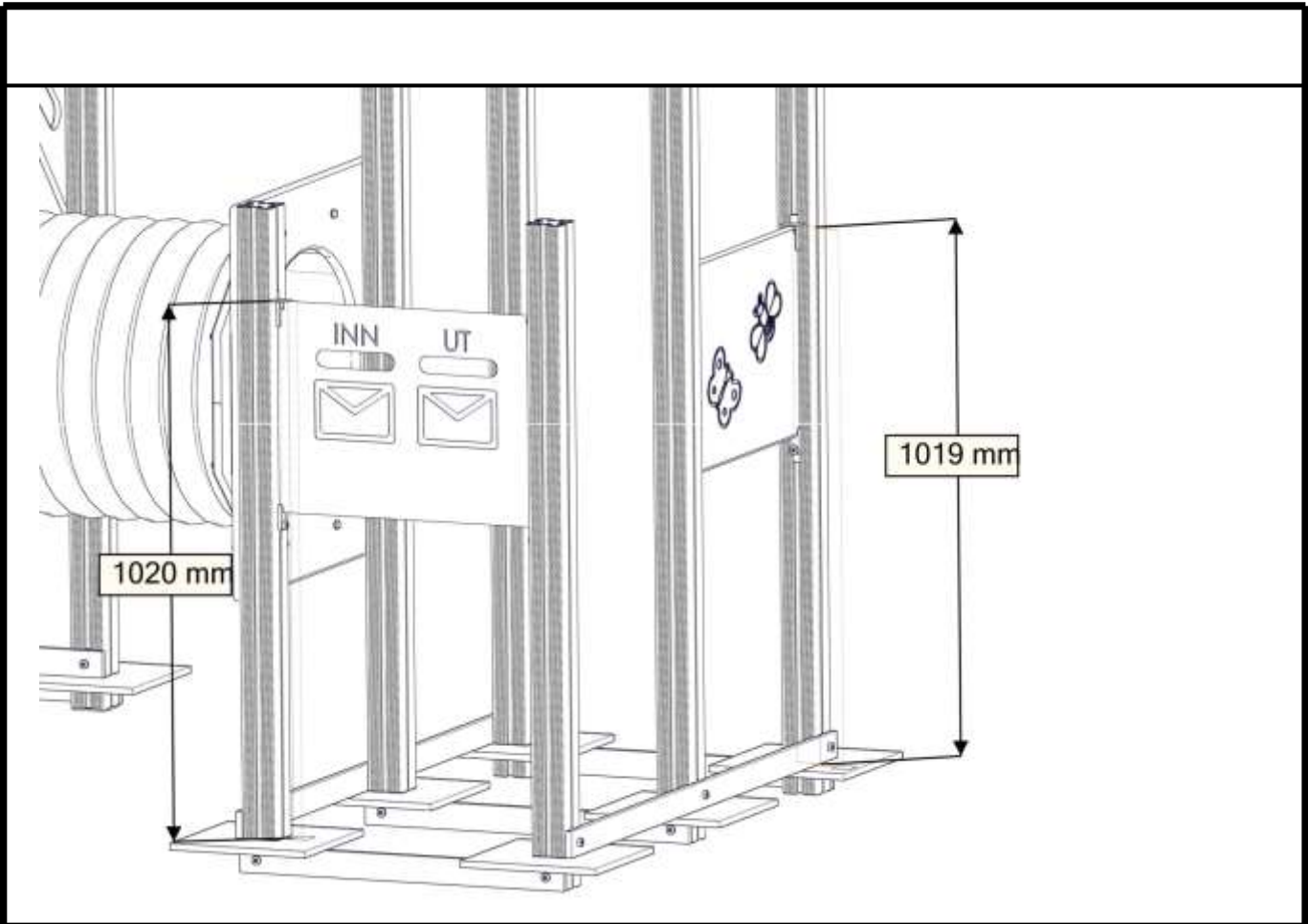

BOM ID	Name	SW Configuration	Artnr (config)	Qty
1	TorxM8-1	TXM8x25	04-000-025	4
2	brikke_SFA5116Special-1	12mm	04-060-041	4
3	brikke_SFA5116-1	50_1T	04-060-050	4
4	VeggMini520x400-1	STD	07-510-110	1

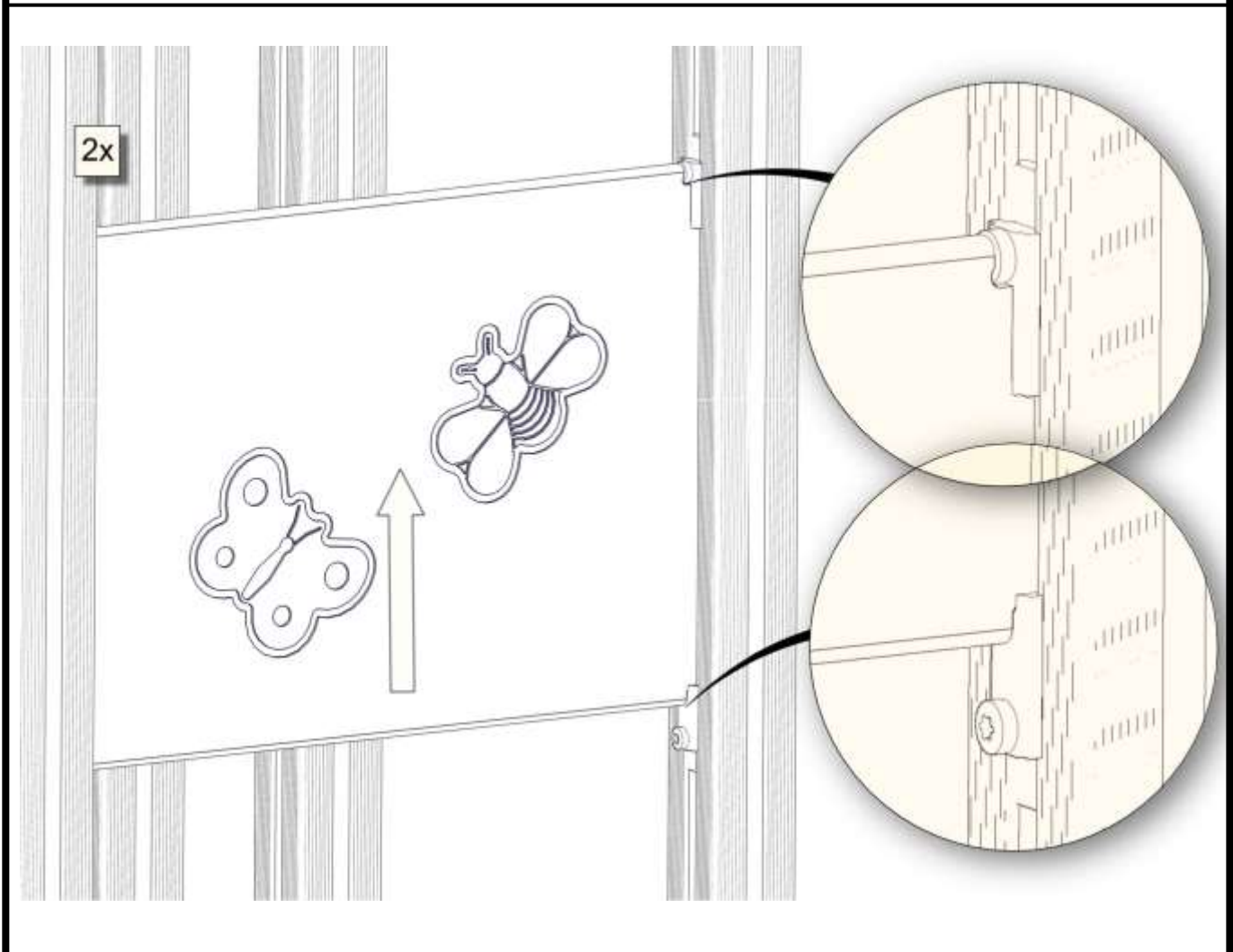
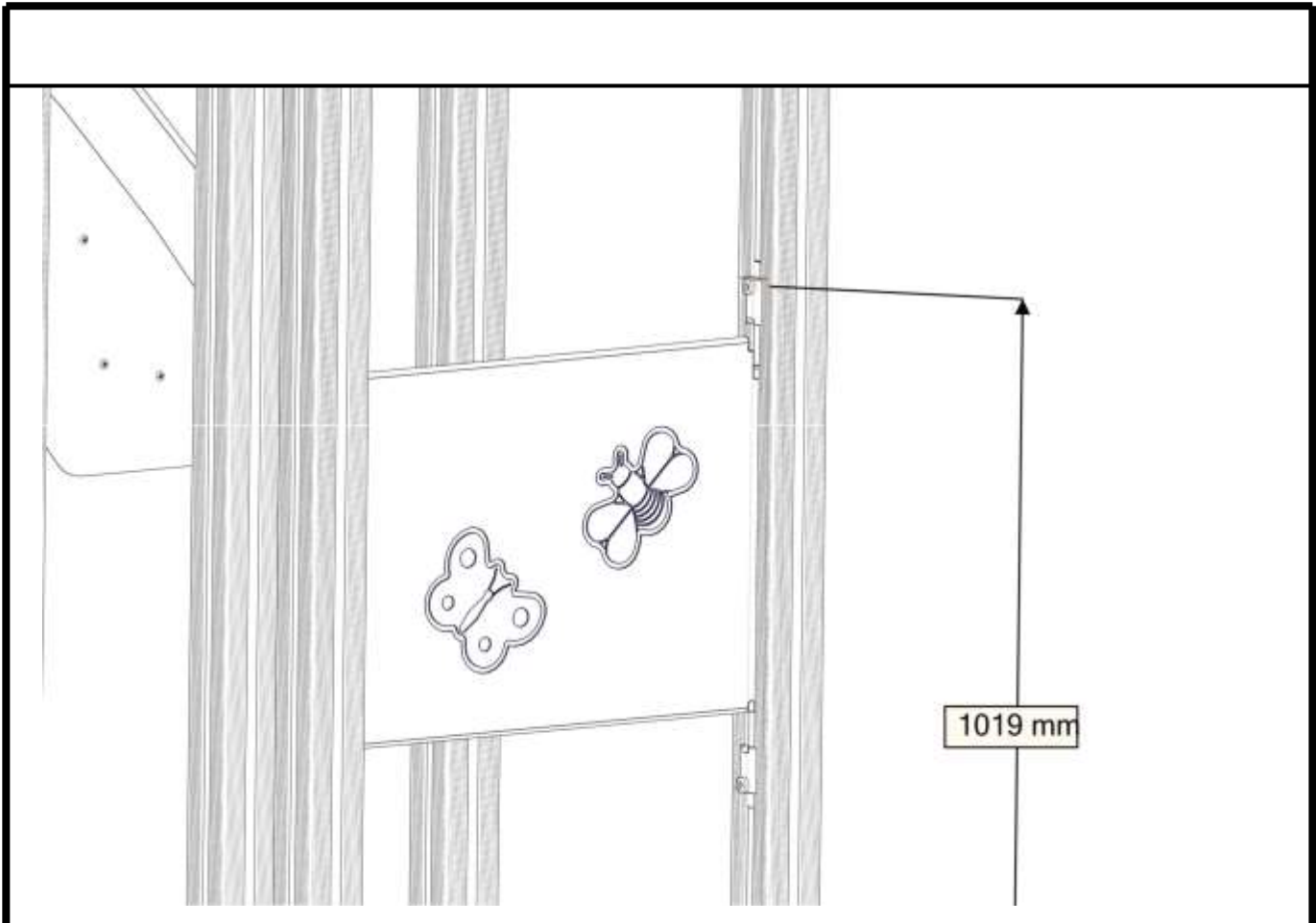

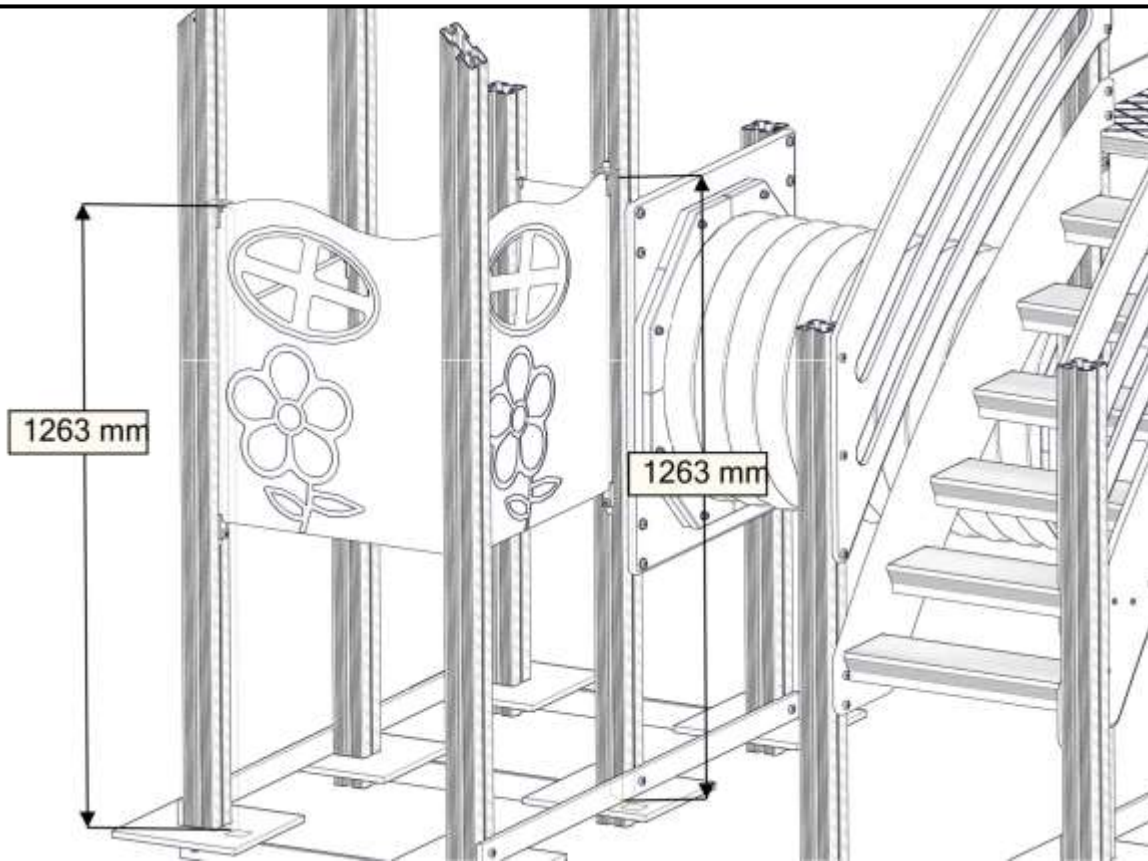

2x

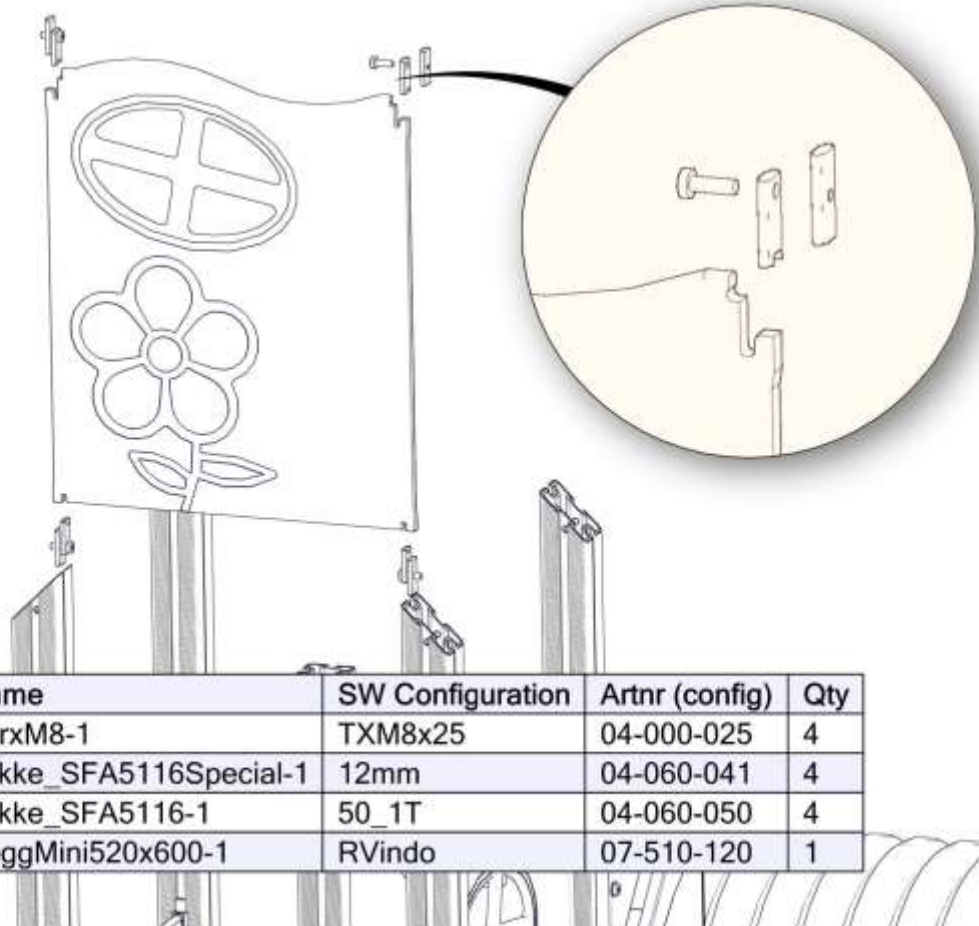

BOM ID	Name	SW Configuration	Artnr (config)	Qty
1	TorxM8-1	TXM8x25	04-000-025	4
2	brikke_SFA5116Special-1	12mm	04-060-041	4
3	brikke_SFA5116-1	50_1T	04-060-050	4
4	VeggMini520x600-1	RVindo	07-510-120	1

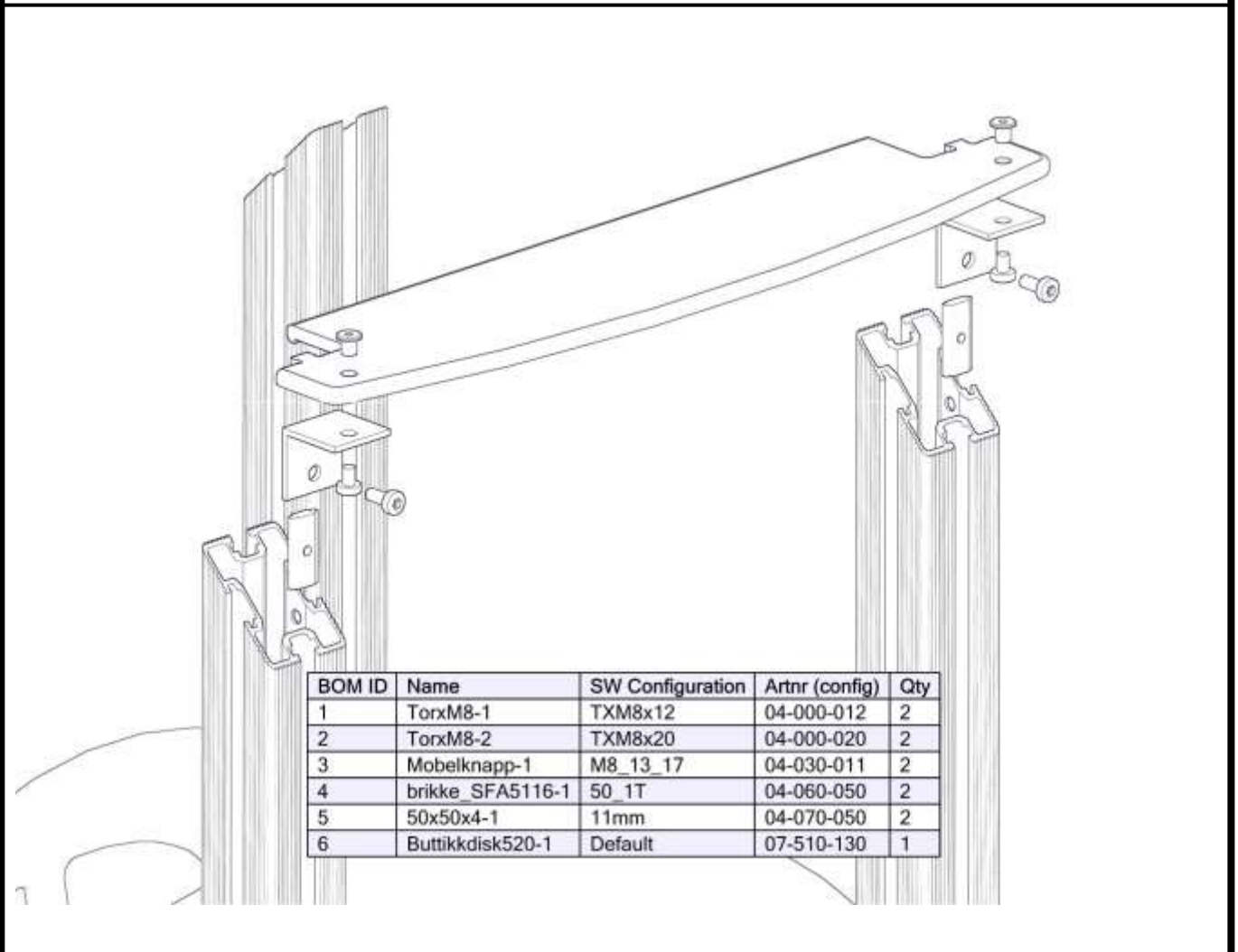
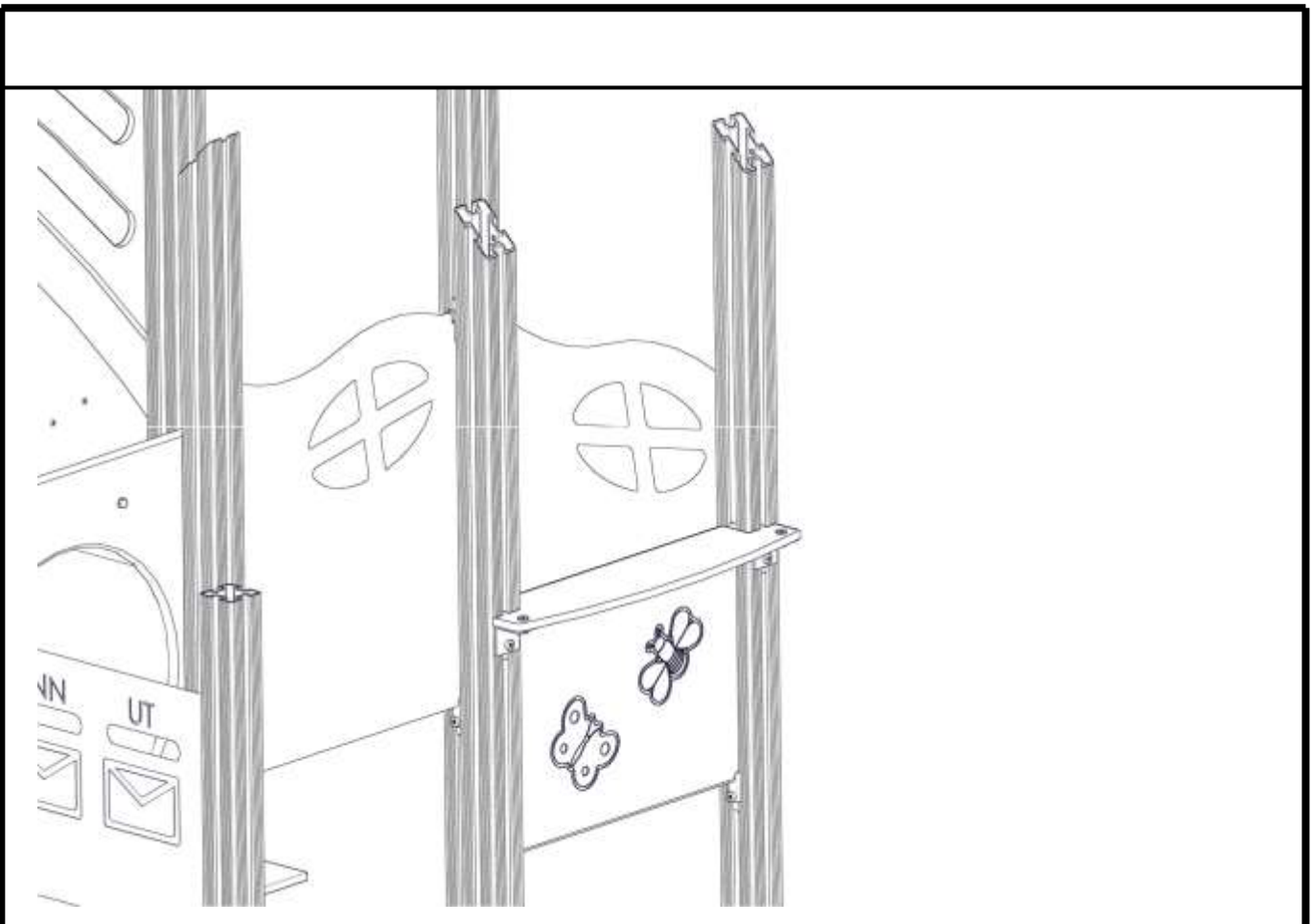

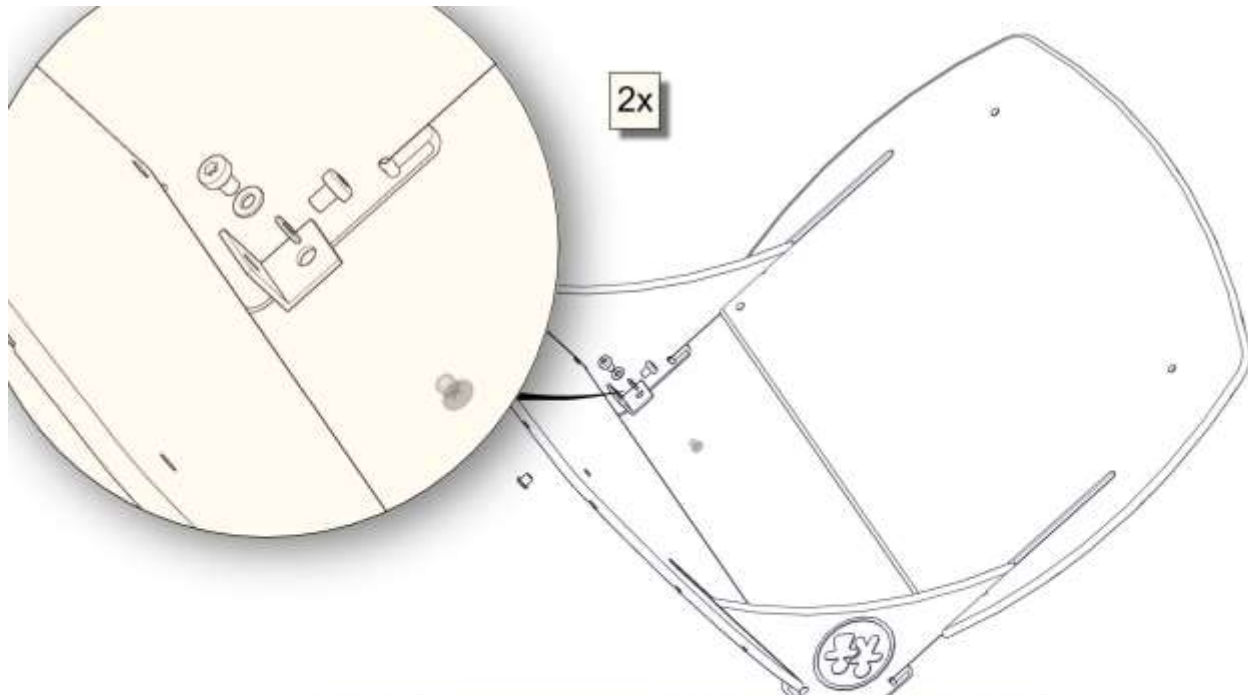
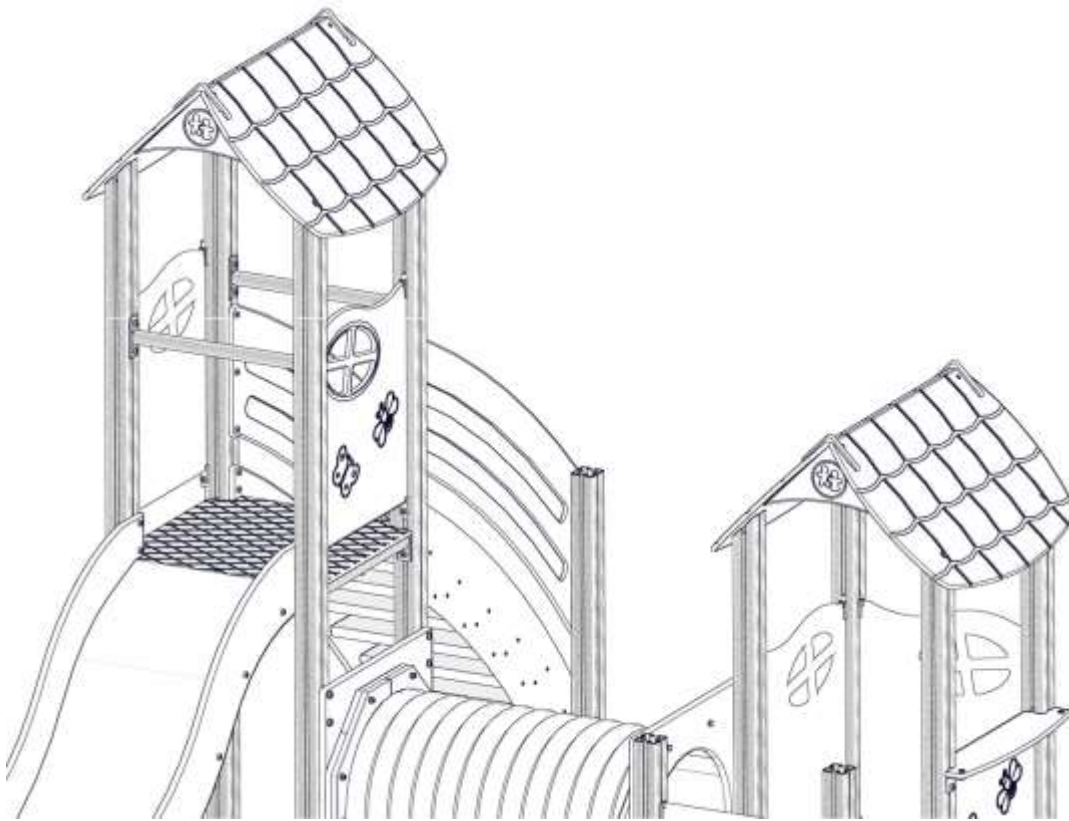



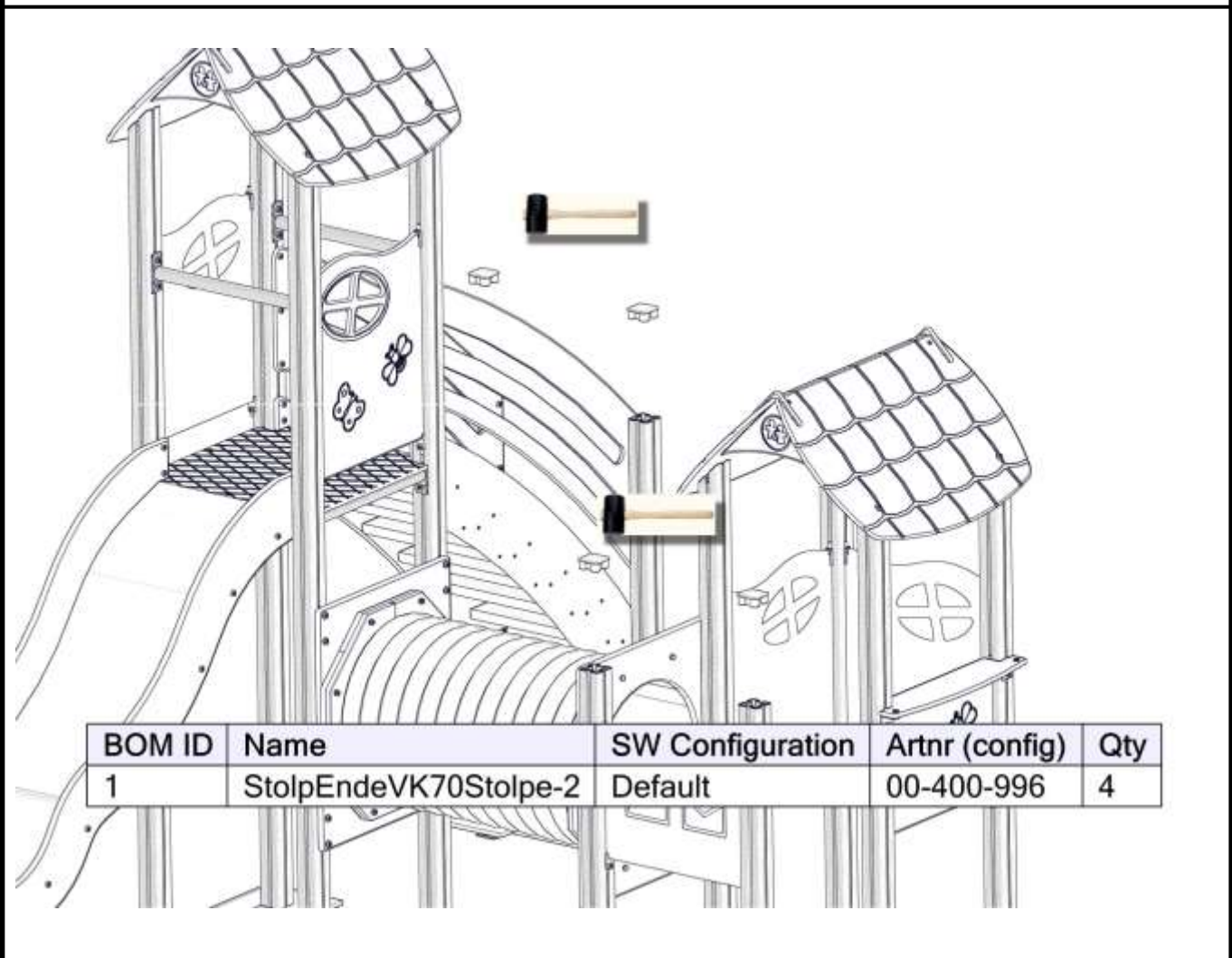
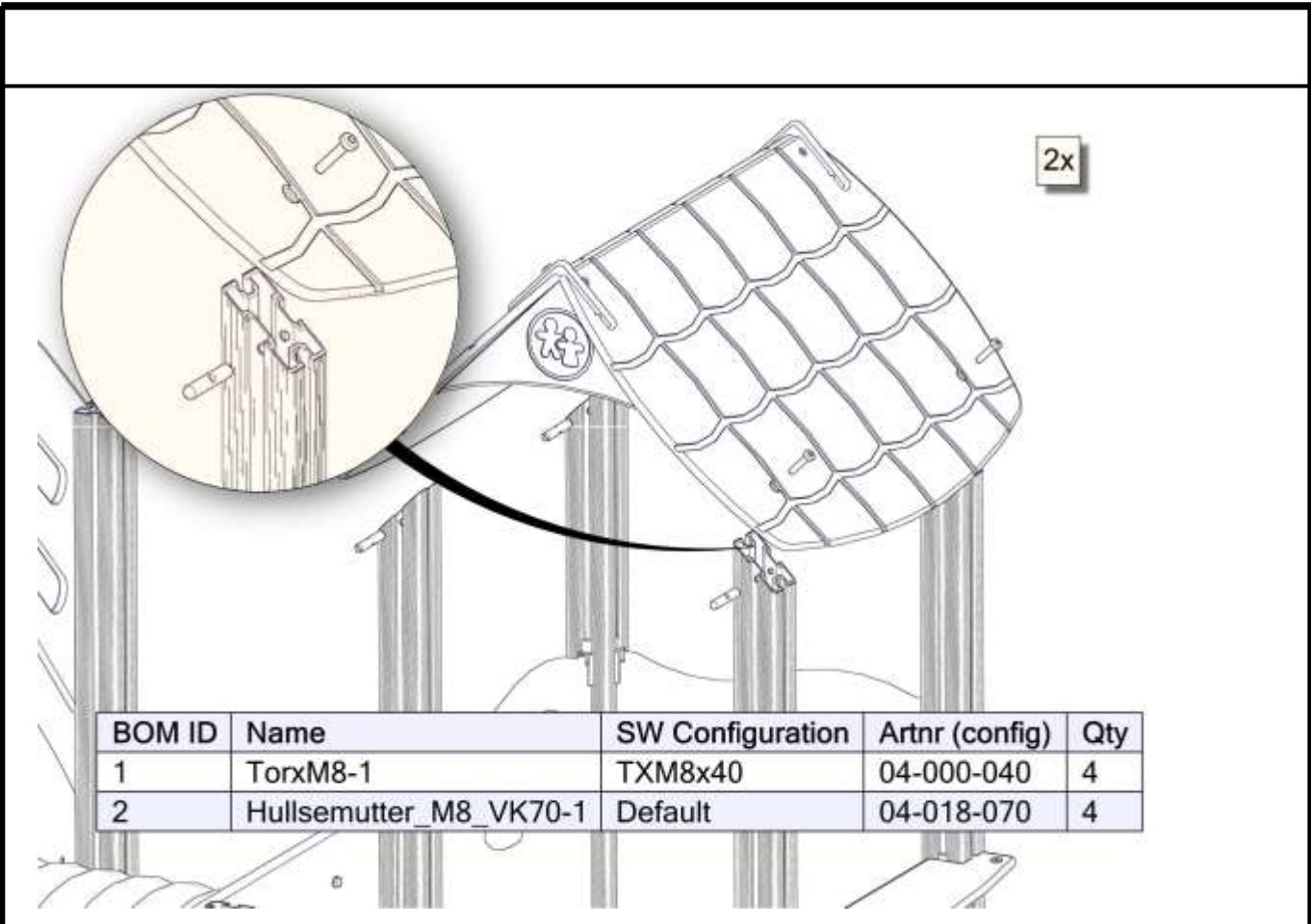









BOM ID	Name	SW Configuration	Artnr (config)	Qty
1	Torxm8-	TXM8x12	04-000-012	4
2	Mobelknapp-	M8_13_17	04-030-011	4
3	Skive-	M8	04-050-008	4
4	35x35x3-1	11mm	04-070-036	2
5	Tak_Miniserie2011-	rod	07-510-105	2
6	Gavelplatemini2011-	Rod	07-510-106	2



Før utstyret tas i bruk / Before play begins / Innan lekredskapet tas i bruk	
N	<ul style="list-style-type: none"> ● Påse at fallunderlag er utlagt i henhold til gjeldende regler eller vår anbefaling ● Fjern alle monteringshjelpemidler (rester av betong, planker, paller, plast, og lignende) ● Før utstyret tas i bruk, burde man sjekke at det ikke er fare for at anorakksnorer og lignende som kan hekte seg fast noen steder på lekeapparatet. (Vedlagte snor med dobbe (kneledd) kan brukes til å sjekke at dette er i orden. Se vedlagte veiledning for bruk av denne. Dette gjøres for å oppdage eventuelle feilmonteringer.?) ● NB! Bør stå i 2-3 dager før bruk
EN	<ul style="list-style-type: none"> ● Make sure the area and depth of safer surfacing are according to the current standard, or to the manufacturer's recommendation ● Make sure all tools and surplus materials are removed before play begins ● PS! When complete, allow 2-3 days for the concrete to set before use
S	<ul style="list-style-type: none"> ● Kontrollera att fallunderlag är utlagt enligt gällande regler eller vårt rekommendation ● Ta bort alla monteringshjälpmedel (rester av betong, plankor, pallar, plast och liknande) ● Innan lekredskapet används, kontrollera att anoracksnoddar eller kläder/delar av kläder eller liknande inte kan fastna i några delar på redskapet. (Den bipackade "knävringen" kan man med fördel användas för denna kontroll. ● Detta görs för att upptäcka eventuella felmonteringar.)







Boltepakker for / Boltpackage for / Bultpaket för

Sign. _____.

 <p>VK70 skrå 2100-600 07-510-158</p> <p>4</p>	 <p>VK70 skrå 1150-600 07-510-158</p> <p>4</p>
 <p>Sperrerør 520 07-510-160</p> <p>2</p>	 <p>Sperrerør 520 gulv 07-510-161</p> <p>4</p>
 <p>VK70 660-600 07-510-455</p> <p>2</p>	 <p>VK70 800-600 07-510-455</p> <p>2</p>
 <p>Tak 07-510-105</p> <p>2</p>	 <p>Gulv 520 07-510-102</p> <p>1</p>
 <p>Vegge 520x600 07-510-120</p> <p>2</p>	 <p>Vegge 520x600 07-510-120</p> <p>2</p>
 <p>Rutsjebane 950 07-510-305</p> <p>1</p>	 <p>trekke 950 07-510-451</p> <p>1</p>

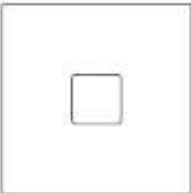
Boltepakker for / Boltpackage for / Bultpaket för

Sign. _____

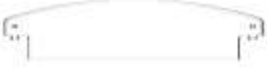
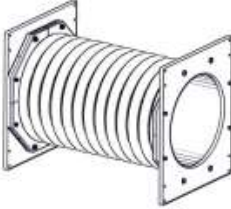
 <p>MiniSprosse 660 07-510-200</p> <p>9</p>	 <p>MiniSprosse 1250 07-510-202</p> <p>2</p>
 <p>FunMiniSkive 07-510-201</p> <p>12</p>	 <p>Endelokk70x70 00-400-996</p> <p>4</p>
 <p>Vegge520x400 Sommerfugl/Bi 07-510-110</p> <p>1</p>	 <p>Vegge520x400 Postkasse 07-510-111</p> <p>1</p>
 <p>Butikkdisk 07-510-130</p> <p>1</p>	 <p>Tunell 07-510-481</p> <p>1</p>