



Monteringsanvisning



Assembly Instructions



Monteringsanvisning

Produkt nr. / Product no. / Produkt nr.

25-200-150

Ordr. nr. _____

Dato. _____

Sign. _____



Søve Lekemiljø AS

3830 Ulefoss - Norway

Tlf: +47 35 94 65 65

www.sove.no



Søve AB

Fabriksgatan 7

412 50 Göteborg

Phone: +46 (0)31 773 97 00

www.sove.se

Monteringstips / Assembly Advice / Monteringsstips

N

- Les monteringsanvisningen nøye før montering.
- Monter elementene i rekkefølgen som vist.
- Boltene bør ikke skrues for hardt til før alt er montert, vatret og loddet. Skru så boltene til.
- NB! Ved bruk av drill, kan boltene ryke.
- På grunn av at solen kan gjøre rutsjeflaten veldig varm, bør rutsjebanens utløp vende mot nord-øst eller nord-vest.
- Er lekeutstyret plassert i naturlige ferdselstraséer må området sikres mot spontan gjennomgang.
- Innspringningshinder bør vurderes rundt lekeapparater hvor det er stor bevegelse, f.eks.
 - ved huskestativ.
- Det bør være fritt innsyn til lekeutstyr som er beregnet for barn under 3 år.

NB! Under monteringsarbeidet må utstyr, som ikke er forankret forsvarlig i bakken, avstives slik at det ikke velte. Området må avstenges under oppsettelse av apparatene med sperrebånd eller lignende.

UK

- Read the instruction carefully before assembling the play unit.
- Assemble the components in the sequence shown in these instructions.
- Fixings must not be fully tightened during assembly. Before casting the foundations, the structure must be level and plumb, at which point all fixings are tightened.
- PS! If use of drill, the bolts may be wrecked.
- Avoid positioning the slide facing due south because of overheating – ideal positions are facing north-east or north-west.
- Secure the construction-area to prevent people from walking through it.
- Consider installing barriers around play-equipment which gives rise to a lot of activity – i.e. swings.
- Ensure that clear vision is possible across the play area so that supervision is possible from any position, particularly where children under 3 years of age will be playing.

NB! During assembly of the equipment, ensure that all structures are securely propped, especially when left overnight. Also ensure that equipment is supported whilst concrete foundations are setting and enclose the area securely to prevent access.

Monteringstips / Assembly Advice / Monteringsstips











S

- Läs monteringsanvisningen noga före montering.
 - Montera delarna i den ordningen som anvisas
 - Skruvarna bör inte skruvas för hårt tills allt är monterat, i våg och lodat.
- OBS! Används elektrisk skruvdragare, kan bulten gå sönder. Hårdra därför manuellt!
- Solen kan göra att rutchbanan blir väldigt varm. Banans nedfart rekommenderas att vändas i norrlig riktning
 - Om lekplatsen placeras vid en gångväg mm bör området säkras mot genomfart av gående och cyklister.
 - Inspringningshinder bör placeras runt lekutrustning med stor rörelse, t ex, gungställning.
 - Det bör vara fri insyn till lekutrustning beräknat till barn under 3 år.

OBS! Under monteringsarbete bör utrustningen som inte ska förankras i marken, ställs så att den inte kan välta.

Området måste spärras när lekutrustningen byggs upp, med avspärrningsband eller liknande.

Nødvendig verktøy / Tools required / Nödvändiga verktyg

<p>(N)</p> <p>(UK)</p> <p>(S)</p>	<p>(A)</p> 	<p>(B)</p>  <p>Torx Nr 45 High quality</p> 	<p>(C)</p> <p>5 mm 6 mm</p> 	<p>(D)</p> 	<p>(E)</p> 
		<p>Metermål Metric measure Tumstoc</p> 	<p>16 V</p> 	<p>Merkebånd Mark ribbon Märkeband</p> 	<p>13 + 17mm</p> 

Nødvendig antall personer / Number of persons required / Lämpligt antal personer





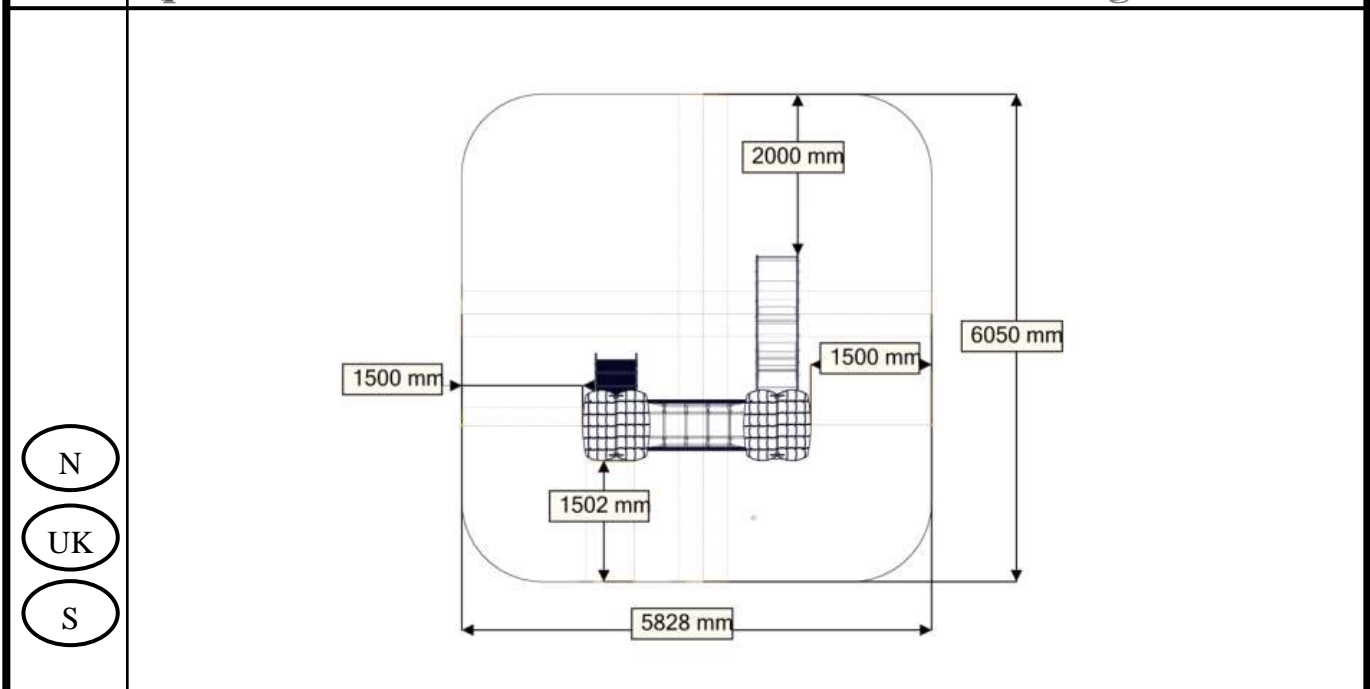







Anbefalt arealbehov ved montering / Recommended working space / Rekommenderad arealbehov vid montering





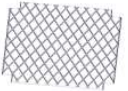











Boltepakker for / Boltpackage for / Bultpaket för

Sign. _____.

Stolpe 70x70 skrå	Ant= 8	Navn	Artnr/dimensjon	Ant	Lev
		VK70 2100-600 (1) Skrå	07-510-158	4	
		VK70 1700-600(1) Brikke på stolpe!	07-510-156	4	
		Torx M8x40 (1)	04-000-040	8	
		Hullsemutter (1) VK70	04-018-070	8	
FundamentMini 660	Ant= 8	Navn	Artnr/dimensjon	Ant	Lev
		miniSprosse 660 (1)	07-510-200	8	
		Brikke 50_1T (2)	04-060-040	16	
		Torx M8x35 (2)	04-000-035	16	
FundamentSkive	Ant= 8	Navn	Artnr/dimensjon	Ant	Lev
		Skive (1)	07-510-201	8	
Gulv mini	Ant= 2	Navn	Artnr/dimensjon	Ant	Lev
		Gulv Mini 520(1)	07-510-102	2	
		Møbelknapp (4)	04-030-011	8	
		Torx M8x45 (4)	04-000-045	8	

Boltepakker for / Boltpackage for / Bultpaket för

Sign. _____

Vegge 520x600 Vindo bloms	Ant= 2	Navn	Artnr/dimensjon	Ant	Lev
		Vegge520x600 (1) Vindu blom	07-510-120	2	
		Brikkespesial(4)	04-060-041	8	
		Brikke(4)	04-060-040	8	
		Torx M8x25(4)	04-000-025	8	
Vegge 520x600 Vindo Bi	Ant= 2	Navn	Artnr/dimensjon	Ant	Lev
		Vegge520x600 (1) Vindu bi/ Sommerfulg	07-510-120	2	
		Brikkespesial(4)	04-060-041	8	
		Brikke(4)	04-060-040	8	
		Torx M8x25(4)	04-000-025	8	
Vegge 520x400 Sommerfugl / bie	Ant= 2	Navn	Artnr/dimensjon	Ant	Lev
		Vegge520x400 (1) Sommerfugl/bi	07-510-110	2	
		Brikkespesial(4)	04-060-041	8	
		Brikke(4)	04-060-040	8	
		Torx M8x25(4)	04-000-025	8	











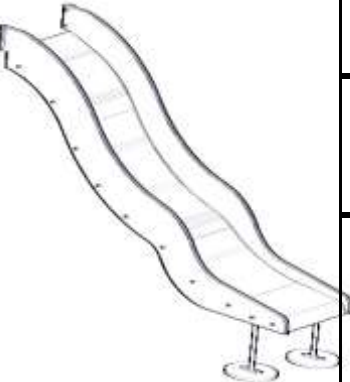

Boltepakker for / Boltpackage for / Bultpaket för

Sign. _____.

Sperrerør 520	Ant= 2	Navn	Artnr/dimensjon	Ant	Lev
		Sperrerør 520 (1)	07-510-160	2	
		Brikke 120_3T (2)	04-060-120	4	
		Torx M8x25 (4)	04-000-025	8	
Sperrerør 520 gulv	Ant= 6	Navn	Artnr/dimensjon	Ant	Lev
		Sperrerør 520 (1)	07-510-161	6	
		Brikke 90_2T (2)	04-060-090	0 På stolpe	
		Torx M8x25 (2)	04-000-025	12	
Sperrerør 520 gulv 2 hull 300	Ant= 2	Navn	Artnr/dimensjon	Ant	Lev
		Sperrerør 520 (1) For brua	07-510-162	2	
		Brikke 90_2T (2)	04-060-090	0 På stolpe	
		Torx M8x25 (2)	04-000-025	4	

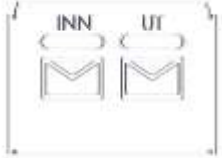







Boltepakker for / Boltpackage for / Bultpaket för

Sign. _____.

Rutsjebane 950 07-510-310	Ant= 1	Navn	Artnr/dimensjon	Ant	Lev
		Rutsjebane	07-510-310	1	
		Brikke120 3T(5)	04-060-120	2	
		Torx M8x35(4)	04-000-035	4	
		Torx M8x45(2)	04-000-045	2	
		Torzx M8x30(4)	04-000-030	4	
		Fundamentskive(2) 2H 80	00-003-106	2	
		Skive M8(2)	04-050-008	4	
	Mutter M8(2)	04-040-008	6		
	Stålforankring(2)	00-100-310	2		
Vegge 520x400 Postkasse	Ant= 1	Navn	Artnr/dimensjon	Ant	Lev
		Vegge520x400(1) Postkasse	07-510-111	1	
		Brikkespesial(4)	04-060-041	4	
		Brikke(4)	04-060-040	4	
		Torx M8x25(4)	04-000-025	4	







Boltepakker for / Boltpackage for / Bultpaket för

Sign. _____.

Trappe 550 07-510???	Ant= 1	Navn	Artnr/dimensjon	Ant	Lev
		Rutsjebane	01-290-090	1	
		Brikke90 3T(5)	04-060-090	2	
		Torx M8x35(4)	04-000-035	10	
		Fundamentskive(2) 2H 80	00-003-106	2	
		Skive M8(2)	04-050-008	6	
		Mutter M8(2)	04-040-008	6	
		Stålforankering(2)	00-100-310	2	











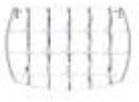

Boltepakker for / Boltpackage for / Bultpaket för

Sign. _____.

Nettbro skrå 07-510-175	Ant= 1	Navn	Artnr/dimensjon	Ant	Lev
		Nett (1) INKL. beslag	07-510-175	1	
		Rør skrå(2)	07-510-166	2	
		Brikke120 3T(8)	04-060-120	8	
		Torx M8x25(16)	04-000-025	16	
		Saddelwasher 38mm (24)	04-210-010	24	
		Møbelknapp (12)	04-030-025	12	

Boltepakker for / Boltpackage for / Bultpaket för

Sign. _____

Tak	Ant= 2	Navn	Artnr/dimensjon	Ant	Lev
		Tak mini (2)	07-510-105	4	
		Gavelplate(2)	07-510-106	4	
		Vinkel 35x35x3(2) 11mm	04-070-036	4	
		Møbelknapp	04-030-011	8	
		Torx M8x12(4)	04-000-012	8	
		Skive M8 (4)	04-050-008	8	
Buttikkdisk	Ant= 1	Navn	Artnr/dimensjon	Ant	Lev
		Buttikkdiskk	07-510-130	1	
		Vinkel 50x50x4(2) 11mm	04-070-050	2	
		Møbelknapp(2)	04-030-011	2	
		Brikke 501T(2)	04-060-040	2	
		Torx M8x12 (2) Torx M8x20 (2)	04-000-012 04-000-020	2 2	
		Skive M8 (2)	04-050-008	2	

Fundamentering med betong / Foundation concrete / Förankring med betong

(N)	Støtsand		(N)	(UK)	(S)
(UK)	Safer surface		Bakkenivå	Ground level	Marknivå
(S)	Stridsan		↓	Ref NS-EN 177	
(N)	Komprimert masse.	betong			
(UK)	Compressed mass.	concrete			
(S)	Komprimerad massa.	betong			

Fundamentering uten betong / Foundation without concrete / Förankring utan betong

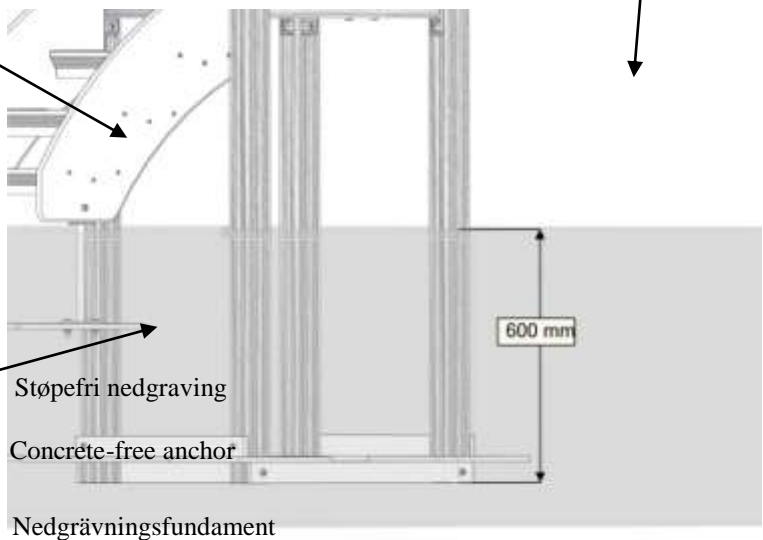
(N)	Støtsand		(N)	(UK)	(S)
(UK)	Safer surface		Bakkenivå	Ground level	Marknivå
(S)	Stridsan		↓		
(N)	Komprimert masse	Støpefri nedgraving			
(UK)	Compressed mass	Concrete-free anchor			
(S)	Komprimerad massa	Nedgravningsfundament			
Ref NS-EN 1177					

(N)	Alle mål er oppgitt i millimeter
(UK)	Scale measured in mm
(S)	Alla mått är i millimeter.

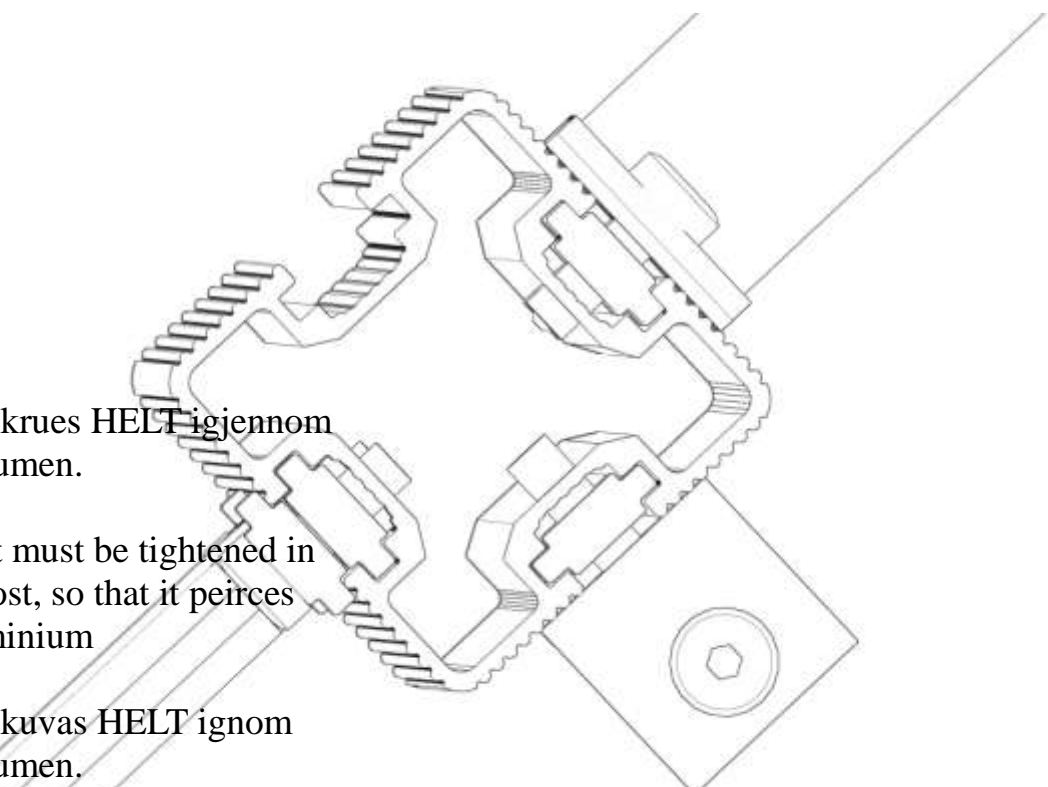
<p>N</p> <p>UK</p> <p>S</p>	 <p>Bolten skrues HELT igjennom aluminiumen.</p> <p>The bolt must be tightened in to the post, so that it peirces the aluminium</p> <p>Bulten skruvas HELT ignom aluminiumen.</p>

Fallhøyder / Free height of fall / Fallhöjder

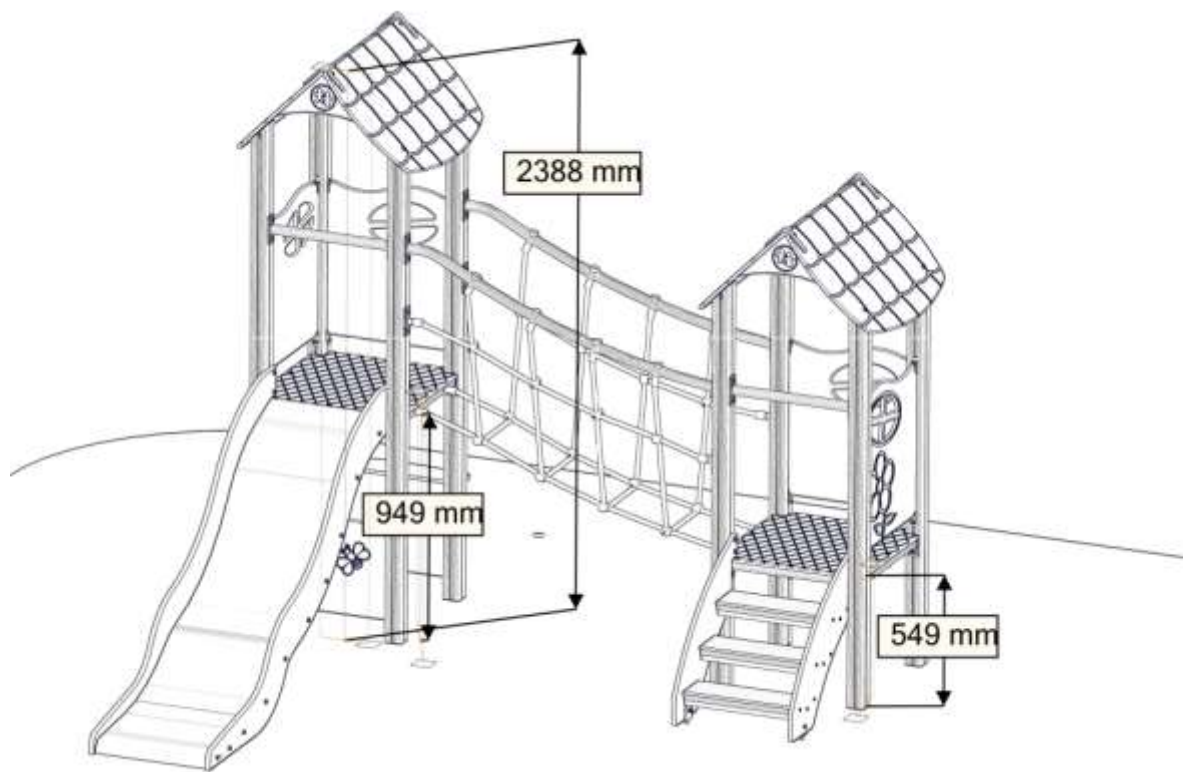

Sikkerhetszone / Safety zone / Säkerhetszon

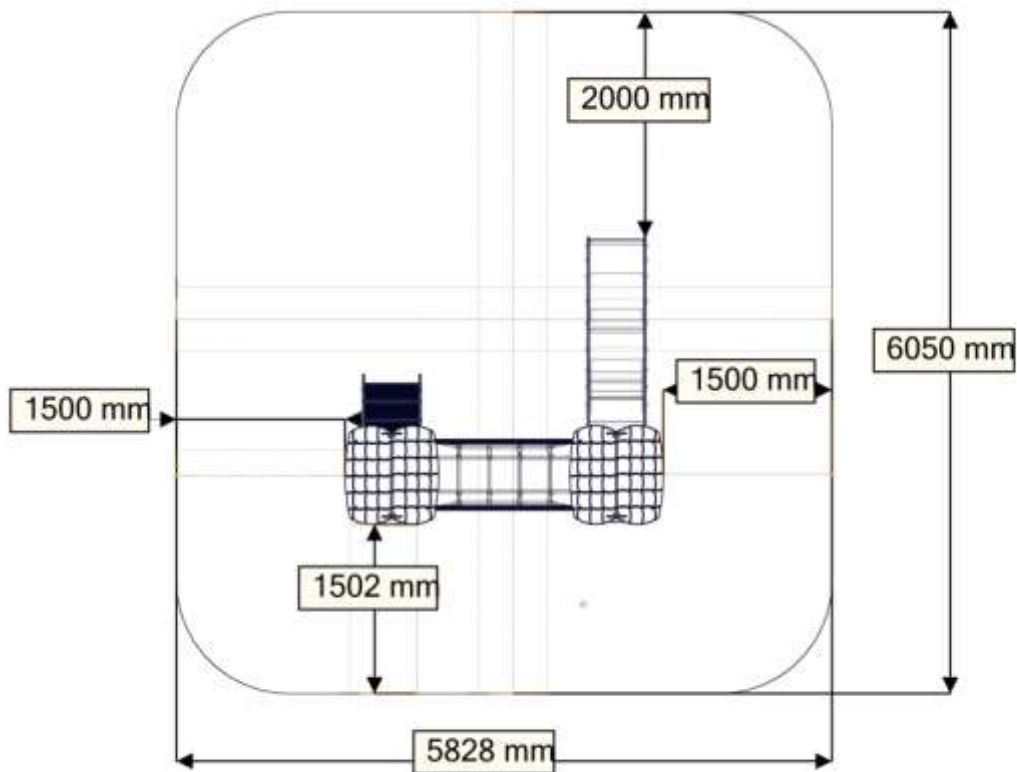

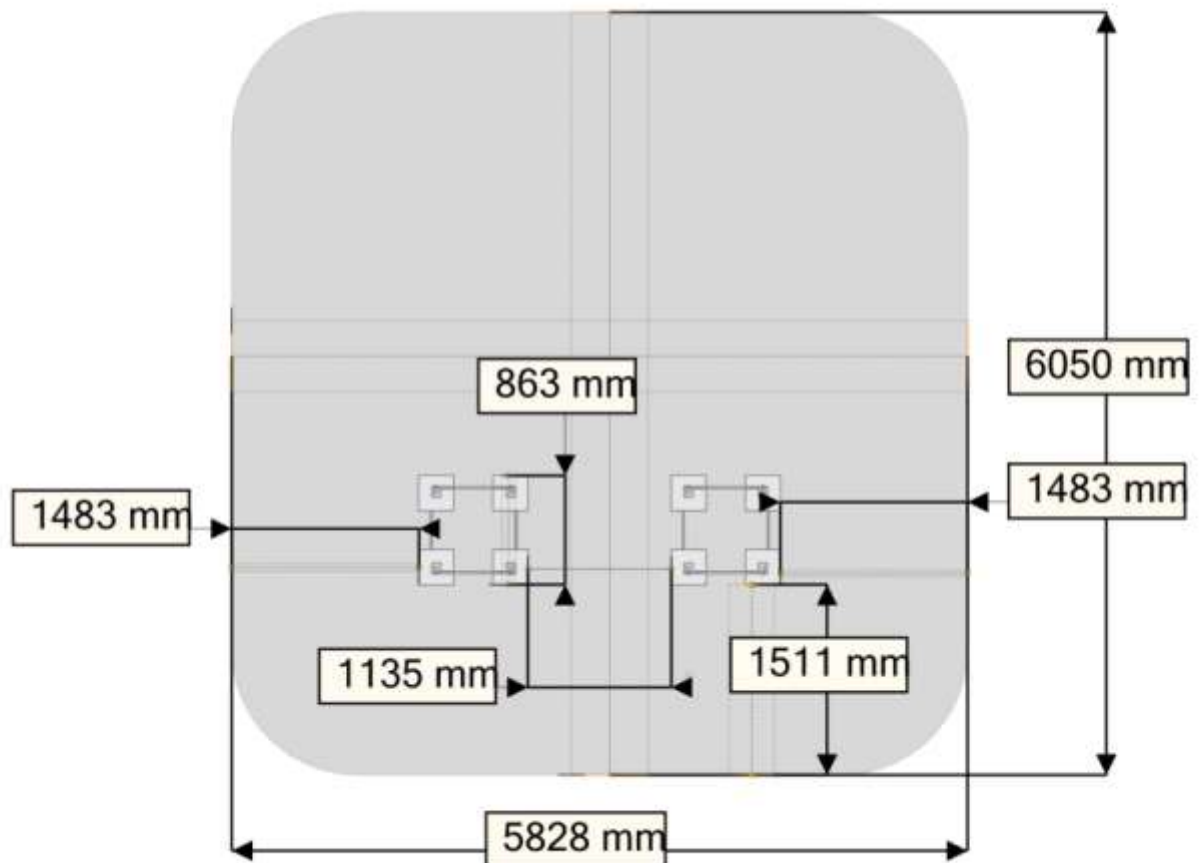
Plassering av forankringer / Ground plan / Placering av förankringar

N

Alle mål er oppgitt i millimeter

UK

Scale measured in mm

S

Alla mått är i millimeter.

Montering av lekeapparatet / Assembly instructions / Montering av lekredskapet



Montasje hos Søve

04-060-090

1530 mm

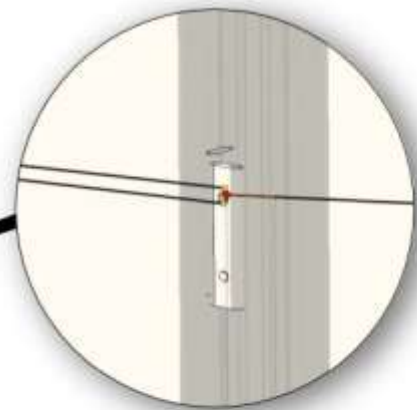

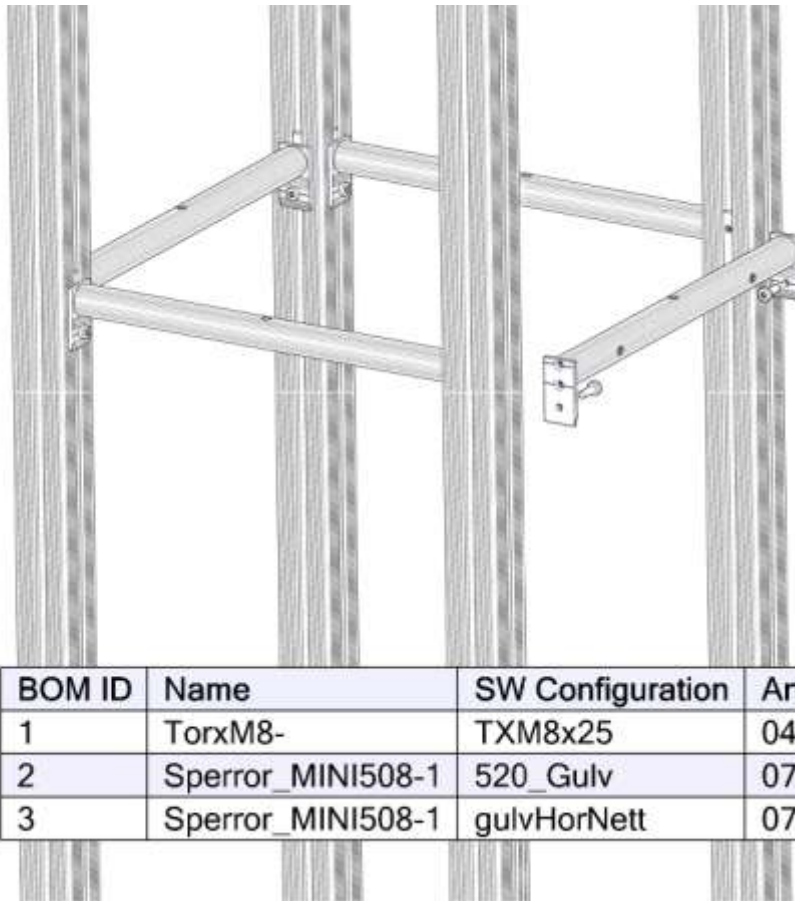

BOM ID	Name	SW Configuration	Artnr (config)	Qty
1	TorxM8-	TXM8x25	04-000-025	8
2	Sperror_MINI508-1	520_Gulv	07-510-161	3
3	Sperror_MINI508-1	gulvHorNett	07-510-162	1

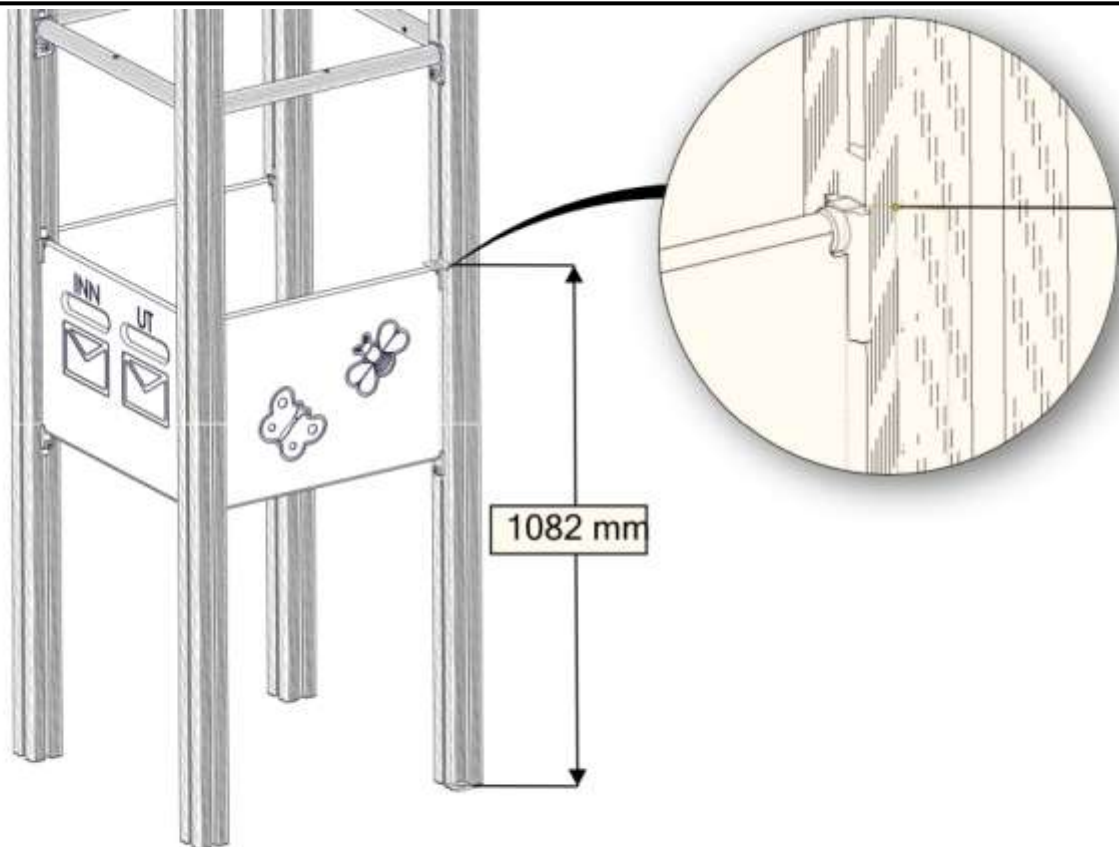

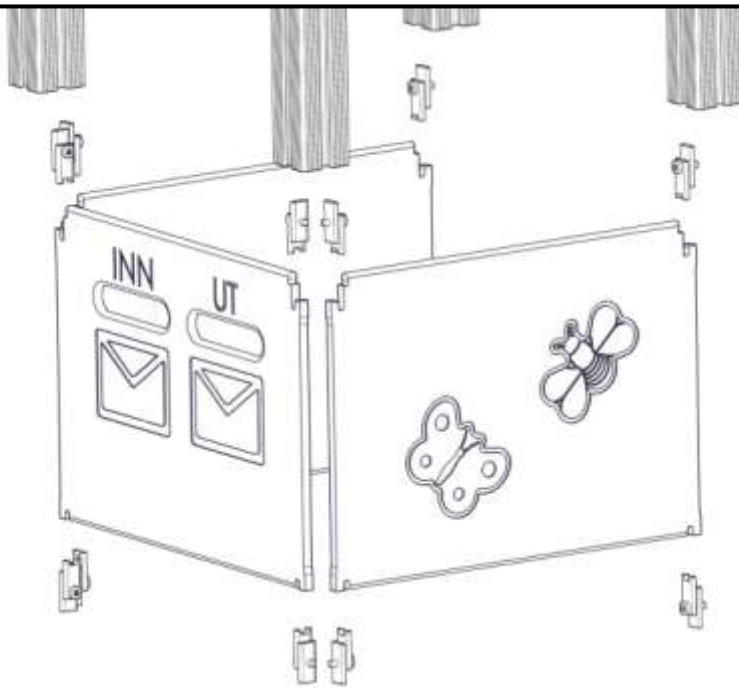

BOM ID	Name	SW Configuration	Artnr (config)	Qty
1	Torxm8-1	TXM8x25	04-000-025	12
2	brikke_SFA5116Special-1	12mm	04-060-041	12
3	brikke_SFA5116-1	50_1T	04-060-050	12
4	VeggMini520x400-1	STD	07-510-110	2
5	VeggMini520x400-1	Postkase	07-510-111	1

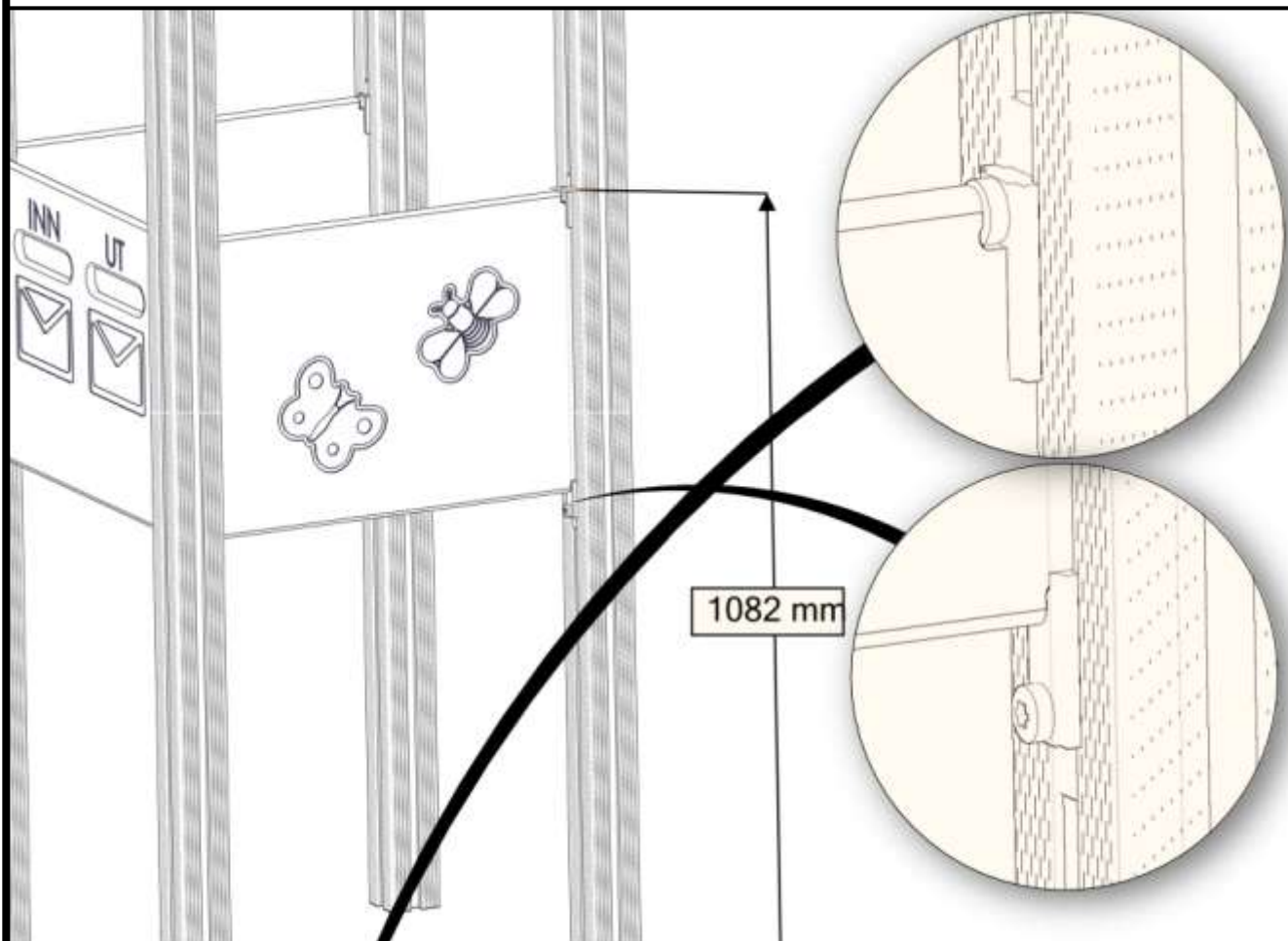

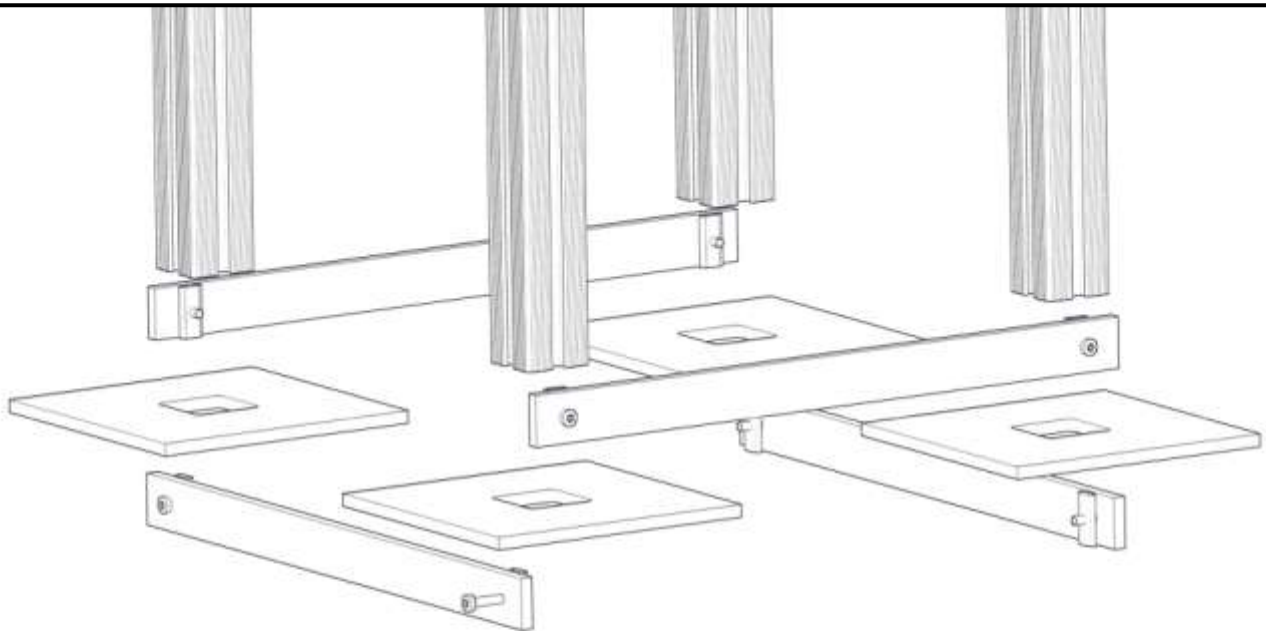
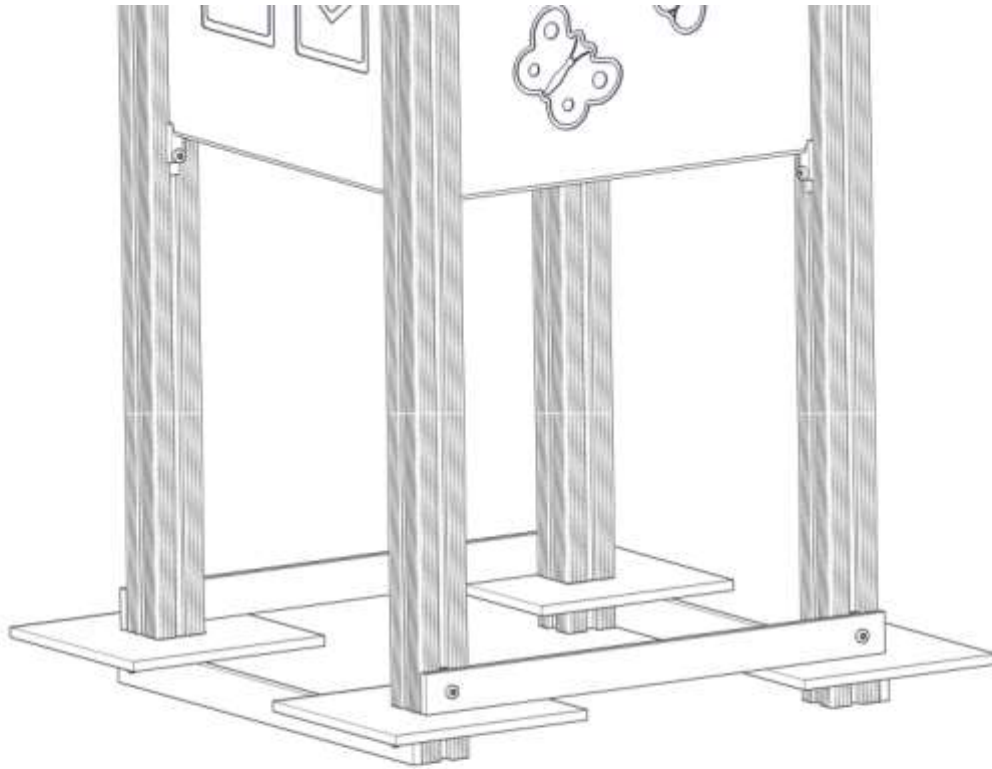

BOM ID	Name	SW Configuration	Artnr (config)	Qty
1	TorxM8-	TXM8x35	04-000-035	8
2	brikke_SFA5116-	50_1T	04-060-050	8
3	minifun_sprosse-1	660	07-510-200	4
4	minifunSkive-	Default	07-510-201	4

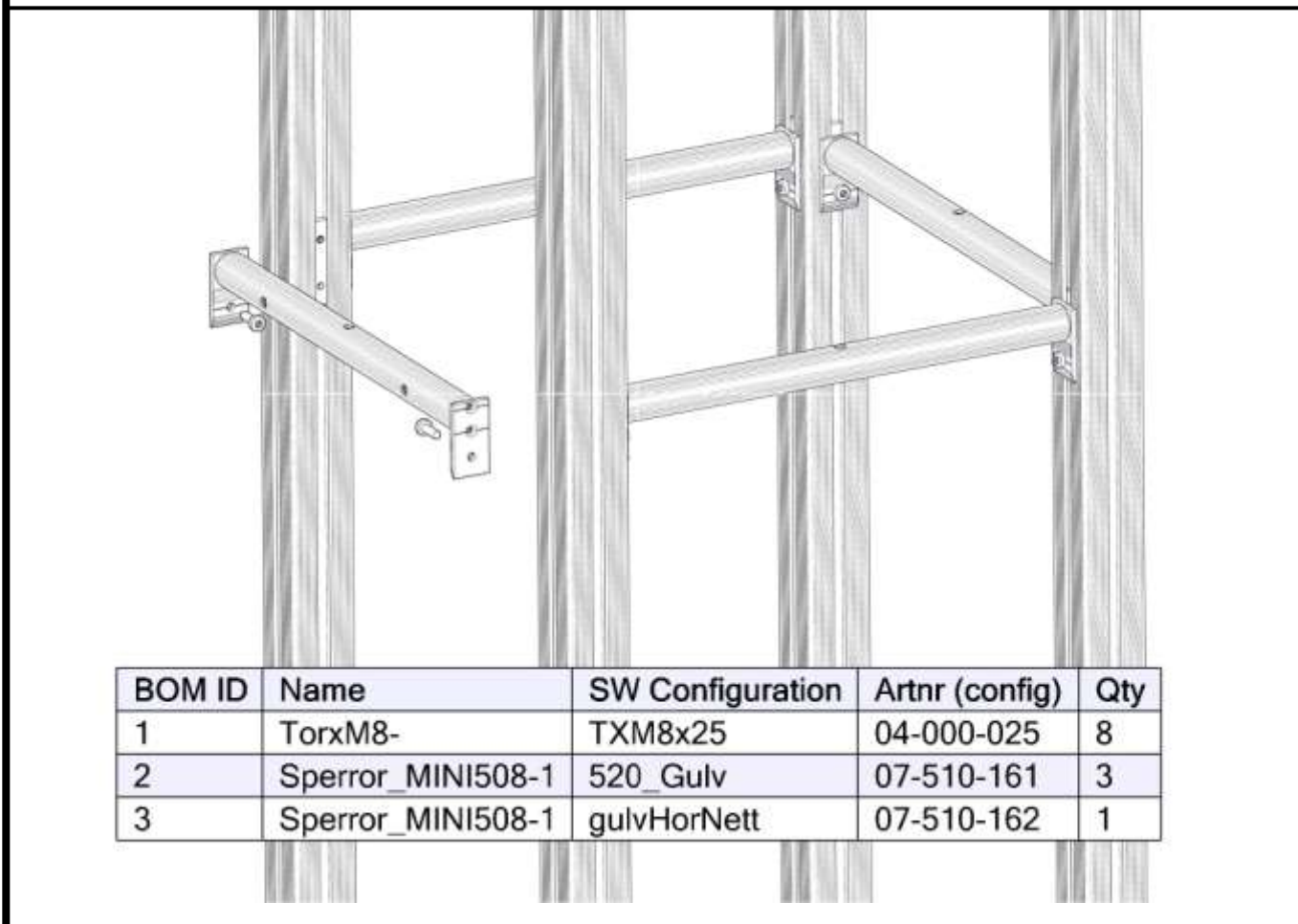
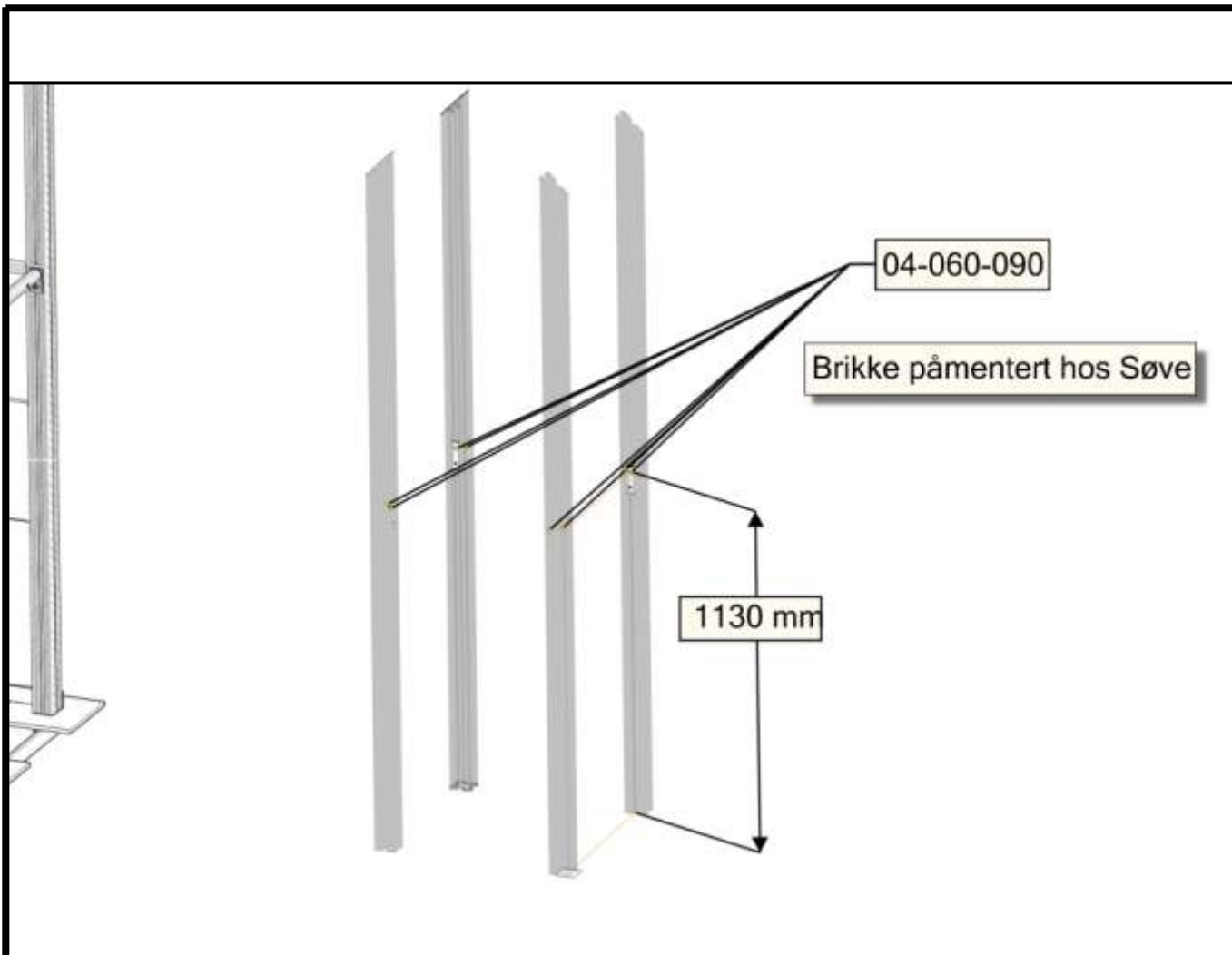

BOM ID	Name	SW Configuration	Artnr (config)	Qty
1	TorxM8-	TXM8x25	04-000-025	8
2	Sperror_MINI508-1	520_Gulv	07-510-161	3
3	Sperror_MINI508-1	gulvHorNett	07-510-162	1

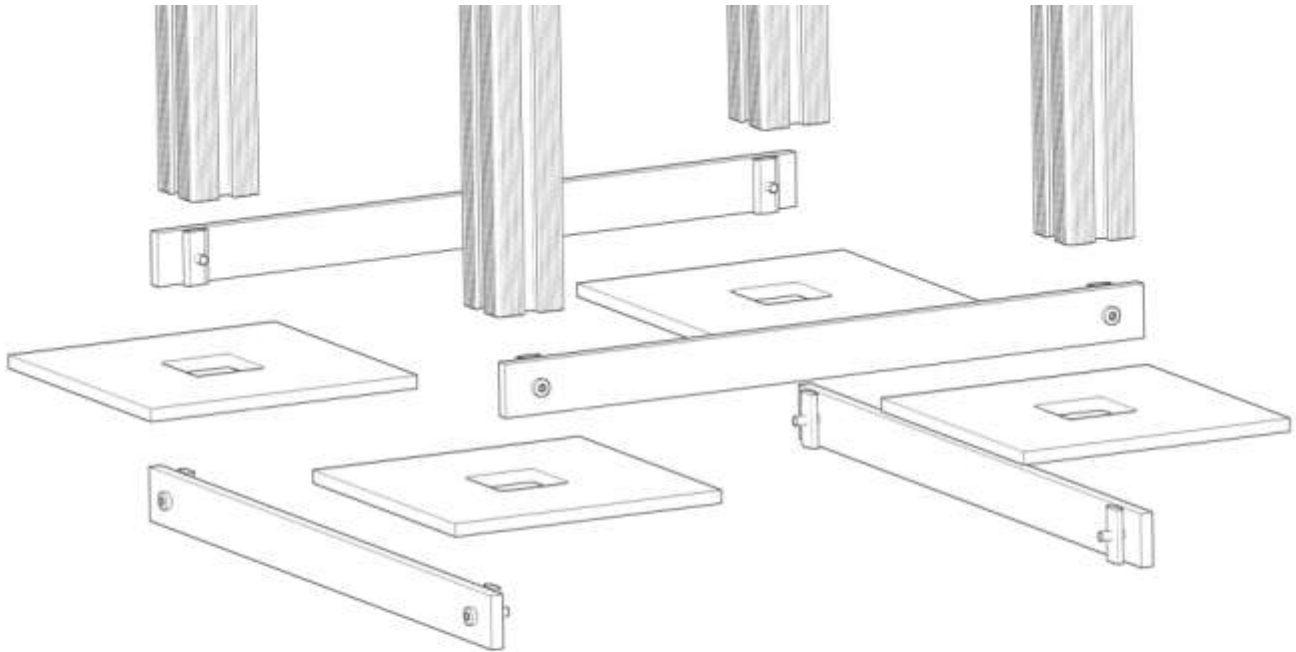

BOM ID	Name	SW Configuration	Artnr (config)	Qty
1	TorxM8-	TXM8x35	04-000-035	8
2	brikke_SFA5116-	50_1T	04-060-050	8
3	minifun_sprosse-1	660	07-510-200	4
4	minifunSkive-	Default	07-510-201	4

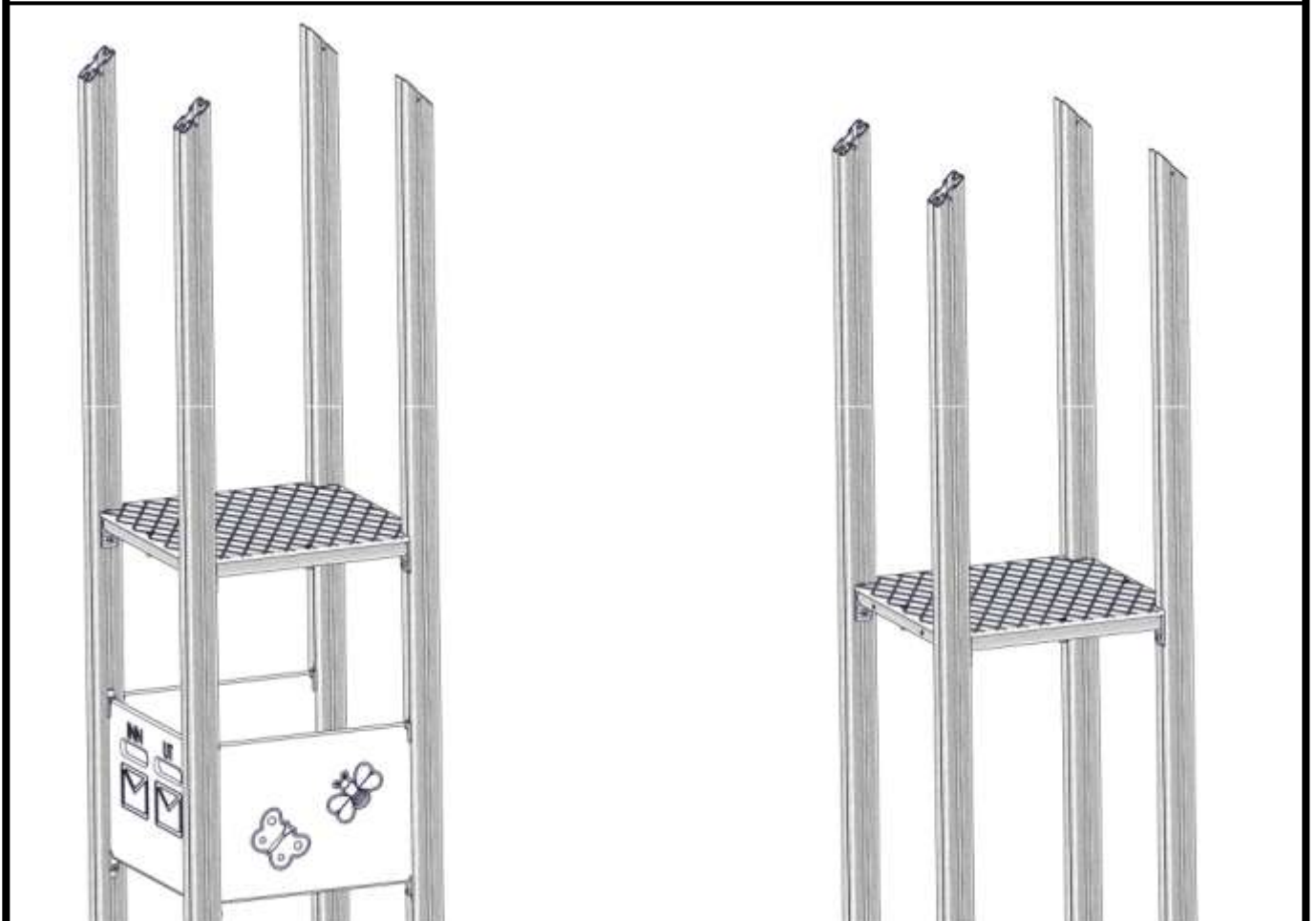

2x

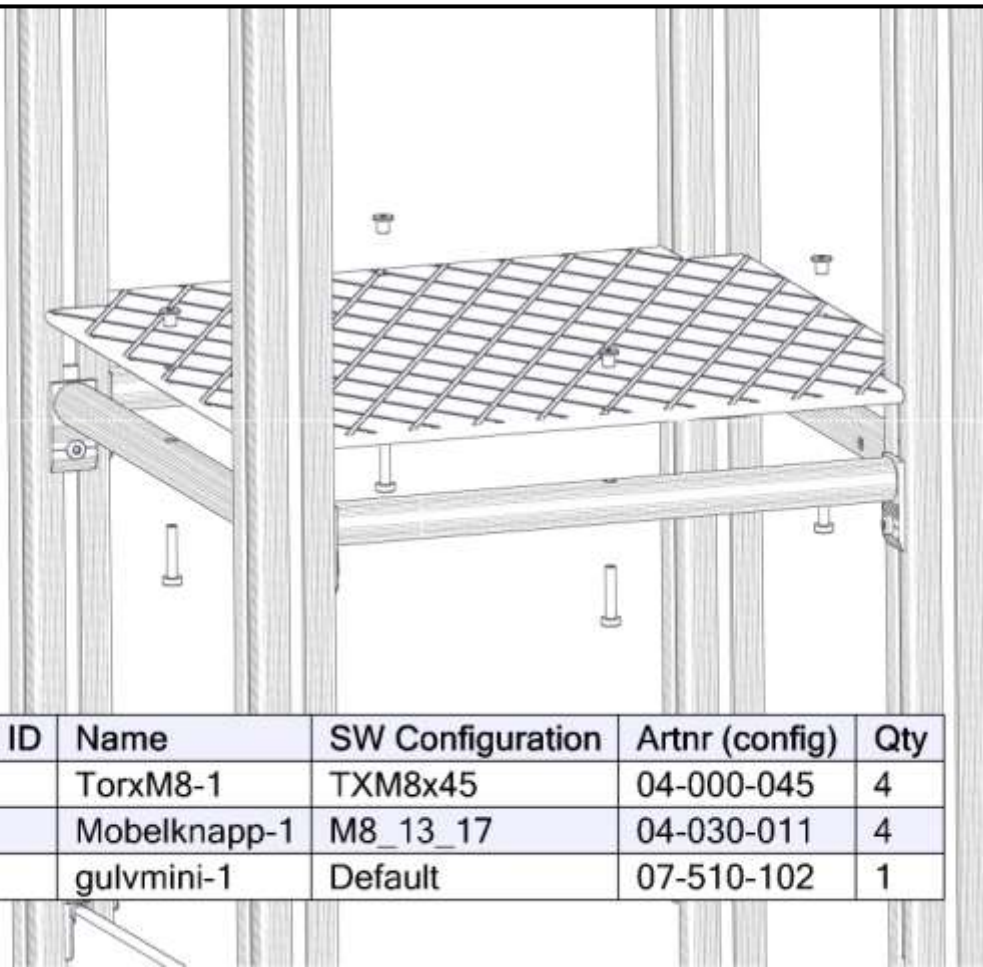

BOM ID	Name	SW Configuration	Artnr (config)	Qty
1	TorxM8-1	TXM8x45	04-000-045	4
2	Mobelknapp-1	M8_13_17	04-030-011	4
3	gulvmini-1	Default	07-510-102	1

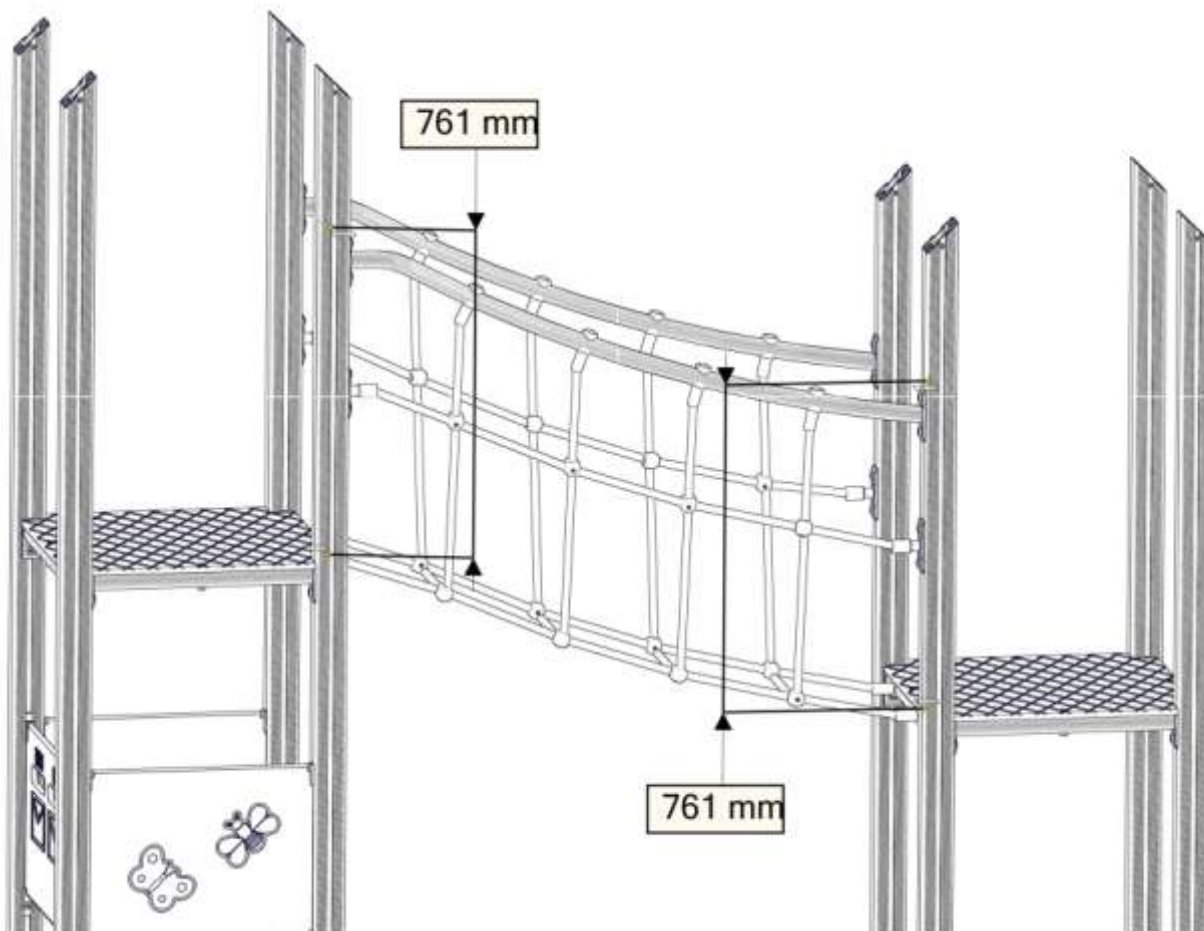

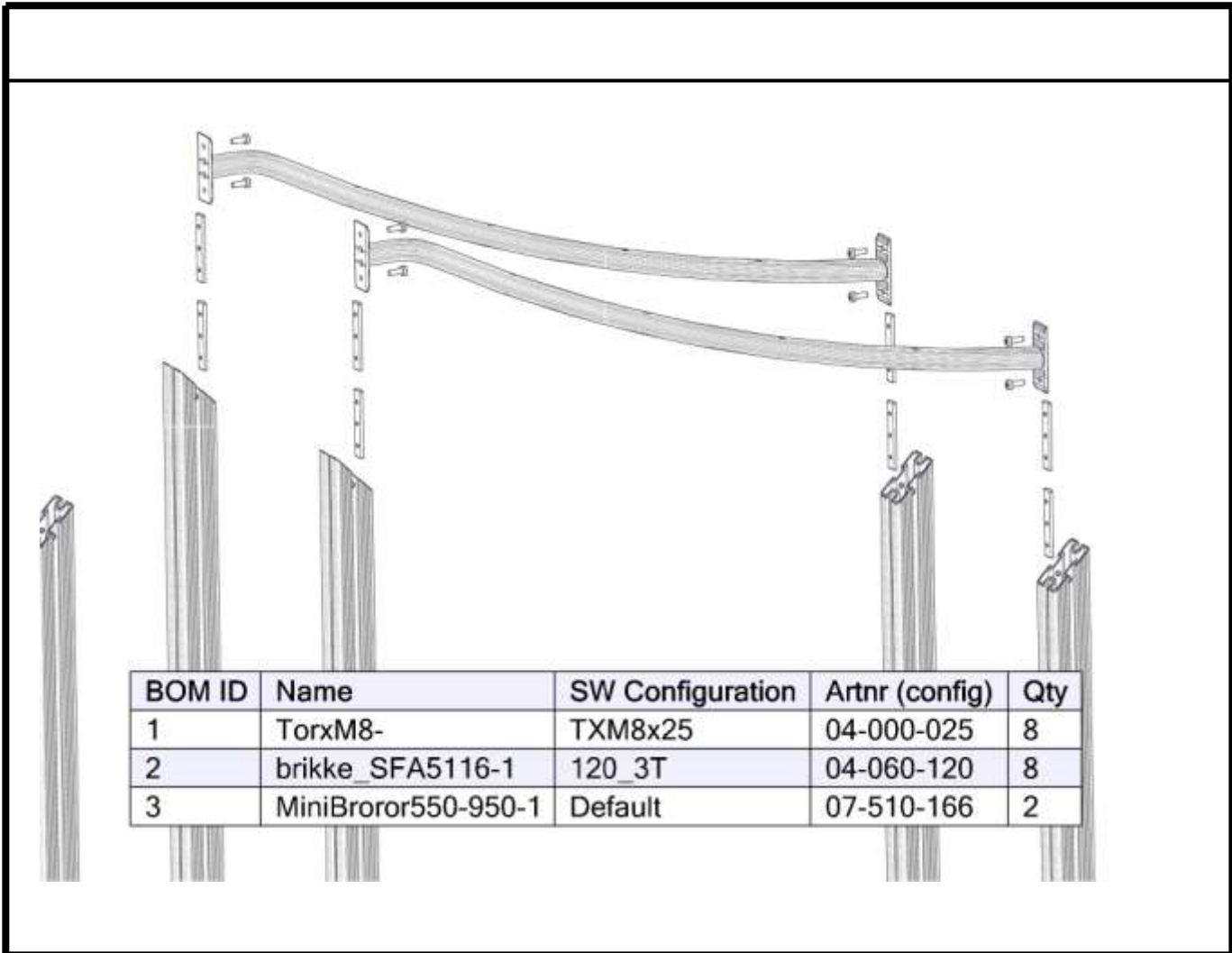

BOM ID	Name	SW Configuration	Artnr (config)	Qty
1	TorxM8-	TXM8x25	04-000-025	8
2	brikke_SFA5116-1	120_3T	04-060-120	8
3	MiniBroror550-950-1	Default	07-510-166	2

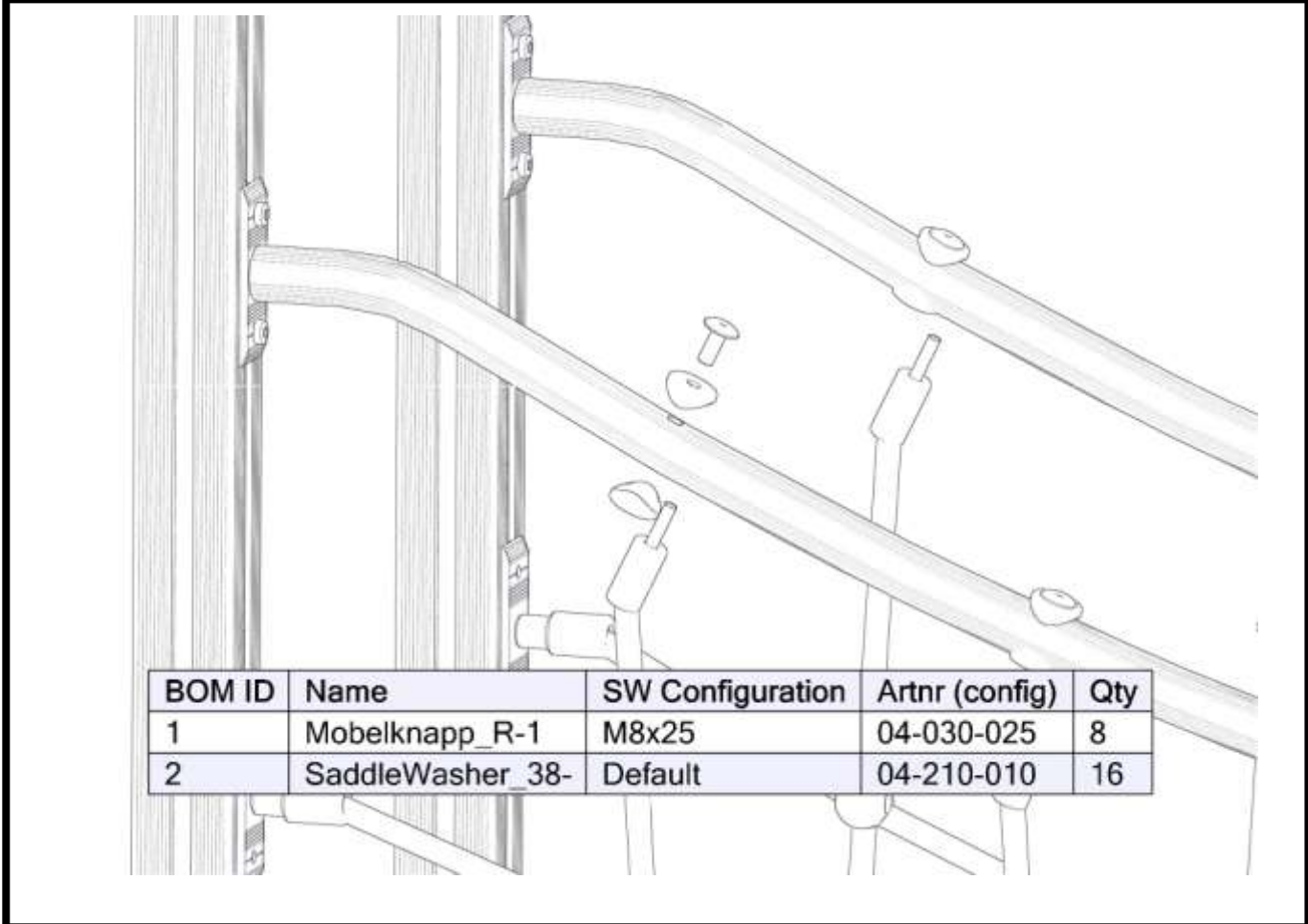

BOM ID	Name	SW Configuration	Artnr (config)	Qty
1	Mobelknapp_R-1	M8x25	04-030-025	8
2	SaddleWasher_38-	Default	04-210-010	16

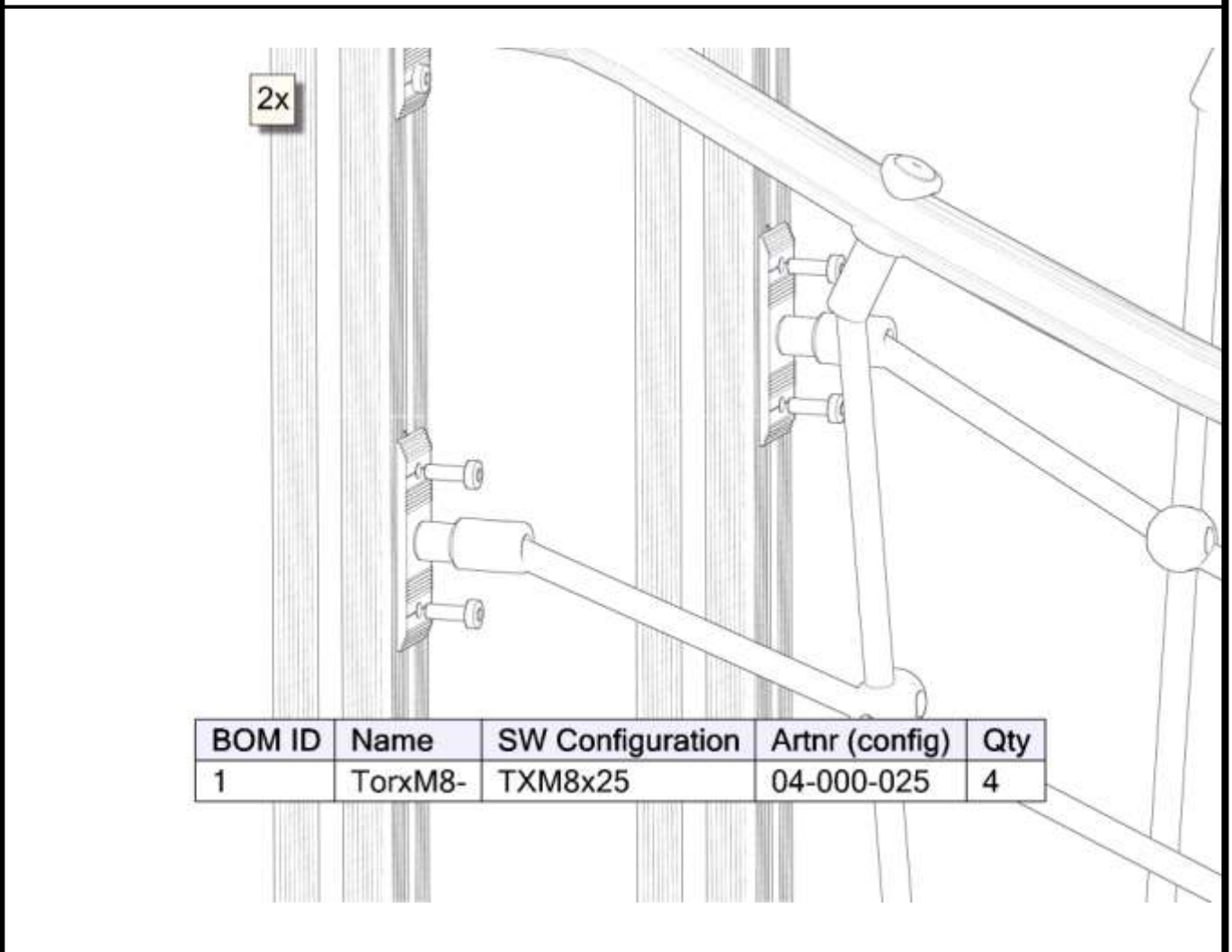
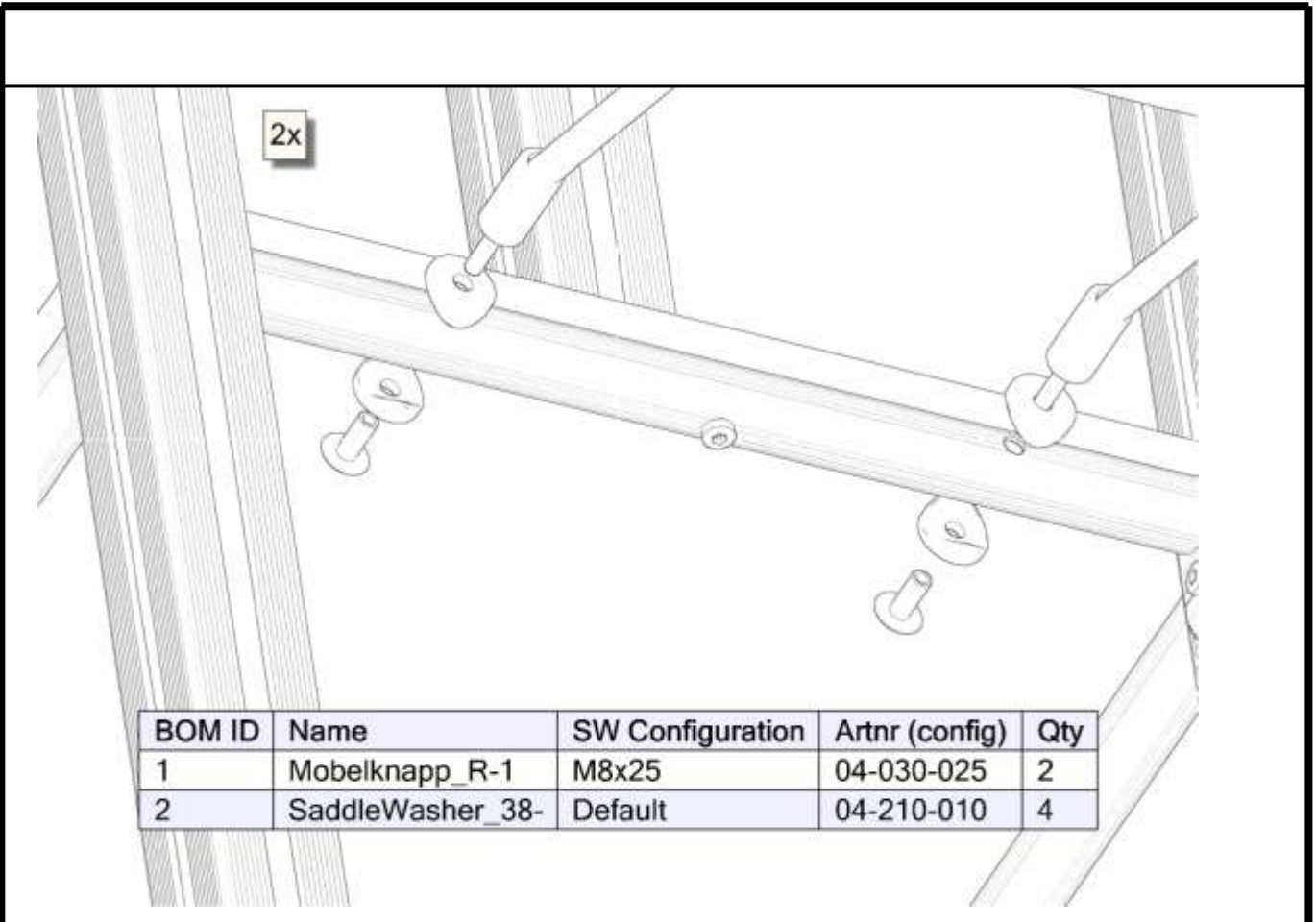

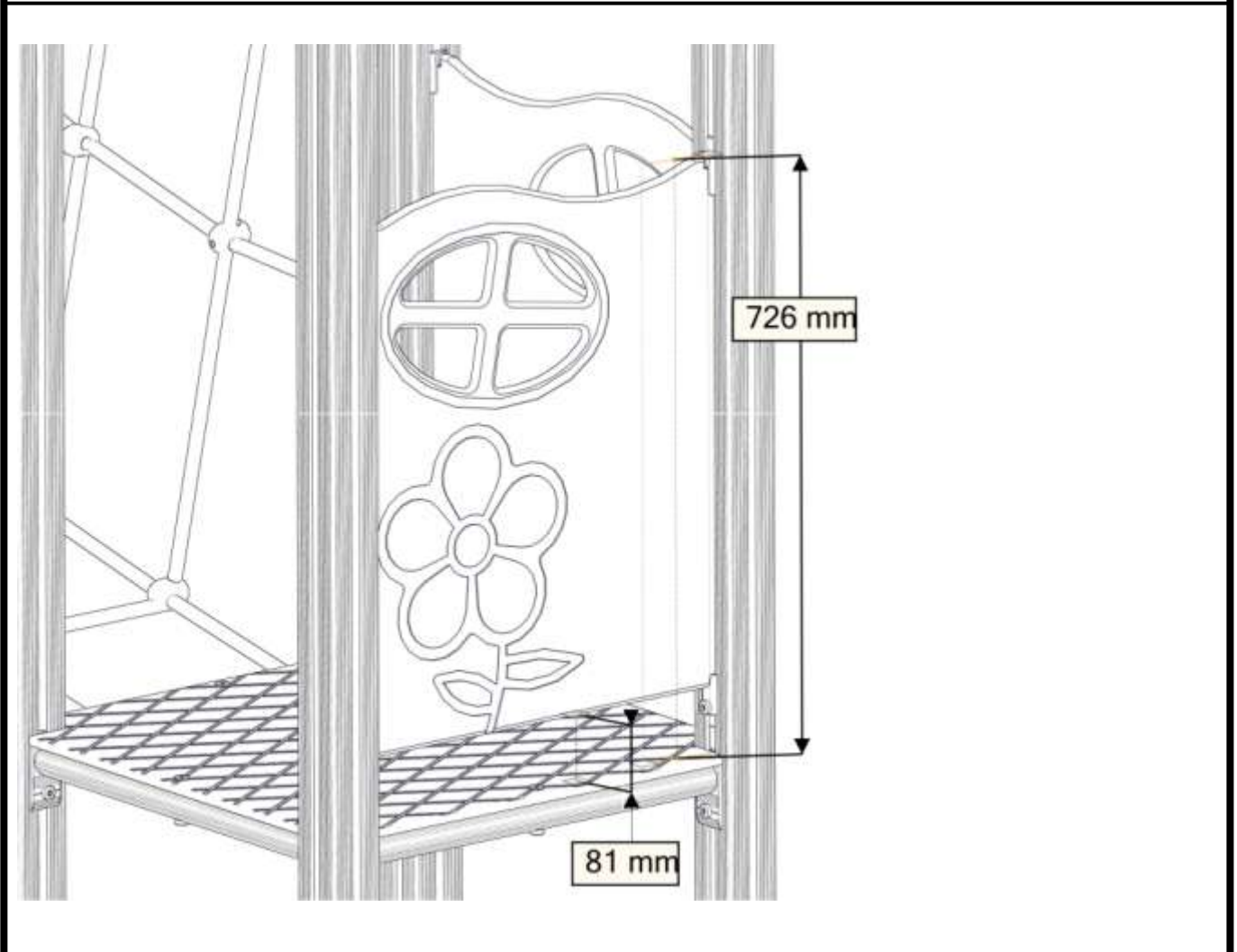
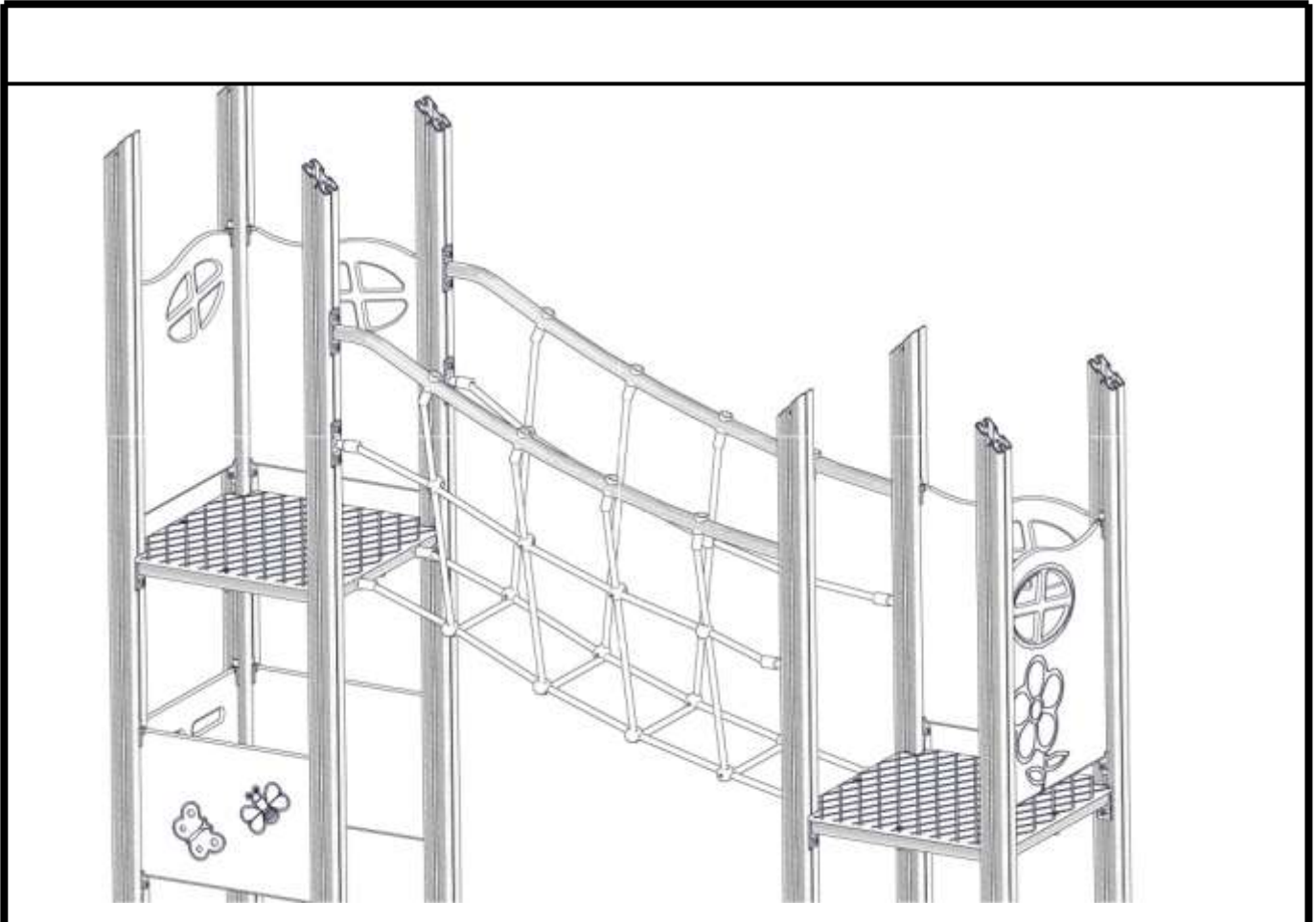

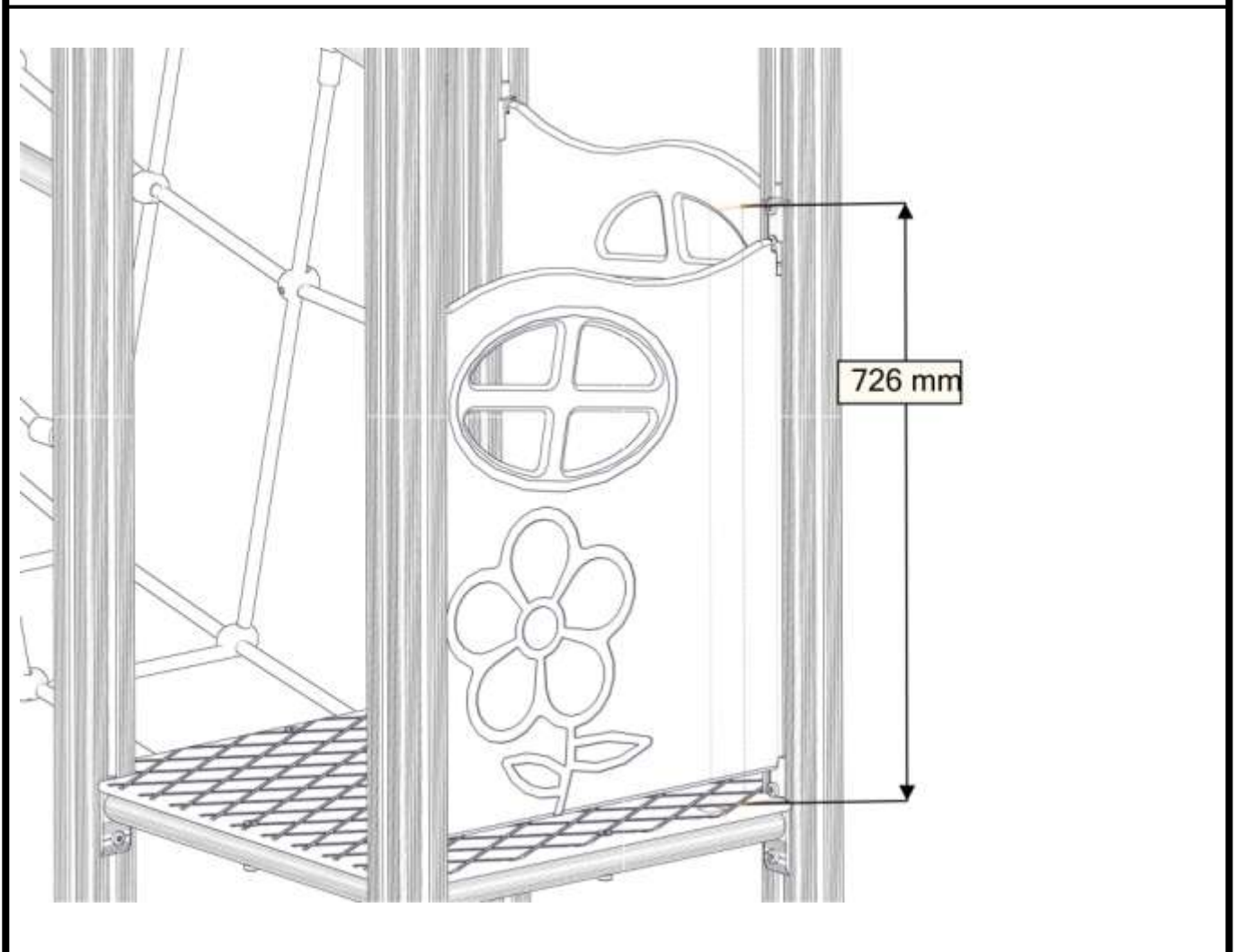
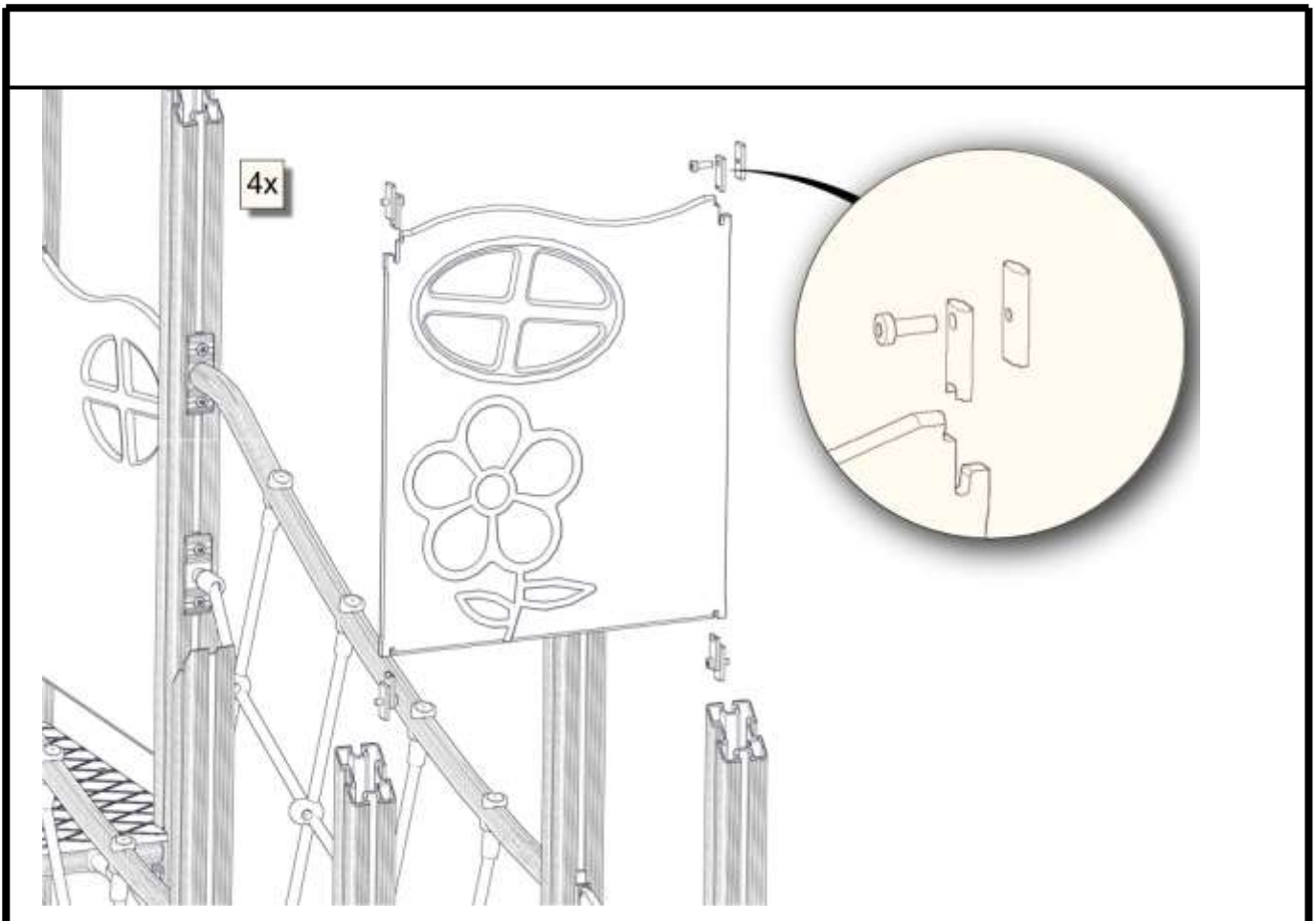

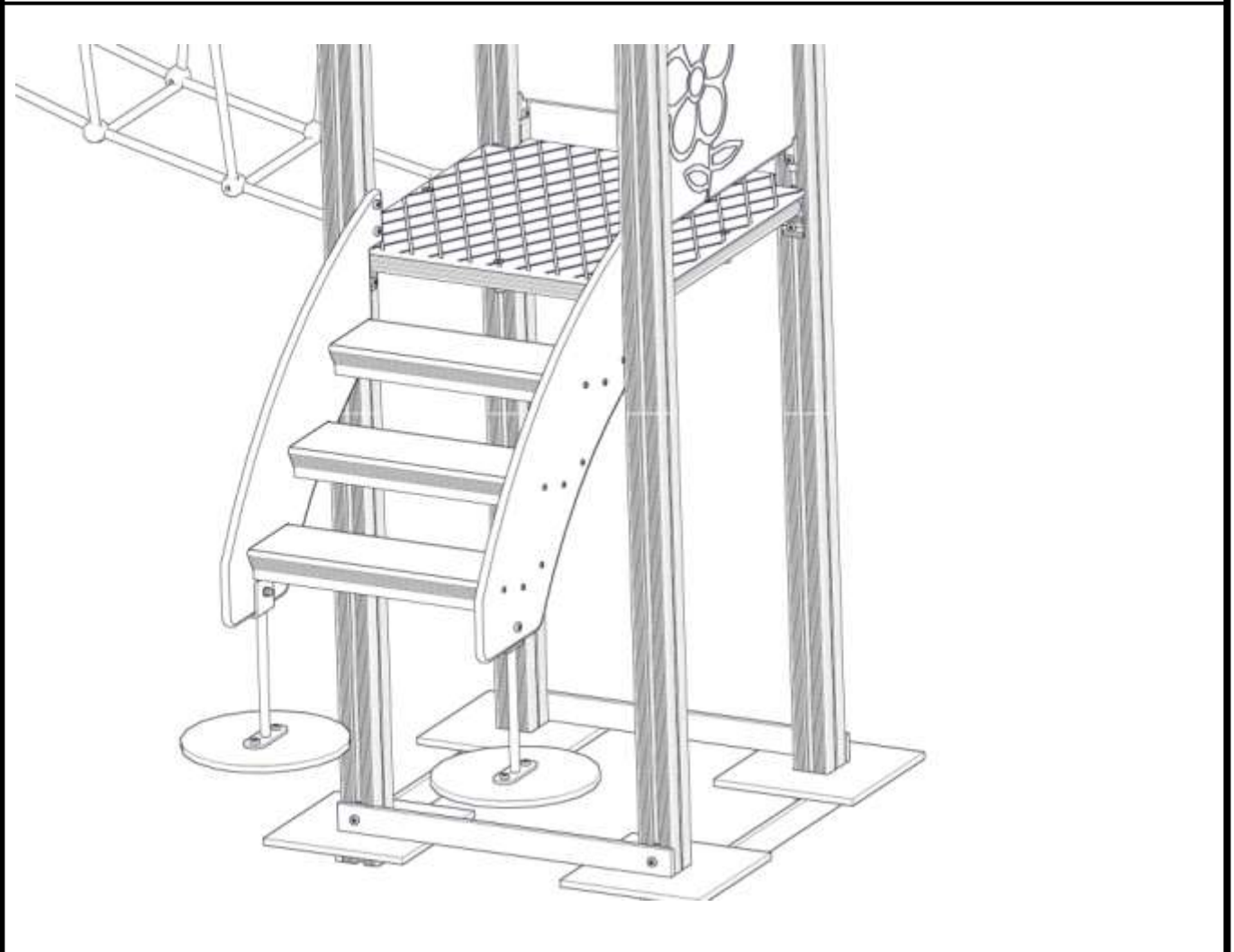
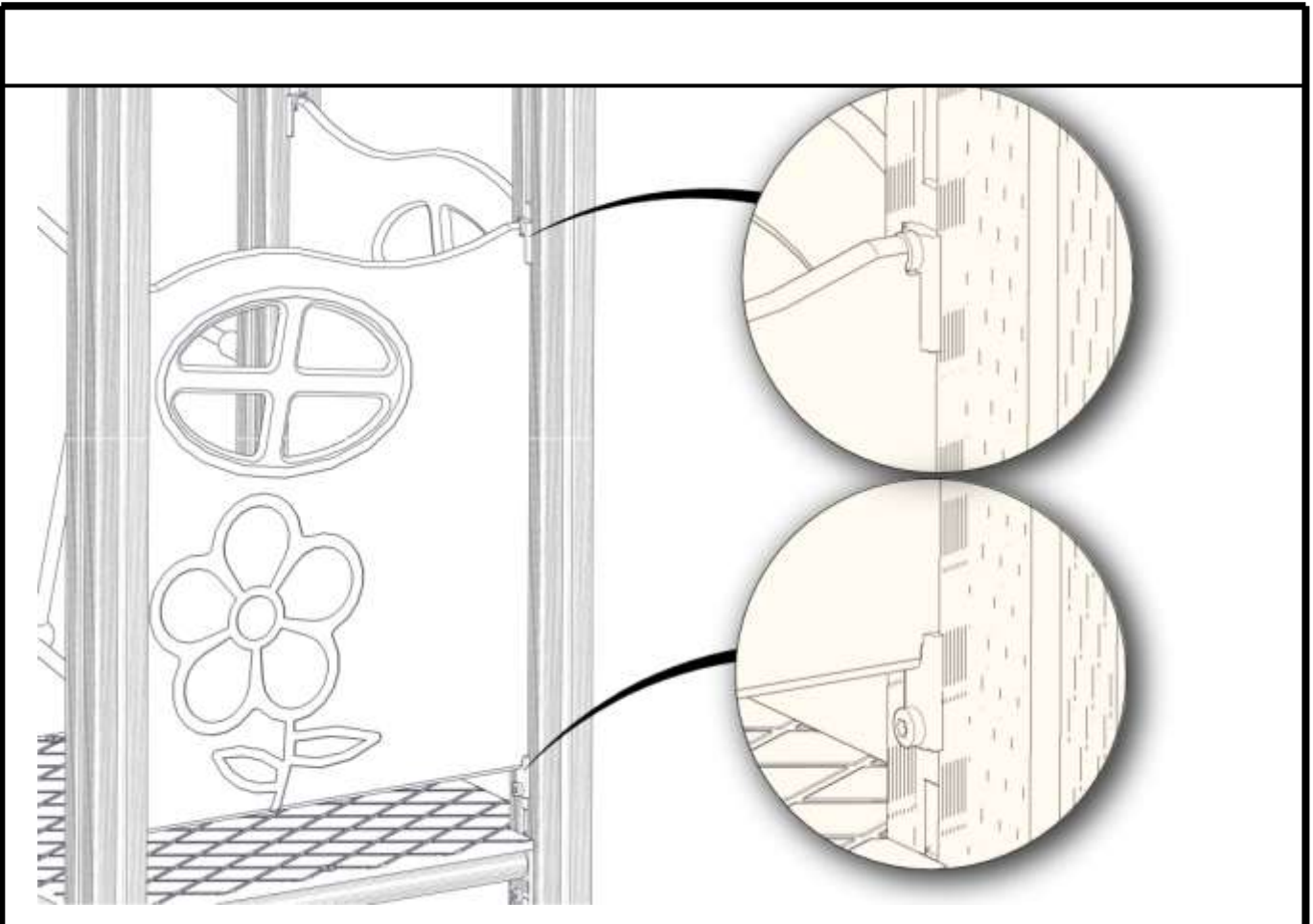

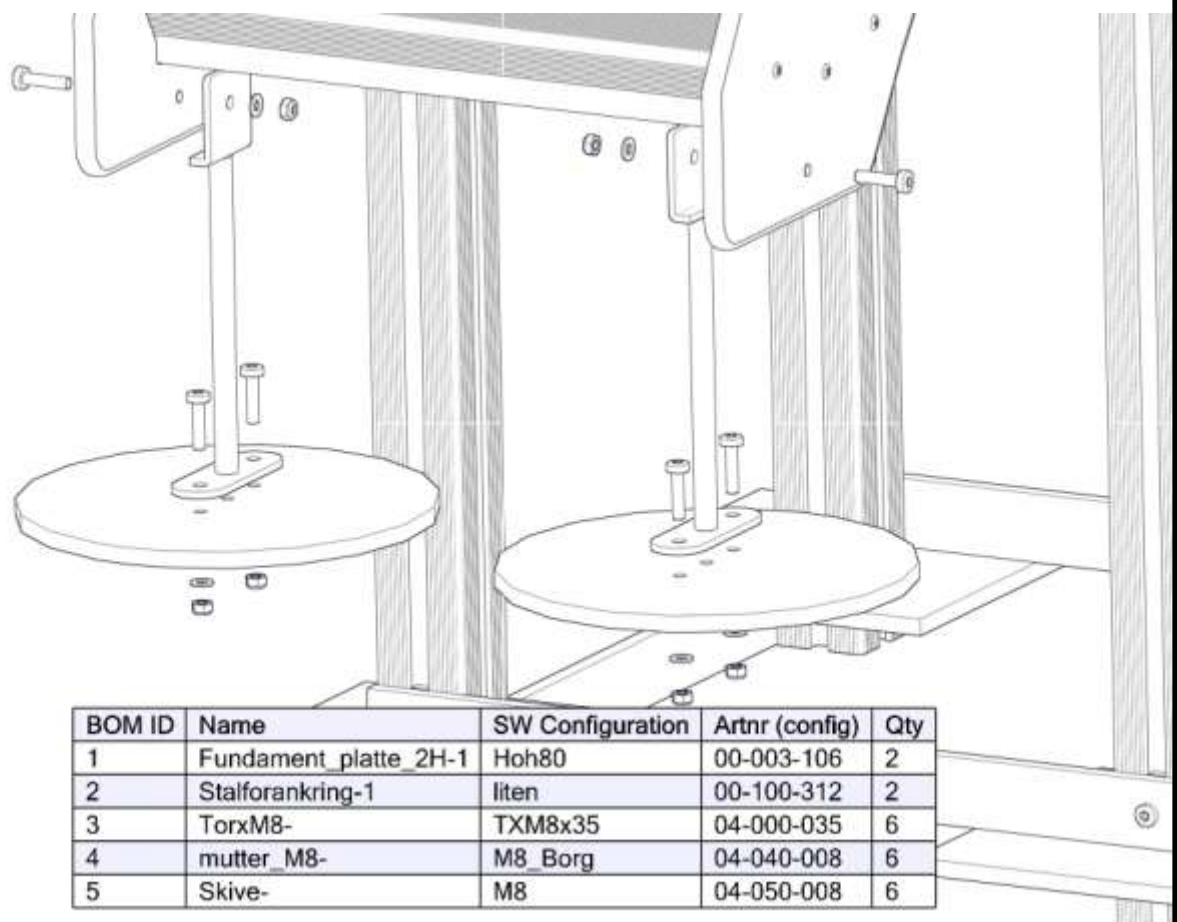
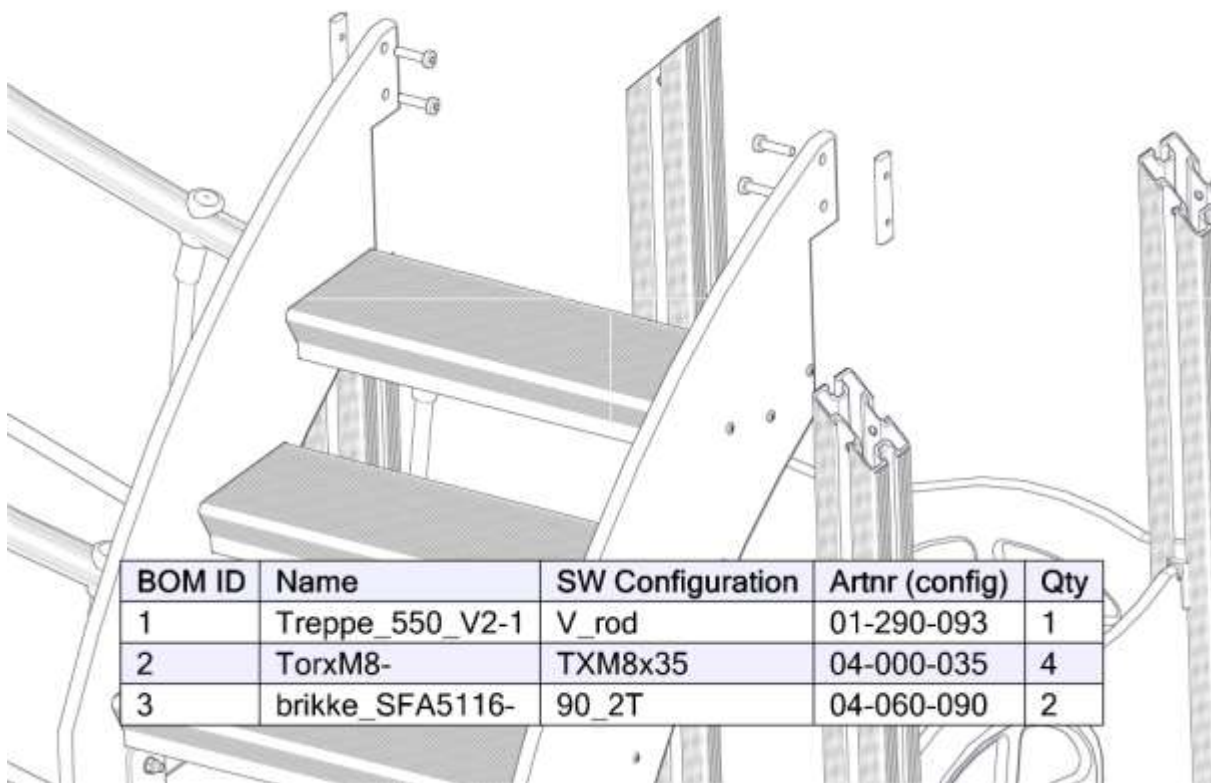

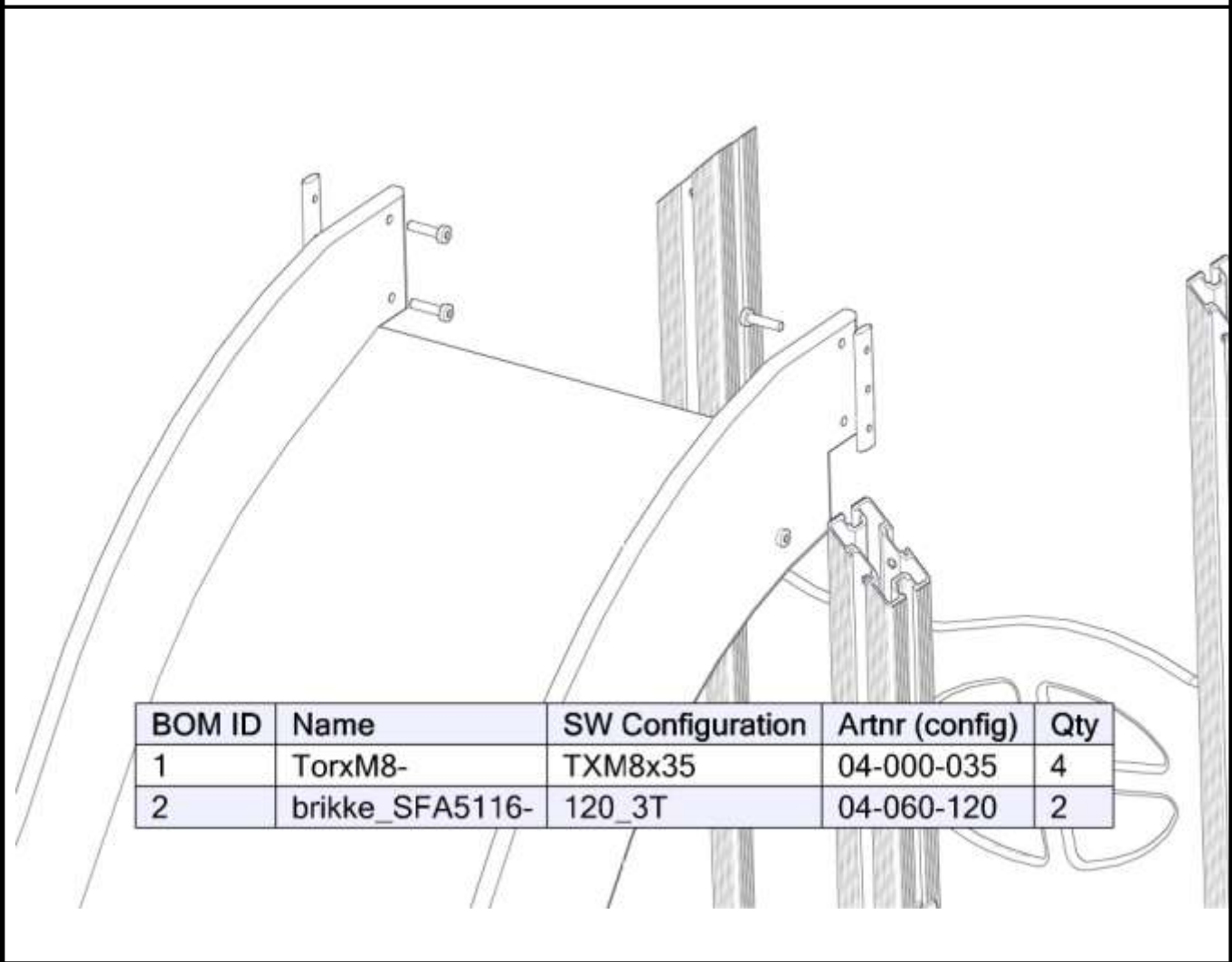
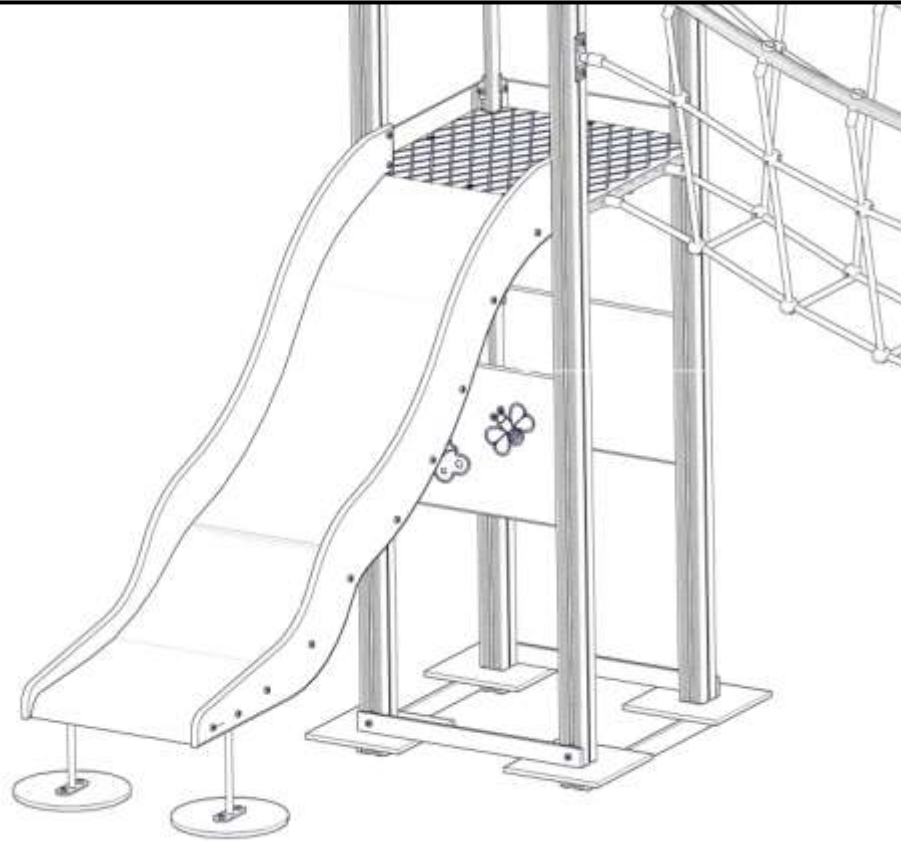

BOM ID	Name	SW Configuration	Artnr (config)	Qty
1	TorxM8-	TXM8x35	04-000-035	4
2	brikke_SFA5116-	120_3T	04-060-120	2

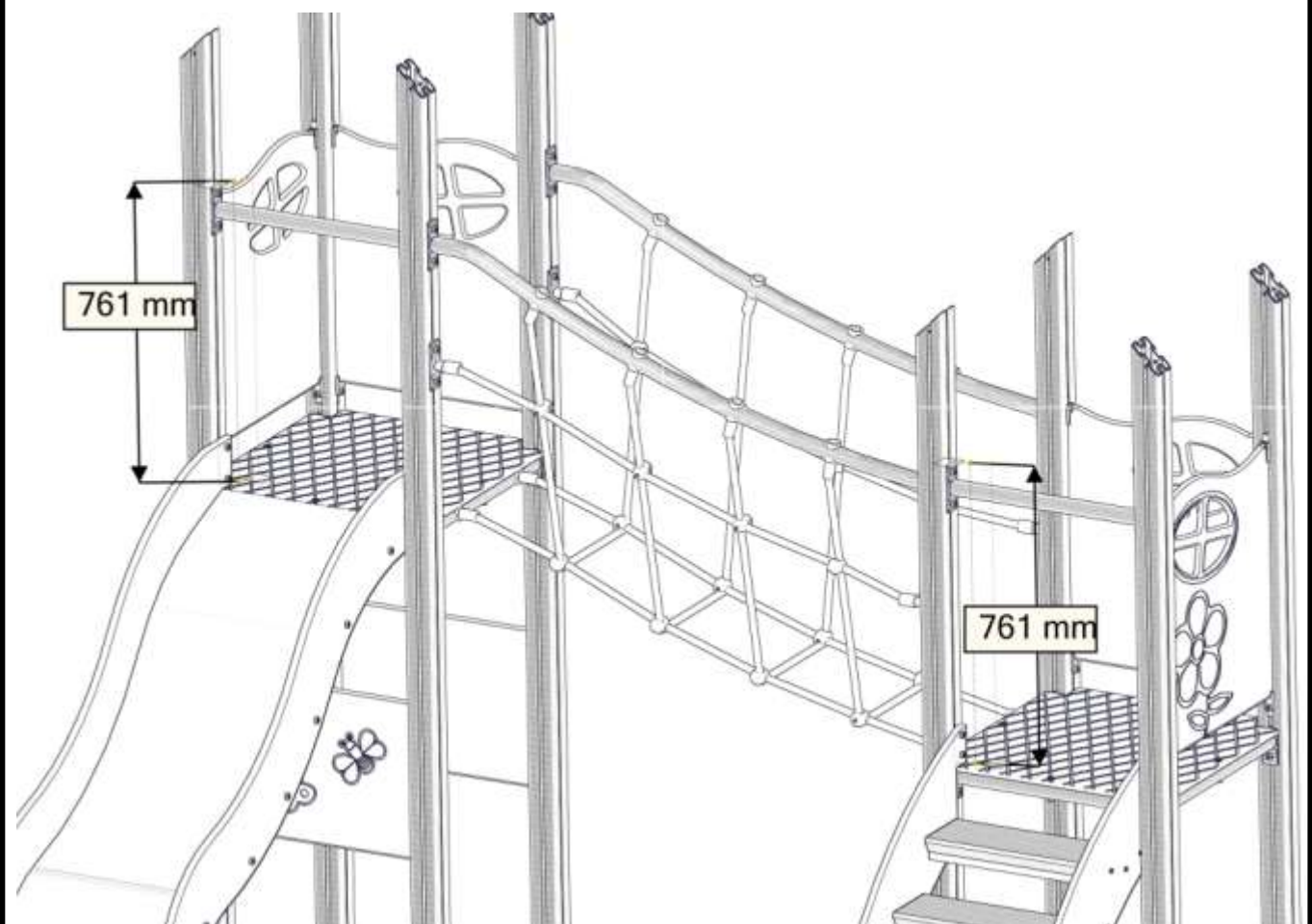
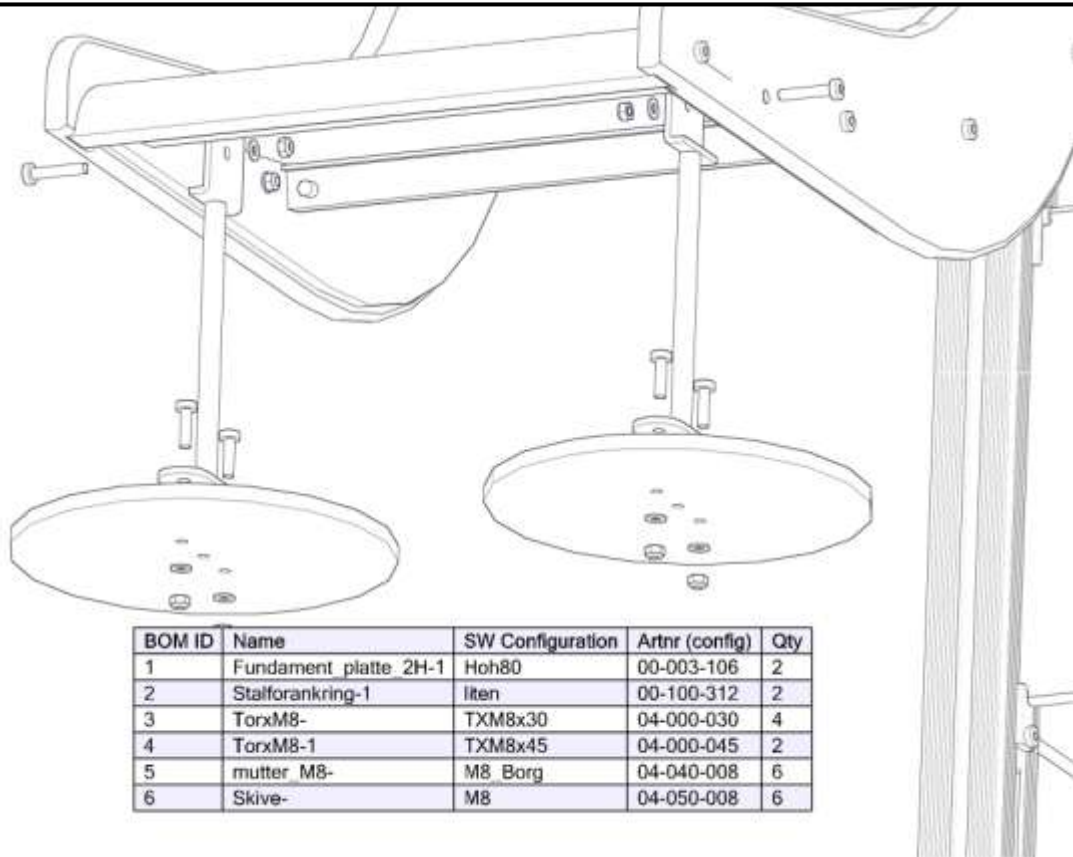

2x

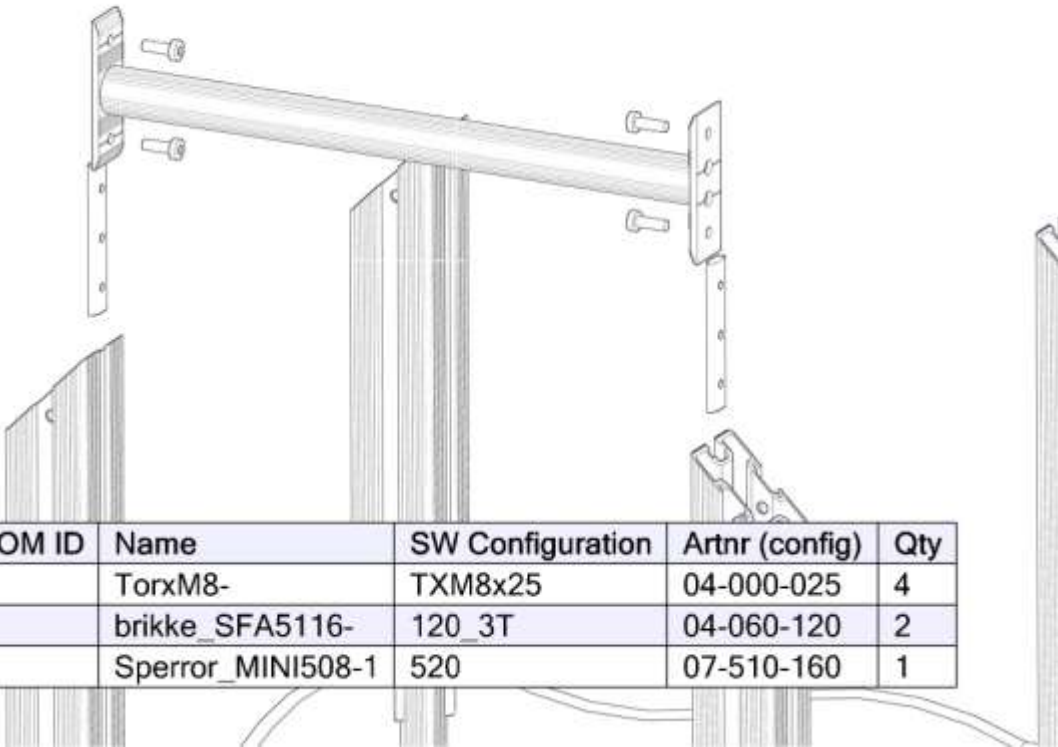

BOM ID	Name	SW Configuration	Artnr (config)	Qty
1	TorxM8-	TXM8x25	04-000-025	4
2	brikke_SFA5116-	120_3T	04-060-120	2
3	Sperror_MINI508-1	520	07-510-160	1

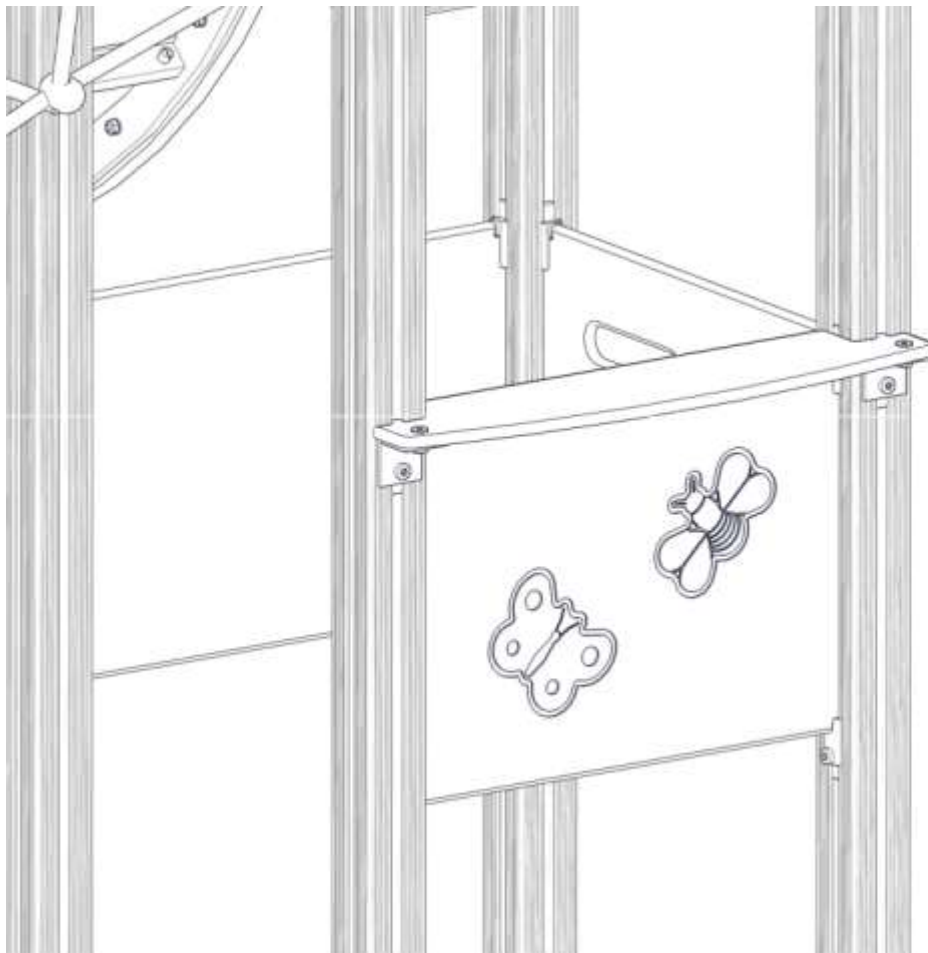

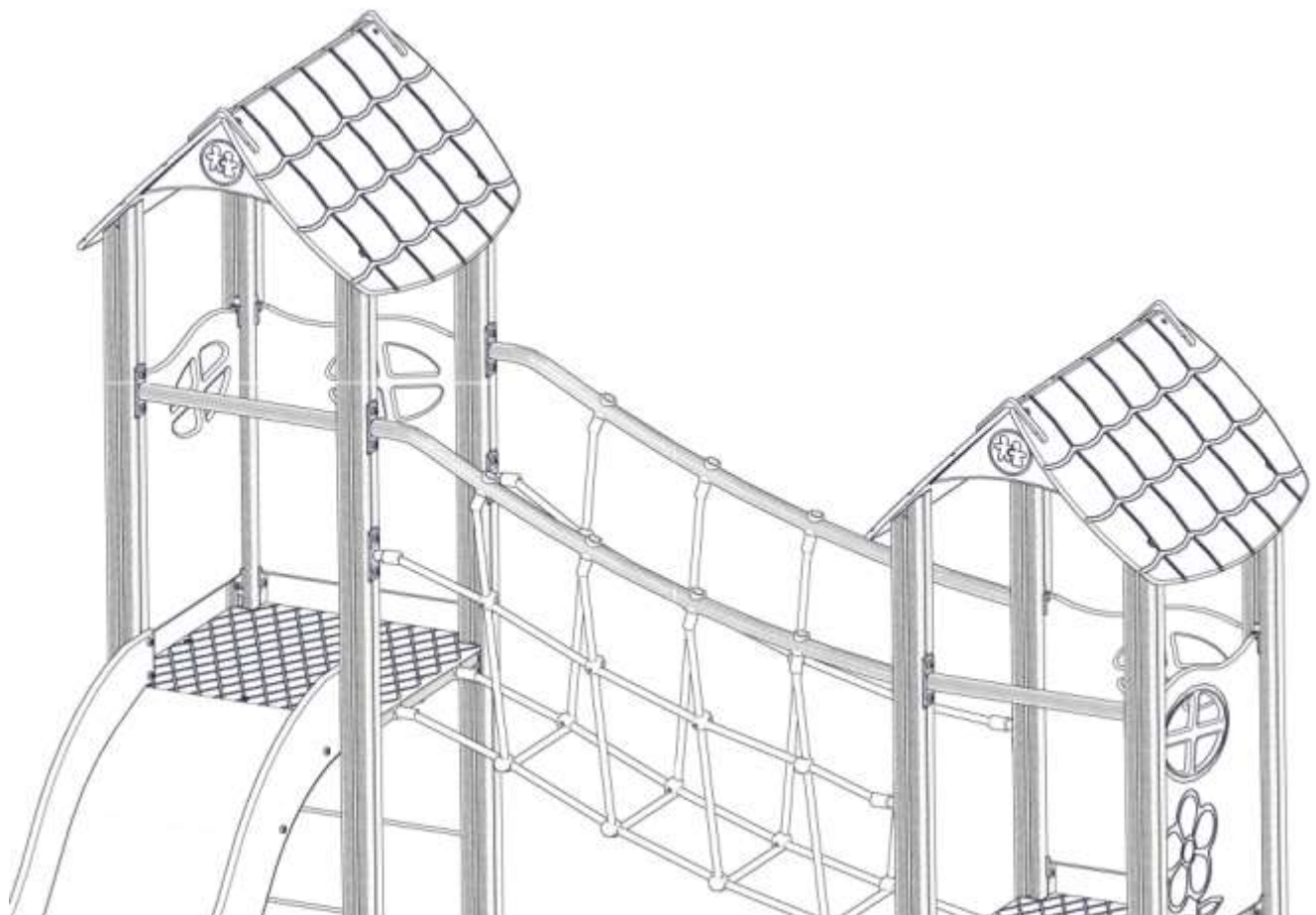
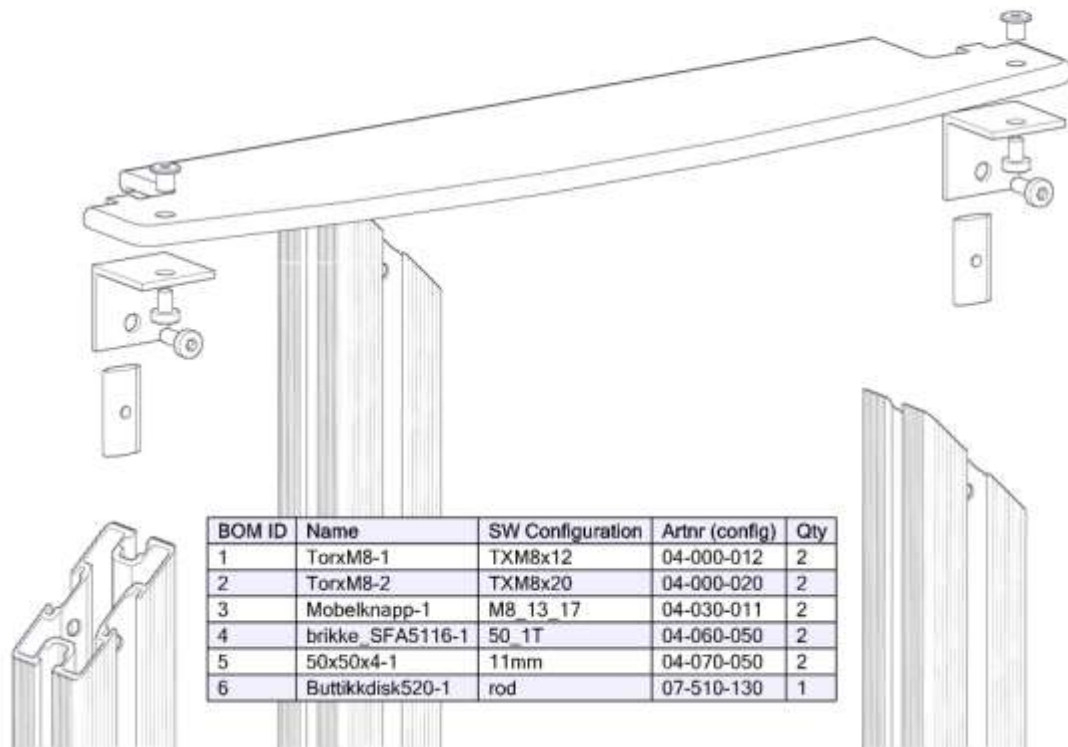

2x

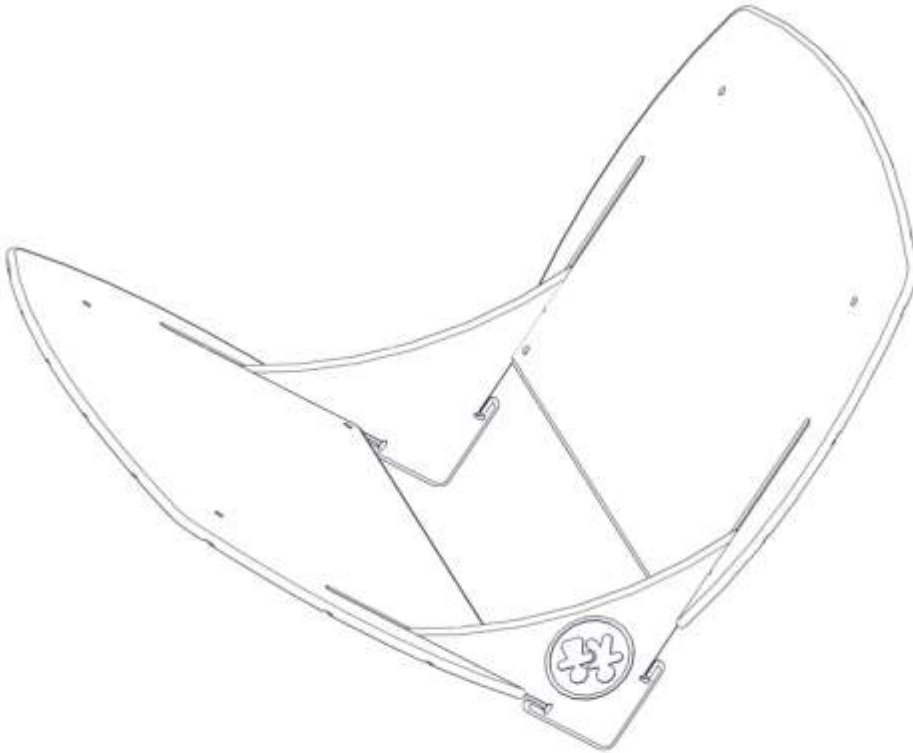

4x

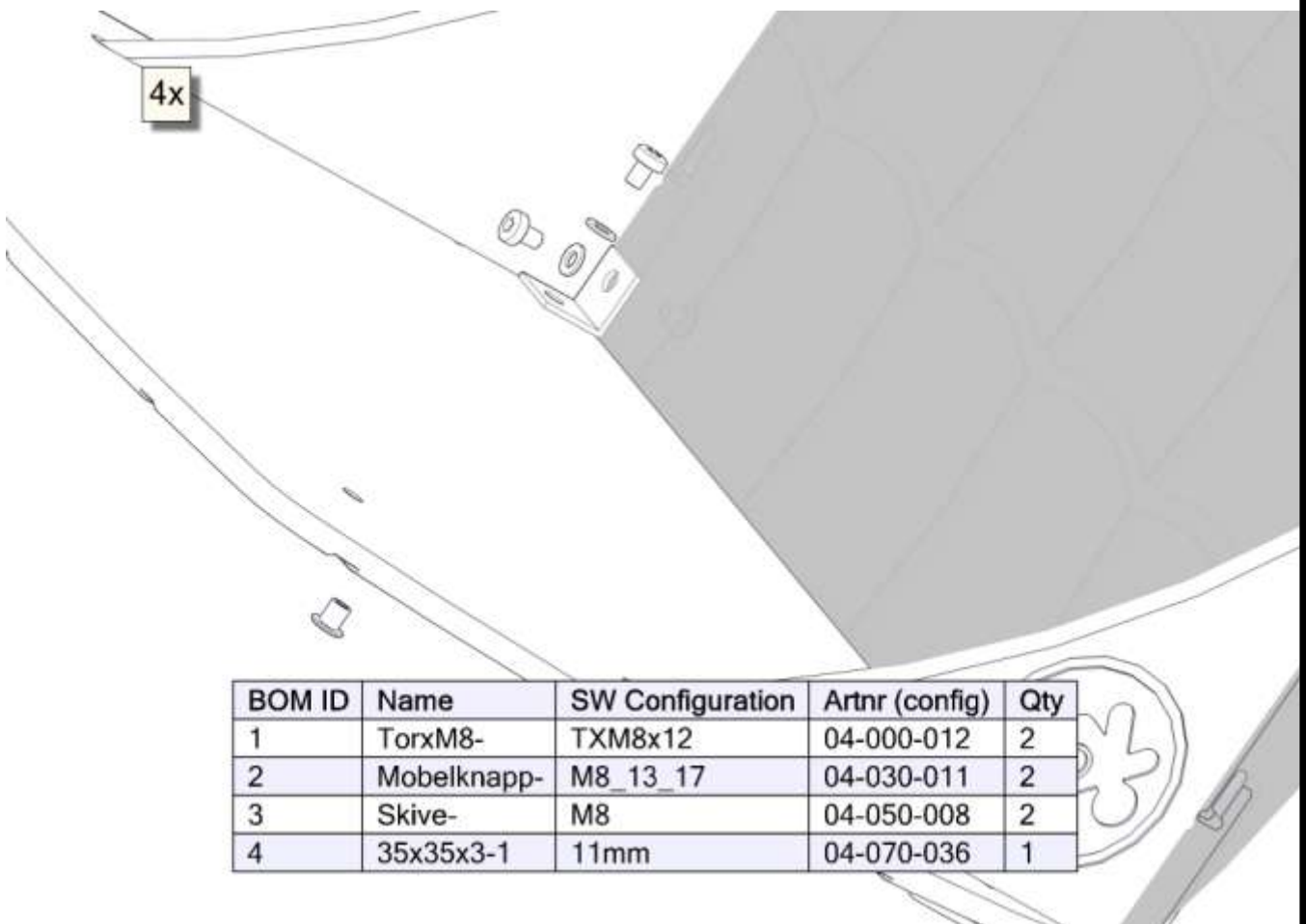

BOM ID	Name	SW Configuration	Artnr (config)	Qty
1	TorxM8-	TXM8x12	04-000-012	2
2	Mobelknapp-	M8_13_17	04-030-011	2
3	Skive-	M8	04-050-008	2
4	35x35x3-1	11mm	04-070-036	1

2x

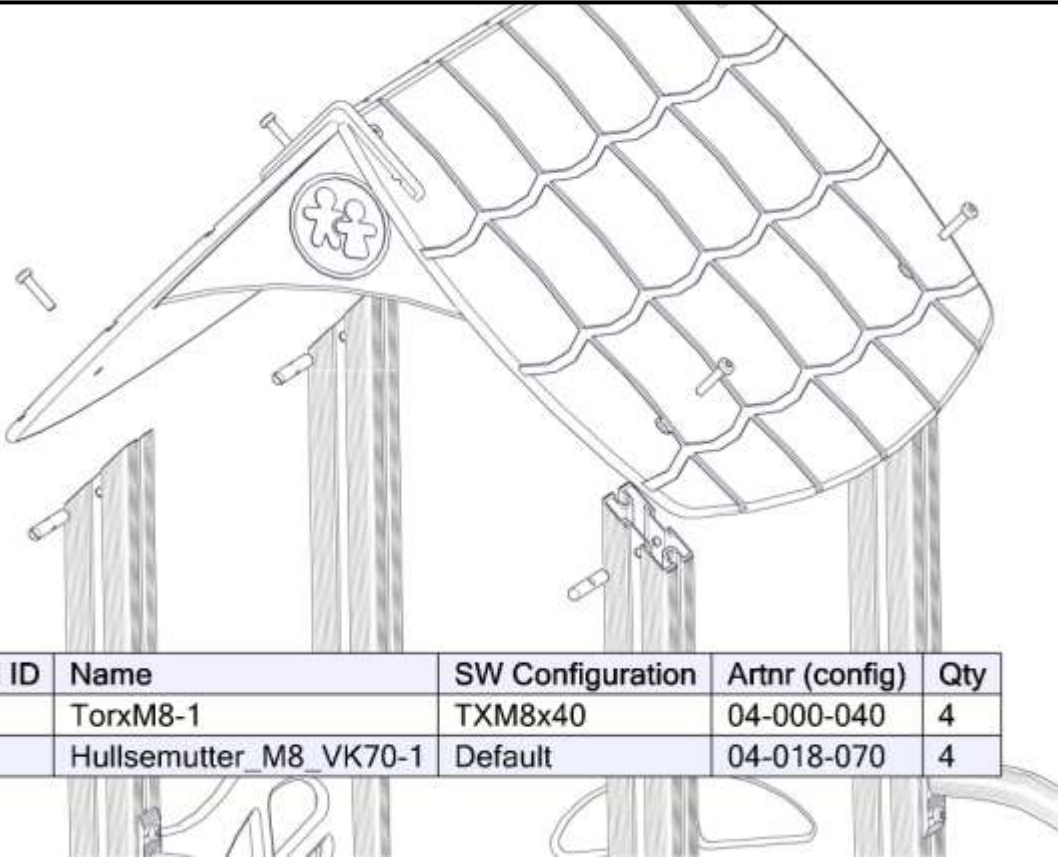

BOM ID	Name	SW Configuration	Artnr (config)	Qty
1	Torxm8-1	TXM8x40	04-000-040	4
2	Hullsemutter_M8_VK70-1	Default	04-018-070	4

Før utstyret tas i bruk / Before play begins / Innan lekredskapet tas i bruk	
N	<ul style="list-style-type: none"> • Påse at fallunderlag er utlagt i henhold til gjeldende regler eller vår anbefaling • Fjern alle monteringshjelpemidler (rester av betong, planker, paller, plast, og lignende) • Før utstyret tas i bruk, burde man sjekke at det ikke er fare for at anorakksnorer og lignende som kan hekte seg fast noen steder på lekeapparatet. (Vedlagte snor med dobbe (kneledd) kan brukes til å sjekke at dette er i orden. Se vedlagte veiledning for bruk av denne. Dette gjøres for å oppdage eventuelle feilmonteringer.?) • NB! Bør stå i 2-3 dager før bruk
UK	<ul style="list-style-type: none"> • Make sure the area and depth of safer surfacing are according to the current standard, or to the manufacturer's recommendation • Make sure all tools and surplus materials are removed before play begins • PS! When complete, allow 2-3 days for the concrete to set before use
S	<ul style="list-style-type: none"> • Kontrollera att fallunderlag är utlagt enligt gällande regler eller vårt rekomenation • Ta bort alla monteringshjälpmedel (rester av betong, plankor, pallar, plast och liknande) • Innan lekredskapet används, kontrollera att anoracksnoddar eller kläder/delar av kläder eller liknande inte kan fastna i några delar på redskapet. (Den bipackade "knävringen" kan man med fördel användas för denna kontroll. • Detta görs för att upptäcka eventuella felmonteringar.)