

N

Monteringsanvisning

EN

Assembly Instructions

S

Monteringsanvisning

Produkt nr. / Product no. / Produkt nr.

**25-200-151**

Ord. nr. \_\_\_\_\_

Dato. \_\_\_\_\_

Sign. \_\_\_\_\_

**sove**

Søve AS  
3830 Ulefoss - Norway  
Tlf: +47 35 94 65 65  
[www.sove.no](http://www.sove.no)



Søve AB  
EA Rosengrensgatan 32  
421 31 Västra Frölunda  
Phone: +46 (0)31 773 97 00  
[www.sove.se](http://www.sove.se)

## Monteringstips / Assembly Advice / Monteringsstips

**N**

- Les monteringsanvisningen nøye før montering.
- Monter elementene i rekkefølgen som vist.
- Boltene bør ikke skrues for hardt til før alt er montert, vatret og loddet. Skru så boltene til.
- NB! Ved bruk av drill, kan boltene ryke.
- På grunn av at solen kan gjøre rutsjeplaten veldig varm, bør rutsjebanens utløp vende mot nord-øst eller nord-vest.
- Er lekeutstyret plassert i naturlige ferdselstraséer må området sikres mot gjennomgang.
- Innspringningshinder bør vurderes rundt lekeapparater hvor det er stor bevegelse, f.eks. ved huskestativ.
- Det bør være fritt innsyn til lekeutstyr som er beregnet for barn under 3 år.

**NB! Under monteringsarbeidet må utstyr, som ikke er forankret forsvarlig i bakken, sikres slik at det ikke velte.**

**Området må avstenges under montering av apparatene med sperrebånd eller lignende.**

**EN**

- Read the instruction carefully before assembling the play unit..
- Assemble the components in the sequence shown in these instructions.
- Fixings must not be fully tightened during assembly. Before casting the foundations, the structure must be level and plumb, at which point all fixings are tightened.
- PS! If use of drill, the bolts may be wrecked.
- Avoid positioning the slide facing due south because of overheating – ideal positions are facing north-east or north-west.
- Secure the construction-area to prevent people from walking through it.
- Consider installing barriers around play-equipment which gives rise to a lot of activity – i.e.swings.
- Ensure that clear vision is possible across the play area so that supervision is possible from any position, particularly where children under 3 years of age will be playing.

**NB! During assembly of the equipment, ensure that all structures are securely propped, especially when left overnight. Also ensure that equipment is supported whilst concrete foundations are setting and enclose the area securely to prevent access.**

## Monteringstips / Assembly Advice / Monteringsstips

**S**

- Läs monteringsanvisningen noga före montering.
- Montera delarna i den ordningen som anvisas
- Skruvarna bör inte skruvas för hårt tills allt är monterat, i våg och lodat.











**OBS!** Används elektrisk skruvdragare, kan bulten gå sönder. Hårdra därför manuellt!

- Solen kan göra att rutchbanan blir väldigt varm. Banans nedfart rekommenderas att vändas i norrlig riktning
- Om lekplatsen placeras vid en gångväg mm bör området säkras mot genomfart av gående och cyklister.
- Inspjängningshinder bör placeras runt lekutrustning med stor rörelse, t ex, gungställning.
- Det bör vara fri insyn till lekutrustning beräknat till barn under 3 år.

**OBS!** Under monteringsarbete bör utrustningen som inte ska förankras i marken, ställs så att den inte kan välta.

Området måste spärras när lekutrustningen byggs upp, med avspärningsband eller liknande.

**Nødvendig verktøy / Tools required / Nödvändiga verktyg**

<p>(N)</p> <p>(EN)</p> <p>(S)</p>	<p>(A)</p> 	<p>(B)</p>  <p>Torx Nr 45 High quality</p>	<p>(C)</p> <p>5 mm 6 mm</p> 	<p>(D)</p> 	<p>(E)</p> 
		<p>Metermål Metric measure Tumstock</p> 	<p>16 V</p> 	<p>Merkebånd Mark ribbon Märkeband</p> 	<p>13 + 17mm</p> 

**Nødvendig antall personer / Number of persons required / Rekommenderad antal personer**

<p>(N)</p> <p>(EN)</p> <p>(S)</p>	
-----------------------------------	---

**Anbefalt arealbehov ved montering / Recommended working space / Rekommenderad arealbehov ved montering**

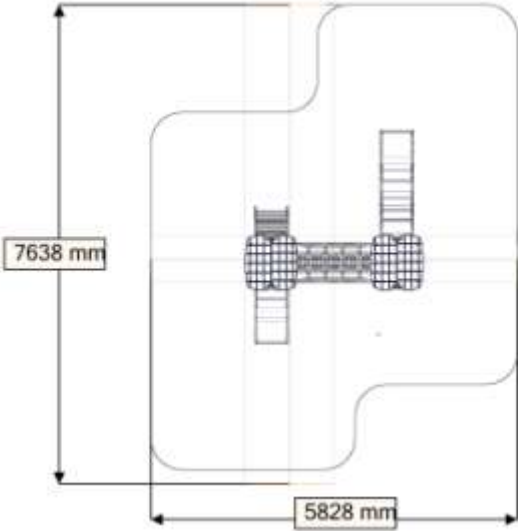
<p>(N)</p> <p>(EN)</p> <p>(S)</p>	
-----------------------------------	--

**Fallhøyder / Free height of fall / Fallhöjder**

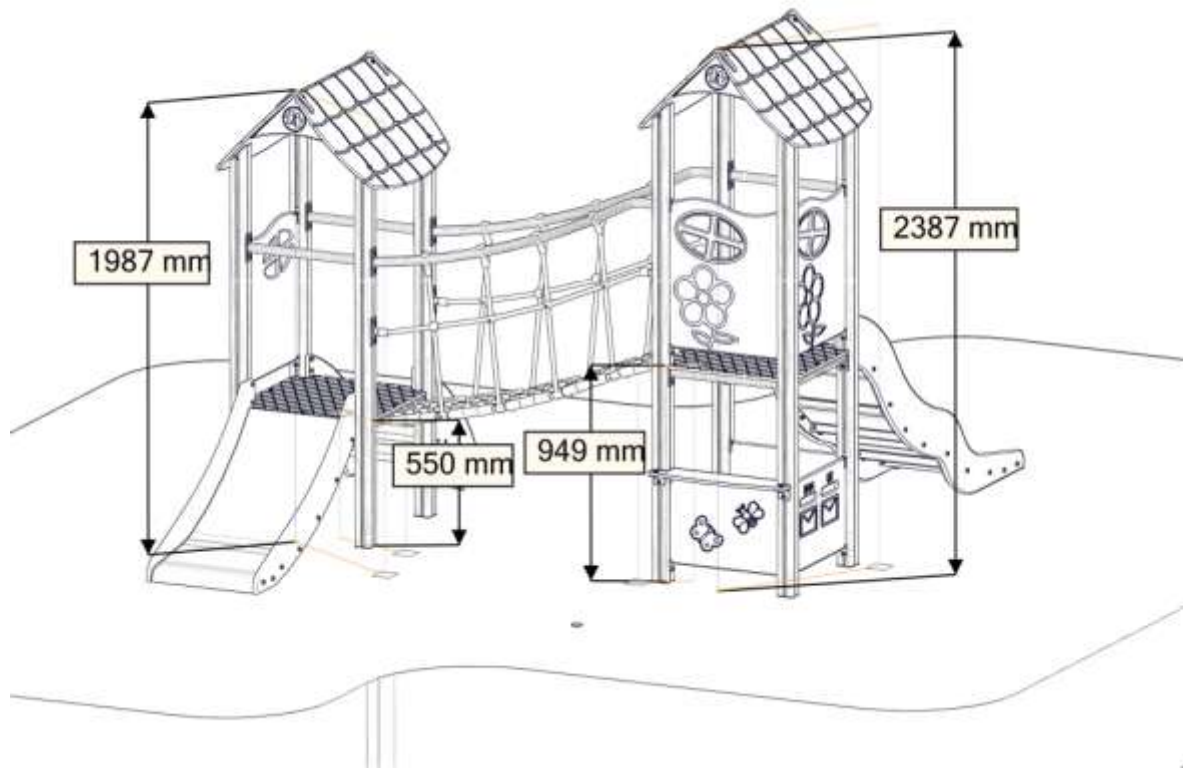

**Sikkerhetszone / Safety zone / Säkerhetszon**

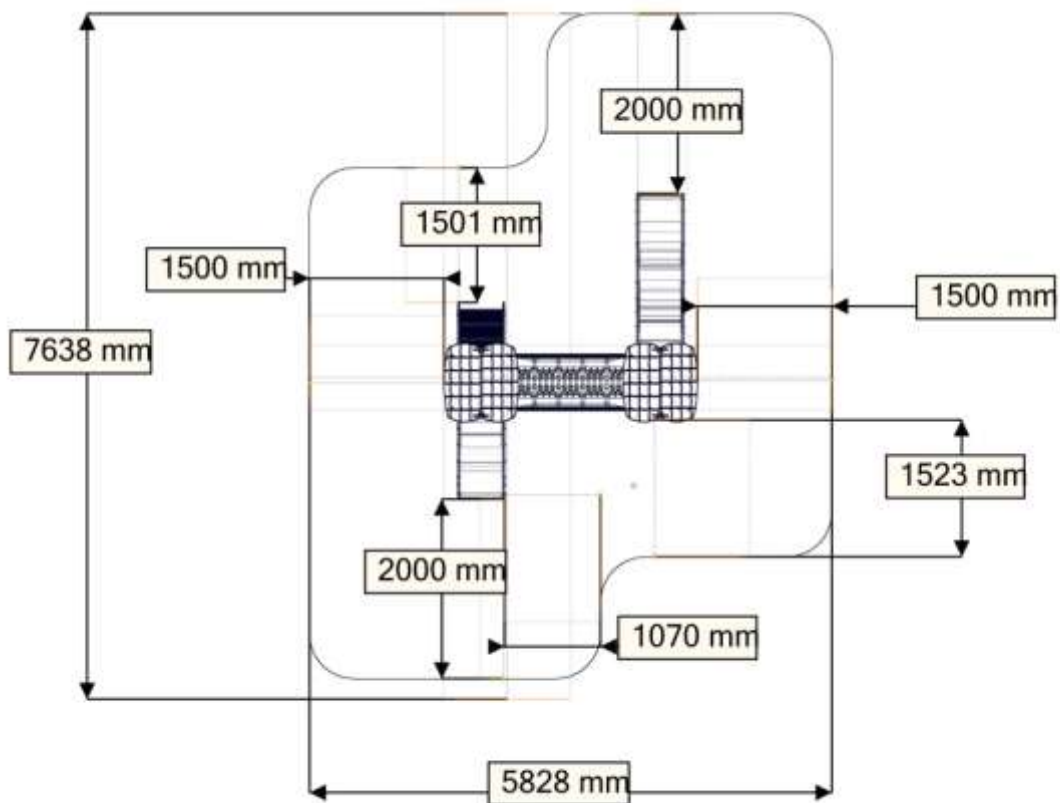

**Plassering av forankringer / Ground plan / Placering av förankringar**

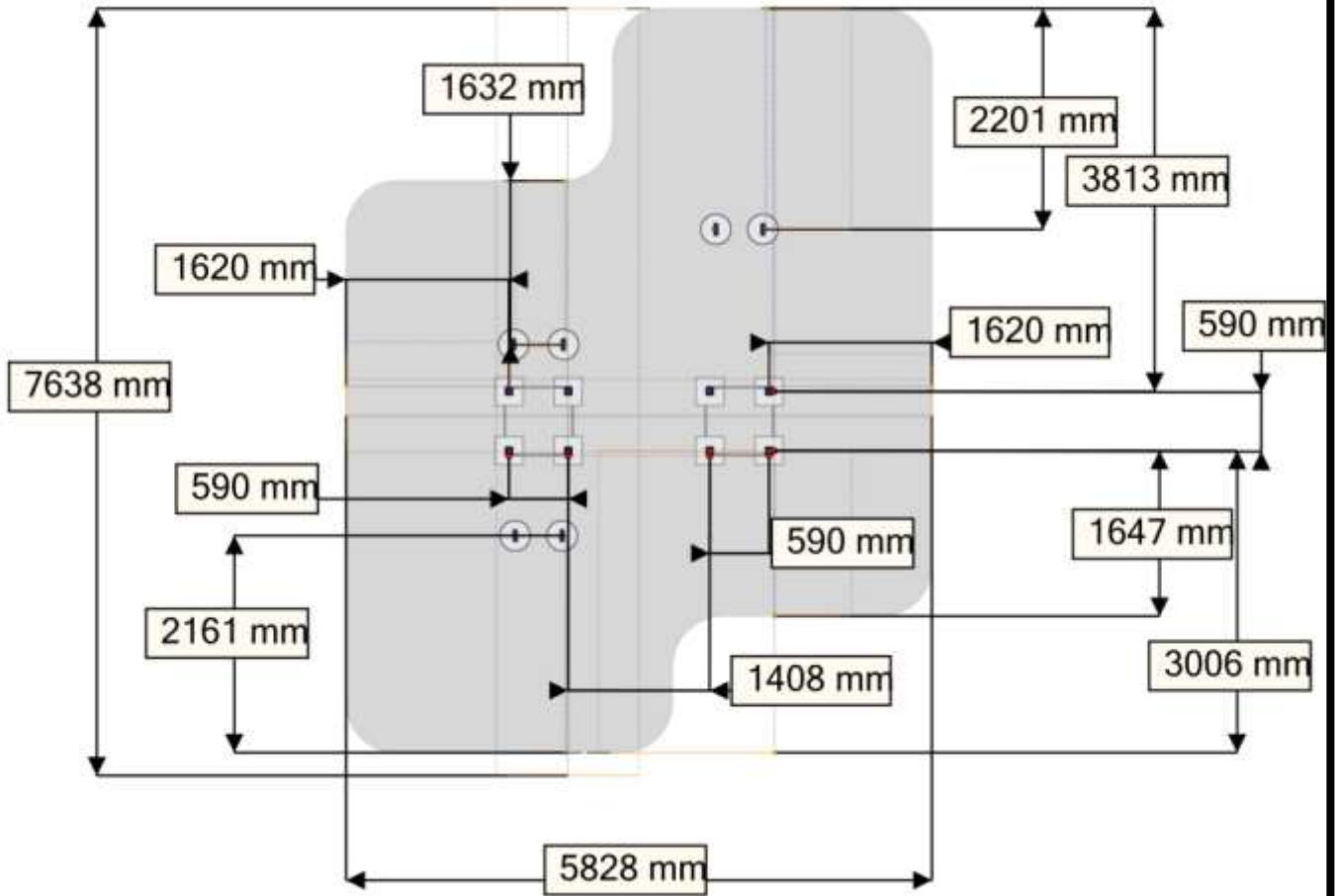

N

Alle mål er oppgitt i millimeter

EN

Scale measured in mm

S

Alla mått är i millimeter.

**Fundamentering uten betong / Foundation without concrete / Förankring utan betong**

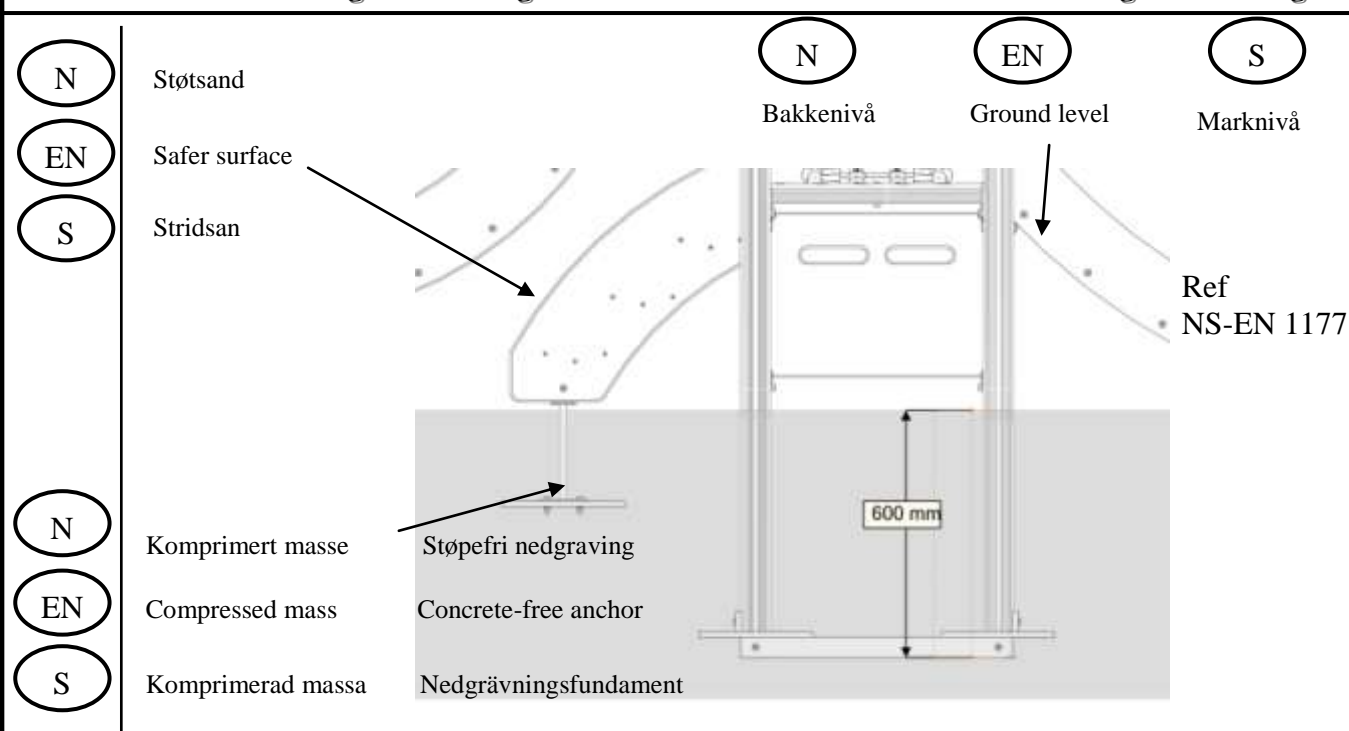



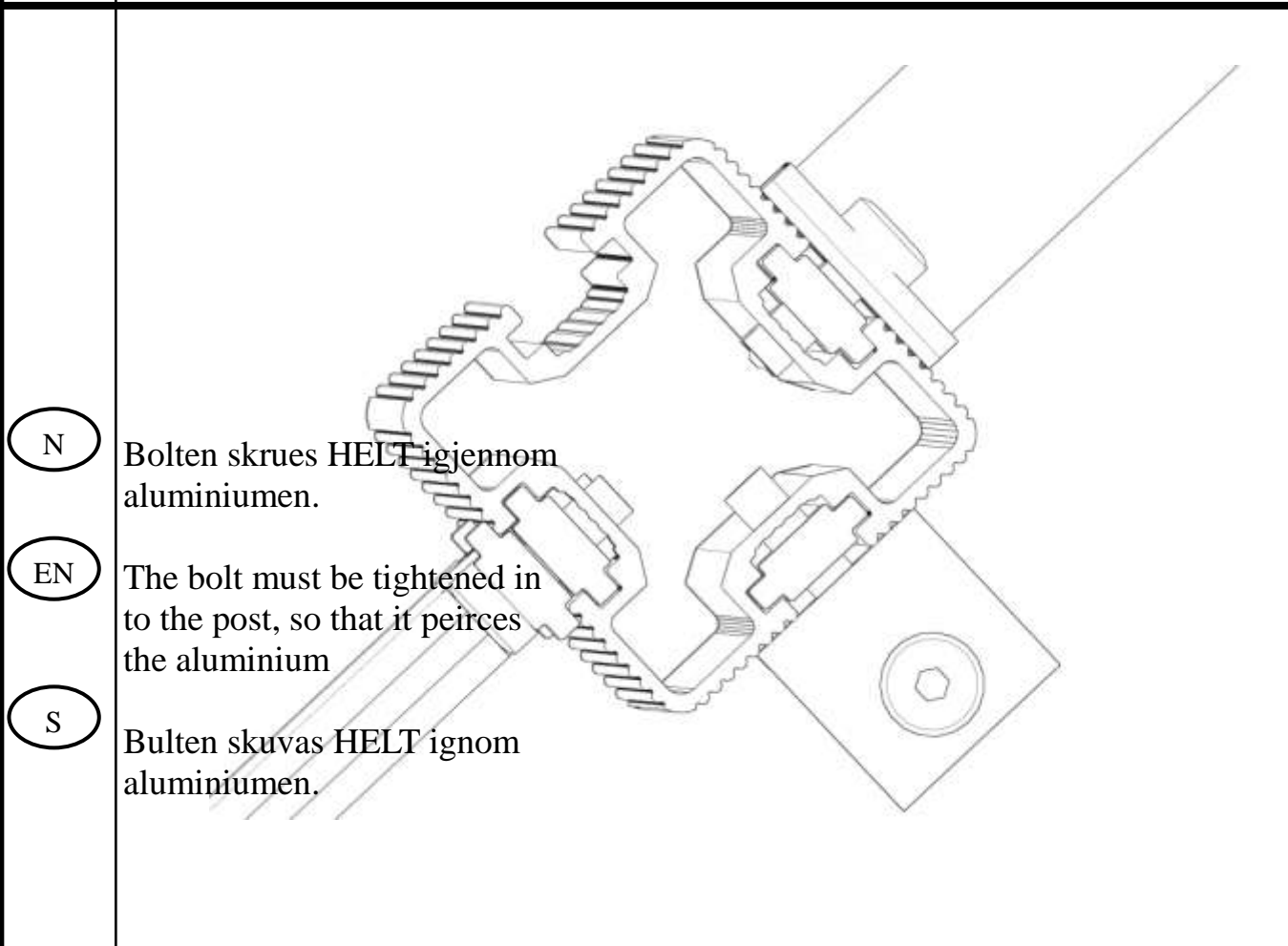







(N)	Alle mål er oppgitt i millimeter
(EN)	Scale measured in mm
(S)	Alla mått är i millimeter.



**Boltepakker for / Boltpackage for / Bultpaket för**

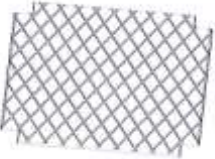
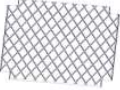













Sign. \_\_\_\_\_

<b>Stolpe 70x70 skrå</b>	<b>Ant= 8</b>	<b>Navn</b>	<b>Artnr/dimensjon</b>	<b>Ant</b>	<b>Lev</b>
		VK70 2100-600 (1) Skrå VK70 1700-600(1) Brikke på stolpe!	07-510-158	4	
		Torx M8x40 (1)	04-000-040	8	
		Hullsemutter (1) VK70	04-018-070	8	
<b>FundamentMini 660</b>	<b>Ant= 8</b>	<b>Navn</b>	<b>Artnr/dimensjon</b>	<b>Ant</b>	<b>Lev</b>
		miniSprosse 660 (1)	07-510-200	8	
		Brikke 50_1T (2)	04-060-050	16	
		Torx M8x35 (2)	04-000-035	16	
<b>FundamentSkive</b>	<b>Ant= 8</b>	<b>Navn</b>	<b>Artnr/dimensjon</b>	<b>Ant</b>	<b>Lev</b>
		Skive (1) 275x275x12	07-510-201	8	
<b>Gulv mini</b>	<b>Ant= 2</b>	<b>Navn</b>	<b>Artnr/dimensjon</b>	<b>Ant</b>	<b>Lev</b>
		Gulv Mini 520(1)	07-510-102	2	
		Møbelknapp (4)	04-030-011	8	
		Torx M8x45 (4)	04-000-045	8	



**Boltepakker for / Boltpackage for / Bultpaket för**

Sign. \_\_\_\_\_

<b>Vegge 520x600 Vindo bloms</b>	<b>Ant= 2</b>	<b>Navn</b>	<b>Artnr/dimensjon</b>	<b>Ant</b>	<b>Lev</b>
		Vegge520x600 (1) Vindu blom	07-510-120	2	
		Brikkespesial(4)	04-060-051	8	
		Brikke(4)	04-060-050	8	
		Torx M8x25(4)	04-000-025	8	
<b>Vegge 520x600 Vindo Bi</b>	<b>Ant= 1</b>	<b>Navn</b>	<b>Artnr/dimensjon</b>	<b>Ant</b>	<b>Lev</b>
		Vegge520x600 (1) Vindu bi/ Sommerfulg	07-510-120	1	
		Brikkespesial(4)	04-060-051	4	
		Brikke(4)	04-060-050	4	
		Torx M8x25(4)	04-000-025	4	
<b>Vegge 520x400 Sommerfugl / bie</b>	<b>Ant= 2</b>	<b>Navn</b>	<b>Artnr/dimensjon</b>	<b>Ant</b>	<b>Lev</b>
		Vegge520x400 (1) Sommerfugl/bi	07-510-110	2	
		Brikkespesial(4)	04-060-051	8	
		Brikke(4)	04-060-050	8	
		Torx M8x25(4)	04-000-025	8	











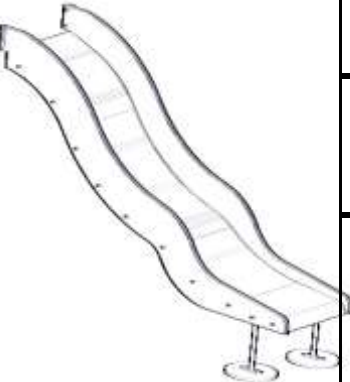

**Boltepakker for / Boltpackage for / Bultpaket för**

Sign. \_\_\_\_\_.

<b>Sperrerør 520</b>	<b>Ant= 3</b>	<b>Navn</b>	<b>Artnr/dimensjon</b>	<b>Ant</b>	<b>Lev</b>
		Sperrerør 520 (1)	07-510-160	3	
		Brikke 120_3T (2)	04-060-120	6	
		Torx M8x25 (4)	04-000-025	12	
<b>Sperrerør 520 gulv</b>	<b>Ant= 6</b>	<b>Navn</b>	<b>Artnr/dimensjon</b>	<b>Ant</b>	<b>Lev</b>
		Sperrerør 520 (1)	07-510-161	6	
		Brikke 90_2T (2)	04-060-090	0 På stolpe	
		Torx M8x25 (2)	04-000-025	12	
<b>Sperrerør 520 gulv 4 hull 100</b>	<b>Ant= 2</b>	<b>Navn</b>	<b>Artnr/dimensjon</b>	<b>Ant</b>	<b>Lev</b>
		Sperrerør 520 (1) For brua	07-510-167	2	
		Brikke 90_2T (2)	04-060-090	0 På stolpe	
		Torx M8x25 (2)	04-000-025	4	

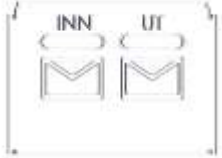







**Boltepakker for / Boltpackage for / Bultpaket för**

Sign. \_\_\_\_\_.

<b>Rutsjebane 950 07-510-310</b>	<b>Ant= 1</b>	<b>Navn</b>	<b>Artnr/dimensjon</b>	<b>Ant</b>	<b>Lev</b>
		Rutsjebane	07-510-310	1	
		Brikke120 3T(5)	04-060-120	2	
		Torx M8x35(4)	04-000-035	4	
		Torx M8x45(2)	04-000-045	2	
		Torzx M8x30(4)	04-000-030	4	
		Fundamentskive(2) 2H 80	00-003-106	2	
		Skive M8(2)	04-050-008	6	
		låsemutter M8(2)	04-040-008	6	
	Stålforankering(2)	00-100-310	2		
<b>Vegge 520x400 Postkasse</b>	<b>Ant= 1</b>	<b>Navn</b>	<b>Artnr/dimensjon</b>	<b>Ant</b>	<b>Lev</b>
		Vegge520x400(1) Postkasse	07-510-111	1	
		Brikkespesial(4)	04-060-051	4	
		Brikke(4)	04-060-050	4	
		Torx M8x25(4)	04-000-025	4	









**Boltepakker for / Boltpackage for / Bultpaket för**

Sign. \_\_\_\_\_.

<b>Rutsjebane 550 07-510-305</b>	<b>Ant= 1</b>	<b>Navn</b>	<b>Artnr/dimensjon</b>	<b>Ant</b>	<b>Lev</b>
		Rutsjebane	07-510-305	1	
		Brikke120 3T(2)	04-060-120	2	
		Torx M8x35(4)	04-000-035	4	
		Torx M8x45(2)	04-000-045	2	
		Torzx M8x30(4)	04-000-030	4	
		Fundamentskive(2) 2H 80	00-003-106	2	
		Skive M8(2)	04-050-008	4	
		Låsemutter M8(2)	04-040-008	6	
	Stålforankering(2)	00-100-310	2		







**Boltepakker for / Boltpackage for / Bultpaket för**

Sign. \_\_\_\_\_.

<b>Trappe 550 01-290-090</b>	<b>Ant= 1</b>	<b>Navn</b>	<b>Artnr/dimensjon</b>	<b>Ant</b>	<b>Lev</b>
		Trapp 550	01-290-090	1	
		Brikke90 3T(5)	04-060-090	2	
		Torx M8x35(4)	04-000-035	10	
		Fundamentskive(2) 2H 80	00-003-106	2	
		Skive M8(2)	04-050-008	6	
		Låsemutter M8(2)	04-040-008	6	
		Stålforankering(2)	00-100-310	2	















**Boltepakker for / Boltpackage for / Bultpaket för**

Sign. \_\_\_\_\_.

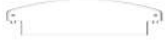
Nettbro skrå Tett 07-510-179	Ant= 1	Navn	Artnr/dimensjon	Ant	Lev
		Nett (1) Tett INKL. beslag	07-510-179	1	
		Rør skrå(2)	07-510-166	2	
		Brikke120 3T(8)	04-060-120	8	
		Torx M8x25(16)	04-000-025	16	
		Saddelwasher 38mm (32)	04-210-010	32	
		Møbelknapp (16)	04-030-025	16	

**Boltepakker for / Boltpackage for / Bultpaket för**

Sign. \_\_\_\_\_.

Tak	Ant= 2	Navn	Artnr/dimensjon	Ant	Lev
		Tak mini (2)	07-510-105	4	
		Gavelplate(2)	07-510-106	4	
		Vinkel 35x35x3(2) 11mm	04-070-036	4	
		Møbelknapp	04-030-011	8	
		Torx M8x12(4)	04-000-012	8	
		Skive M8 (4)	04-050-008	8	
Buttikdisk	Ant= 1	Navn	Artnr/dimensjon	Ant	Lev
		Buttikdiskk	07-510-130	1	
		Vinkel 50x50x4(2) 11mm	04-070-050	2	
		Møbelknapp(2)	04-030-011	2	
		Brikke 501T(2)	04-060-040	2	
		Torx M8x12 (2) Torx M8x20 (2)	04-000-012 04-000-020	2 2	
		Skive M8 (2)	04-050-008	2	

## Montering av lekeapparatet / Assembly instructions / Montering av lekredskapet

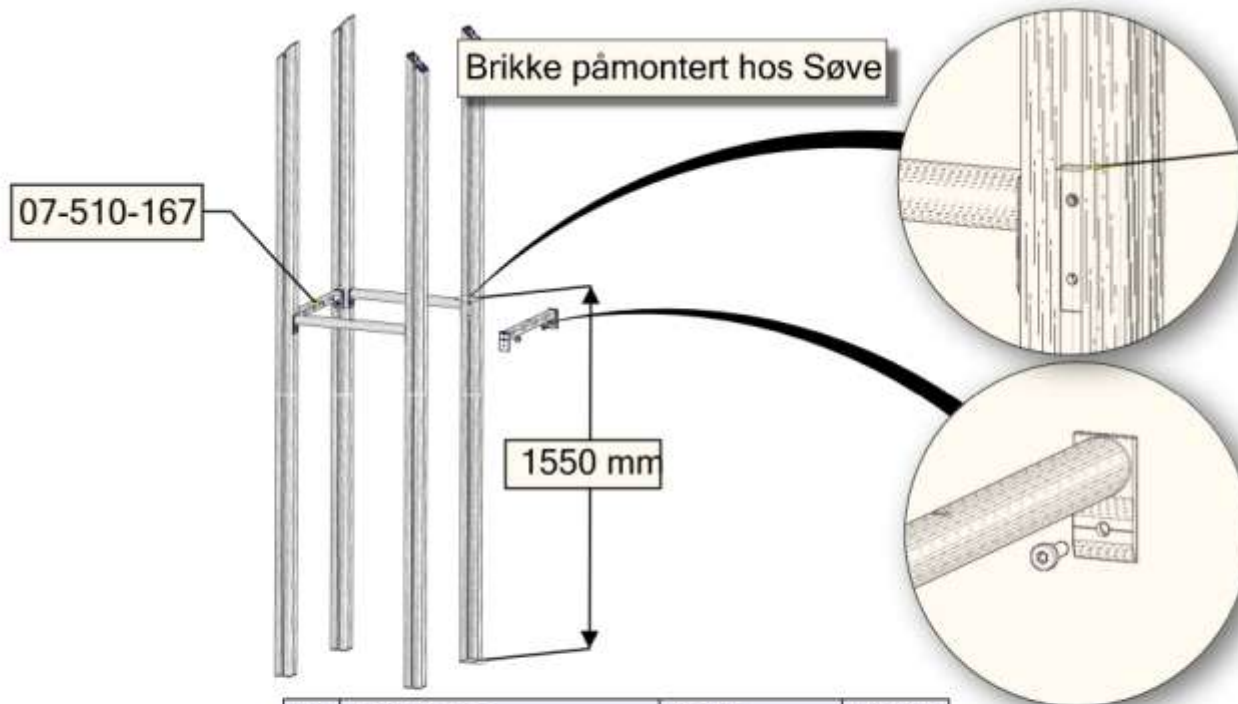

nr	PartName	Artnr	Antall
4	Torx M8x25	04-000-025	8
1	70x70 2700 skrå	07-510-158	4
2	Sperrerør gulv	07-510-161	3
3	Sperrerør gulv og nett	07-510-167	1

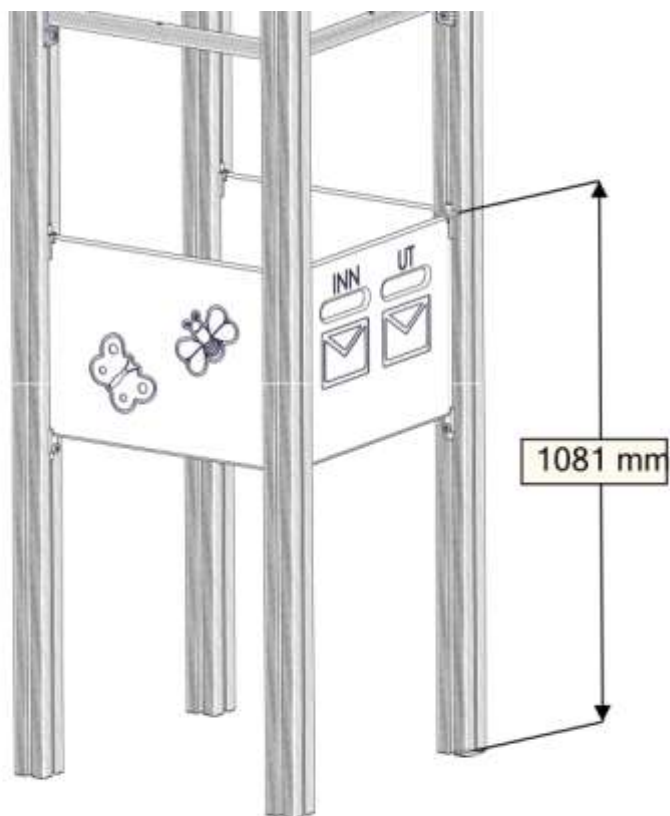



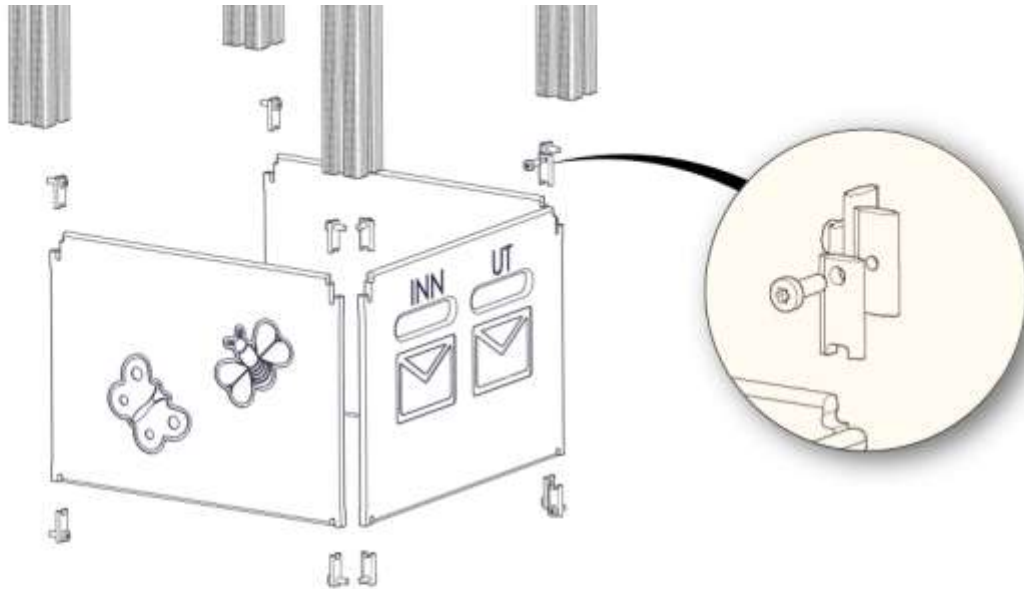

nr	PartName	Artnr	Antall
1	Torx M8x25	04-000-025	12
2	Brikke Spesial 12mm	04-060-051	12
4	Vegg 520x400	07-510-110	2
5	Vegg Postkasse 520x400	07-510-111	1

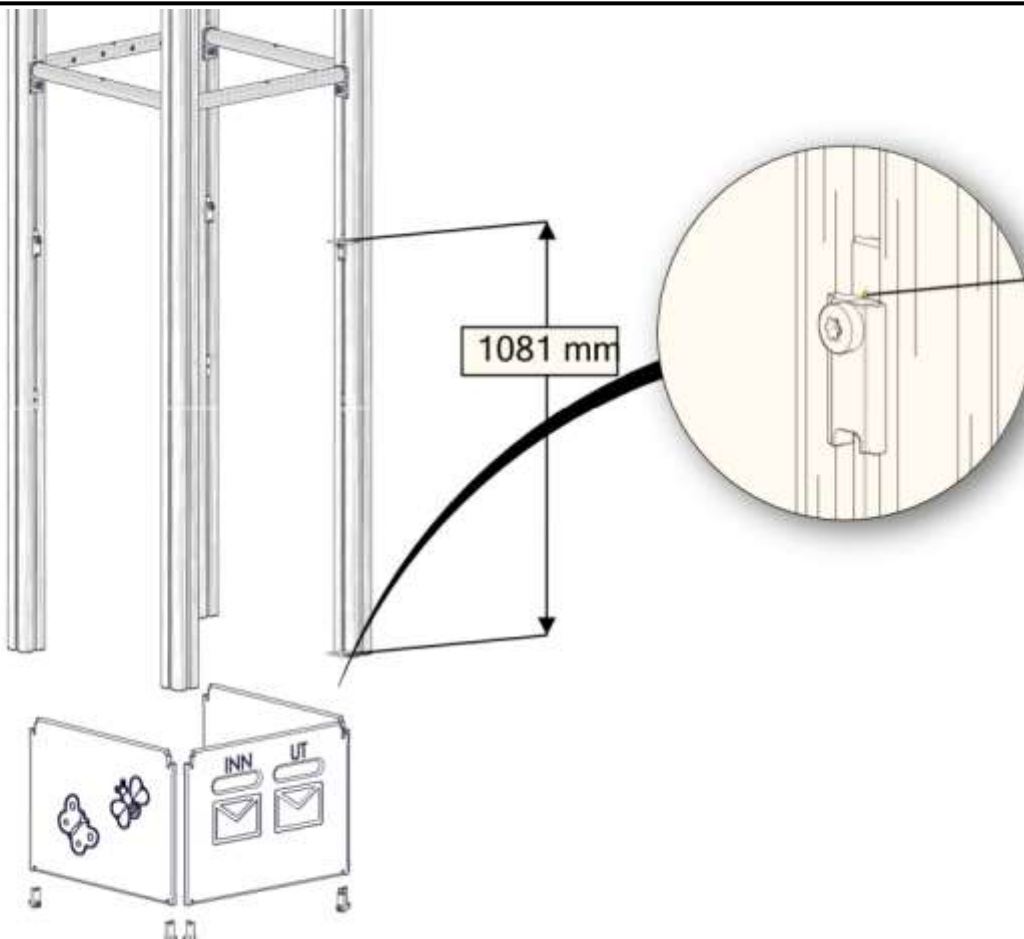

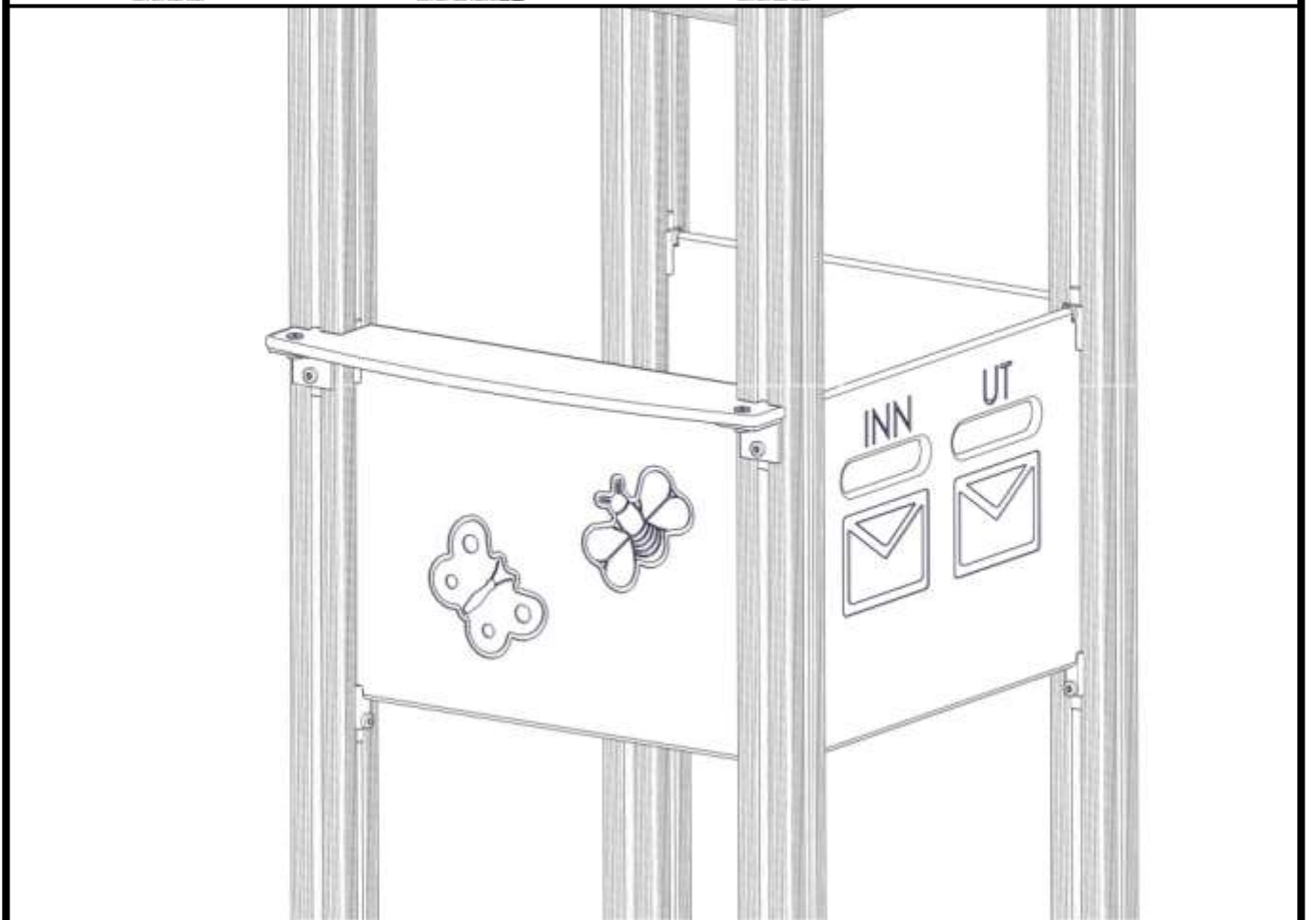
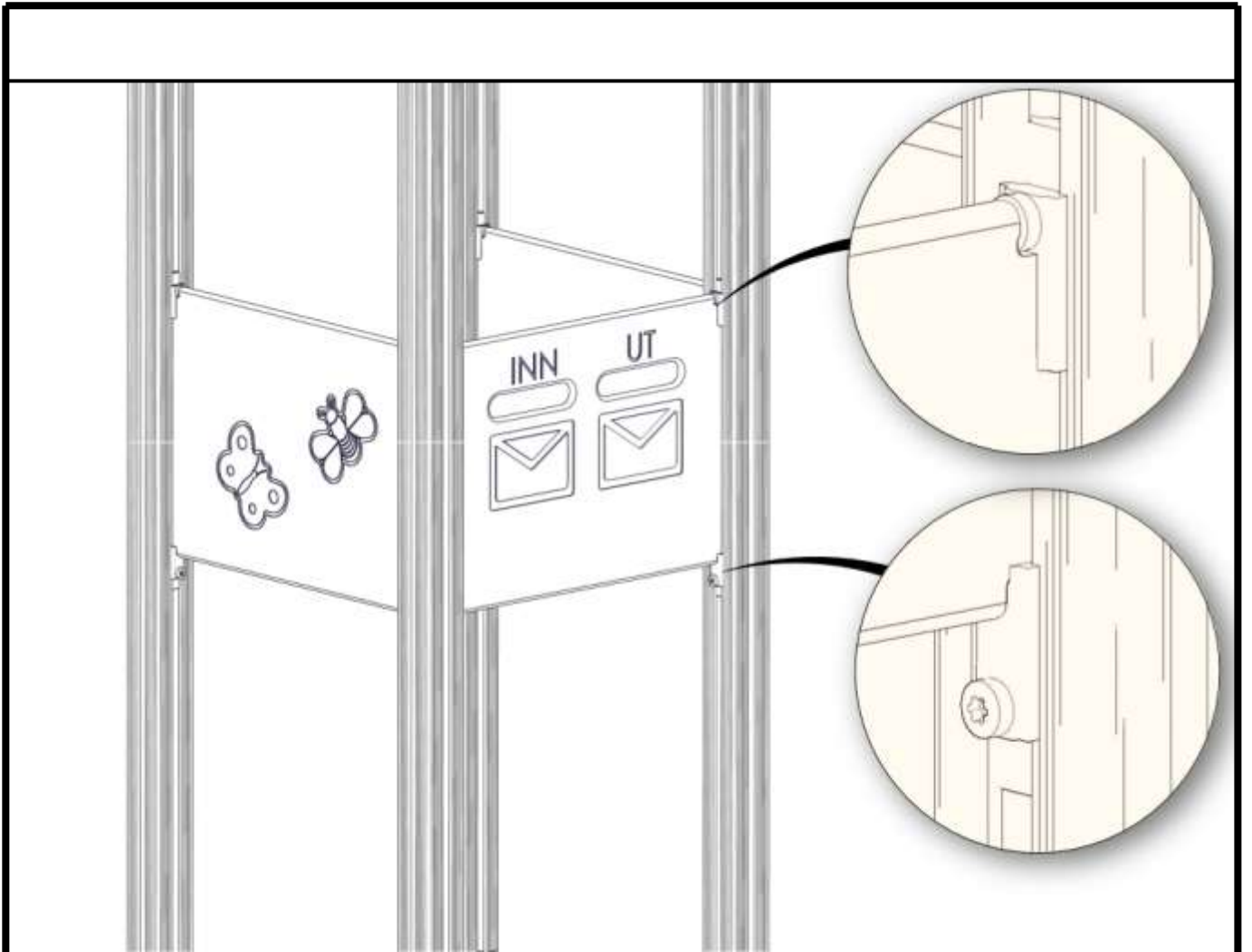

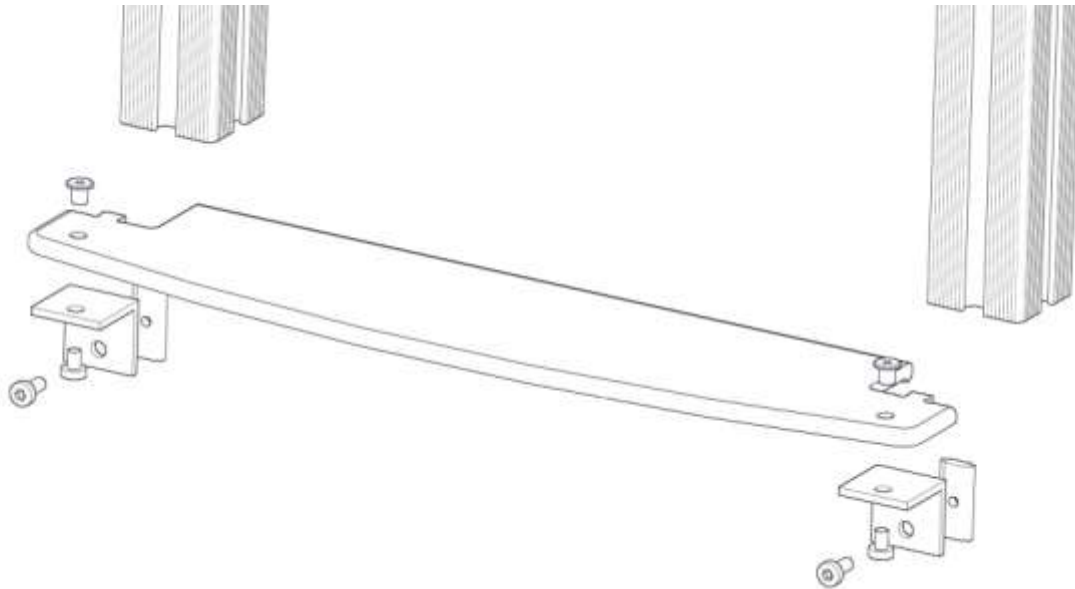

nr	PartName	Artnr	Antall
1	Torx M8x12	04-000-012	2
2	Torx M8x20	04-000-020	2
3	Møbelknapp 16x11	04-030-011	2
4	Brikke50 1XM8	04-060-050	2

nr	PartName	Artnr	Antall
5	Vinkel 50x50x50x5 11mm hull	04-070-050	2
6	Butikksdisk 520	07-510-130	1

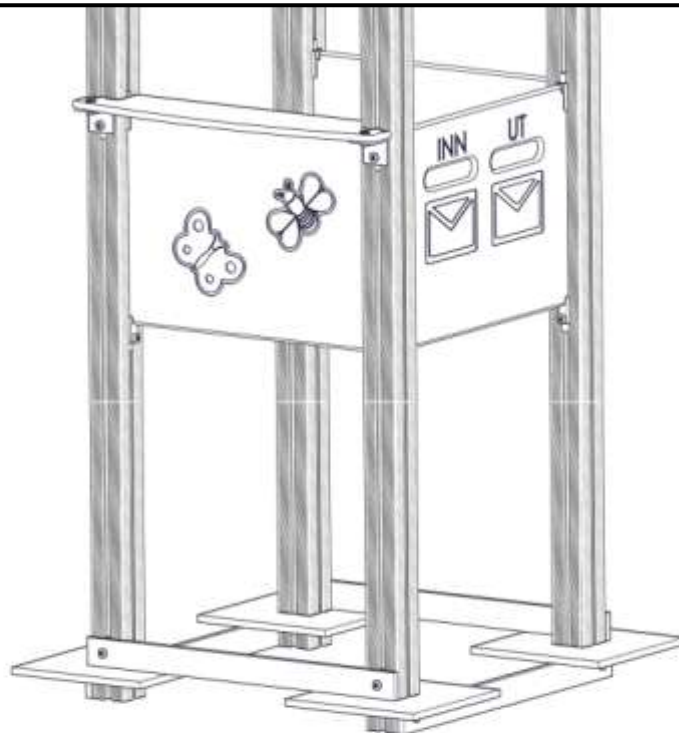

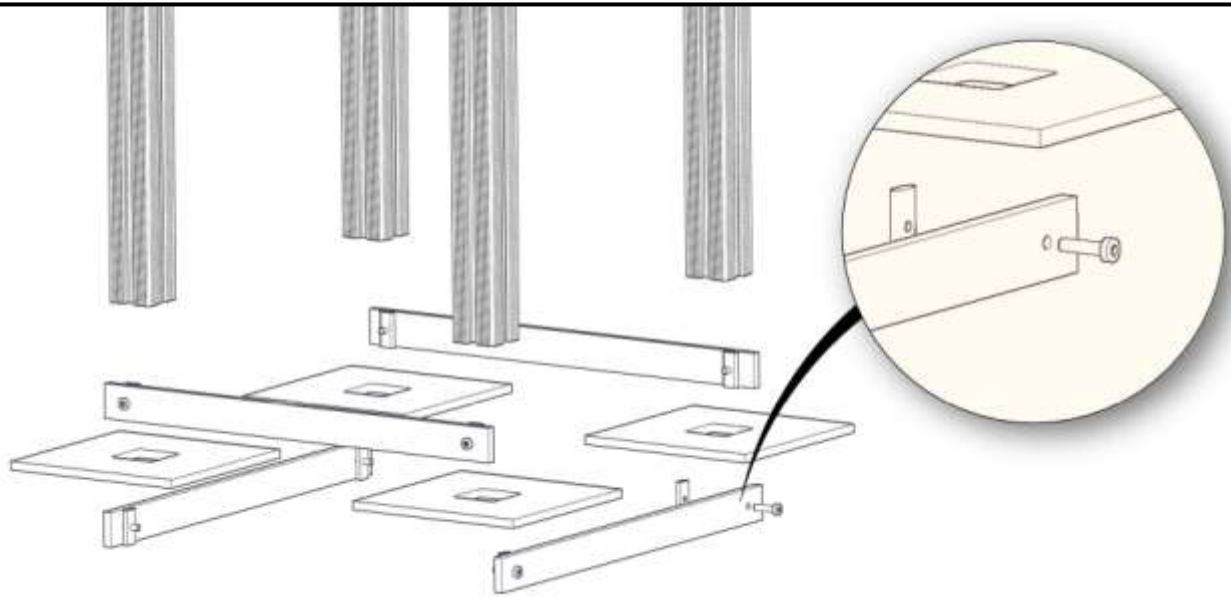

nr	PartName	Artnr	Antall
1	Torx M8x35	04-000-035	8
2	Brikke50 1XM8	04-060-050	8
3	Fundamet sprosse 660x50	07-510-200	4
4	Fundament 275x275x12	07-510-201	4

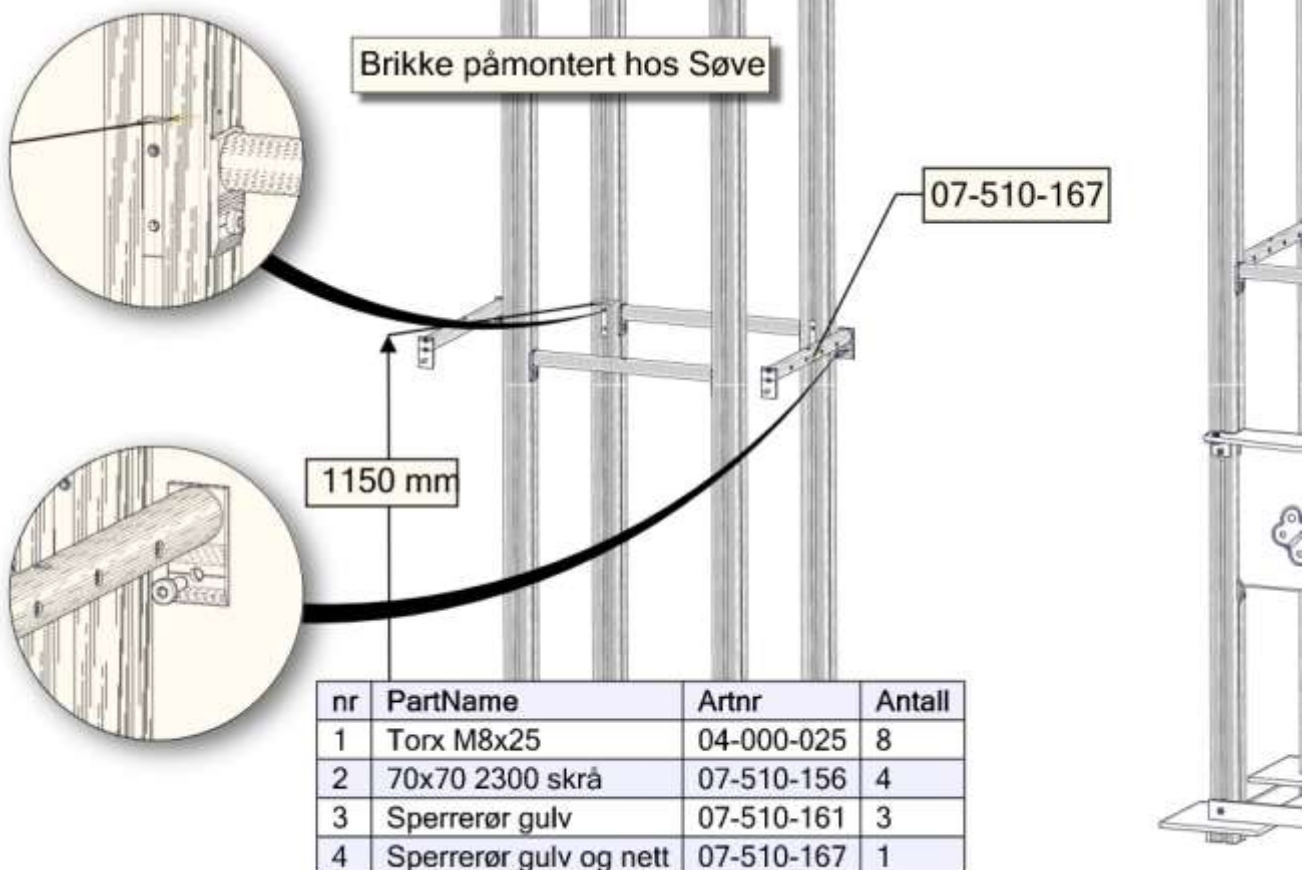

nr	PartName	Artnr	Antall
1	Torx M8x25	04-000-025	8
2	70x70 2300 skrå	07-510-156	4
3	Sperrerør gulv	07-510-161	3
4	Sperrerør gulv og nett	07-510-167	1

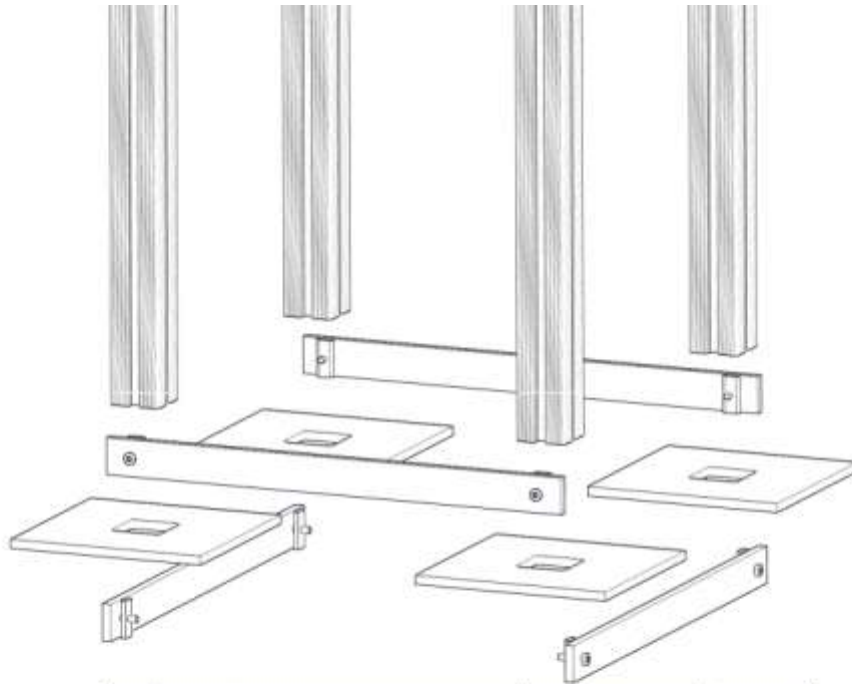

nr	PartName	Artnr	Antall
1	Torx M8x35	04-000-035	8
2	Brikke50 1XM8	04-060-050	8
3	Fundamet sprosse 660x50	07-510-200	4
4	Fundament 275x275x12	07-510-201	4

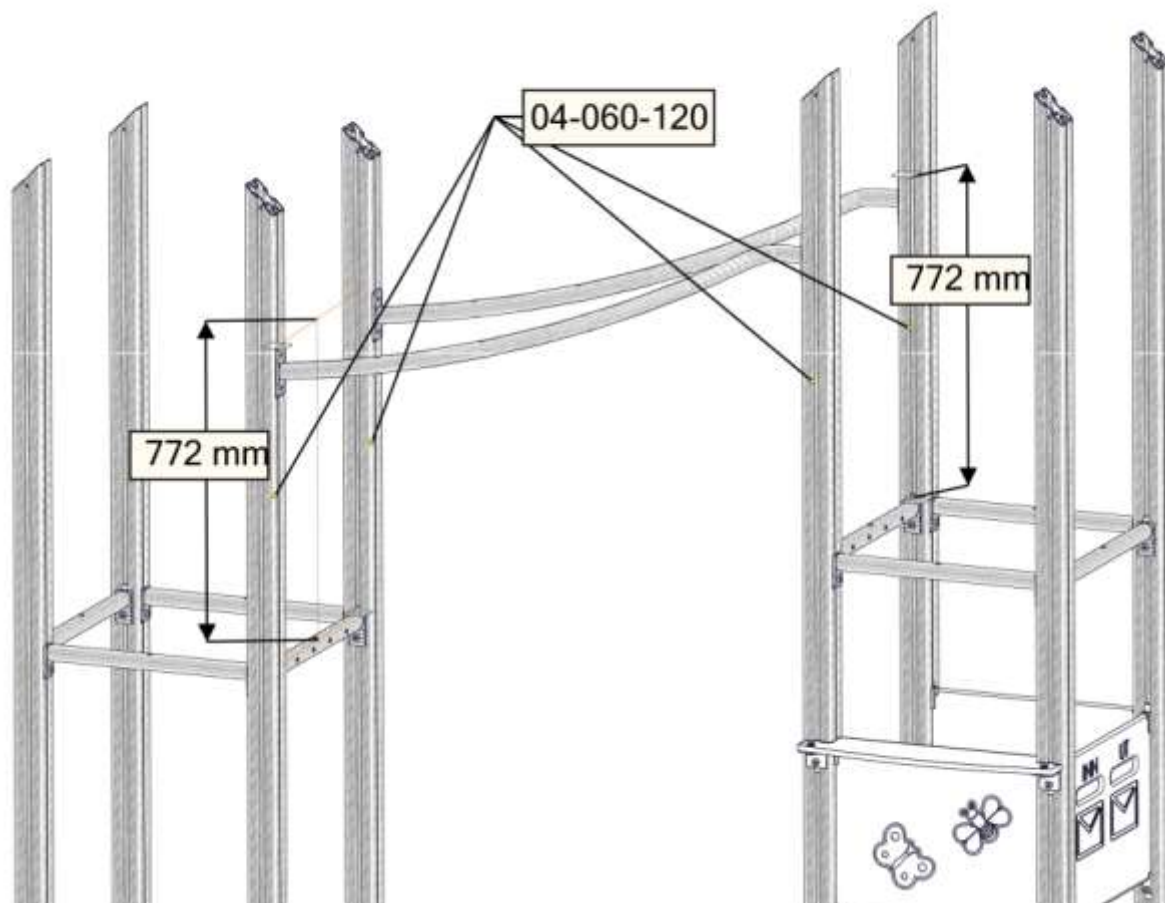

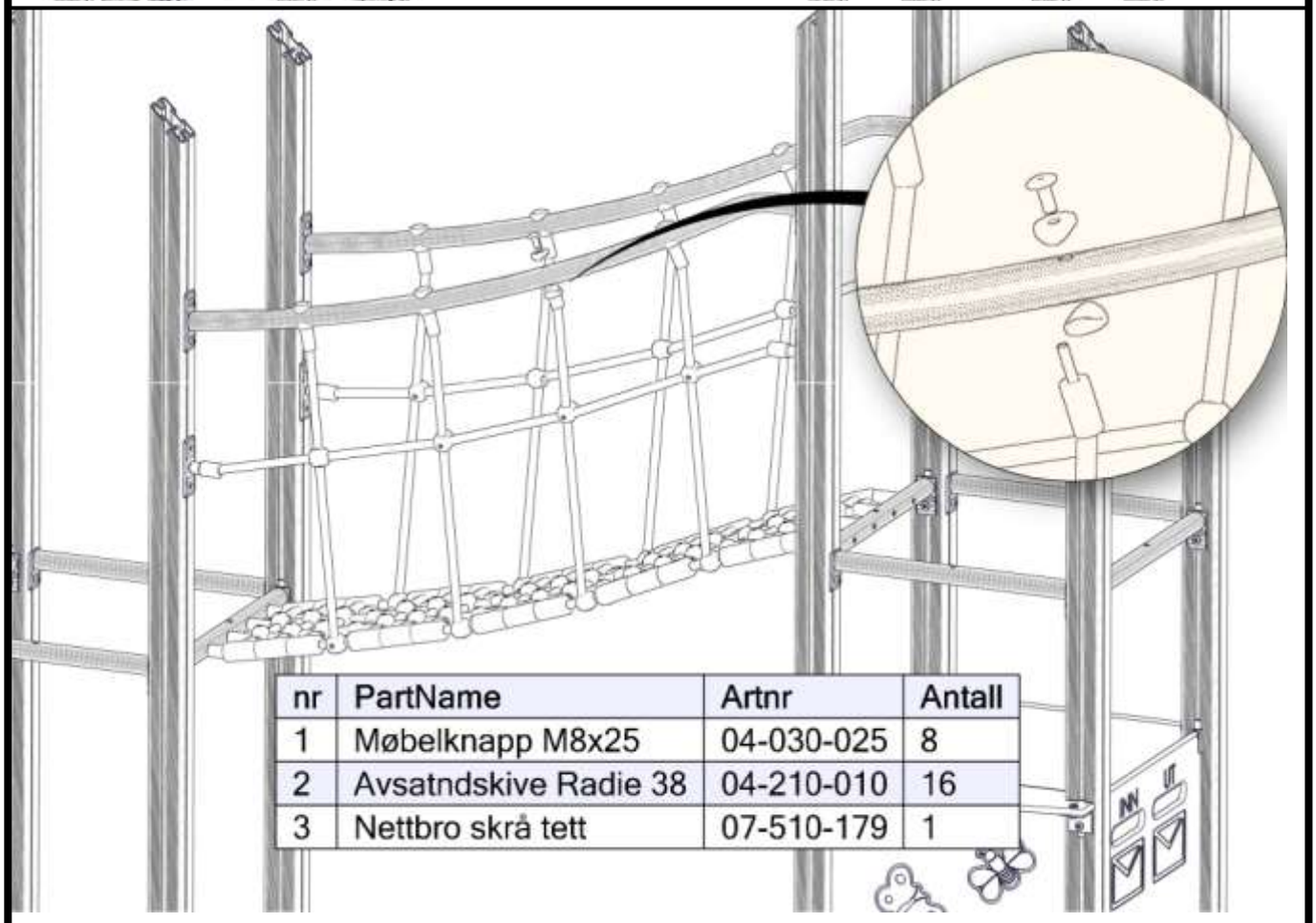
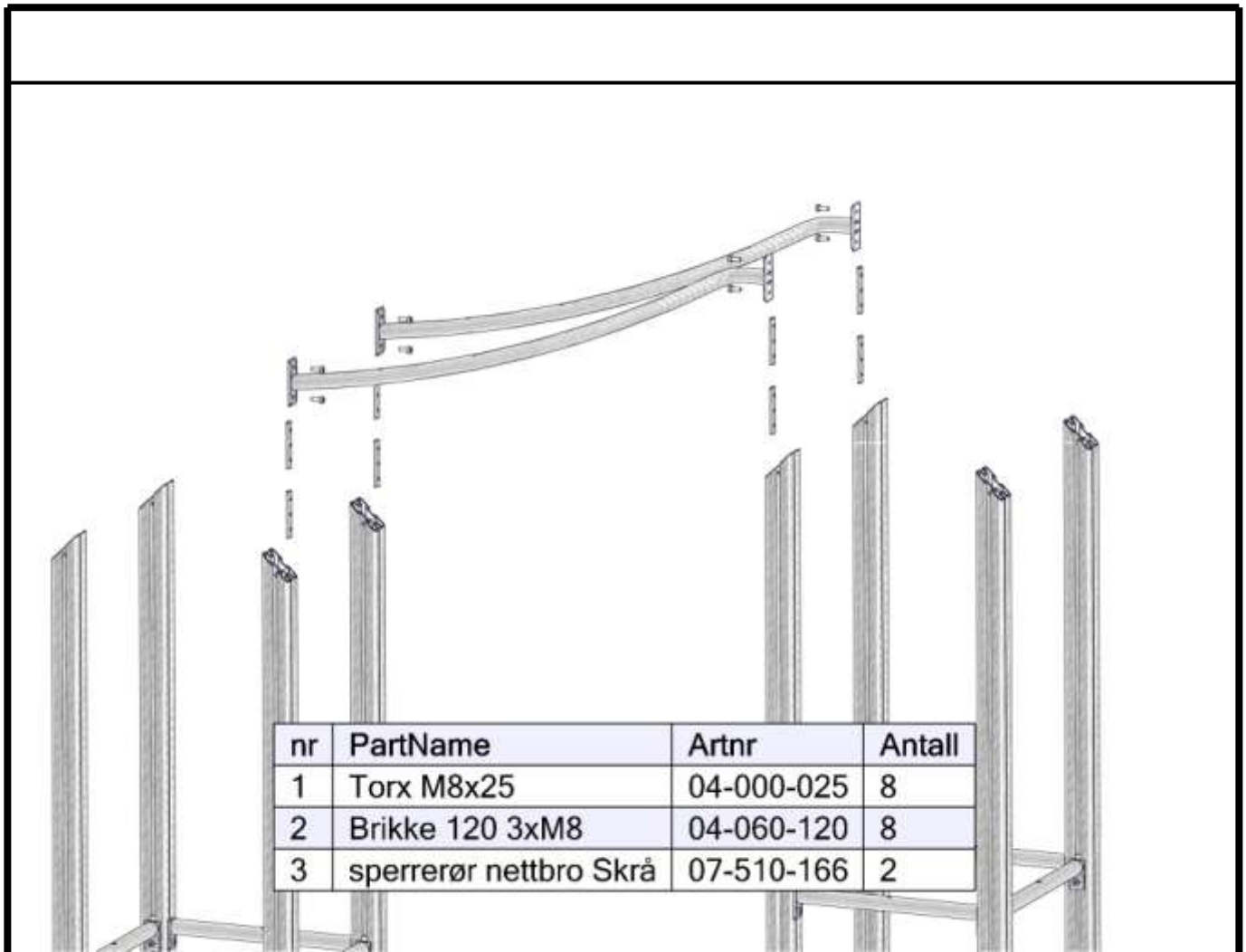

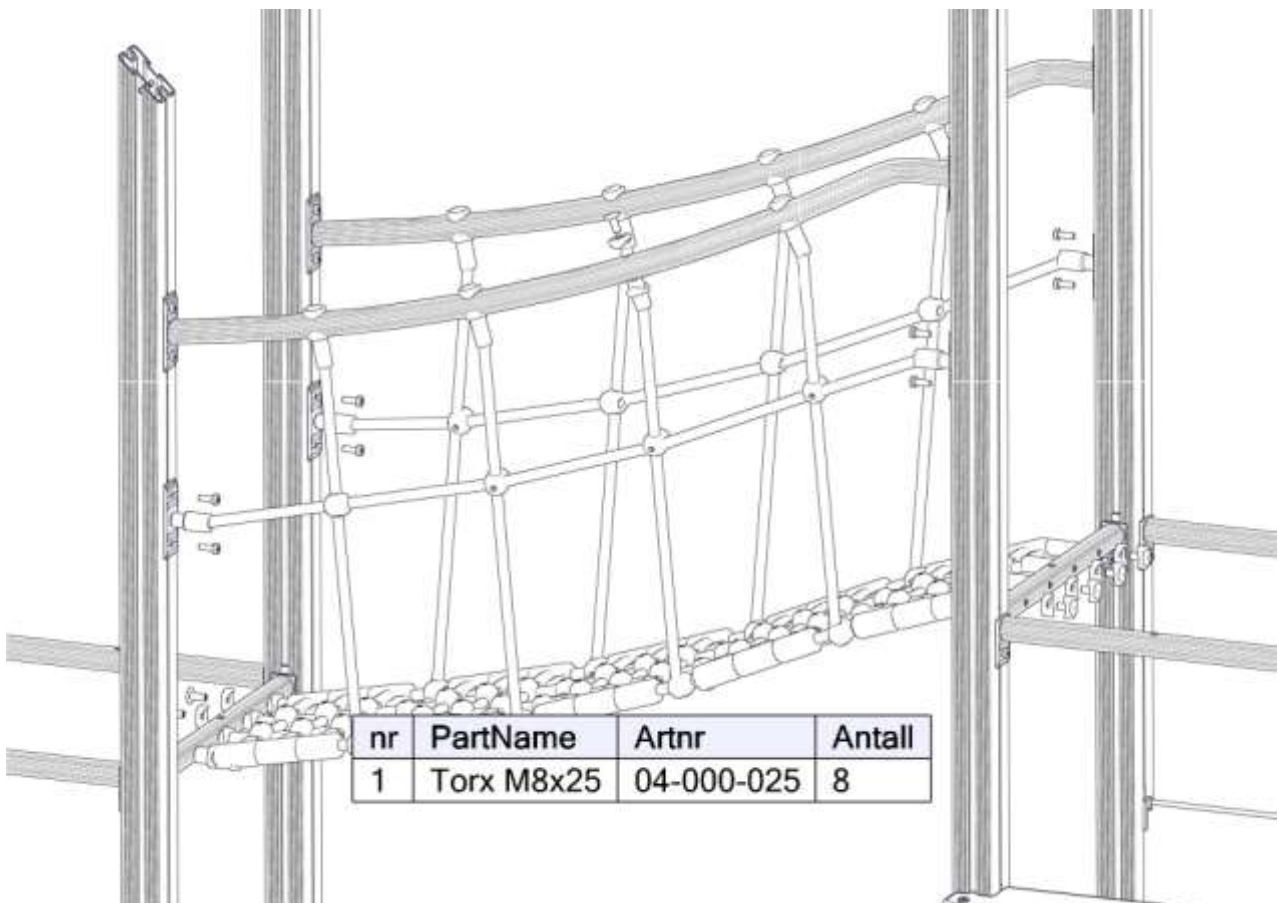
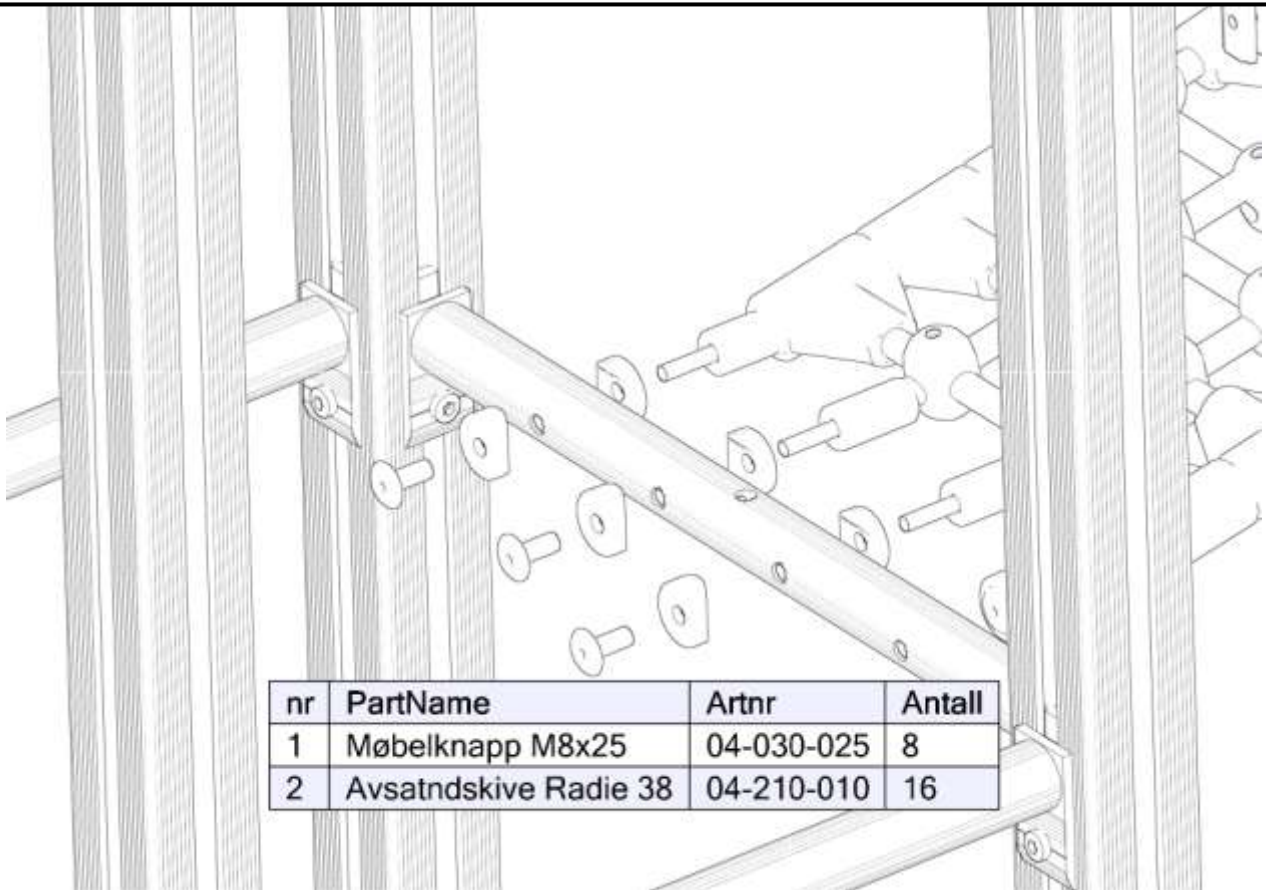

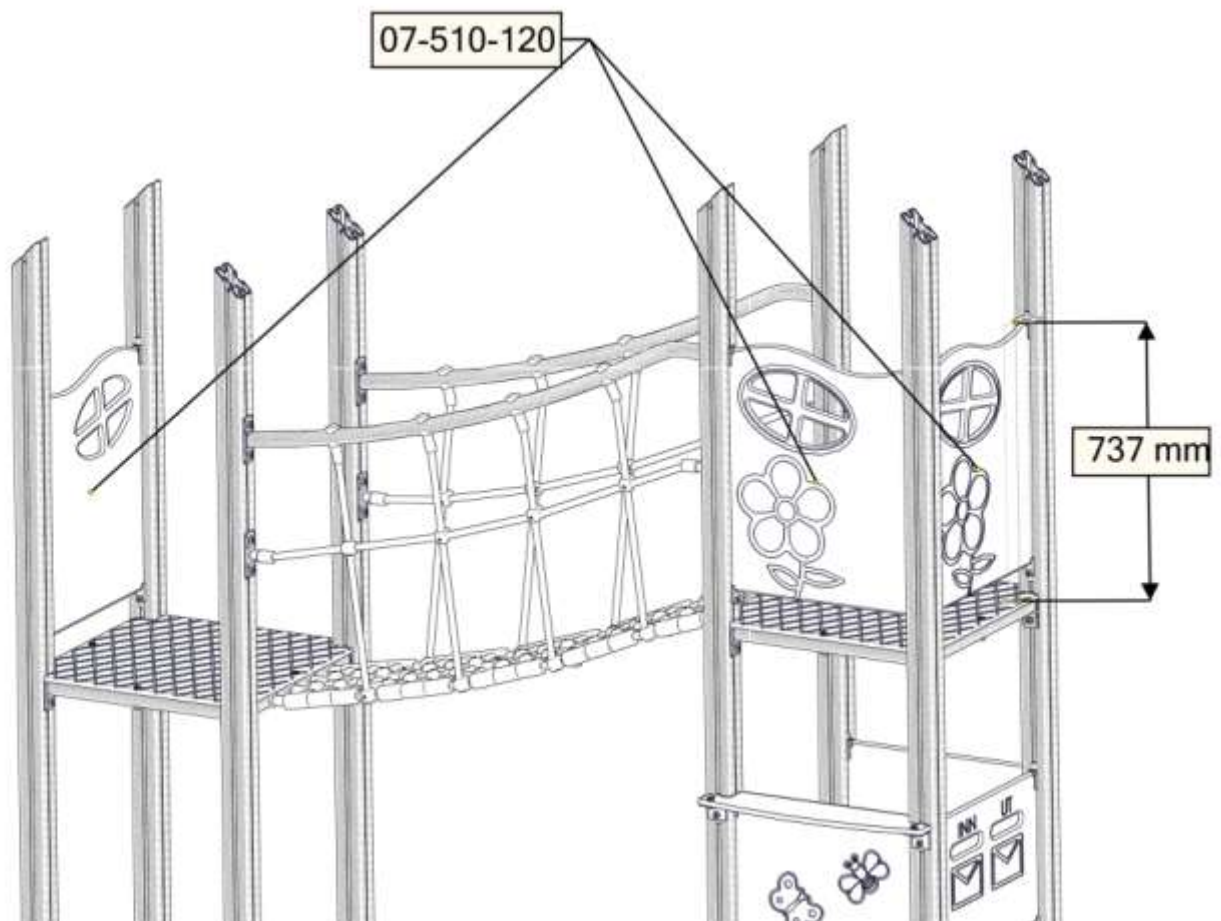
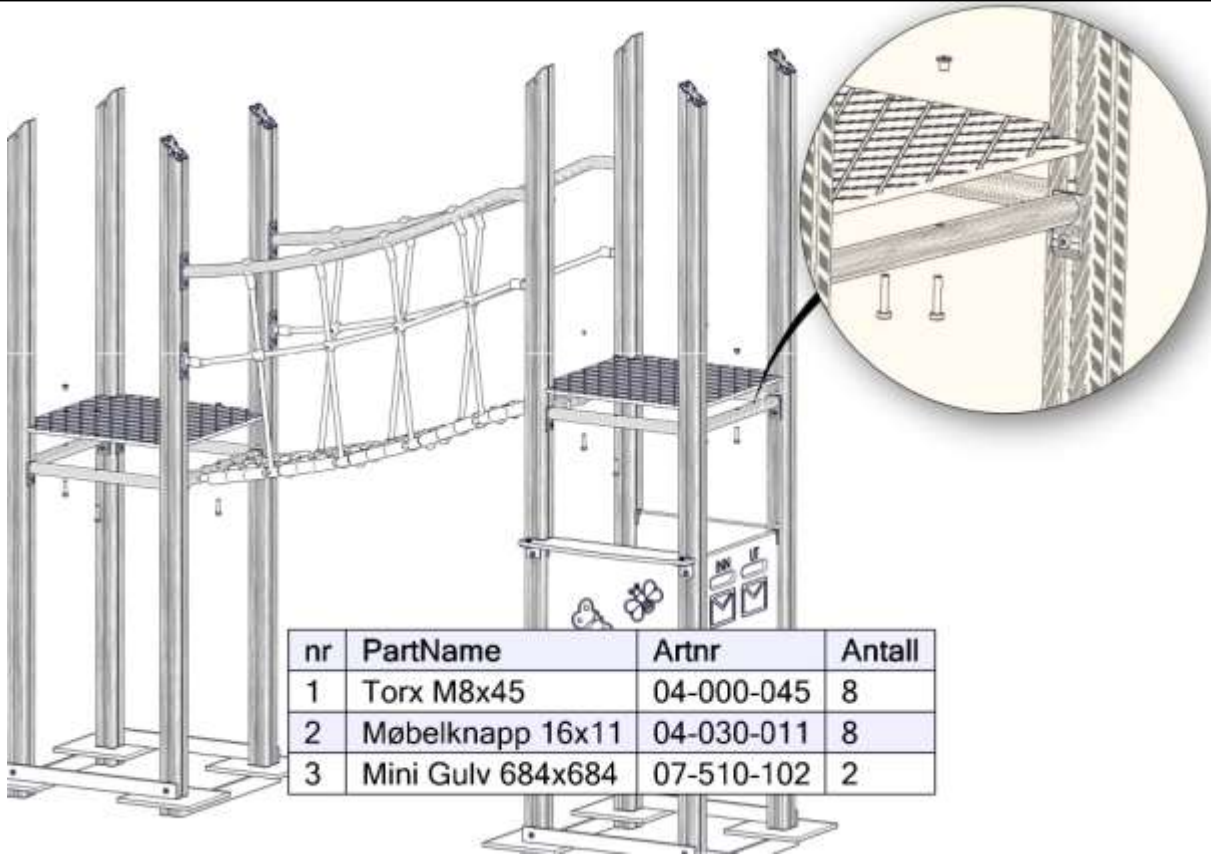



3x

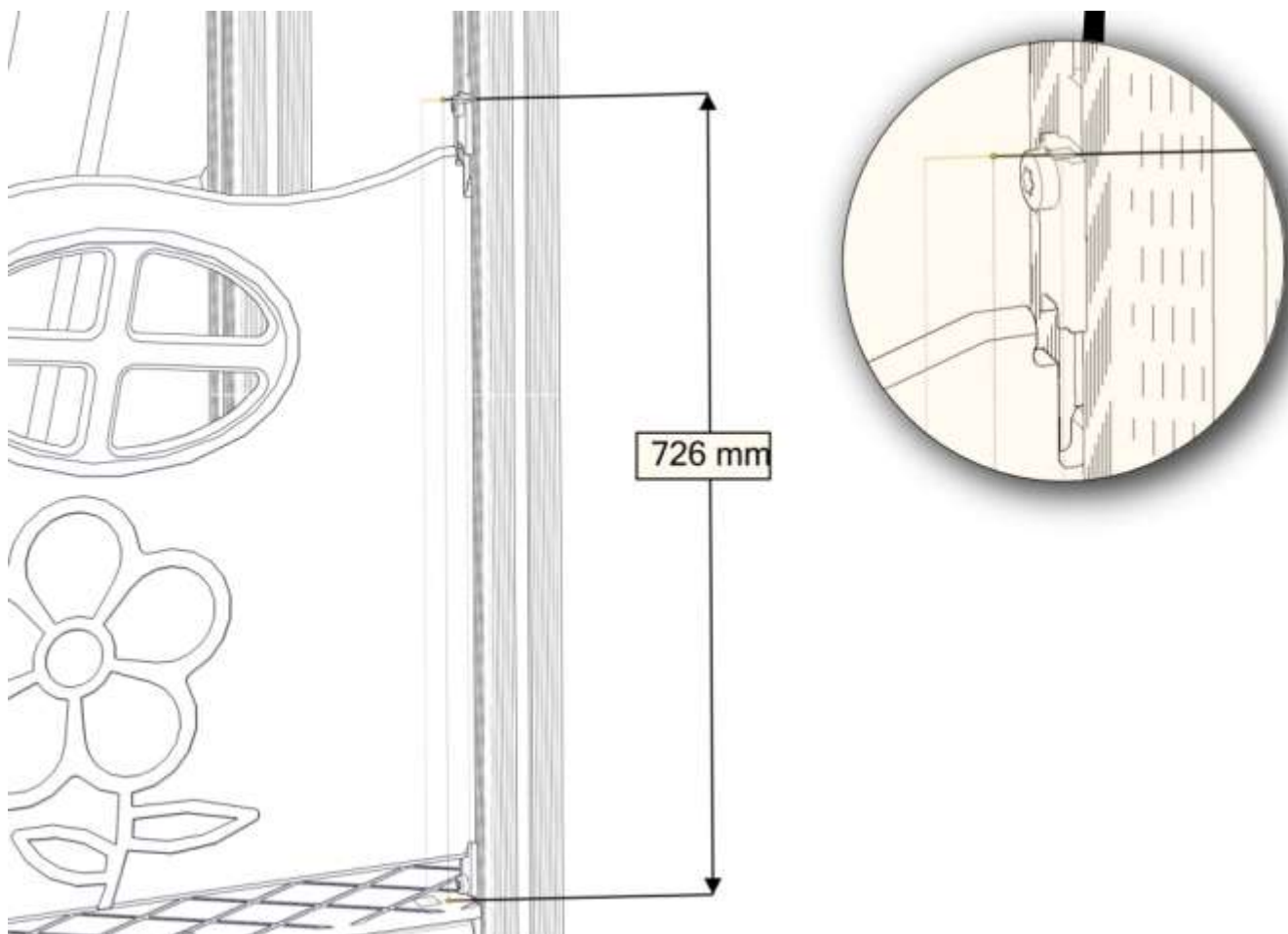
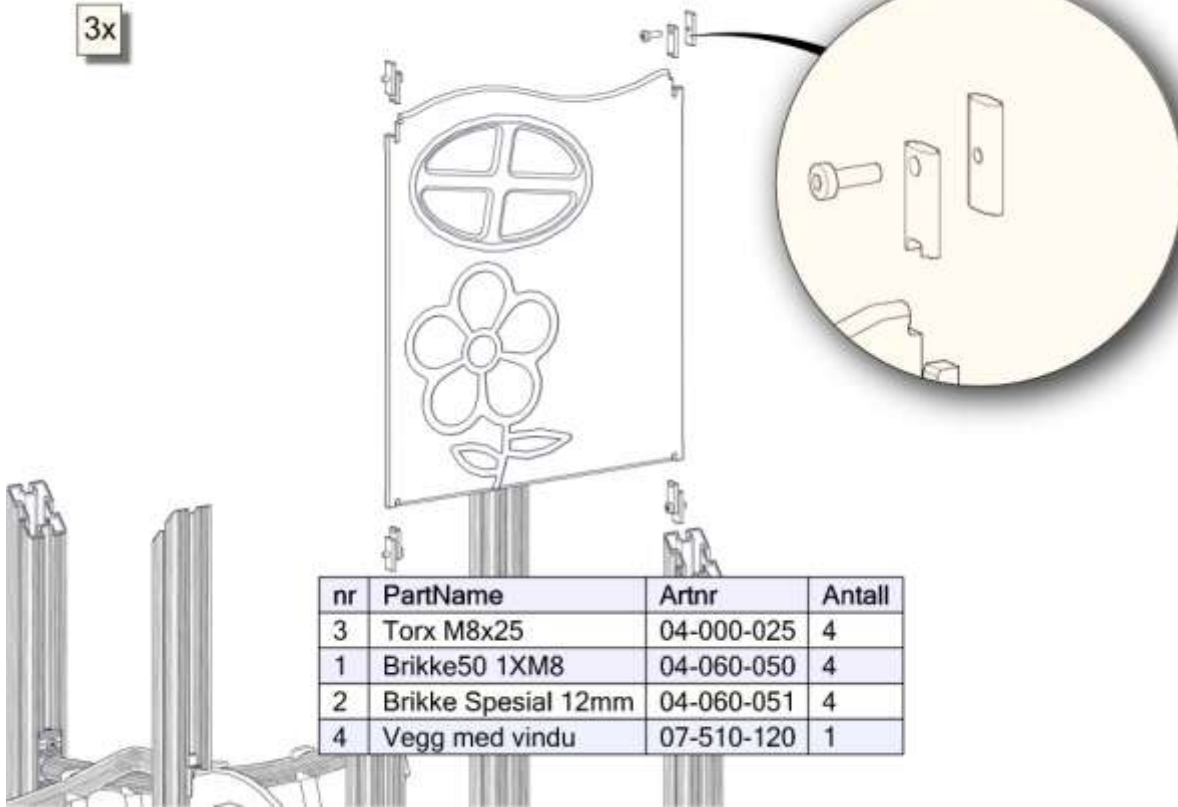

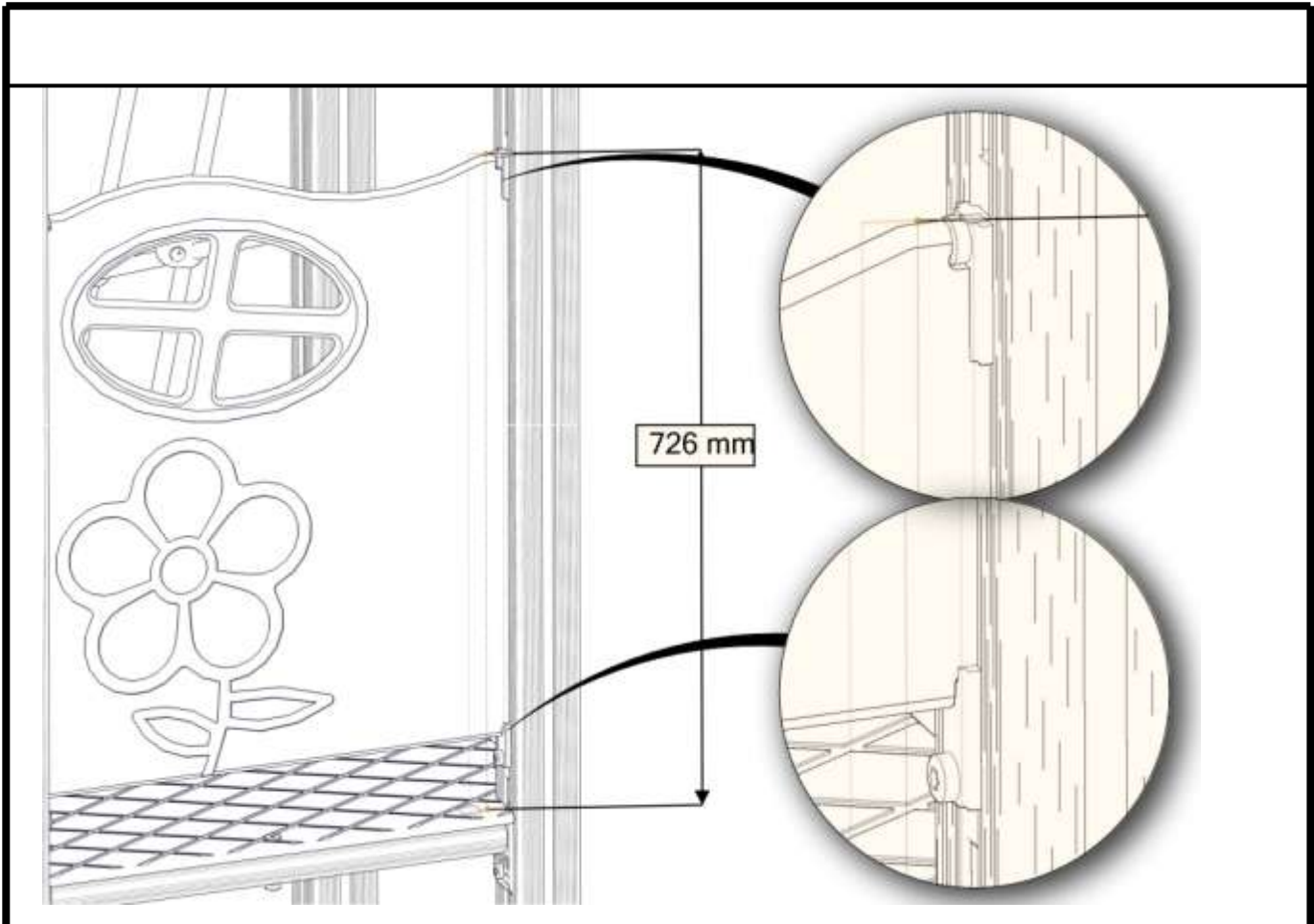

2x

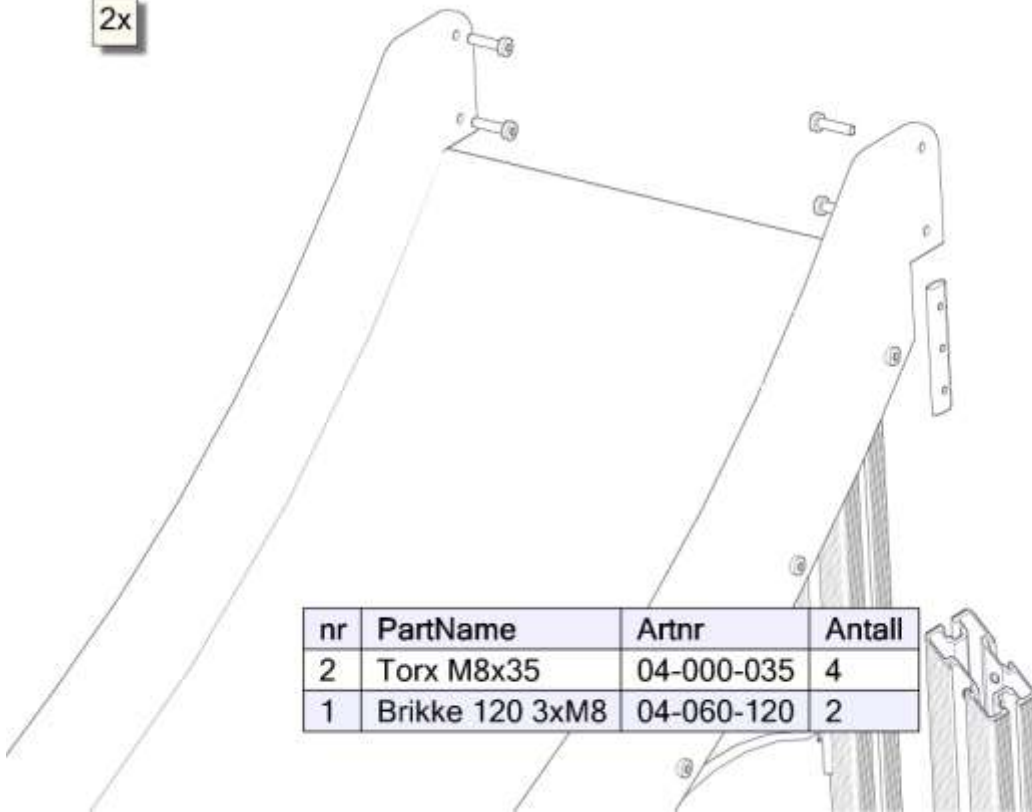

2x

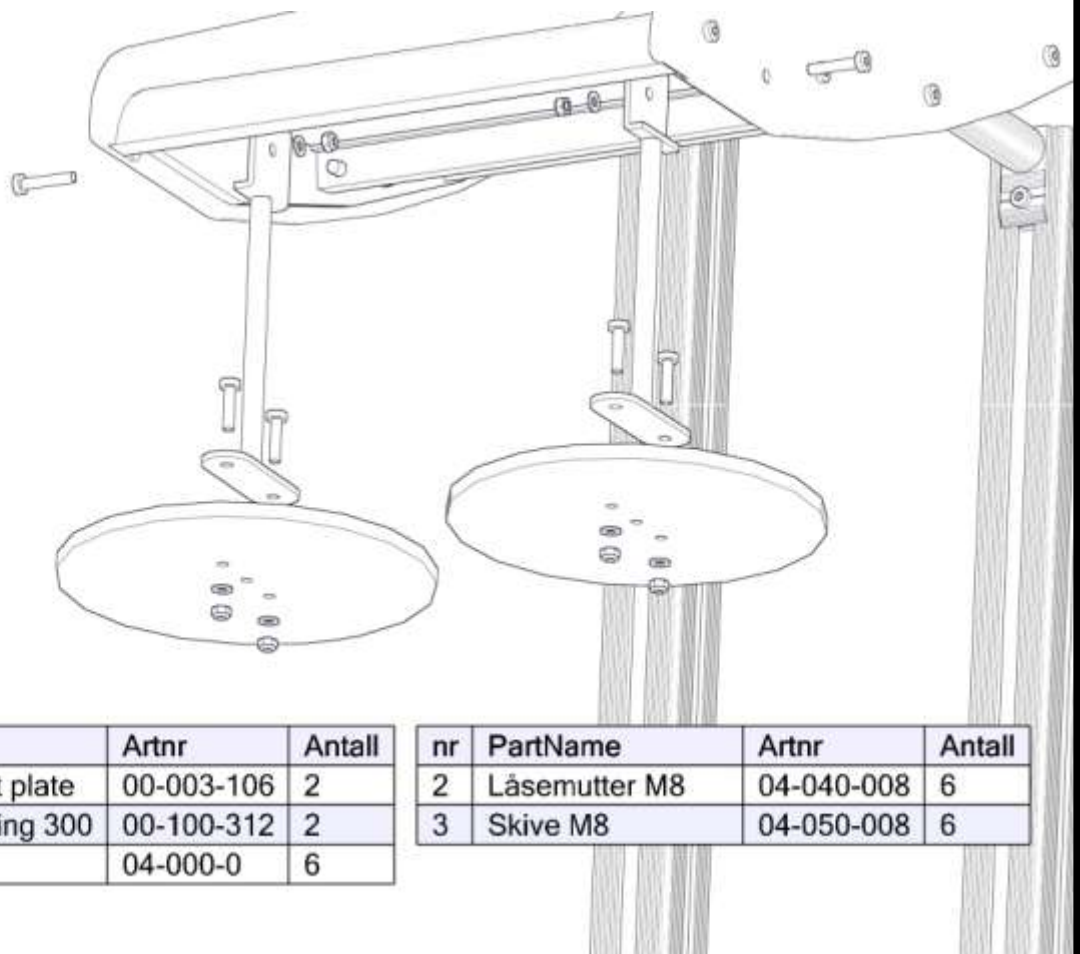

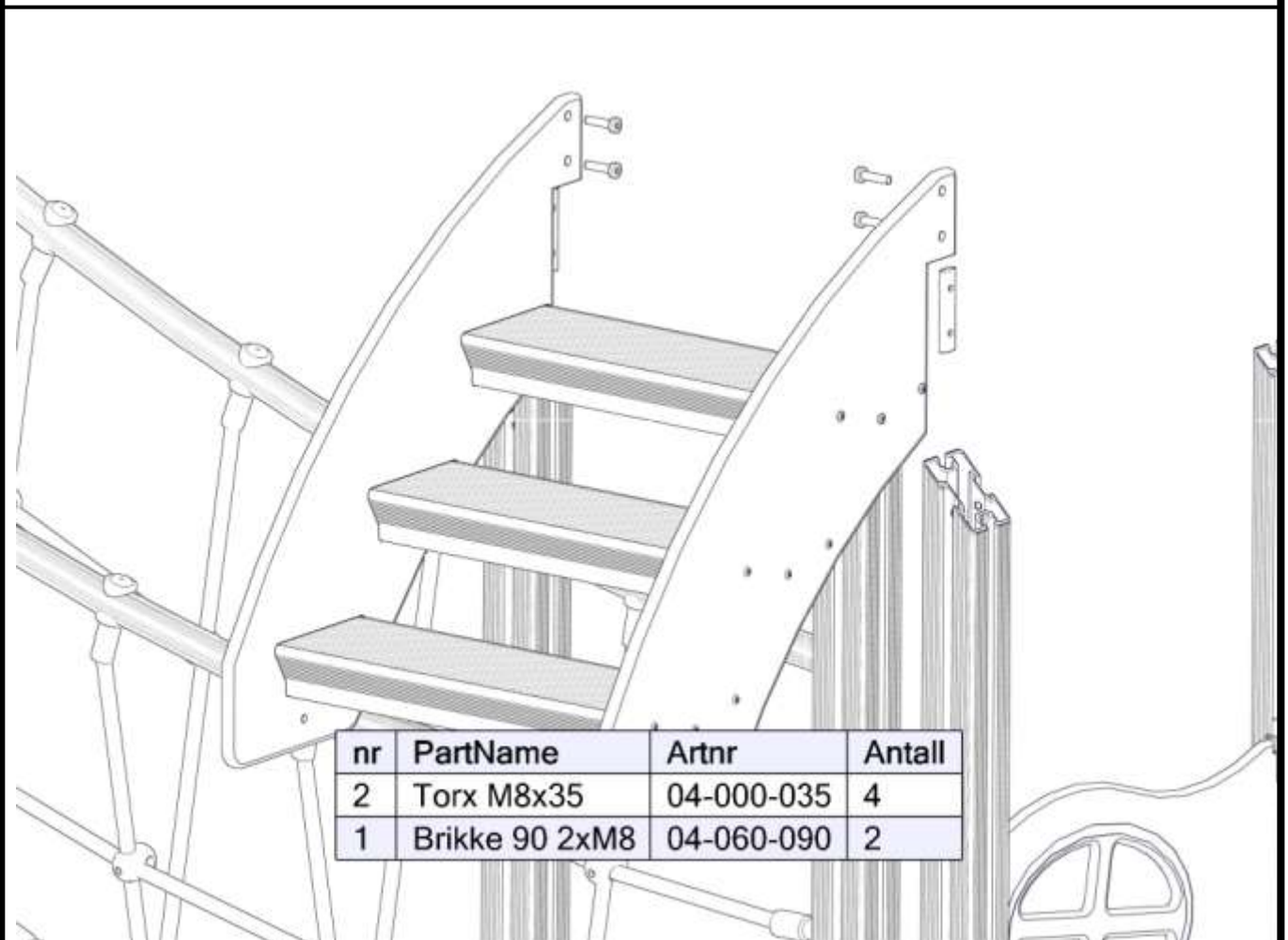
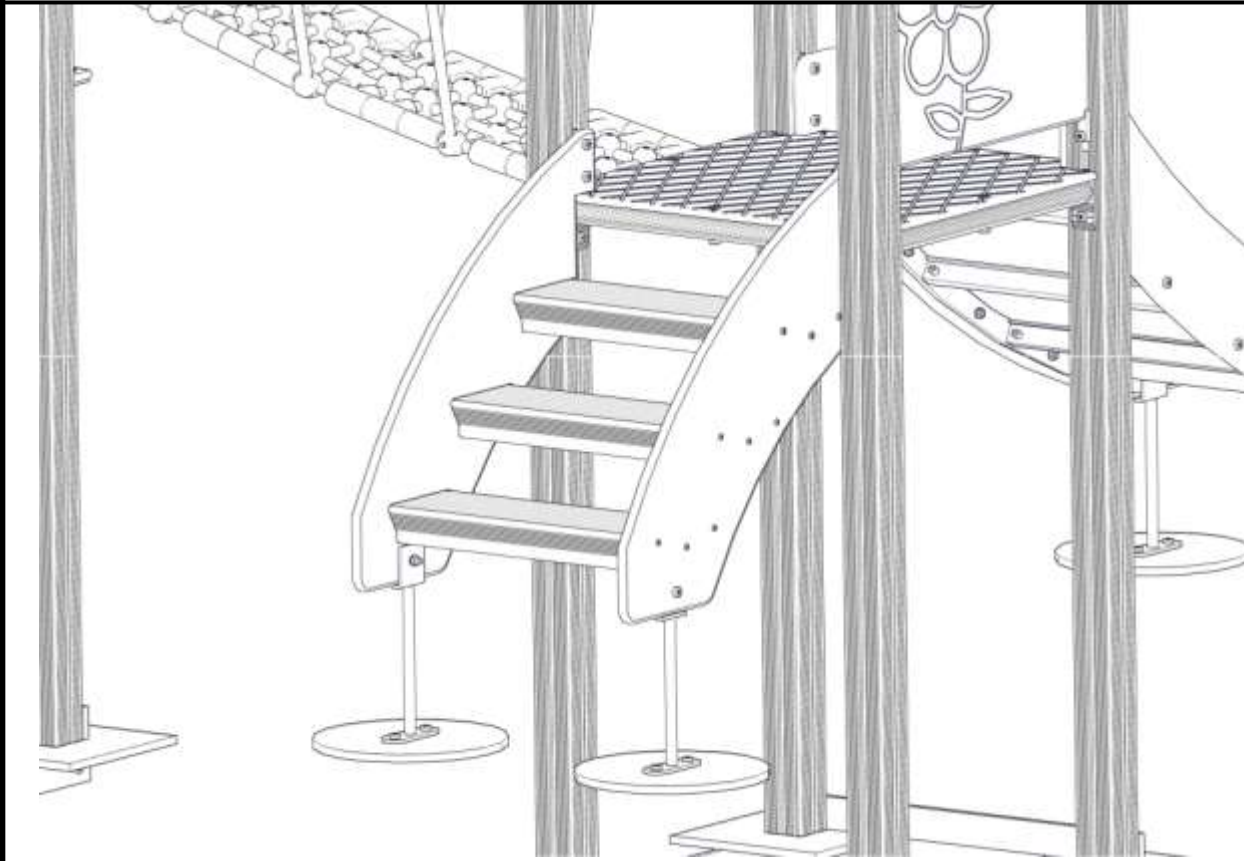

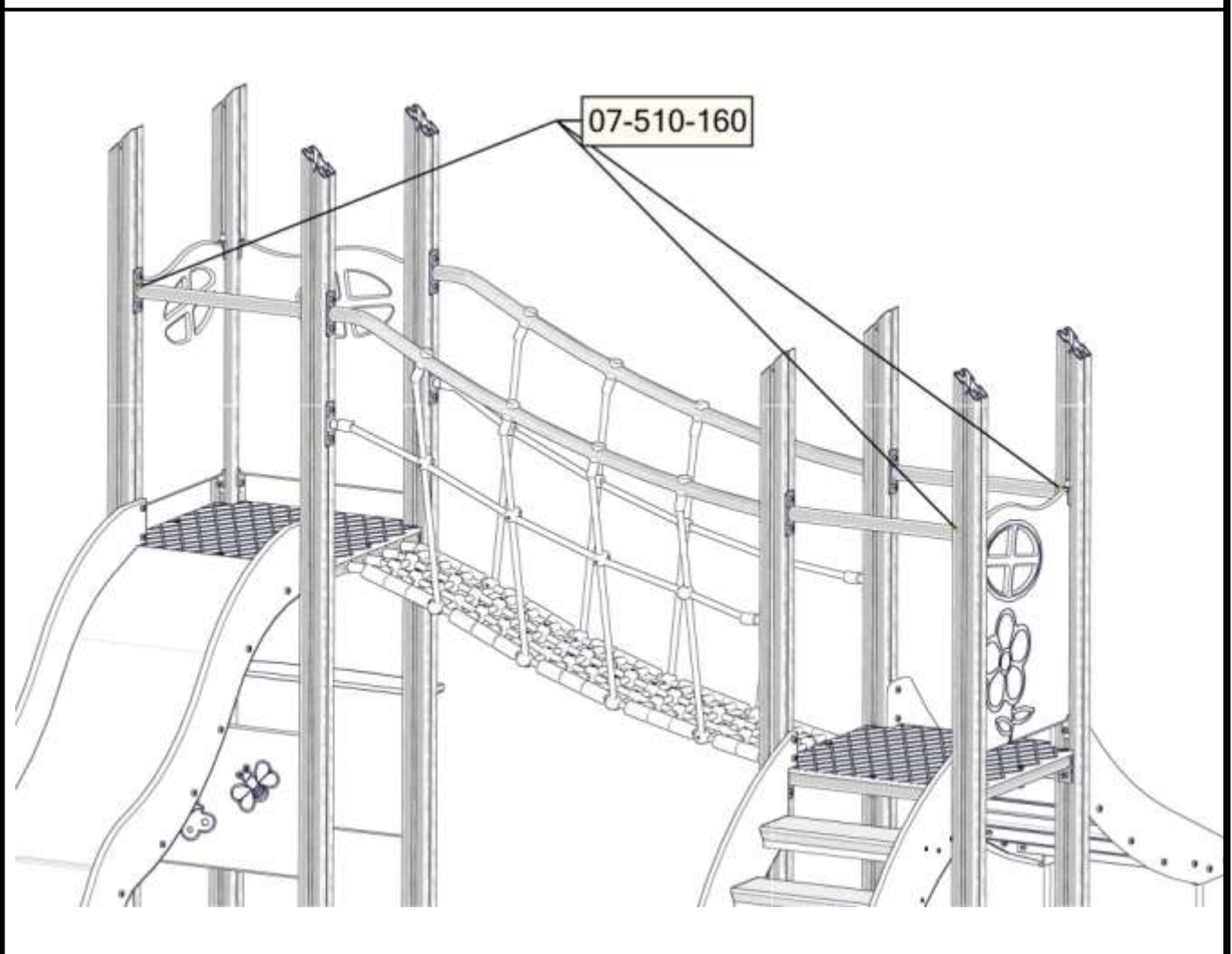
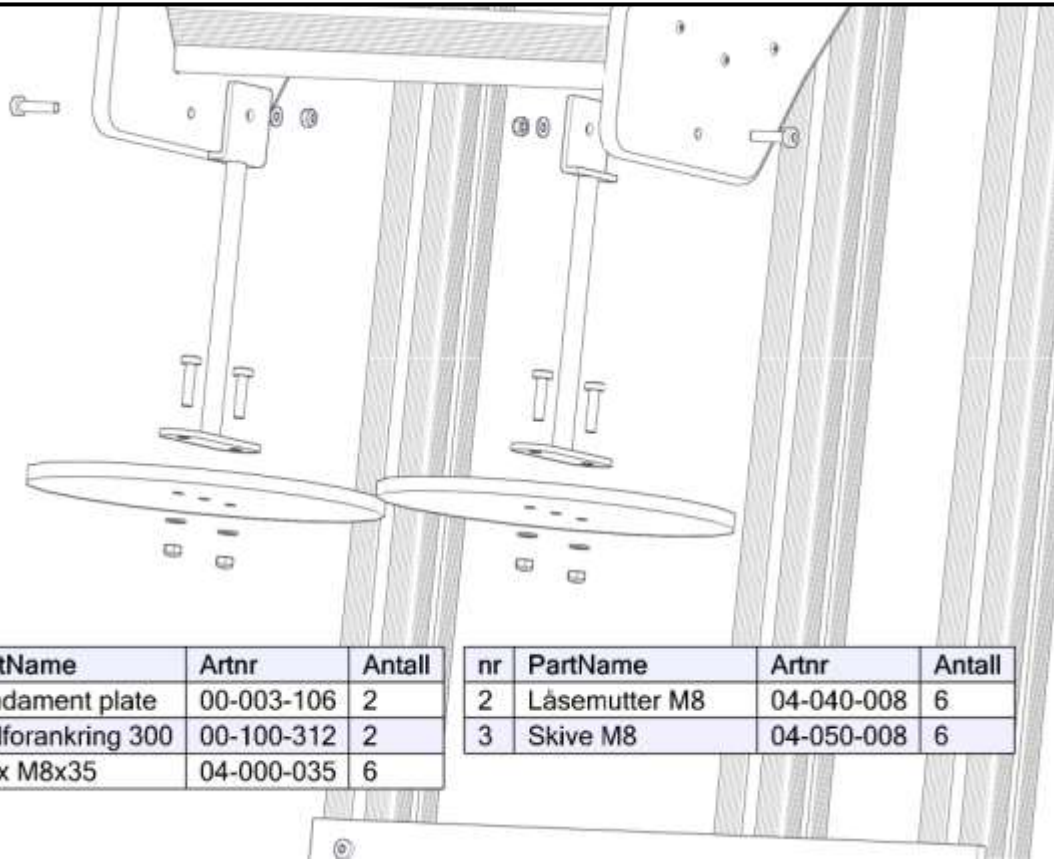

3x

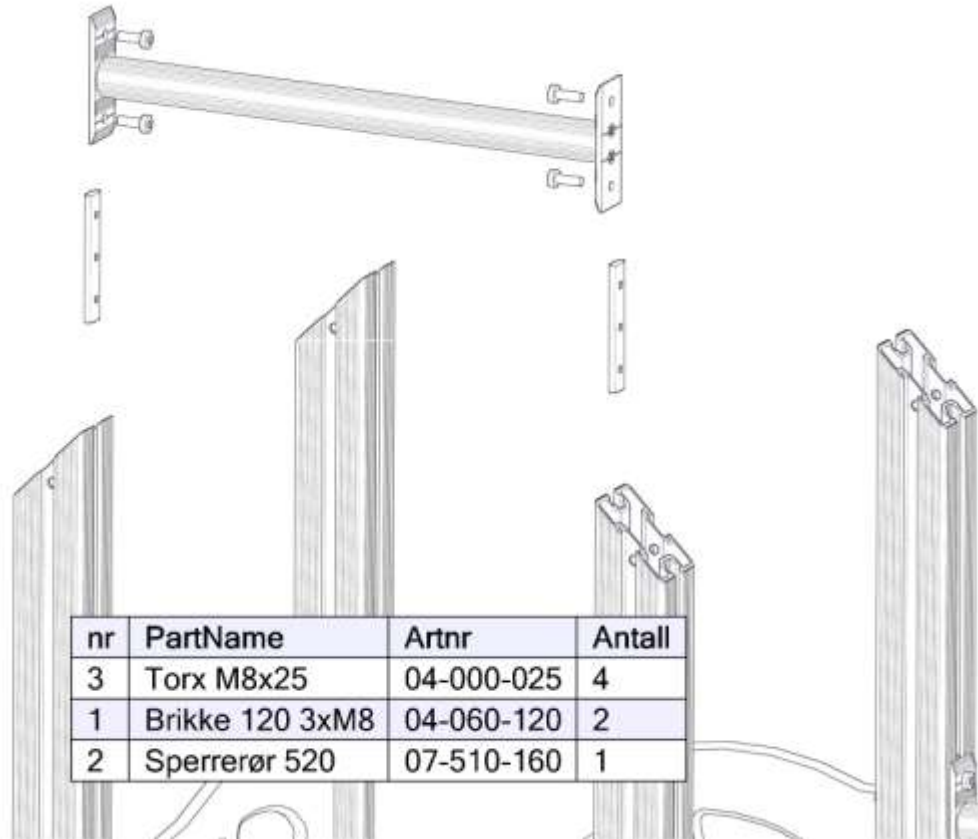

2x

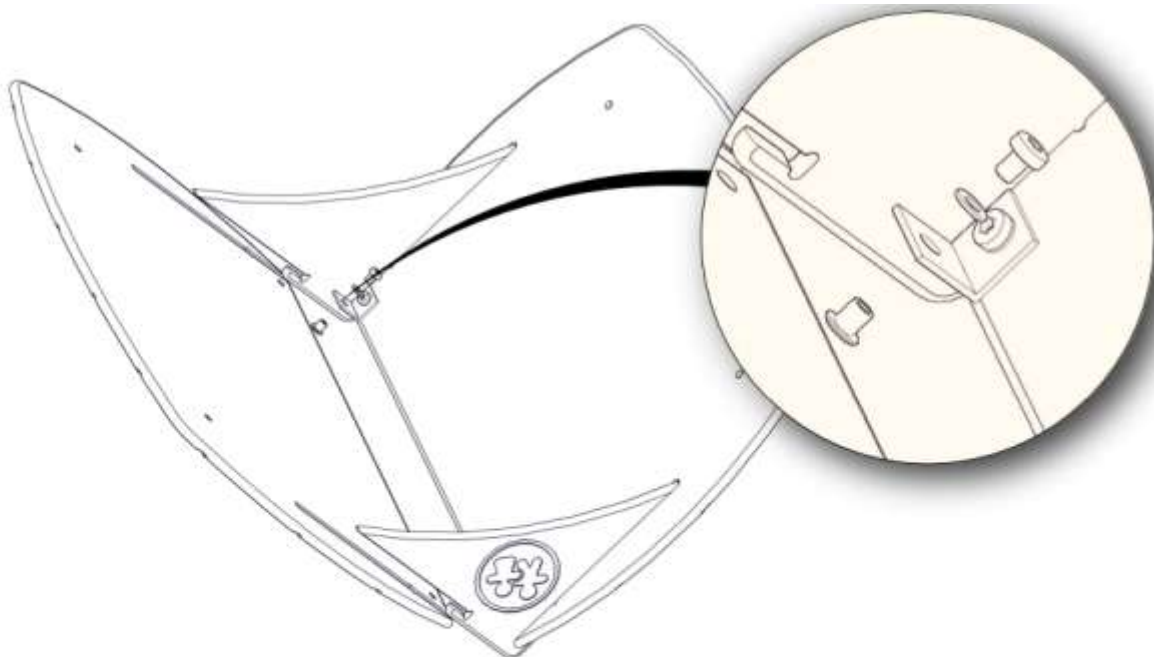





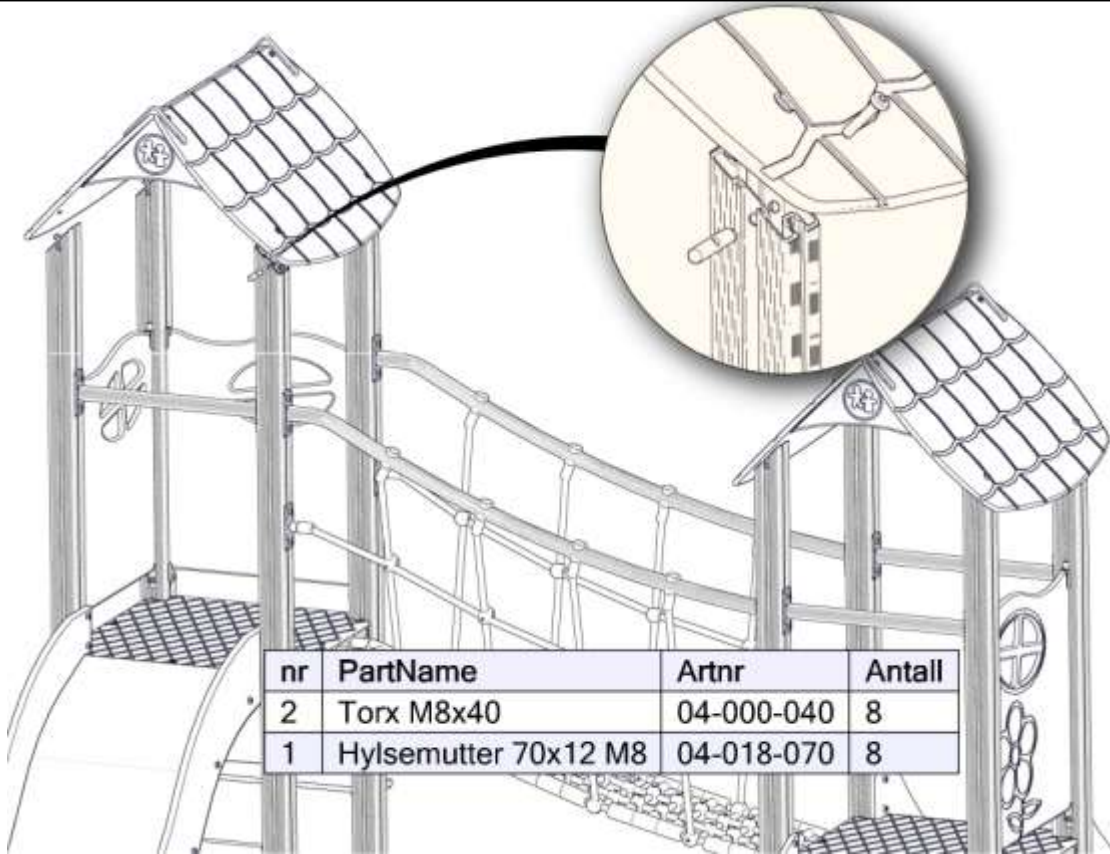



nr	PartName	Artnr	Antall
6	Torx M8x12	04-000-012	4
3	Møbelknapp 16x11	04-030-011	4
4	Skive M8	04-050-008	4
1		04-070-036	2

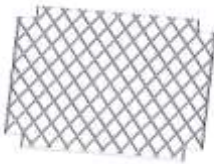













nr	PartName	Artnr	Antall
5	Tak 880x580	07-510-105	2
2	Gavelplate	07-510-106	2



<b>Før utstyret tas i bruk / Before play begins / Innan lekredskapet tas i bruk</b>	
<b>N</b>	<ul style="list-style-type: none"> <li>● Påse at fallunderlag er utlagt i henhold til gjeldende regler eller vår anbefaling</li> <li>● Fjern alle monteringshjelpemidler ( rester av betong, planker, paller, plast, og lignende)</li> <li>● Før utstyret tas i bruk, burde man sjekke at det ikke er fare for at anorakksnorer og lignende som kan hekte seg fast noen steder på lekeapparatet. (Vedlagte snor med dobbe (kneledd) kan brukes til å sjekke at dette er i orden. Se vedlagte veiledning for bruk av denne. Dette gjøres for å oppdage eventuelle feilmonteringer.?)</li> <li>● NB! Bør stå i 2-3 dager før bruk</li> </ul>
<b>EN</b>	<ul style="list-style-type: none"> <li>● Make sure the area and depth of safer surfacing are according to the current standard, or to the manufacturer's recommendation</li> <li>● Make sure all tools and surplus materials are removed before play begins</li> <li>● PS! When complete, allow 2-3 days for the concrete to set before use</li> </ul>
<b>S</b>	<ul style="list-style-type: none"> <li>● Kontrollera att fallunderlag är utlagt enligt gällande regler eller vårt rekommendation</li> <li>● Ta bort alla monteringshjälpmedel (rester av betong, plankor, pallar, plast och liknande)</li> <li>● Innan lekredskapet används, kontrollera att anoracksnoddar eller kläder/delar av kläder eller liknande inte kan fastna i några delar på redskapet. (Den bipackade "knävringen" kan man med fördel användas för denna kontroll.</li> <li>● Detta görs för att upptäcka eventuella felmonteringar.)</li> </ul>



<b>komponenter</b>		Sign. _____.
	VK70 2100-600 skrå 07-510-158	<b>4</b>
	VK70 1700-600 Skrå 07-510-156	<b>4</b>
	Gulv Mini 520 07-510-102	<b>2</b>
	Mini funda- ment skive 07-510-201	<b>8</b>
	Minisprosse fund L=660 07-510-200	<b>8</b>
	Rutsjebane 950 07-510-310	<b>1</b>
	Rutsjebane 550 07-310-305	<b>1</b>
	Vegg 520x600 07-510-120	<b>2</b>
	Vegg 520x600 07-510-120	<b>1</b>
	Vegg 520x400 07-510-110	<b>2</b>
	Vegg Postkasse 520x400 07-510-111	<b>1</b>
	Trapp 550 01-290-090	<b>1</b>
	Sperrerør gulv MED 4 hull 07-510-167	<b>2</b>
	Sperrerør 520 07-510-160	<b>3</b>
	Sperrerør gulv 07-510-161	<b>6</b>
	Rør Skrå 07-510-166	<b>2</b>
	Nett nettbroSkrå 07-510-179	<b>1</b>

<b>komponenter</b>		Sign. _____				
	Torx M8x12 04-000-012	<b>10</b>		Brikke 50-1T 04-060-050	<b>42</b>	
	Torx M8x20 04-000-020	<b>2</b>			Brikke 90-2T 04-060-090	<b>2</b>
	Torx M8x25 04-000-025	<b>68</b>			Brikke 120-3T 04-060-120	<b>18</b>
	Torx M8x30 04-000-030	<b>8</b>		Spesialbrikke 04-060-051	<b>24</b>	
	Torx M8x35 04-000-035	<b>34</b>			Låsemutter M8 04-040-008	<b>18</b>
	Torx M8x40 04-000-040	<b>8</b>				
	Torx M8x45 04-000-045	<b>12</b>				
	Vinkel 35x35x35 04-070-036	<b>4</b>		Skive M8 04-050-008	<b>26</b>	
	Vinkel 50x50x50 04-070-050 11mm	<b>2</b>				
	Møbelknapp M8x13x17 04-030-011	<b>18</b>		Hylsemutter M8 12-70 04-018-070	<b>8</b>	
		04-030-025		<b>16</b>		
	Fundamentplate 00-003-106	<b>6</b>		Saddelwasher 04-210-010	<b>32</b>	
	Takplate mini 07-510-105	<b>4</b>		Gavleplate 07-510-106	<b>4</b>	
	Butikdisk 07-510-130	<b>1</b>		Stålforankring 320 00-100-310	<b>6</b>	