



Monteringsanvisning



Assembly Instructions



Monteringsanvisning

Produkt nr. / Product no. / Produkt nr.

25-200-160

Ord. nr. _____

Dato. _____

Sign. _____

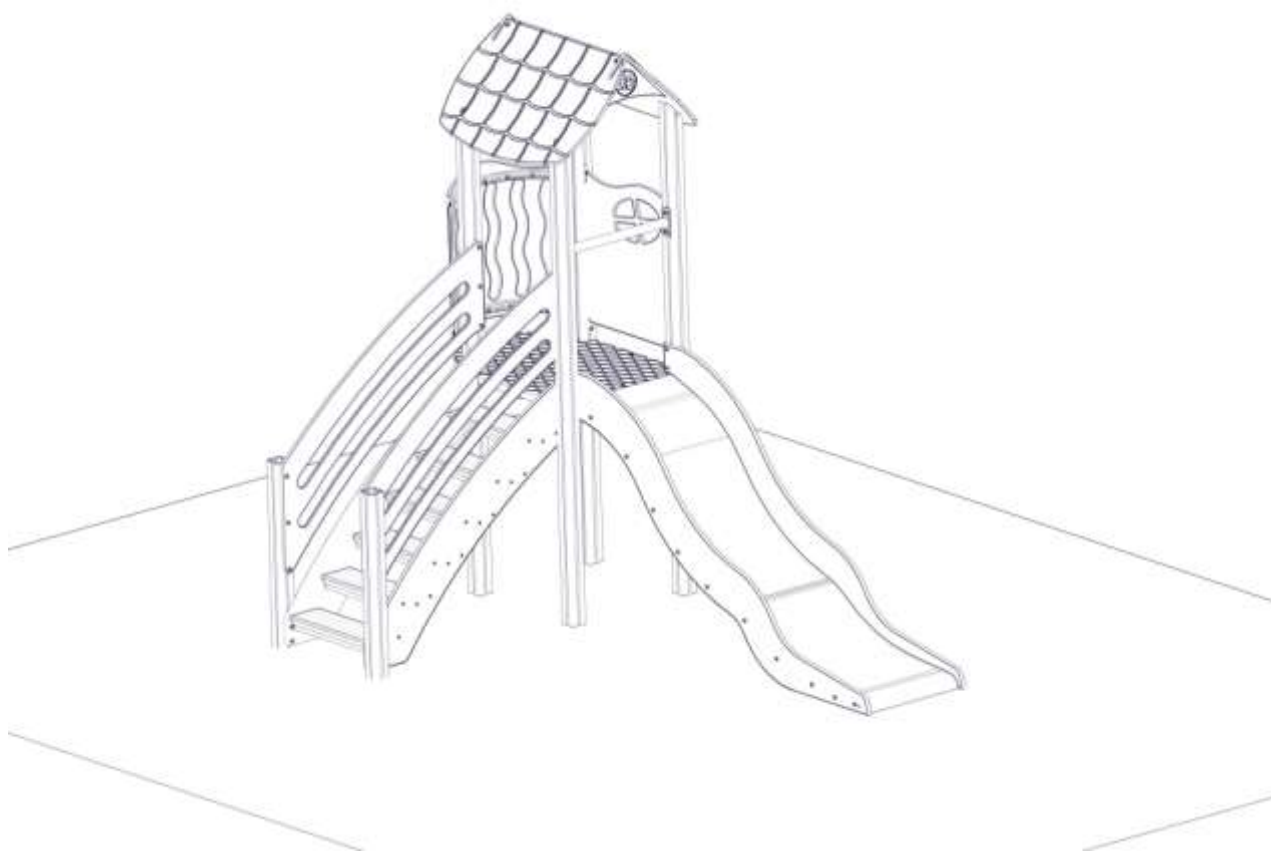

søve

Søve AS
3830 Ulefoss - Norway
Tlf: +47 35 94 65 65
www.sove.no



Søve AB
EA Rosengrensgatan 32
421 31 Västra Frölunda
Phone: +46 (0)31 773 97 00
www.sove.se

Monteringstips / Assembly Advice / Monteringsstips

N

- Les monteringsanvisningen nøye før montering.
- Monter elementene i rekkefølgen som vist.
- Boltene bør ikke skrues for hardt til før alt er montert, vatret og loddet. Skru så boltene til.
- NB! Ved bruk av drill, kan boltene ryke.
- På grunn av at solen kan gjøre rutsjeplatene veldig varme, bør rutsjebanens utløp vende mot nord-øst eller nord-vest.
- Er lekeutstyret plassert i naturlige ferdselstraséer må området sikres mot gjennomgang.
- Innspringningshinder bør vurderes rundt lekeapparater hvor det er stor bevegelse, f.eks. ved huskestativ.
- Det bør være fritt innsyn til lekeutstyr som er beregnet for barn under 3 år.

NB! Under monteringsarbeidet må utstyr, som ikke er forankret forsvarlig i bakken, sikres slik at det ikke velte.

Området må avstenges under montering av apparatene med sperrebånd eller lignende.

EN

- Read the instruction carefully before assembling the play unit..
- Assemble the components in the sequence shown in these instructions.
- Fixings must not be fully tightened during assembly. Before casting the foundations, the structure must be level and plumb, at which point all fixings are tightened.
- PS! If use of drill, the bolts may be wrecked.
- Avoid positioning the slide facing due south because of overheating – ideal positions are facing north-east or north-west.
- Secure the construction-area to prevent people from walking through it.
- Consider installing barriers around play-equipment which gives rise to a lot of activity – i.e. swings.
- Ensure that clear vision is possible across the play area so that supervision is possible from any position, particularly where children under 3 years of age will be playing.

NB! During assembly of the equipment, ensure that all structures are securely propped, especially when left overnight. Also ensure that equipment is supported whilst concrete foundations are setting and enclose the area securely to prevent access.

Monteringstips / Assembly Advice / Monteringsstips**S**

- Läs monteringsanvisningen noga före montering.
- Montera delarna i den ordningen som anvisas
- Skruvarna bör inte skruvas för hårt tills allt är monterat, i våg och lodat.









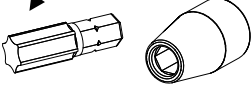

OBS! Används elektrisk skruvdragare, kan bulten gå sönder. Härddra därför manuellt!

- Solen kan göra att rutchbanan blir väldigt varm. Banans nedfart rekommenderas att vändas i norrlig riktning
- Om lekplatsen placeras vid en gångväg mm bör området säkras mot genomfart av gående och cyklister.
- Inspångningshinder bör placeras runt lekutrustning med stor rörelse, t ex, gungställning.
- Det bör vara fri insyn till lekutrustning beräknat till barn under 3 år.

OBS! Under monteringsarbete bör utrustningen som inte ska förankras i marken, ställs så att den inte kan välta.

Området måste spärras när lekutrustningen byggs upp, med avspärrningsband eller liknande.

Nødvendig verktøy / Tools required / Nödvändiga verktyg

<p>(N)</p> <p>(UK)</p> <p>(S)</p>	<p>(A)</p> 	<p>(B)</p>  <p>Torx Nr 45 High quality</p> 	<p>(C)</p> <p>5 mm 6 mm</p> 	<p>(D)</p> 	<p>(E)</p> 
		<p>Metermål Metric measure Tumstoc</p> 	<p>16 V</p> 	<p>Merkebånd Mark ribbon Märkeband</p> 	<p>13 + 17mm</p> 

Nødvendig antall personer / Number of persons required / Lämpligt antal personer





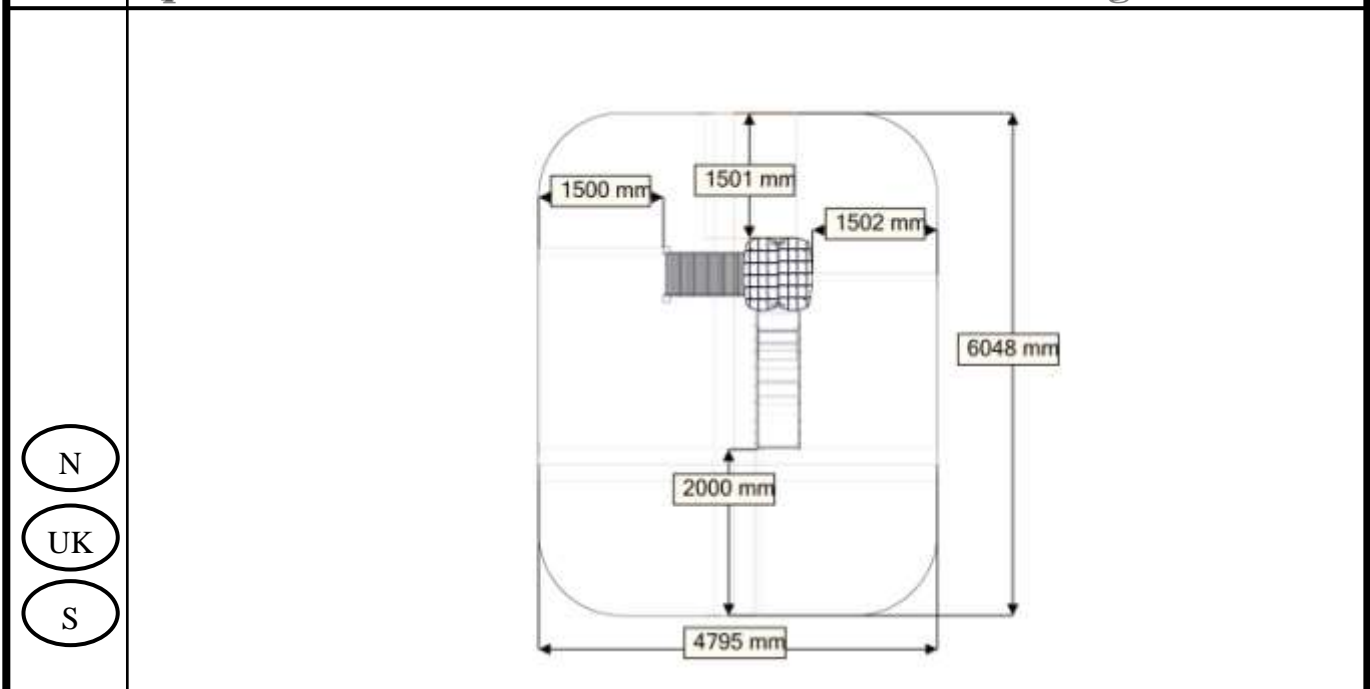





Anbefalt arealbehov ved montering / Recommended working space / Rekommenderad arealbehov vid montering

















Boltepakker for / Boltpackage for / Bultpaket för

Sign. _____.

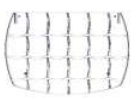
Stolpe 70x70 skrå	Ant= 4	Navn	Artnr/dimensjon	Ant	Lev
		VK70 2100-600 (1) Skrå Brikke på stolpe!	07-510-158	4	
		Torx M8x40 (1)	04-000-040	4	
		Hullsemutter (1) VK70	04-018-070	4	
FundamentMini 660	Ant= 4	Navn	Artnr/dimensjon	Ant	Lev
		miniSprosse 660 (1)	07-510-200	4	
		Brikke 50_1T (2)	04-060-040	8	
		Torx M8x35 (2)	04-000-035	8	
FundamentSkive	Ant= 4	Navn	Artnr/dimensjon	Ant	Lev
		Skive (1)	07-510-201	4	











Boltepakker for / Boltpackage for / Bultpaket för

Sign. _____.

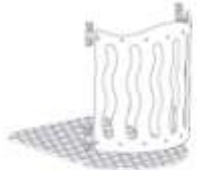
Sperrerør 520	Ant= 1	Navn	Artnr/dimensjon	Ant	Lev
		Sperrerør 520 (1)	07-510-160	1	
		Brikke 120_3T (2)	04-060-120	2	
		Torx M8x25 (4)	04-000-025	4	
Sperrerør 520 gulv	Ant= 4	Navn	Artnr/dimensjon	Ant	Lev
		Sperrerør 520 (1)	07-510-161	4	
		Brikke 90_2T (2)	04-060-090	0 På stolpe	
		Torx M8x25 (2)	04-000-025	8	
Tak	Ant= 1	Navn	Artnr/dimensjon	Ant	Lev
		Tak mini (2)	07-510-105	2	
		Gavelplate(2)	07-510-106	2	
		Vinkel 35x35x3(2) 11mm	04-070-036	2	
		Møbelknapp	04-030-011	4	
		Torx M8x12(4)	04-000-012	4	
		Skive M8 (4)	04-050-008	4	







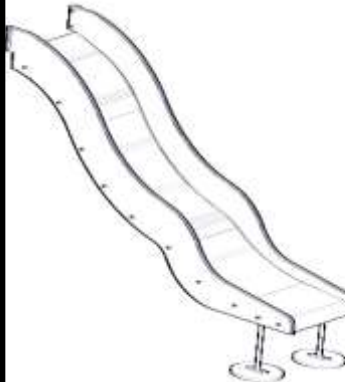

Boltepakker for / Boltpackage for / Bultpaket för

Sign. _____.

Vegge 520x600 Vindo bloms	Ant= 1	Navn	Artnr/dimensjon	Ant	Lev
		Vegge520x600 (1) Vindu blom	07-510-120	1	
		Brikkespesial(4)	04-060-041	4	
		Brikke(4)	04-060-040	4	
		Torx M8x25(4)	04-000-025	4	
Utsikt	Ant= 1	Navn	Artnr/dimensjon	Ant	Lev
		Utsikt med sperrerør (1)	07-510-134	1	
		Gulv til utsikt (4)	05-510-101	1	
		Torx M8x45 (4) Torx M8x25(8)	04-000-045 04-000-025	4 8	
		Møbelknapp M8x13x17	04-030-011	4	
		Brikke 120_3T	04-060-120	4	













Boltepakker for / Boltpackage for / Bultpaket för

Sign. _____.

Rutsjebane 950 07-510-310	Ant= 1	Navn	Artnr/dimensjon	Ant	Lev
		Rutsjebane	07-510-310	1	
		Brikke120 3T(5)	04-060-120	2	
		Torx M8x35(4)	04-000-035	4	
		Torx M8x45(2)	04-000-045	2	
		Torzx M8x30(4)	04-000-030	4	
		Fundamentskive(2) 2H 80	00-003-106	2	
		Skive M8(2)	04-050-008	6	
		Mutter M8(2)	04-040-008	6	
	Stålforankering(2)	00-100-312	2		

Boltepakker for / Boltpackage for / Bultpaket för

Sign. _____

Stolpe 70x70	Ant= 2	Navn	Artnr/dimensjon	Ant	Lev
		VK70x70 (1) 600-800=1400	07-510-455	2	
		Stolpende	00-400-996	2	
FundamentMini 660	Ant= 2	Navn	Artnr/dimensjon	Ant	Lev
		miniSprosse 660 (1)	07-510-200	2	
		Brikke 50_1T (2)	04-060-040	4	
		Torx M8x35 (2)	04-000-035	4	
FundamentSkive	Ant= 2	Navn	Artnr/dimensjon	Ant	Lev
		Skive (1)	07-510-201	2	
Trapp 950	Ant= 1	Navn	Artnr/dimensjon	Ant	Lev
		Trapp 950	07-510-451	1	
		Rekkverk trappa	07-510-454	2	
		Brikke 50 1T	04-060-040	16	
		Brikke 90 2T	04-060-090	2	
		Torx M8x35	04-000-035	20	

Fundamentering med betong / Foundation concrete / Förankring med betong

(N)	Støtsand		(N)	(UK)	(S)
(UK)	Safer surface		Bakkenivå	Ground level	Marknivå
(S)	Stridsan		Ref NS-EN 177		
(N)	Komprimert masse.	betong			
(UK)	Compressed mass.	concrete			
(S)	Komprimerad massa.	betong			

Fundamentering uten betong / Foundation without concrete / Förankring utan betong

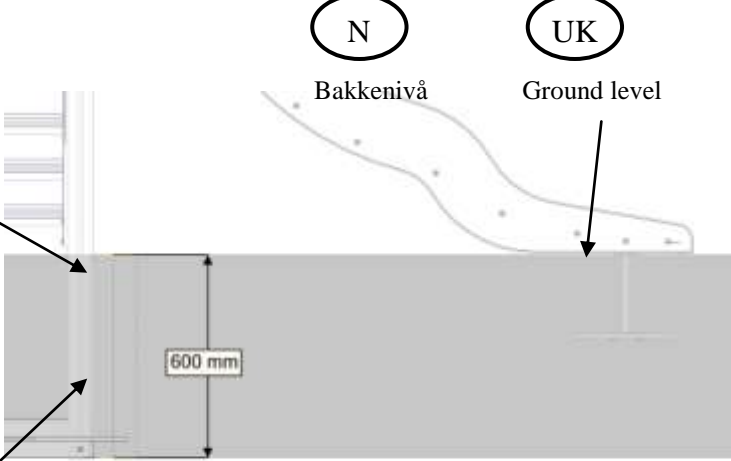
(N)	Støtsand		(N)	(UK)	(S)
(UK)	Safer surface		Bakkenivå	Ground level	Marknivå
(S)	Stridsan		Ref NS-EN 1177		
(N)	Komprimert masse	Støpefri nedgraving			
(UK)	Compressed mass	Concrete-free anchor			
(S)	Komprimerad massa	Nedgravningsfundament			

(N)	Alle mål er oppgitt i millimeter
(UK)	Scale measured in mm
(S)	Alla mått är i millimeter.

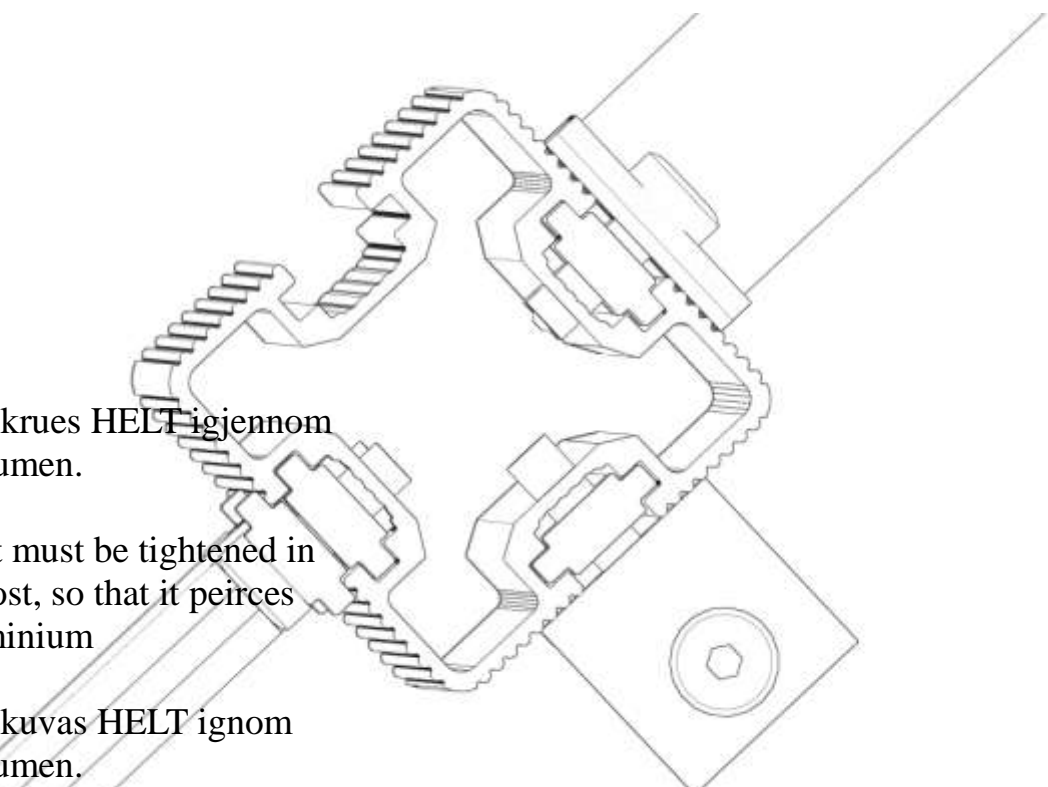
<p>N</p> <p>UK</p> <p>S</p>	 <p>Bolten skrues HELT igjennom aluminiumen.</p> <p>The bolt must be tightened in to the post, so that it pierces the aluminium</p> <p>Bulten skruvas HELT igjennom aluminiumen.</p>

Fallhøyder / Free height of fall / Fallhöjder

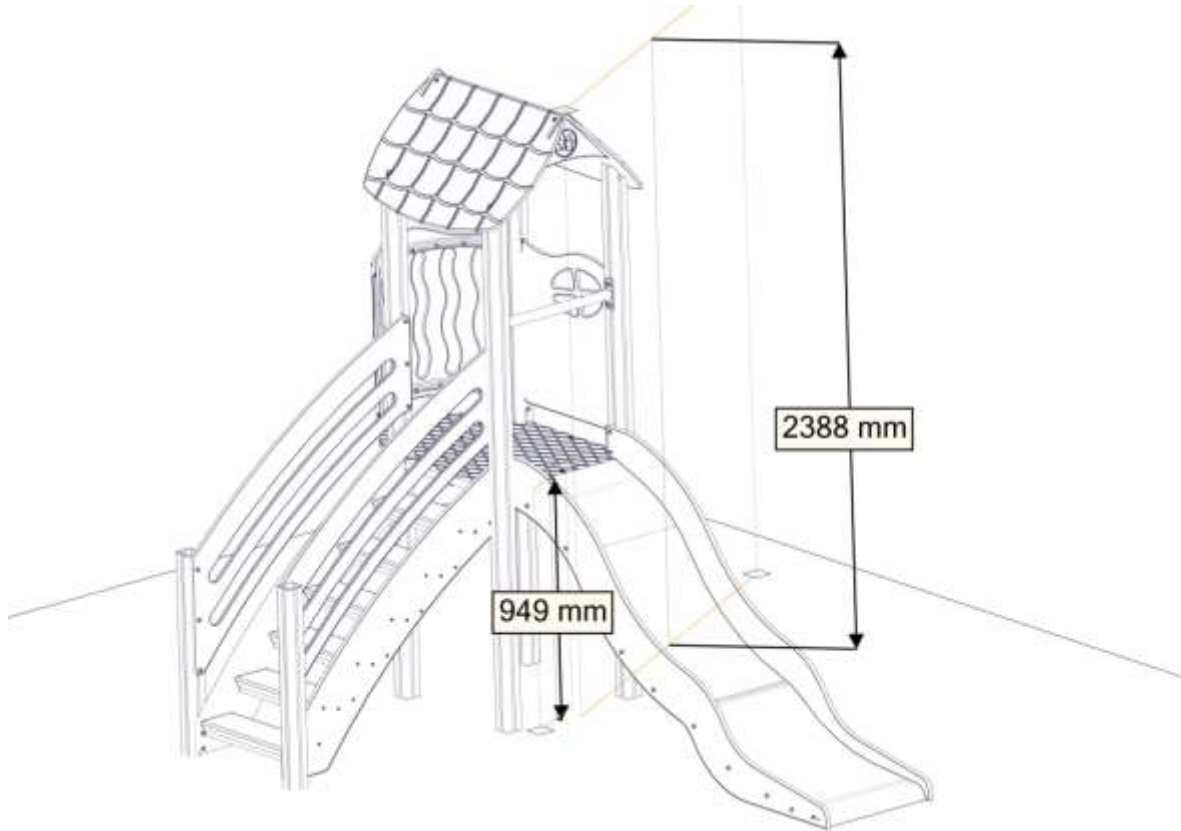

Sikkerhetszone / Safety zone / Säkerhetszon

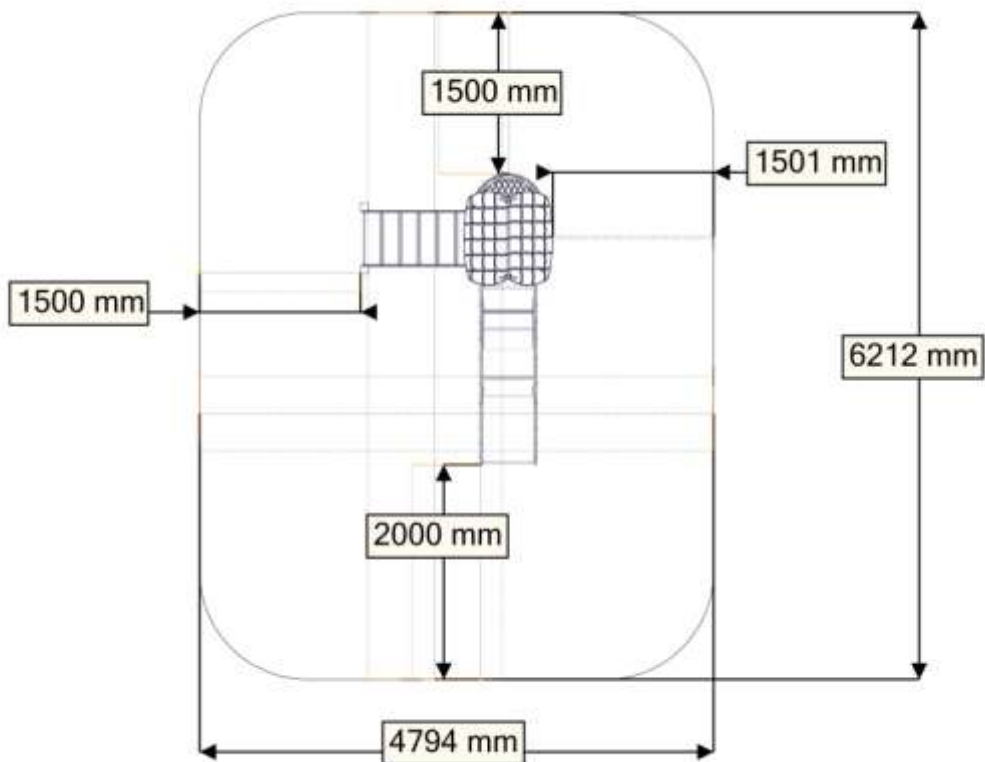

Plassering av forankringer / Ground plan / Placering av förankringar

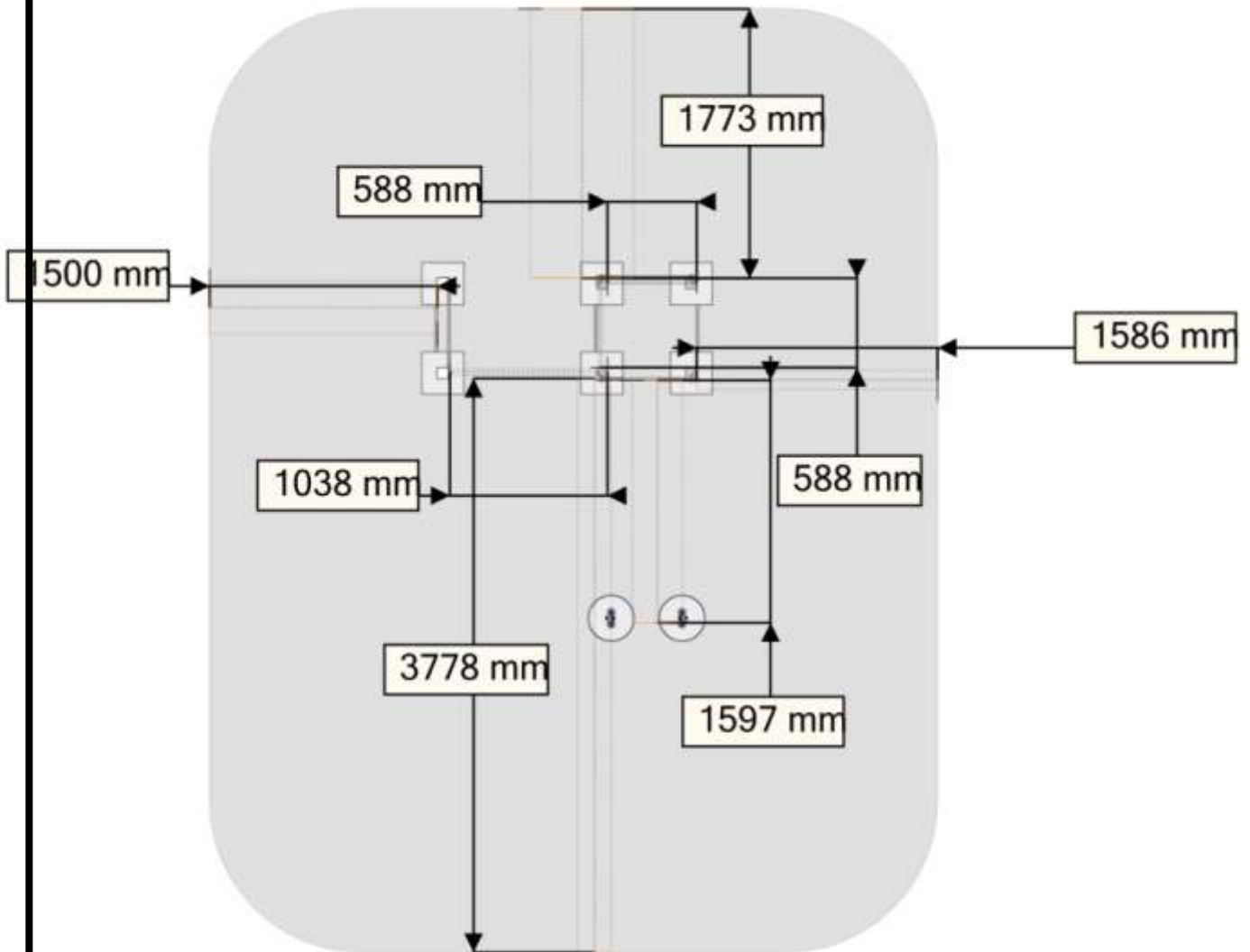

N

Alle mål er oppgitt i millimeter

UK

Scale measured in mm

S

Alla mått är i millimeter.

Montering av lekeapparatet / Assembly instructions / Montering av lekredskapet

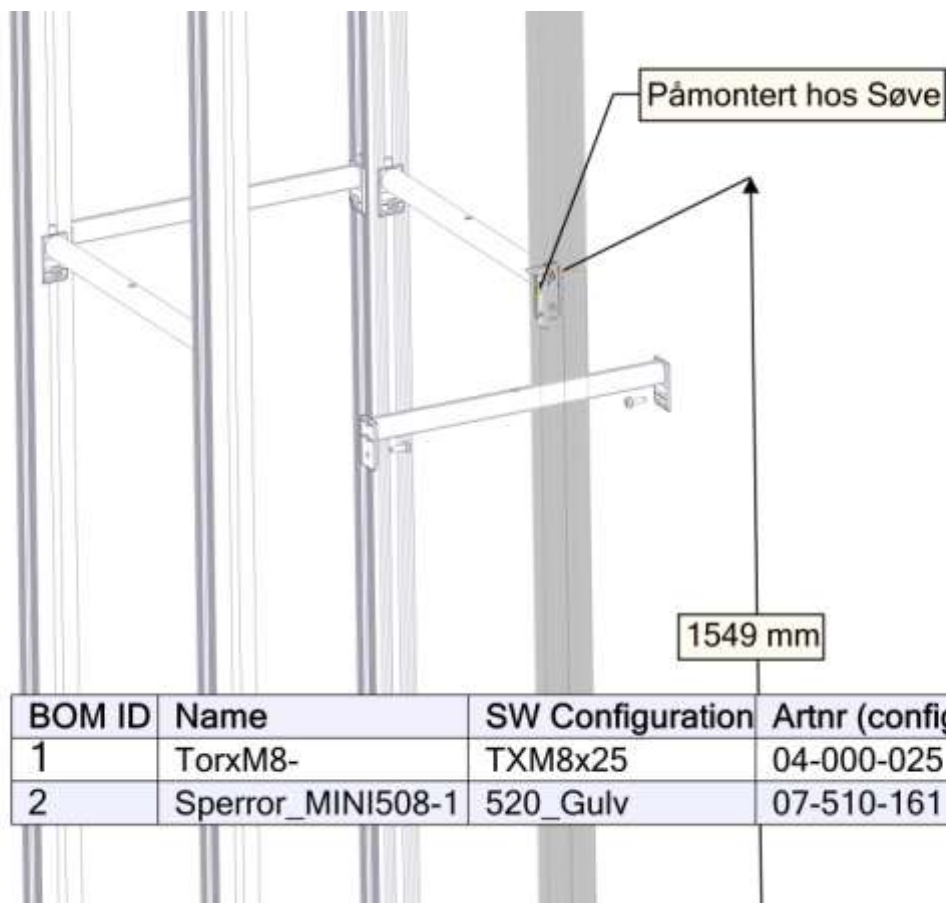

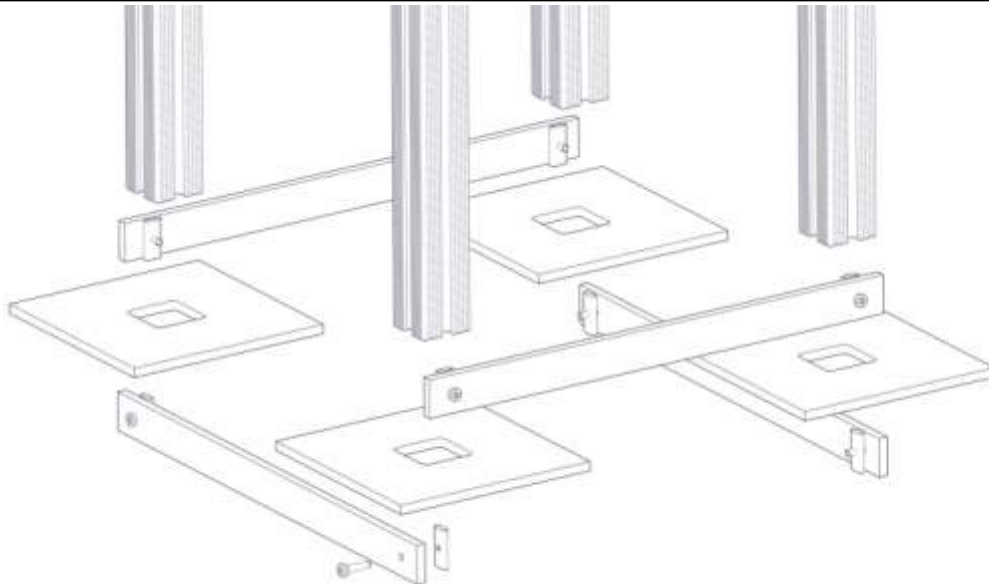

BOM ID	Name	SW Configuration	Artnr (config)	Qty
1	TorxM8-	TXM8x35	04-000-035	8
2	brikke_SFA5116-	50_1T	04-060-050	8
3	minifun_sprosse-1	660	07-510-200	4
4	minifunSkive-	Default	07-510-201	4

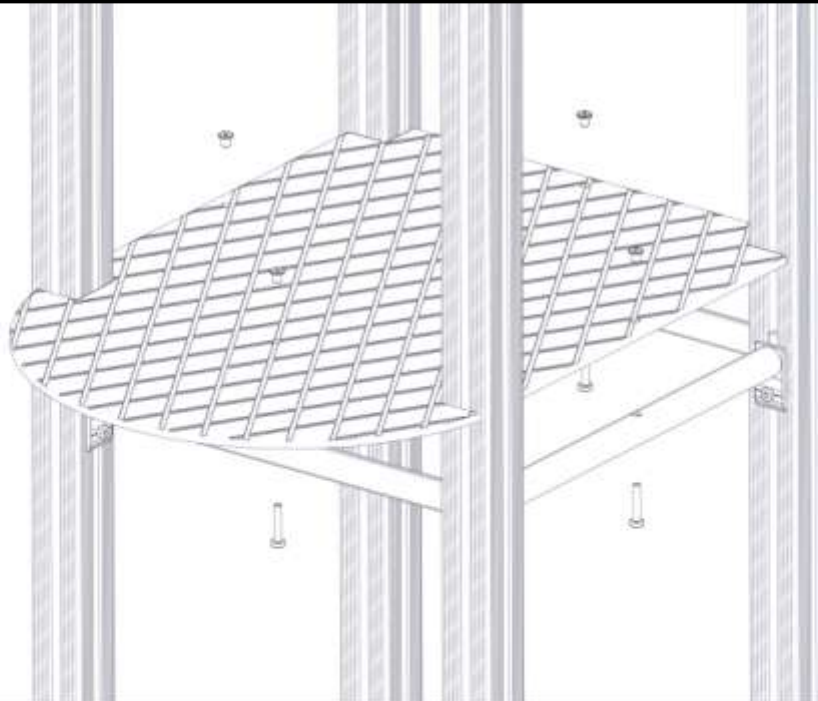
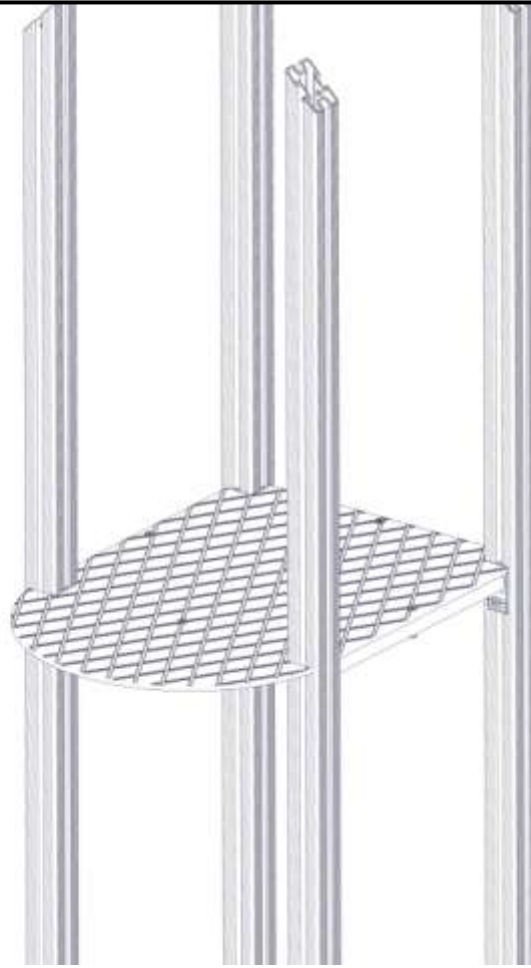

BOM ID	Name	SW Configuration	Artnr (config)	Qty
1	Mobelknapp-1	M8_13_17	04-030-011	4
2	Torxm8-1	TXM8x45	04-000-045	4
3	gulvmini_utsiktV3-1	Default	07-510-101	1

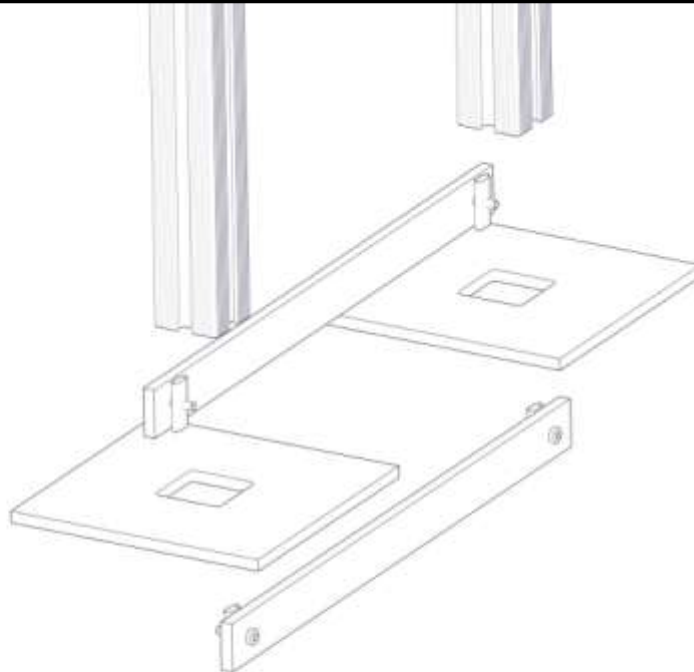
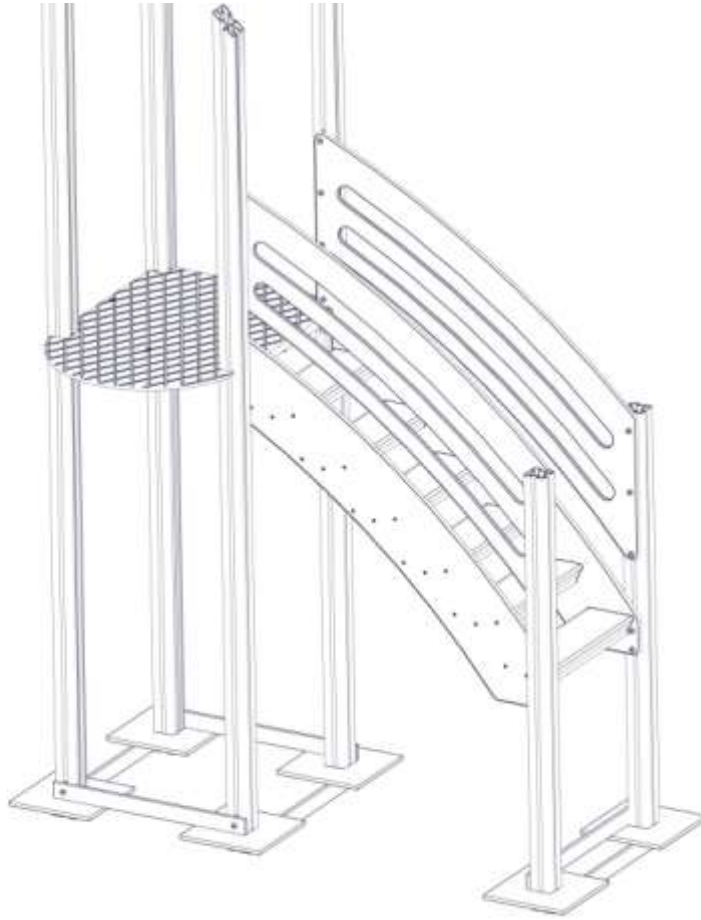

BOM ID	Name	SW Configuration	Artnr (config)	Qty
1	Torxm8-	TXM8x35	04-000-035	4
2	brikke_SFA5116-	50_1T	04-060-050	4
3	VK70_SFA5123-1	600-800	07-510-455	2
4	minifun_sprosse-1	660	07-510-200	2
5	minifunSkive-	Default	07-510-201	2

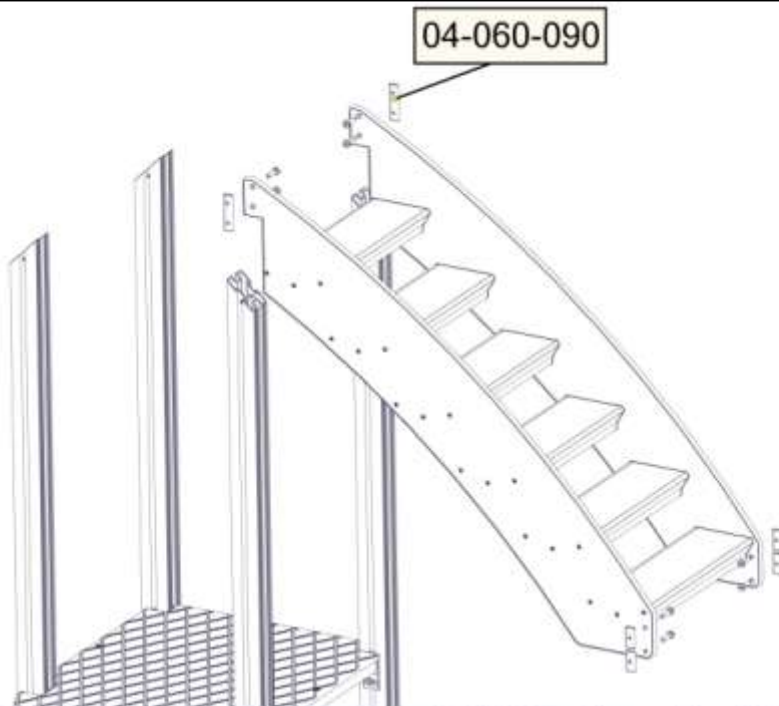

BOM ID	Name	SW Configuration	Artnr (config)	Qty
1	Torxm8-	TXM8x35	04-000-035	8
2	brikke_SFA5116-	50_1T	04-060-050	4
3	brikke_SFA5116-	90_2T	04-060-090	2

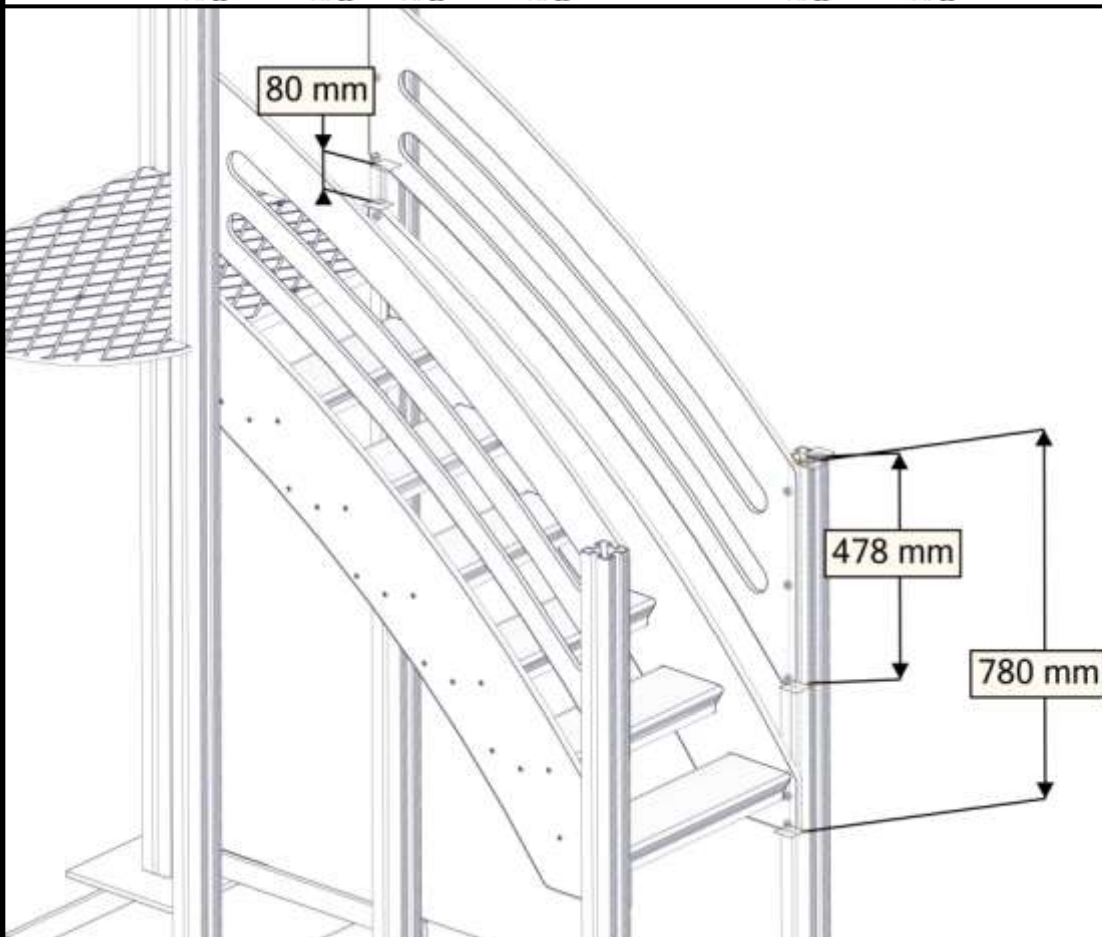

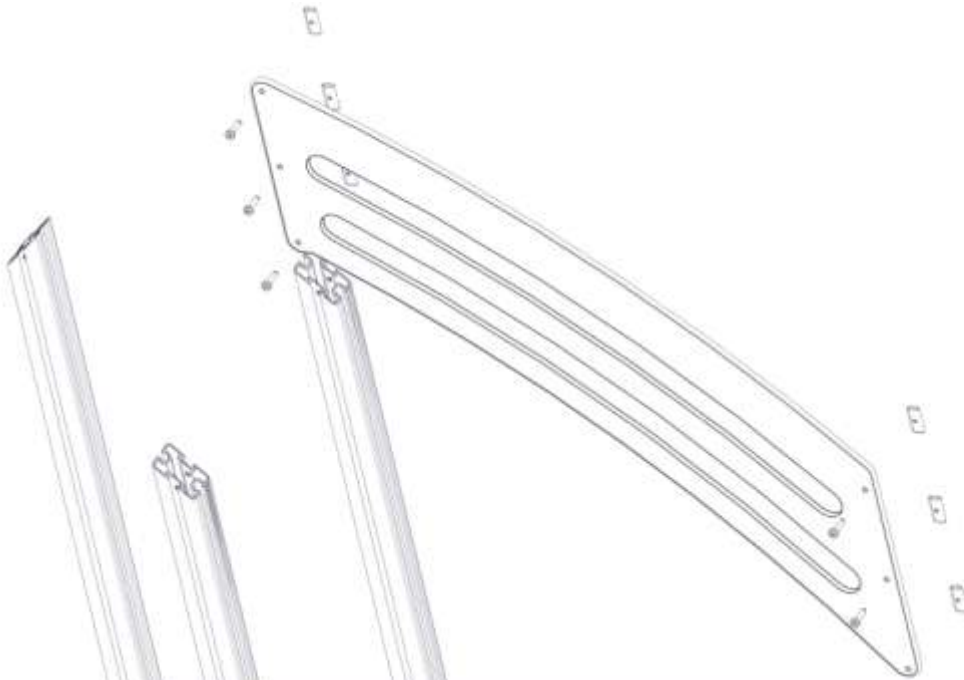
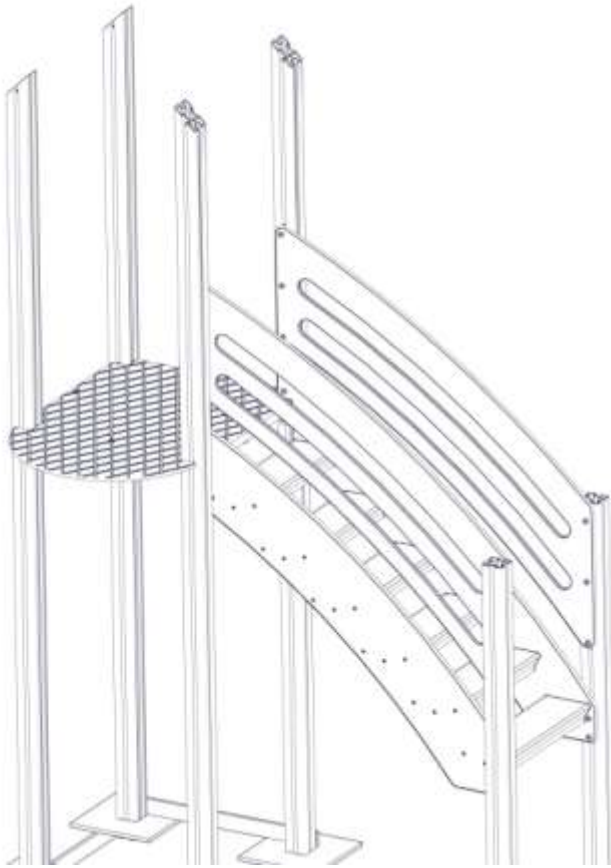

BOM ID	Name	SW Configuration	Artnr (config)	Qty
1	Torxm8-1	TXM8x35	04-000-035	12
2	brikke_SFA5116-1	50_1T	04-060-050	12
3	TreppeRekkverk950_V2-1	V	07-510-454	1
4	TreppeRekkverk950_V2-2	V	07-510-454	1

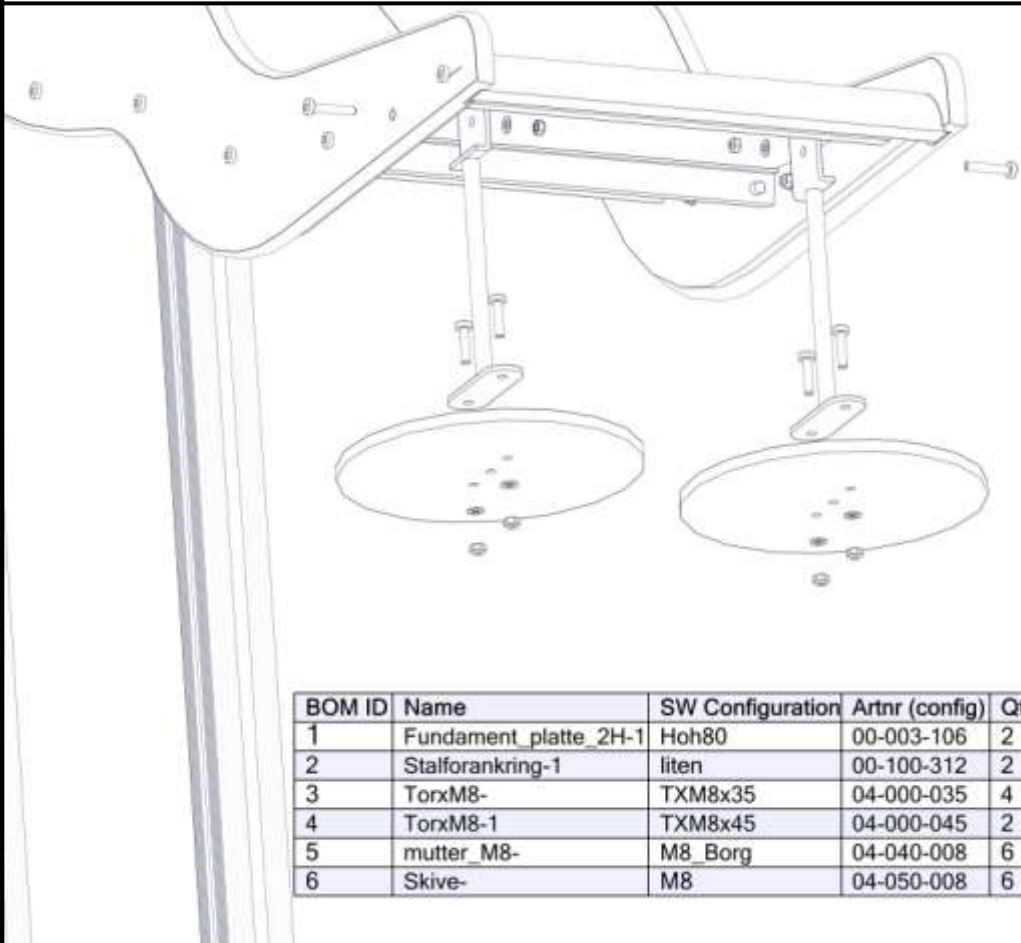
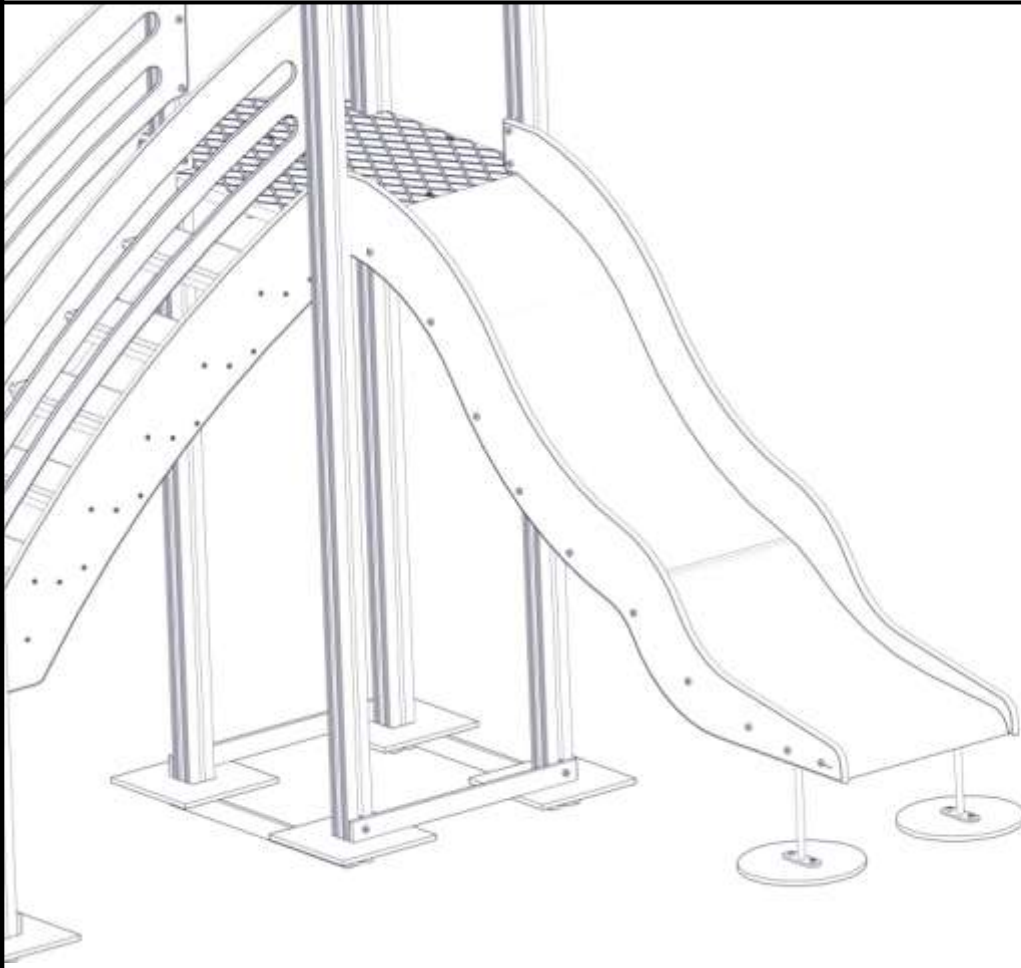

BOM ID	Name	SW Configuration	Artnr (config)	Qty
1	Fundament_platte_2H-1	Hoh80	00-003-106	2
2	Stalforankring-1	liten	00-100-312	2
3	Torxm8-	TXM8x35	04-000-035	4
4	Torxm8-1	TXM8x45	04-000-045	2
5	mutter_M8-	M8_Borg	04-040-008	6
6	Skive-	M8	04-050-008	6

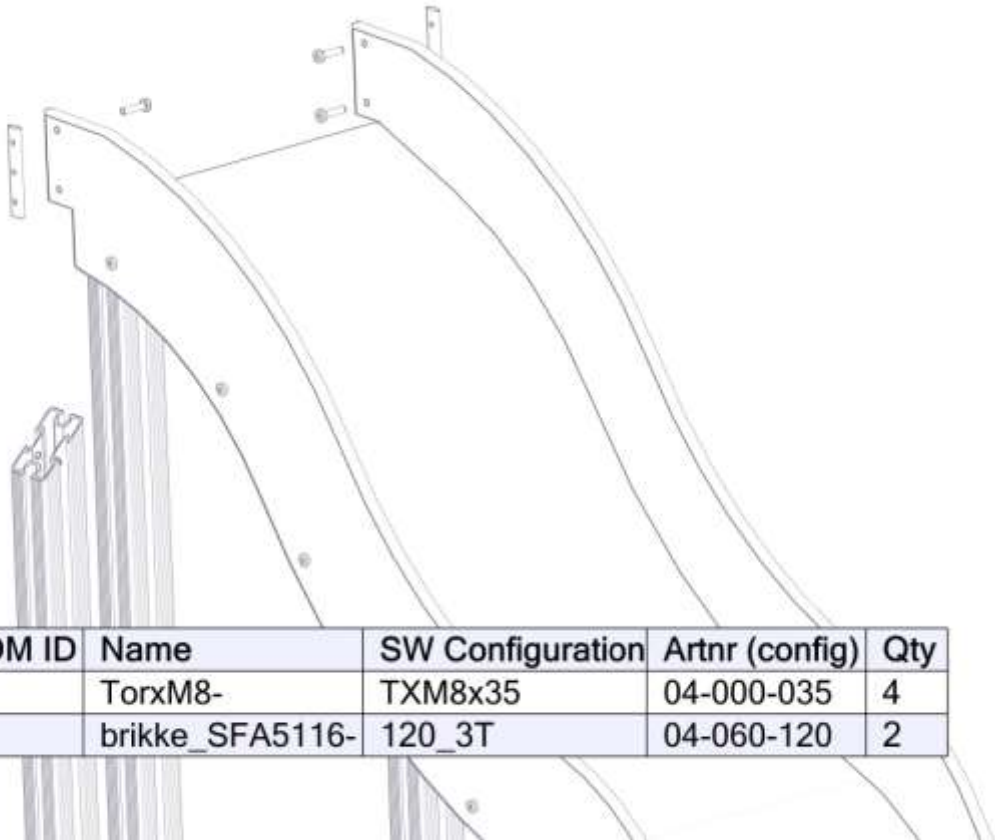

BOM ID	Name	SW Configuration	Artnr (config)	Qty
1	TorxM8-	TXM8x35	04-000-035	4
2	brikke_SFA5116-	120_3T	04-060-120	2

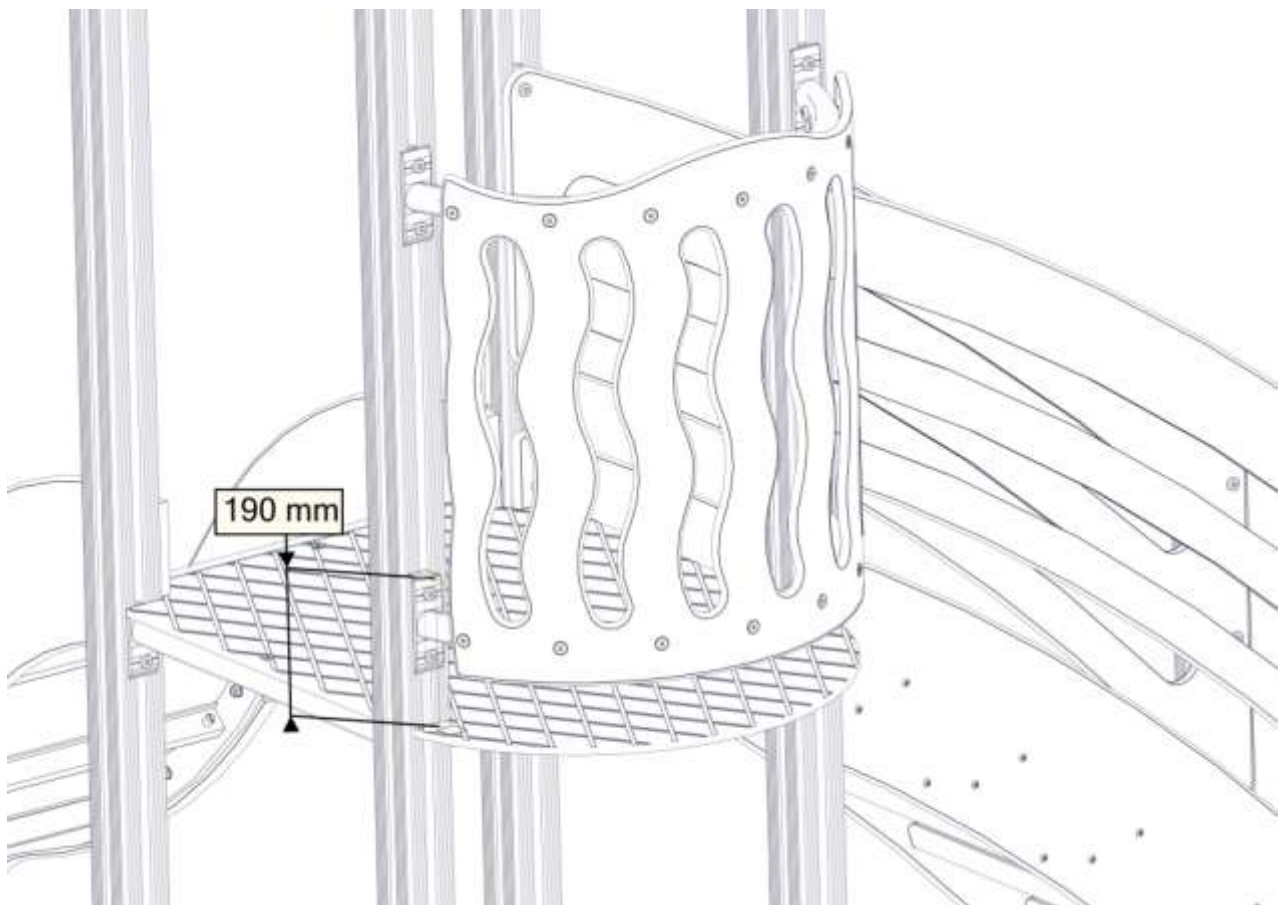

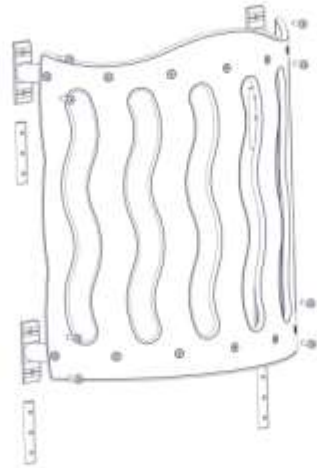

BOM ID	Name	SW Configuration	Artnr (config)	Qty
1	Torxm8-	TXM8x25	04-000-025	8
2	brikke_SFA5116-1	120_3T	04-060-120	4
3	HDPE_Utsikt_V3-1	Default	07-500-????	1

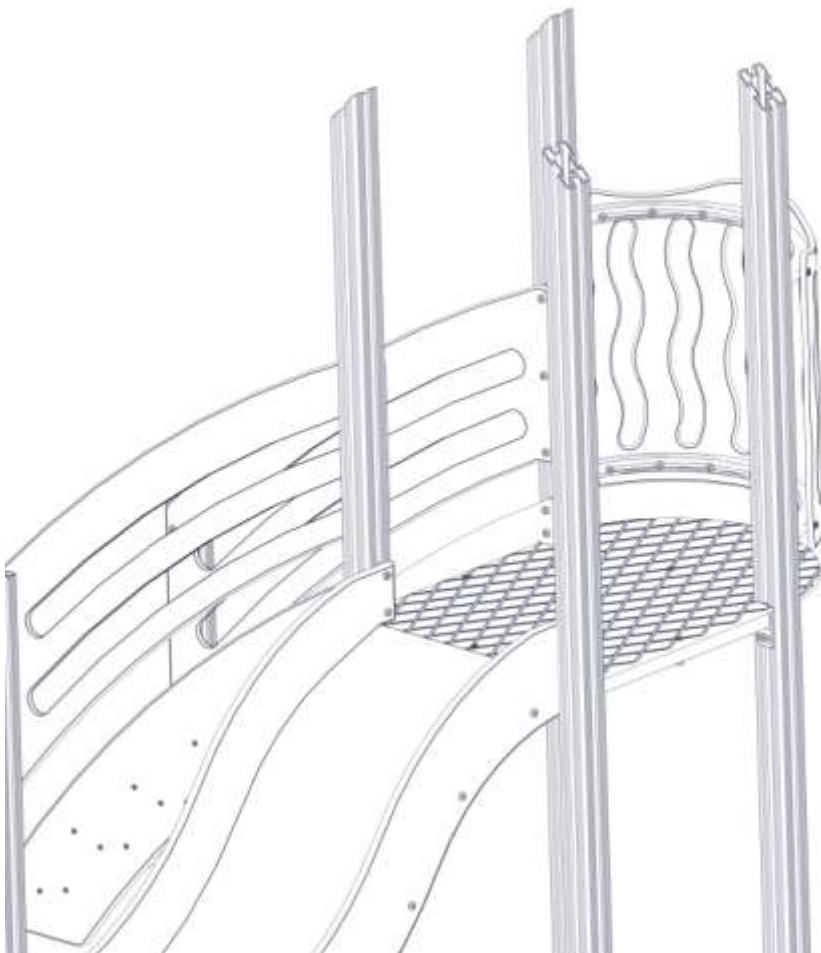

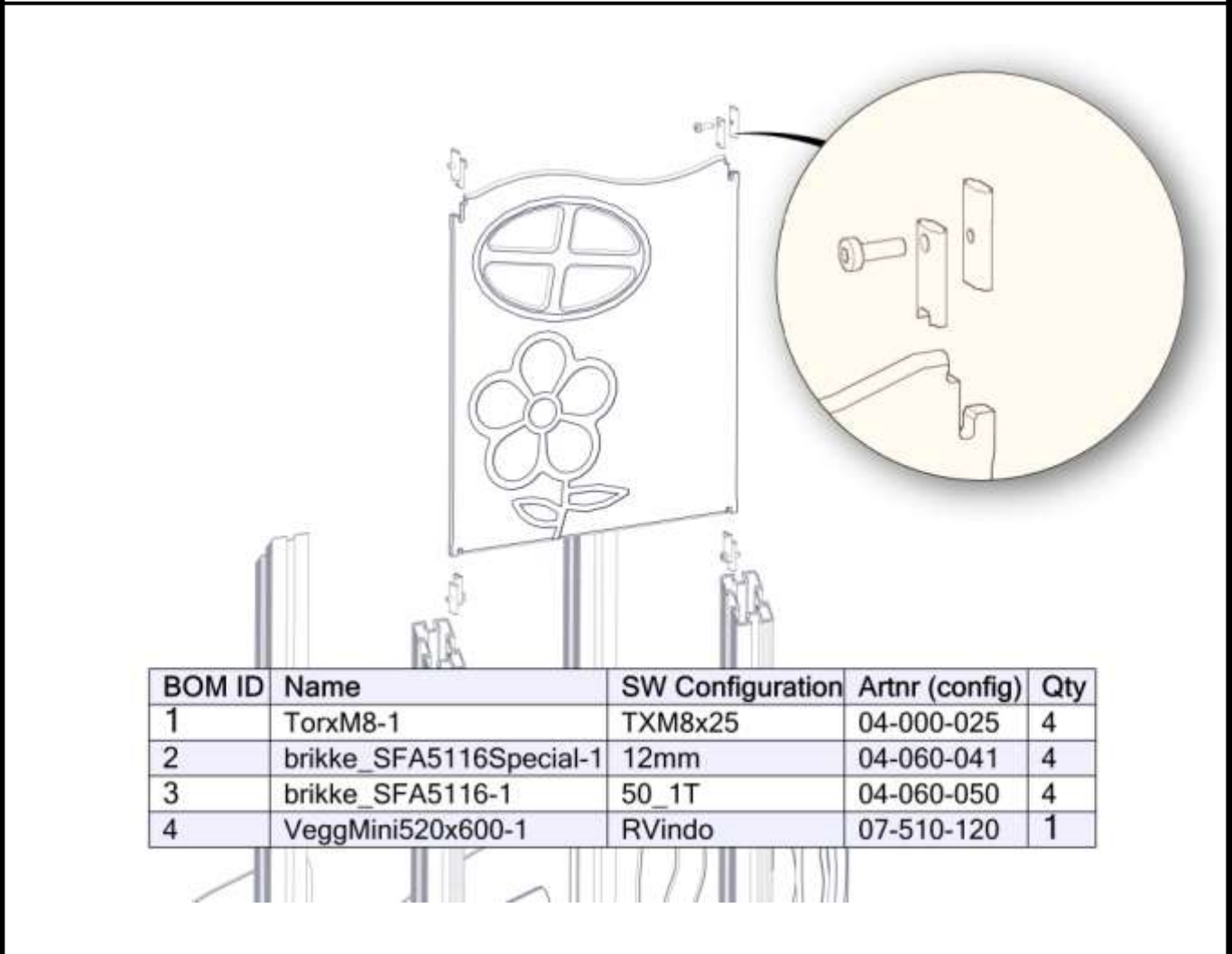
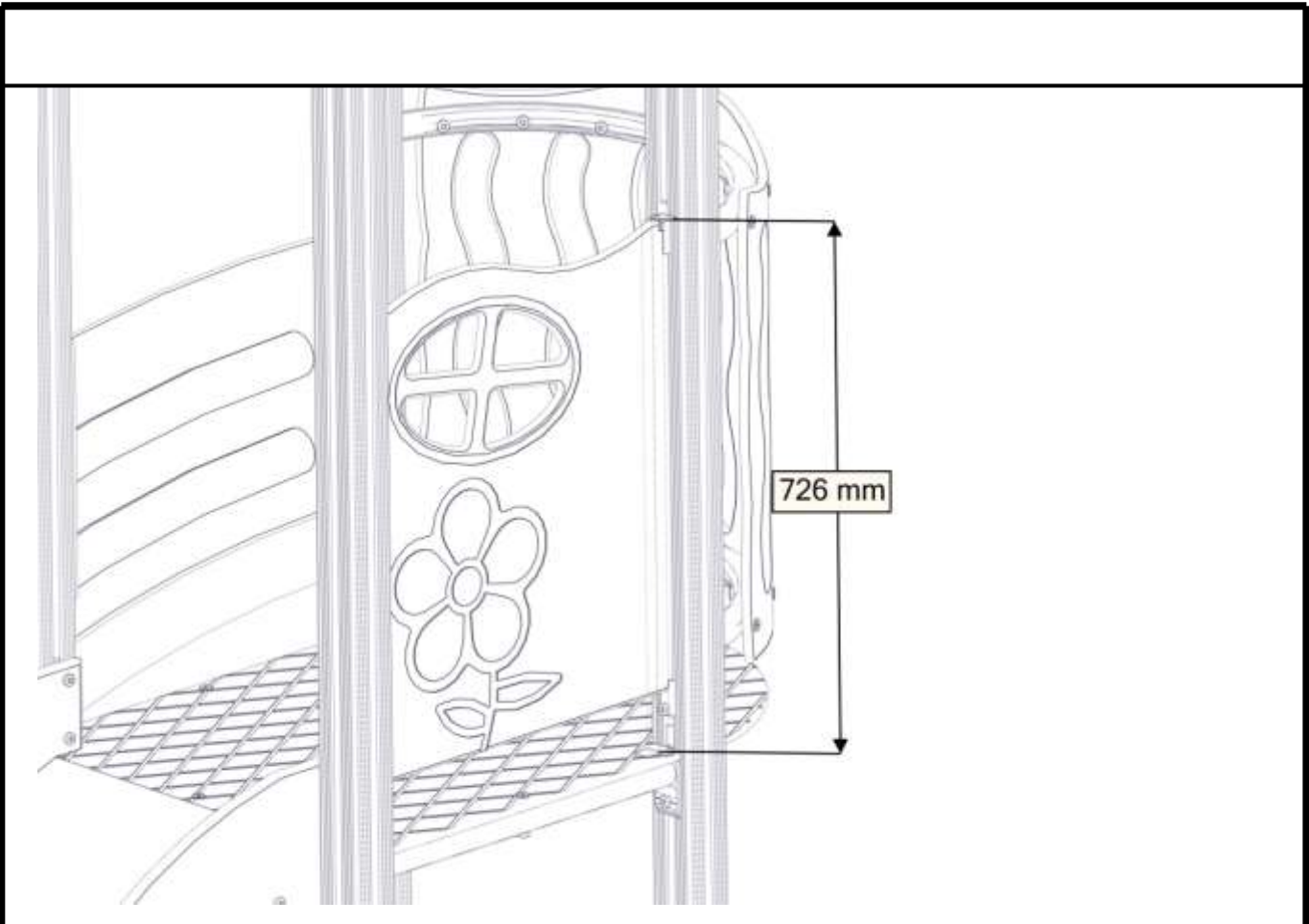

BOM ID	Name	SW Configuration	Artnr (config)	Qty
1	TorxM8-1	TXM8x25	04-000-025	4
2	brikke_SFA5116Special-1	12mm	04-060-041	4
3	brikke_SFA5116-1	50_1T	04-060-050	4
4	VeggMini520x600-1	RVindo	07-510-120	1

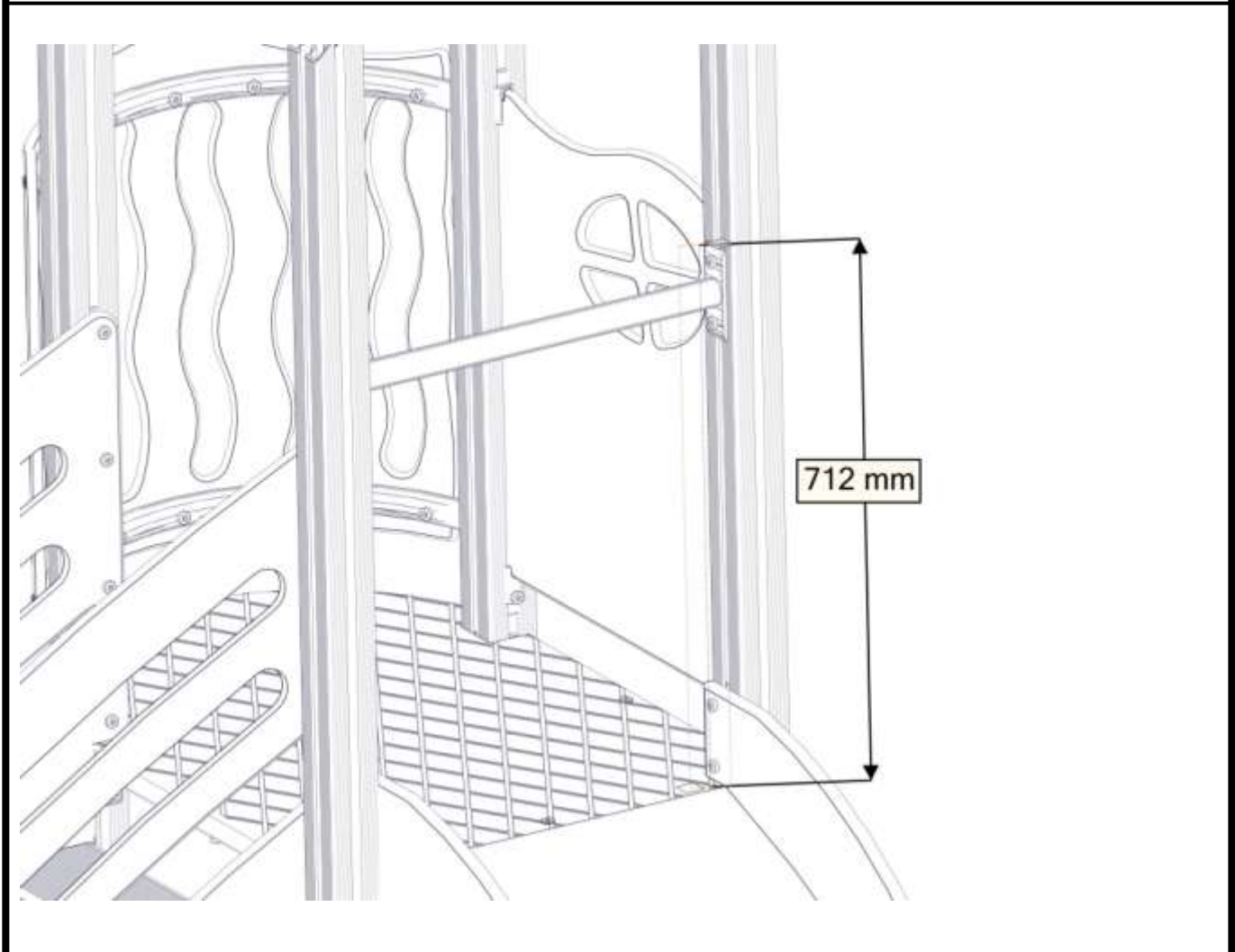
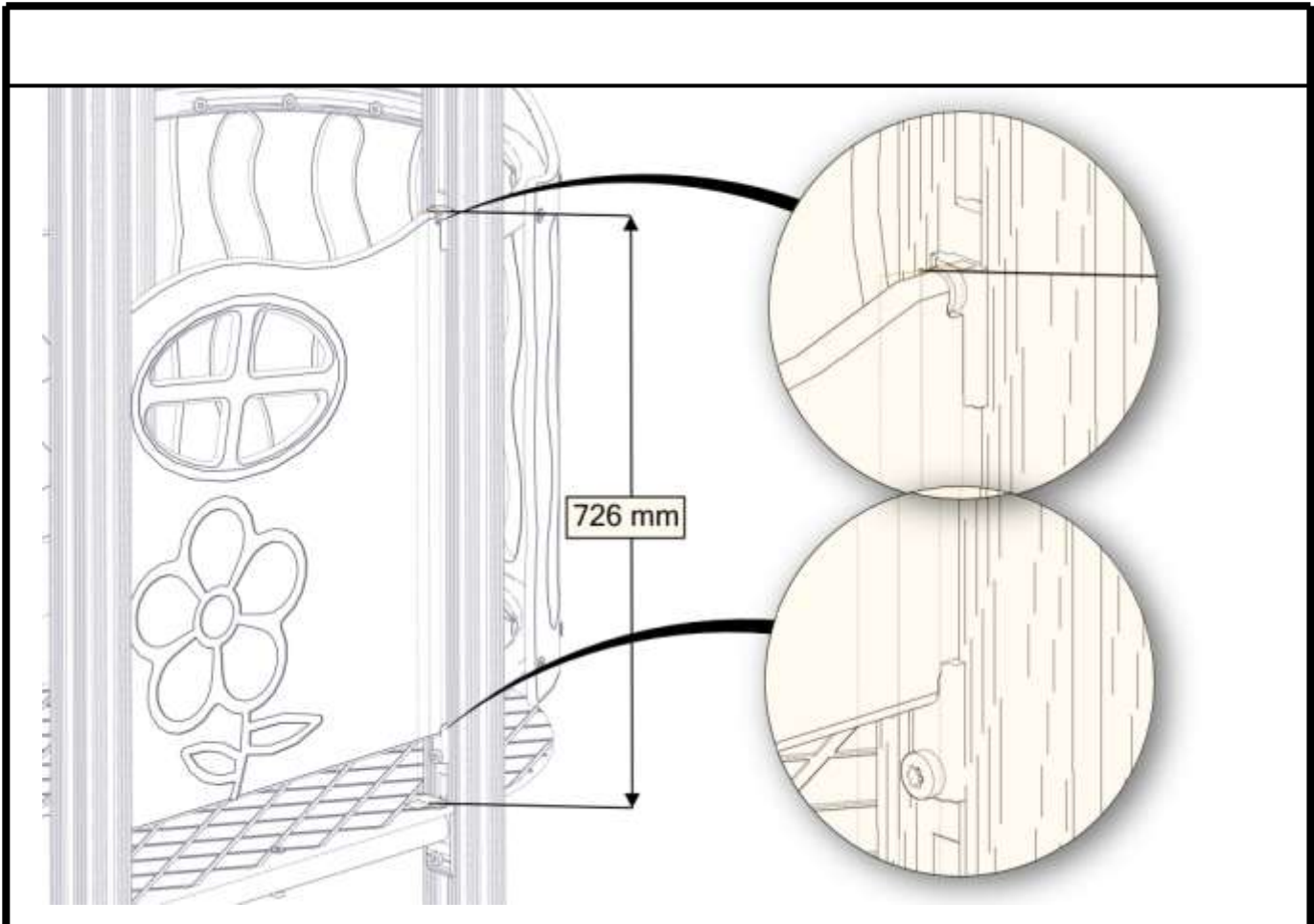

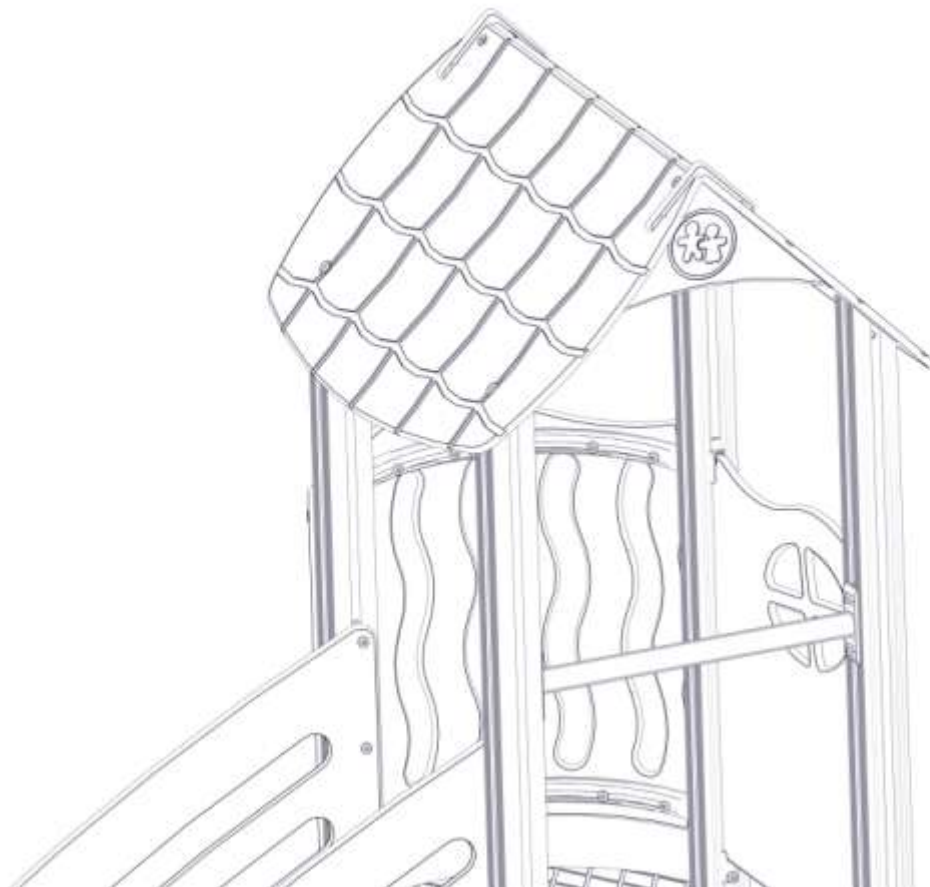
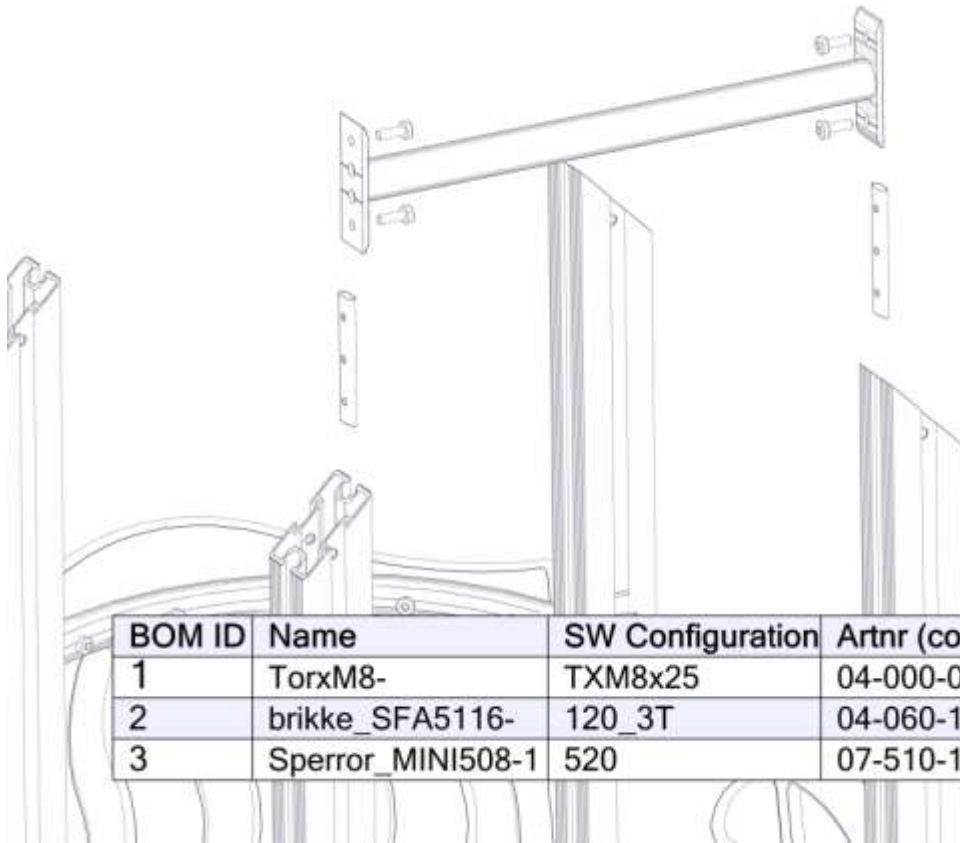

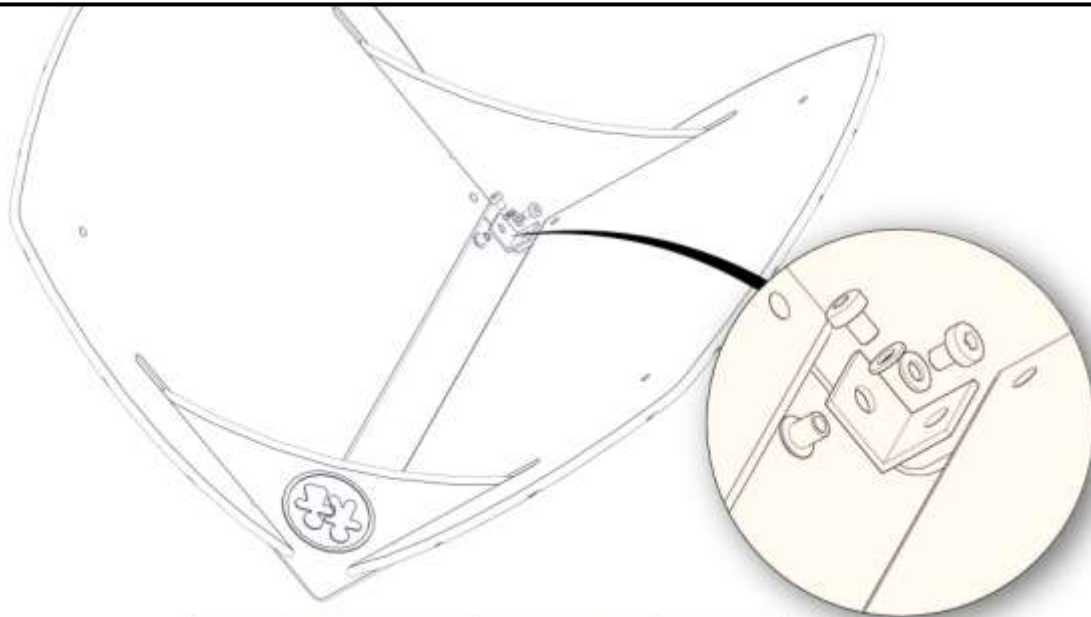

BOM ID	Name	SW Configuration	Artnr (config)	Qty
1	TorxM8-	TXM8x12	04-000-012	4
2	Mobelknapp-	M8 13 17	04-030-011	4
3	Skive-	M8	04-050-008	4
4	35x35x3-1	11mm	04-070-036	2
5	Tak_Miniserie2011-	rod	07-510-105	2
6	Gavelplatemini2011-	Rod	07-510-106	2

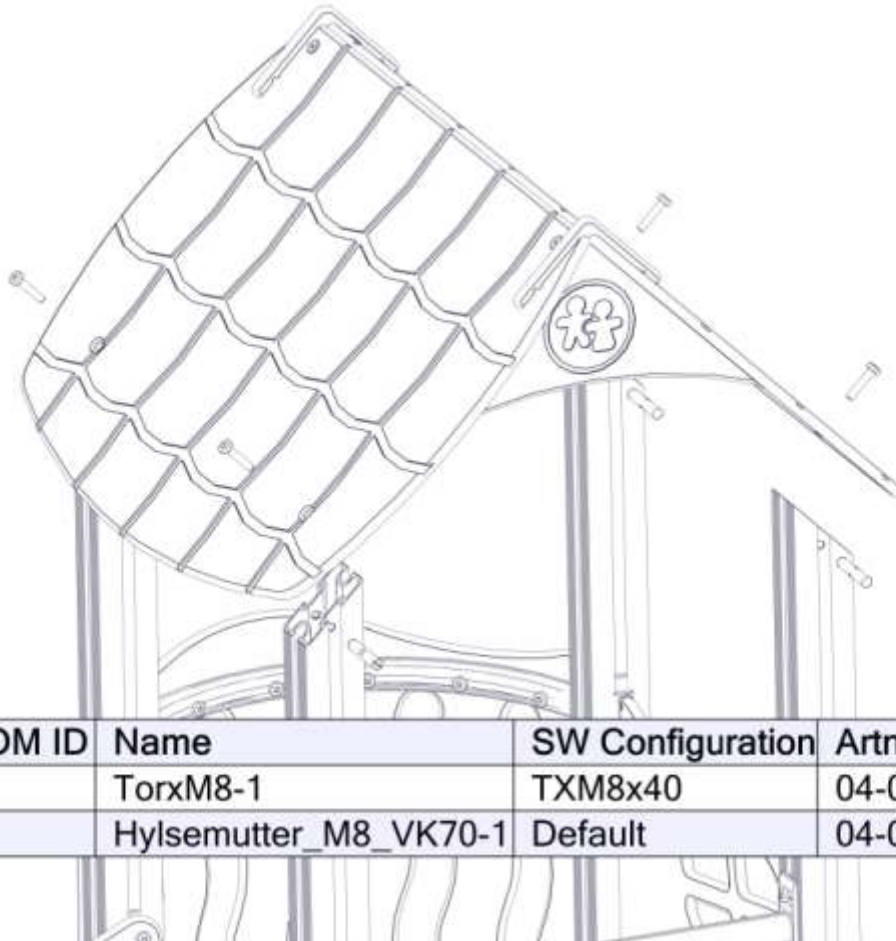

BOM ID	Name	SW Configuration	Artnr (config)	Qty
1	TorxM8-1	TXM8x40	04-000-040	4
2	Hylsemutter_M8_VK70-1	Default	04-018-070	4

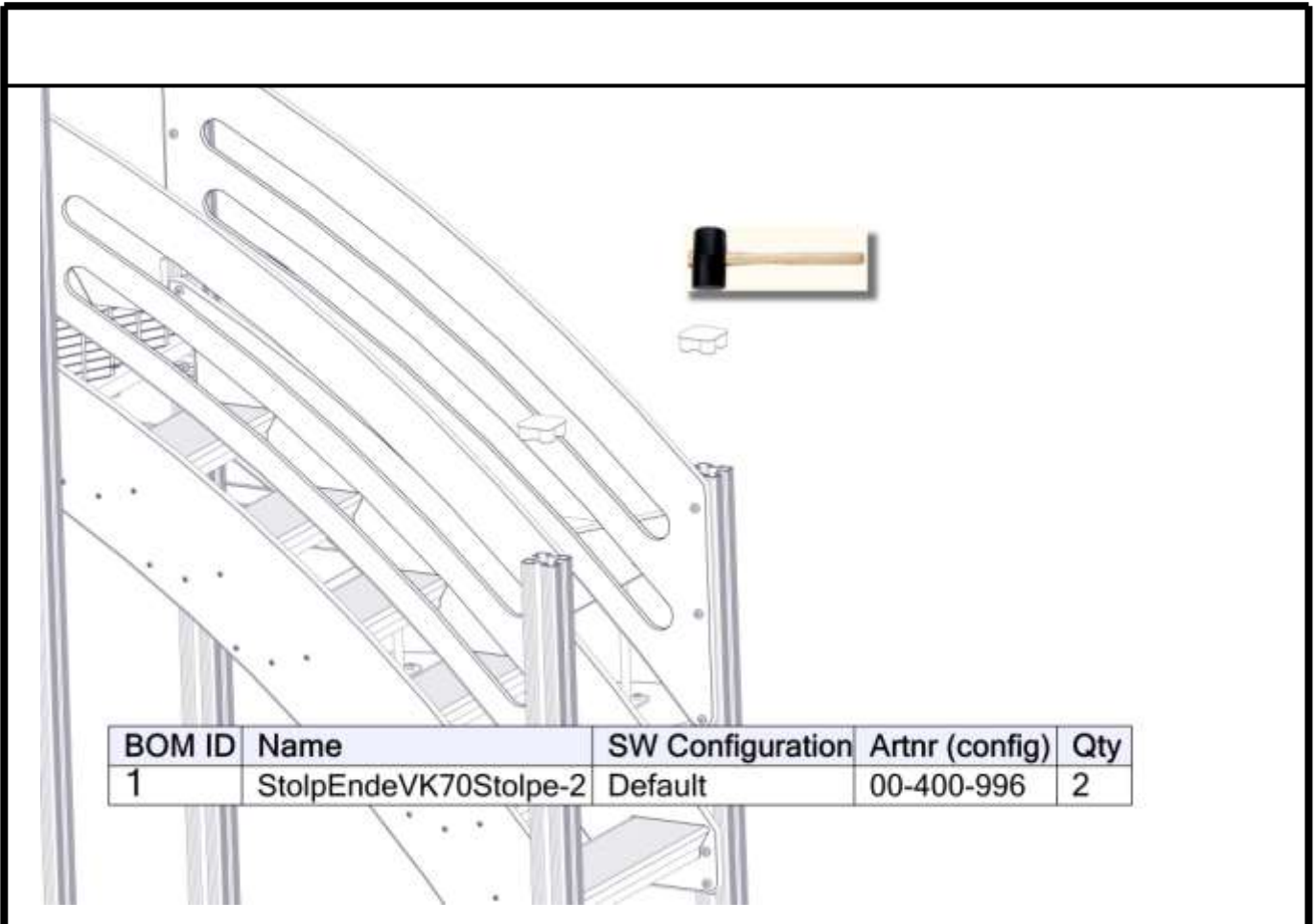

Før utstyret tas i bruk / Before play begins / Innan lekredskapet tas i bruk**N**















- Påse at fallunderlag er utlagt i henhold til gjeldende regler eller vår anbefaling
- Fjern alle monteringshjelpemidler (rester av betong, planker, paller, plast, og lignende)
- Før utstyret tas i bruk, burde man sjekke at det ikke er fare for at anorakksnorer og lignende som kan hekte seg fast noen steder på lekeapparatet. (Vedlagte snor med dobbe (kneledd) kan brukes til å sjekke at dette er i orden. Se vedlagte veiledning for bruk av denne. Dette gjøres for å oppdage eventuelle feilmonteringer.?)
- NB! Bor stå i 2-3 dager før bruk











EN

- Make sure the area and depth of safer surfacing are according to the current standard, or to the manufacturer's recommendation
- Make sure all tools and surplus materials are removed before play begins
- PS! When complete, allow 2-3 days for the concrete to set before use

S

- Kontrollera att fallunderlag är utlagt enligt gällande regler eller vårt rekommendation
- Ta bort alla monteringshjälpmedel (rester av betong, plankor, pallar, plast och liknande)
- Innan lekredskapet används, kontrollera att anoracksnoddar eller kläder/delar av kläder eller liknande inte kan fastna i några delar på redskapet. (Den bipackade "knävringen" kan man med fördel användas för denna kontroll.
- Detta görs för att upptäcka eventuella felmonteringar.)

Boltepakker for / Boltpackage for / Bultpaket för			Sign. _____.		
	VK70 skrå 2100-600 07-510-158	4		Sperrerør 520 07-510-160	1
	Minisprosse 07-510-200	6		Sperrerør gulv 07-510-161	4
	FunminiSkive 07-510-201	6		VK70 600-800 07-510-455	2
	Rutsjebane 07-510-305	1		Gulv 520 07-510-101	1
	Vegg 520x600 07-510-120	1		Utsikt med sperrerør 07-510-134	1
	Tak mini 07-510-105	2		Gavelplate 07-510-106	2
	Ende lokk 00-400-996	2		Trapp 950 07-510-451	1
	Rekkverk trapp 07-510-454	2			

Boltepakker for / Boltpackage for / Bultpaket för			Sign. _____.			
	Torx M8x12 04-000-012	4		Brikke 50-1T 04-060-050	32	
	Torx M8x25 04-000-025	24			Brikke 90-2T 04-060-090	2
	Torx M8x30 04-000-030	4	Brikke 120-3T 04-060-120		8	
	Torx M8x35 04-000-035	36			BrikkeSpesial 04-060-041	4
	Torx M8x40 04-000-040	4				Møbelknapp 04-030-011
	Torx M8x45 04-000-045	6				
	Hylsemutter 04-018-070	4				
	Vinkel 35x35x35x3 04-070-036	2		Skive M8 04-050-008	10	
	Låsemutter M8 04-040-008	6		Fundament skive 00-003-106	2	
				Stålforankring 00-100-312	2	