



Monteringsanvisning



Assembly Instructions



Monteringsanvisning

Produkt nr. / Product no. / Produkt nr.

25-200-170

Ordr. nr. _____

Dato. _____

Sign. _____



sove

Søve AS
3830 Ulefoss - Norway
Tlf: +47 35 94 65 65
www.sove.no



Søve AB
EA Rosengrensgatan 32
421 31 Västra Frölunda
Phone: +46 (0)31 773 97 00
www.sove.se

Monteringstips / Assembly Advice / Monteringsstips

N

- Les monteringsanvisningen nøye før montering.
- Monter elementene i rekkefølgen som vist.
- Boltene bør ikke skrues for hardt til før alt er montert, vatret og loddet. Skru så boltene til.
- NB! Ved bruk av drill, kan boltene ryke.
- På grunn av at solen kan gjøre rutsjeflaten veldig varm, bør rutsjebanens utløp vende mot nord-øst eller nord-vest.
- Er lekeutstyret plassert i naturlige ferdselstraséer må området sikres mot gjennomgang.
- Innspringningshinder bør vurderes rundt lekeapparater hvor det er stor bevegelse, f.eks. ved huskestativ.
- Det bør være fritt innsyn til lekeutstyr som er beregnet for barn under 3 år.

NB! Under monteringsarbeidet må utstyr, som ikke er forankret forsvarlig i bakken, sikres slik at det ikke velte.

Området må avstenges under montering av apparatene med sperrebånd eller lignende.

UK

- Read the instruction carefully before assembling the play unit..
- Assemble the components in the sequence shown in these instructions.
- Fixings must not be fully tightened during assembly. Before casting the foundations, the structure must be level and plumb, at which point all fixings are tightened.
- PS! If use of drill, the bolts may be wrecked.
- Avoid positioning the slide facing due south because of overheating – ideal positions are facing north-east or north-west.
- Secure the construction-area to prevent people from walking through it.
- Consider installing barriers around play-equipment which gives rise to a lot of activity – i.e.swings.
- Ensure that clear vision is possible across the play area so that supervision is possible from any position, particularly where children under 3 years of age will be playing.

NB! During assembly of the equipment, ensure that all structures are securely propped, especially when left overnight. Also ensure that equipment is supported whilst concrete foundations are setting and enclose the area securely to prevent access.

Monteringstips / Assembly Advice / Monteringsstips

S

- Läs monteringsanvisningen noga före montering.
- Montera delarna i den ordningen som anvisas
- Skruvarna bör inte skruvas för hårt tills allt är monterat, i våg och lodat.









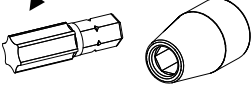

OBS! Används elektrisk skruvdragare, kan bulten gå sönder. Härddra därför manuellt!

- Solen kan göra att rutchbanan blir väldigt varm. Banans nedfart rekommenderas att vändas i norrlig riktning
- Om lekplatsen placeras vid en gångväg mm bör området säkras mot genomfart av gående och cyklister.
- Inspringningshinder bör placeras runt lekutrustning med stor rörelse, t ex, gungställning.
- Det bör vara fri insyn till lekutrustning beräknat till barn under 3 år.

OBS! Under monteringsarbete bör utrustningen som inte ska förankras i marken, ställs så att den inte kan välta.

Området måste spärras när lekutrustningen byggs upp, med avspärrningsband eller liknande.

Nødvendig verktøy / Tools required / Nödvändiga verktyg

<p>(N)</p> <p>(UK)</p> <p>(S)</p>	<p>(A)</p> 	<p>(B)</p>  <p>Torx Nr 45 High quality</p> 	<p>(C)</p> <p>5 mm 6 mm</p> 	<p>(D)</p> 	<p>(E)</p> 
		<p>Metermål Metric measure Tumstoc</p> 	<p>16 V</p> 	<p>Merkebånd Mark ribbon Märkeband</p> 	<p>13 + 17mm</p> 

Nødvendig antall personer / Number of persons required / Lämpligt antal personer





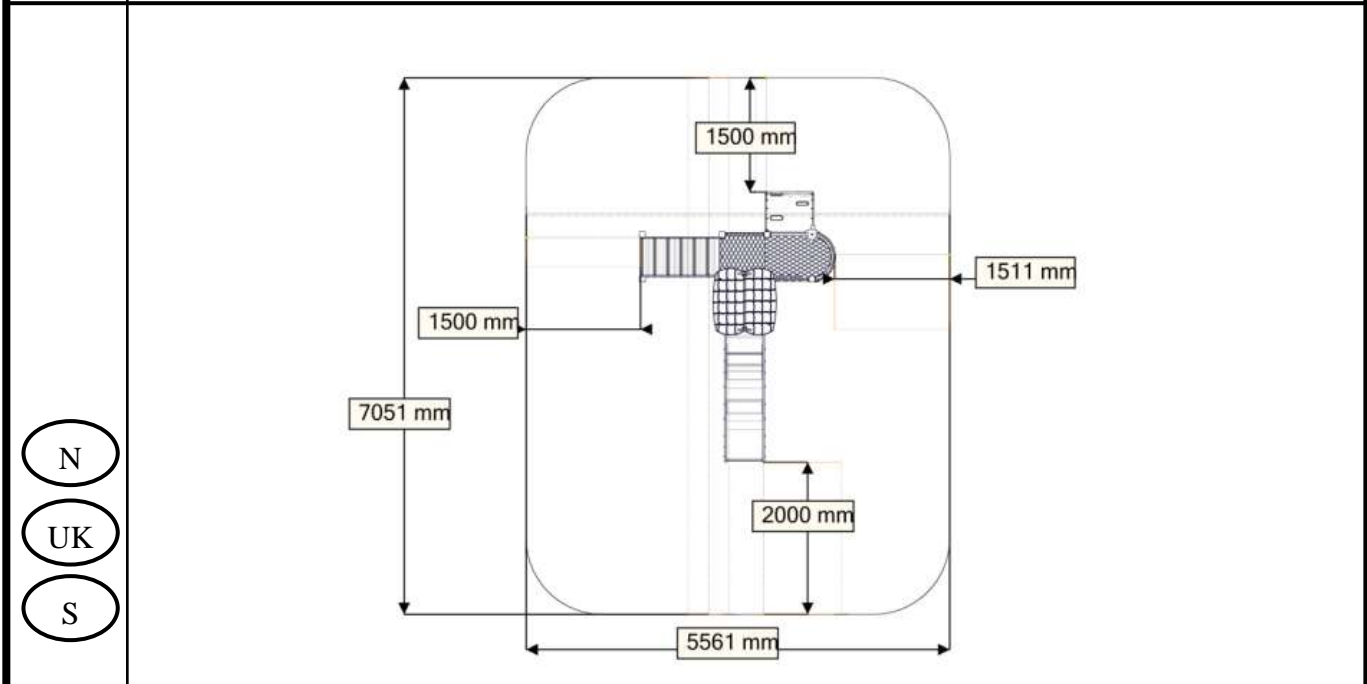











Anbefalt arealbehov ved montering / Recommended working space / Rekommenderad arealbehov vid montering



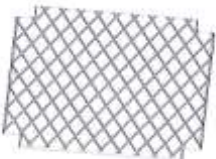









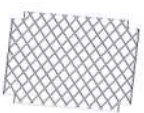

Boltepakker for / Boltpackage for / Bultpaket för

Sign. _____

Stolpe 70x70 skrå	Ant= 4	Navn	Artnr/dimensjon	Ant	Lev
	A+B+C+D	VK70 2100-600 (1) Skrå Brikke på stolpe!	07-510-158	4	
		Torx M8x40 (1)	04-000-040	4	
		Hullsemutter (1) VK70	04-018-070	4	
Stolpe 70x70	Ant= 4	Navn	Artnr/dimensjon	Ant	Lev
	E+F+G+H	VK70 1700-600 (1) Brikke på stolpe!	07-510-150	4	
		Endelokk	00-400-996	3	
FundamentMini	Ant= 2+6	Navn	Artnr/dimensjon	Ant	Lev
		MiniSprosse 660 (1) Minisprosse 1250(1)	07-510-200 07-510-202	2 4	
		Brikke 50_1T (2)	04-060-050	16	
		Torx M8x35 (2)	04-000-035	16	
FundamentSkive	Ant= 12	Navn	Artnr/dimensjon	Ant	Lev
		Skive (1)	07-510-201	8	
Gulv mini	Ant= 1	Navn	Artnr/dimensjon	Ant	Lev
		Gulv Mini 520(1)	07-510-102	1	
		Møbelknapp (4)	04-030-011	4	
		Torx M8x45 (4)	04-000-045	4	















Boltepakker for / Boltpackage for / Bultpaket för

Sign. _____

Gulv mini LANG	Ant= 1	Navn	Artnr/dimensjon	Ant	Lev
		Gulv Mini Lang	07-510-104	1	
		Møbelknapp (4)	04-030-011	4	
		Torx M8x45 (4)	04-000-045	4	
Vegge 520x400 Postkasse	Ant= 1	Navn	Artnr/dimensjon	Ant	Lev
		Vegge520x400 (1) Postkasse	07-510-111	1	
		Brikkespesial(4)	04-060-041	4	
		Brikke(4)	04-060-040	4	
		Torx M8x25(4)	04-000-025	4	
Vegge 520x600 Uten vindo med hull	Ant= 1	Navn	Artnr/dimensjon	Ant	Lev
		Vegge520x600 (1) Uten vindo	07-510-125	1	
		Brikkespesial(4)	04-060-041	4	
		Brikke(4)	04-060-040	4	
		Torx M8x25(4)	04-000-025	4	









Boltepakker for / Boltpackage for / Bultpaket för

Sign. _____

Vegge 520x600 Vindo bloms	Ant= 2	Navn	Artnr/dimensjon	Ant	Lev
		Vegge520x600 (1) Vindu blom	07-510-120	2	
		Brikkespesial(4)	04-060-041	8	
		Brikke(4)	04-060-040	8	
		Torx M8x25(4)	04-000-025	8	
Vegge 520x600 Vindo Bi	Ant= 1	Navn	Artnr/dimensjon	Ant	Lev
		Vegge520x600 (1) Vindu bi/ Sommerfulg	07-510-120	1	
		Brikkespesial(4)	04-060-041	4	
		Brikke(4)	04-060-040	4	
		Torx M8x25(4)	04-000-025	4	
Vegge 520x400 Sommerfugl / bie	Ant= 3	Navn	Artnr/dimensjon	Ant	Lev
		Vegge520x400 (1) Sommerfugl/bi	07-510-110	3	
		Brikkespesial(4)	04-060-041	12	
		Brikke(4)	04-060-040	12	
		Torx M8x25(4)	04-000-025	12	













Boltepakker for / Boltpackage for / Bultpaket för

Sign. _____.

Sperrerør 520	Ant= 2	Navn	Artnr/dimensjon	Ant	Lev
		Sperrerør 520 (1)	07-510-160	2	
		Brikke 120_3T (2)	04-060-120	4	
		Torx M8x25 (4)	04-000-025	8	
Sperrerør 520 gulv	Ant= 12	Navn	Artnr/dimensjon	Ant	Lev
		Sperrerør 520 (1)	07-510-161	12	
		Brikke 90_2T (2)	04-060-090	0 På stolpe	
		Torx M8x25 (2)	04-000-025	24	











Boltepakker for / Boltpackage for / Bultpaket för

Sign. _____

Stolpe 70x70	Ant= 2	Navn	Artnr/dimensjon	Ant	Lev
		VK70x70 (1) 600-800=1400	07-510-455	2	
		Stolpende	00-400-996	2	
FundamentMini 660	Ant= 2	Navn	Artnr/dimensjon	Ant	Lev
		miniSprosse 660 (1)	07-510-200	2	
		Brikke 50_1T (2)	04-060-040	4	
		Torx M8x35 (2)	04-000-035	4	
FundamentSkive	Ant= 2	Navn	Artnr/dimensjon	Ant	Lev
		Skive (1)	07-510-201	2	
Trapp 950	Ant= 1	Navn	Artnr/dimensjon	Ant	Lev
		Trapp 950	07-510-451	1	
		Rekkverk trappa	07-510-454	2	
		Brikke 50 1T	04-060-050	16	
		Brikke 90 2T	04-060-090	2	
		Torx M8x35	04-000-035	20	









Boltepakker for / Boltpackage for / Bultpaket för

Sign. _____.

Utsikt	Ant= 1	Navn	Artnr/dimensjon	Ant	Lev
		Utsikt med sperrerør (1)	07-510-134	1	
		Gulv til utsikt (1)	05-510-101	1	
		Torx M8x45 (4) Torx M8x25(8)	04-000-045 04-000-025	4 8	
		Møbelknapp M8x13x17	04-030-011	4	
		Brikke 120_3T	04-060-120	4	
		Plug spor	00-400-980	2	
Kikkert	Ant= 1	Navn	Artnr/dimensjon	Ant	Lev
		Kikkert	35-100-615	1	
		Brikke 50_1T	04-060-050	2	
		Torx M8x25	04-000-025	2	

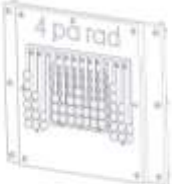









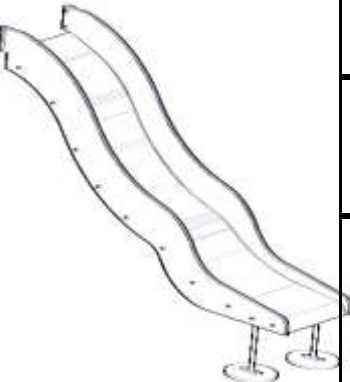



Boltepakker for / Boltpackage for / Bultpaket för

Sign. _____.

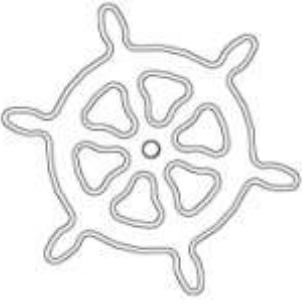
Krabbeplate HDPE	Ant= 1	Navn	Artnr/dimensjon	Ant	Lev
		Krabbeplate på rør (1)	07-510-135	1	
		Brikke 150-2T	04-060-151	2	
		Torx M8x25 (4) Torx M8x35(4)	04-000-025 04-000-035	4 4	
		Skive M8	04-050-008	4	
		Låsemutter M8	04-040-008	4	
		Fundament plate	00-003-106	2	
Søve 4 på rad	Ant= 1	Navn	Artnr/dimensjon	Ant	Lev
		Søve 4 på rad	25-100-010	1	
		Brikke 50_1T (6)	04-060-050	6	
		Torx M8x30 (6)	04-000-030	6	
		Skive M8	04-050-008	6	











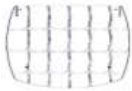

Boltepakker for / Boltpackage for / Bultpaket för

Sign. _____

Rutsjebane 950 07-510-310	Ant= 1	Navn	Artnr/dimensjon	Ant	Lev
		Rutsjebane	07-510-310	1	
		Brikke120 3T(5)	04-060-120	2	
		Torx M8x35(4)	04-000-035	4	
		Torx M8x45(2)	04-000-045	2	
		Torzx M8x30(4)	04-000-030	4	
		Fundamentskive(2) 2H 80	00-003-106	2	
		Skive M8(2)	04-050-008	4	
		Mutter M8(2)	04-040-008	6	
	Stålforankering(2)	00-100-310	2		
Styr Skute	Ant= 1	Navn	Artnr/dimensjon	Ant	Lev
		Skute styr	02-500-078	1	
		BilStyr Hylse	02-500-005	1	
		Torx M8x50	04-000-050	1	
		Skive M8	04-055-008	1	
		Møbelknapp(1)	04-030-011	1	

Boltepakker for / Boltpackage for / Bultpaket för

Sign. _____.

Tak	Ant= 1	Navn	Artnr/dimensjon	Ant	Lev
		Tak mini (2)	07-510-105	2	
		Gavelplate(2)	07-510-106	2	
		Vinkel 35x35x3(2) 11mm	04-070-036	2	
		Møbelknapp	04-030-011	4	
		Torx M8x12(4)	04-000-012	4	
		Skive M8 (4)	04-050-008	4	
Buttikkdisk	Ant= 1	Navn	Artnr/dimensjon	Ant	Lev
		Butikkdiskk	07-510-130	1	
		Vinkel 50x50x4(2) 11mm	04-070-050	2	
		Møbelknapp(2)	04-030-011	2	
		Brikke 501T(2)	04-060-050	2	
		Torx M8x12 (2) Torx M8x20 (2)	04-000-012 04-000-020	2 2	
		Skive M8 (2)	04-050-008	2	

Fundamentering med betong / Foundation concrete / Förankring med betong

(N)	Støtsand		(N)	(UK)	(S)
(UK)	Safer surface		Bakkenivå	Ground level	Marknivå
(S)	Stridsan				
				↓	Ref NS-EN 177
(N)	Komprimert masse.	betong			
(UK)	Compressed mass.	concrete			
(S)	Komprimerad massa.	betong			

Fundamentering uten betong / Foundation without concrete / Förankring utan betong

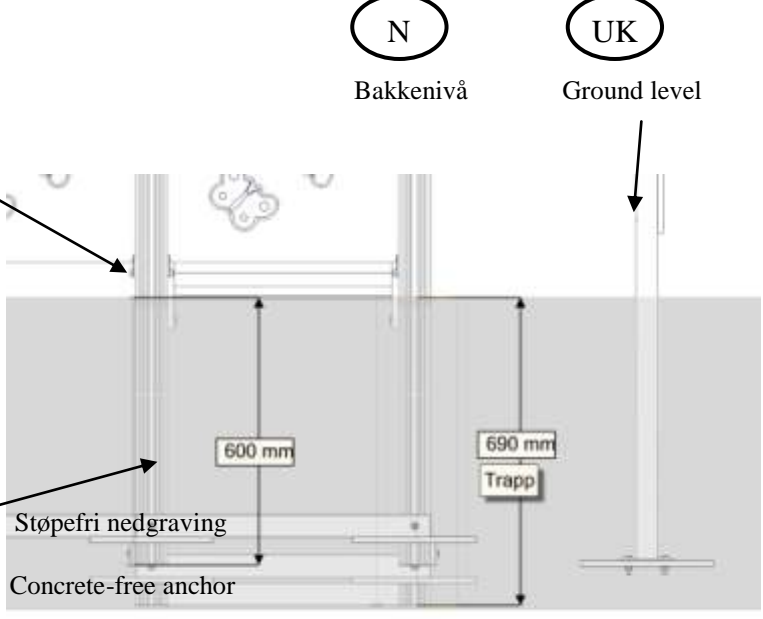
(N)	Støtsand		(N)	(UK)	(S)
(UK)	Safer surface		Bakkenivå	Ground level	Marknivå
(S)	Stridsan				
(N)	Komprimert masse	Støpefri nedgraving			Ref NS-EN 1177
(UK)	Compressed mass	Concrete-free anchor			
(S)	Komprimerad massa	Nedgravningsfundament			

(N)	Alle mål er oppgitt i millimeter
(UK)	Scale measured in mm
(S)	Alla mått är i millimeter.

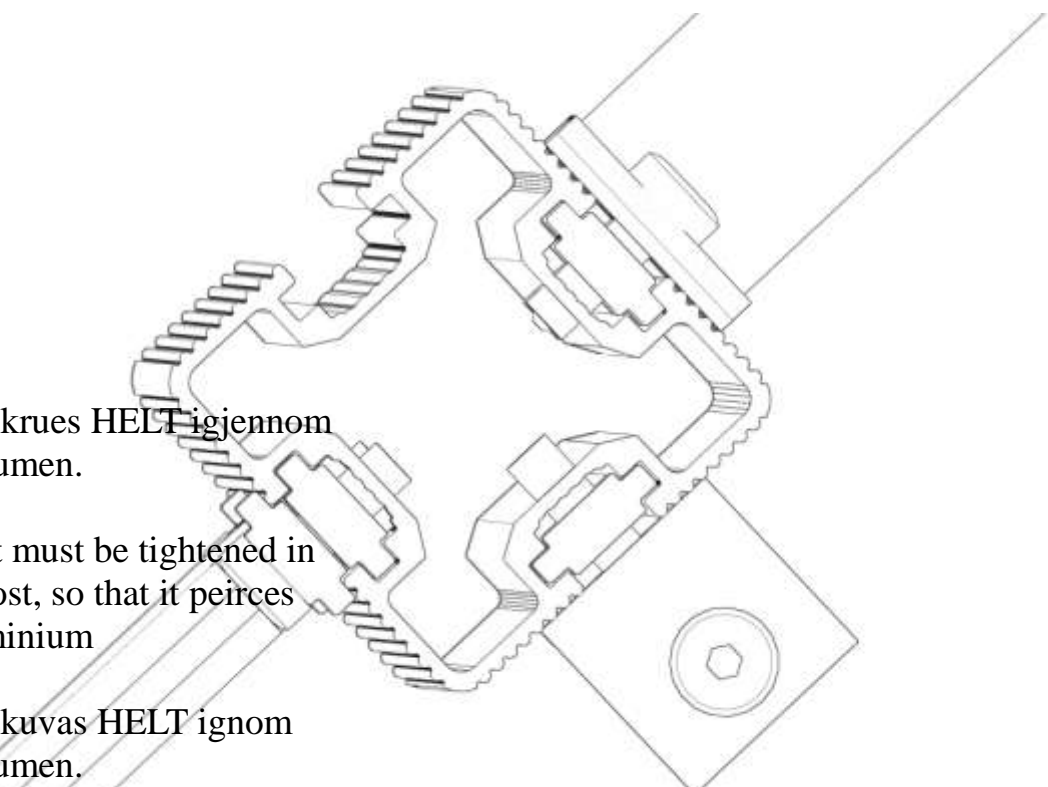
<p data-bbox="124 1559 220 1626">N</p> <p data-bbox="124 1693 220 1760">UK</p> <p data-bbox="124 1850 220 1917">S</p>	 <p data-bbox="240 1585 703 1666">Bolten skrues HELT igjennom aluminiumen.</p> <p data-bbox="240 1715 687 1841">The bolt must be tightened in to the post, so that it peirces the aluminium</p> <p data-bbox="240 1890 663 1971">Bulten skruvas HELT ignom aluminiumen.</p>

Fallhøyder / Free height of fall / Fallhöjder

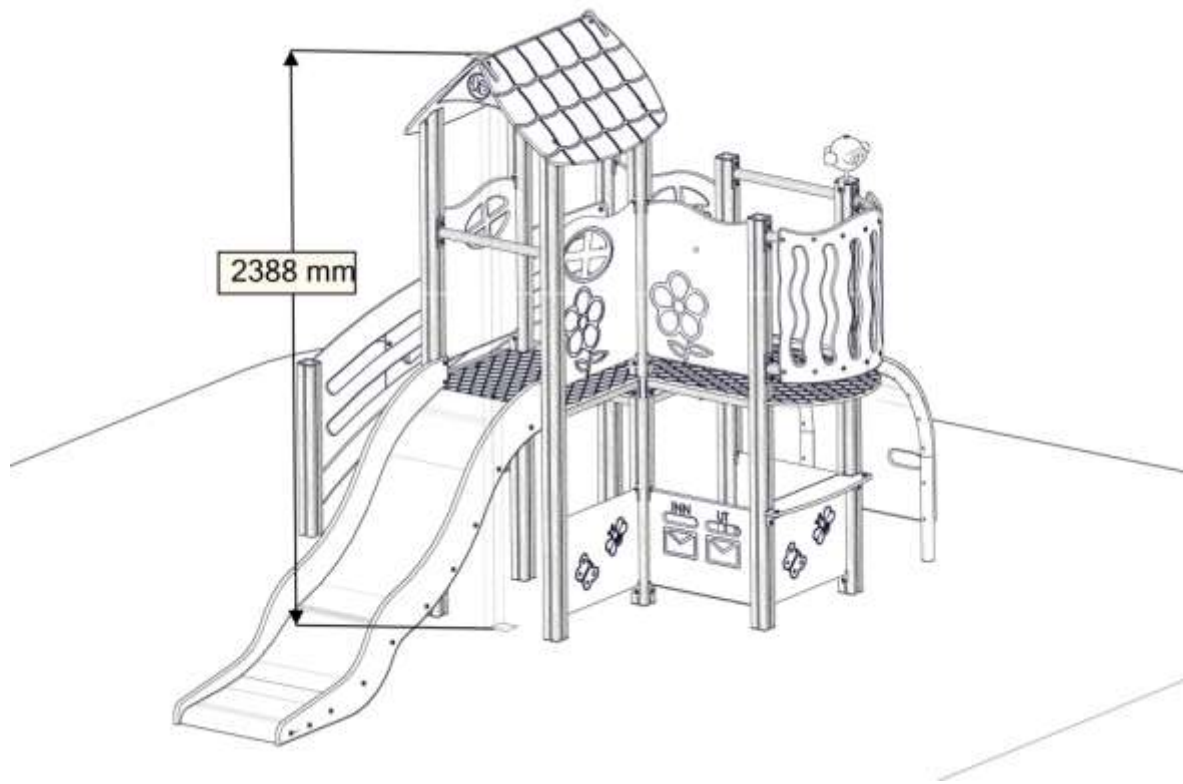

Sikkerhetszone / Safety zone / Säkerhetszon

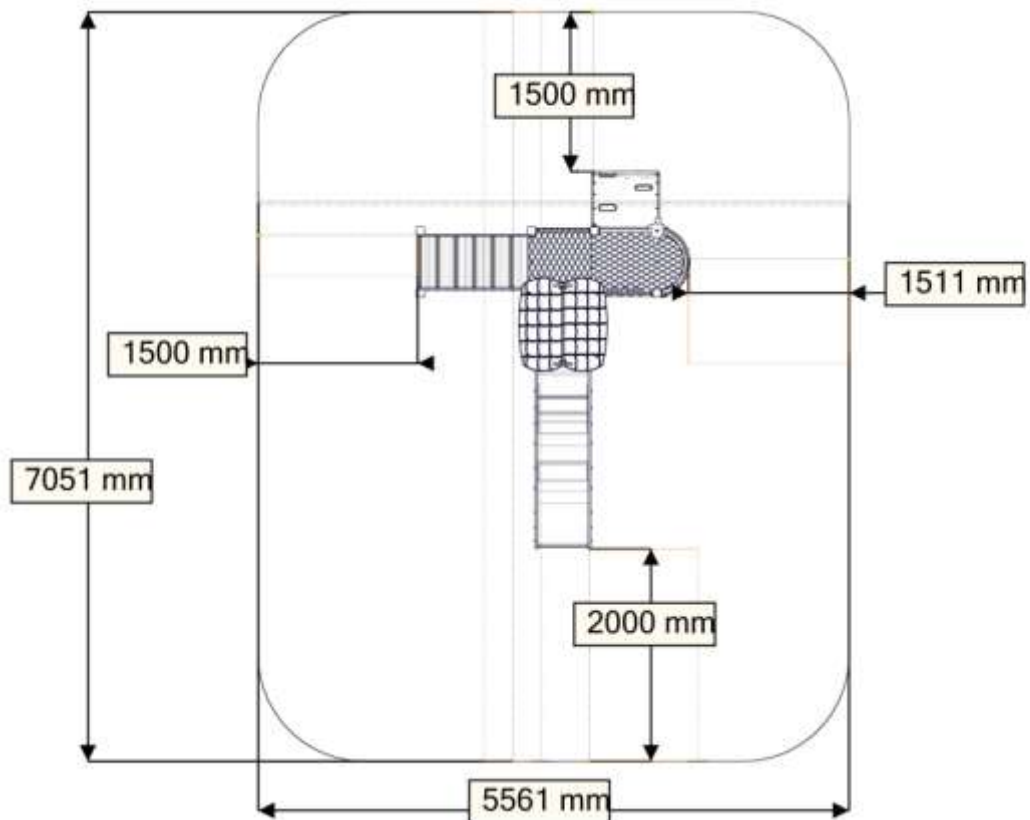

Plassering av forankringer / Ground plan / Placering av förankringar

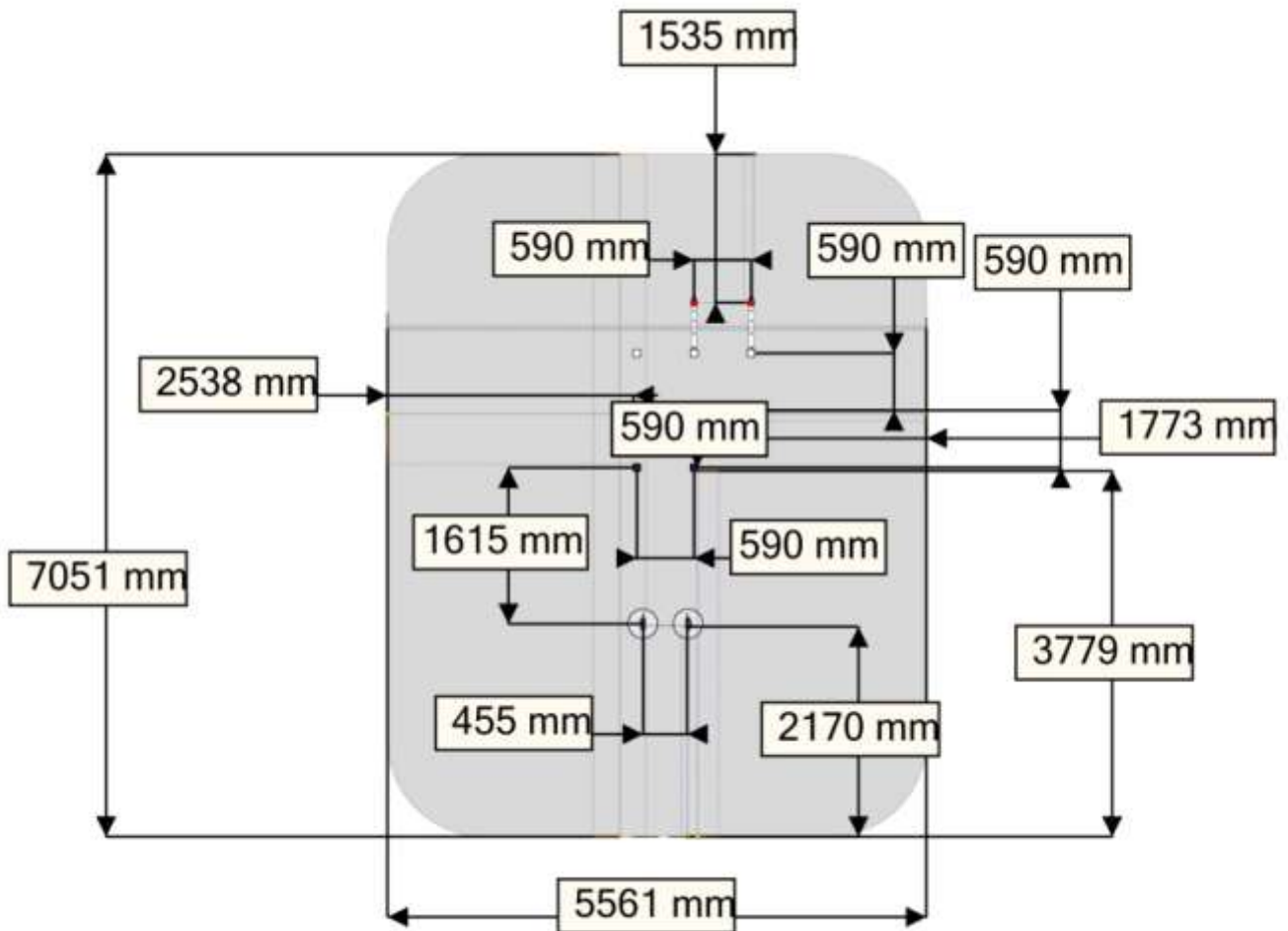

N

Alle mål er oppgitt i millimeter

UK

Scale measured in mm

S

Alla mått är i millimeter.

Montering av lekeapparatet / Assembly instructions / Montering av lekredskapet

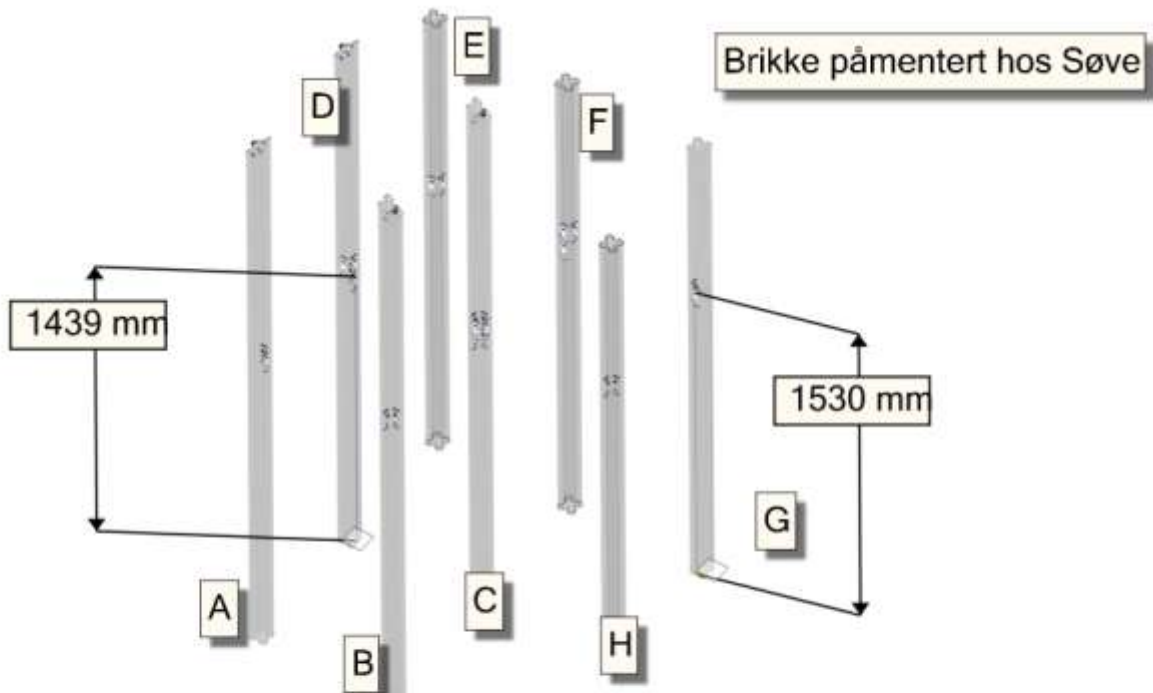

BOM ID	Name	SW Configuration	Artnr (config)	Qty
1	VK70_SFA5123_miniserie-1	1700-600	07-510-150	4
2	VK70_SFA5123_miniSkra-1	2100-600	07-510-158	4
3	brikke_SFA5116-	90_2T	04-060-090	24

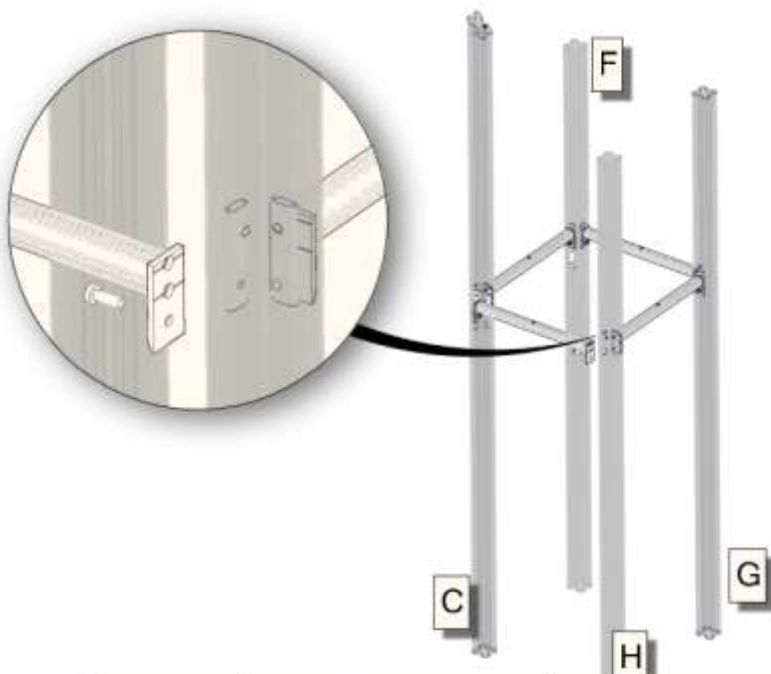

BOM ID	Name	SW Configuration	Artnr (config)	Qty
1	Sperror_MINI508-1	520_Gulv	07-510-161	4
2	Torxm8-	TXM8x25	04-000-025	8

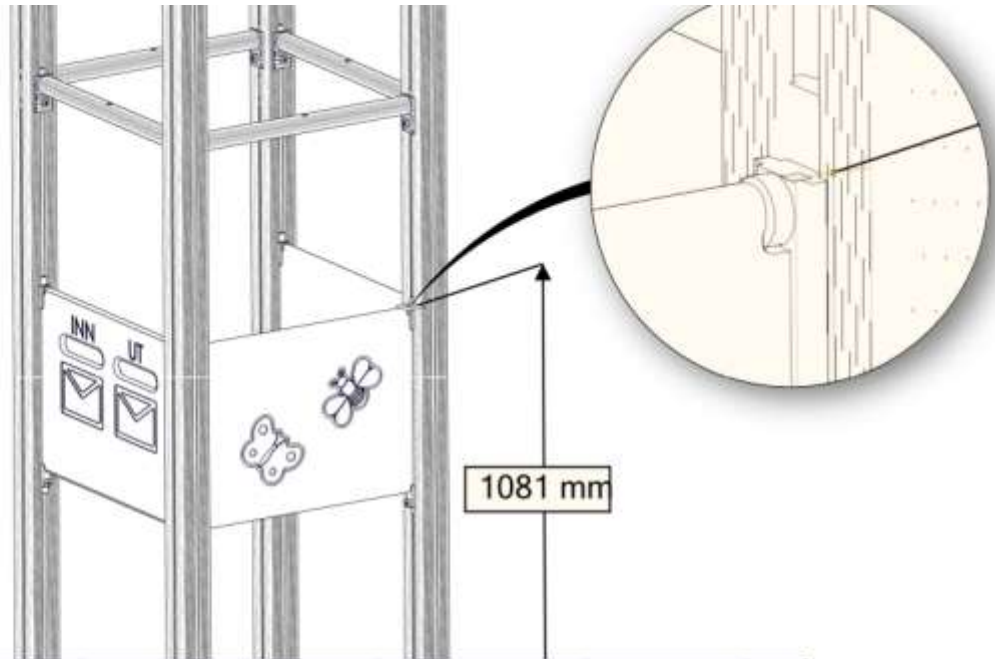

BOM ID	Name	SW Configuration	Artnr (config)	Qty
1	brikke_SFA5116Special-1	12mm	04-060-041	8
2	brikke_SFA5116-1	50_1T	04-060-050	8
3	VeggMini520x400-1	Postkase	07-510-111	1
4	VeggMini520x400-1	STD	07-510-110	2
5	TorxM8-1	TXM8x25	04-000-025	8

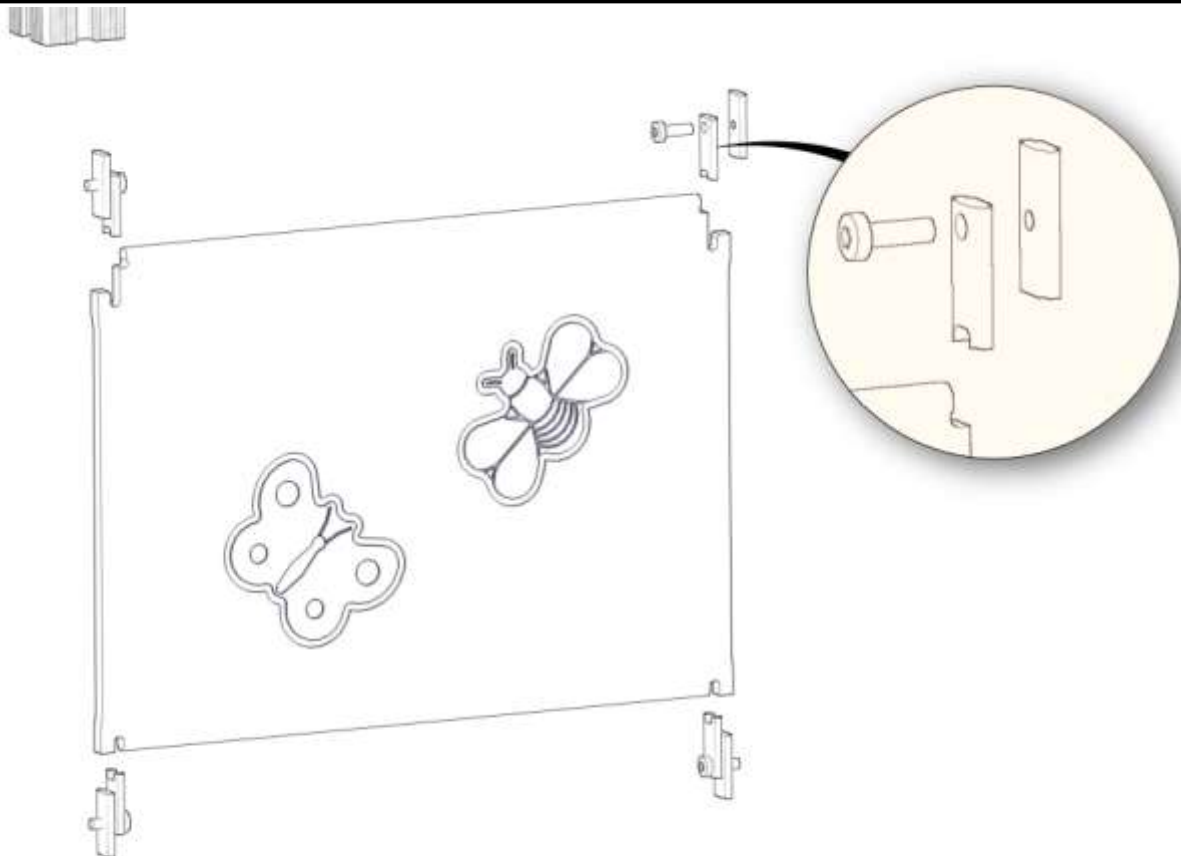

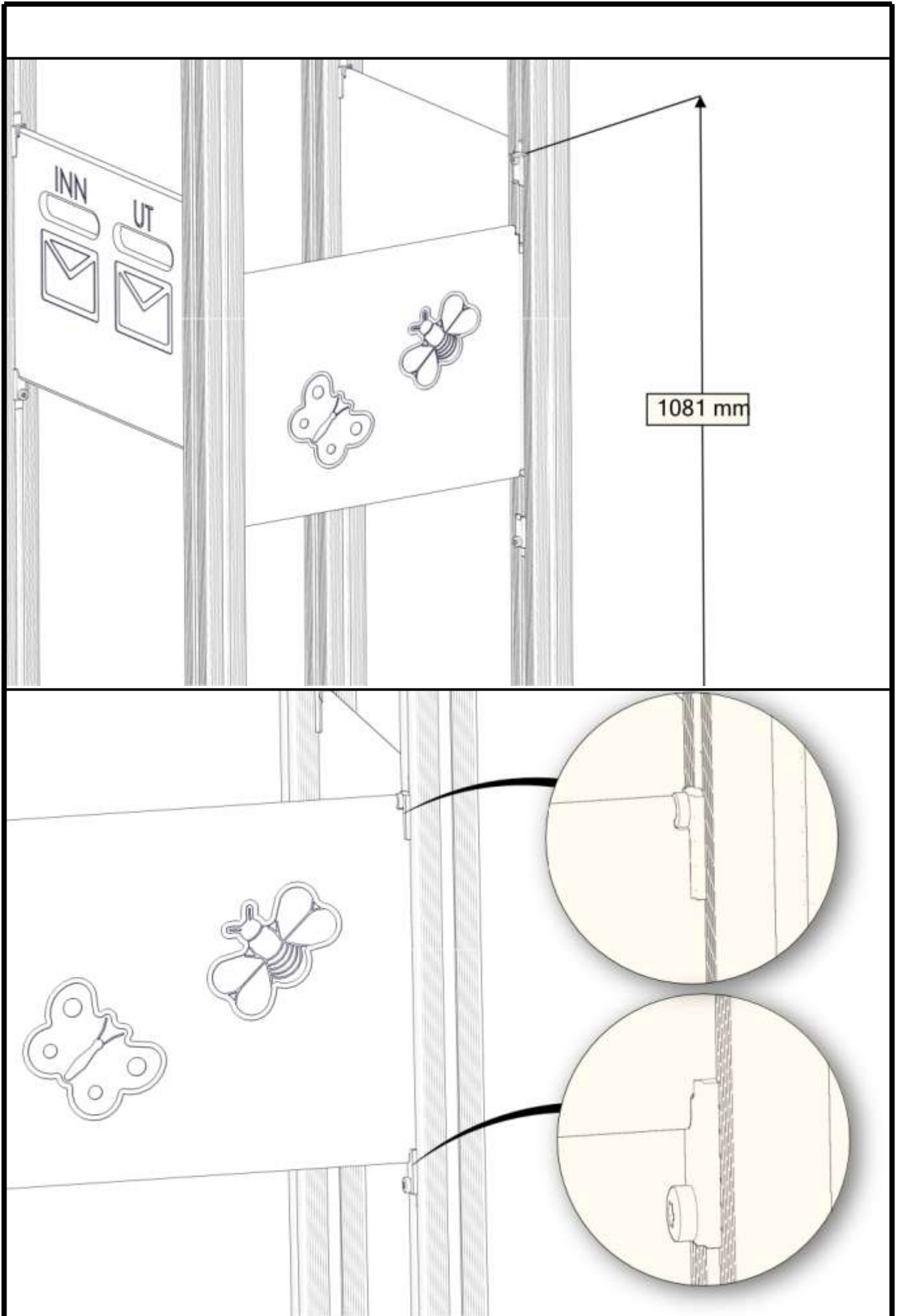

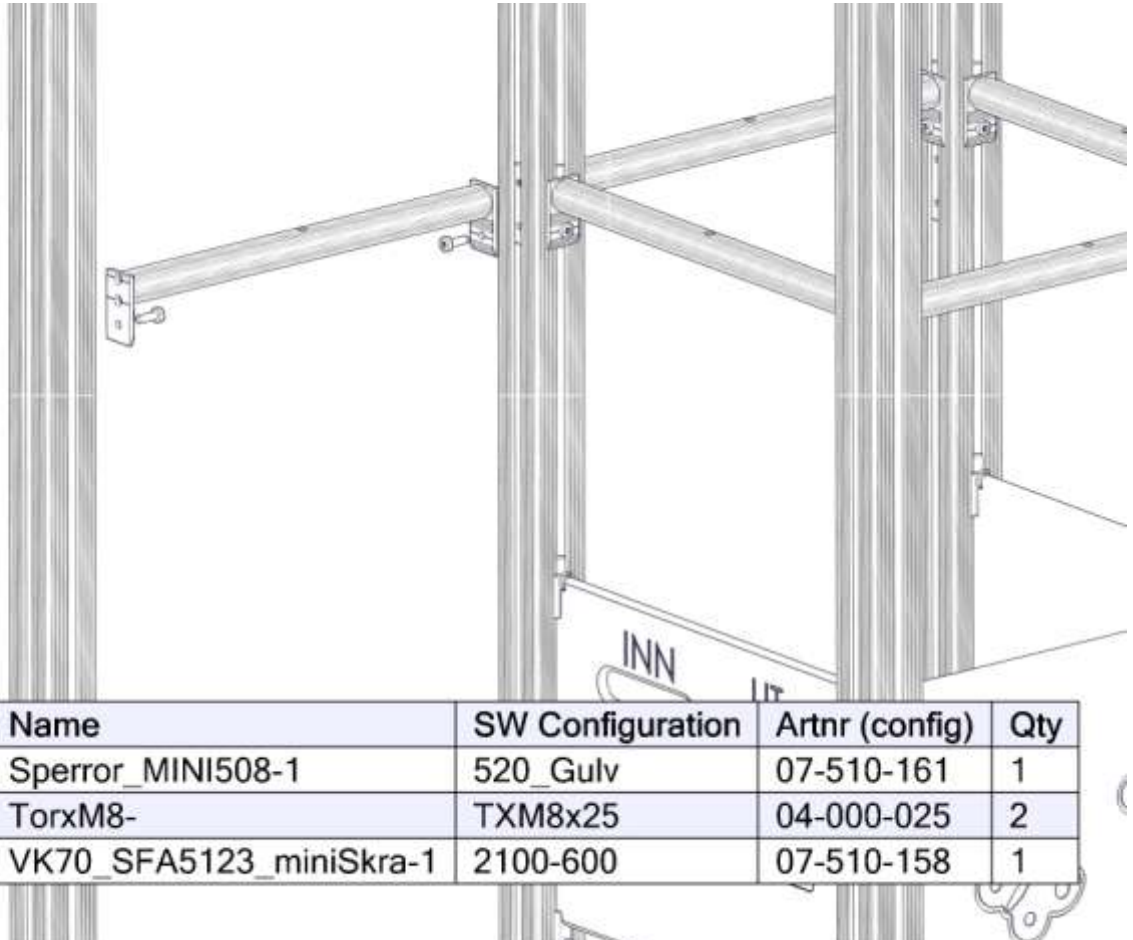

BOM ID	Name	SW Configuration	Artnr (config)	Qty
1	Sperror_MINI508-1	520_Gulv	07-510-161	1
2	TorxM8-	TXM8x25	04-000-025	2
3	VK70_SFA5123_miniSkra-1	2100-600	07-510-158	1

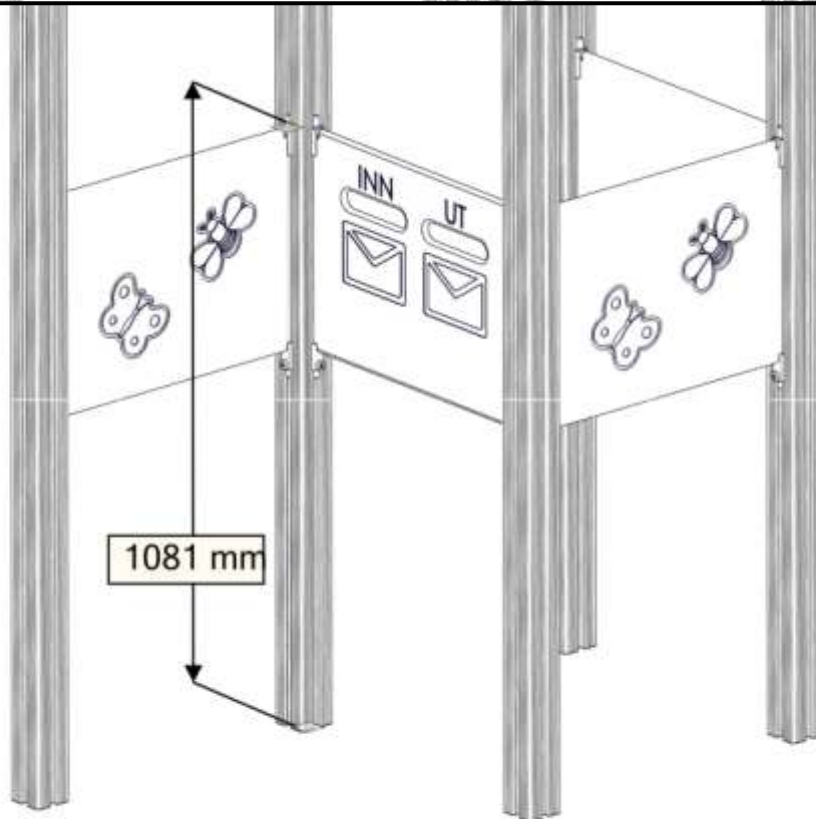

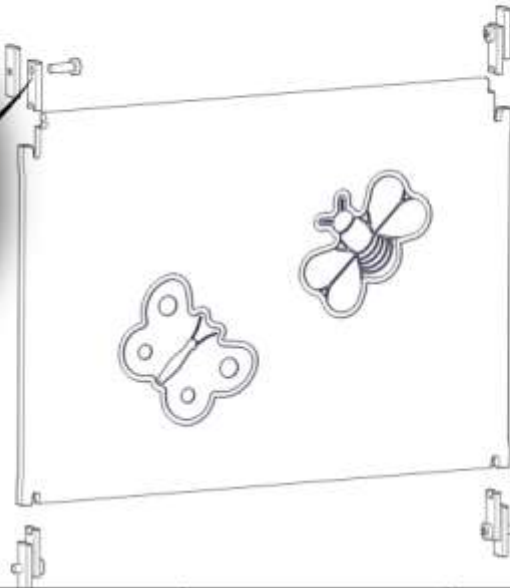
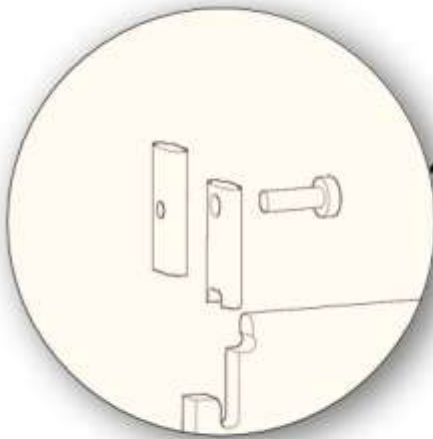

BOM ID	Name	SW Configuration	Artnr (config)	Qty
1	brikke_SFA5116Special-1	12mm	04-060-041	4
2	brikke_SFA5116-1	50_1T	04-060-050	4
3	VeggMini520x400-1	STD	07-510-110	1
4	TorxM8-1	TXM8x25	04-000-025	4

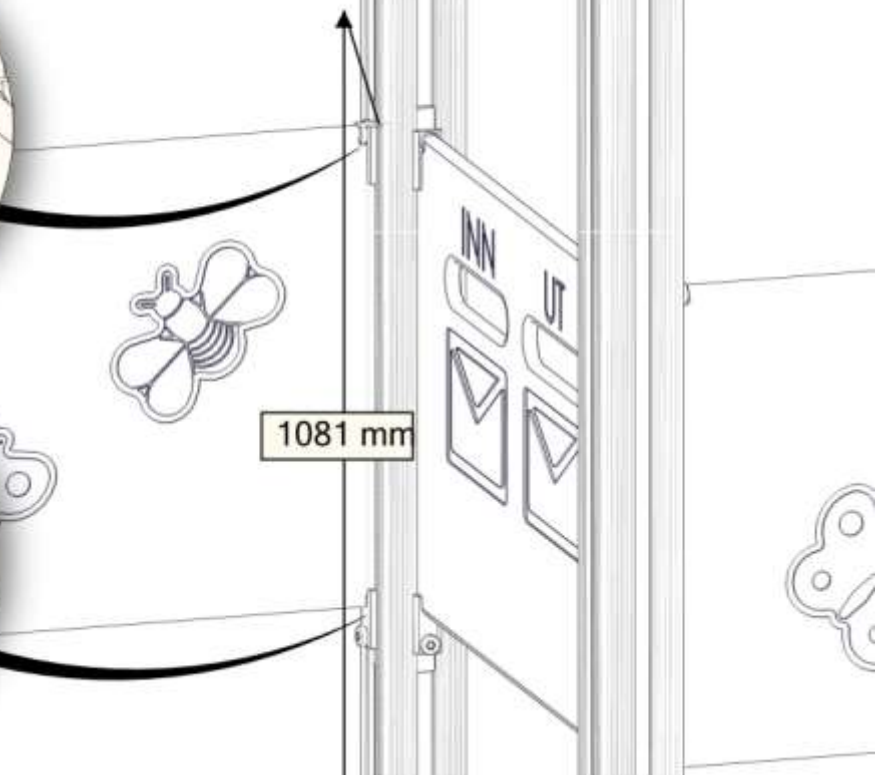
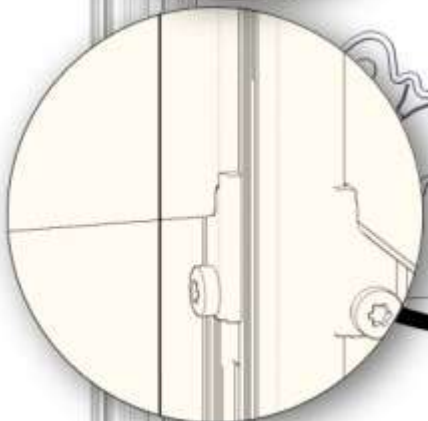
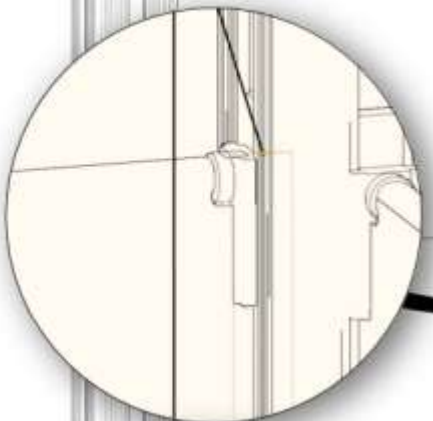

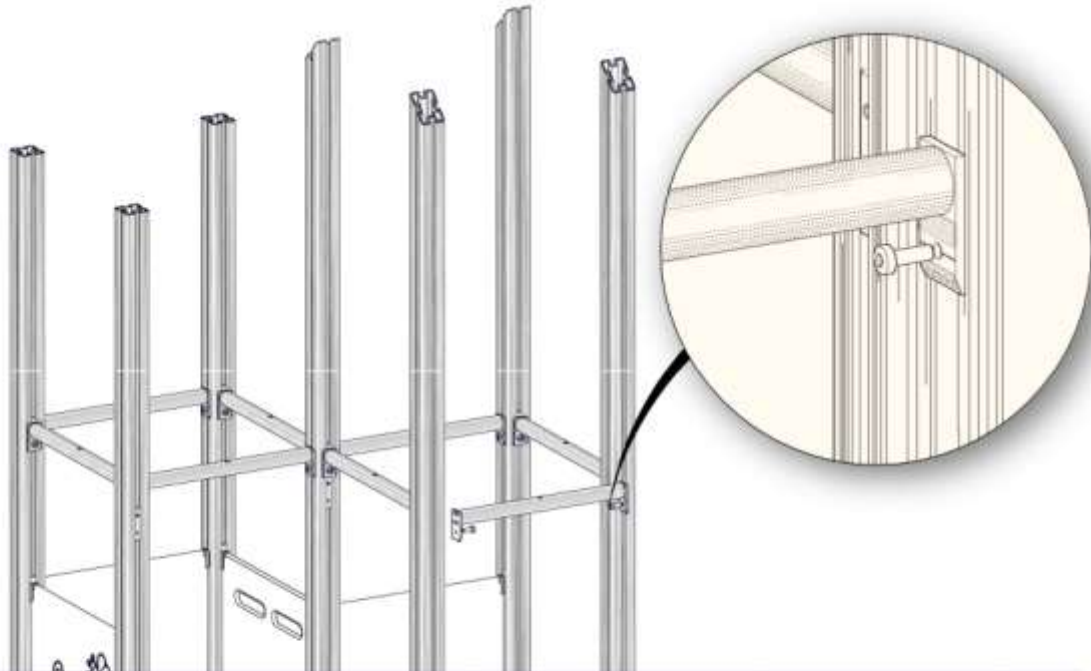

BOM ID	Name	SW Configuration	Artnr (config)	Qty
1	VK70_SFA5123_miniSkra-1	2100-600	07-510-158	3
2	Sperror_MINI508-1	520_Gulv	07-510-161	3
3	Torxm8-	TXM8x25	04-000-025	6

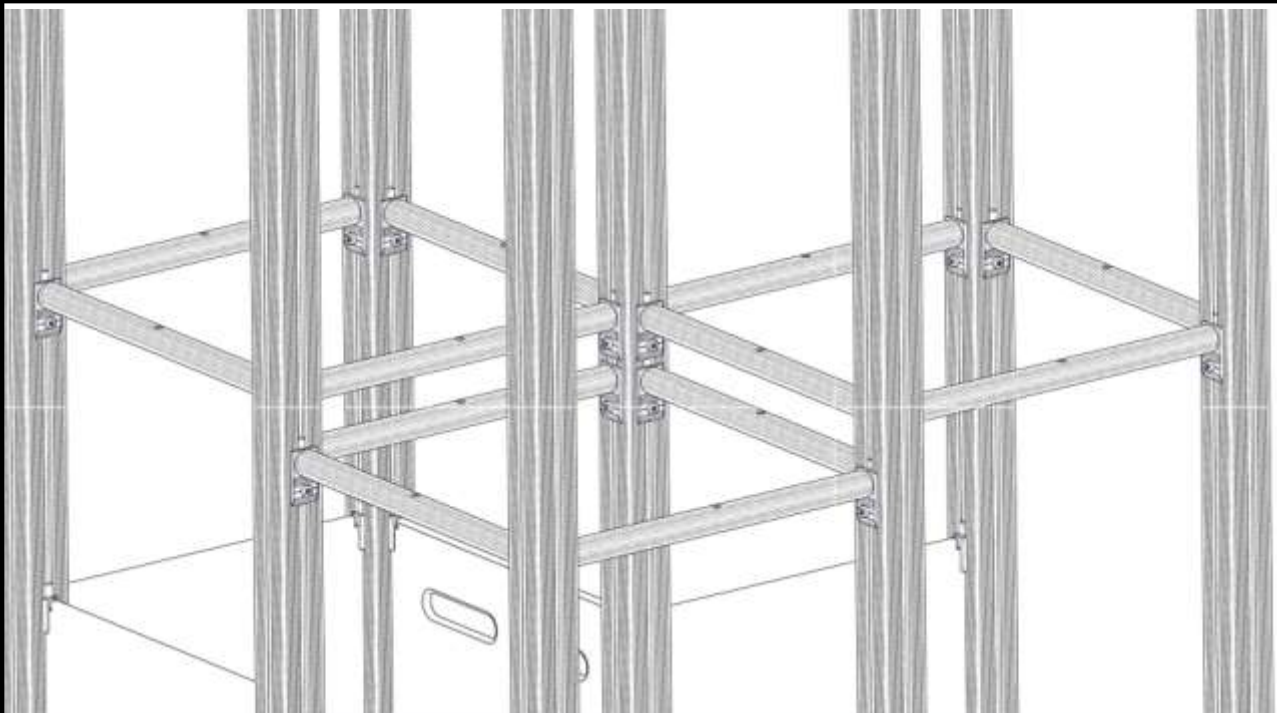

BOM ID	Name	SW Configuration	Artnr (config)	Qty
1	VK70_SFA5123_miniserie-1	1700-600	07-510-150	1
2	Sperror_MINI508-1	520_Gulv	07-510-161	4
3	Torxm8-	TXM8x25	04-000-025	8

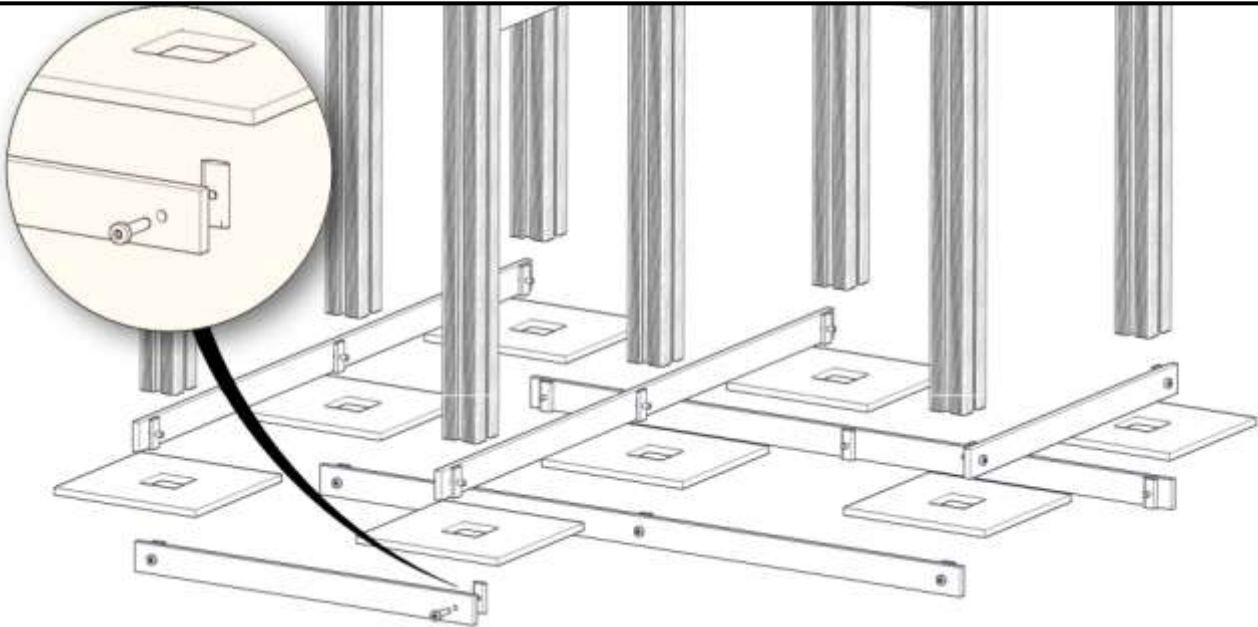
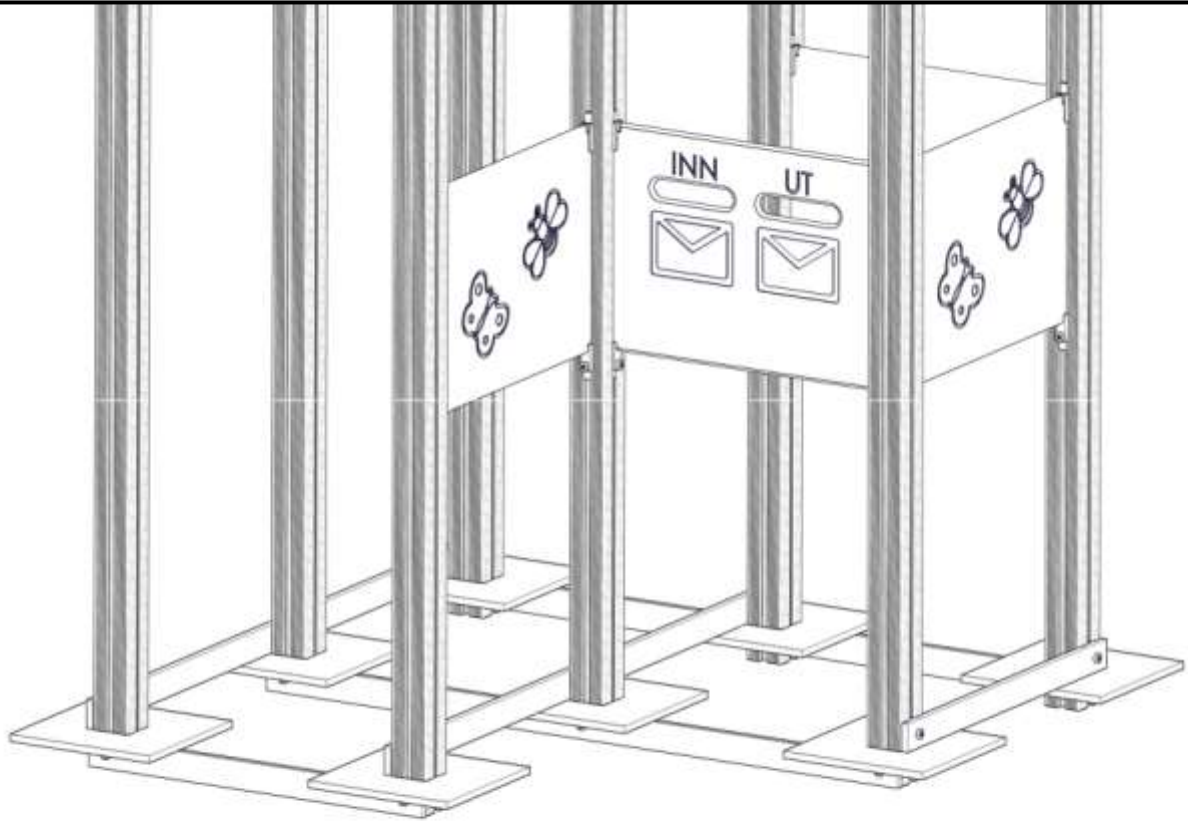

BOM ID	Name	SW Configuration	Artnr (config)	Qty
1	minifun_sprosse-1	1250	07-510-202	4
2	brikke_SFA5116-	50_1T	04-060-050	16
3	minifun_sprosse-1	660	07-510-200	2
4	minifunSkive-	Default	07-510-201	8
5	TorxM8-	TXM8x35	04-000-035	16

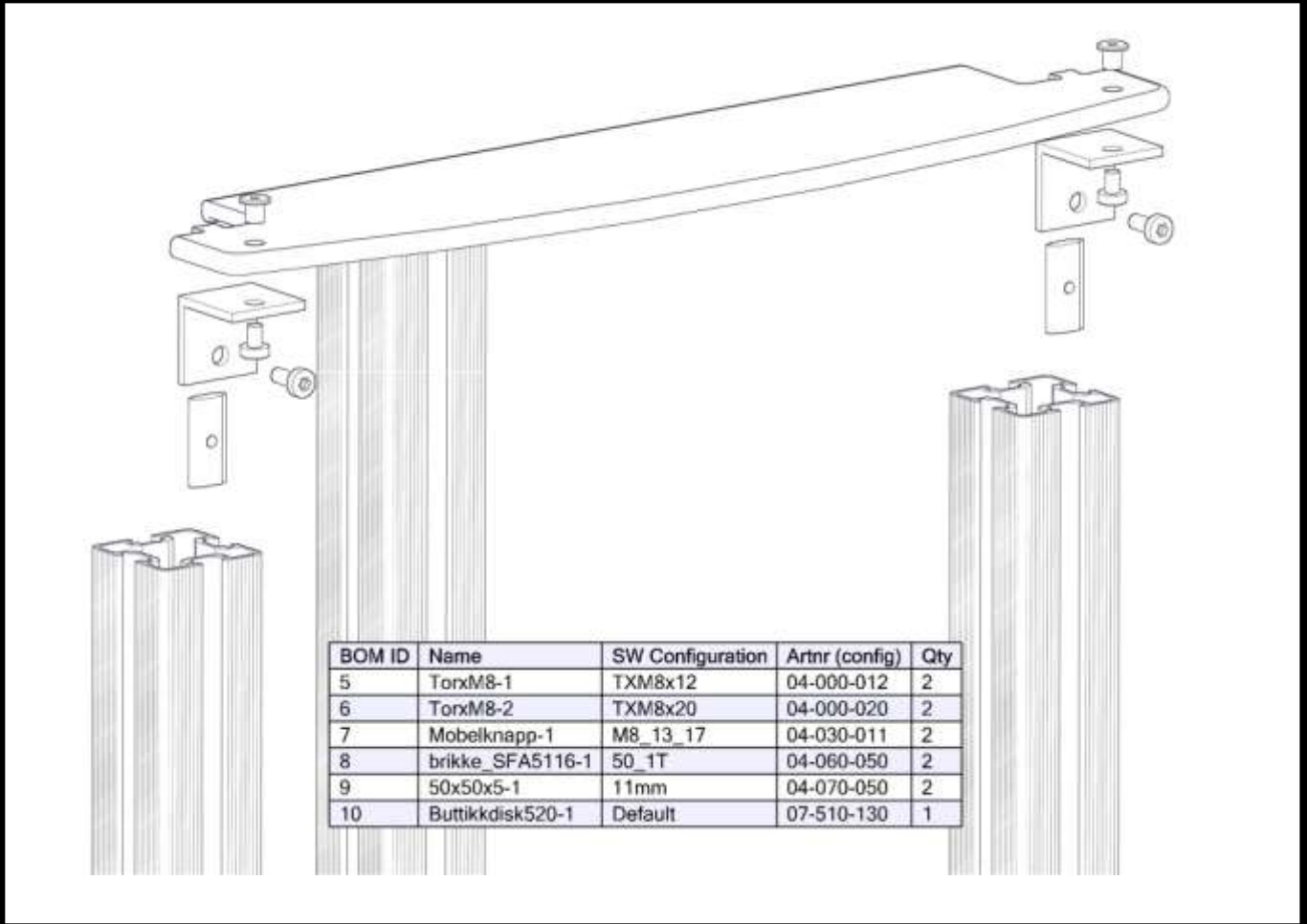
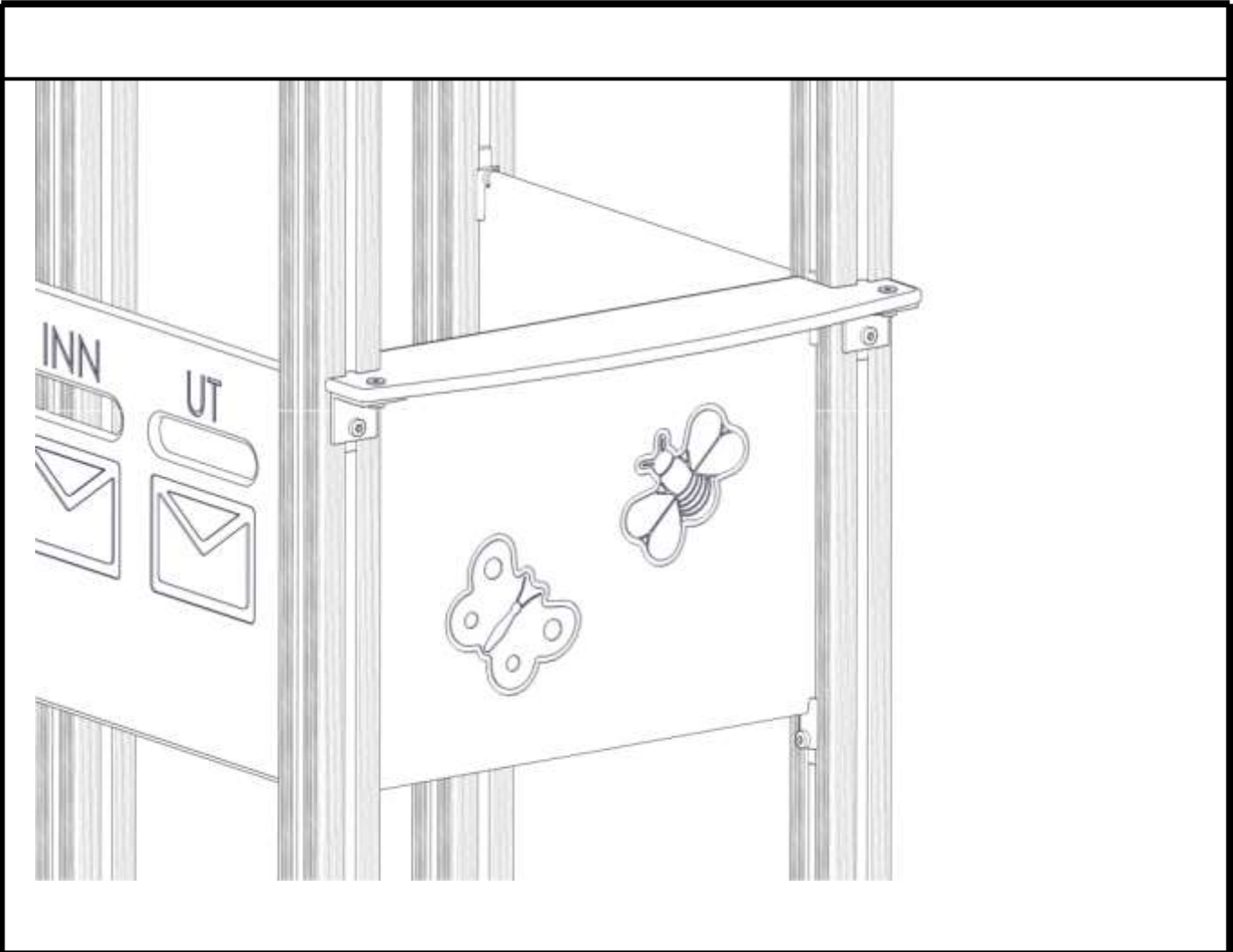

BOM ID	Name	SW Configuration	Artnr (config)	Qty
5	TorxM8-1	TXM8x12	04-000-012	2
6	TorxM8-2	TXM8x20	04-000-020	2
7	Mobelknapp-1	M8_13_17	04-030-011	2
8	brikke_SFA5116-1	50_1T	04-060-050	2
9	50x50x5-1	11mm	04-070-050	2
10	Buttikkdisk520-1	Default	07-510-130	1

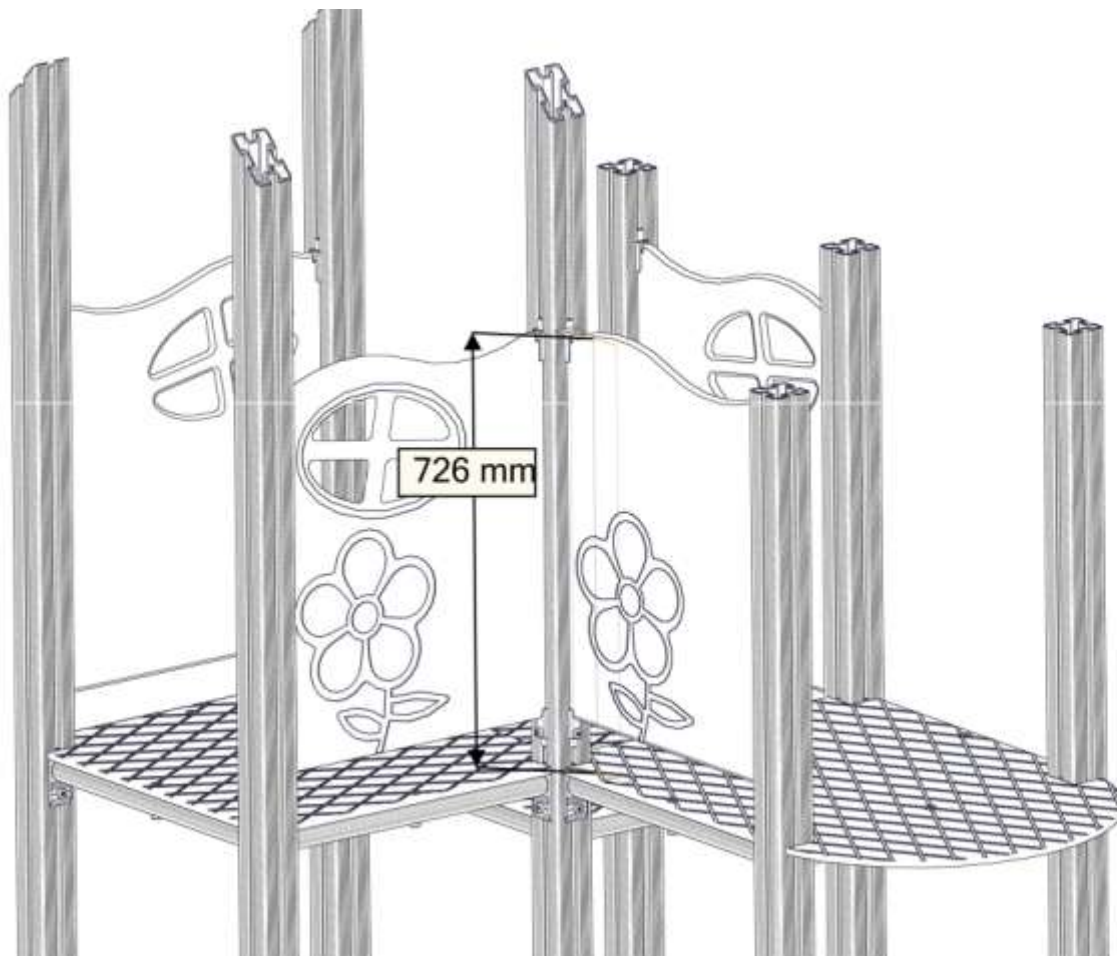
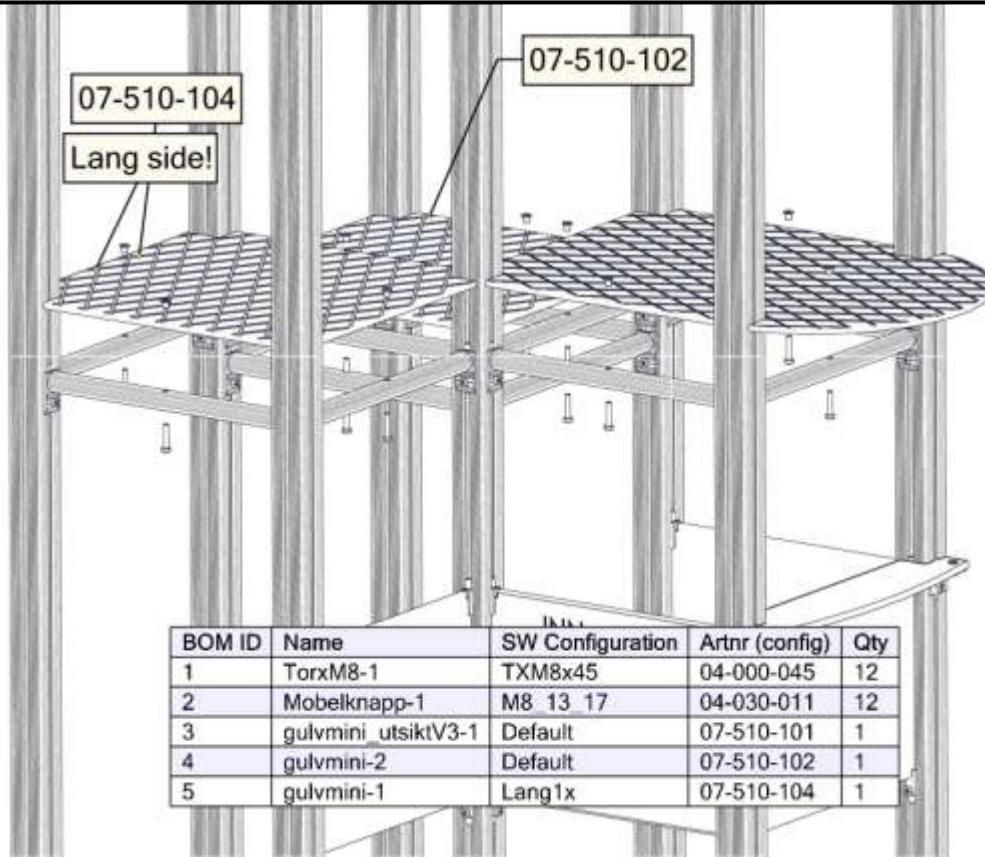

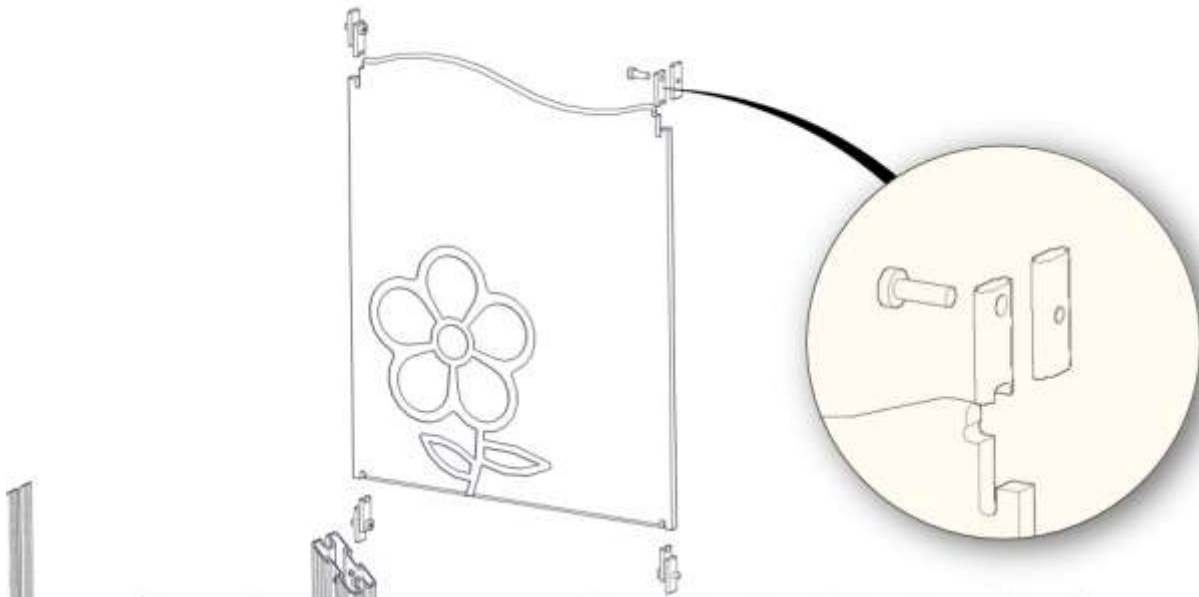

BOM ID	Name	SW Configuration	Artnr (config)	Qty
1	TorxM8-1	TXM8x25	04-000-025	4
2	brikke_SFA5116Special-1	12mm	04-060-041	4
3	brikke_SFA5116-1	50_1T	04-060-050	4
4	VeggMini520x600-1	Default	07-510-125	1

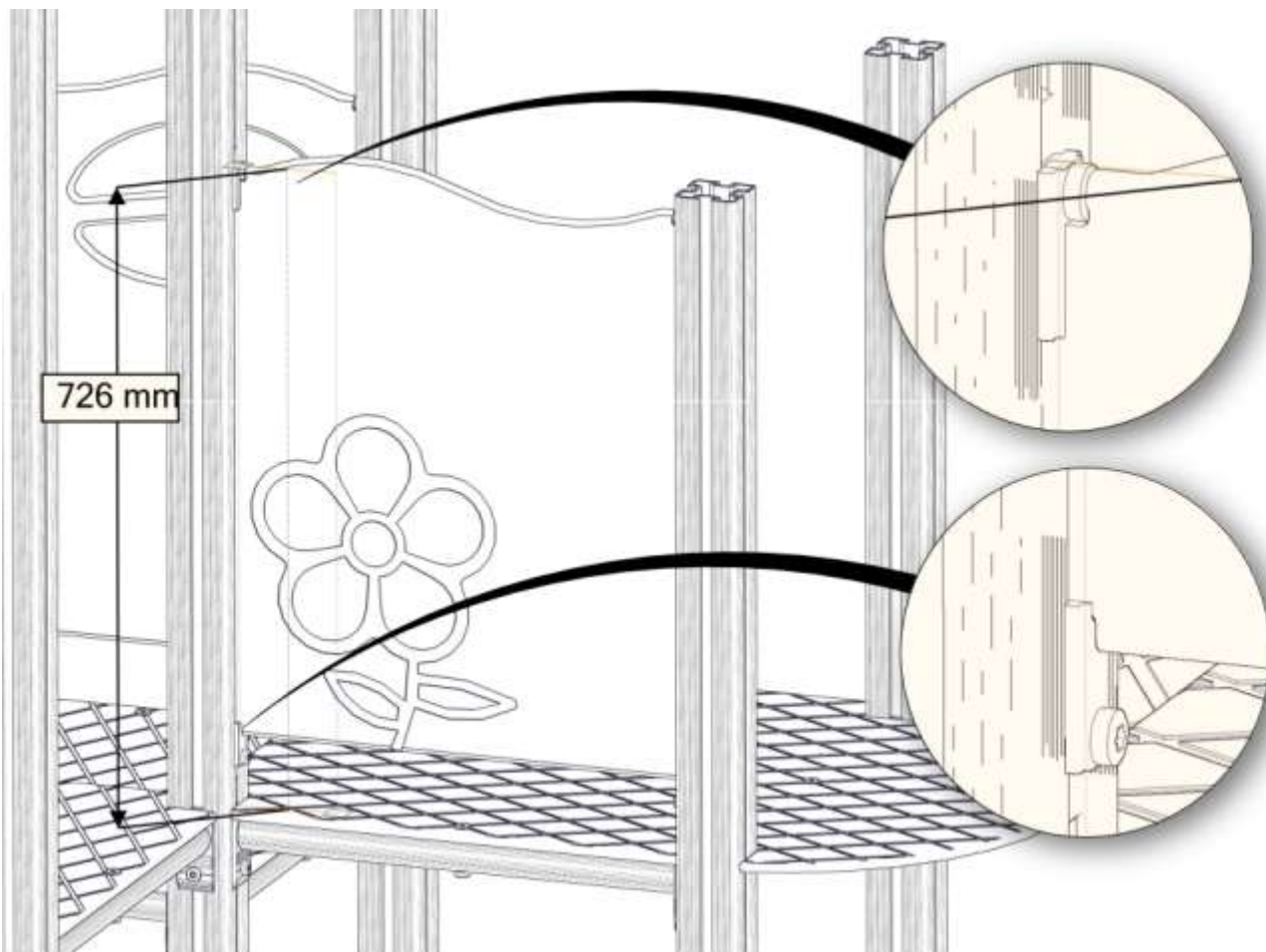

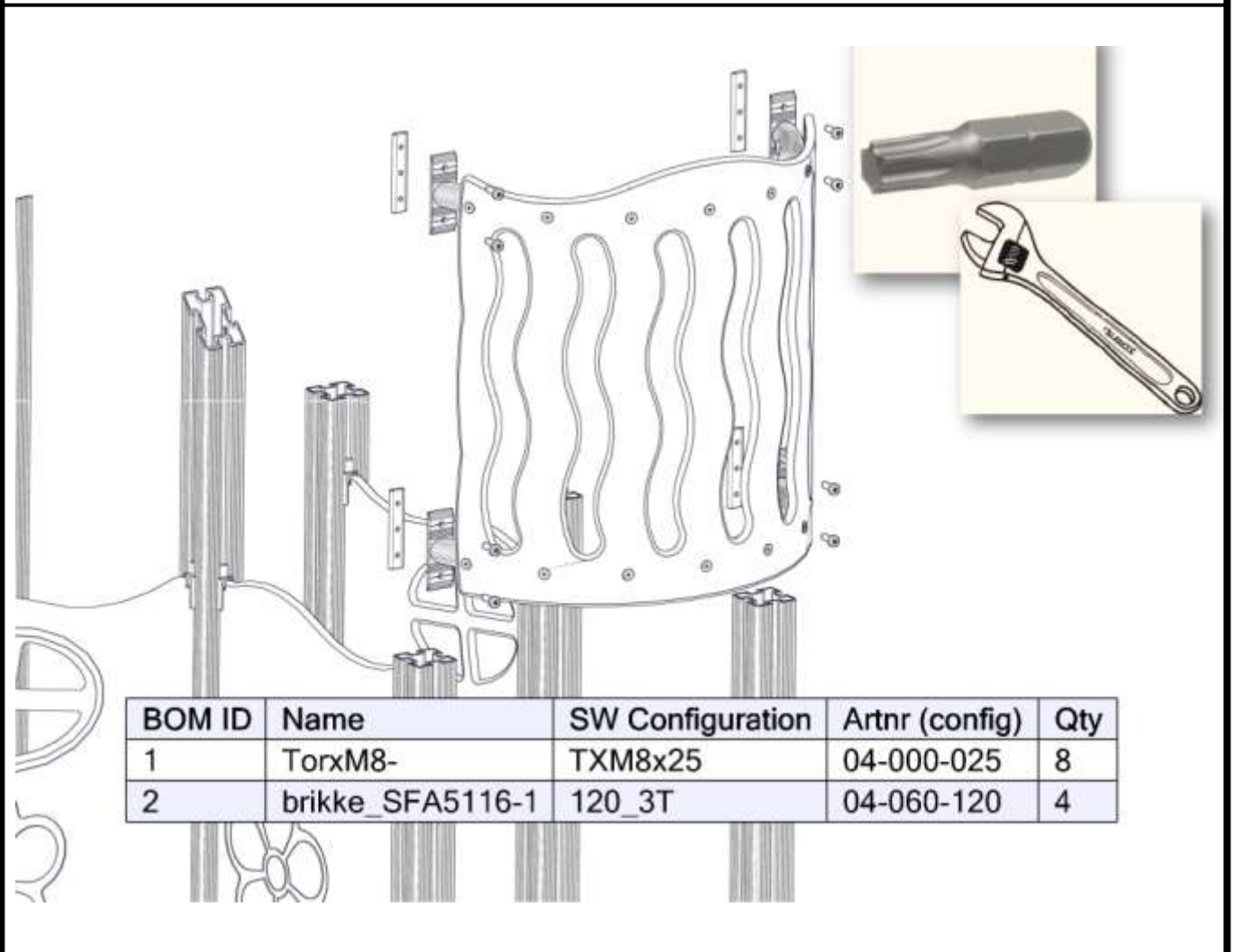
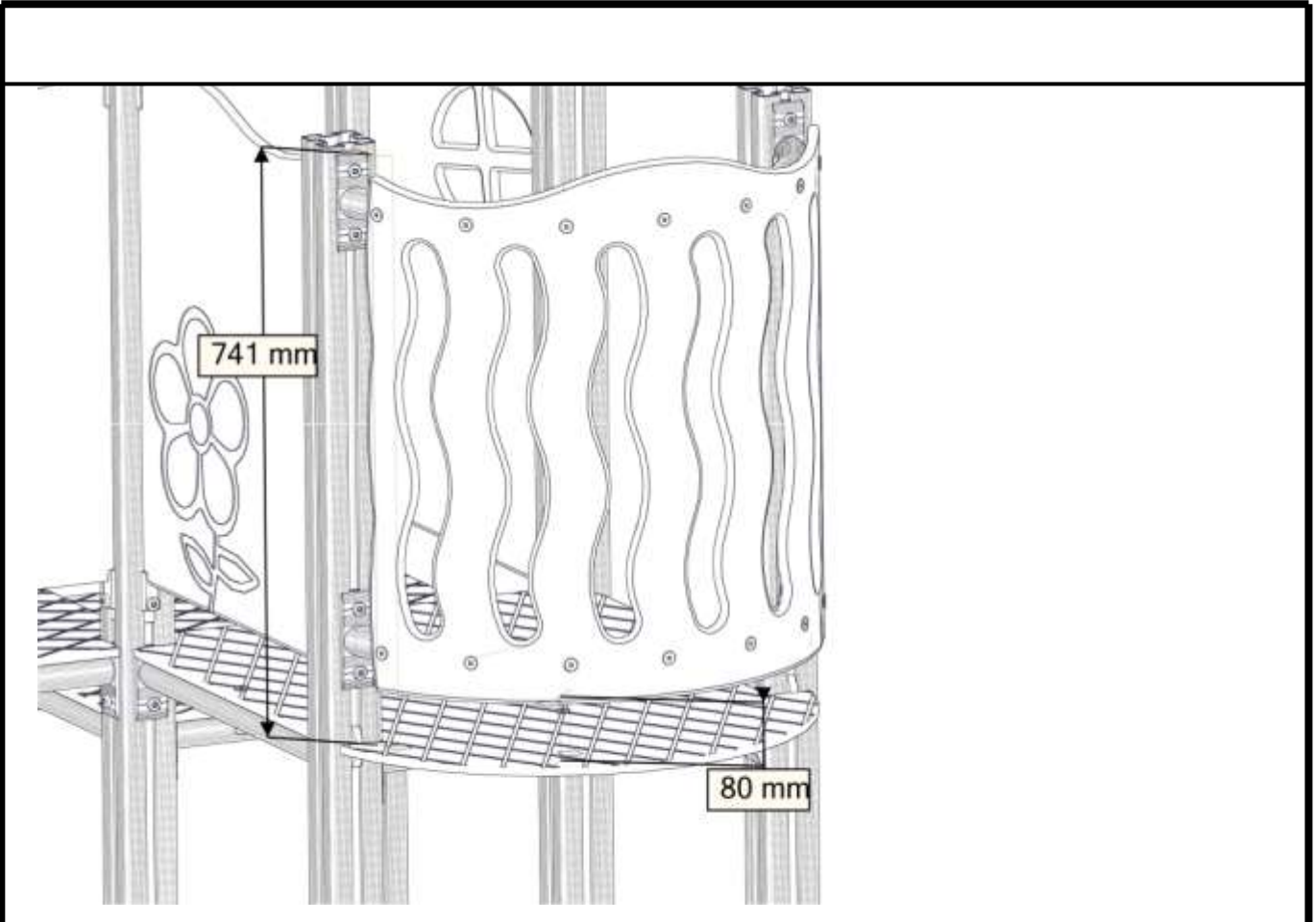

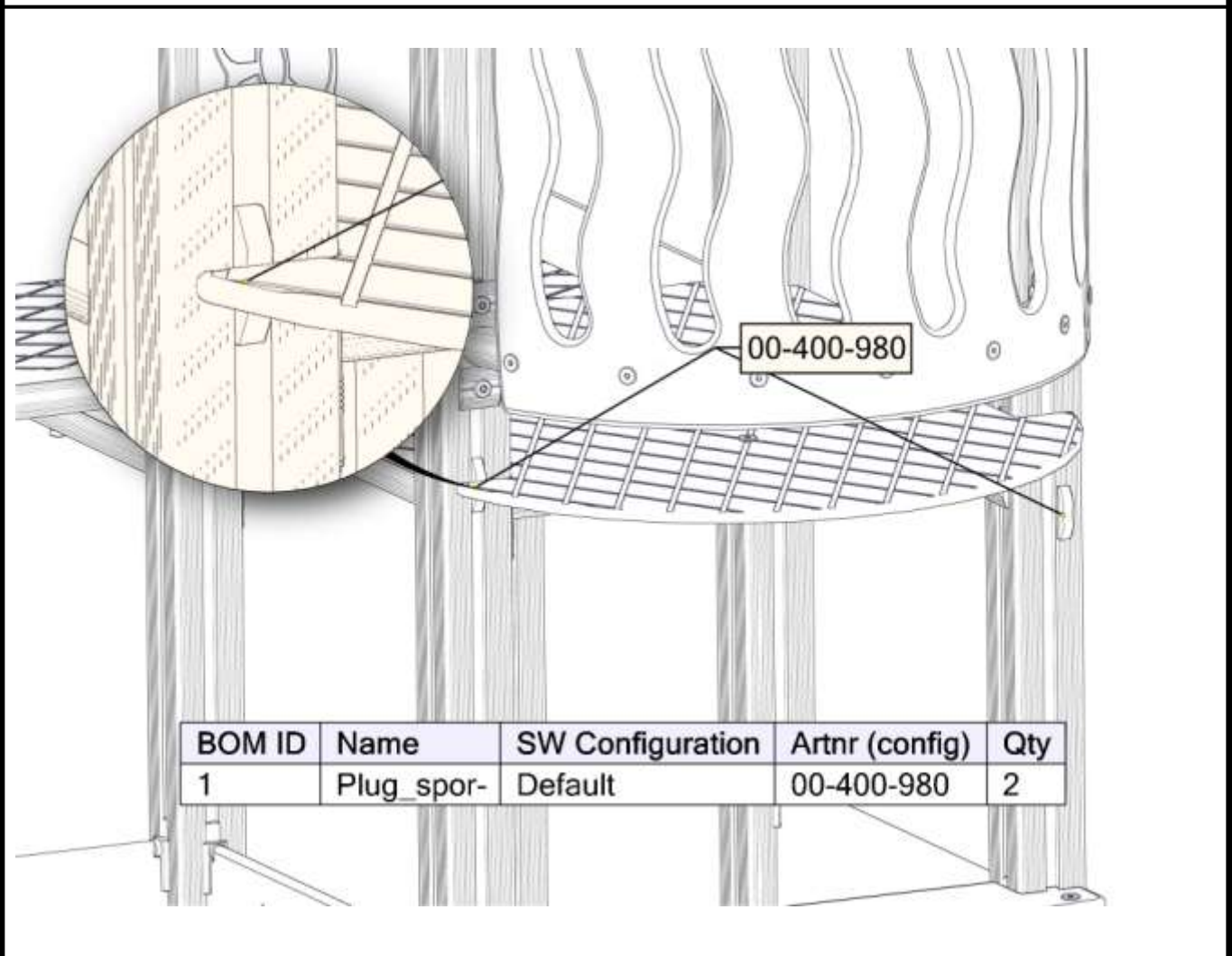
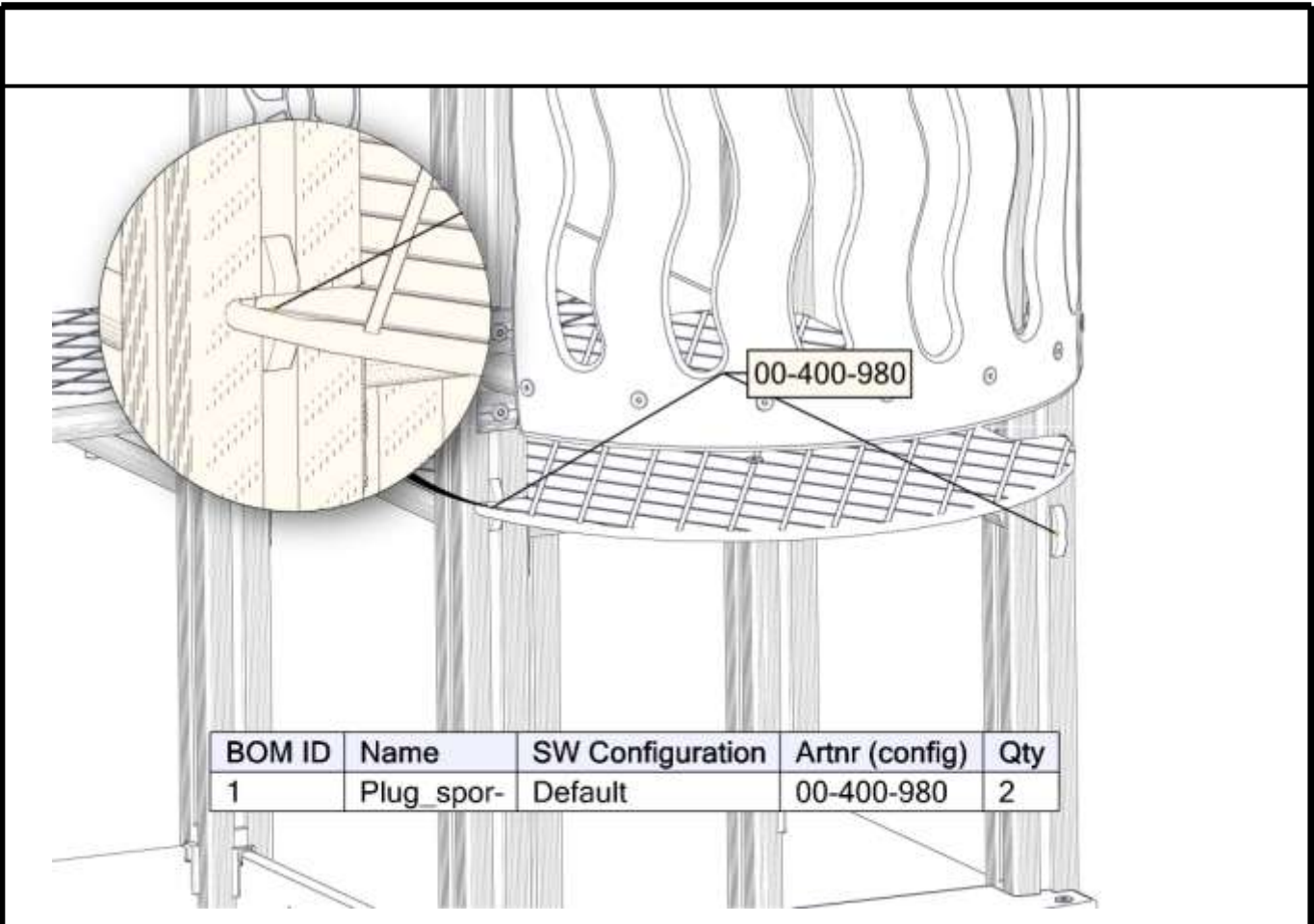

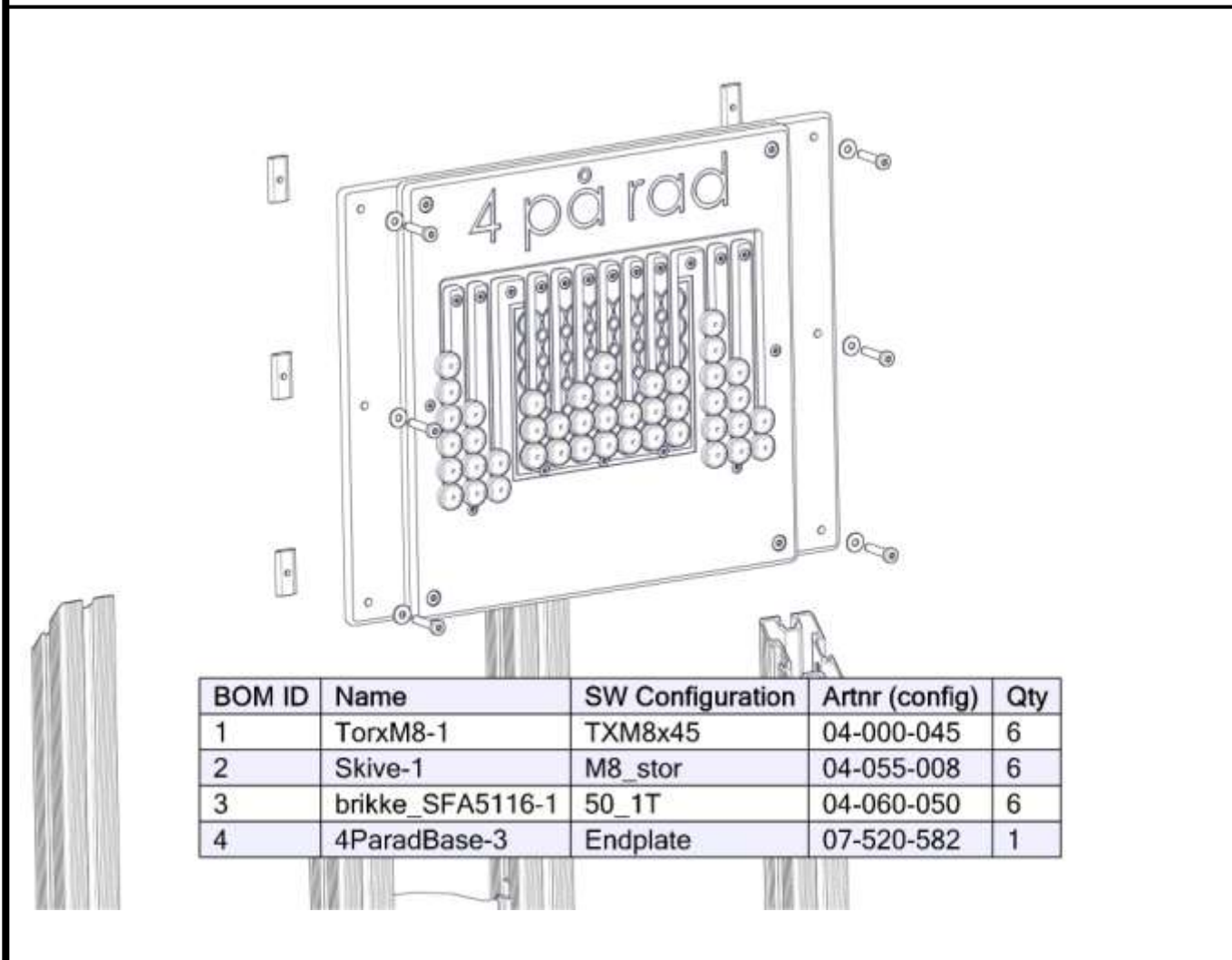
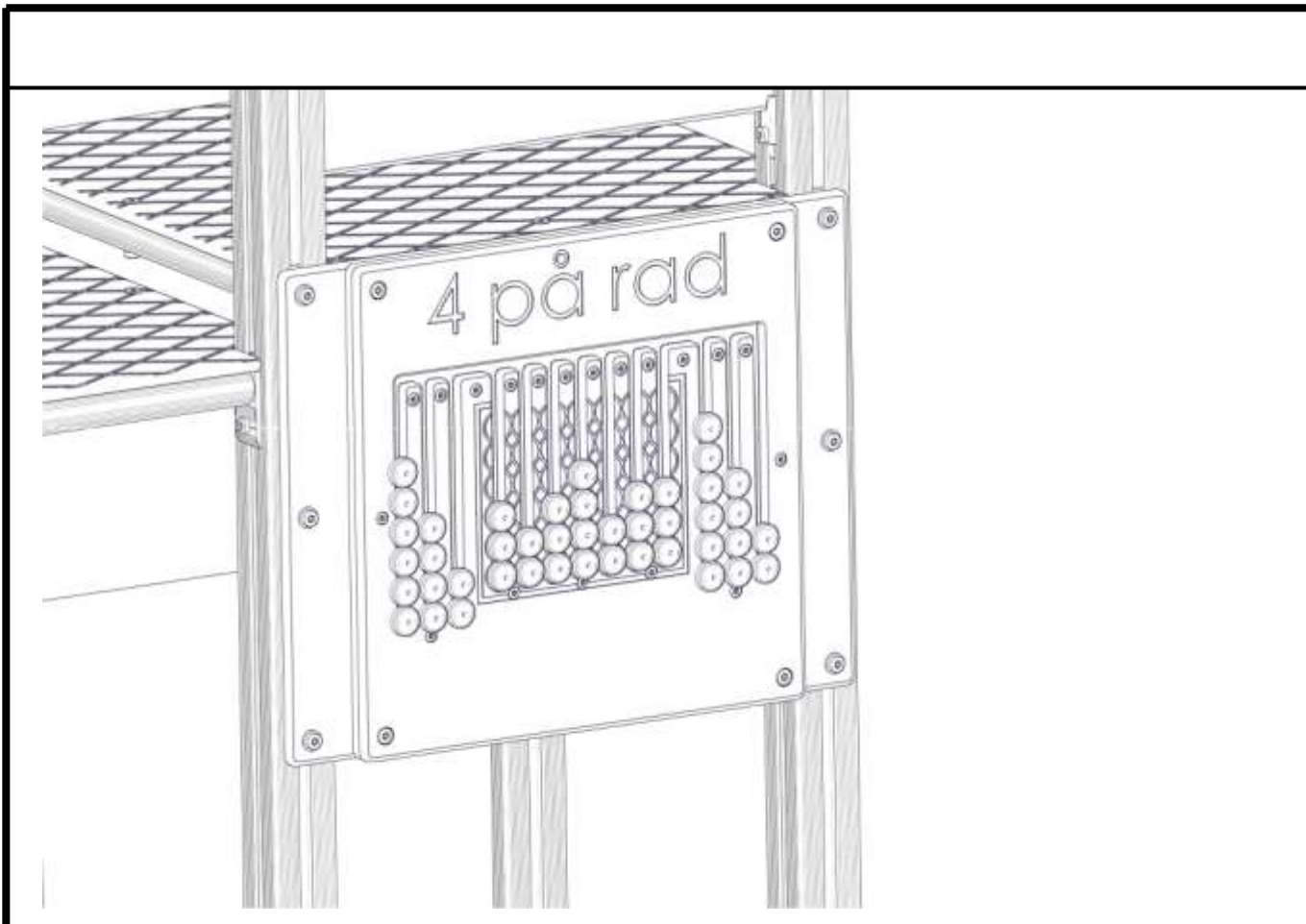

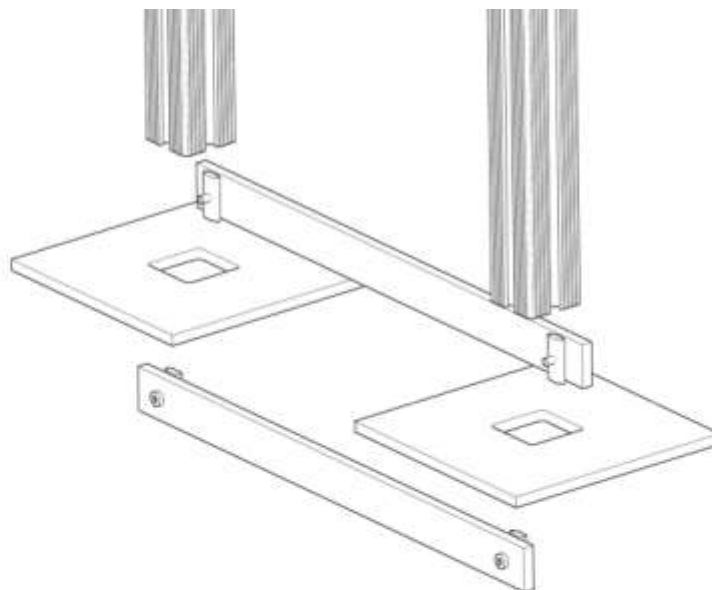
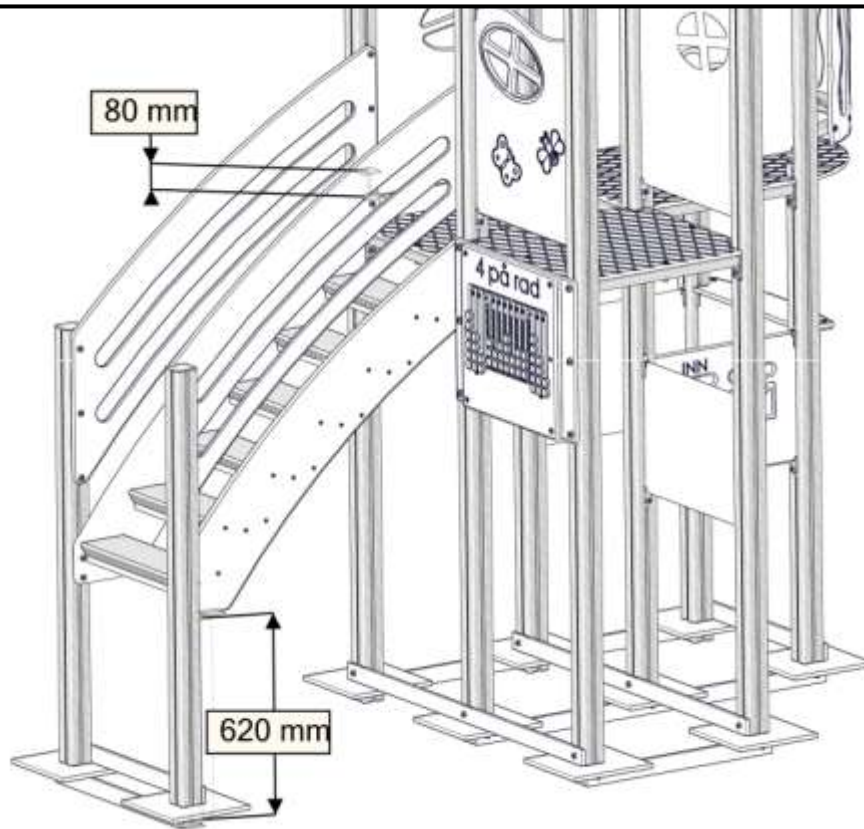

BOM ID	Name	SW Configuration	Artnr (config)	Qty
5	TorxM8-	TXM8x35	04-000-035	4
6	brikke_SFA5116-	50_1T	04-060-050	4
7	minifun_sprosse-1	660	07-510-200	2
8	minifunSkive-	Default	07-510-201	2
9	VK70_SFA5123-1	600-800	07-510-455	2

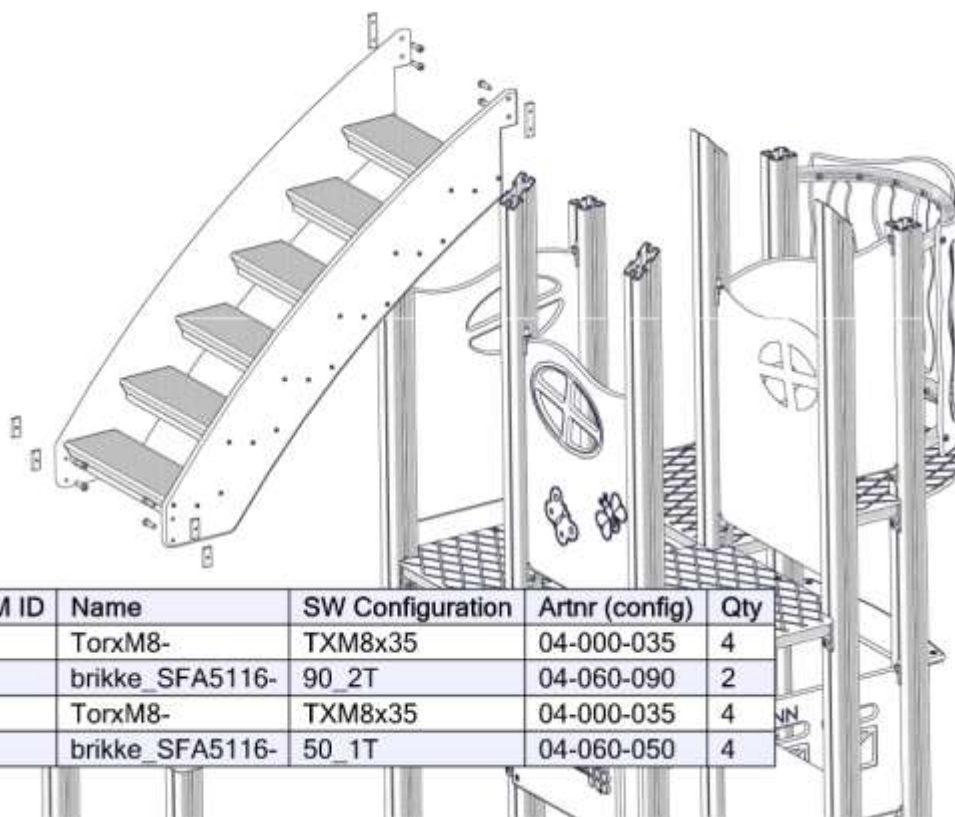

BOM ID	Name	SW Configuration	Artnr (config)	Qty
1	Torxm8-	TXM8x35	04-000-035	4
2	brikke_SFA5116-	90_2T	04-060-090	2
3	Torxm8-	TXM8x35	04-000-035	4
4	brikke_SFA5116-	50_1T	04-060-050	4

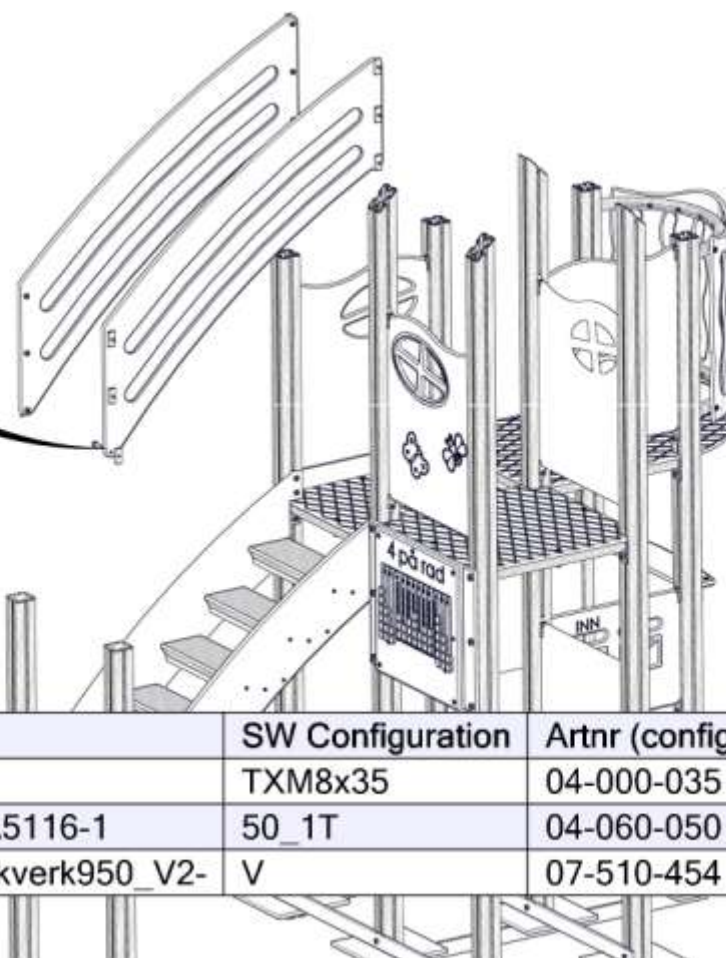

BOM ID	Name	SW Configuration	Artnr (config)	Qty
1	Torxm8-1	TXM8x35	04-000-035	12
2	brikke_SFA5116-1	50_1T	04-060-050	12
3	TreppeRekkverk950_V2-	V	07-510-454	2

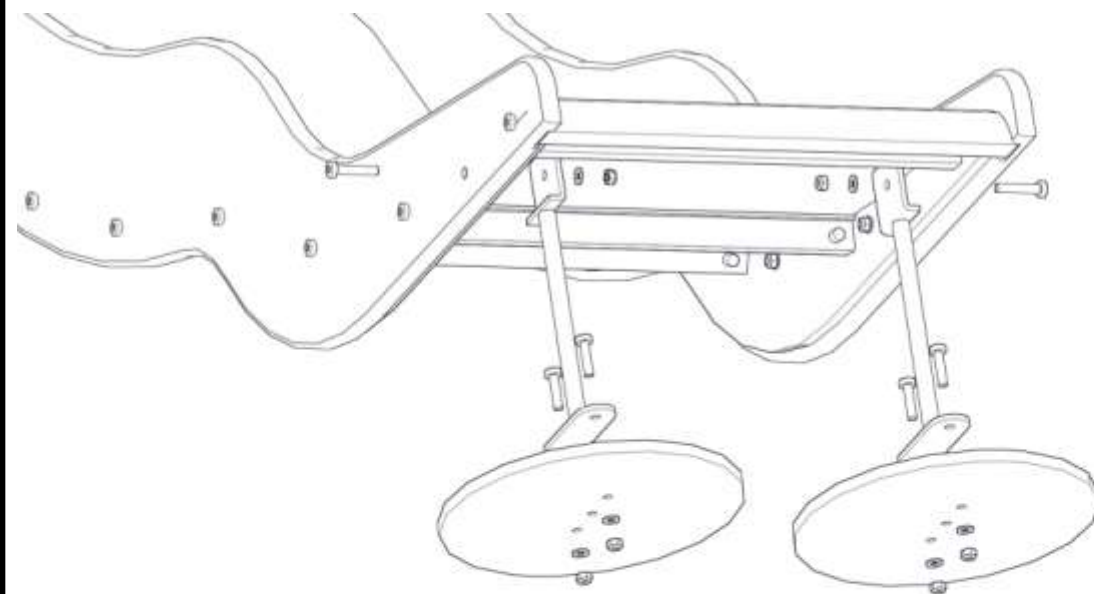
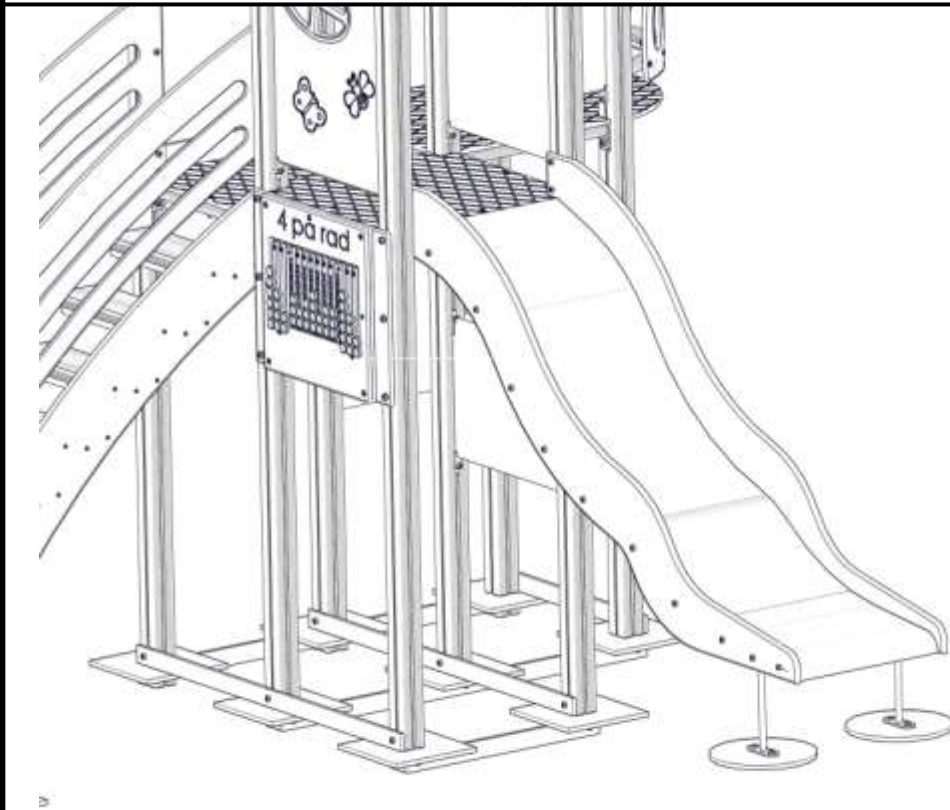

BOM ID	Name	SW Configuration	Artnr (config)	Qty
1	Fundament platte 2H-1	Hoh80	00-003-106	2
2	Stalforankring-1	liten	00-100-312	2
3	Torxm8-	TXM8x35	04-000-035	4
4	Torxm8-1	TXM8x45	04-000-045	2
5	mutter M8-	M8 Borg	04-040-008	6
6	Skive-	M8	04-050-008	6

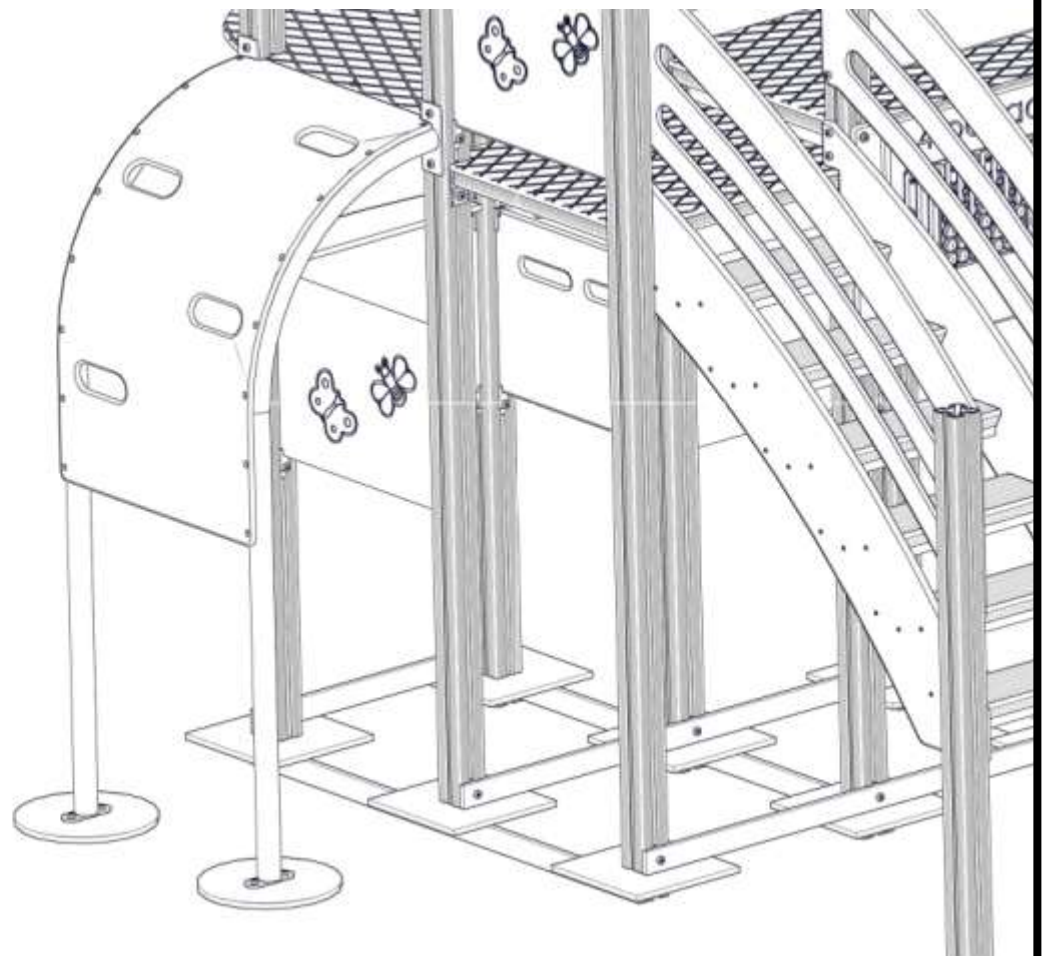
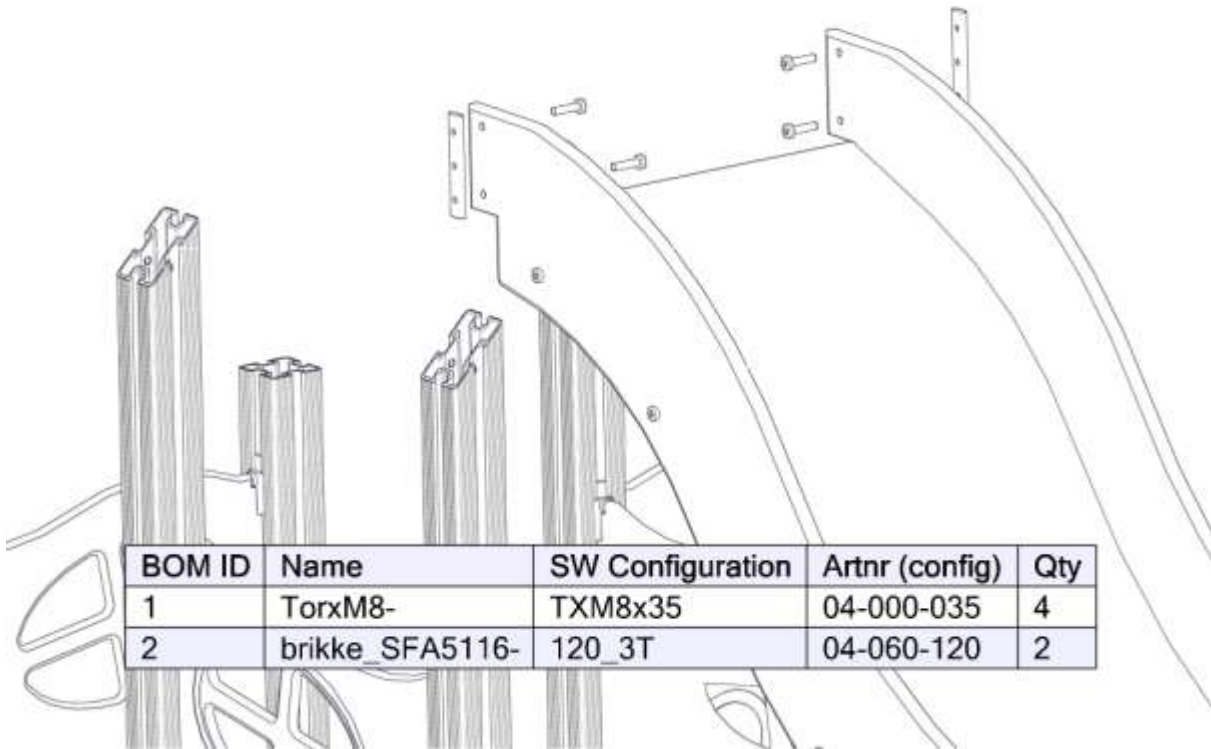

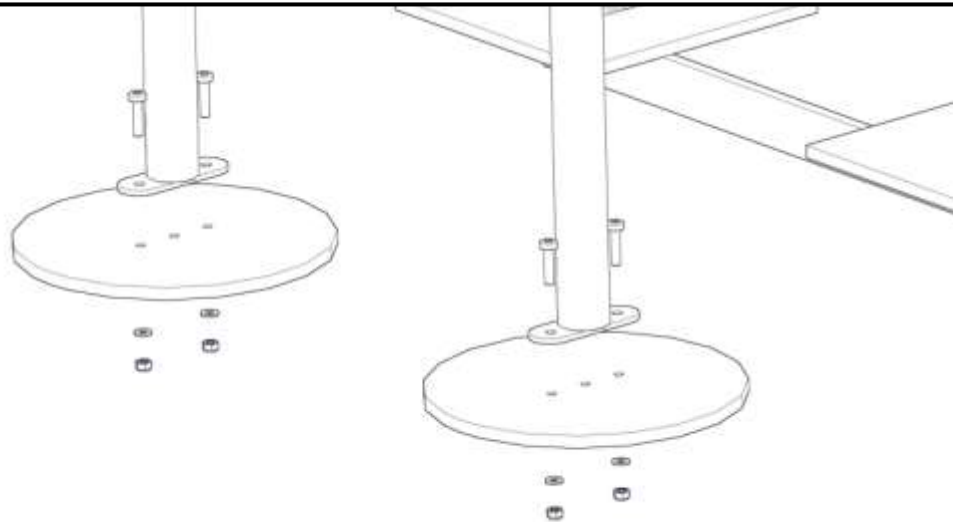

BOM ID	Name	SW Configuration	Artnr (config)	Qty
1	Fundament_platte_2H-	Hoh80	00-003-106	2
2	Torxm8-1	TXM8x35	04-000-035	4
3	mutter_M8-1	M8_Borg	04-040-008	4
4	Skive-1	M8	04-050-008	4

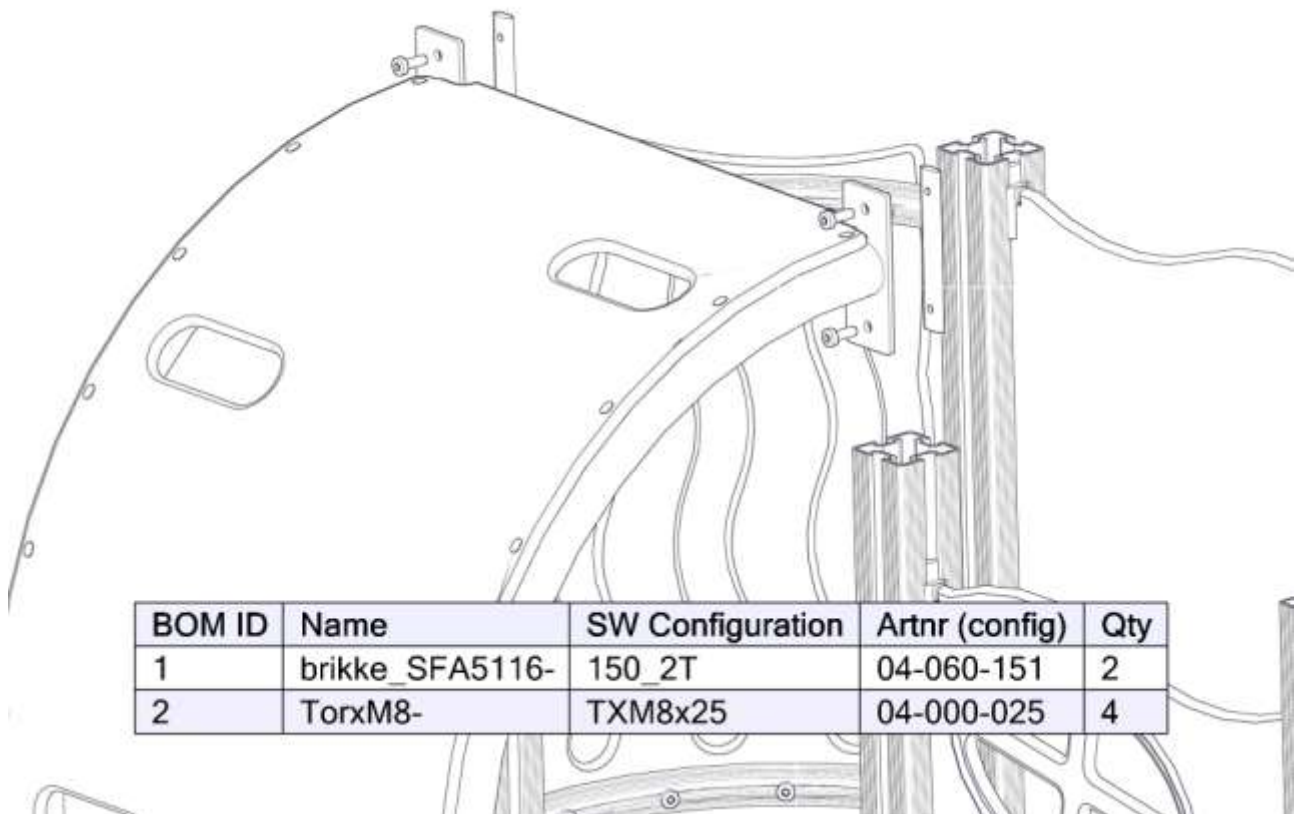

BOM ID	Name	SW Configuration	Artnr (config)	Qty
1	brikke_SFA5116-	150_2T	04-060-151	2
2	Torxm8-	TXM8x25	04-000-025	4

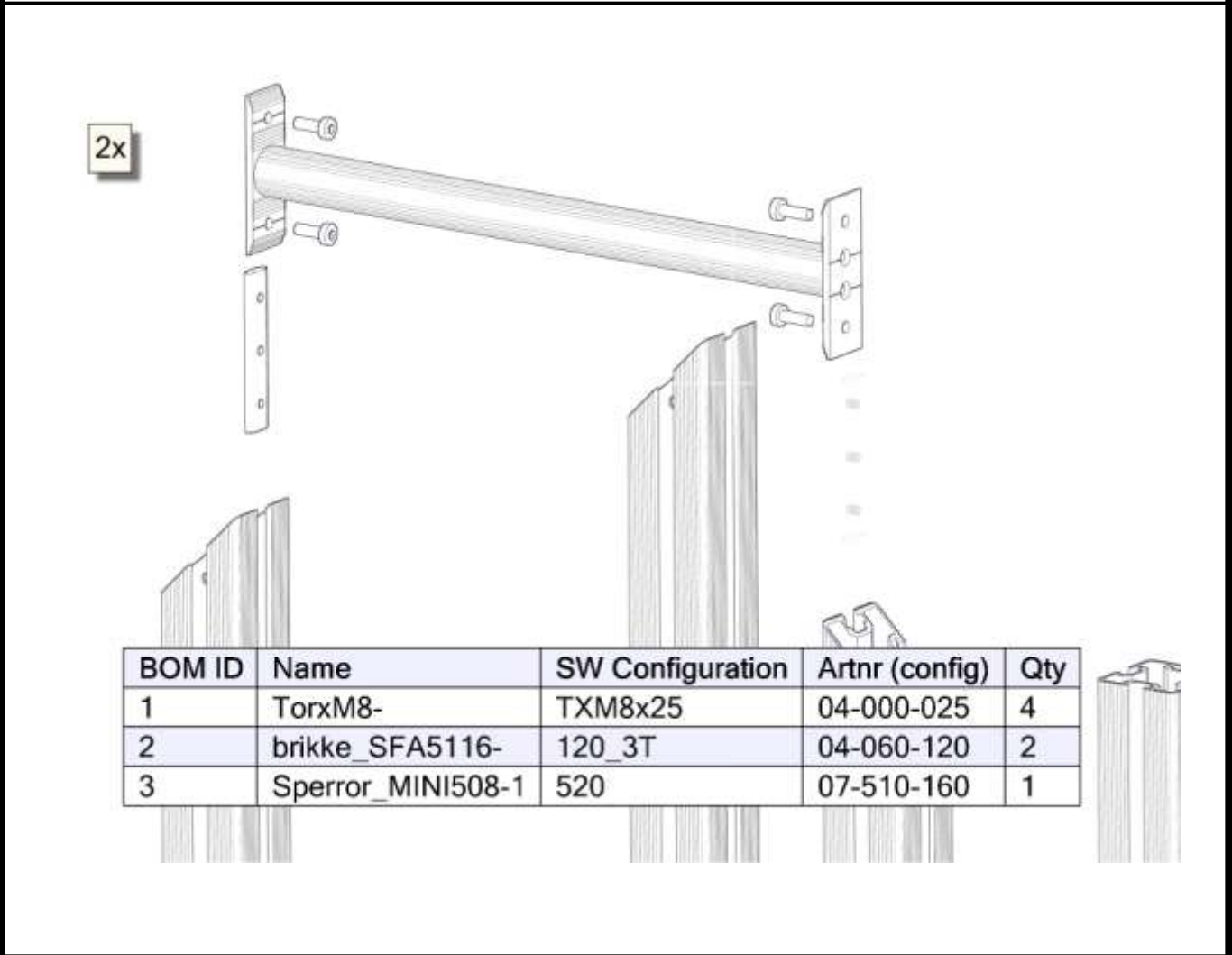
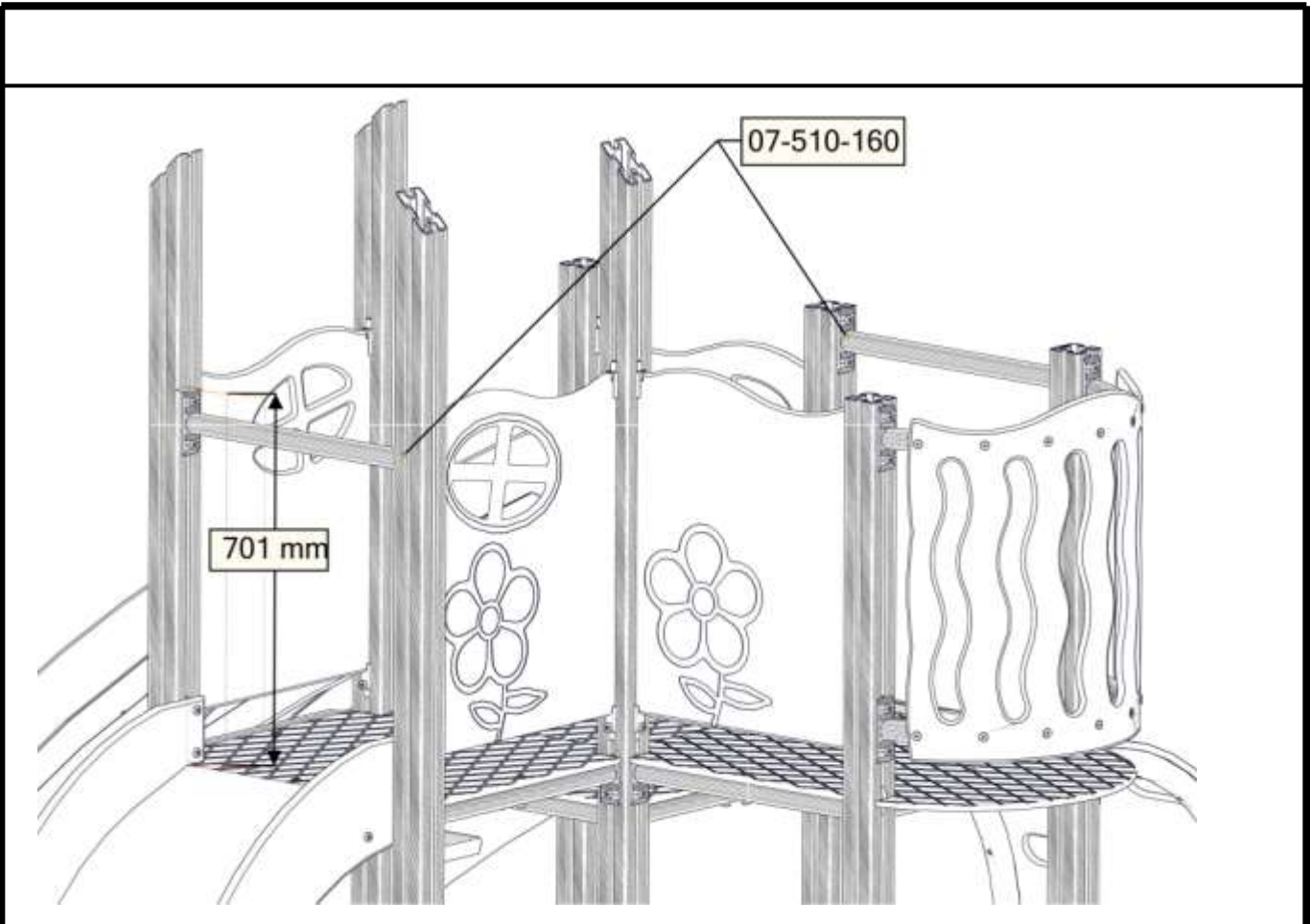

BOM ID	Name	SW Configuration	Artnr (config)	Qty
1	Torxm8-	TXM8x25	04-000-025	4
2	brikke_SFA5116-	120_3T	04-060-120	2
3	Sperror_MINI508-1	520	07-510-160	1

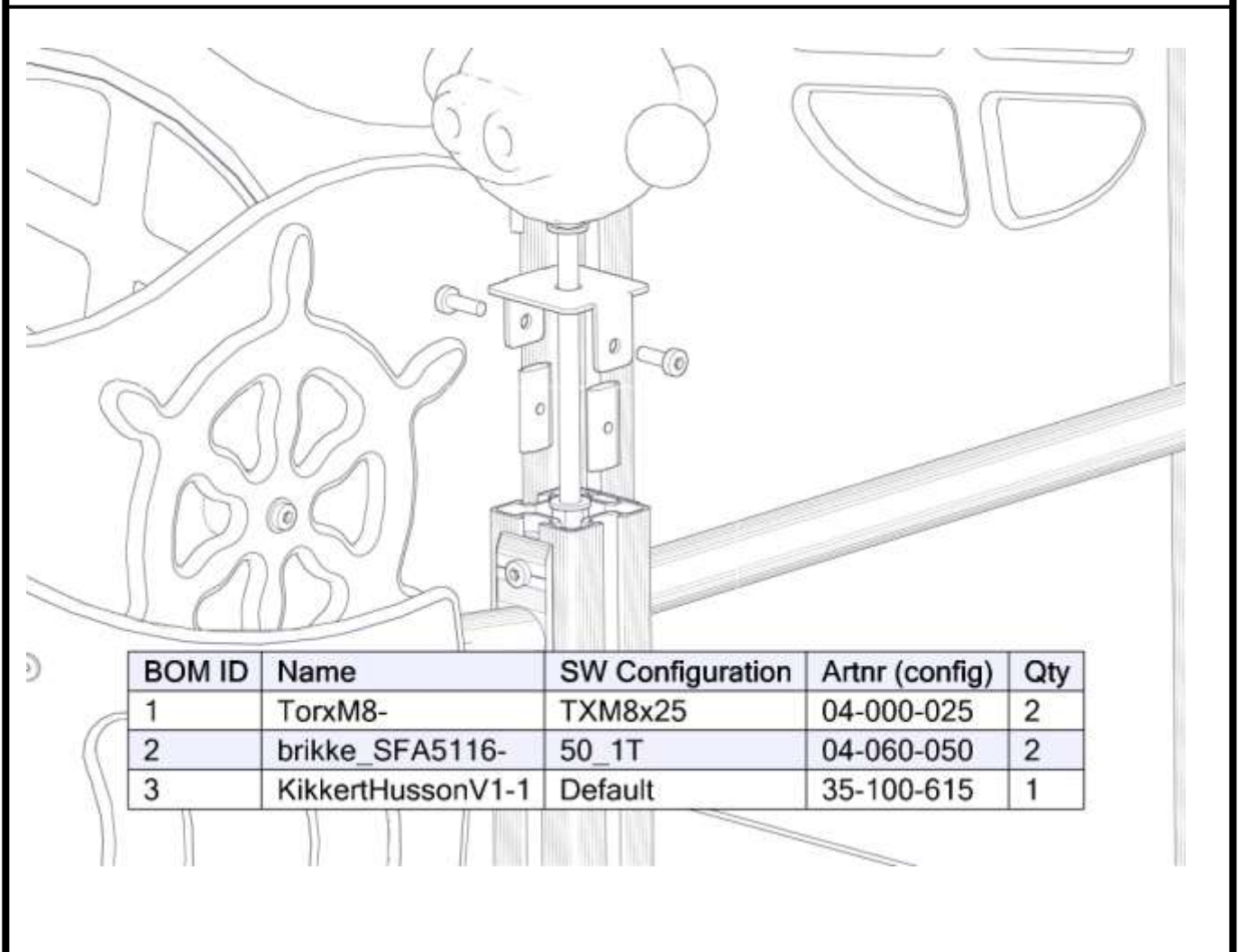
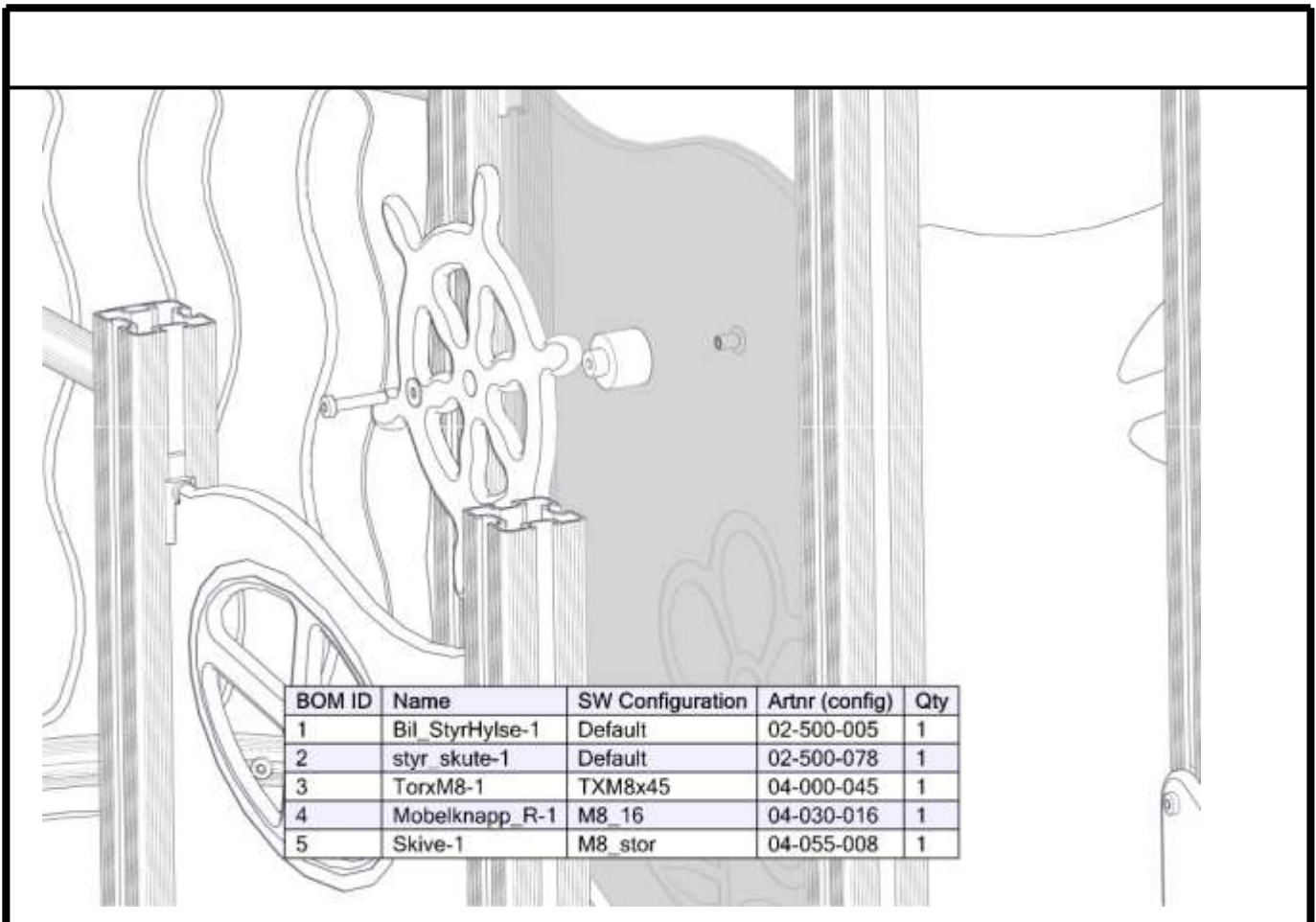

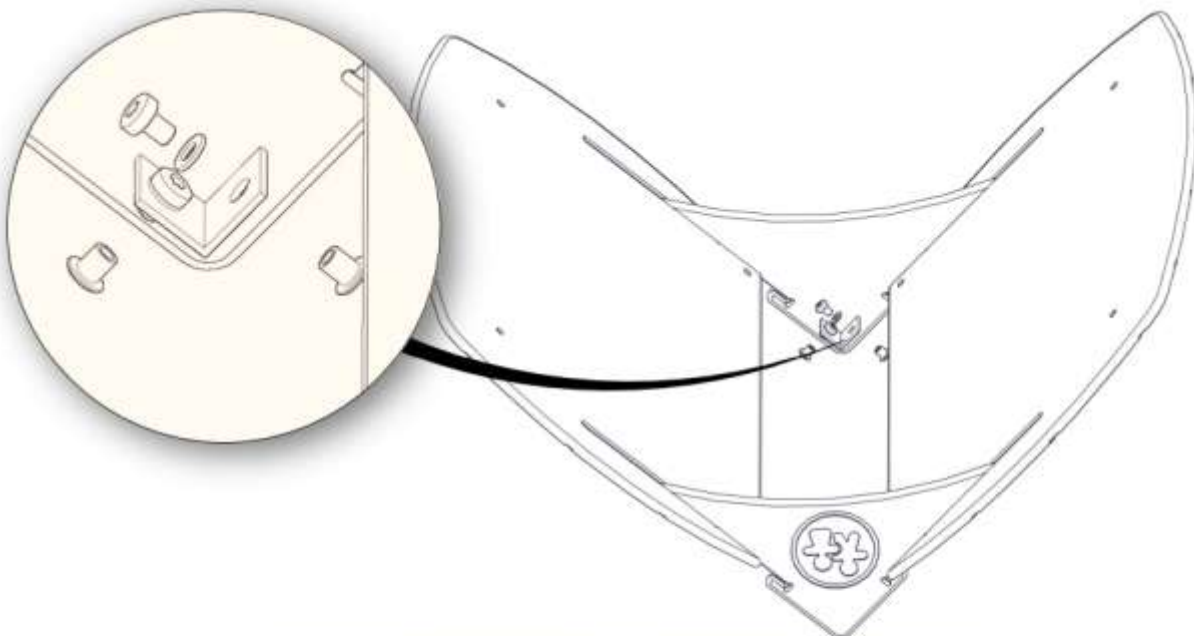
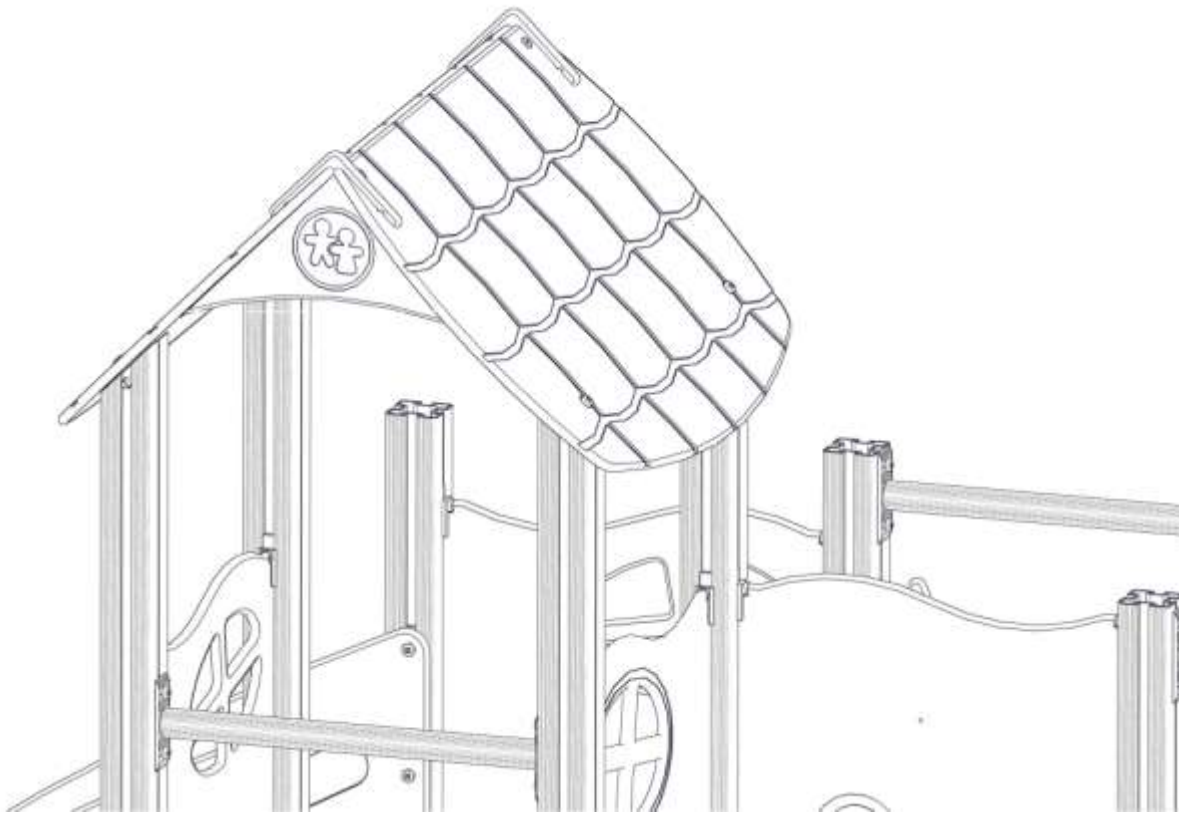

BOM ID	Name	SW Configuration	Artnr (config)	Qty
1	TorxM8-	TXM8x12	04-000-012	4
2	Mobelknapp-	M8 13 17	04-030-011	4
3	Skive-	M8	04-050-008	4
4	35x35x3-1	11mm	04-070-036	2
5	Tak_Miniserie2011-	rod	07-510-105	2
6	Gavelplatemini2011-	Rod	07-510-106	2

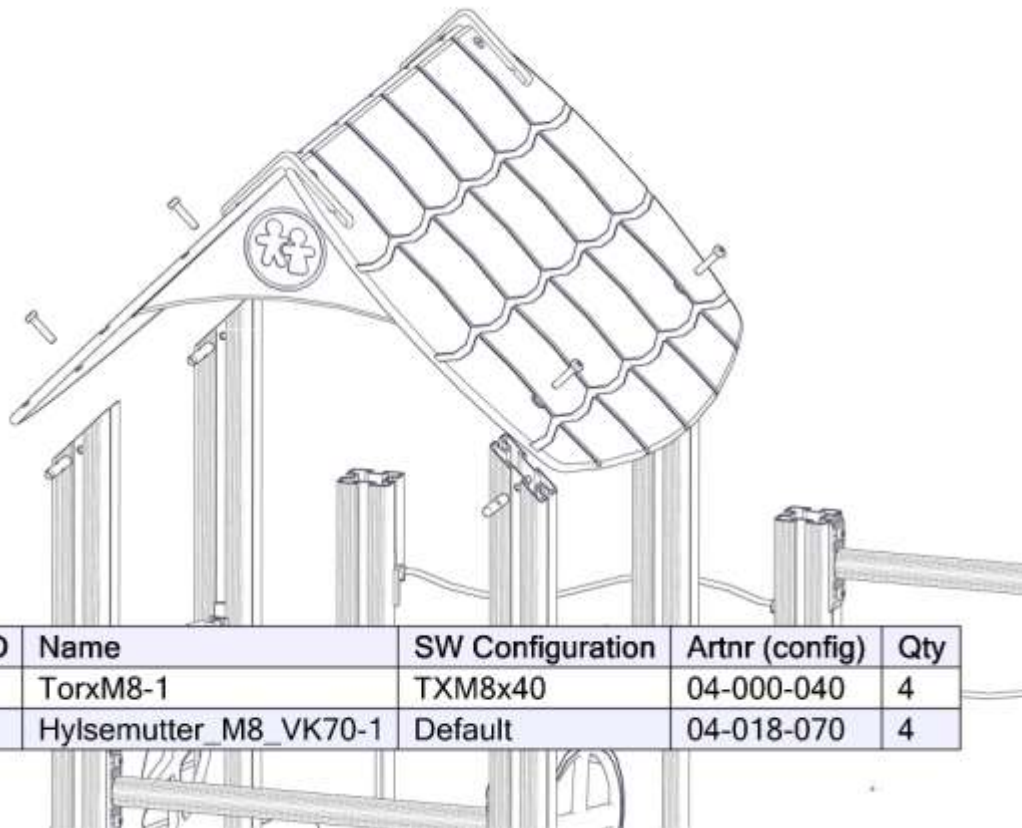



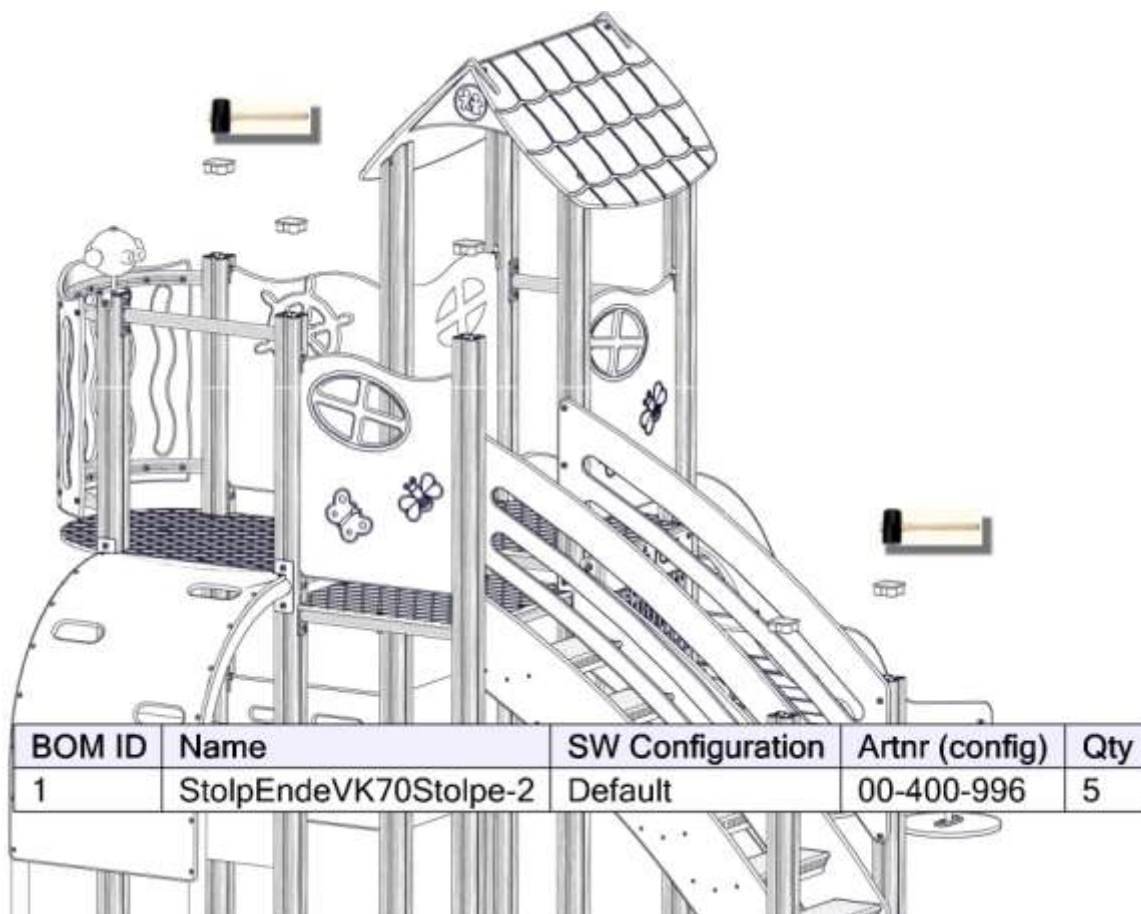















BOM ID	Name	SW Configuration	Artnr (config)	Qty
1	TorxM8-1	TXM8x40	04-000-040	4
2	Hylsemutter_M8_VK70-1	Default	04-018-070	4



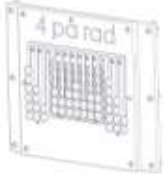



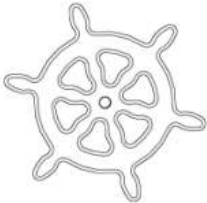



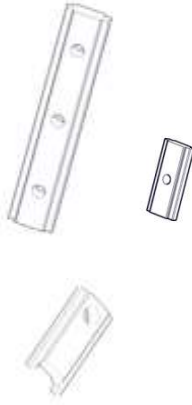

BOM ID	Name	SW Configuration	Artnr (config)	Qty
1	StolpEndeVK70Stolpe-2	Default	00-400-996	5

Før utstyret tas i bruk / Before play begins / Innan lekredskapet tas i bruk	
N	<ul style="list-style-type: none"> ● Påse at fallunderlag er utlagt i henhold til gjeldende regler eller vår anbefaling ● Fjern alle monteringshjelpemidler (rester av betong, planker, paller, plast, og lignende) ● Før utstyret tas i bruk, burde man sjekke at det ikke er fare for at anorakksnorer og lignende som kan hekte seg fast noen steder på lekeapparatet. (Vedlagte snor med dobbe (kneledd) kan brukes til å sjekke at dette er i orden. Se vedlagte veiledning for bruk av denne. Dette gjøres for å oppdage eventuelle feilmonteringer.?) ● NB! Bør stå i 2-3 dager før bruk
UK	<ul style="list-style-type: none"> ● Make sure the area and depth of safer surfacing are according to the current standard, or to the manufacturer's recommendation ● Make sure all tools and surplus materials are removed before play begins ● PS! When complete, allow 2-3 days for the concrete to set before use
S	<ul style="list-style-type: none"> ● Kontrollera att fallunderlag är utlagt enligt gällande regler eller vårt rekommendation ● Ta bort alla monteringshjälpmedel (rester av betong, plankor, pallar, plast och liknande) ● Innan lekredskapet används, kontrollera att anoracksnoddar eller kläder/delar av kläder eller liknande inte kan fastna i några delar på redskapet. (Den bipackade "knävringen" kan man med fördel användas för denna kontroll. ● Detta görs för att upptäcka eventuella felmonteringar.)

komponenter		Sign. _____.
	VK70 2100-600 skrå 07-510-158 4	Endelokk 5 
	VK70 1700-600 4 07-510-150	Minisprosse fund 4 L=1250 07-510-202
	VK70 600-800 2 L=1400 07-510-455	Minisprosse fund 4 L=660 07-510-200
	Gulv Mini 520 1 07-510-102	Mini fundament 10 skive 07-510-201
	Gulv Mini 520 1 LANG 07-510-104	Vegg 520x600 1 07-510-120
	Vegg 520x600 1 07-510-125 UTEN vindo Med hull styr	Vegg 520x600 2 07-510-120
	Vegg 520x400 3 07-510-110	Vegg 520x400 1 07-510-111 Postkasse
	Sperrerør 520 2 07-510-160	Sperrerør gulv 12 07-510-161

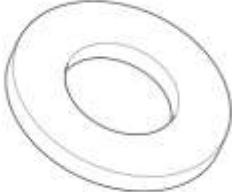
komponenter		Sign. _____
	Utsikt på sper- rerør 07-510-134	1
	Gulv Utsikt 05-510-101	1
	Kikkert 35-100-615	1
	Trapp 950 07-510-451	1
	Søve 4 på rad 25-100-010	1
	Trapp 950 rekkverk 07-510-454	2
	Rutsjebane 07-510-310	1
	Butikkdiskk 07-510-130	1
	Skute styr 02-500-078	1
	Bilstyr hylse 02-500-005	1
	Krabbeplate 07-510-135	1

komponenter		Sign. _____				
	Torx M8x12 04-000-012	6		Brikke 50-1T 04-060-050	74	
	Torx M8x20 04-000-020	2		Brikke 90-2T 04-060-090	2	
	Torx M8x25 04-000-025	74		Brikke 150-2T 04-060-151	2	
	Torx M8x30 04-000-030	6		Brikke 120-3T 04-060-120	14	
	Torx M8x35 04-000-035	48		Spesialbrikke 04-060-041	32	
	Torx M8x40 04-000-040	8			Låsemutter M8 04-040-008	10
	Torx M8x45 04-000-045	18				Stålforankring 00-100-310
Torx M8x50 04-000-050	1					
	Møbelknapp M8x13x17 04-030-011	19		Hylsemutter M8 12-70 04-018-070	4	
	Tak mini 07-510-105	2		Plug Spor 00-400-980	2	
	GavelplateMini 07-510-106	2		Fundamentplate 00-003-106	4	
	Skive M8 04-050-008	20		Vinkel 35x35x35 04-070-036	2	
	Stor Skive M8 04-055-008	1		Vinkel 50x50x50 04-070-050 11mm	2	