

N**Monteringsanvisning****EN****Assembly Instructions****S****Monteringsanvisning**

Produkt nr. / Product no. / Produkt nr.

25-200-180

Ordr. nr. _____

Dato. _____

Sign. _____

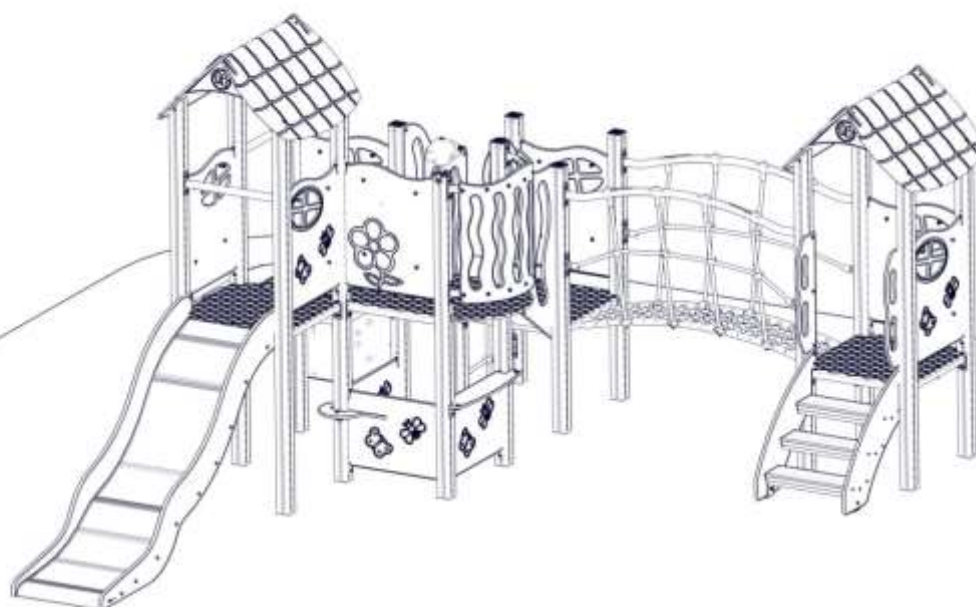

Søve AS
Grønnvoldveien 290
3830 Ulefoss - Norway
Tlf: +47 35 94 65 65



Søve AB
EA Rosengrensgatan 32
421 31 Västra Frölunda
Phone: +46 (0)31 773 97 00
www.sove.se

Monteringstips / Assembly Advice / Monteringsstips

N

- Les monteringsanvisningen nøye før montering.
- Monter elementene i rekkefølgen som vist.
- Boltene bør ikke skrues for hardt til før alt er montert, vatret og loddet. Skru så boltene til.
- NB! Ved bruk av drill, kan boltene ryke.
- Er lekeutstyret plassert i naturlige ferdselstraséer må området sikres mot gjennomgang.
- Innspringningshinder bør vurderes rundt lekeapparater hvor det er stor bevegelse, f.eks. ved huskestativ.
- Det bør være fritt innsyn til lekeutstyr som er beregnet for barn under 3 år.

NB! Under monteringsarbeidet må utstyr, som ikke er forankret forsvarlig i bakken, sikres slik at det ikke velte.

Området må avstenges under montering av apparatene med sperrebånd eller lignende.

EN

- Read the instruction carefully before assembling the play unit..
- Assemble the components in the sequence shown in these instructions.
- Fixings must not be fully tightened during assembly. Before casting the foundations, the structure must be level and plumb, at which point all fixings are tightened.
- PSI! If use of drill, the bolts may be wrecked.
- Secure the construction-area to prevent people from walking through it.
- Consider installing barriers around play-equipment which gives rise to a lot of activity – i.e.swings.
- Ensure that clear vision is possible across the play area so that supervision is possible from any position, particularly where children under 3 years of age will be playing.

NB! During assembly of the equipment, ensure that all structures are securely propped, especially when left overnight. Also ensure that equipment is supported whilst concrete foundations are setting and enclose the area securely to prevent access.

Monteringstips / Assembly Advice / Monteringsstips

S

- Läs monteringsanvisningen noga före montering.
- Montera delarna i den ordningen som anvisas
- Skruvarna bör inte skruvas för hårt tills allt är monterat, i våg och lodat.











OBS! Används elektrisk skruvdragare, kan bulten gå sönder. Hårdra därför manuellt!

- Om lekplatsen placeras vid en gångväg mm bör området säkras mot genomfart av gående och cyklister.
- Inspringshinder bör placeras runt lekutrustning med stor rörelse, t ex, gungställning.
- Det bör vara fri insyn till lekutrustning beräknat till barn under 3 år.

OBS! Under monteringsarbete bör utrustningen som inte ska förankras i marken, ställs så att den inte kan välta.

Området måste spärras när lekutrustningen byggs upp, med avspärrningsband eller liknande.

Nødvendig verktøy / Tools required / Nödvändiga verktyg

<p>(N)</p> <p>(UK)</p> <p>(S)</p>	<p>(A)</p> 	<p>(B)</p>  <p>Torx Nr 45 High quality</p>	<p>(C)</p> <p>5 mm 6 mm</p> 	<p>(D)</p> 	<p>(E)</p> 
		<p>Metermål Metric measure Tumstoc</p> 	<p>16 V</p> 	<p>Merkeband Mark ribbon Märkeband</p> 	<p>13 + 17mm</p> 

Nødvendig antall personer / Number of persons required / Lämpligt antal personer





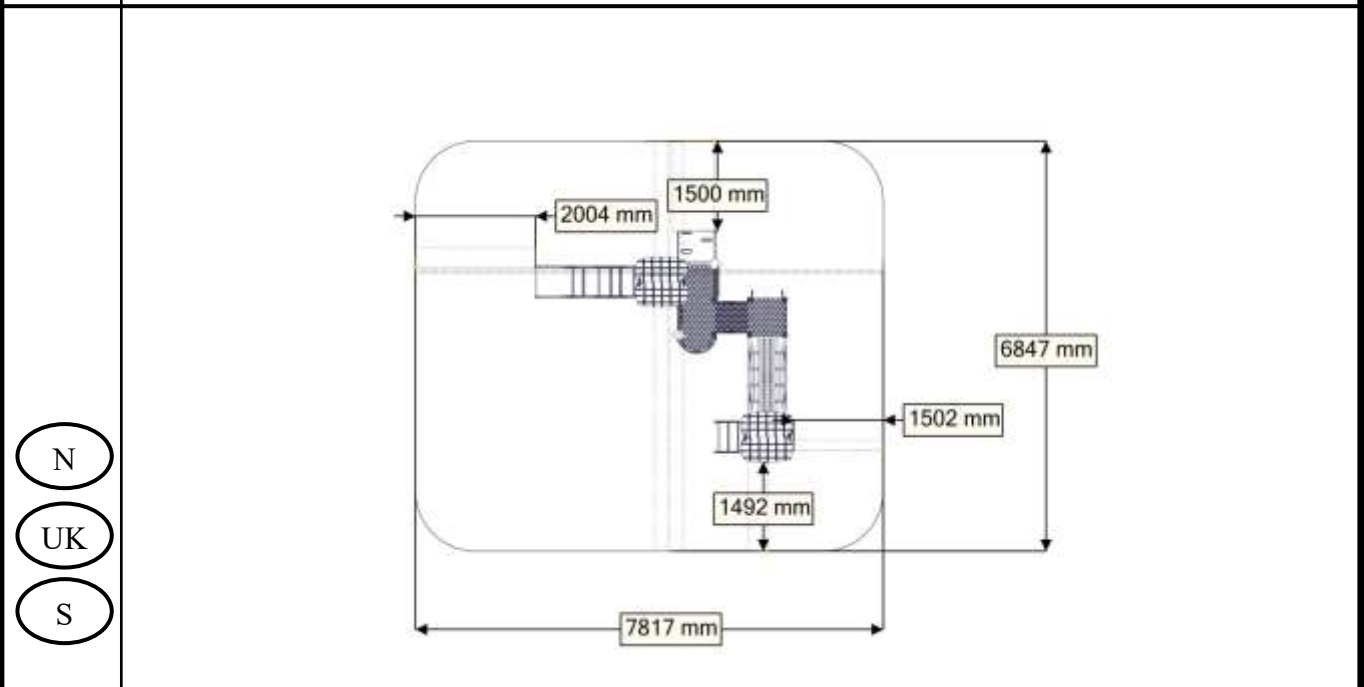









Anbefalt arealbehov ved montering / Recommended working space / Rekommenderad arealbehov vid montering





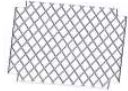







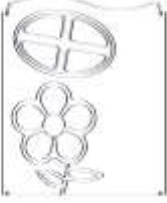



Boltepakker for / Boltpackage for / Bultpaket för

Sign. _____

Stolpe 70x70 skrå	Ant= 4	Navn	Artnr/dimensjon	Ant	Lev
	C+D+E+F	VK70 2100-600 (1) Skrå	07-510-158	4	
	O+P+M+N	VK70 1700-600 Brikke på stolpe!	07-510-156	4	
		Torx M8x40 (1)	04-000-040	8	
	Hullsemutter (1) VK70	04-018-070	8		
Stolpe 70x70	Ant= 4	Navn	Artnr/dimensjon	Ant	Lev
	A+B+G+H	VK70 1700-600 (1)	07-510-150	4	
	B+I+J+K+L	VK70 1400-600(1) Brikke på stolpe!	07-510-157	4	
		Endelokk	00-400-996	6	
FundamentMini	Ant= 8+6	Navn	Artnr/dimensjon	Ant	Lev
		MiniSprosse 660 (1) Minisprosse 1250(1)	07-510-200 07-510-202	8 6	
		Brikke 50_1T (2)	04-060-040	34	
		Torx M8x35 (2)	04-000-035	34	
FundamentSkive	Ant= 16	Navn	Artnr/dimensjon	Ant	Lev
		Skive (1)	07-510-201	16	
Gulv mini	Ant= 4	Navn	Artnr/dimensjon	Ant	Lev
		Gulv Mini 520(1)	07-510-102	4	
		Møbelknapp (4)	04-030-011	16	
		Torx M8x45 (4)	04-000-045	16	













Boltepakker for / Boltpackage for / Bultpaket för

Sign. _____

Vegge 520x600 Vindo bloms	Ant= 3	Navn	Artnr/dimensjon	Ant	Lev
		Vegge520x600 (1) Vindu blom	07-510-120	3	
		Brikkespesial(4)	04-060-041	12	
		Brikke(4)	04-060-040	12	
		Torx M8x25(4)	04-000-025	12	
Vegge 520x600 Vindo Bi	Ant= 3	Navn	Artnr/dimensjon	Ant	Lev
		Vegge520x600 (1) Vindu bi/ Sommerfulg	07-510-120	3	
		Brikkespesial(4)	04-060-041	12	
		Brikke(4)	04-060-040	12	
		Torx M8x25(4)	04-000-025	12	
Vegge 520x400 Sommerfugl / bie	Ant= 1	Navn	Artnr/dimensjon	Ant	Lev
		Vegge520x400 (1) Sommerfugl/bi	07-510-110	1	
		Brikkespesial(4)	04-060-041	4	
		Brikke(4)	04-060-040	4	
		Torx M8x25(4)	04-000-025	4	

Boltepakker for / Boltpackage for / Bultpaket för

Sign. _____.

Sete rund stolpe	Ant= 1	Navn	Artnr/dimensjon	Ant	Lev
		Sete rund stolpe	07-510-132	1	
		Vinkel 35x35x3(2) 11mm	04-070-036	2	
		Møbelknapp(2)	04-030-011	2	
		Brikke 501T(2)	04-060-040	2	
		Torx M8x12 (2) Torx M8x20 (2)	04-000-012 04-000-020	2 2	
		Skive M8 (2)	04-050-008	2	
Vegge 520x400 spor Sommerfugl/bie	Ant= 2	Navn	Artnr/dimensjon	Ant	Lev
		Vegge520x400(1) Sommerfugl /bie Med spor	07-510-112	2	
		Brikkespesial(4)	04-060-041	8	
		Brikke(4)	04-060-040	8	
		Torx M8x25(4)	04-000-025	8	









Boltepakker for / Boltpackage for / Bultpaket för



Sign. _____.

Sperrerør 520	Ant= 2	Navn	Artnr/dimensjon	Ant	Lev
		Sperrerør 520 (1)	07-510-160	2	
		Brikke 120_3T (2)	04-060-120	4	
		Torx M8x25 (4)	04-000-025	8	
Sperrerør 520 gulv	Ant= 18	Navn	Artnr/dimensjon	Ant	Lev
		Sperrerør 520 (1)	07-510-161	18	
		Brikke 90_2T (2)	04-060-090	0 På stolpe	
		Torx M8x25 (2)	04-000-025	36	
Sperrerør 520 gulv 4 hull 100	Ant= 2	Navn	Artnr/dimensjon	Ant	Lev
		Sperrerør 520 (1) For brua	07-510-162	2	
		Brikke 90_2T (2)	04-060-090	0 På stolpe	
		Torx M8x25 (2)	04-000-025	4	

Boltepakker for / Boltpackage for / Bultpaket för

Sign. _____.

Utsikt	Ant= 1	Navn	Artnr/dimensjon	Ant	Lev
		Utsikt med sperrerør (1)	07-510-134	1	
		Gulv til utsikt (4)	05-510-101	1	
		Torx M8x45 (4)	04-000-045	4	
		Sekskant M8x25	04-028-025	8	
		Møbelknapp M8x13x17	04-030-011	4	
		Brikke 120_3T	04-060-120	4	
		Plug Spor	00-400-980	2	

Kikkert	Ant= 1	Navn	Artnr/dimensjon	Ant	Lev
		Kikkert	35-100-615	1	
		Brikke 50_1T	04-060-050	2	
		Torx M8x25	04-000-025	2	













Boltepakker for / Boltpackage for / Bultpaket för

Sign. _____.

Skrå plato	Ant= 1	Navn	Artnr/dimensjon	Ant	Lev
		Venstre vegg Skrå plato	07-510-321	1	
		Gulv Skrå plato	07-510-323	1	
		Høyre vegg Skrå plato	07-510-322	1	
		Vinkel 35x35x35x3 11mm hull	04-070-036	2	
		Møbelknapp M8x13x17	04-030-011	2	
		Torx M8x12 Torx M8x25	04-000-012 04-000-025	2 14	
		Låsse Mutter M8	04-040-008	2	
		Skive M8	04-050-008	4	
		Brikke 50_1T	04-060-050	12	











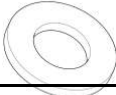

Boltepakker for / Boltpackage for / Bultpaket för

Sign. _____

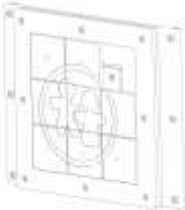
Trappe 550 01-290-090	Ant= 1	Navn	Artnr/dimensjon	Ant	Lev
		Rutsjebane	01-290-090	1	
		Brikke90 3T(5)	04-060-090	2	
		Torx M8x35(4)	04-000-035	10	
		Fundamentskive(2) 2H 80	00-003-106	2	
		Skive M8(2)	04-050-008	6	
		Mutter M8(2)	04-040-008	6	
		Stålforankring(2) L=230	00-100-312	2	
Vegge 520x600 Uten vindo med hull	Ant= 1	Navn	Artnr/dimensjon	Ant	Lev
		Vegge520x600 (1) Uten vindo	07-510-120	1	
		Brikkespesial(4)	04-060-041	4	
		Brikke(4)	04-060-040	4	
		Torx M8x25(4)	04-000-025	4	











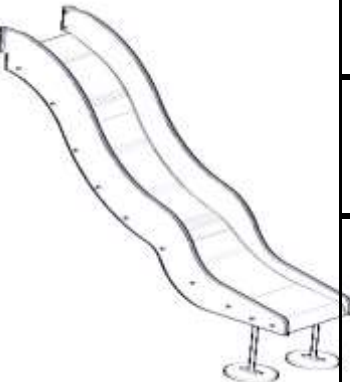



Boltepakker for / Boltpackage for / Bultpaket för

Sign. _____

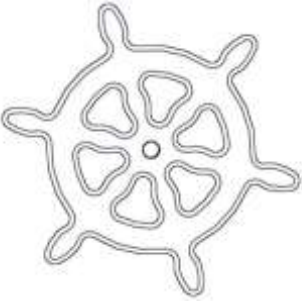
Krabbeplate HDPE	Ant= 1	Navn	Artnr/dimensjon	Ant	Lev
		Krabbeplate på rør (1)	07-510-135	1	
		Brikke 150-2T	04-060-151	2	
		Torx M8x25 (4) Torx M8x35(4)	04-000-025 04-000-035	4 4	
		Skive M8	04-050-008	4	
		Låsemutter M8	04-040-008	4	
		Fundament plate	00-003-106	2	
Søve Slide	Ant= 1	Navn	Artnr/dimensjon	Ant	Lev
		Søve Slide	25-100-020	1	
		Brikke 50_1T (6)	04-060-050	6	
		Torx M8x30 (6)	04-000-030	6	
		Skive M8	04-050-008	6	
Produktmerke	Ant= 1	Navn	Artnr/dimensjon	Ant	Lev
		Produktmerking Hos Søve	25-200-180	1	











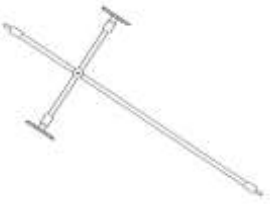

Boltepakker for / Boltpackage for / Bultpaket för

Sign. _____

Rutsjebane 950 07-510-310	Ant= 1	Navn	Artnr/dimensjon	Ant	Lev
		Rutsjebane	07-510-310	1	
		Brikke120 3T(5)	04-060-120	2	
		Torx M8x35(4)	04-000-035	4	
		Torx M8x45(2)	04-000-045	2	
		Torzx M8x30(4)	04-000-030	4	
		Fundamentskive(2) 2H 80	00-003-106	2	
		Skive M8(2)	04-050-008	4	
		Mutter M8(2)	04-040-008	6	
	Stålforankring(2) L=230	00-100-312	2		
Styr Skute	Ant= 1	Navn	Artnr/dimensjon	Ant	Lev
		Skute styr	02-500-078	1	
		BilStyr Hylse	02-500-005	1	
		Torx M8x50	04-000-050	1	
		Skive M8	04-055-008	1	
		Møbelknapp(1)	04-030-011	1	











Boltepakker for / Boltpackage for / Bultpaket för

Sign. _____

PolyTreppe 550 07-510-177	Ant= 1	Navn	Artnr/dimensjon	Ant	Lev
		StigTrinn 550 (1) INKL beslag	07-510-177	1	
		Saddelwasher 38mm (1)	04-210-010	1	
		Brikke 120_3T (2)	04-060-120	2	
		Torx M8x20 (2)	04-000-020	4	
		Møbelknapp (1)	04-030-011	1	
		Fundamentskive	00-003-103	1	
		Skive M8	04-050-008	1	
		Låsemutter M8	04-040-008	1	
Håndtak dobbel	Ant= 4	Navn	Artnr/dimensjon	Ant	Lev
		Håndtak dobbel (1)	00-400-172	4	
		Brikke 50_1T (3)	04-060-050	12	
		Torx M8x30 (3)	04-000-030	12	











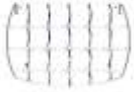

Boltepakker for / Boltpackage for / Bultpaket för

Sign. _____.

Nettbro rett tett 07-510-178	Ant= 1	Navn	Artnr/dimensjon	Ant	Lev
		Nett (1) INKL. beslag	07-510-178	1	
		Rør bue(2)	07-510-164	2	
		Brikke120 3T(8)	04-060-120	8	
		Torx M8x25(16)	04-000-025	16	
		Saddelwasher 38mm (32)	04-210-010	32	
		Møbelknapp (12)	04-030-025	16	
Megafon	Ant= 1	Navn	Artnr/dimensjon	Ant	Lev
		Megafon	35-100-620	1	
		Brikke 50_1T	04-060-050	2	
		Torx M8x25	04-000-025	2	

Boltepakker for / Boltpackage for / Bultpaket för

Sign. _____

Tak	Ant= 2	Navn	Artnr/dimensjon	Ant	Lev
		Tak mini (2)	07-510-105	4	
		Gavelplate(2)	07-510-106	4	
		Vinkel 35x35x3(2) 11mm	04-070-036	4	
		Møbelknapp	04-030-011	8	
		Torx M8x12(4)	04-000-012	8	
		Skive M8 (4)	04-050-008	8	
Buttikkdisk	Ant= 1	Navn	Artnr/dimensjon	Ant	Lev
		Buttikkdiskk	07-510-130	1	
		Vinkel 50x50x4(2) 11mm	04-070-050	2	
		Møbelknapp(2)	04-030-011	2	
		Brikke 501T(2)	04-060-040	2	
		Torx M8x12 (2) Torx M8x20 (2)	04-000-012 04-000-020	2 2	
		Skive M8 (2)	04-050-008	2	

Fundamentering med betong / Foundation concrete / Förankring med betong

(N)	Støtsand		(N)	(UK)	(S)
(UK)	Safer surface		Bakkenivå	Ground level	Marknivå
(S)	Stridsan				↓ Ref NS-EN 177
(N)	Komprimert masse.	betong			
(UK)	Compressed mass.	concrete			
(S)	Komprimerad massa.	betong			

Fundamentering uten betong / Foundation without concrete / Förankring utan betong

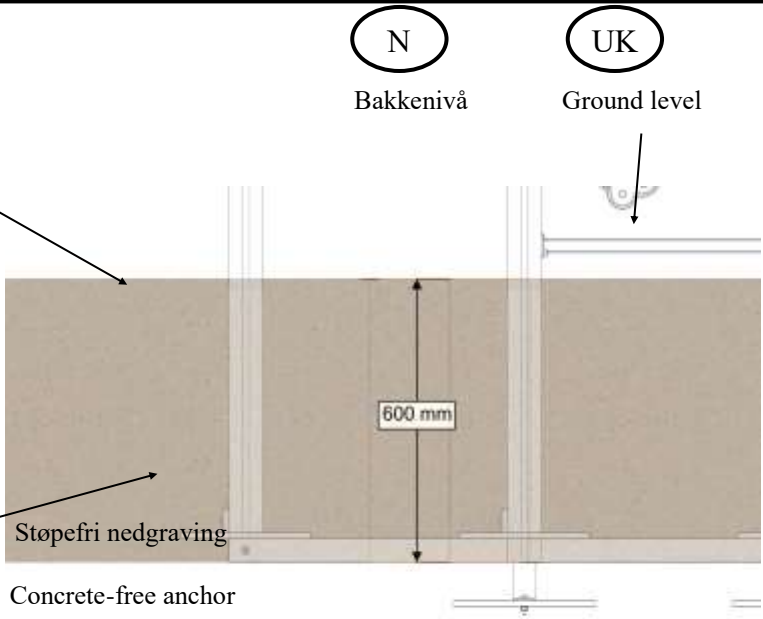
(N)	Støtsand		(N)	(UK)	(S)
(UK)	Safer surface		Bakkenivå	Ground level	Marknivå
(S)	Stridsan				↓ Ref NS-EN 1177
(N)	Komprimert masse	Støpefri nedgraving			
(UK)	Compressed mass	Concrete-free anchor			
(S)	Komprimerad massa	Nedgrävningfundament			

(N)	Alle mål er oppgitt i millimeter
(UK)	Scale measured in mm
(S)	Alla mått är i millimeter.

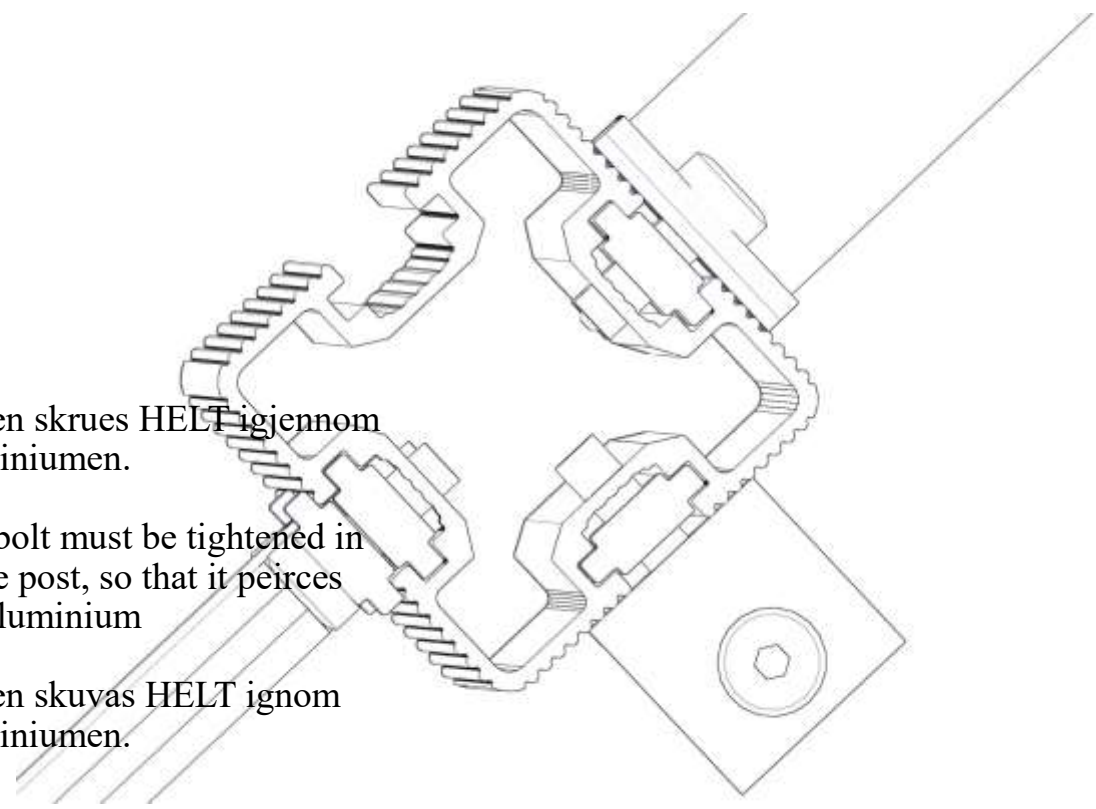
<p data-bbox="124 1556 220 1624">N</p> <p data-bbox="124 1691 220 1758">UK</p> <p data-bbox="124 1848 220 1915">S</p>	 <p data-bbox="239 1579 702 1668">Bolten skrues HELT igjennom aluminiumen.</p> <p data-bbox="239 1691 686 1825">The bolt must be tightened in to the post, so that it peirces the aluminium</p> <p data-bbox="239 1848 662 1937">Bulten skuyas HELT ignom aluminiumen.</p>

Fallhøyder / Free height of fall / Fallhöjder

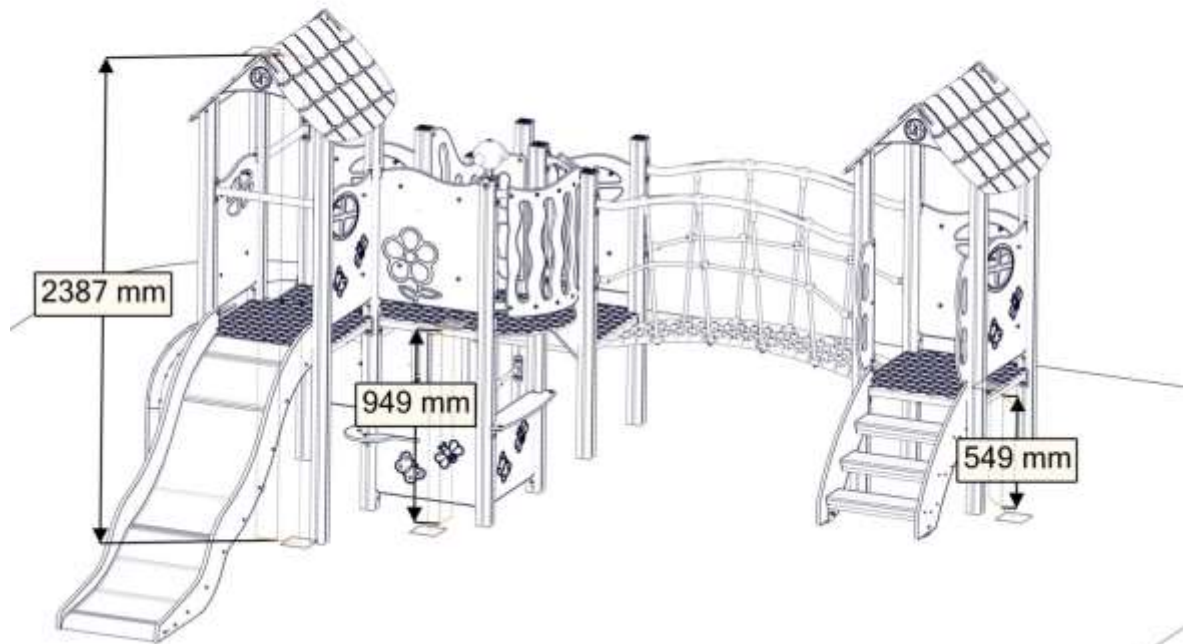

Sikkerhetszone / Safety zone / Säkerhetszon

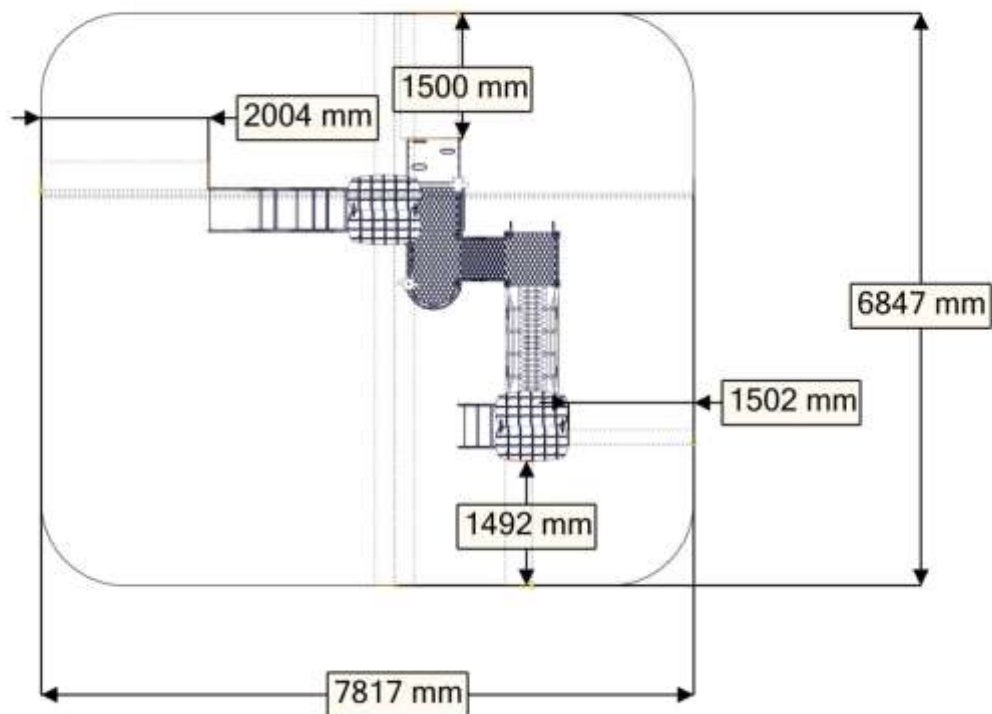

Plassering av forankringer / Ground plan / Placering av förankringar

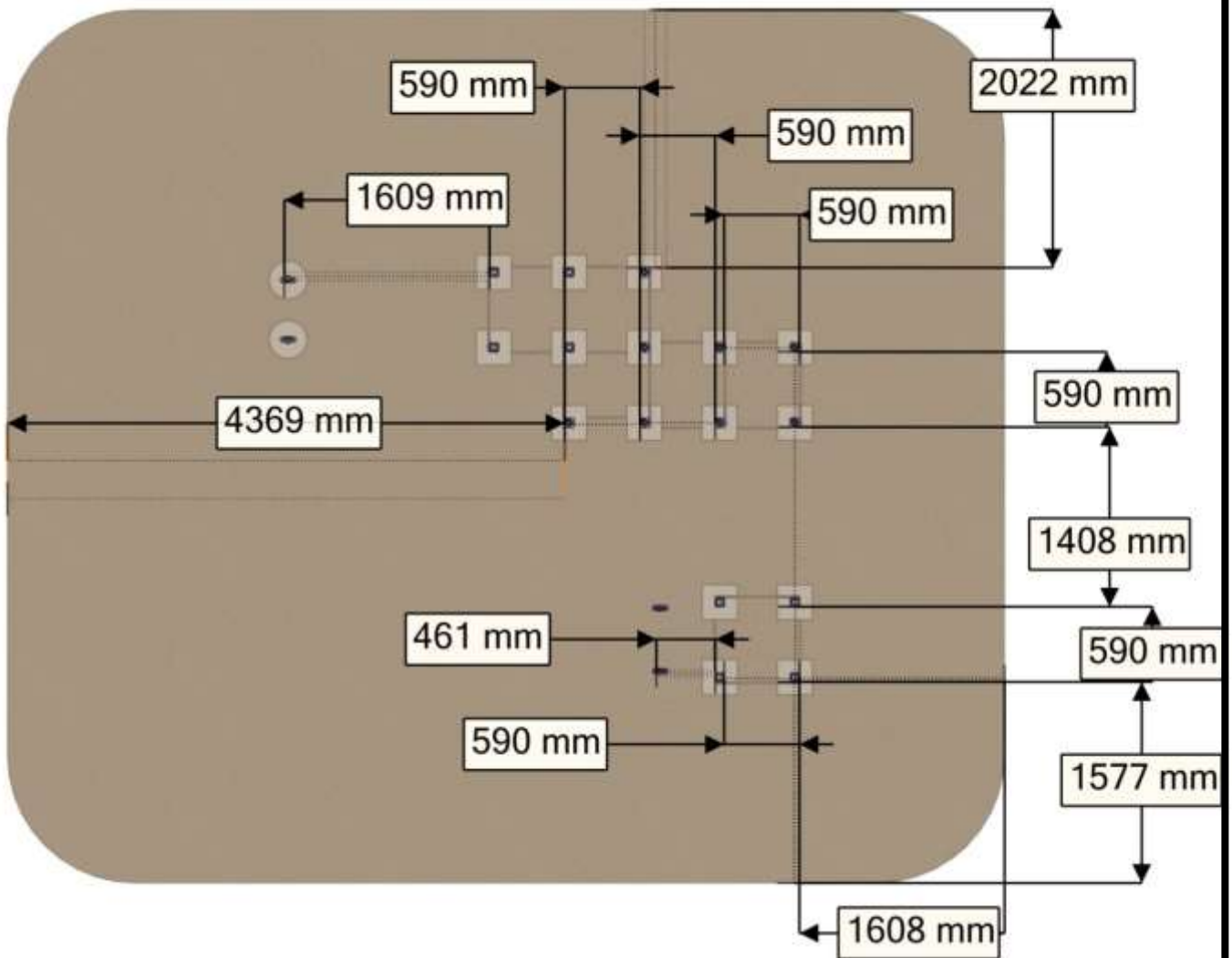

N

Alle mål er oppgitt i millimeter

UK

Scale measured in mm

S

Alla mått är i millimeter.

Montering av lekeapparatet / Assembly instructions / Montering av lekredskapet

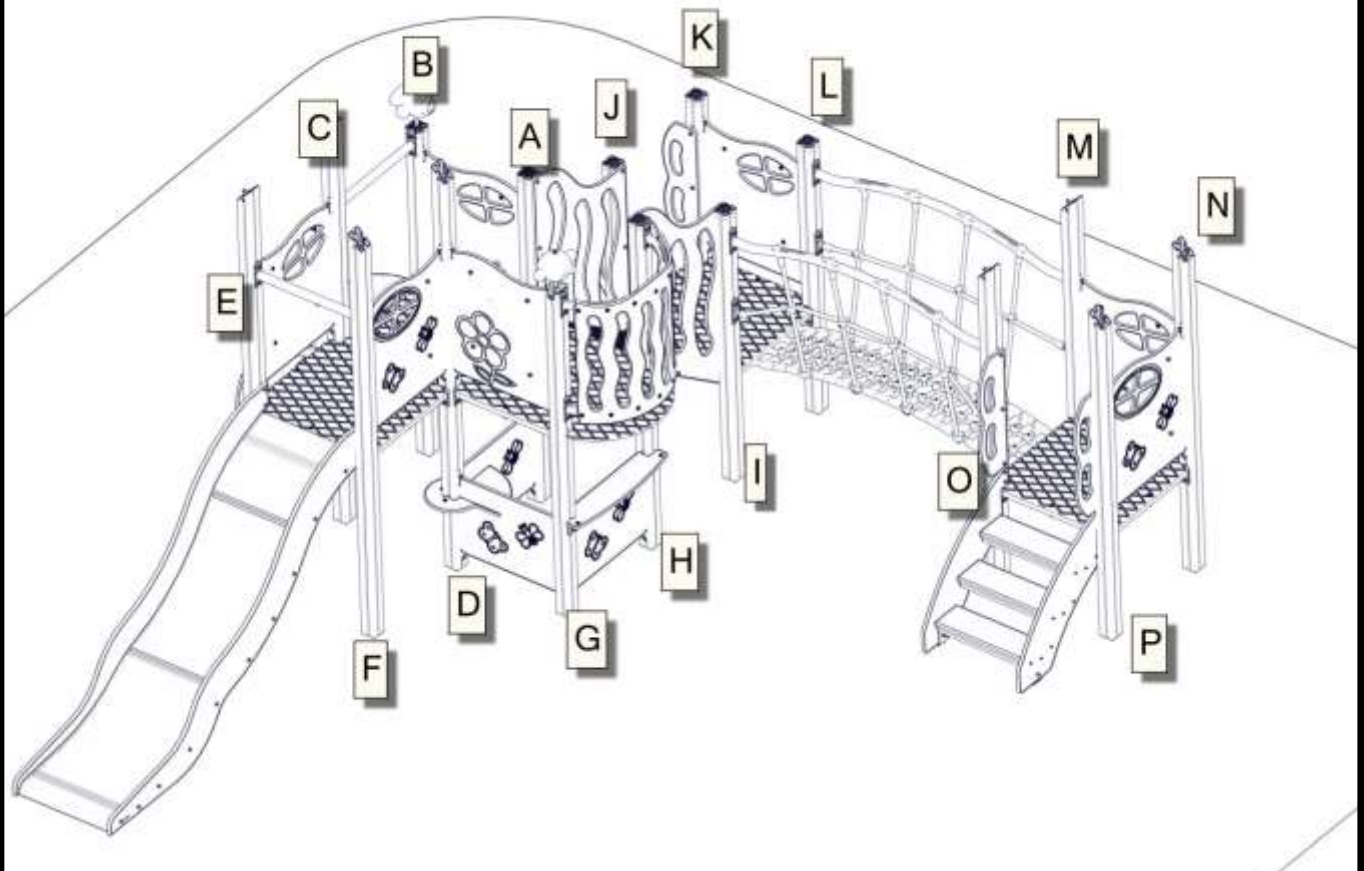

Brikke påmontert hos Søve

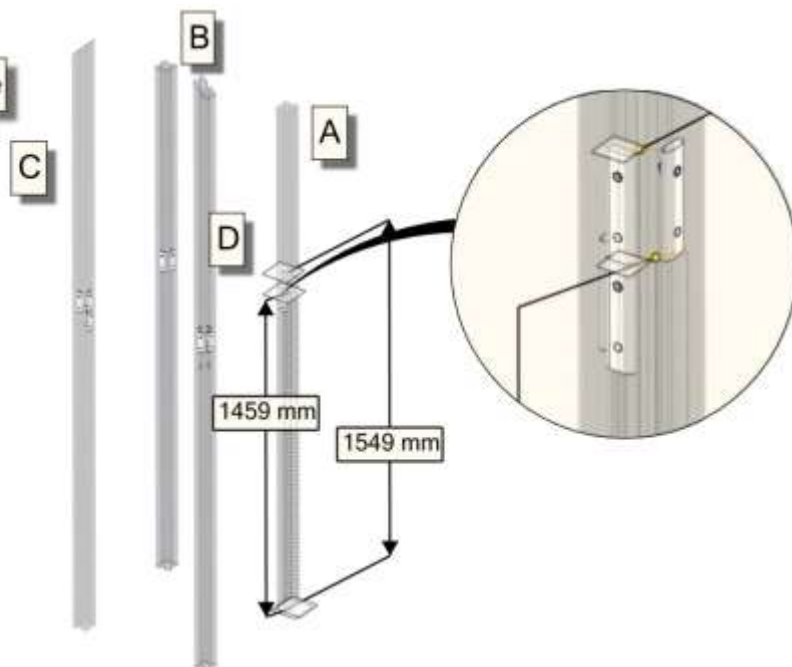

BOM ID	Name	SW Configuration	Artnr (config)	Qty
1	VK70_SFA5123_miniserie-1	1700-600	07-510-150	2
2	VK70_SFA5123_miniSkra-1	2100-600	07-510-158	2

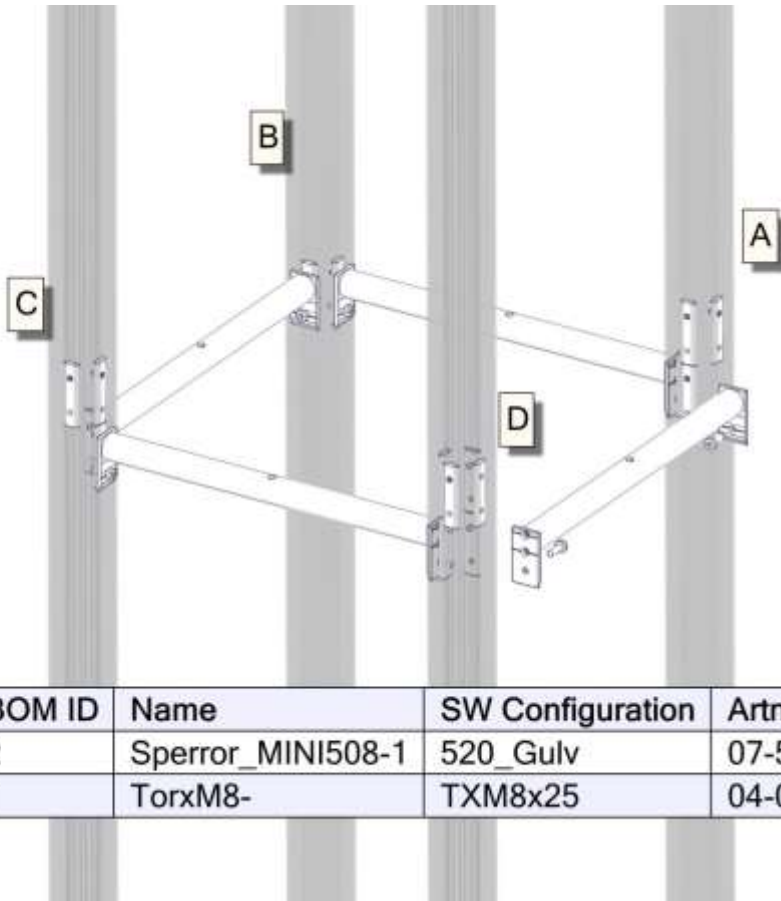

BOM ID	Name	SW Configuration	Artnr (config)	Qty
2	Sperror_MINI508-1	520_Gulv	07-510-161	4
1	Torxm8-	TXM8x25	04-000-025	8

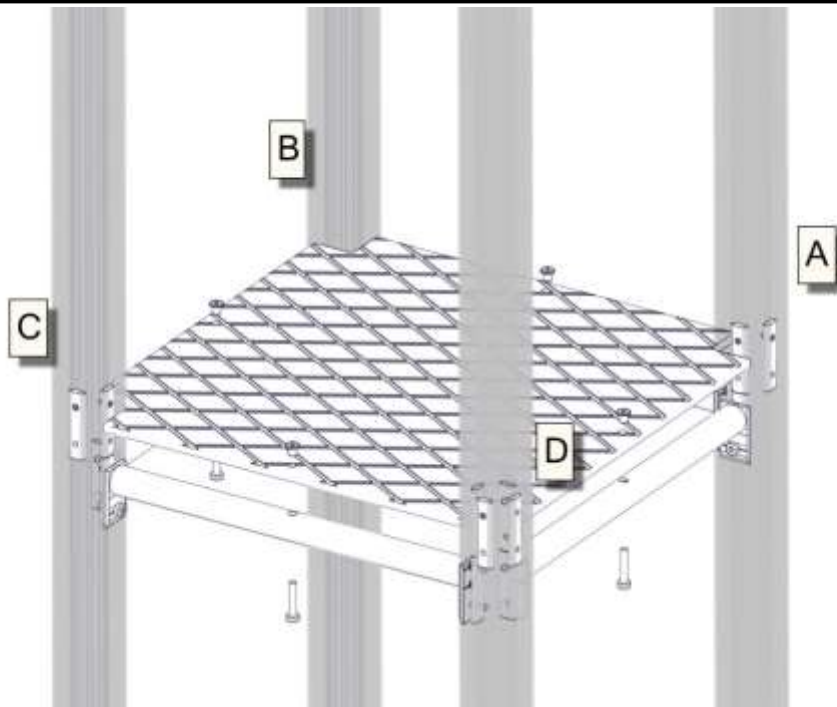

BOM ID	Name	SW Configuration	Artnr (config)	Qty
3	gulvmini-5	Default	07-510-102	1
2	Mobelknapp-1	M8_13_17	04-030-011	4
1	Torxm8-1	TXM8x45	04-000-045	4

Brikke påmontert hos Søve

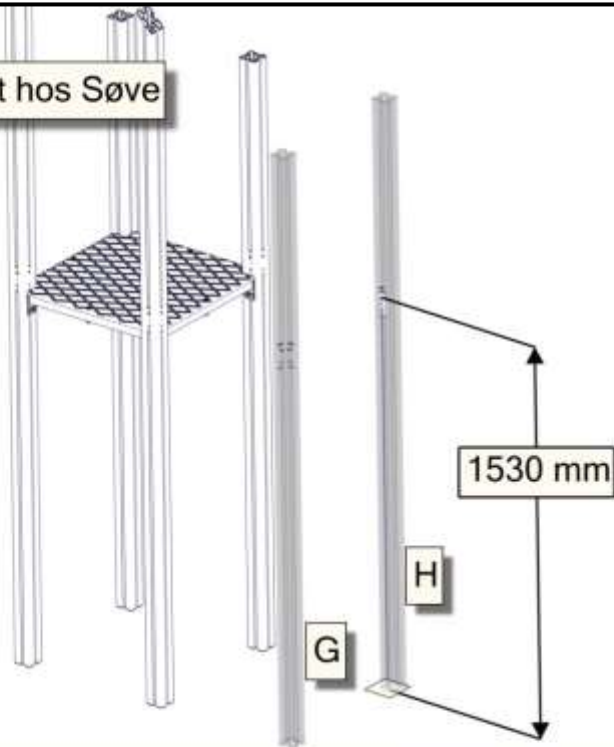

BOM ID	Name	SW Configuration	Artnr (config)	Qty
1	VK70_SFA5123_miniserie-1	1700-600	07-510-150	2

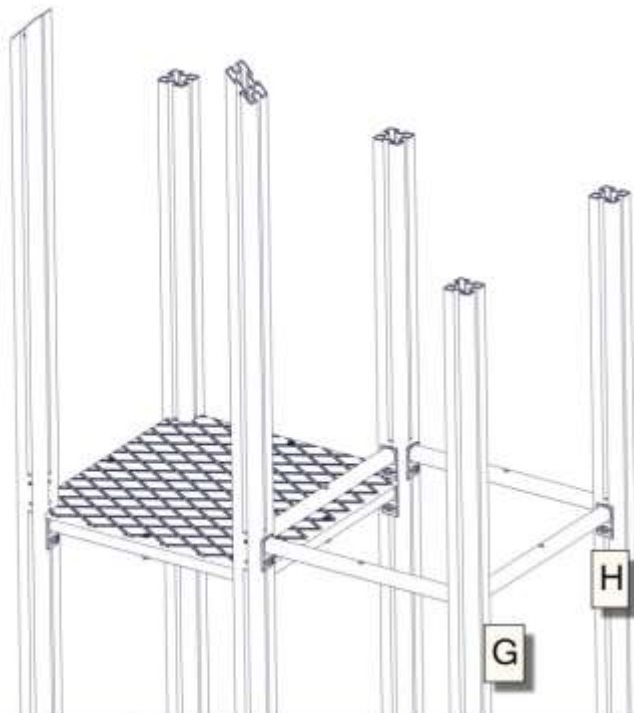

BOM ID	Name	SW Configuration	Artnr (config)	Qty
2	Sperror_MINI508-1	520_Gulv	07-510-161	4
1	Torxm8-	TXM8x25	04-000-025	8

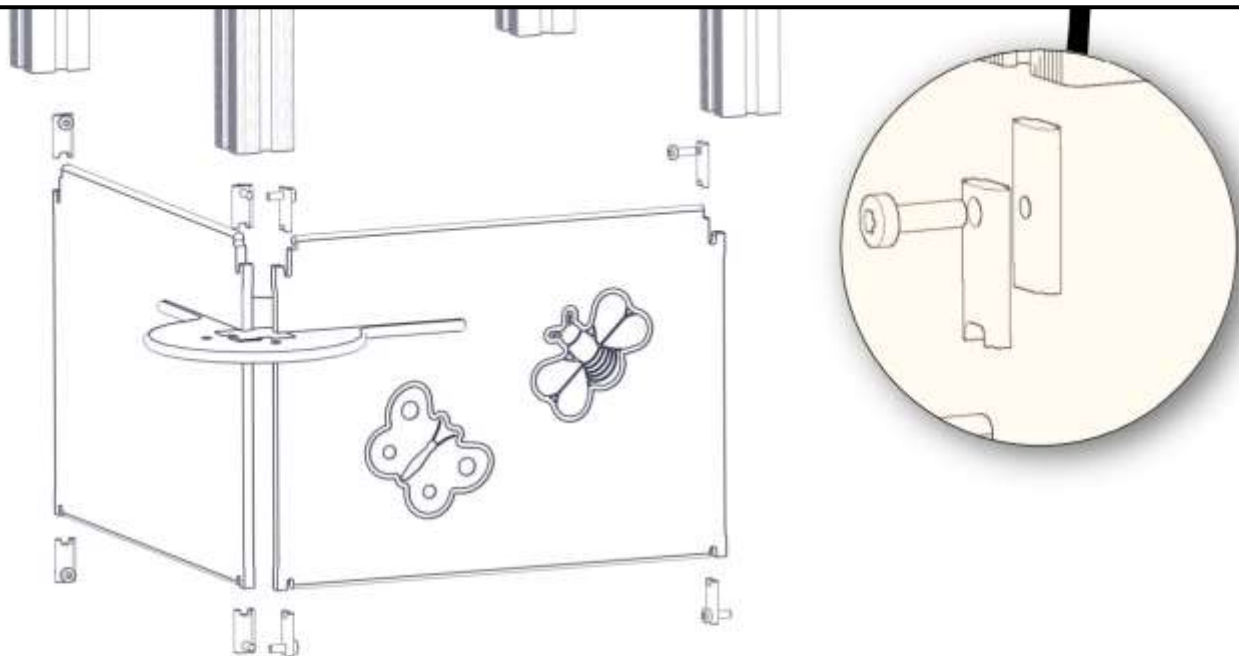
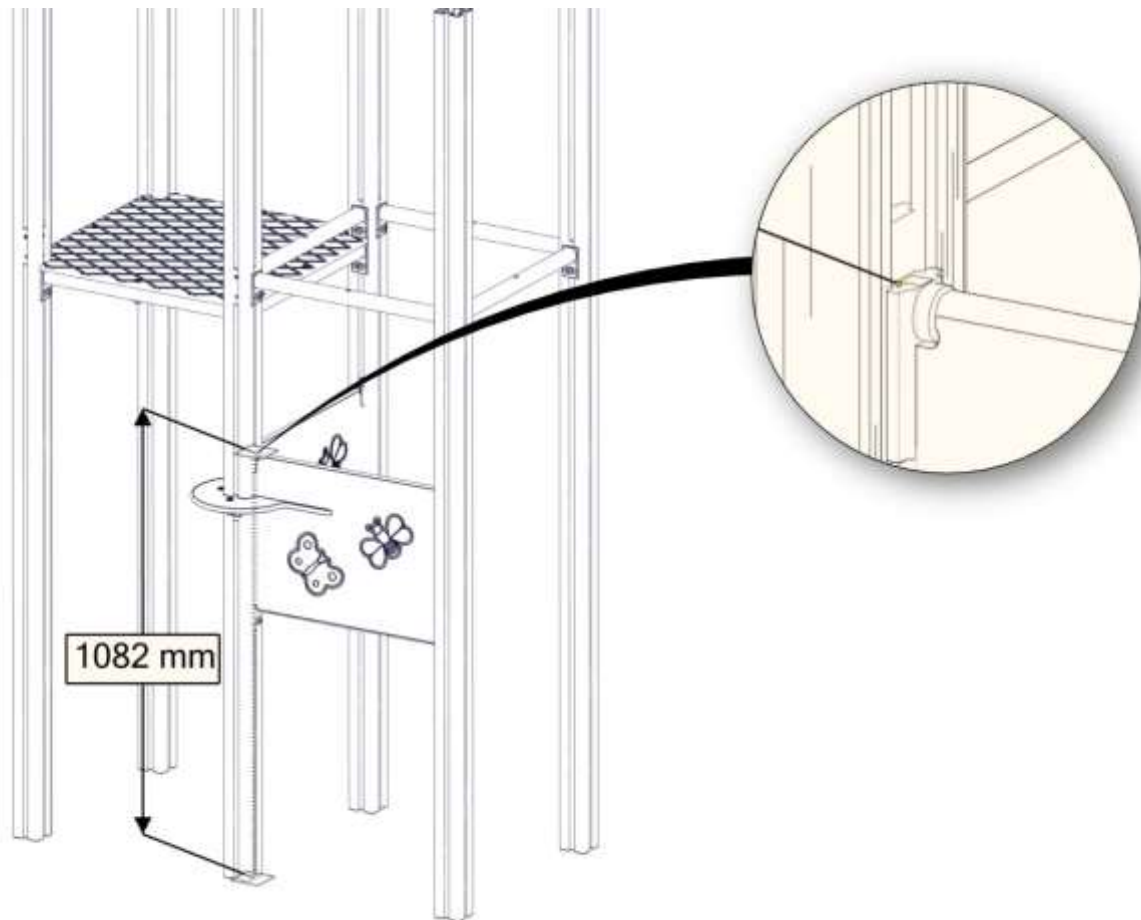

BOM ID	Name	SW Configuration	Artnr (config)	Qty
2	brikke_SFA5116Special-1	12mm	04-060-051	8
4	VeggMini520x400-1	Med_Spor	07-510-112	2
5	SeteRundStolpe-1	Stor	07-510-132	1
1	TorxM8-1	TXM8x25	04-000-025	8

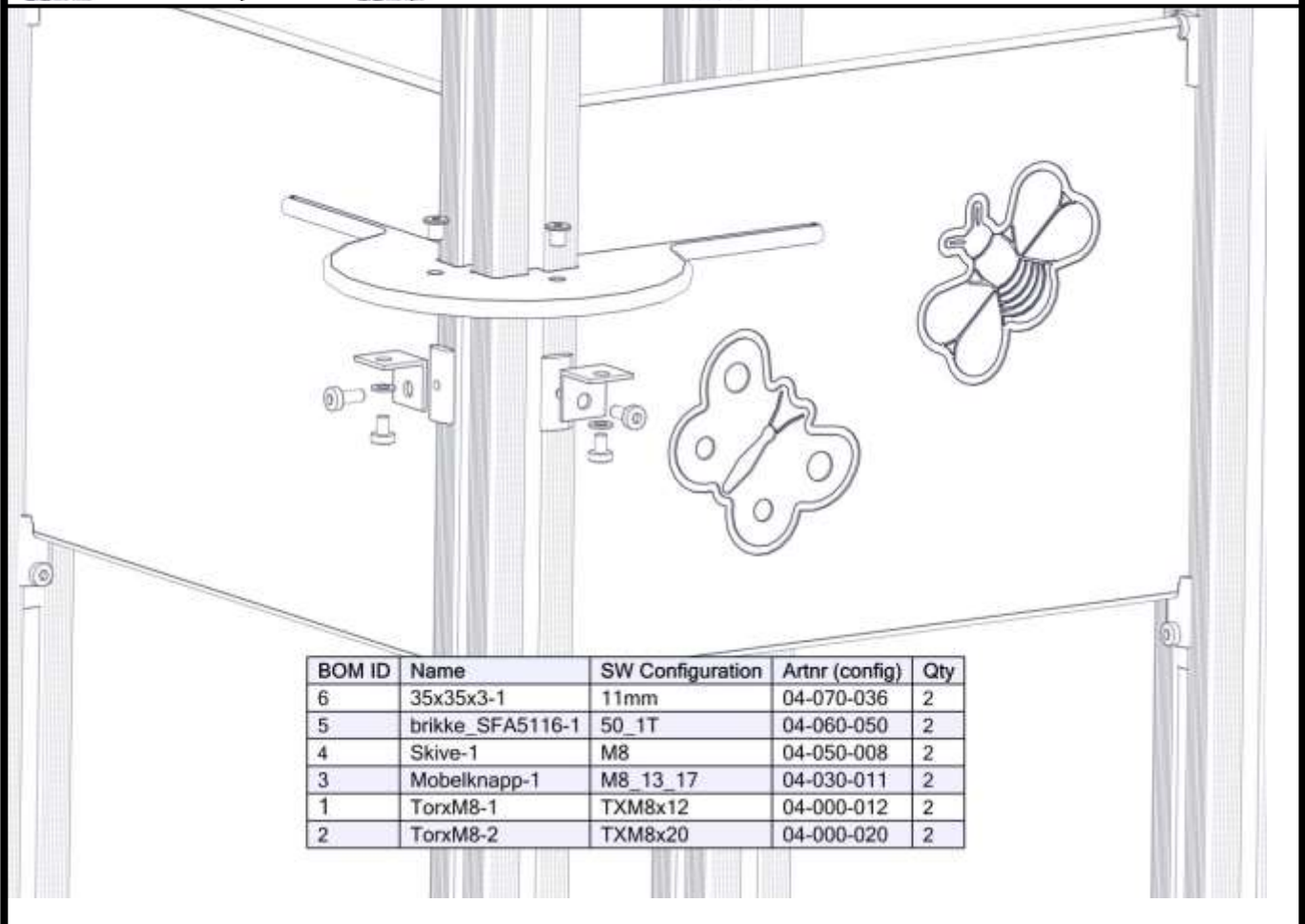
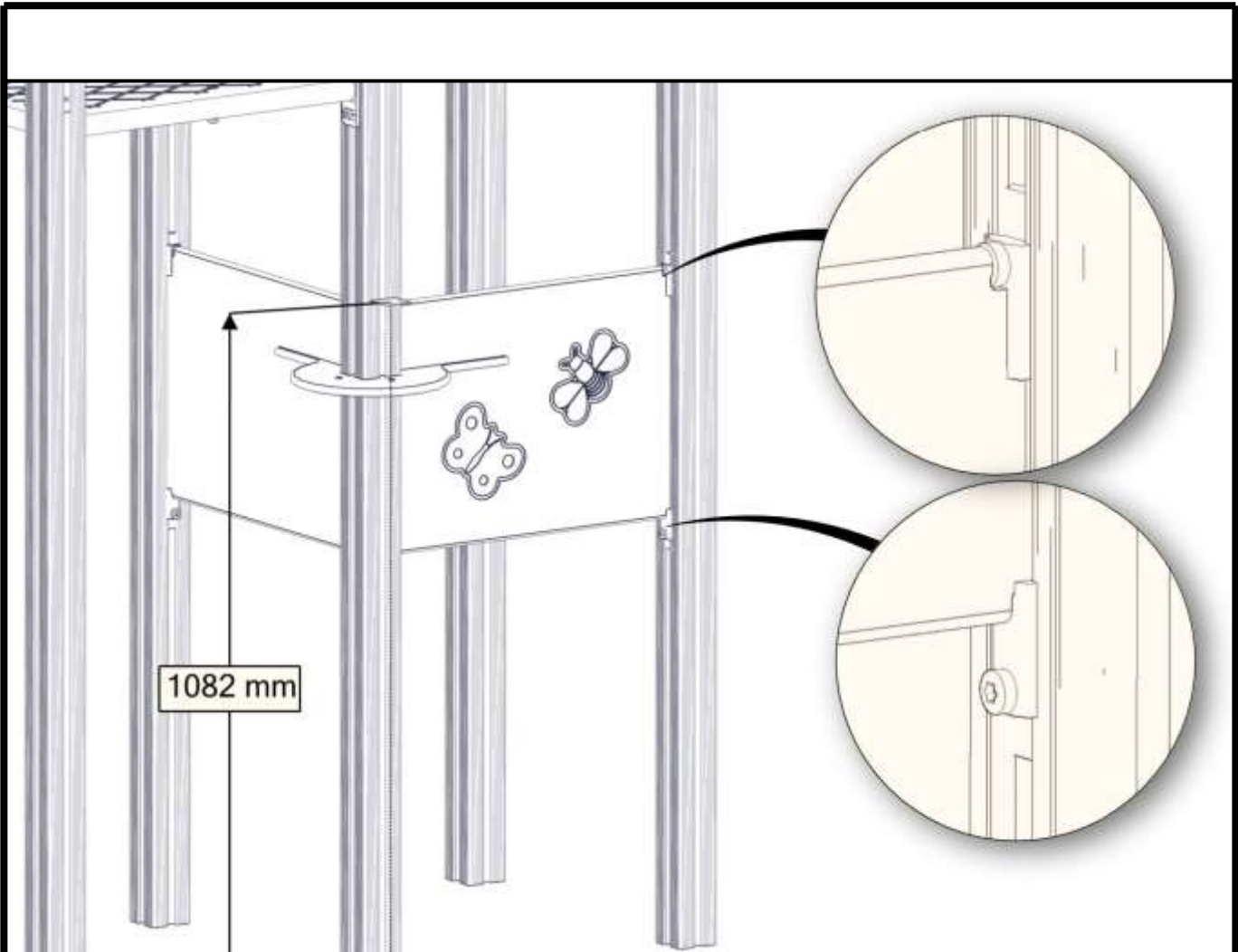

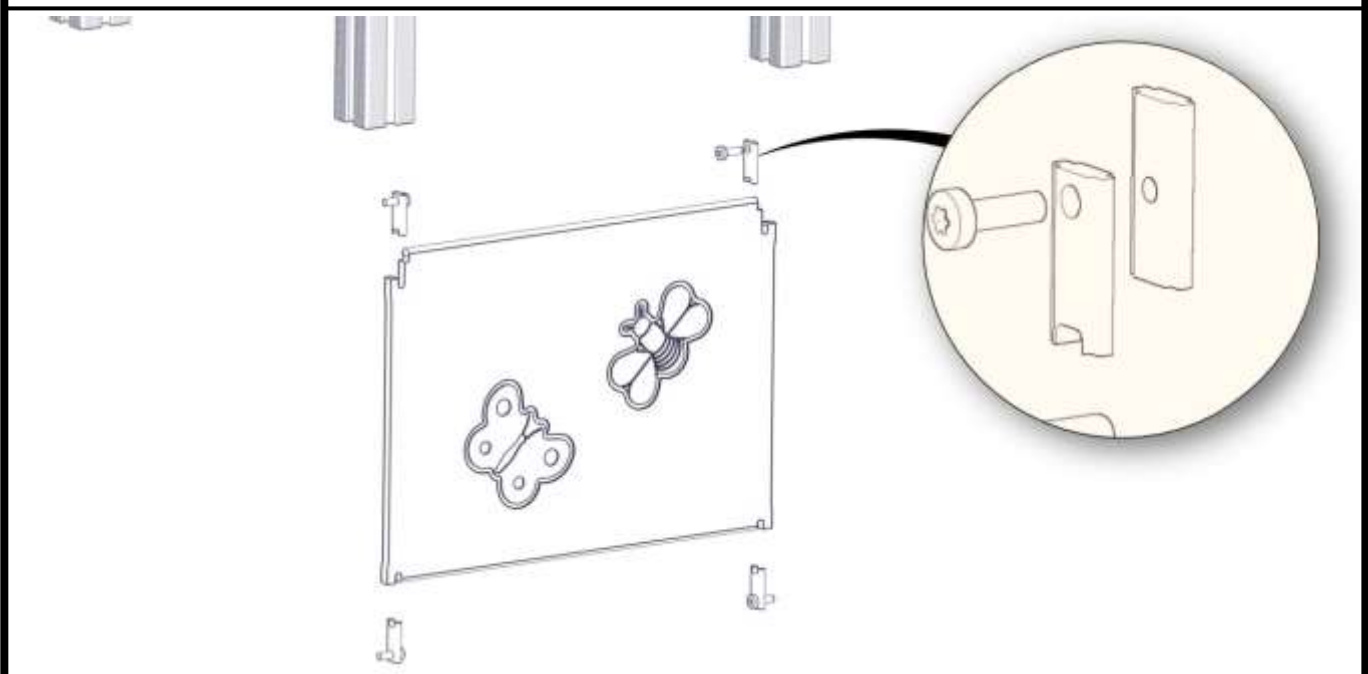
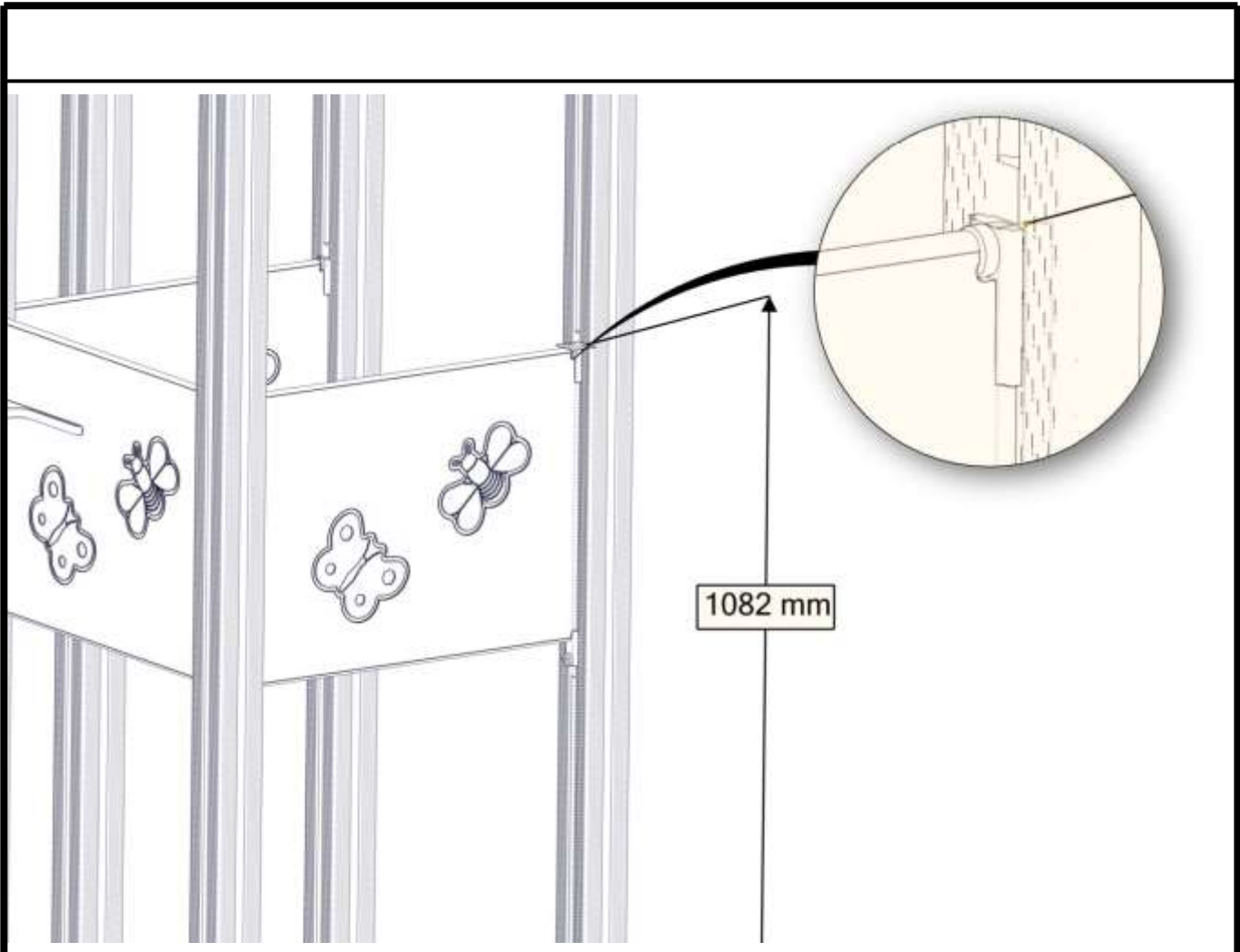

BOM ID	Name	SW Configuration	Arnr (config)	Qty
2	brikke_SFA5116Special-1	12mm	04-060-051	4
4	VeggMini520x400-1	STD	07-510-110	1
1	TorxM8-1	TXM8x25	04-000-025	4

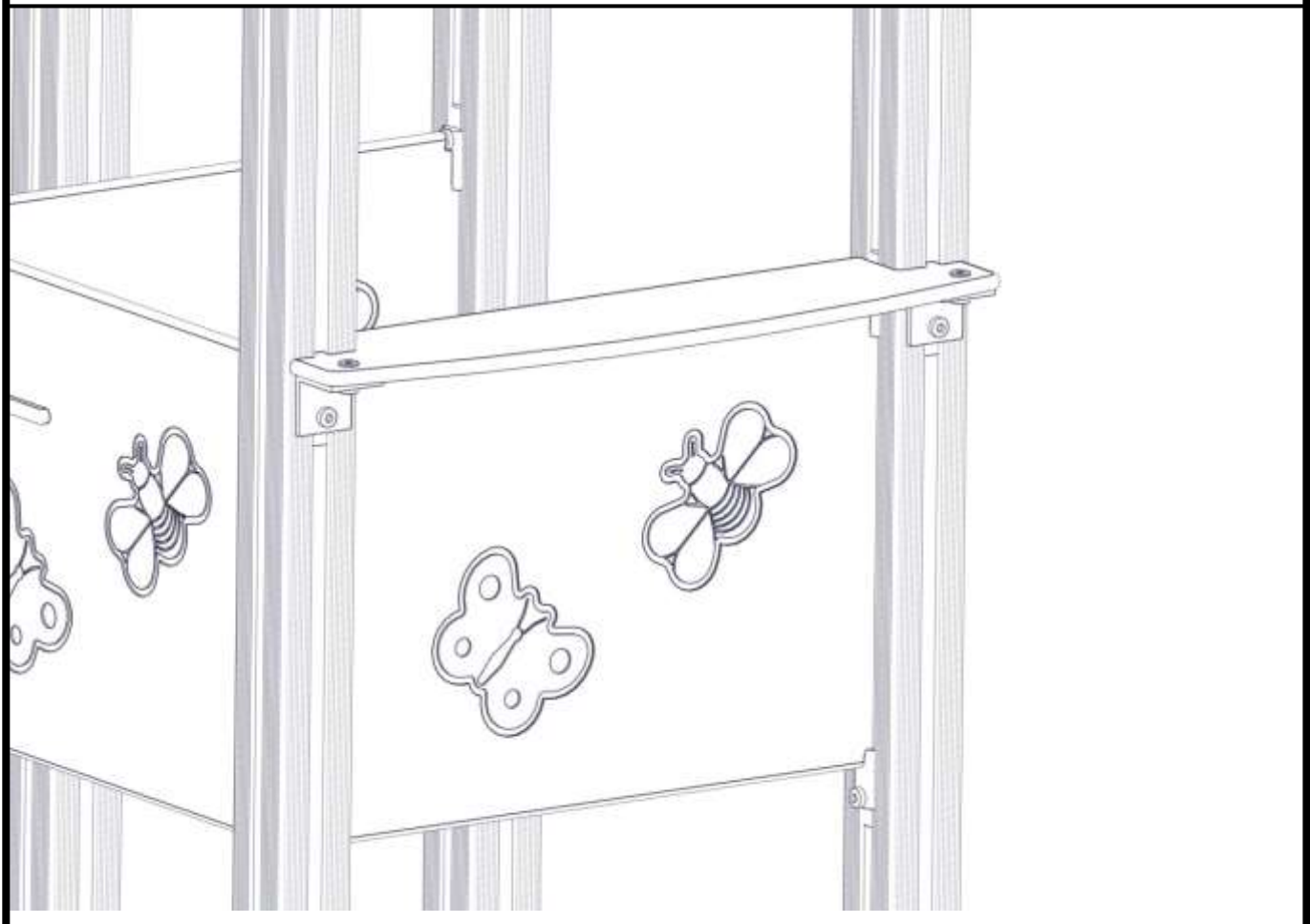
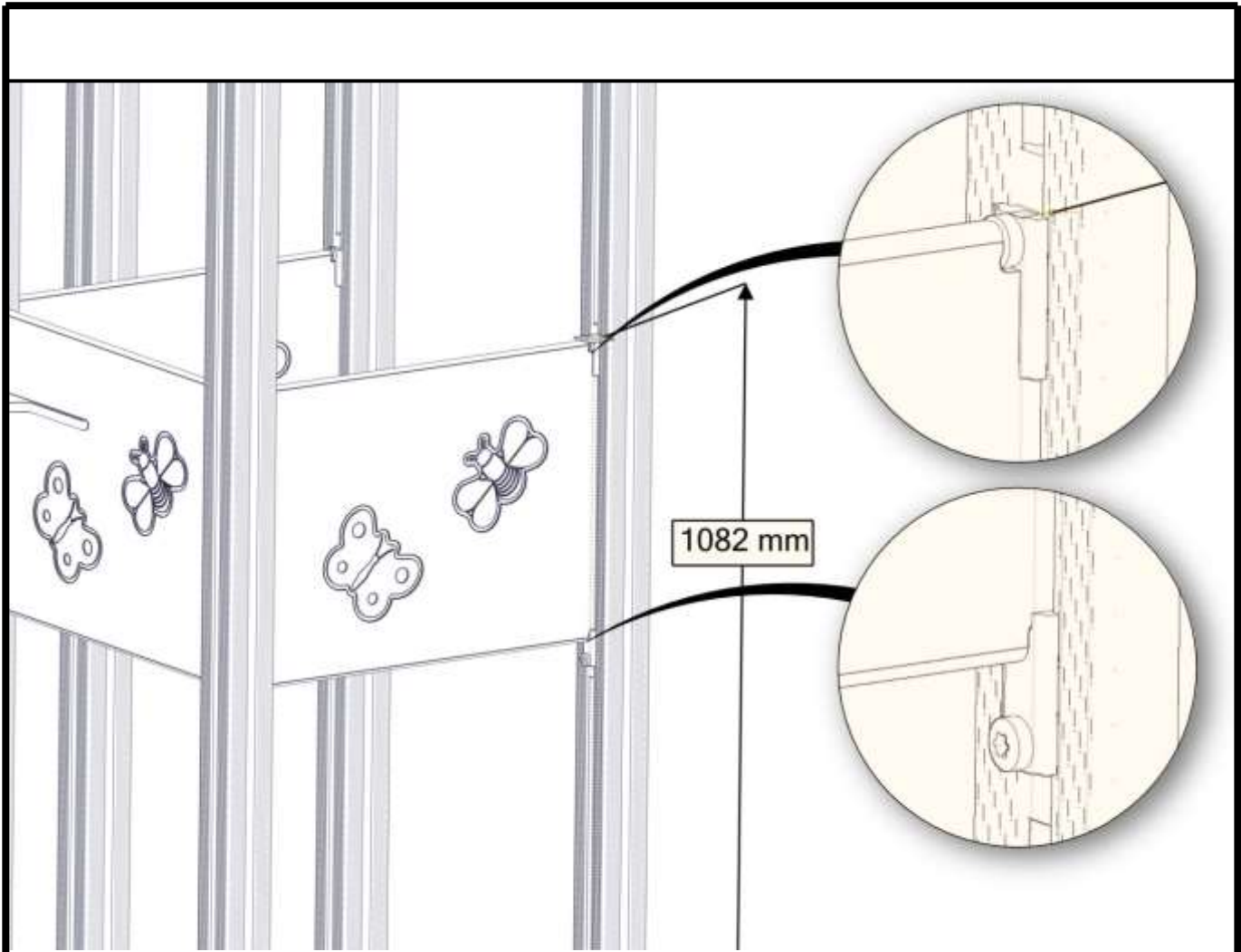

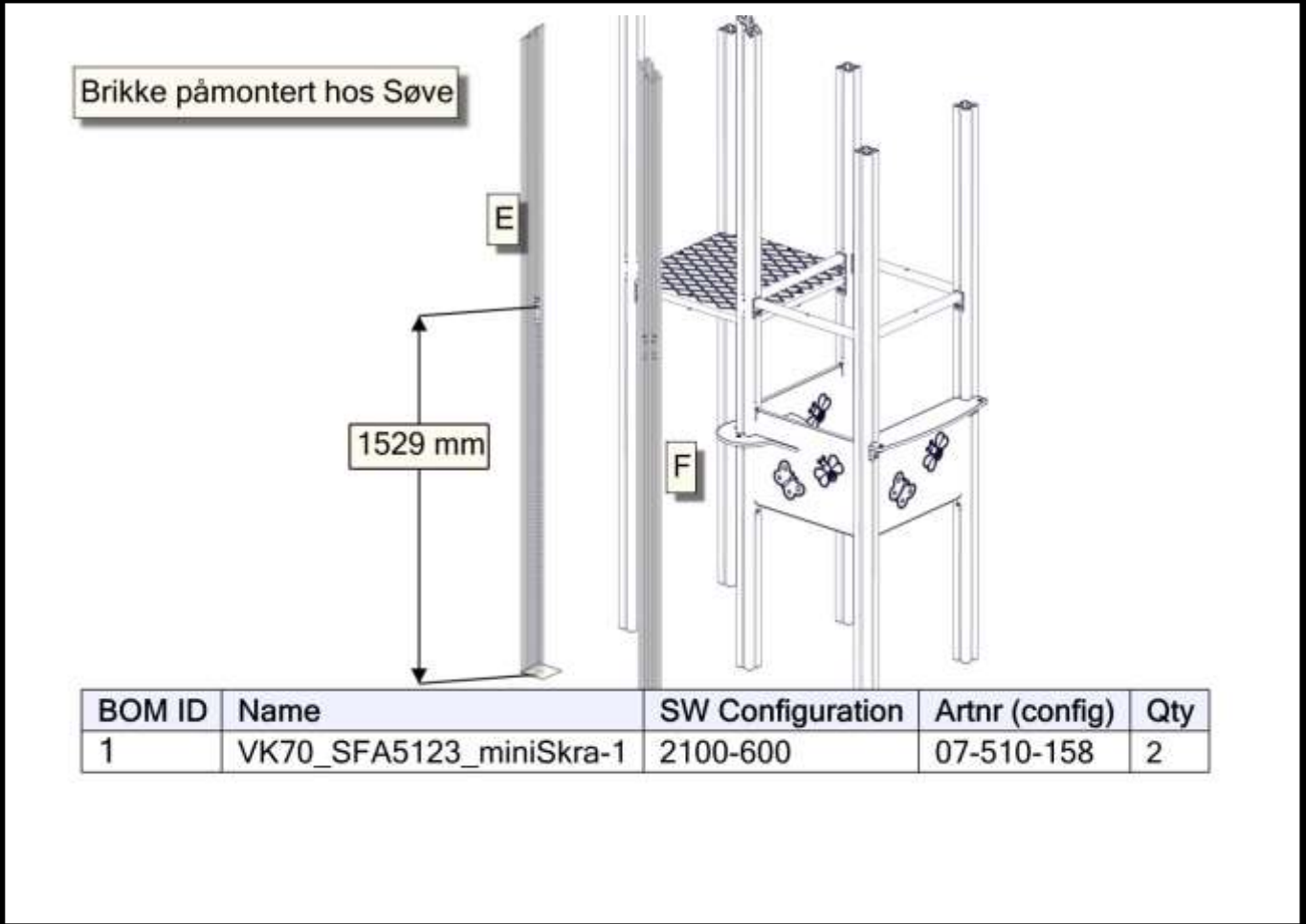
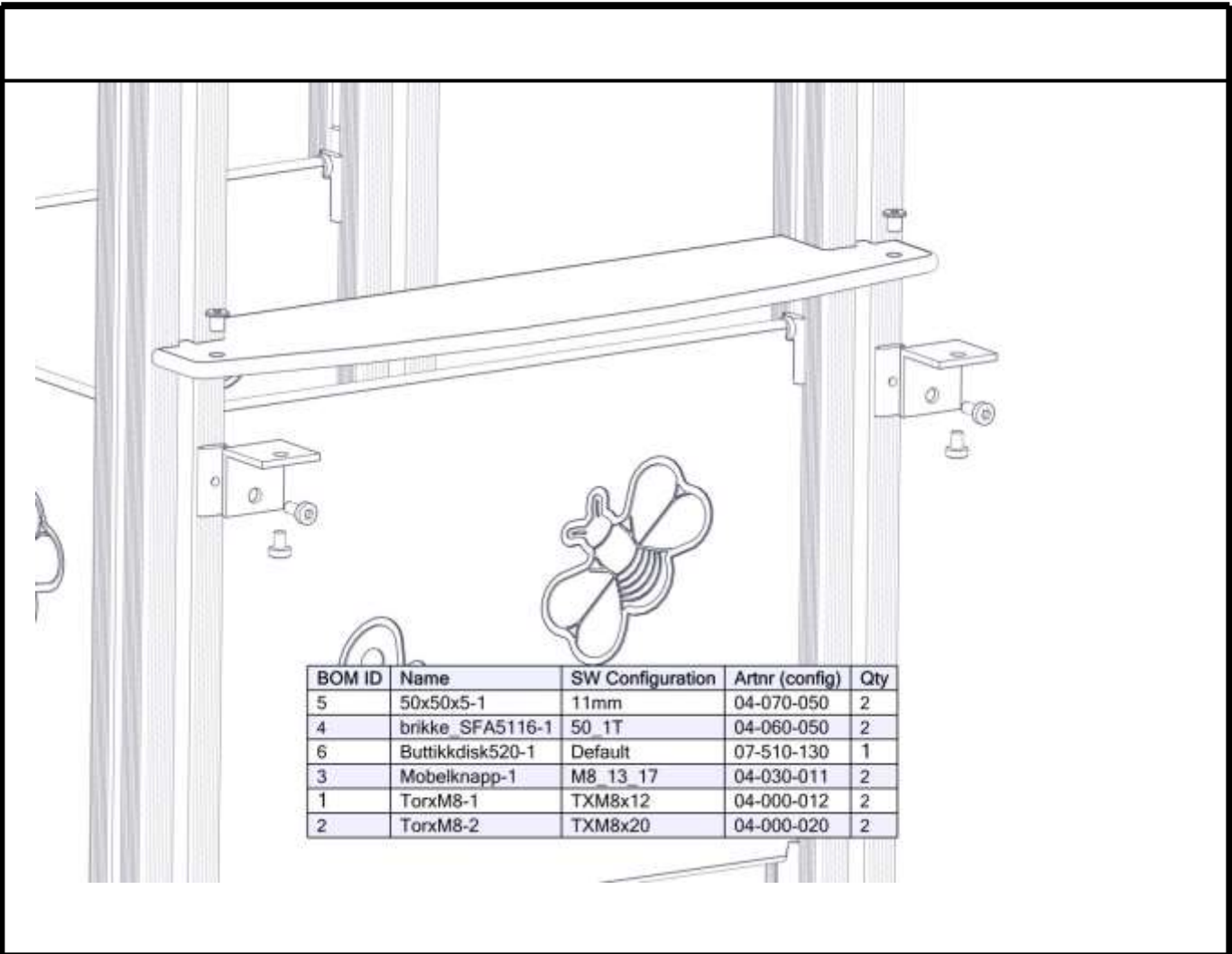

Brikke påmontert hos Søve

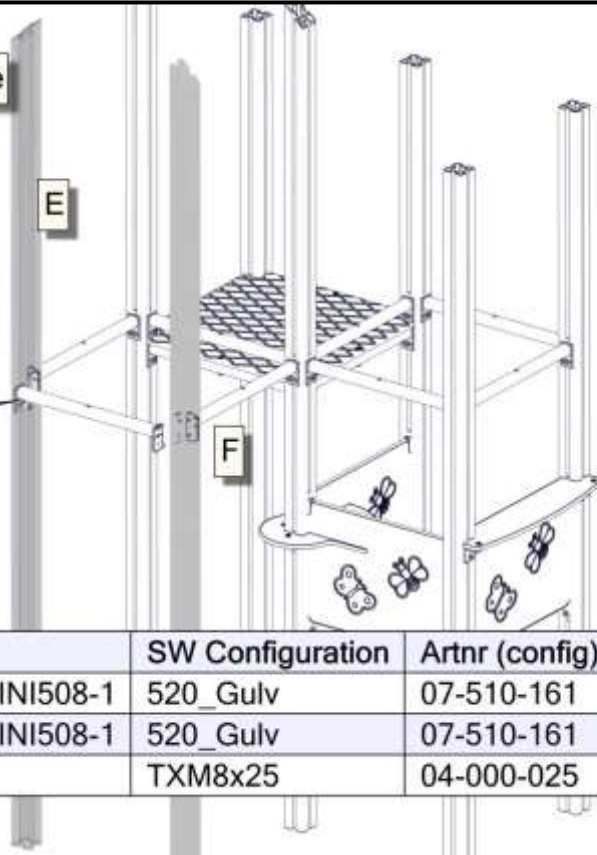

BOM ID	Name	SW Configuration	Artnr (config)	Qty
2	Sperror_MINI508-1	520_Gulv	07-510-161	3
3	Sperror_MINI508-1	520_Gulv	07-510-161	1
1	TorxM8-	TXM8x25	04-000-025	8

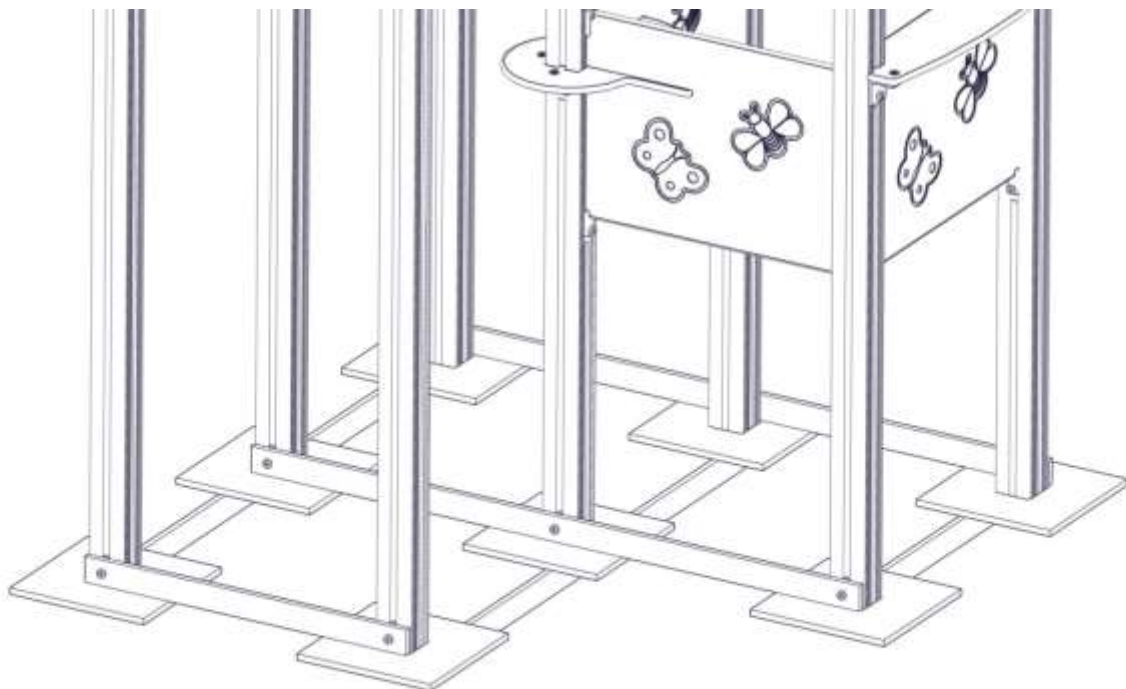

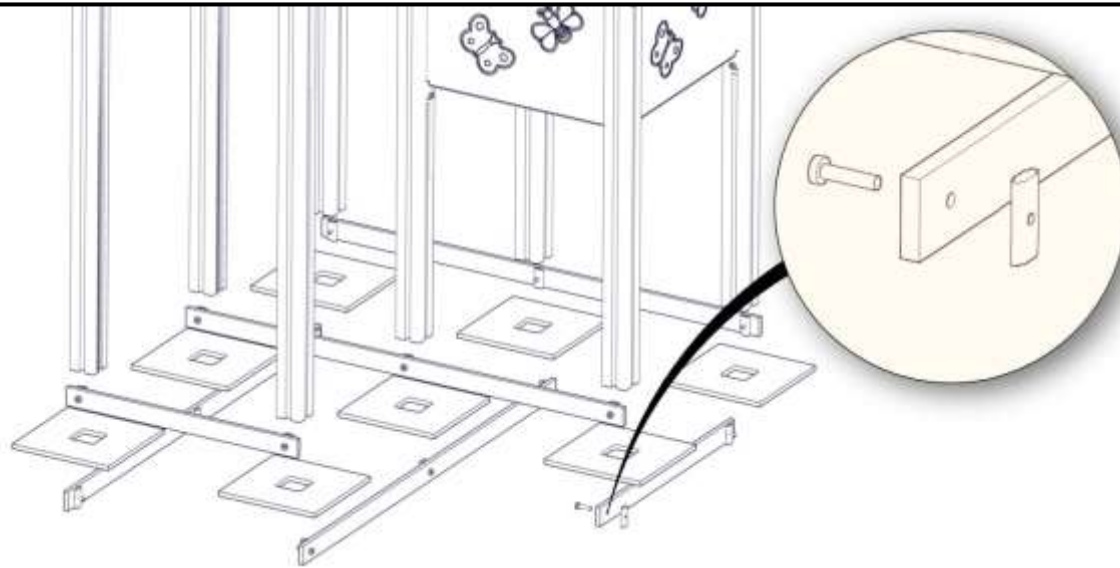

BOM ID	Name	SW Configuration	Artnr (config)	Qty
2	brikke_SFA5116-	50_1T	04-060-050	16
3	minifun_sprosse-1	660	07-510-200	2
5	minifun_sprosse-1	1250	07-510-202	4
4	minifunSkive-	Default	07-510-201	8
1	TorxM8-	TXM8x35	04-000-035	16

Brikke påmontert hos Søve

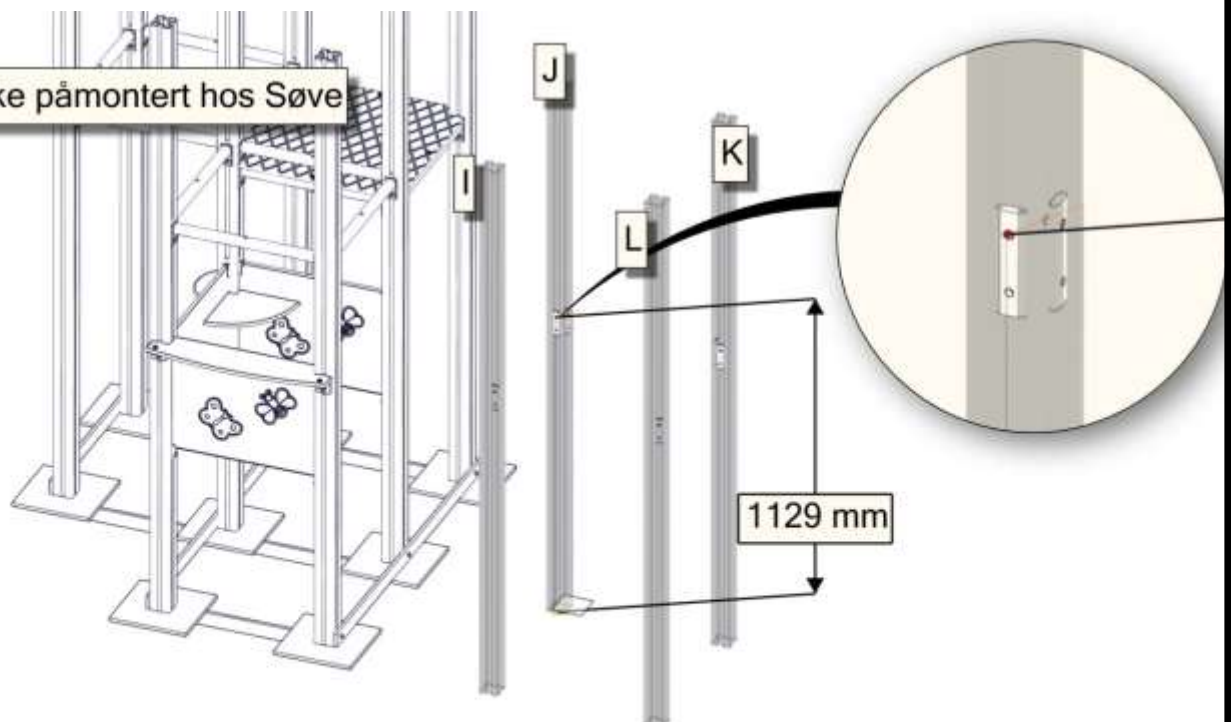

BOM ID	Name	SW Configuration	Artnr (config)	Qty
1	VK70_SFA5123_miniserie-1	1400-600	07-510-157	4

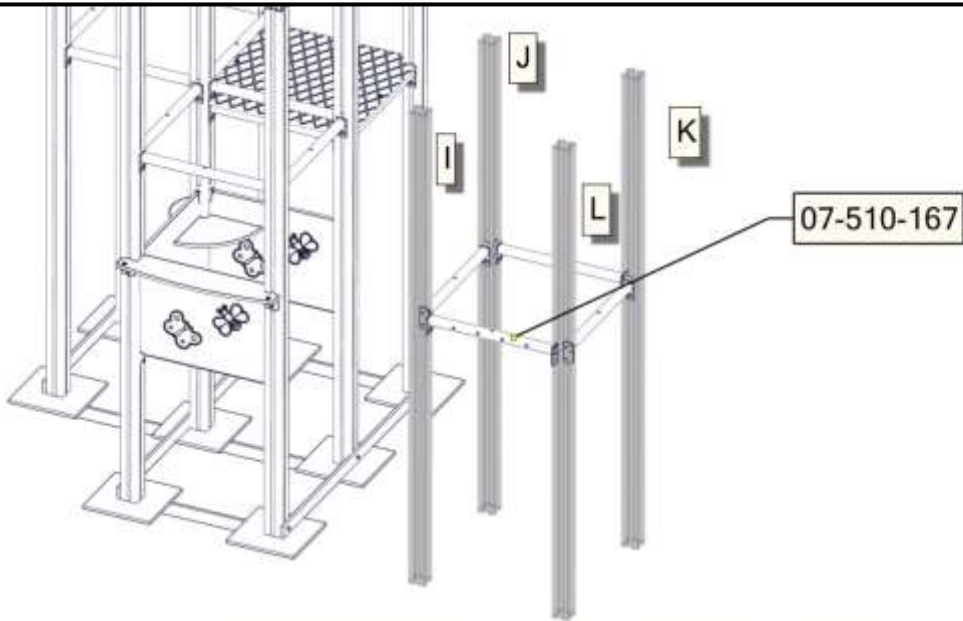

BOM ID	Name	SW Configuration	Artnr (config)	Qty
3	Sperror_MINI508-1		07-510-16	2
2	Sperror_MINI508-1	520_Gulv	07-510-161	2
1	Torxm8-	TXM8x25	04-000-025	6

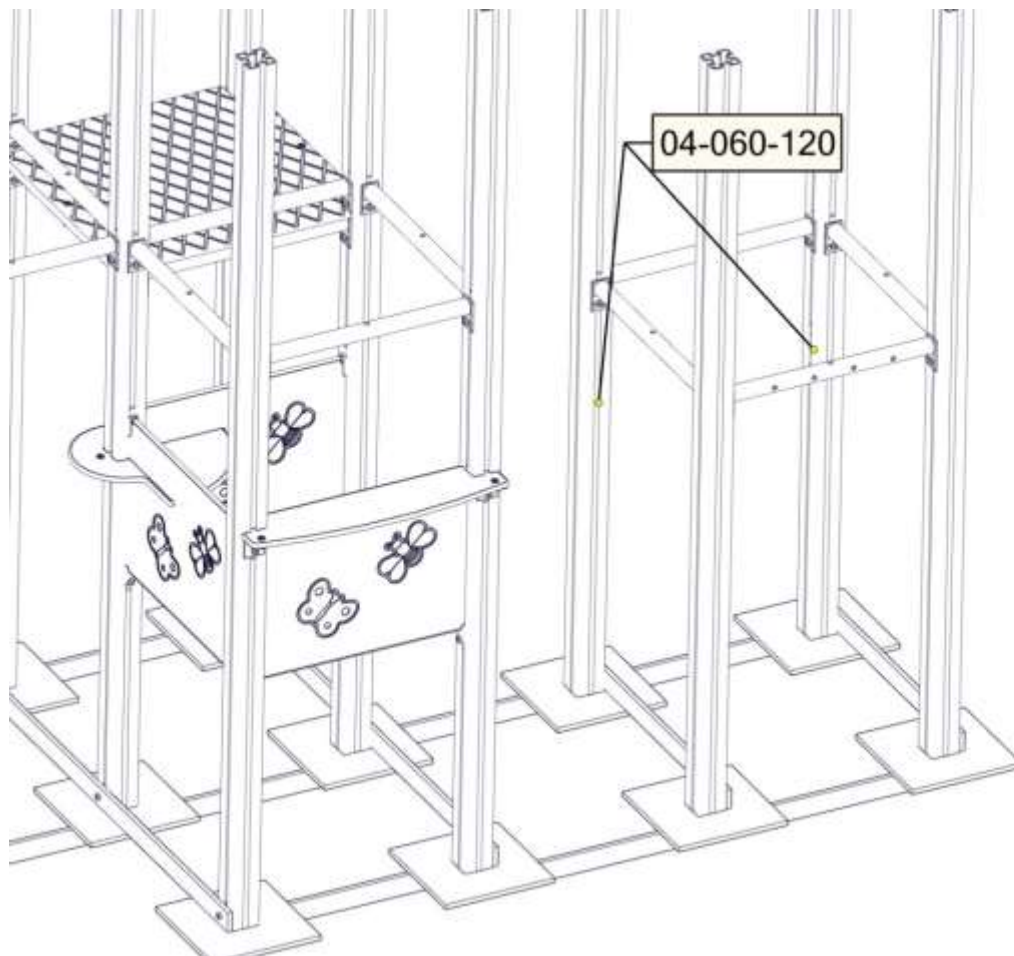

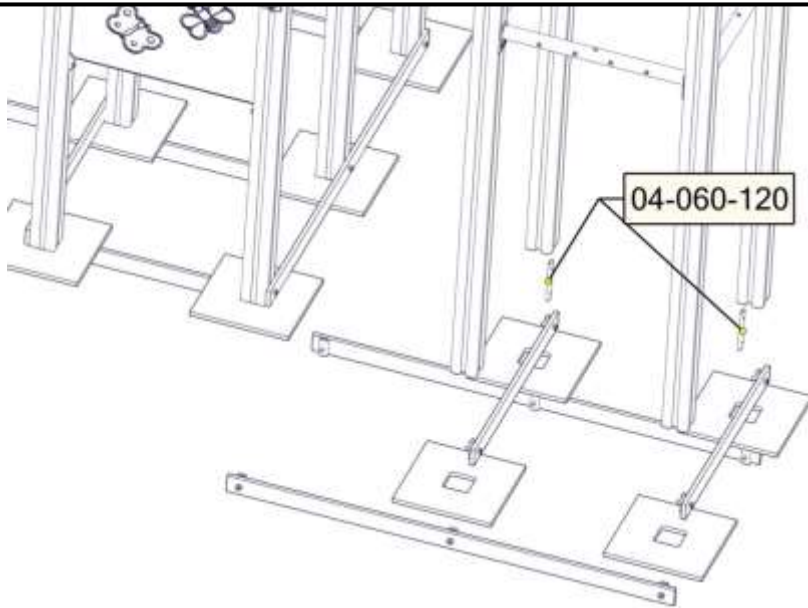

BOM ID	Name	SW Configuration	Artnr (config)	Qty
2	brikke_SFA5116-	50_1T	04-060-050	10
6	brikke_SFA5116-	120_3T	04-060-120	2
3	minifun_sprosse-1	660	07-510-200	2
5	minifun_sprosse-1	1250	07-510-202	2
4	minifunSkive-1	Default	07-510-201	4
1	TorxM8-	TXM8x35	04-000-035	10

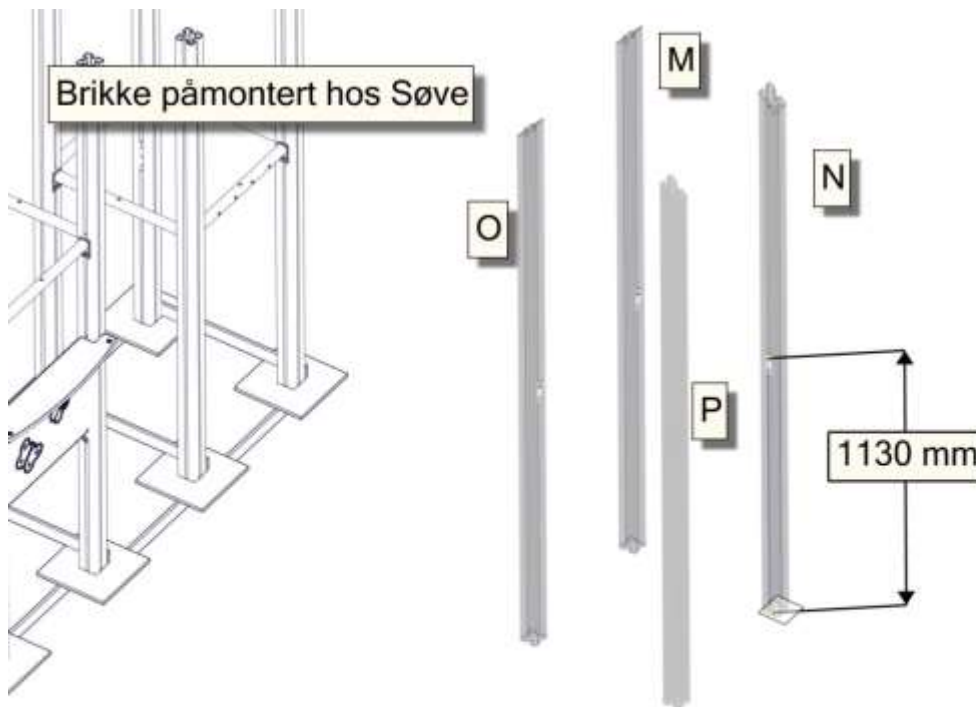

BOM ID	Name	SW Configuration	Artnr (config)	Qty
1	VK70_SFA5123_miniSkra-1	1700-600	07-510-156	4

Brikke påmontert hos Søve

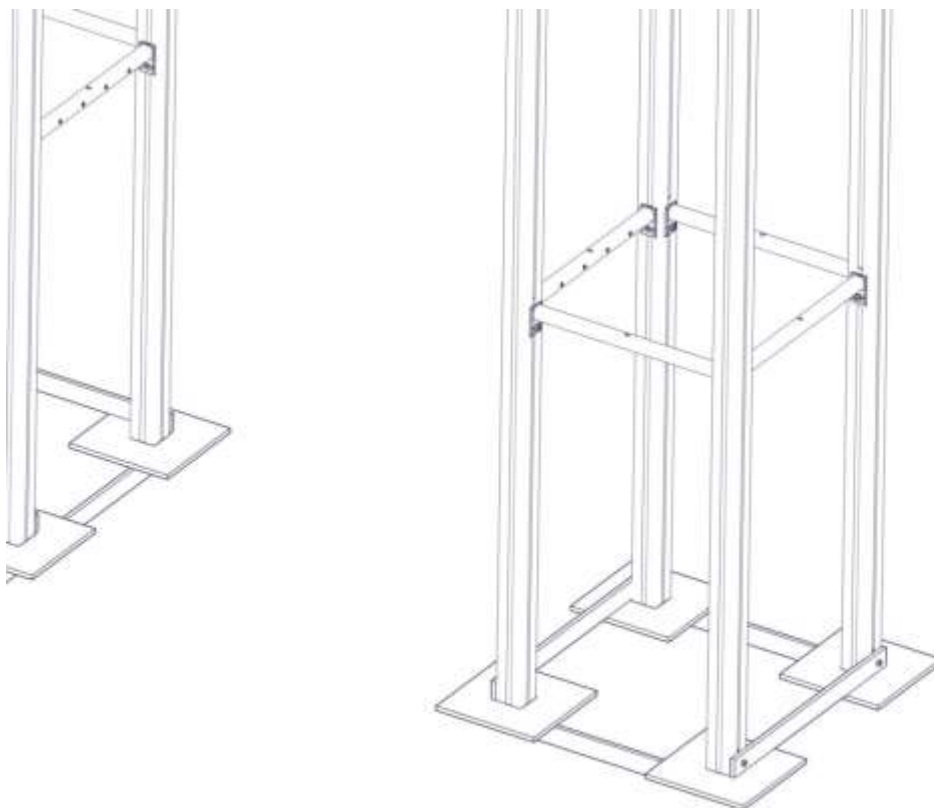
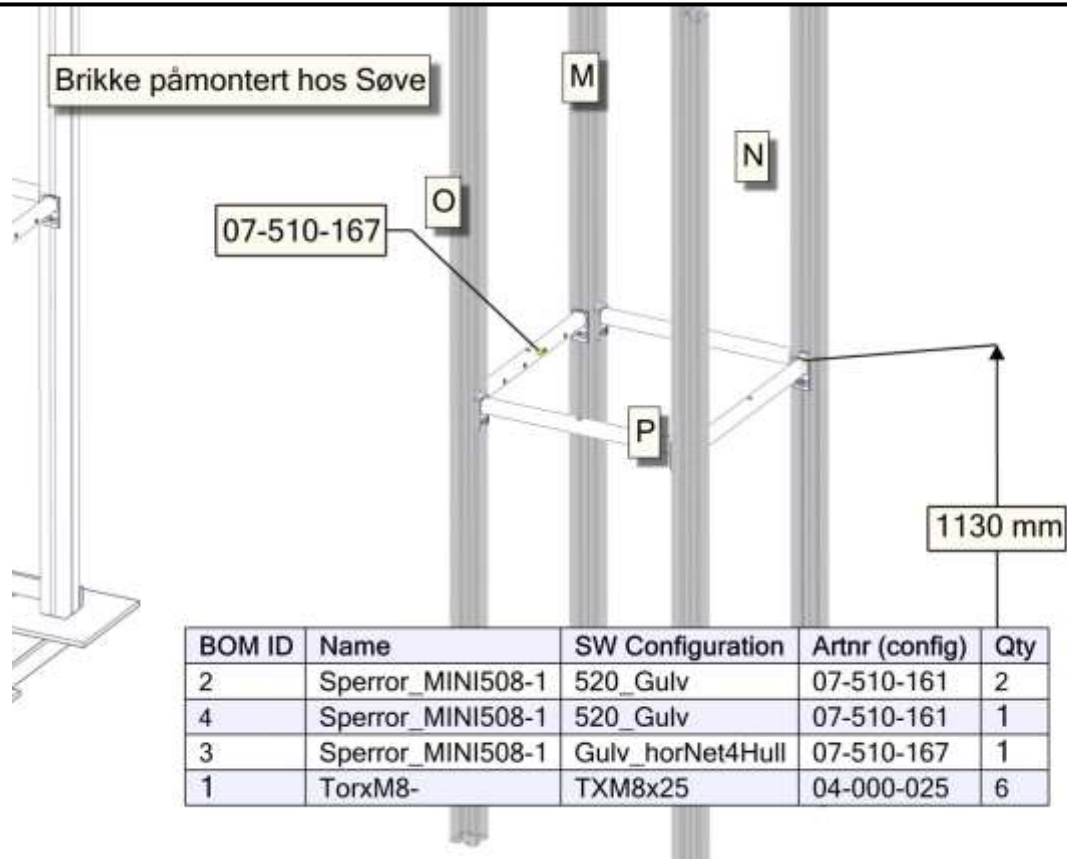

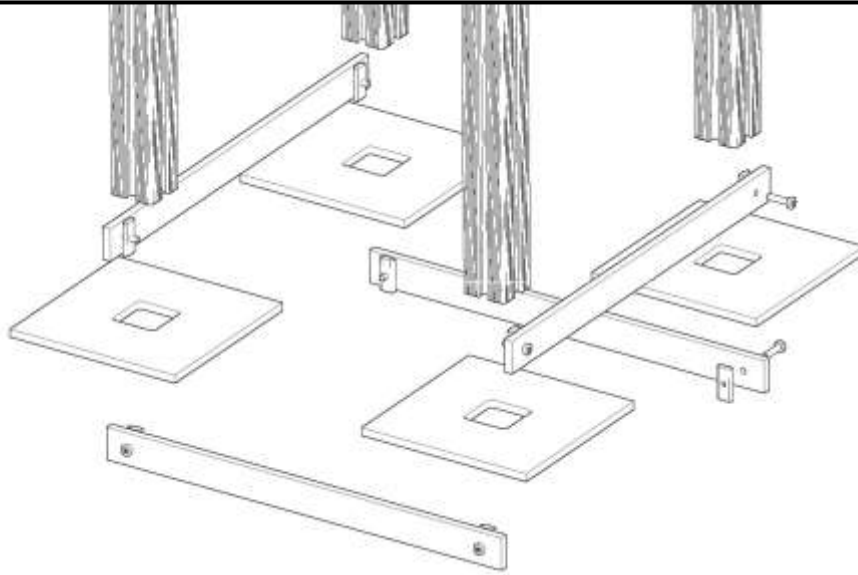

BOM ID	Name	SW Configuration	Artnr (config)	Qty
2	brikke_SFA5116-	50_1T	04-060-050	8
3	minifun_sprosse-1	660	07-510-200	4
4	minifunSkive-	Default	07-510-201	4
1	TorxM8-	TXM8x35	04-000-035	8

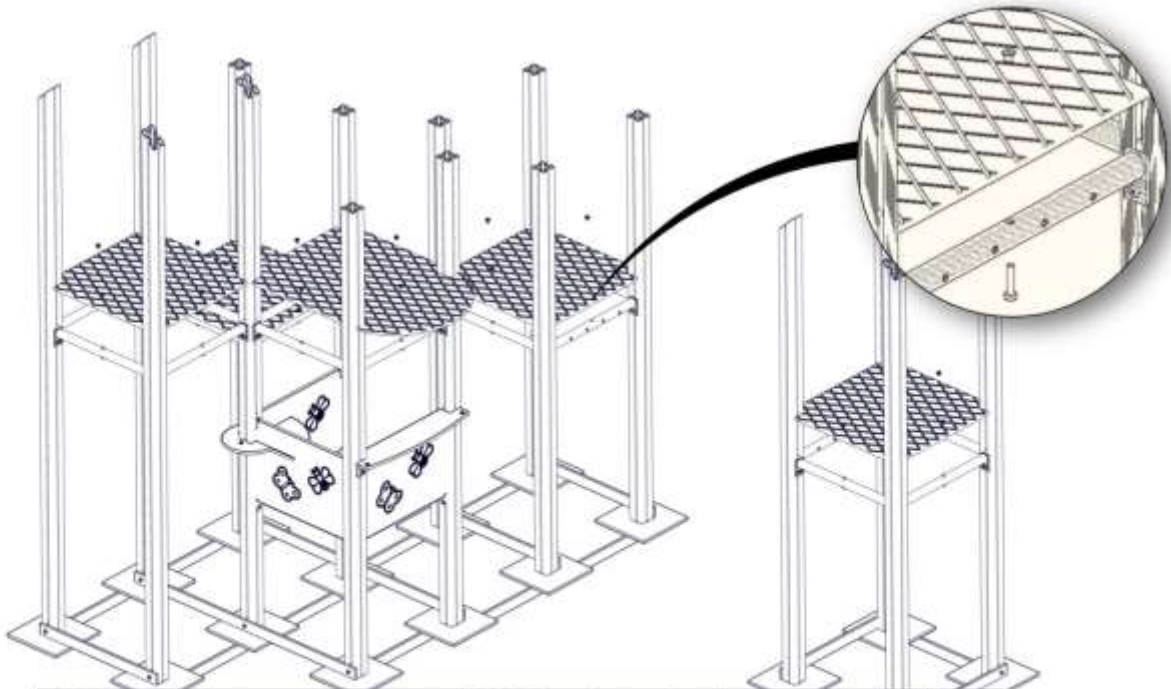

BOM ID	Name	SW Configuration	Artnr (config)	Qty
1	gulvmini_utsiktV3-1	Default	07-510-101	1
2	gulvmini-	Default	07-510-102	3
4	Mobelknapp-1	M8_13_17	04-030-011	14
3	TorxM8-1	TXM8x45	04-000-045	14

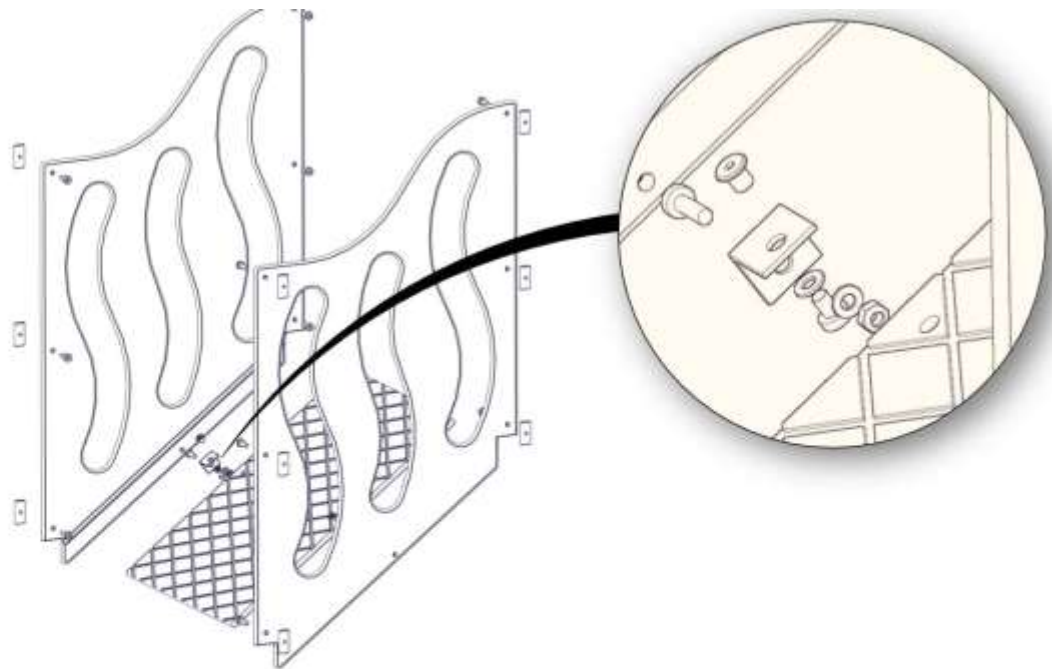
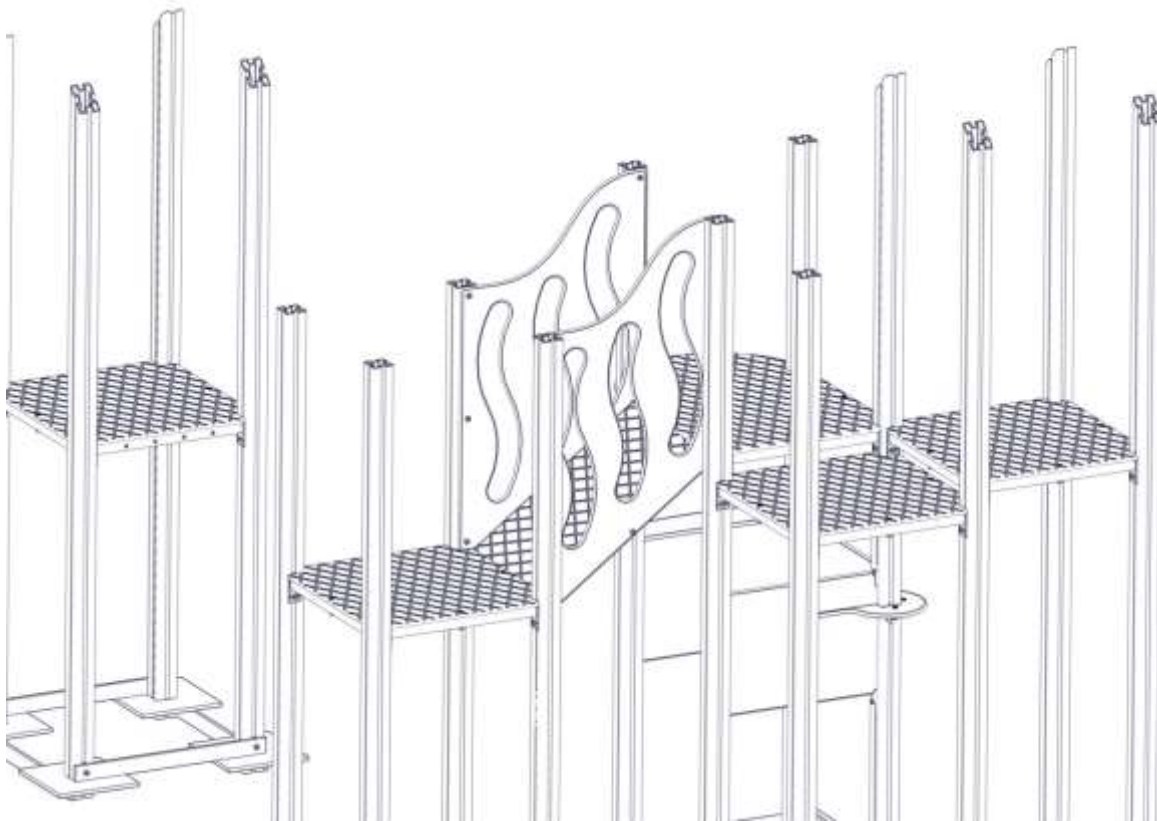

BOM ID	Name	SW Configuration	Artnr (config)	Qty
7	35x35x3-	11mm	04-070-036	2
6	brikke_SFA5116-1	50_1T	04-060-050	12
10	Skra_plato-1	Default	07-510-323	1
8	Rekkverk_skraplate-1	Default	07-510-321	1
9	Rekkverk_skraplate_mirror-1	Default	07-510-322	1
5	Skive-	M8	04-050-008	4

BOM ID	Name	SW Configuration	Artnr (config)	Qty
3	Mobelknapp-	M8_13_17	04-030-011	2
4	mutter_M8-	M8_Borg	04-040-008	2
1	TorxM8-	TXM8x12	04-000-012	2
2	TorxM8-	TXM8x25	04-000-025	14

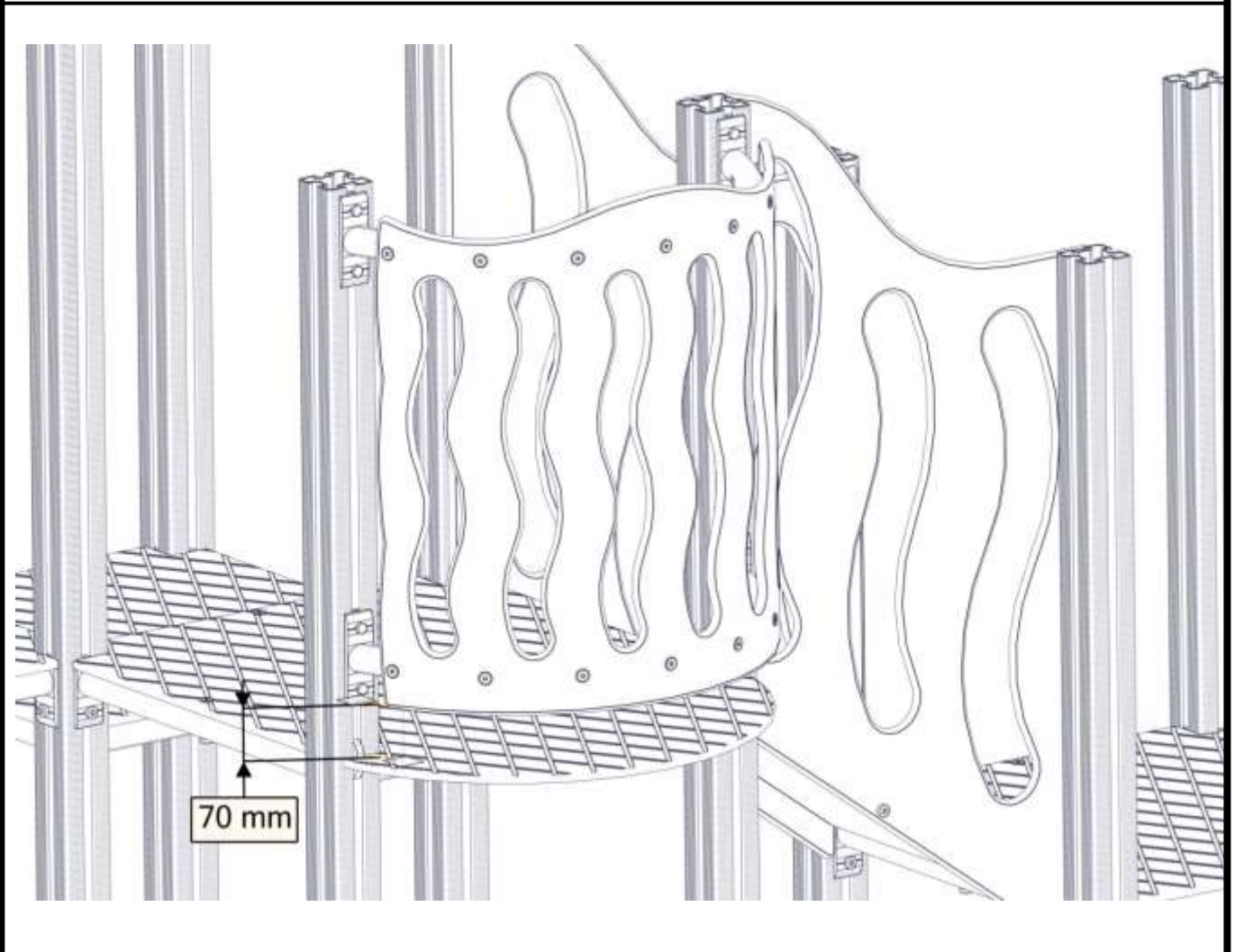
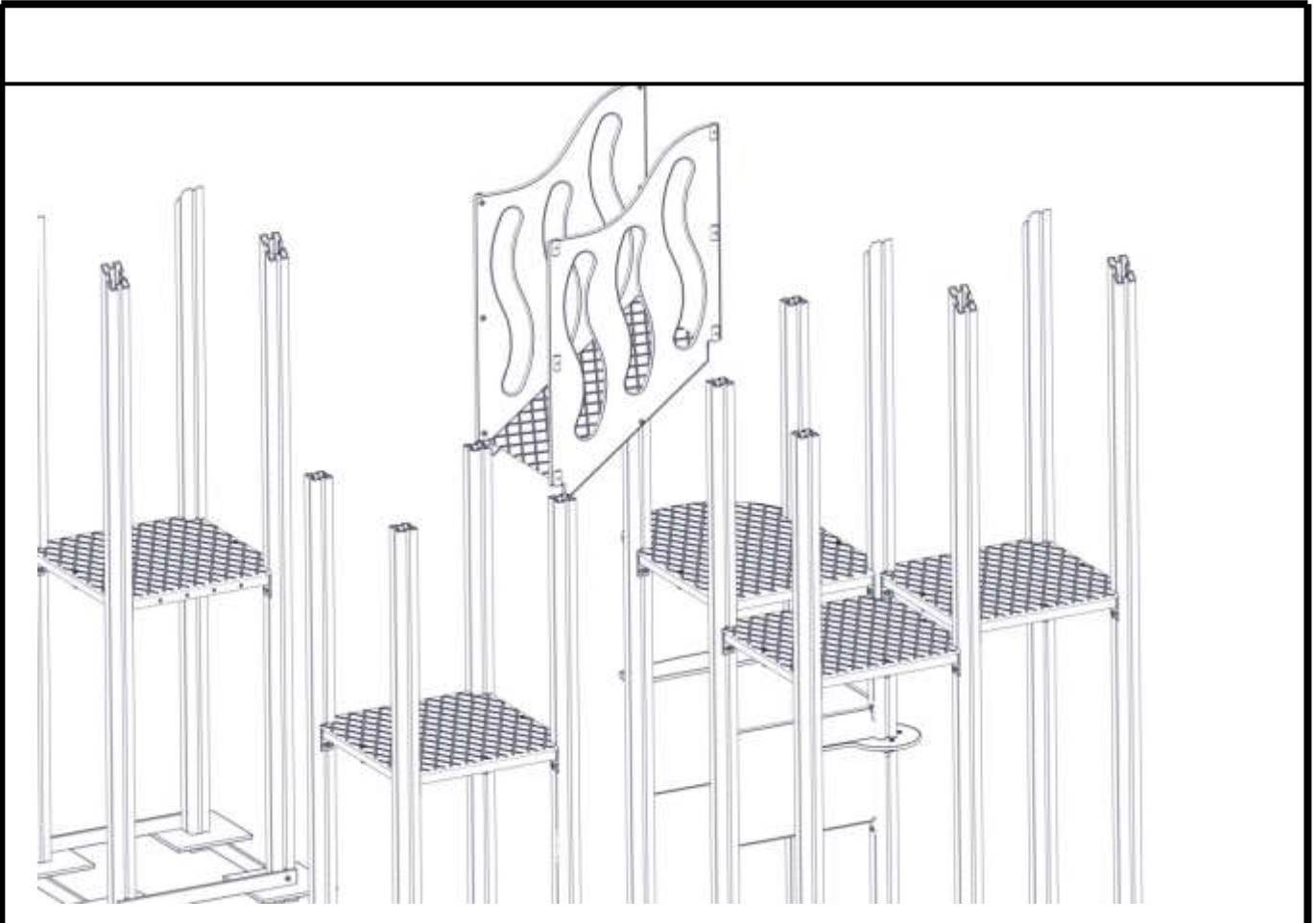

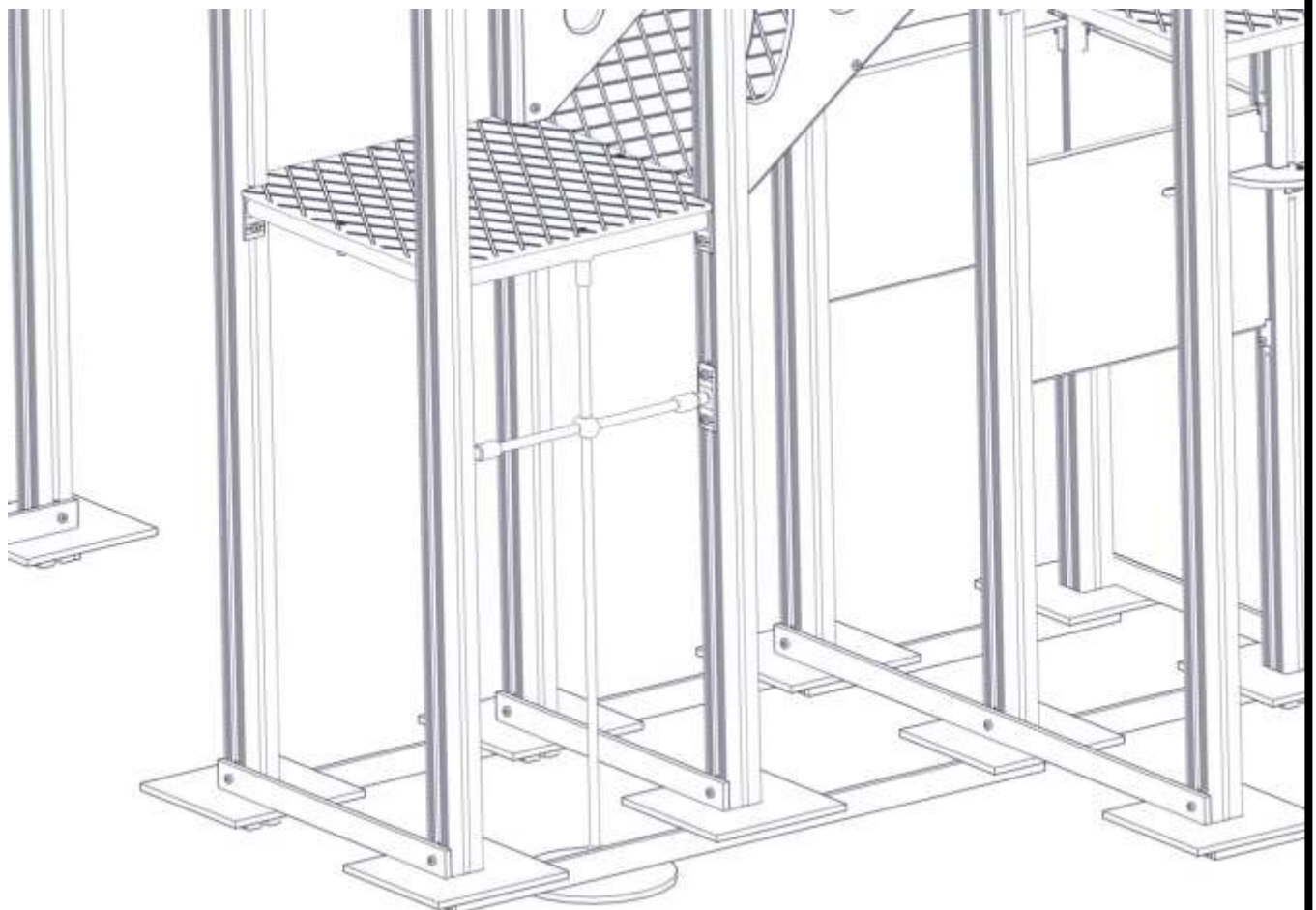
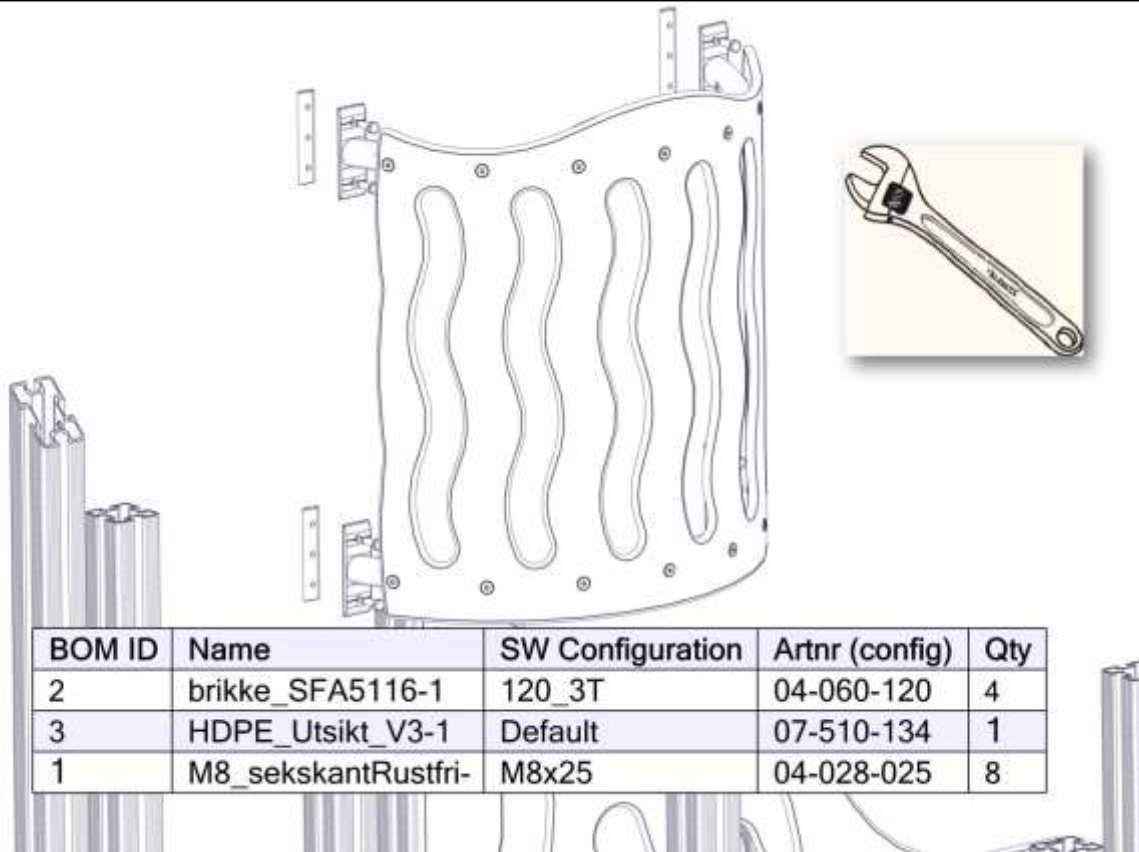

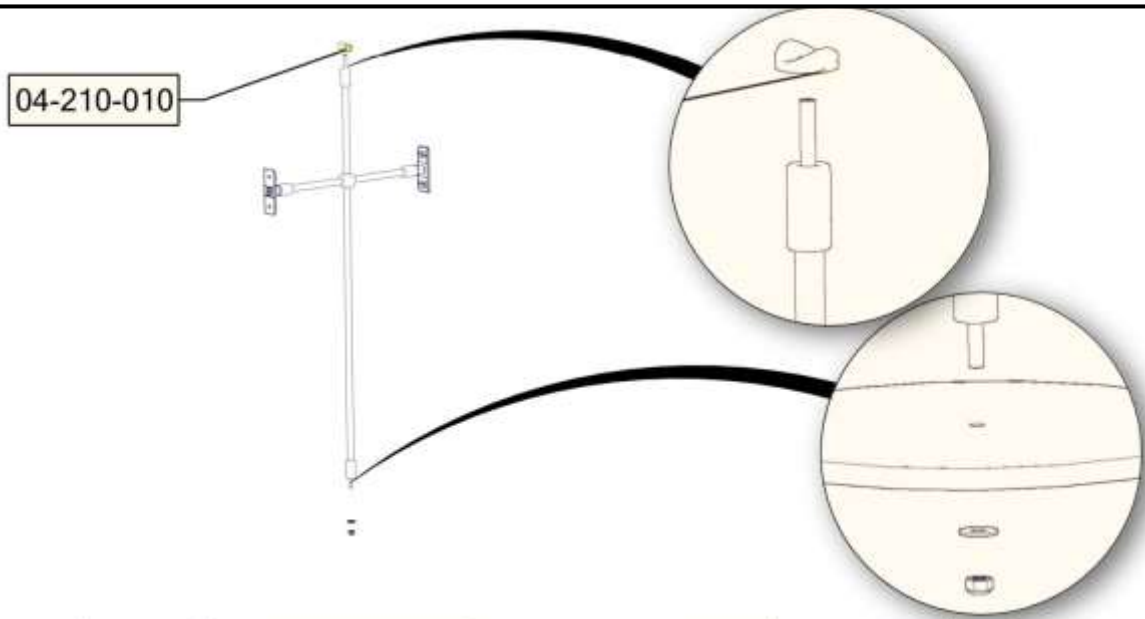

BOM ID	Name	SW Configuration	Artnr (config)	Qty
4	SaddleWasher_38-2	Default	04-210-010	1
5	Trepp550-1	Default<As Machined>	07-510-177	1
2	mutter_M8-1	M8_Borg	04-040-008	1
3	Skive-1	M8_stor	04-055-008	1

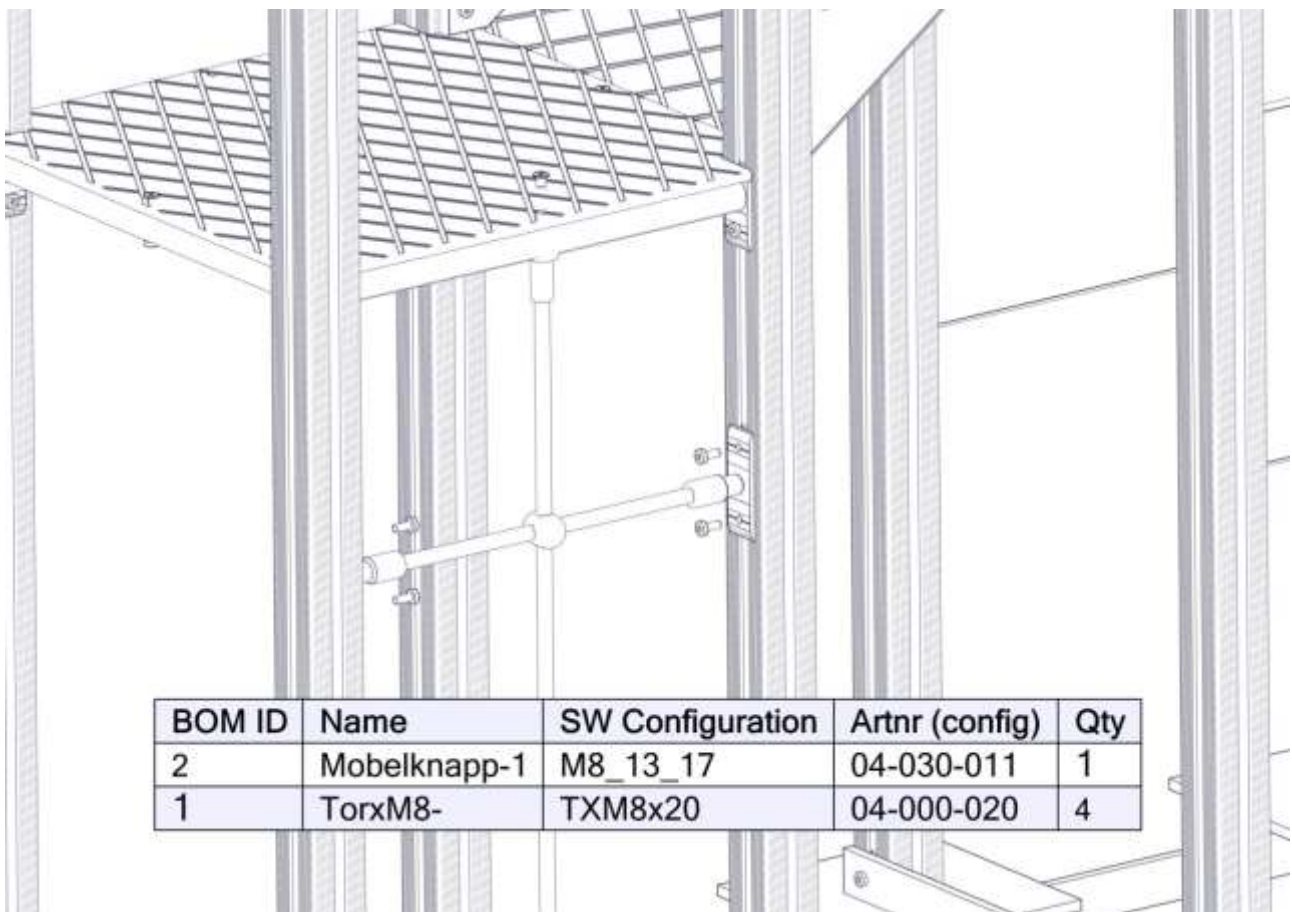

BOM ID	Name	SW Configuration	Artnr (config)	Qty
2	Mobelknapp-1	M8_13_17	04-030-011	1
1	TorxM8-	TXM8x20	04-000-020	4

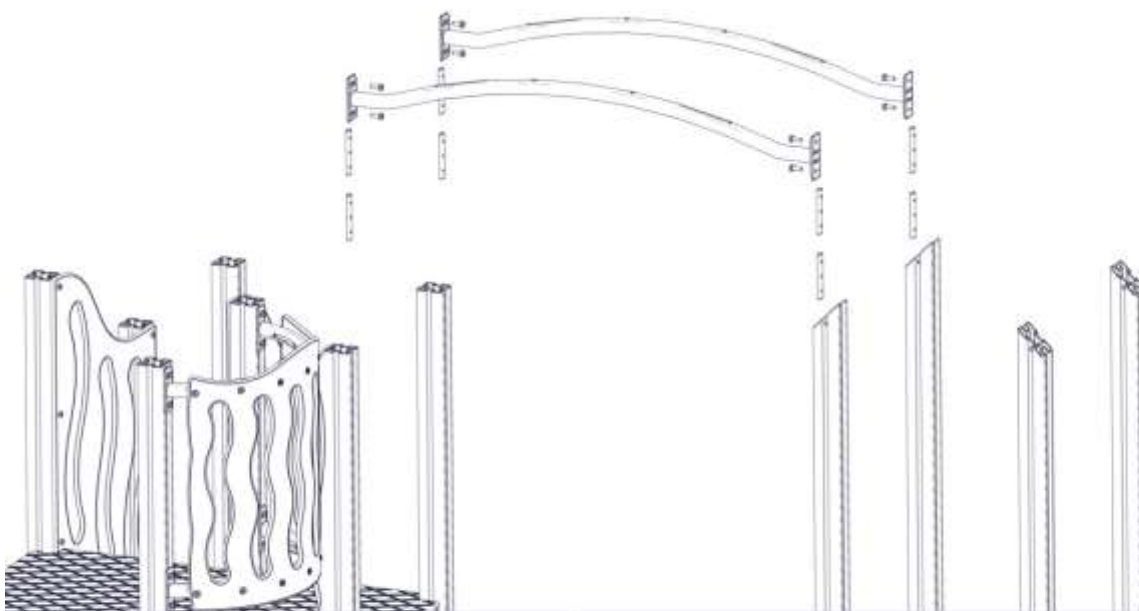
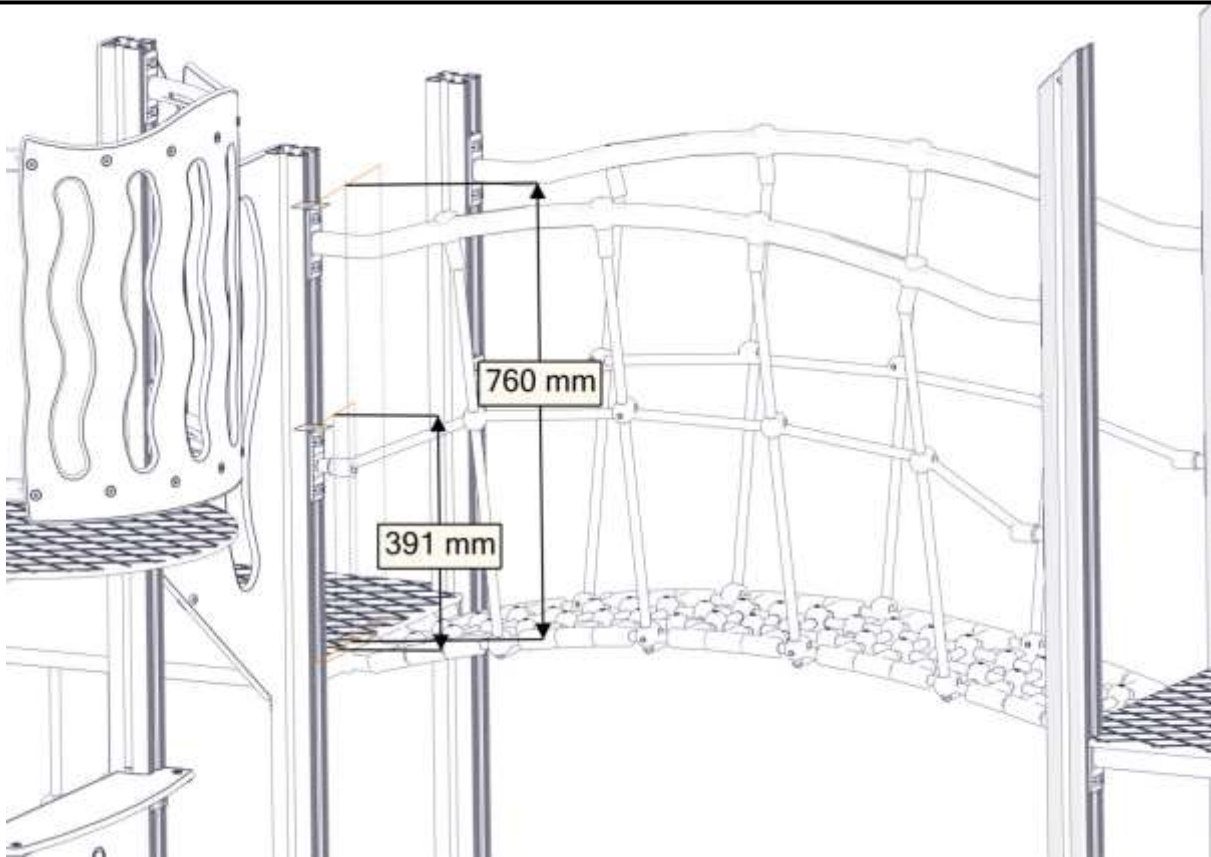

BOM ID	Name	SW Configuration	Artnr (config)	Qty
2	brikke_SFA5116-1	120_3T	04-060-120	8
3	Mini_Boy_SperrorV2-1	Default<As Machined>	07-510-164	2
1	TorxM8-	TXM8x25	04-000-025	8

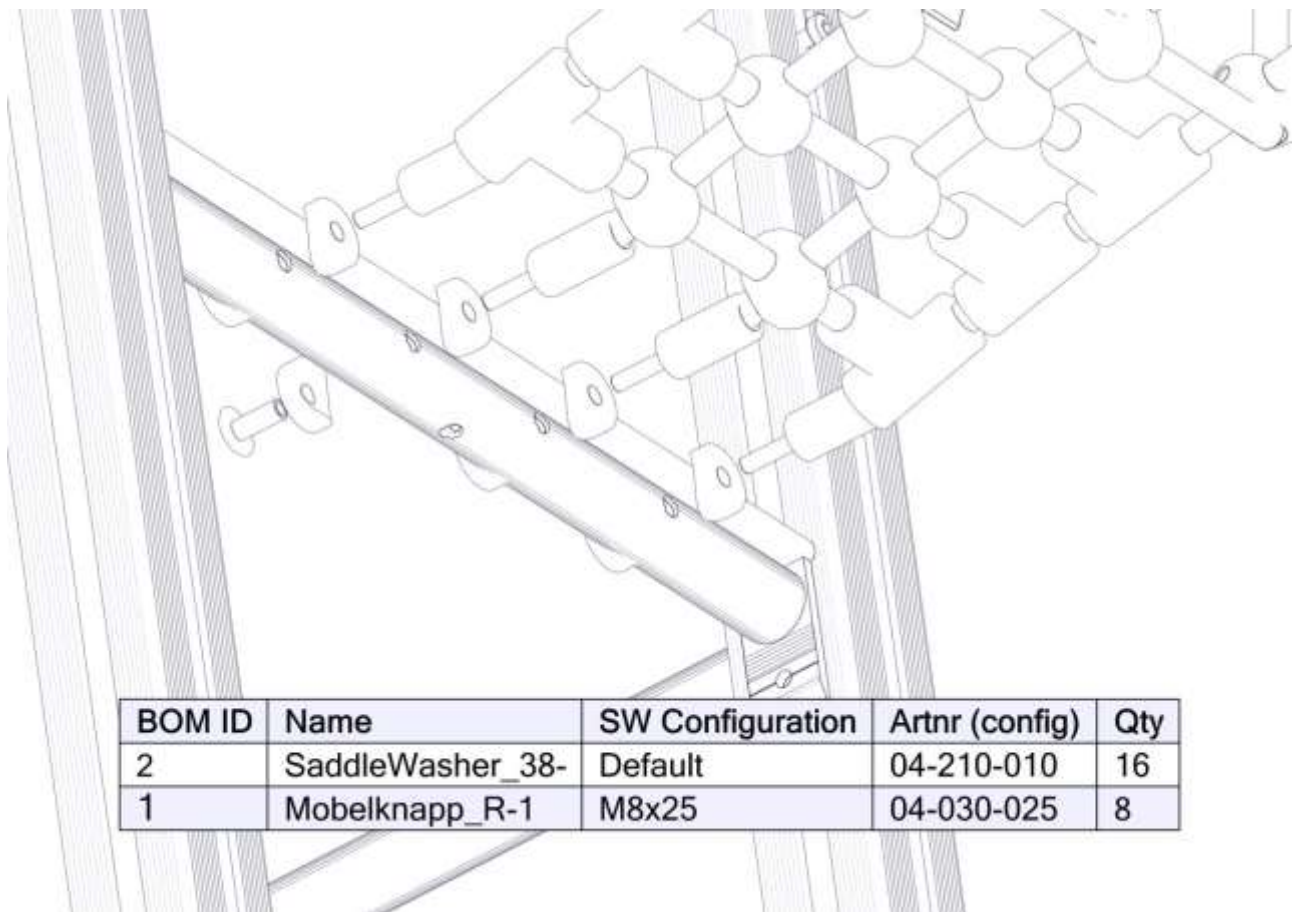
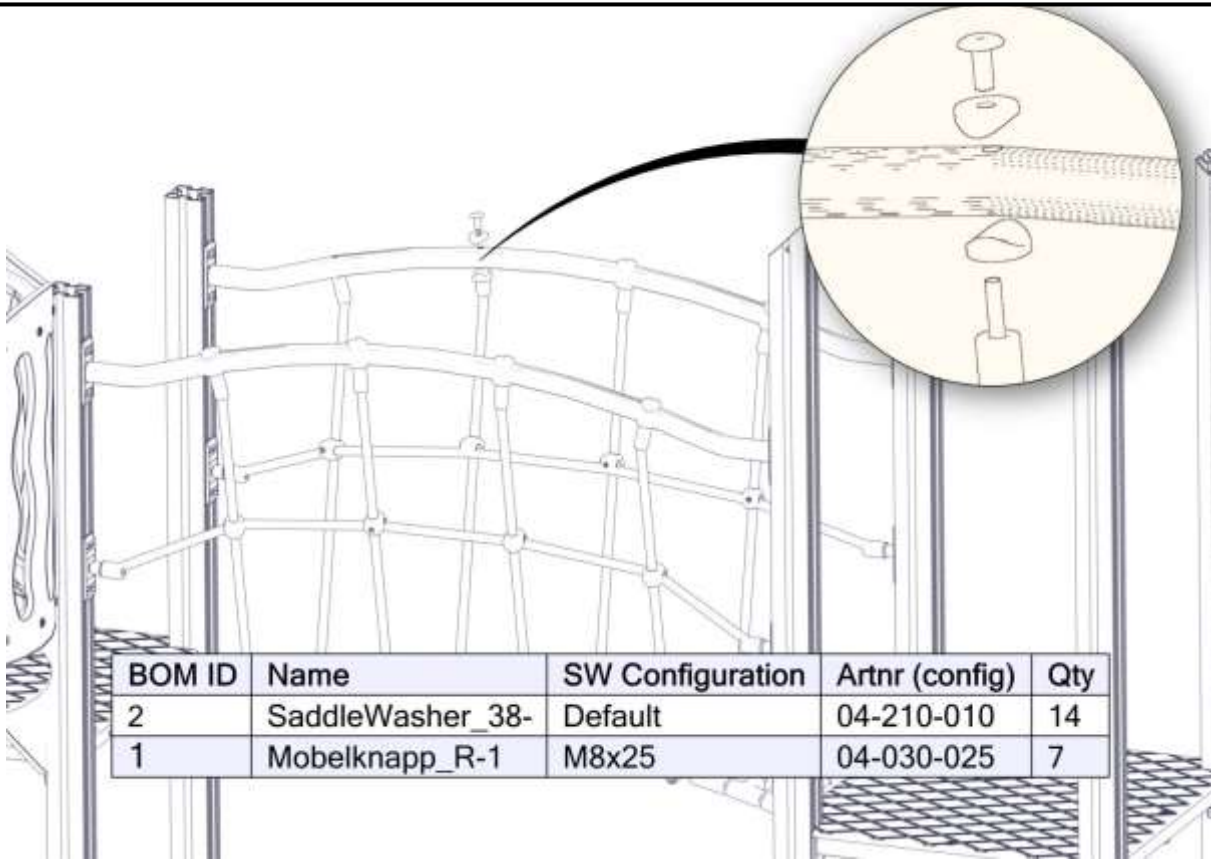

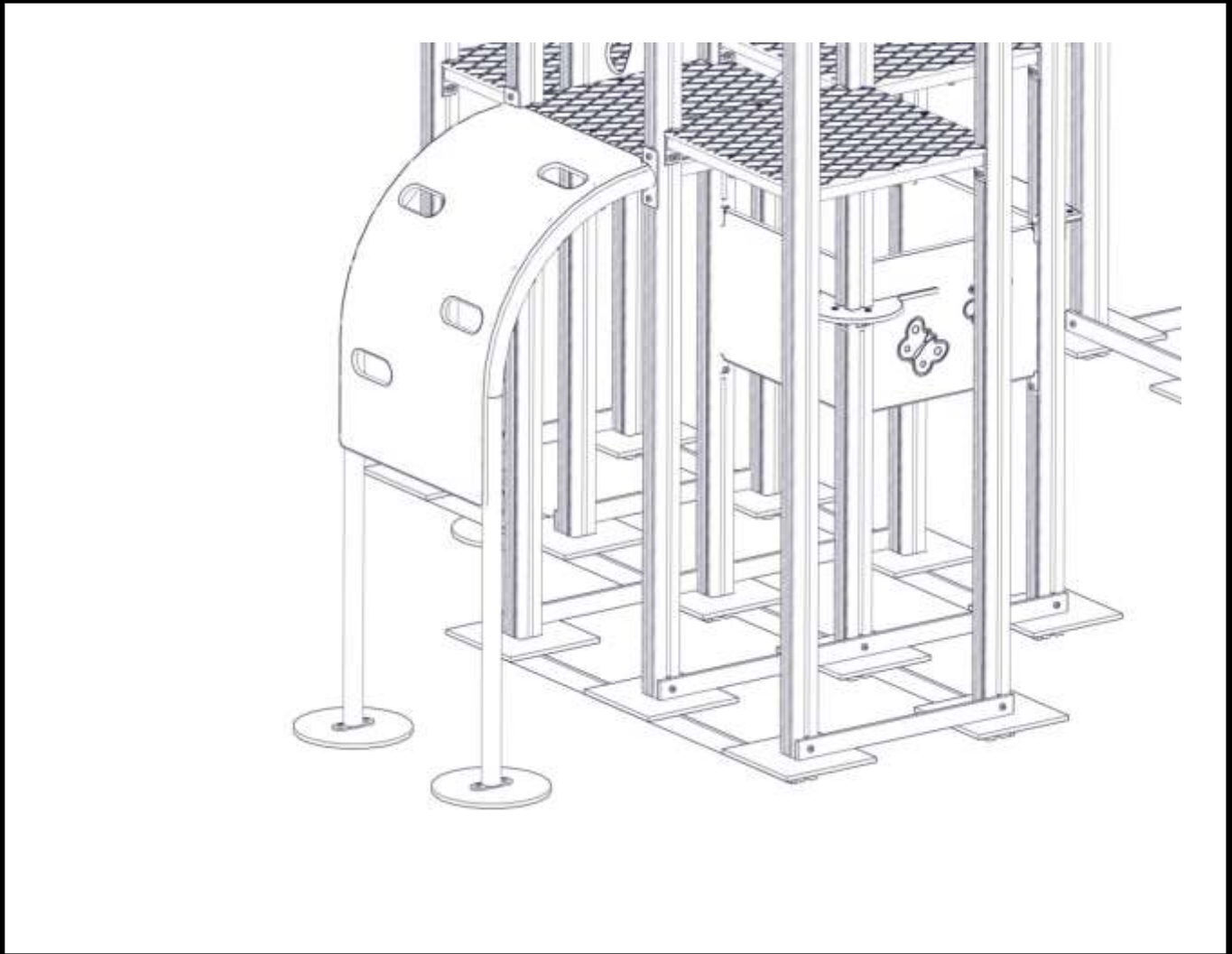
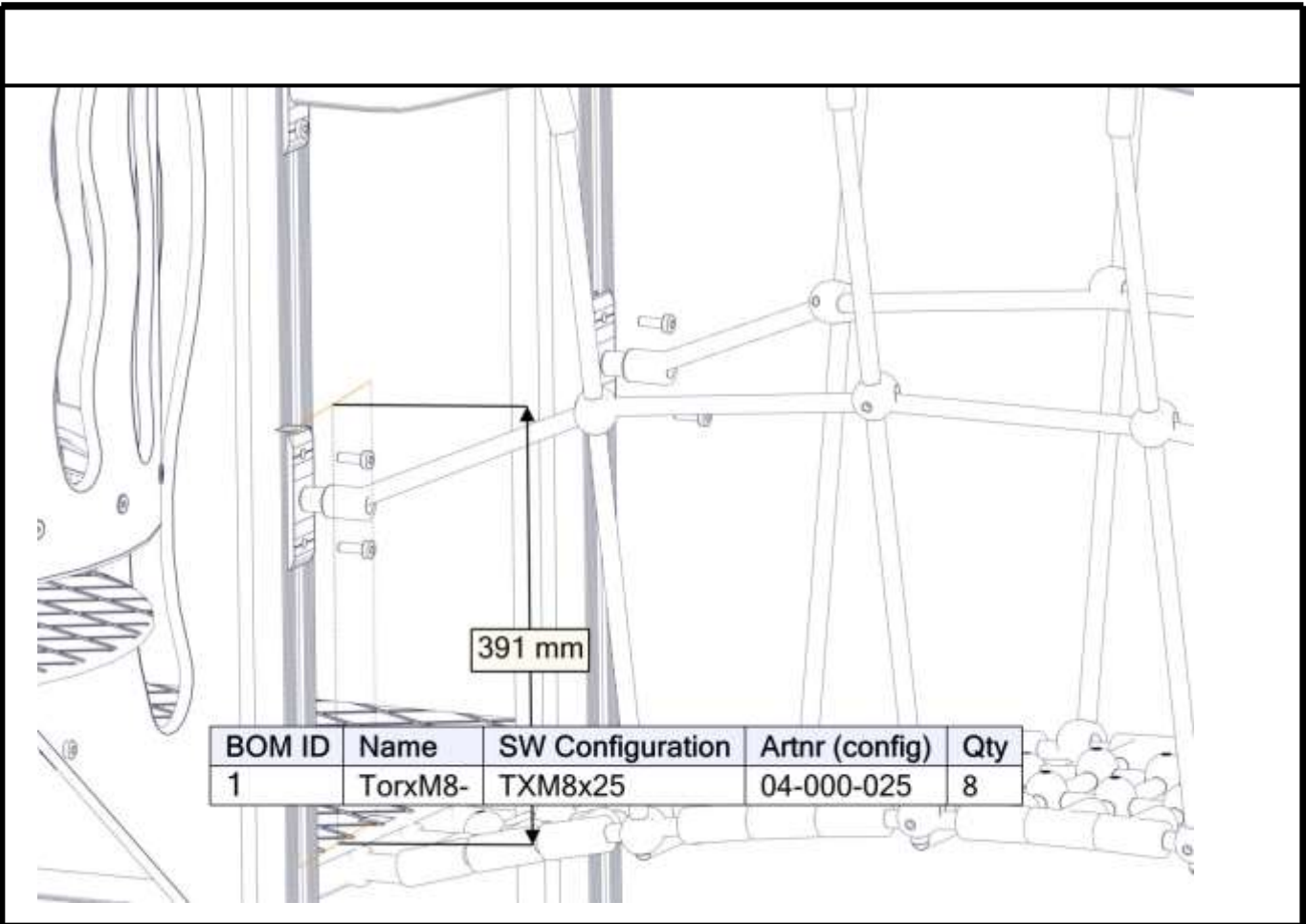

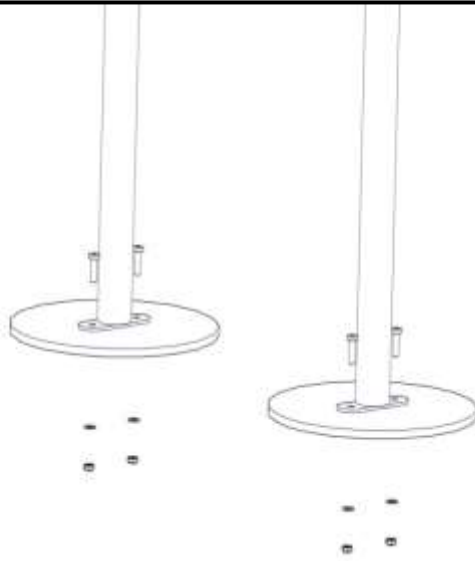

BOM ID	Name	SW Configuration	Artnr (config)	Qty
5	KrabbeplateHDPE-1	Default	07-510-135	1
4	Skive-1	M8	04-050-008	4
3	mutter_M8-1	M8_Borg	04-040-008	4
2	Torxm8-1	TXM8x35	04-000-035	4

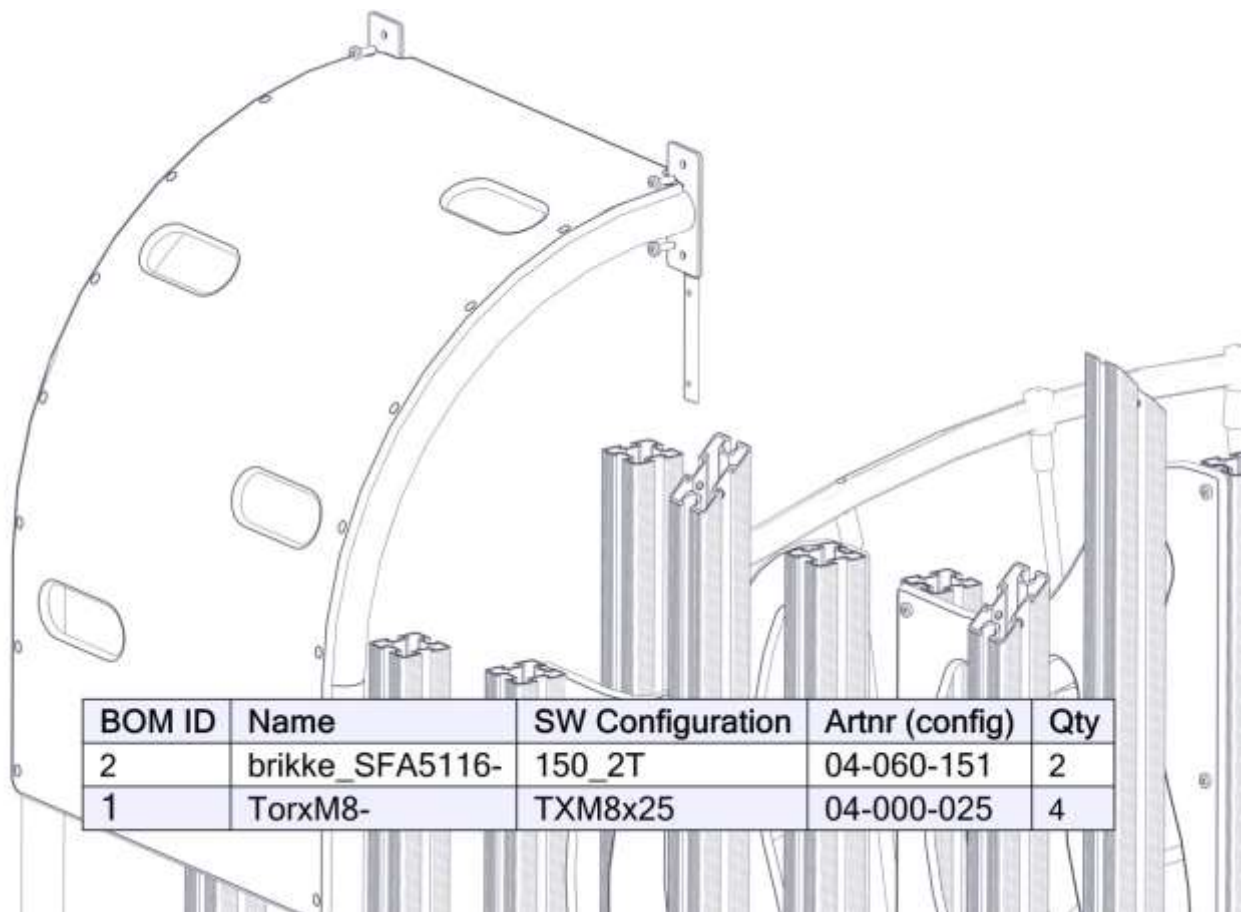

BOM ID	Name	SW Configuration	Artnr (config)	Qty
2	brikke_SFA5116-	150_2T	04-060-151	2
1	Torxm8-	TXM8x25	04-000-025	4

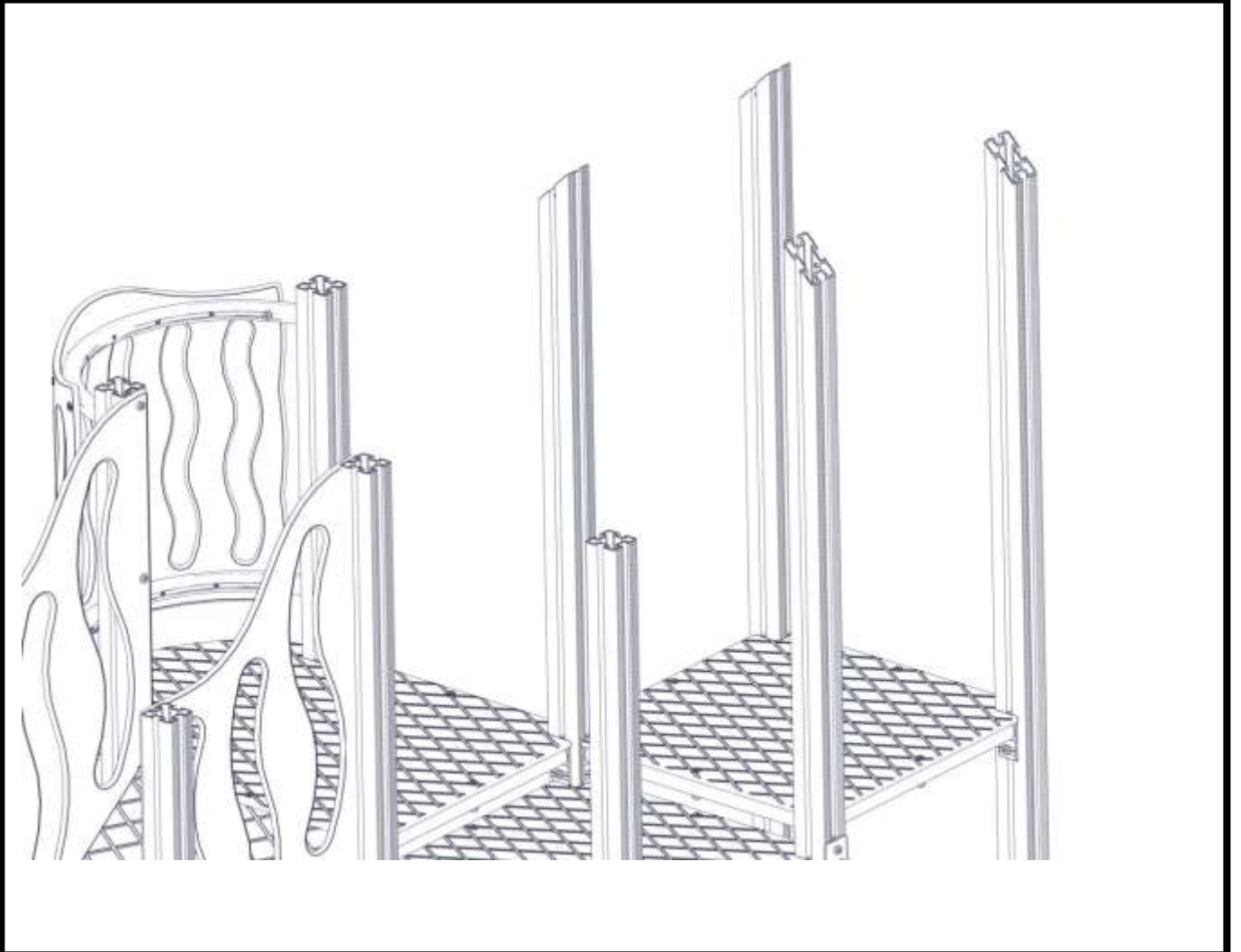
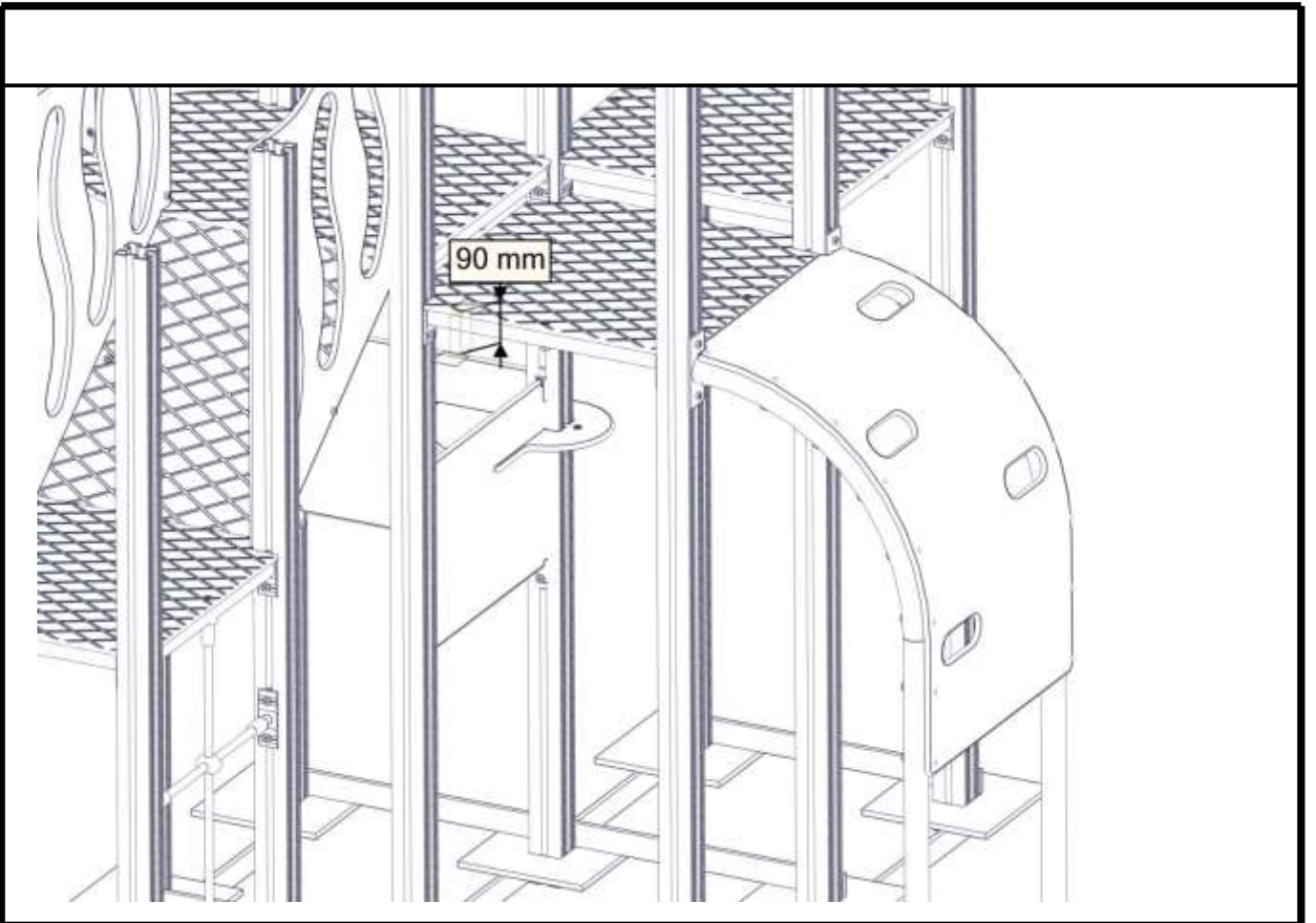

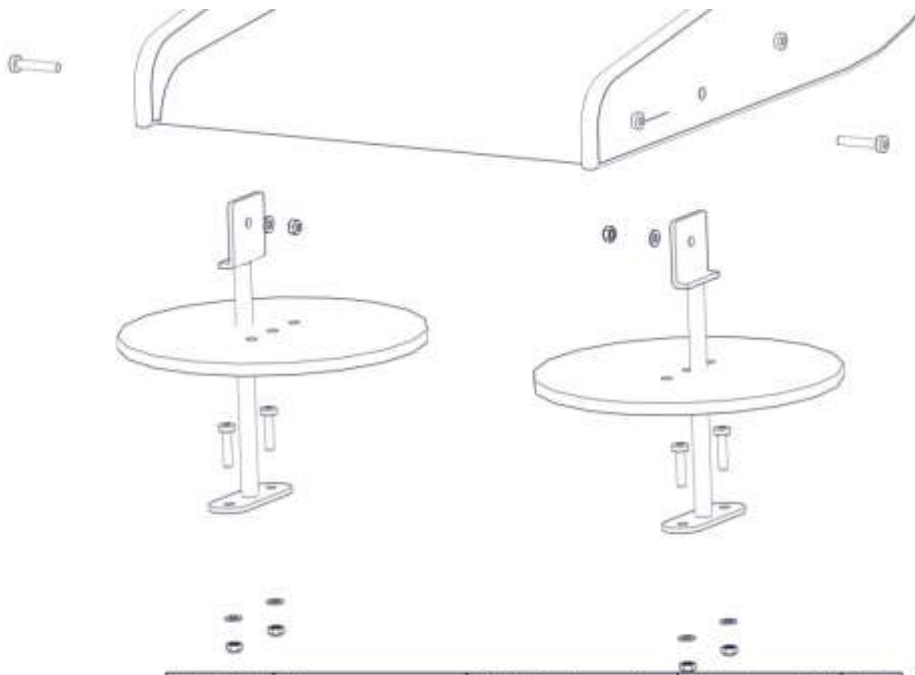
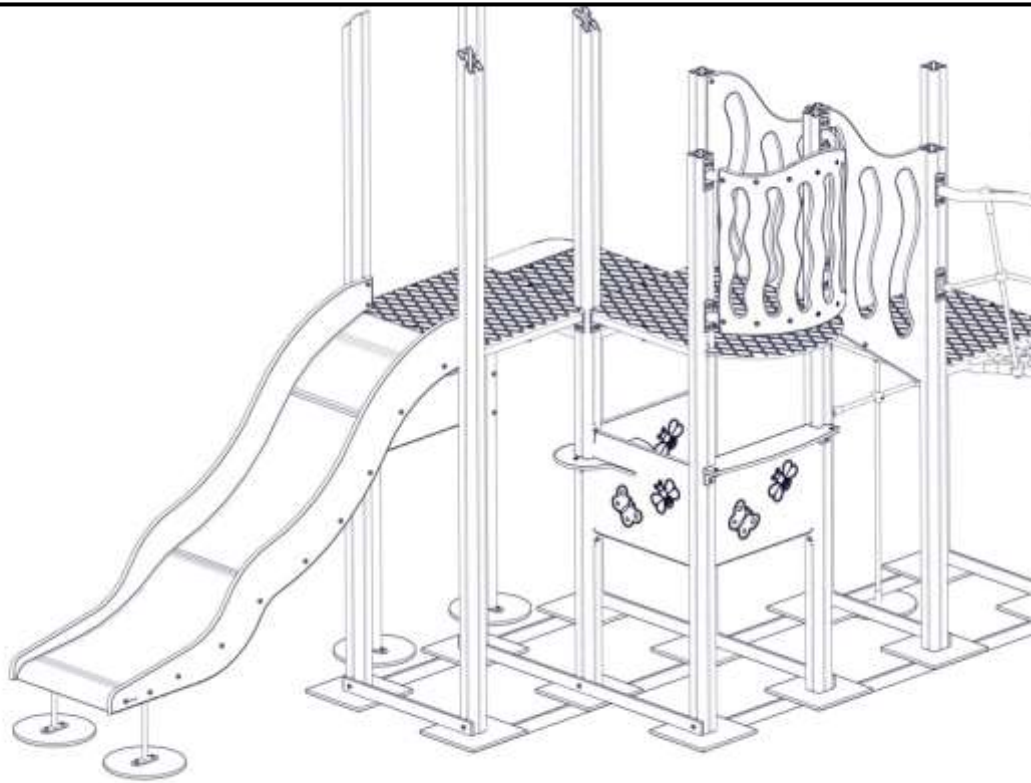

BOM ID	Name	SW Configuration	Artnr (config)	Qty
2	Stalforankring-1	liten	00-100-312	2
6	Skive-	M8	04-050-008	6
5	mutter_M8-	M8_Borg	04-040-008	6
3	TorxM8-	TXM8x35	04-000-035	4
4	TorxM8-1	TXM8x45	04-000-045	2

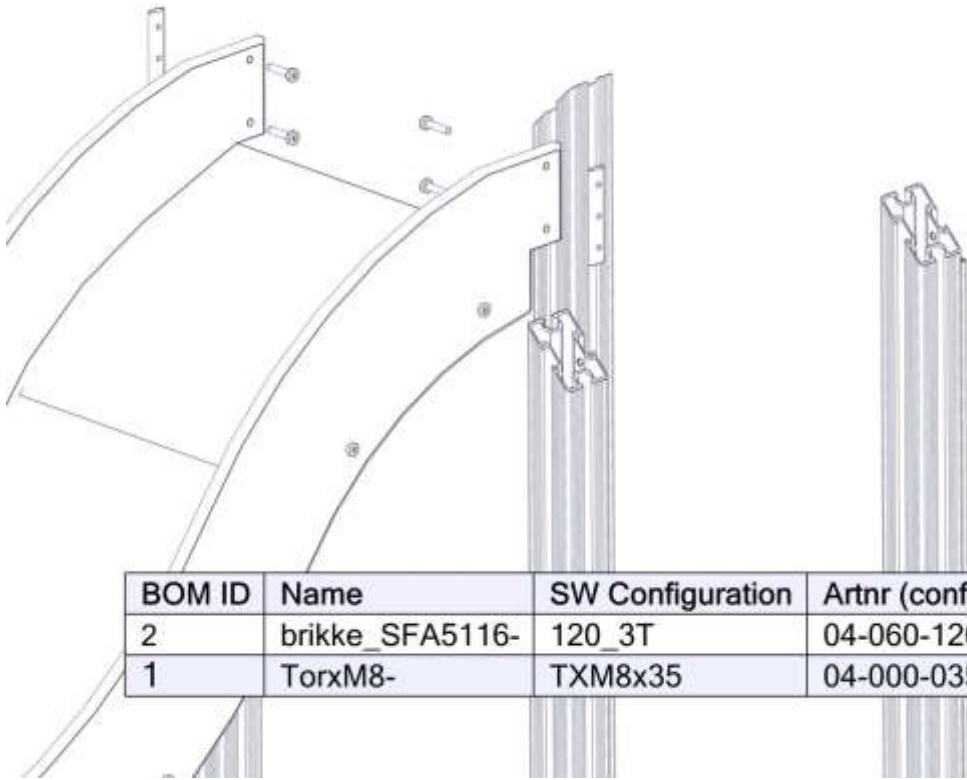

BOM ID	Name	SW Configuration	Artnr (config)	Qty
2	brikke_SFA5116-	120_3T	04-060-120	2
1	TorxM8-	TXM8x35	04-000-035	4

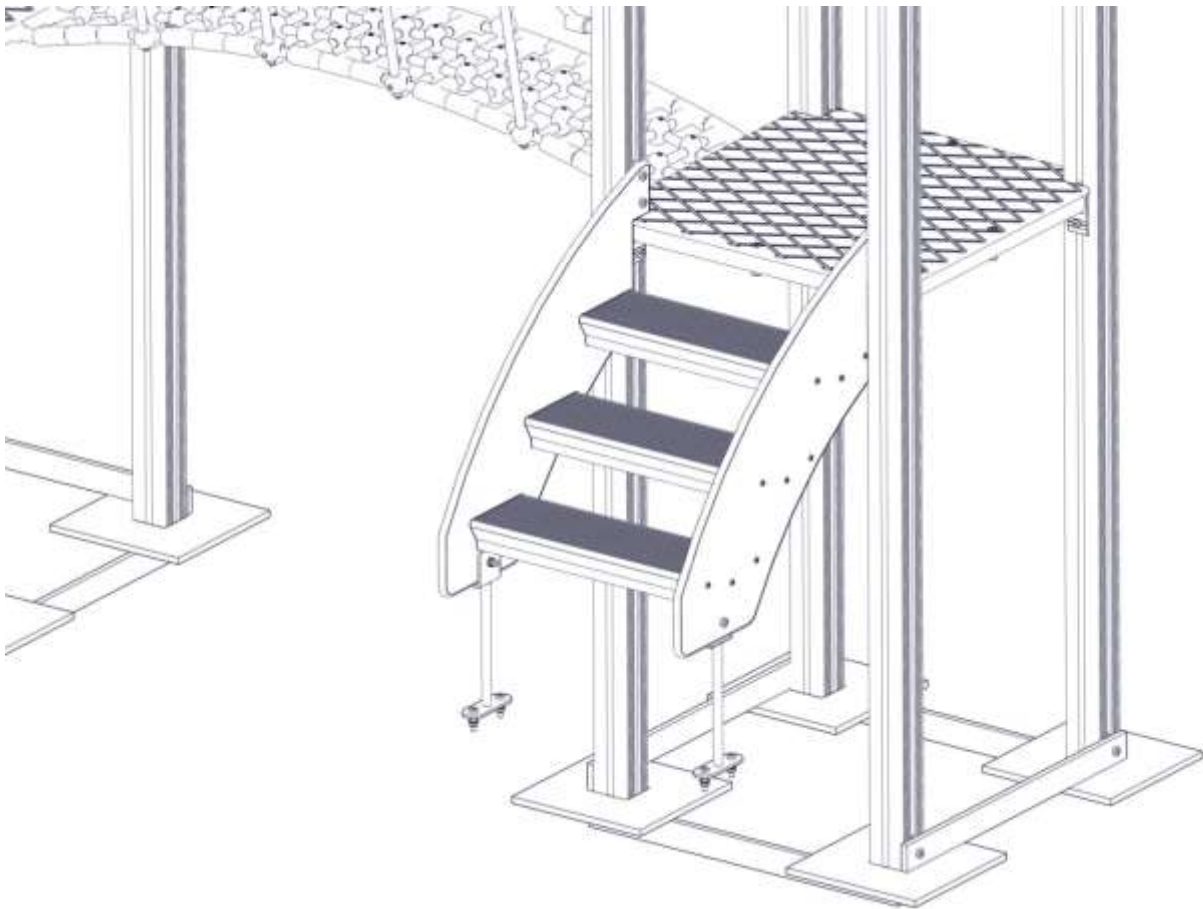

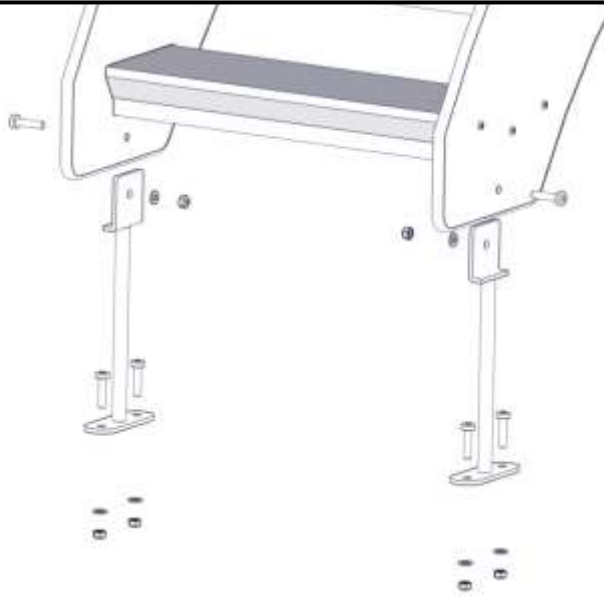

BOM ID	Name	SW Configuration	Artnr (config)	Qty
2	Stalforankring-1	liten	00-100-312	2
5	Skive-	M8	04-050-008	6
4	mutter_M8-	M8_Borg	04-040-008	6
3	TorxM8-	TXM8x35	04-000-035	6

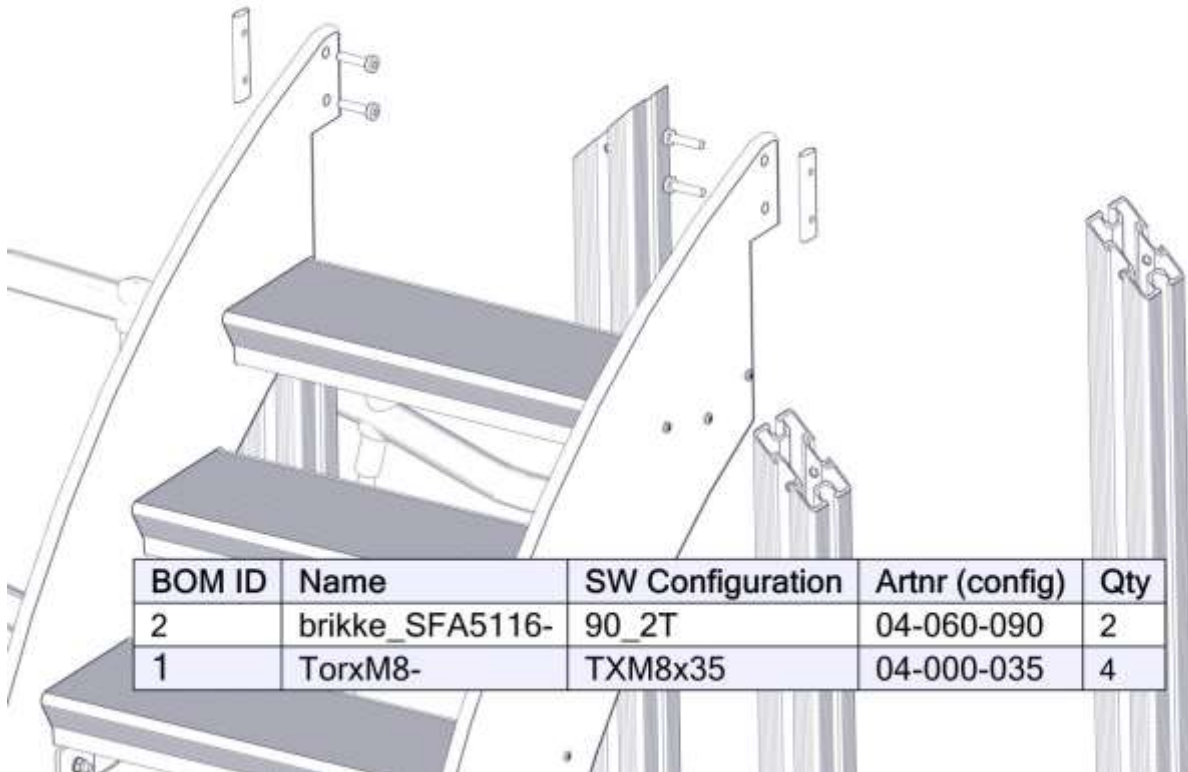

BOM ID	Name	SW Configuration	Artnr (config)	Qty
2	brikke_SFA5116-	90_2T	04-060-090	2
1	TorxM8-	TXM8x35	04-000-035	4

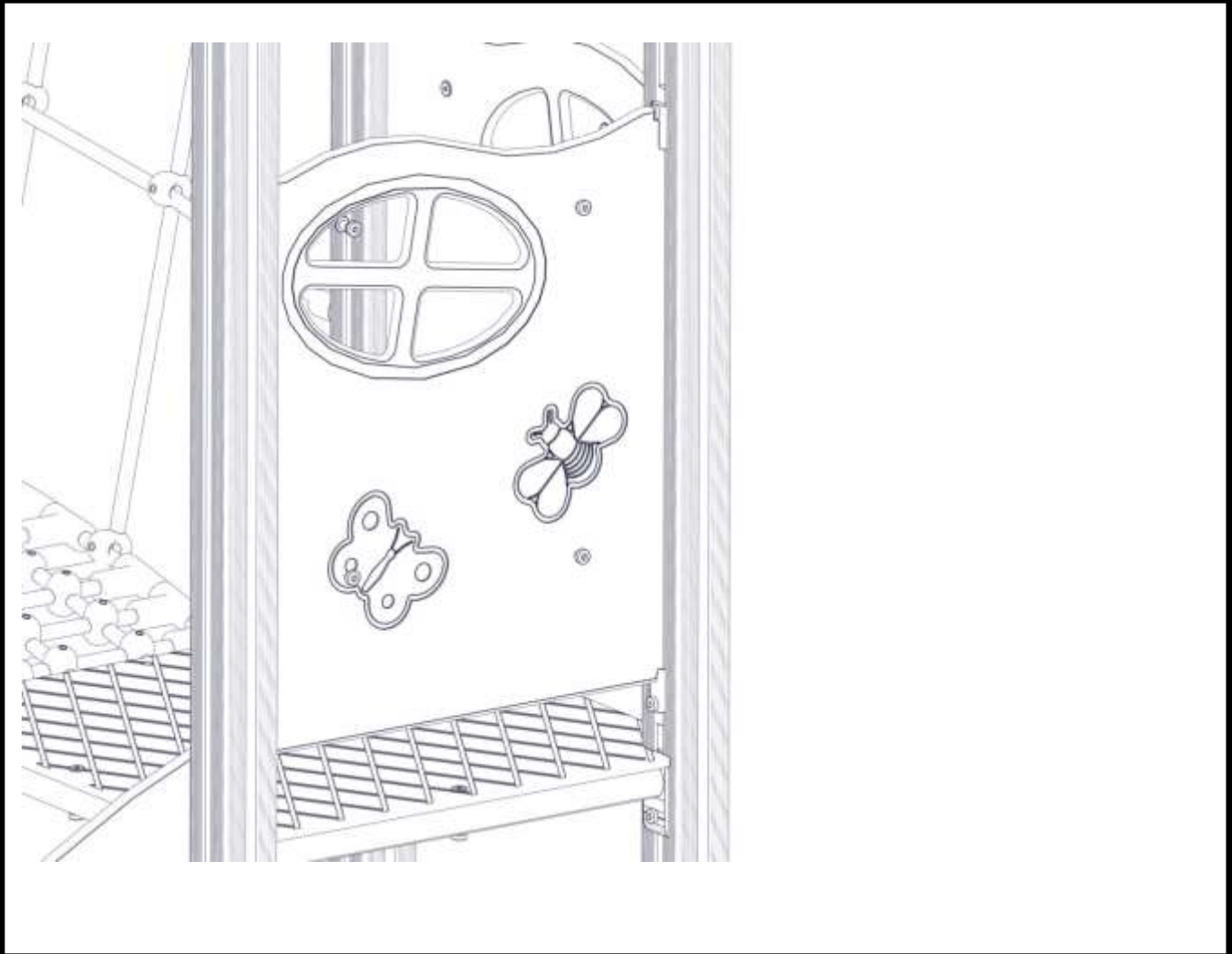
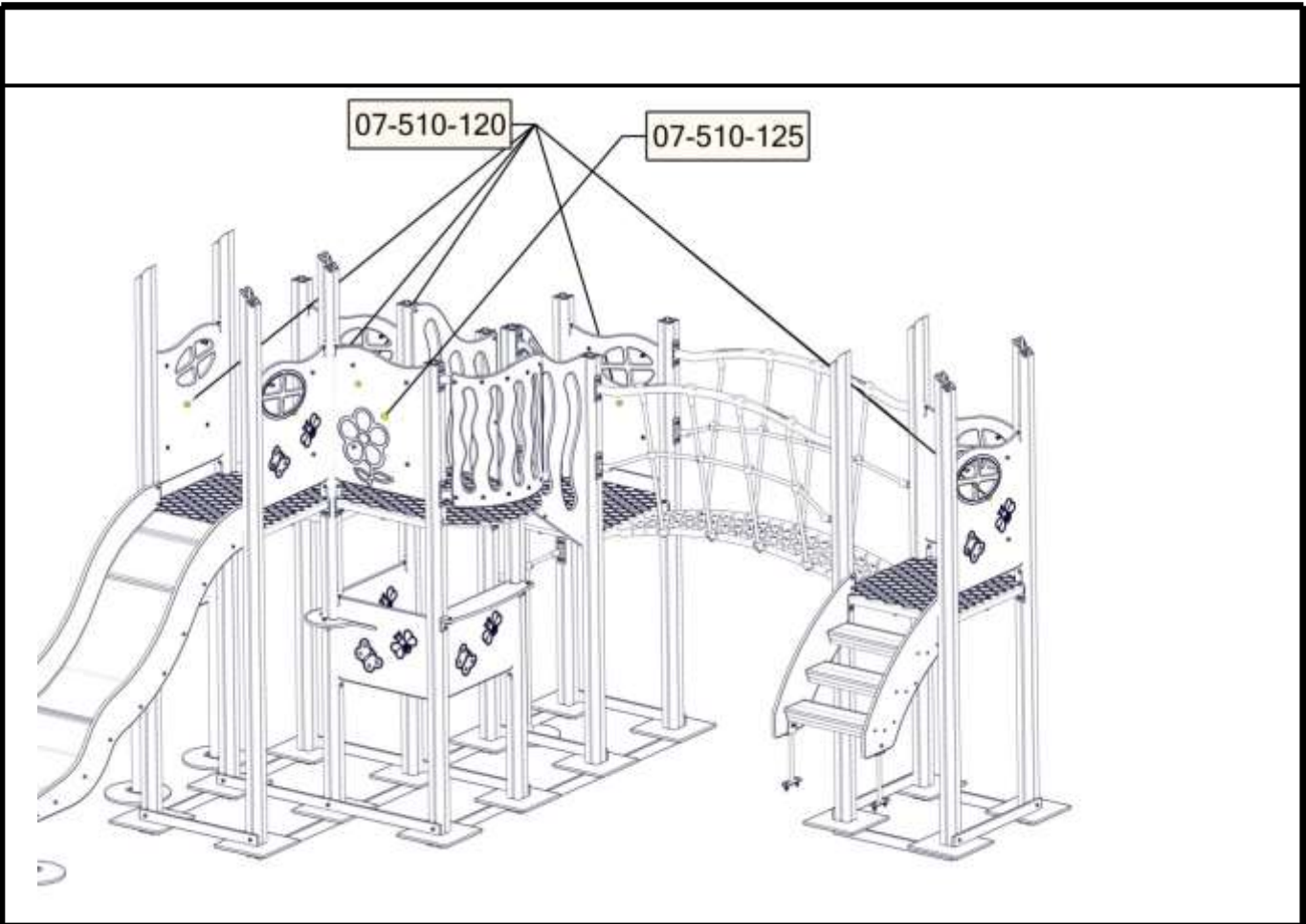

7x

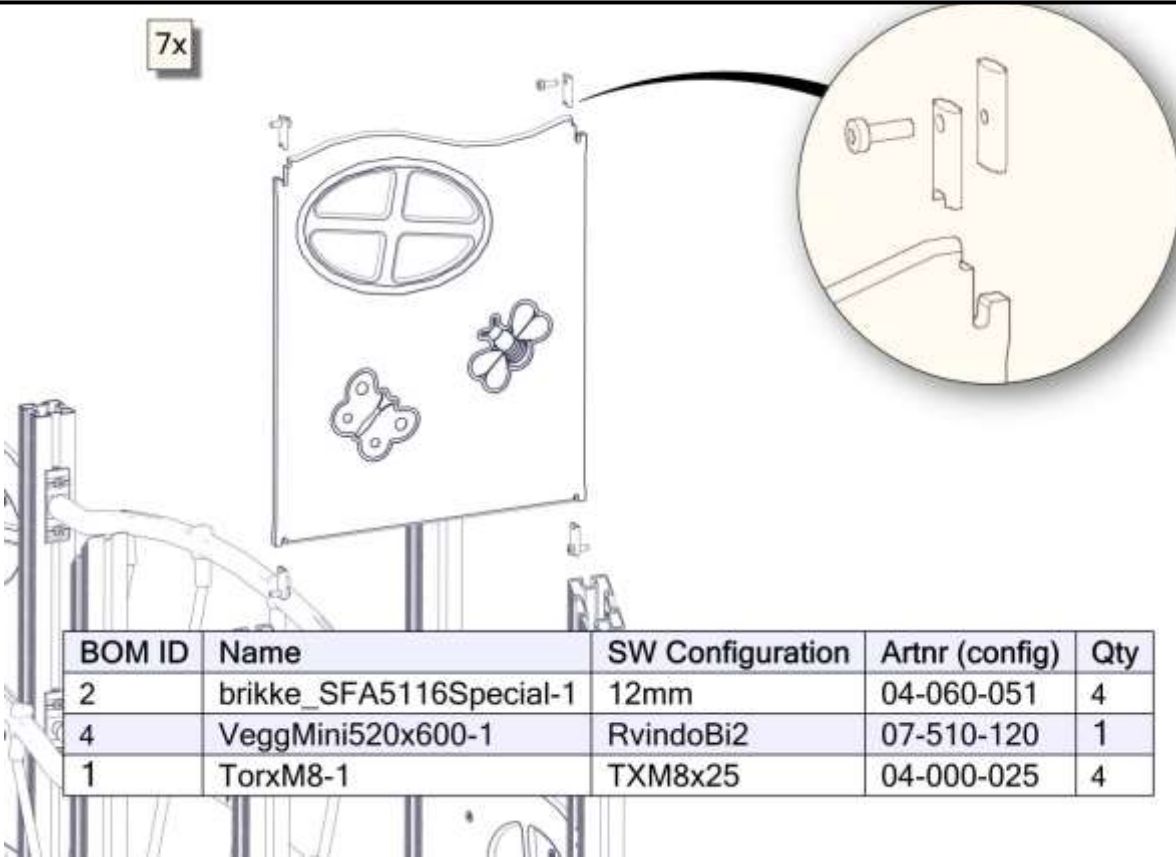

BOM ID	Name	SW Configuration	Artnr (config)	Qty
2	brikke_SFA5116Special-1	12mm	04-060-051	4
4	VeggMini520x600-1	RvindoBi2	07-510-120	1
1	TorxM8-1	TXM8x25	04-000-025	4

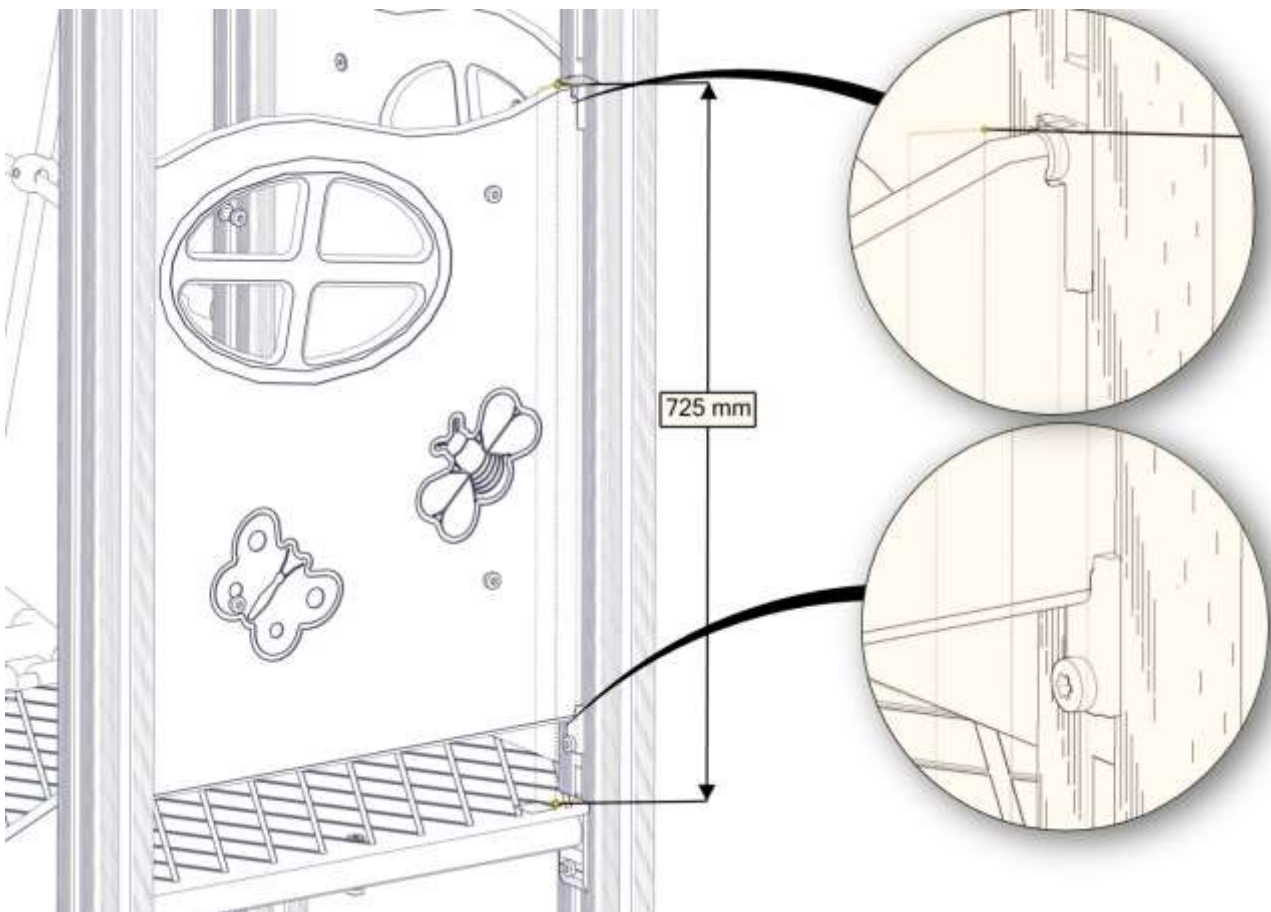

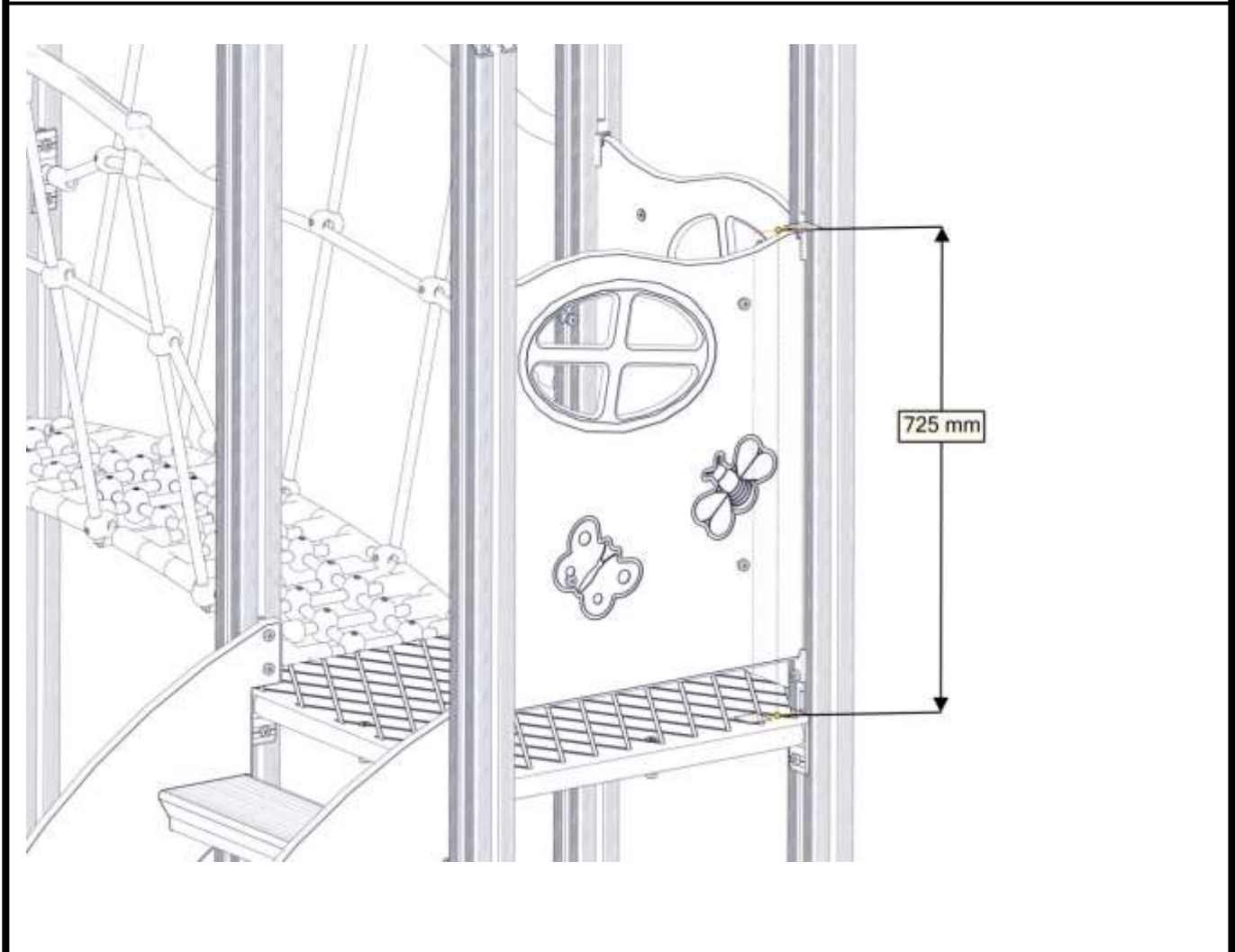
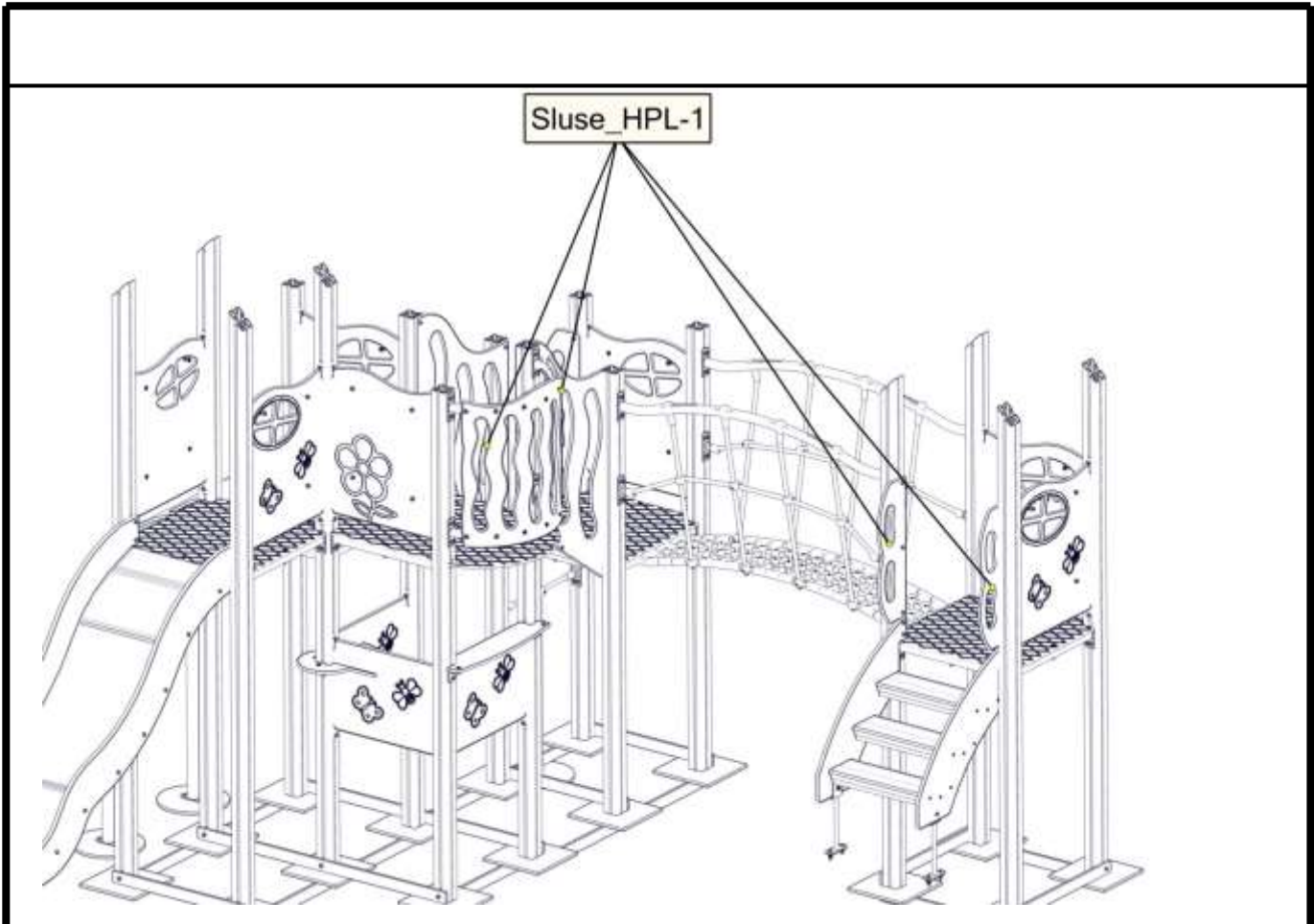

4x

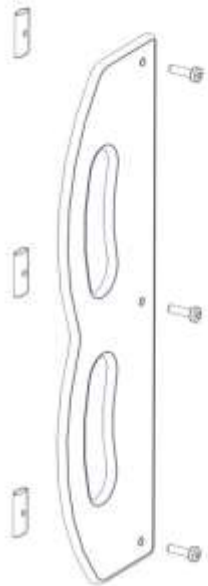

BOM ID	Name	SW Configuration	Artnr (config)	Qty
2	brikke_SFA5116-	50_1T	04-060-050	3
1	TorxM8-	TXM8x30	04-000-030	3
3	Sluse_HPL-1	yellow	00-400-172	1

07-510-160

772 mm

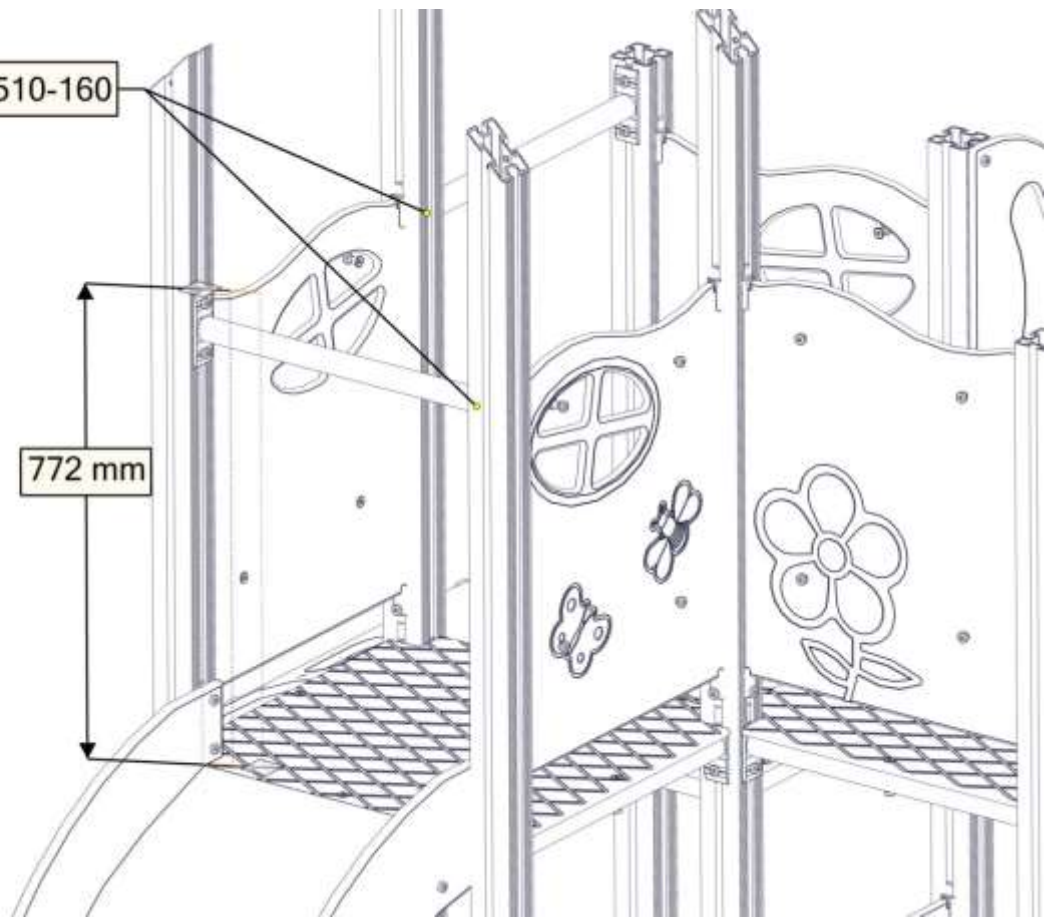

2x

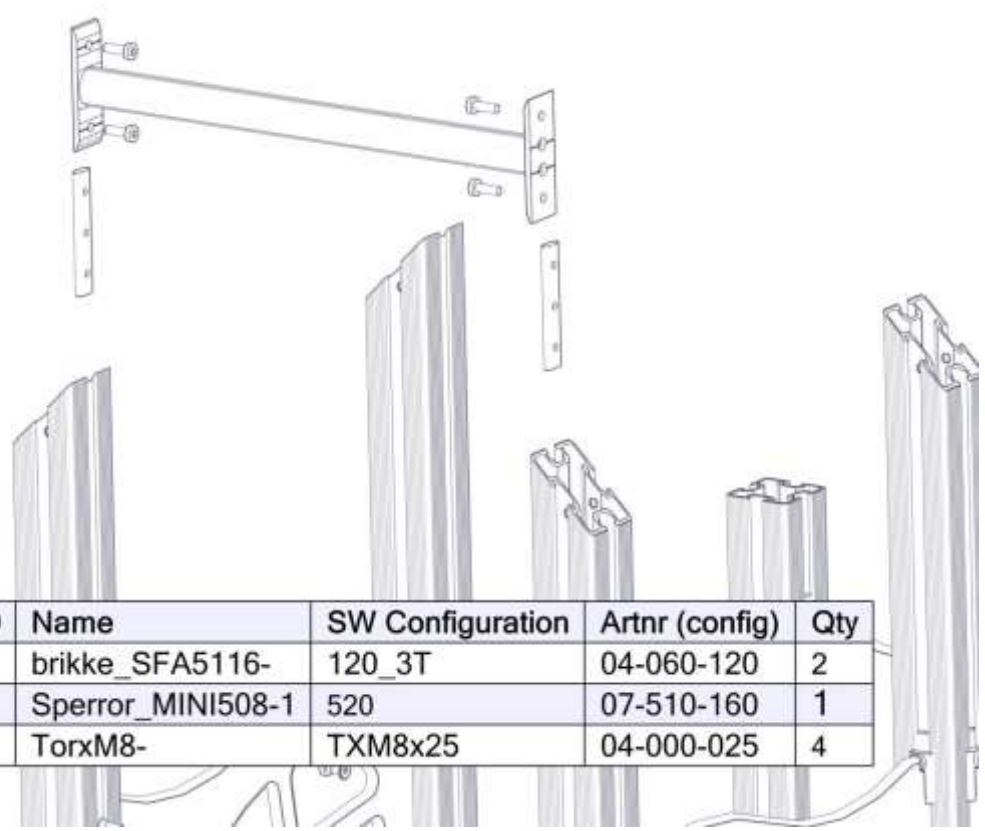

BOM ID	Name	SW Configuration	Artnr (config)	Qty
2	brikke_SFA5116-	120_3T	04-060-120	2
3	Sperror_MINI508-1	520	07-510-160	1
1	TorxM8-	TXM8x25	04-000-025	4



BOM ID	Name	SW Configuration	Artnr (config)	Qty
4	35x35x3-1	11mm	04-070-036	2
3	Skive-	M8	04-050-008	4
2	Mobelknapp-	M8_13_17	04-030-011	4
5	Tak_Miniserie2011-	rod	07-510-105	2
6	Gavelplatemini2011-	Rod	07-510-106	2
1	TorxM8-	TXM8x12	04-000-012	4

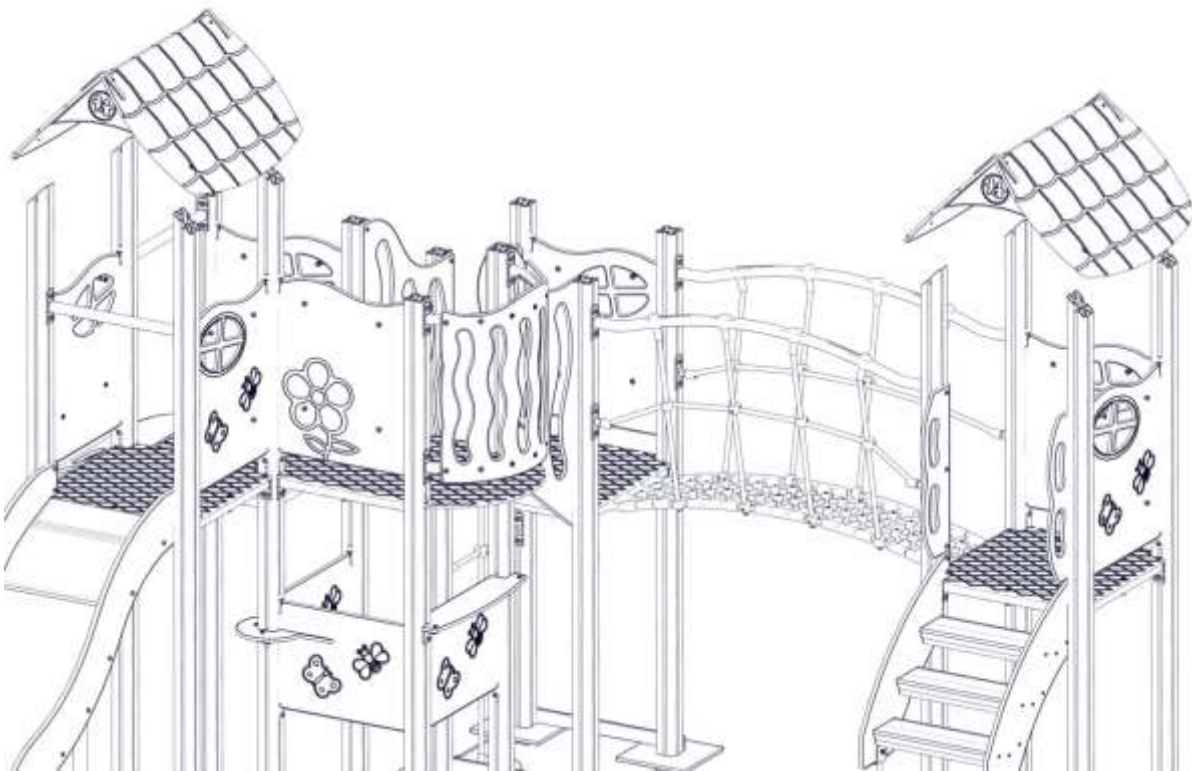

2x

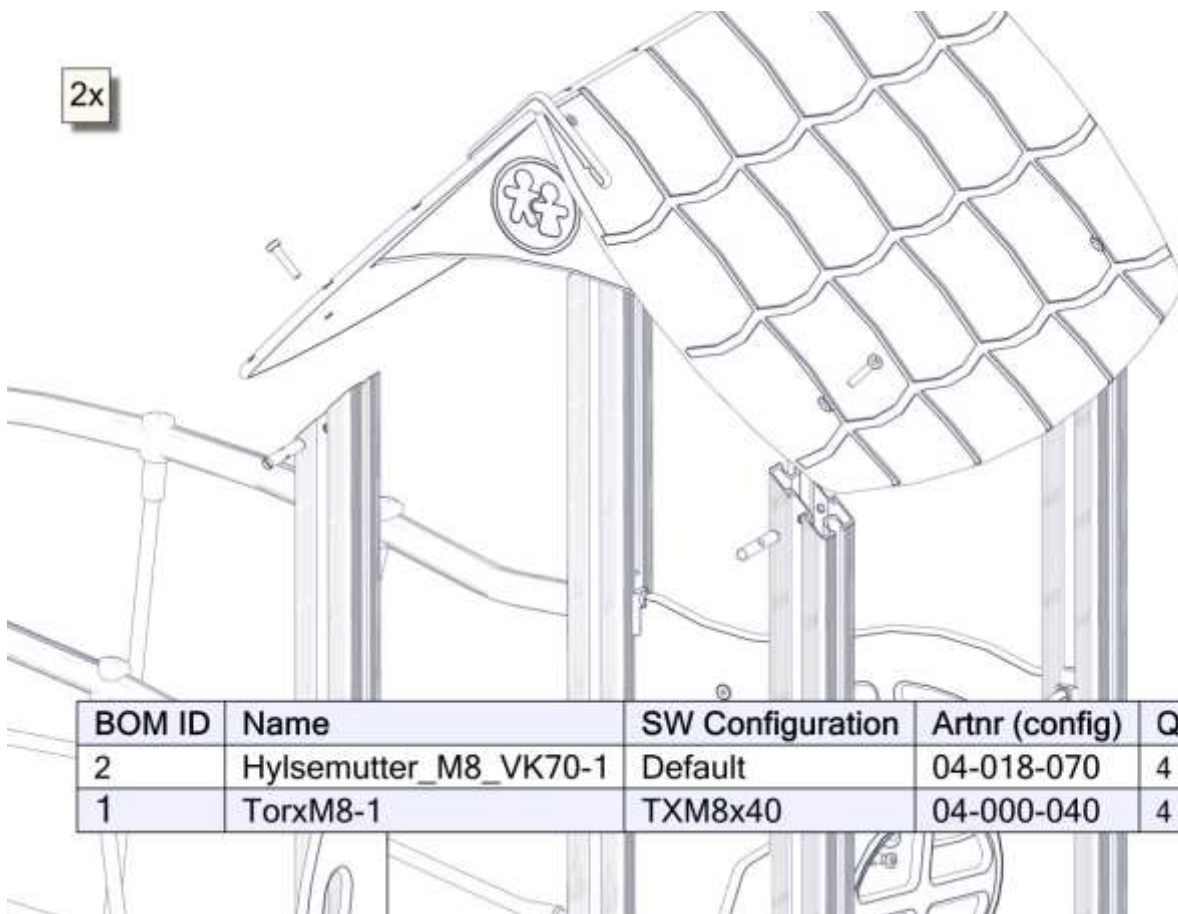



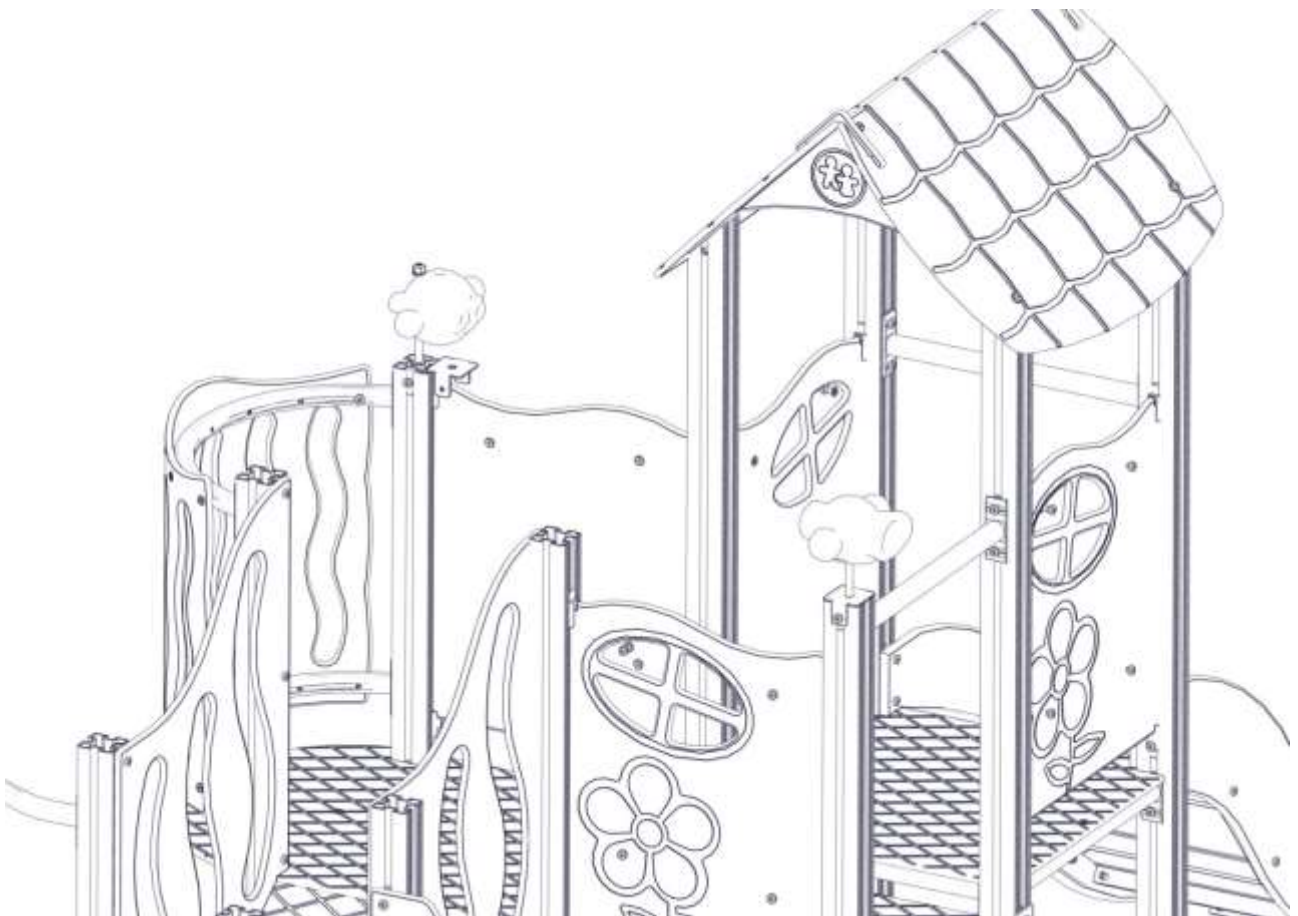
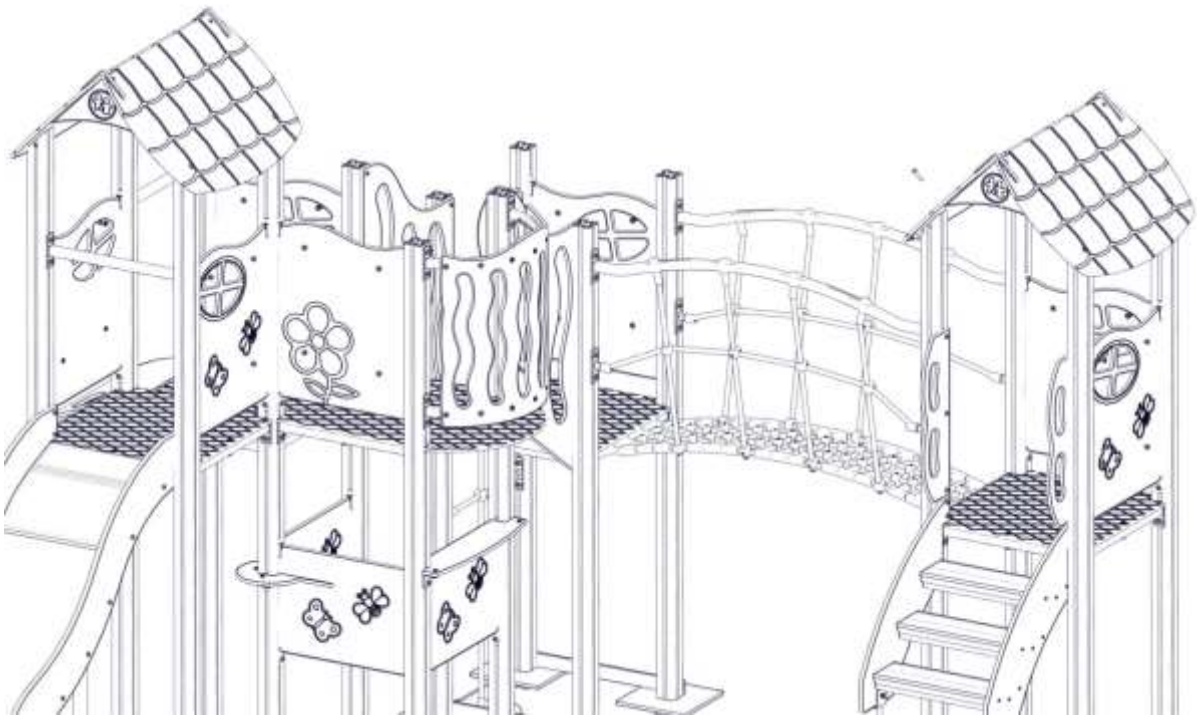

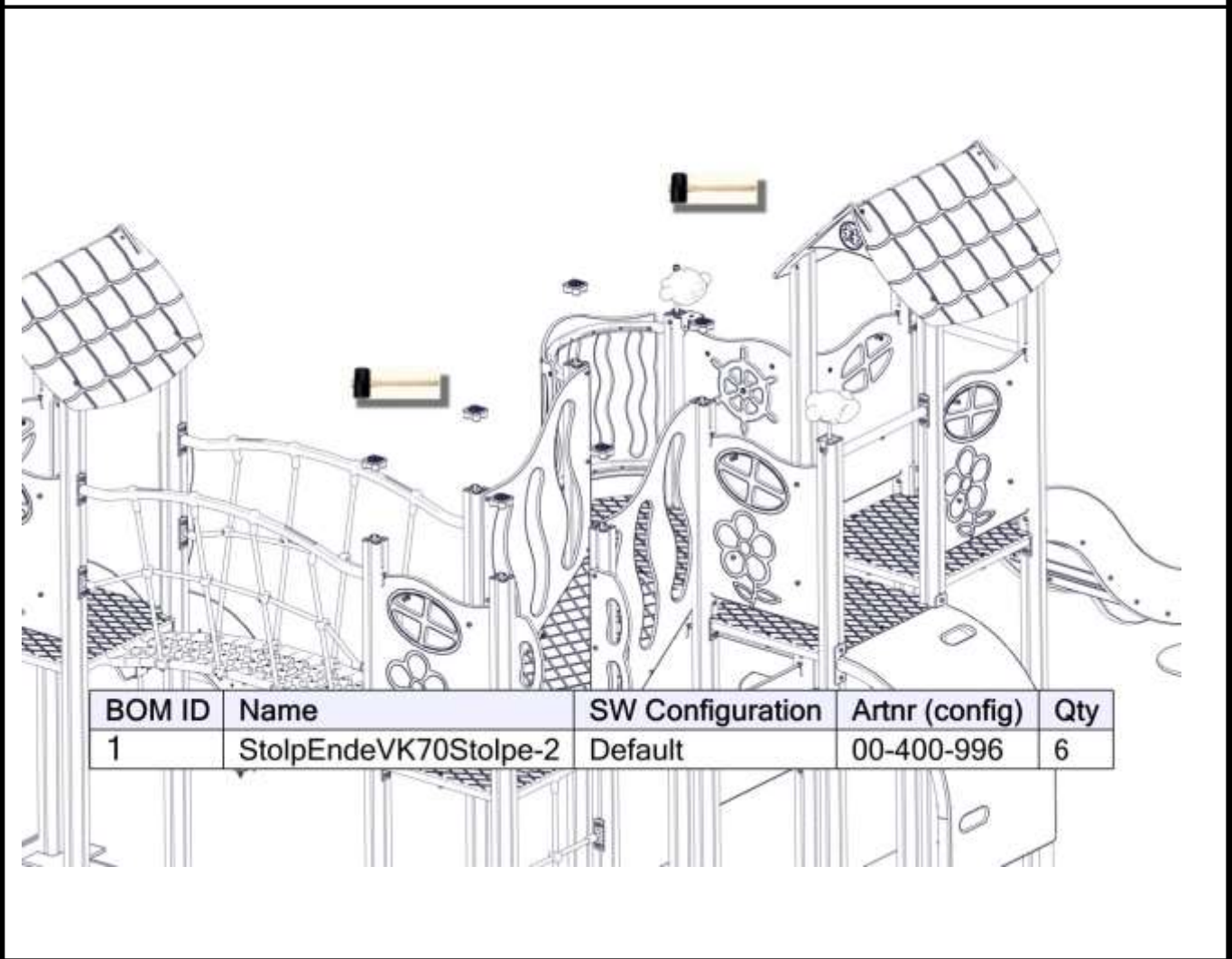
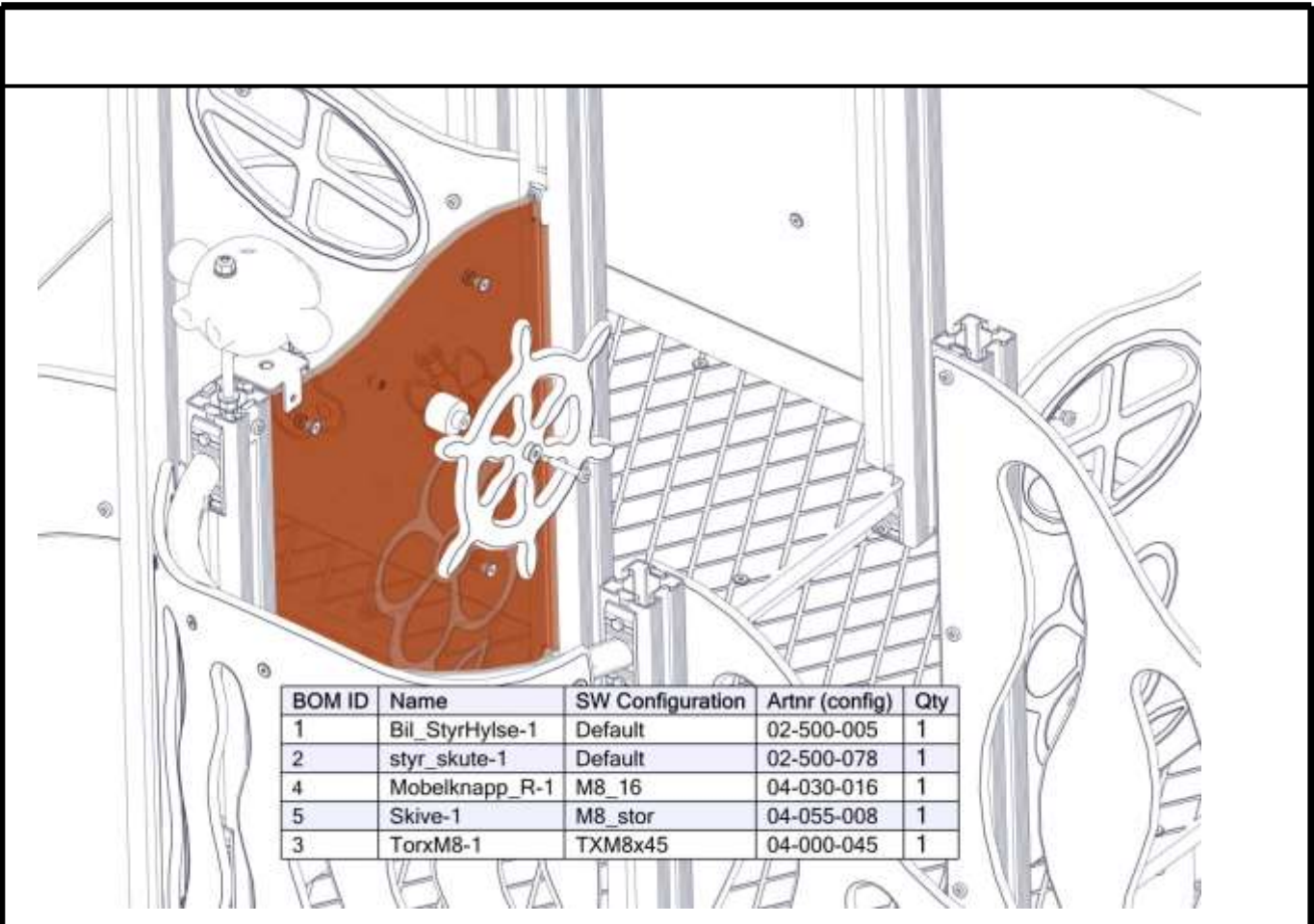







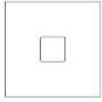















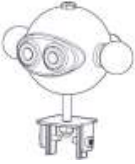

BOM ID	Name	SW Configuration	Artnr (config)	Qty
2	Hylsemutter_M8_VK70-1	Default	04-018-070	4
1	TorxM8-1	TXM8x40	04-000-040	4



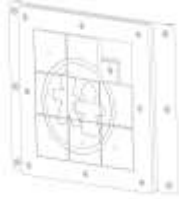

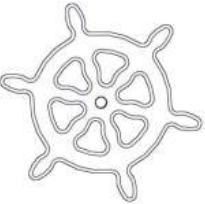
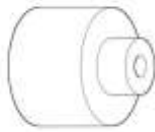
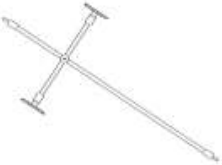













Før utstyret tas i bruk / Before play begins / Innan lekredskapet tas i bruk	
N	<ul style="list-style-type: none"> ● Påse at fallunderlag er utlagt i henhold til gjeldende regler eller vår anbefaling ● Fjern alle monteringshjelpemidler (rester av betong, planker, paller, plast, og lignende) ● Før utstyret tas i bruk, burde man sjekke at det ikke er fare for at anorakksnorer og lignende som kan hekte seg fast noen steder på lekeapparatet. (Vedlagte snor med dobbe (kneledd) kan brukes til å sjekke at dette er i orden. Se vedlagte veiledning for bruk av denne. Dette gjøres for å oppdage eventuelle feilmonteringer.?) ● NB! Bør stå i 2-3 dager før bruk
EN	<ul style="list-style-type: none"> ● Make sure the area and depth of safer surfacing are according to the current standard, or to the manufacturer's recommendation ● Make sure all tools and surplus materials are removed before play begins ● PS! When complete, allow 2-3 days for the concrete to set before use
S	<ul style="list-style-type: none"> ● Kontrollera att fallunderlag är utlagt enligt gällande regler eller vårt rekommendation ● Ta bort alla monteringshjälpmedel (rester av betong, plankor, pallar, plast och liknande) ● Innan lekredskapet används, kontrollera att anoracksnoddar eller kläder/delar av kläder eller liknande inte kan fastna i några delar på redskapet. (Den bipackade "knävringen" kan man med fördel användas för denna kontroll. ● Detta görs för att upptäcka eventuella felmonteringar.)

komponenter		Sign. _____.			
	VK70 2100-600 skrå 07-510-158	4		Endelokk	6
	VK70 1700-600 Skrå 07-510-156	4			
	VK70 1700-600 07-510-150	4		Minisprosse fund L=1250 07-510-202	6
	VK70 1400-600 07-510-157	4		Minisprosse fund L=660 07-510-200	8
	Gulv Mini 520 07-510-102	4		Mini fundament skive 07-510-201	16
					Produktmerking Montert hos Søve
	Vegg 520x600 07-510-120	3		Vegg 520x600 07-510-120	3
	Vegg 520x600 07-510-120 UTEN vindo Med hull styr	1		Sete rund stolpe 07-510-132	1
	Vegg 520x400 07-510-110	1		Vegg 520x400 07-510-112 Med spor	2
	Sperrerør 520 07-510-160	2		Sperrerør gulv 07-510-161	18
	Sperrerør gulv MED 4 hull 07-510-162	2		Plug Spor 00-400-980	2

komponenter		Sign. _____.			
	Utsikt på sper- rerør 07-510-134	1		Gulv Utsikt 05-510-105	1
	Kikkert 35-100-610	1		Megafon 35-100-620	1
	Skrå plato venstre vegg 07-510-321	1		Skrå plato Høyre vegg 07-510-322	1
	Skrå plato 07-510-323	1		Trapp 550 01-290-090	1
	Krabbeplate 07-510-135	1		Søve Slide 25-100-020	1
	Rutsjebane 07-510-310	1		Butikkdiskk 07-510-130	1
	Skute styr 02-500-078	1		Bilstyr hylse 02-500-005	1
	StigTrinn 550 07-510-177	1		Nettbro rett tett 07-510-178	1
	Rør bue nettbru 07-510-164	2		Håndtak dobbel 00-400-172	4

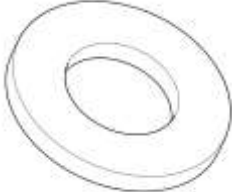
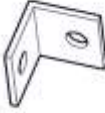
komponenter		Sign. _____				
	Torx M8x12 04-000-012	14	   	Brikke 50-1T 04-060-050	112	
	Torx M8x20 04-000-020	8		Brikke 90-2T 04-060-090	2	
	Torx M8x25 04-000-025	126		Brikke 150-2T 04-060-151	2	
	Torx M8x30 04-000-030	22		Brikke 120-3T 04-060-120	20	
	Torx M8x35 04-000-035	52		Spesialbrikke 04-060-041	40	
	Torx M8x40 04-000-040	8			Låsemutter M8 04-040-008	19
	Torx M8x45 04-000-045	22				
Torx M8x50 04-000-050	1		Stålforankring 00-100-312	4		
	M8x25 Sekskant		8	L=230		
	Møbelknapp M8x13x17 04-030-011	50		Hylsemutter M8 12-70 04-018-070	8	
		04-030-025		16		
	Tak mini 07-510-105	4		Saddelwasher 04-210-010	33	
	GavelplateMini 07-510-106	4				
				Fundamentplate 00-003-106	7	
	Skive M8 04-050-008	39		Vinkel 35x35x35 04-070-036	8	
	Stor Skive M8 04-055-008	1		Vinkel 50x50x50 04-070-050 11mm	2	