

N

Monteringsanvisning

EN

Assembly Instructions

S

Monteringsanvisning

Produkt nr. / Product no. / Produkt nr.

25-200-371**Rød / Grå**

Ord. nr. _____

Dato. _____

Sign. _____

**søve**

Søve AS
Grønnvoldveien 290
3830 Ulefoss - Norway
Tlf: +47 35 94 65 65
www.sove.no

**søve**

Søve AB
EA Rosengrensgatan 32
421 31 Västra Frölunda
Phone: +46 (0)31 773 97 00
www.sove.se

Monteringstips / Assembly Advice / Monteringsstips

N

- Les monteringsanvisningen nøye før montering.
- Monter elementene i rekkefølgen som vist.
- Boltene bør ikke skrues for hardt til før alt er montert, vatret og loddet. Skru så boltene til.
- NB! Ved bruk av drill, kan boltene ryke.
- På grunn av at solen kan gjøre rutsjeflaten veldig varm, bør rutsjebanens utløp vende mot nord-øst eller nord-vest.
- Er lekeutstyret plassert i naturlige ferdselstraséer må området sikres mot gjennomgang.
- Innspringningshinder bør vurderes rundt lekeapparater hvor det er stor bevegelse, f.eks. ved huskestativ.
- Det bør være fritt innsyn til lekeutstyr som er beregnet for barn under 3 år.

NB! Under monteringsarbeidet må utstyr, som ikke er forankret forsvarlig i bakken, sikres slik at det ikke velte.

Området må avstenges under montering av apparatene med sperrebånd eller lignende.

EN

- Read the instruction carefully before assembling the play unit.
- Assemble the components in the sequence shown in these instructions.
Fixings must not be fully tightened during assembly. Before casting the foundations, the structure must be level and plumb, at which point all fixings are tightened.
PS! If use of drill, the bolts may be wrecked.
- Avoid positioning the slide facing due south because of overheating – ideal positions are facing north-east or north-west.
Secure the construction-area to prevent people from walking through it.
- Consider installing barriers around play-equipment which gives rise to a lot of activity – i.e.swings.
- Ensure that clear vision is possible across the play area so that supervision is possible from any position, particularly where children under 3 years of age will be playing.

NB! During assembly of the equipment, ensure that all structures are securely propped, especially when left overnight. Also ensure that equipment is supported

Monteringstips / Assembly Advice / Monteringsstips**S**

- Läs monteringsanvisningen noga före montering.

- Montera delarna i den ordningen som anvisas
- Skruvarna bör inte skruvas för hårt tills allt är monterat, i våg och lodat.









OBS! Används elektrisk skruvdragare, kan bulten gå sönder. Hårdra därför manuellt!

- Solen kan göra att rutchbanan blir väldigt varm. Banans nedfart rekommenderas att vändas i norrlig riktning
- Om lekplatsen placeras vid en gångväg mm bör området säkras mot genomfart av gående och cyklister.
- Insprängningshinder bör placeras runt lekutrustning med stor rörelse, t ex, gungställning.
- Det bör vara fri insyn till lekutrustning beräknat till barn under 3 år.

OBS! Under monteringsarbete bör utrustningen som inte ska förankras i marken, ställs så att den inte kan välta.

Området måste spärras när lekutrustningen byggs upp, med avspärrningsband eller liknande.

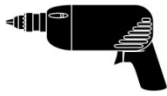
Nødvendig verktøy / Tools required / Nödvändiga verktyg





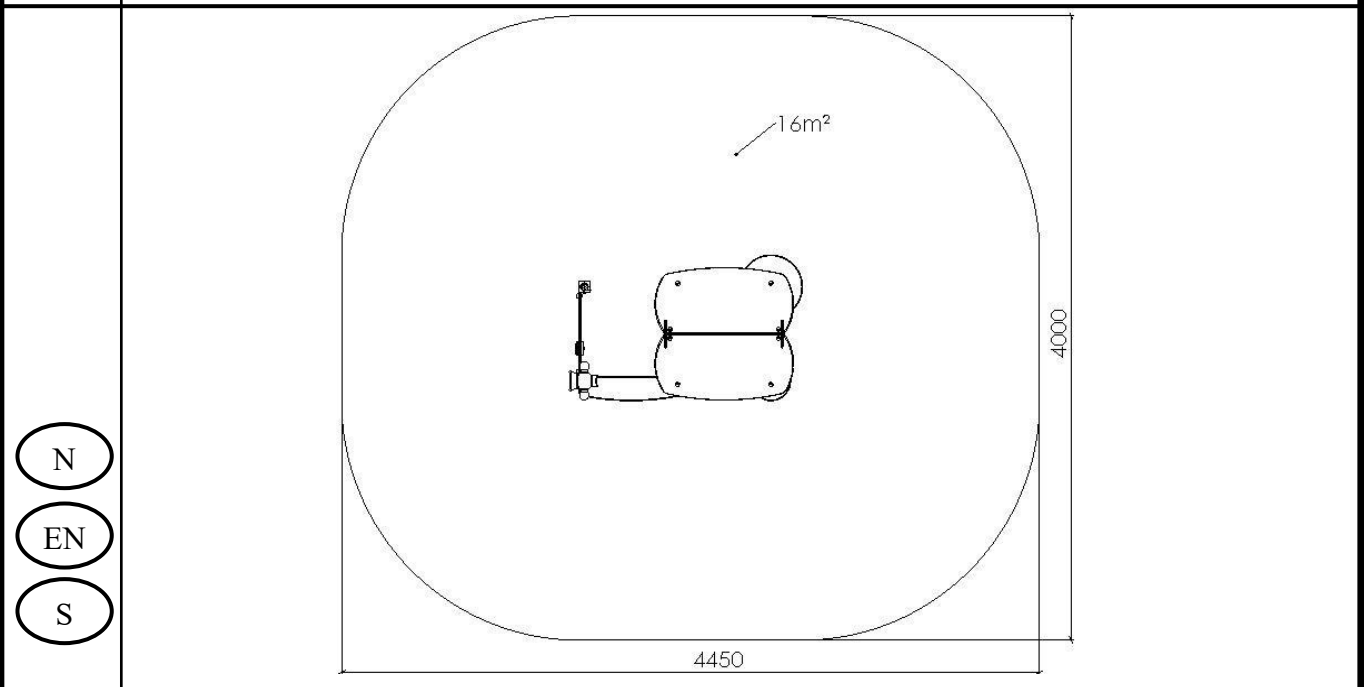

<p>(N)</p> <p>(EN)</p> <p>(S)</p>	<p>(A)</p> 	<p>(B)</p>  <p>Torx Nr 45</p>	<p>(C)</p> <p>5 mm 6 mm</p> 	<p>(D)</p> 	<p>(E)</p> 
		<p>Metermål Metric measure Tumstock</p> 	<p>Ø11mm Bor Ø11mm Drill Ø11mm Borr</p> 	<p>Merkebånd Mark ribbon Märkeband</p> 	<p>13 + 17mm</p> 

Nødvendig antall personer / Number of persons required / Rekommenderad antal personer

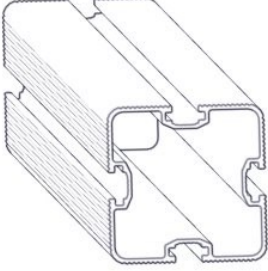





Anbefalt arealbehov ved montering / Recommended working space / Rekommenderad arealbehov vid montering



Boltepakker for / Boltpackage for / Bultpaket för		Sign. _____		
Lovisa m/gulv Rød-Grå 25-200-371	Navn	Artnr/ dimensjon	Ant	Lev
	Stolpe 70 x70 Skrå L = 1650 (400-1250) Sort	07-510-152	4	
	Stolpe 70 x 70 L = 1300 (400-900) Sort	SFA5123/1	2	
	Vegg Standard med spor 520 x 400 Rød	07-510-532K (se egen del- montering)	1	
	Vegg med vindu, spor med karm 520 x 665 Rød	07-510-512K (se egen del- montering)	1	
	Vegg med postkasse 520 x 400 Rød	07-510-534K (se egen del- montering)	1	
	Vegg med spill 520 x 665 Rød	07-510-514K (se egen del- montering)	1	
	Vegg standard 520 x 400 Rød	07-510-530K (se egen del- montering)	1	

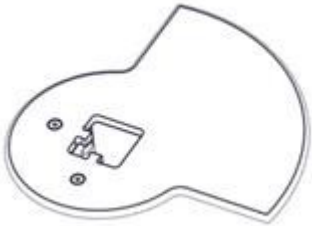
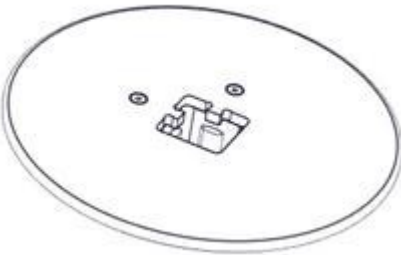
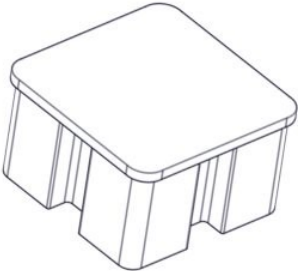

Boltepakker for / Boltpackage for / Bultpaket för





Sign. _____

Lovisa m/gulv, Rød-Grå 25-200-371	Navn	Artnr/ dimensjon	Ant	Lev
	Sete rundt stolpe 70 x 70 Grå	07-510-551K (se egen del- montering)	1	
	Bord rundt stolpe 70 x 70 Grå	07-510-552K (se egen del- montering)	1	
	Endelokk 70 x 70 stolpe Sort	00-400-996	1	
	Butikkdisk L = 520 Grå	07-510-550K (Se egen del- montering)	1	
	Tak Steelmat / Rød	07-510-500K (Se egen del- montering)	1	
	Megafon med feste 70 x 70 Blå	35-100-620K (se egen del- montering)	1	

Boltepakker for / Boltpackage for / Bultpaket för

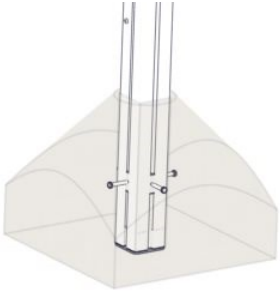
Sign. _____.

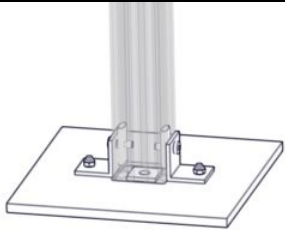
Lovisa m/ gulv, Rød-Grå 25-200-371	Navn	Artnr/ dimensjon	Ant	Lev
	Produktmerke	00-100-400 (montert hos Søve)	0	
	Mini gulv dobbelt 1230x684 Grå	07-510-584K (se egen del- montering)	1	
	Sperrerør rett L=520 for gulv Sort	07-510-161K (Se egen del- montering)	7	

Boltepakker for / Boltpackage for / Bultpaket för		Sign. _____		
Lovisa m/gulv, Rød-Grå 25-200-371	Navn	Artnr/ dimensjon	Ant	Lev
	Fundament Støp			
	Støpefundament 70 x 70 stolpe	00-003-112K (se egen del- montering)	6	
	Sperrerør standard L = 520 Sort	07-510-160K (se egen del- montering)	2	
	Fundament Nedgraving			
	Fundamentskive 70 x 70 stolpe	07-510-207K (se egen del- montering)	6	
	Sperrerør standard L = 520 Sort	07-510-160K (se egen del- montering)	2	

Fundamentering med betong // Foundation concrete // Förankring med betong

(N) Støtdempende materialer

(EN) Impact attenuating materials

(S) Støtdämpande material Ref NS-EN 1176-1 §4.2.8.5

(N) (EN) (S)
Bakkenivå Ground level Marknivå

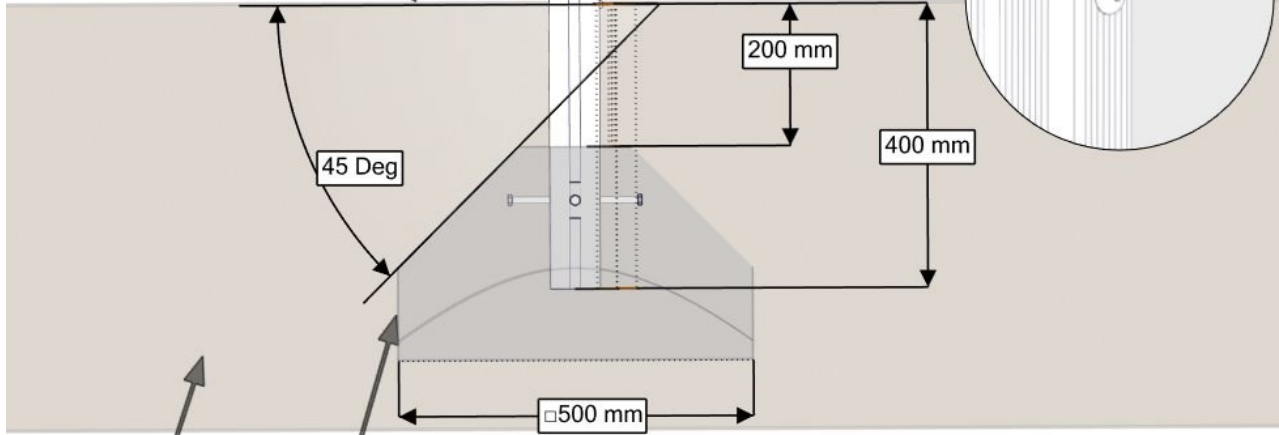

(N) Komprimert masse Betong

(EN) Compressed mass Concrete

(S) Komprimerad massa Betong

Fundamentering uten betong // Foundation without concrete // Förankring utan betong

(N) Støtdempende materialer Ref NS-EN 1176-1 §4.2.8.5

(EN) Impact attenuating materials

(S) Støtdämpande material

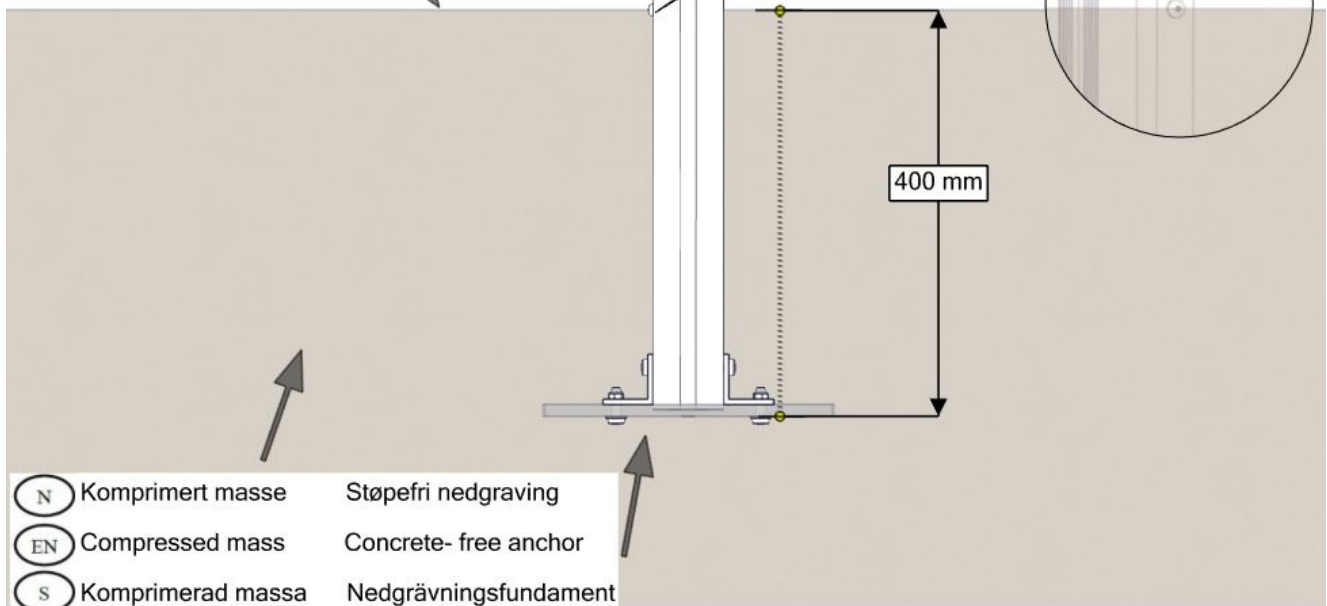

(N) (EN) (S)
Bakkenivå Ground level Marknivå



(N) Komprimert masse Støpefri nedgraving

(EN) Compressed mass Concrete-free anchor

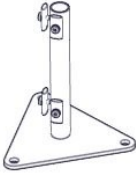
(S) Komprimerad massa Nedgravningsfundament

Boltepakker for / Boltpackage for / Bultpaket för		Sign. _____.		
Lovisa m/gulv, Rød-Grå 25-200-371	Navn	Artnr/ dimensjon	Ant	Lev
	Overflate- montering			
	Fundament 70x70stolpe for be- tongdekke	00-003-129k	6	
	Stolpe kappes Stolpe 70 x70 Skrå L = 1650 (400-1250) Sort	07-510-152	4	
	Stolpe 70 x 70 L = 1300 (400-900) Sort	SFA5123/1	2	
	Torx M8x20 Bruk korte bolter på nedeste festepunkter	04-000-020	24	

Overflatemontering / surface mounting / ytmontering

Ref
NS-EN 1176-1
§4.2.8.5

(N) (EN) (S)
Bakkenivå Ground level marknivå

Tykkelse/Thickness

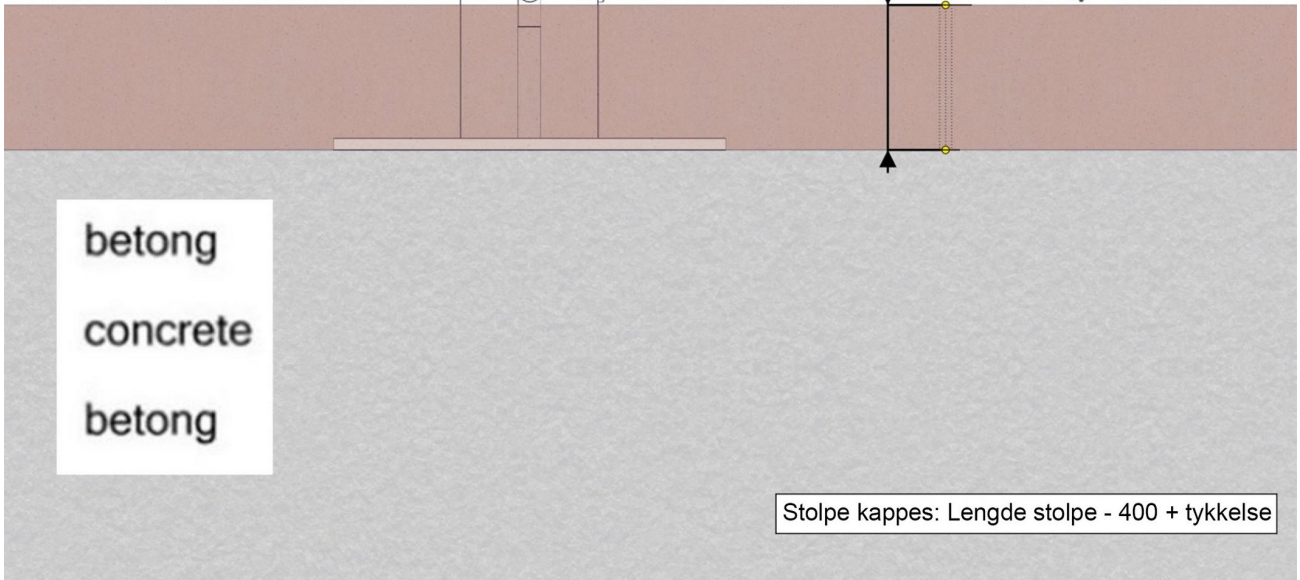

Torx M8x20

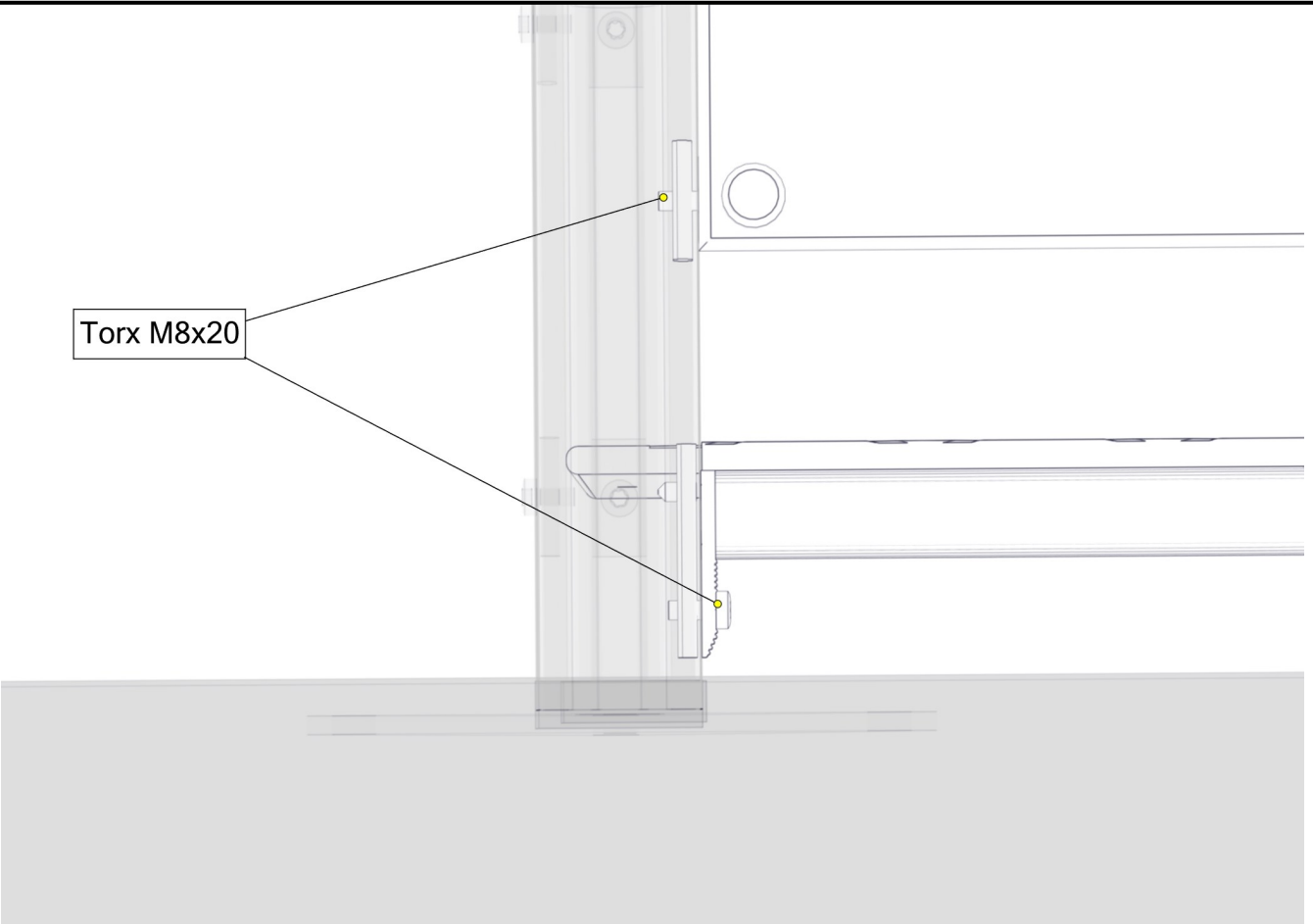

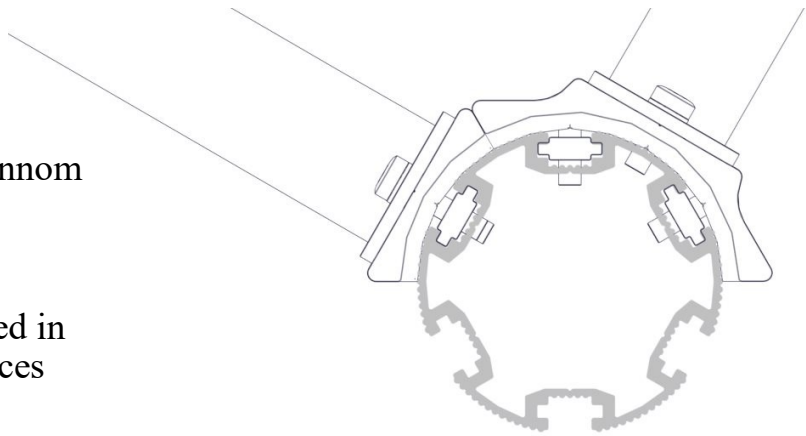
<p>N Bolten skrues HELT igjennom aluminiumen. Maks moment: 30Nm</p> <p>EN The bolt must be tightened in to the post, so that it peirces the aluminium Max torque: 30Nm</p> <p>S Bulten skuvas HELT genom aluminiumen. Maks vridmoment: 30Nm</p>				
NO	Betongkvalitet			
SE	Betongkvalitet	C25/30		
EN	Concrete quality			
NO	Menge betong			
SE	Mängd betong		0,6	m ³
EN	Amount of concrete			
NO	Fundament størrelse			
SE	Stiftelsestorlek		0,5 x 0,5 x 0,4	m
EN	Foundation size			
NO	For sikkerhet må fundamentene med sand eller myk jord være minst 50% større i areal			
SE	För säkerheten måste grunden med sand eller mjuk jord vara minst 50% större i området			
EN	For safety, the foundations with sand or soft soil must be at least 50% larger in area			
NO	Tyngste element			
SE	Tyngsta element	07-510-584	12,5	Kg
EN	Heaviest element			
NO	Største element			
SE	Största element	07-510-152 07-510-584	1,65 x 0,07 x 0,070 1,23x0,684x0,012	m
EN	Biggest element			

Fallhøyder / Free height of fall / Fallhöjder

Fallhøyde < 0,6 meter

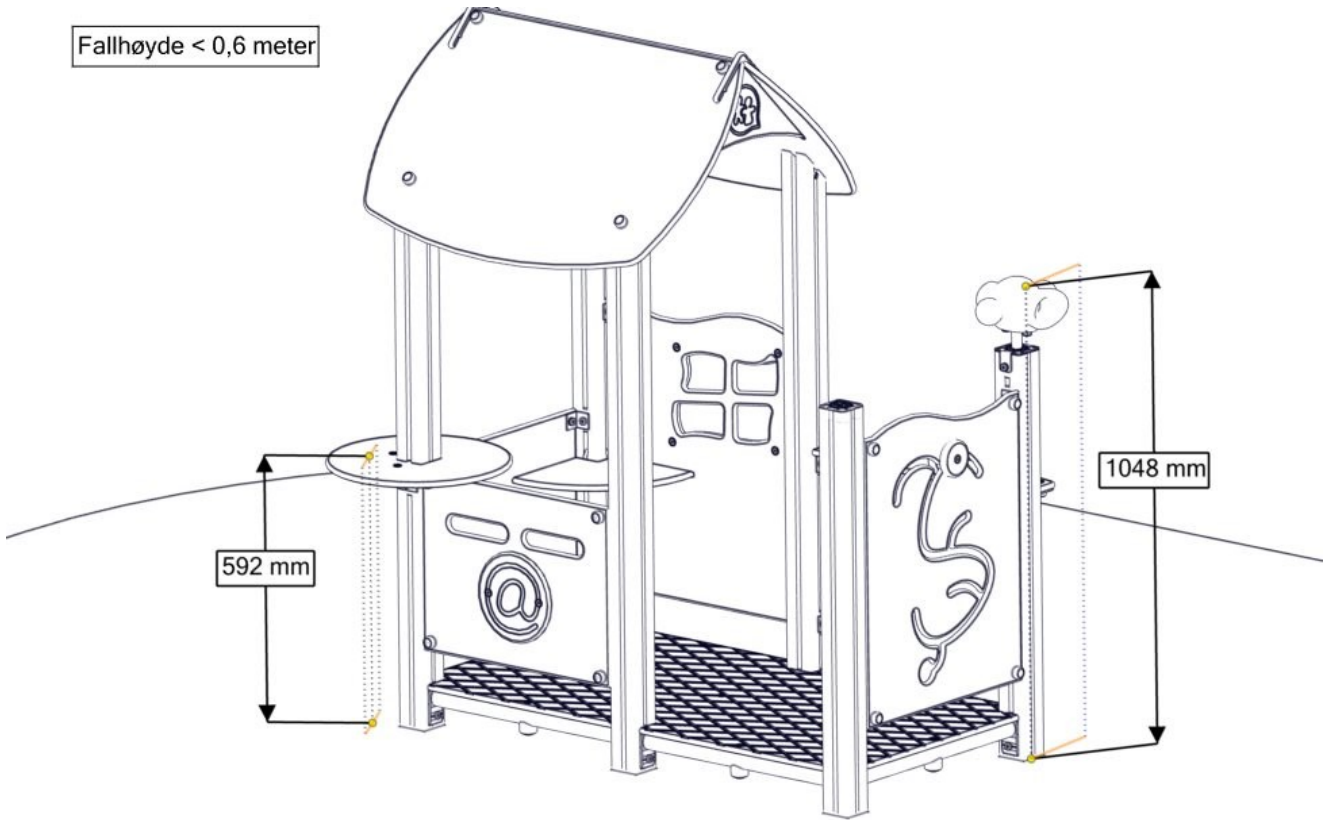

Sikkerhetszone / Safety zone / Säkerhetszon

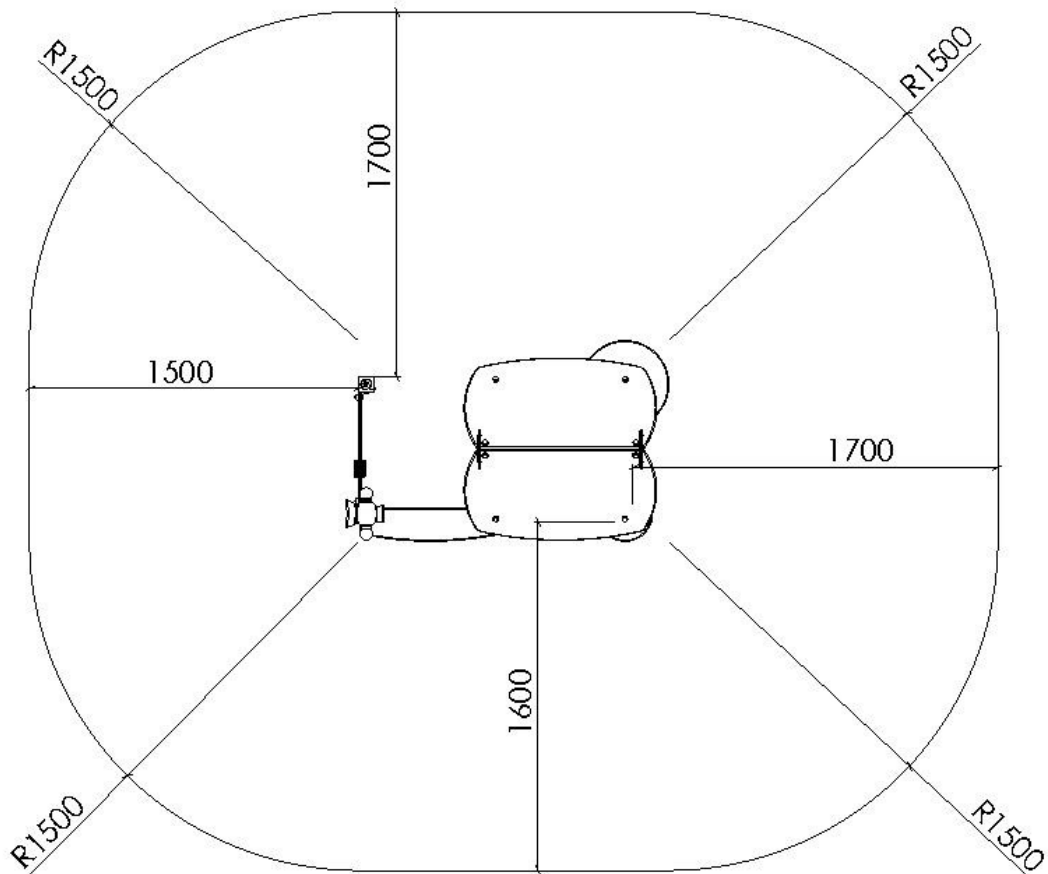

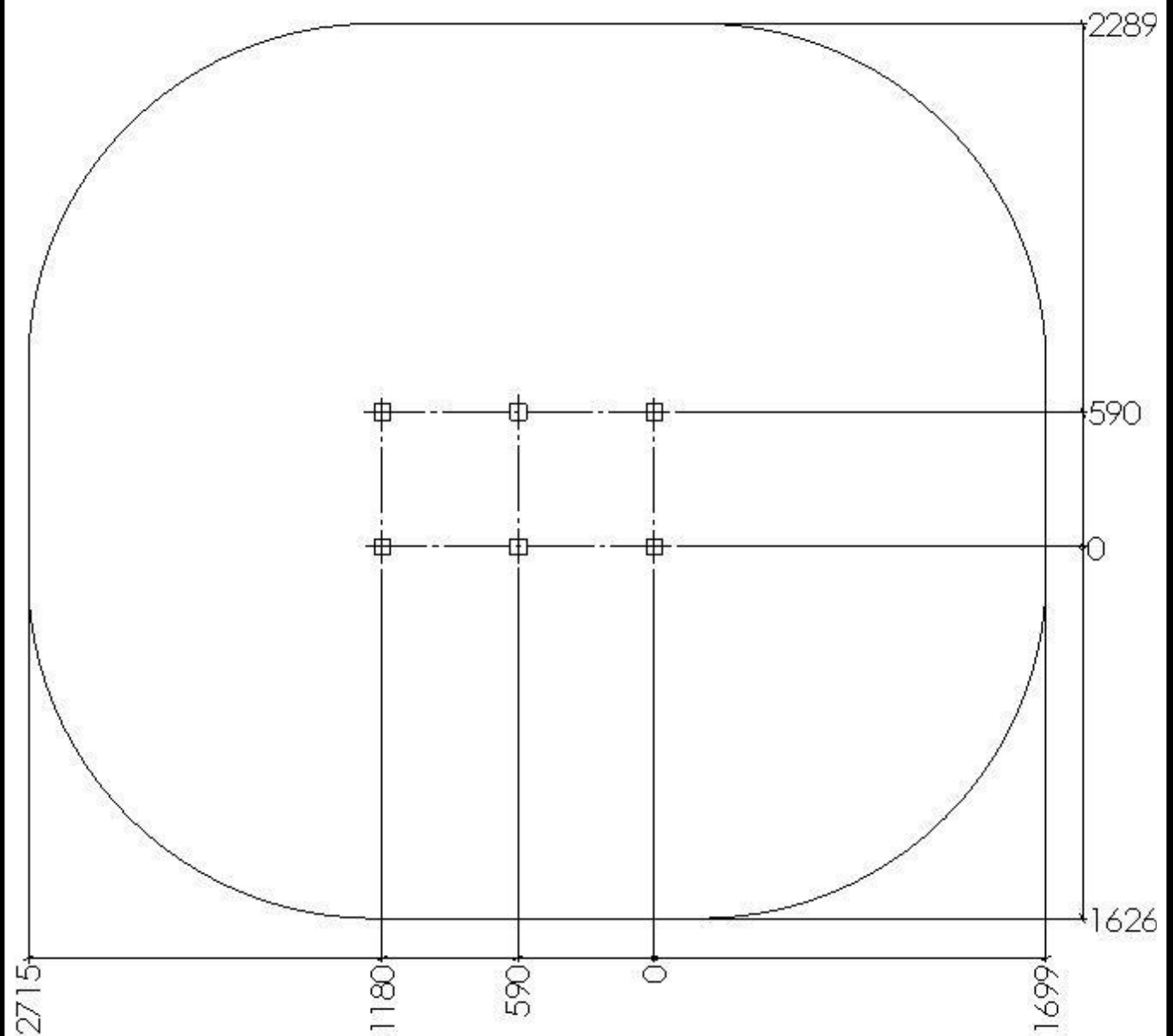
Plassering av forankringer / Ground plan / Placering av förankringar

N

Alle mål er oppgitt i millimeter

EN

Scale measured in mm

S

Alla mått är i millimeter.

Montering av lekeapparatet / Assembly instructions / Montering av lekredskapet

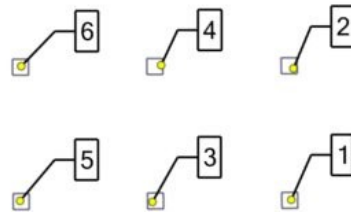
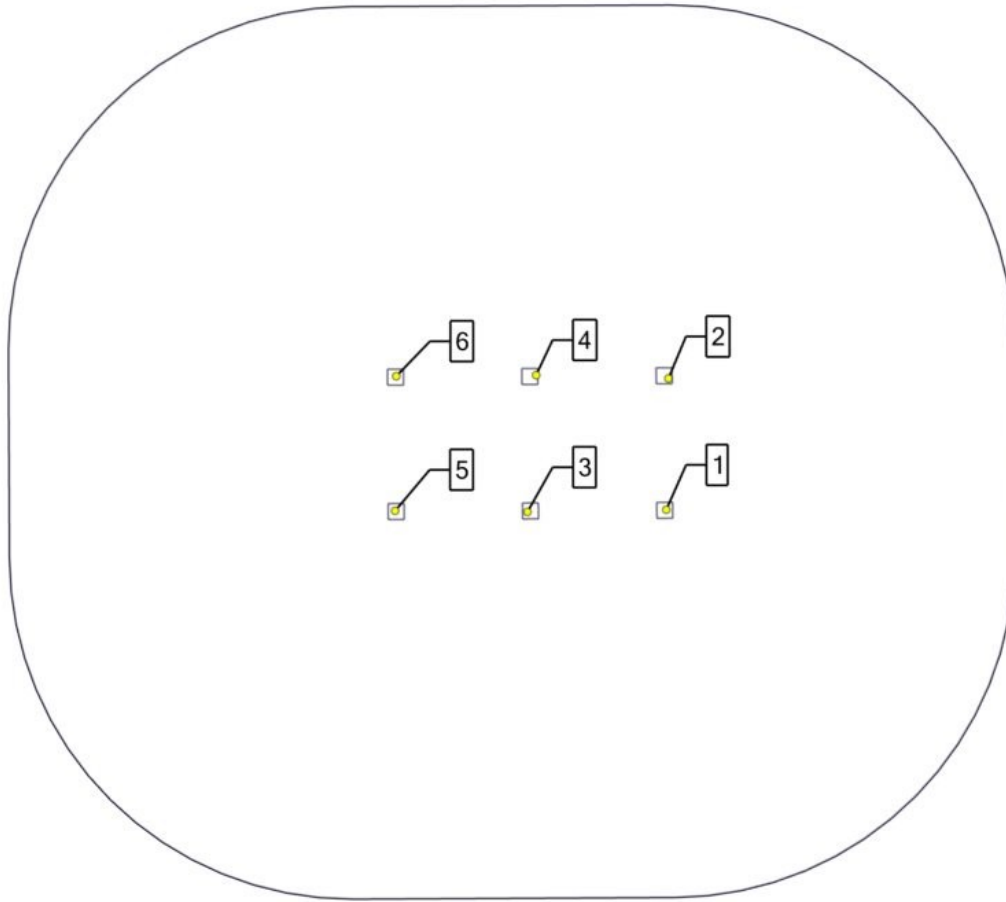

Se separat delmontering for detaljer
See separate assembly for details
Se separata delmontering för detaljer

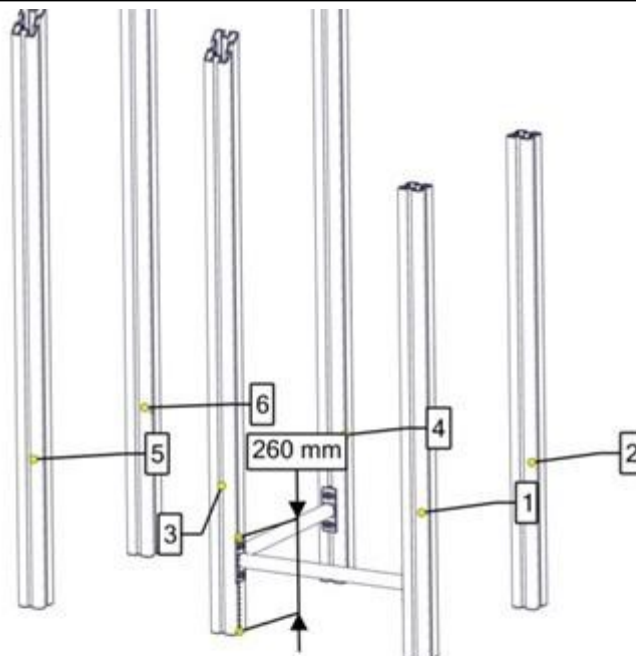

Part Name	Article nr.	Qty
Stolpe 70x70 L=1650 skrå	07-510-152	4
Sperrerør STD L=520	07-510-160K	2
Stolpe 70x70 L=1300mm	SFA5123/1	2

Montering av lekeapparatet / Assembly instructions / Montering av lekredskapet

Se separat delmontering for detaljer
See separate assembly for details
Se separata delmontering för detaljer

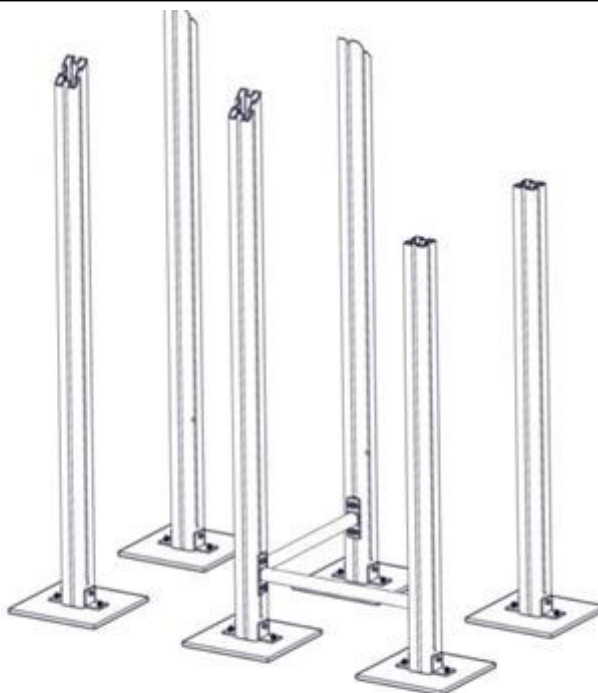

Part Name	Article nr.	Qty
Fundament skive 70x70 stolpe	07-510-207K	6

Se separat delmontering for detaljer
See separate assembly for details
Se separata delmontering för detaljer

Montert hos Søve
Assembled at Søve
Monterad hos Søve

07-510-161

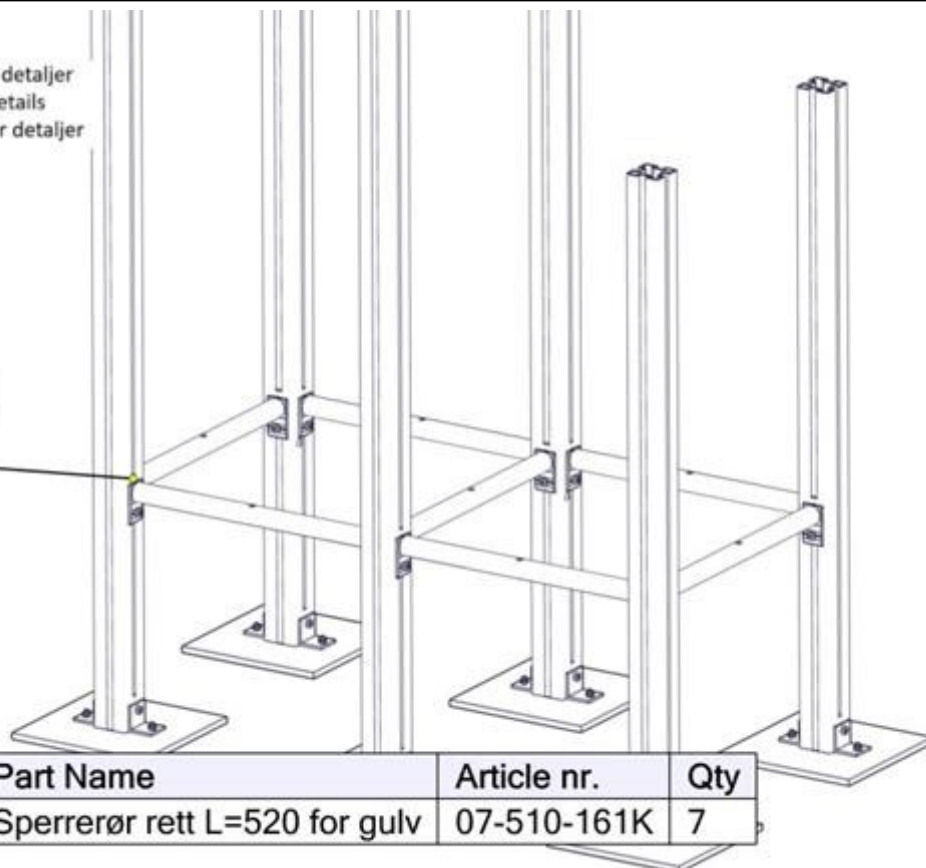

Part Name	Article nr.	Qty
Sperrerør rett L=520 for gulv	07-510-161K	7

Montering av lekeapparatet / Assembly instructions / Montering av lekredskapet

Se separat delmontering for detaljer
See separate assembly for details
Se separata delmontering för detaljer

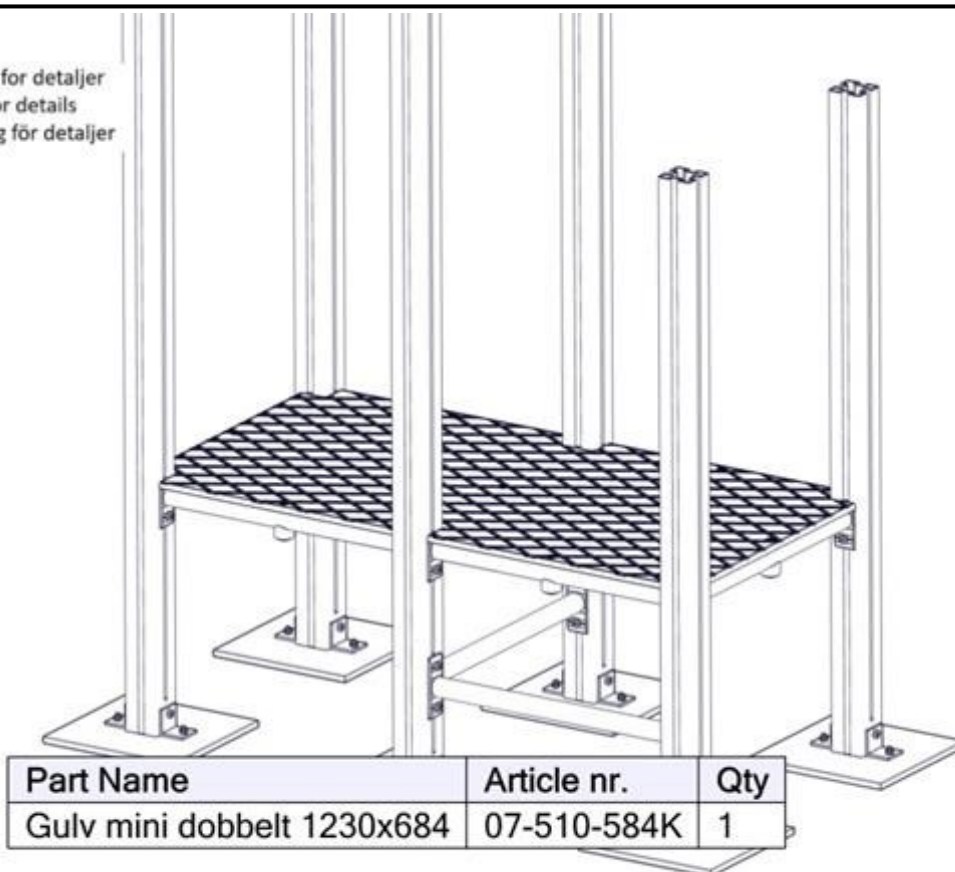

Se separat delmontering for detaljer
See separate assembly for details
Se separata delmontering för detaljer

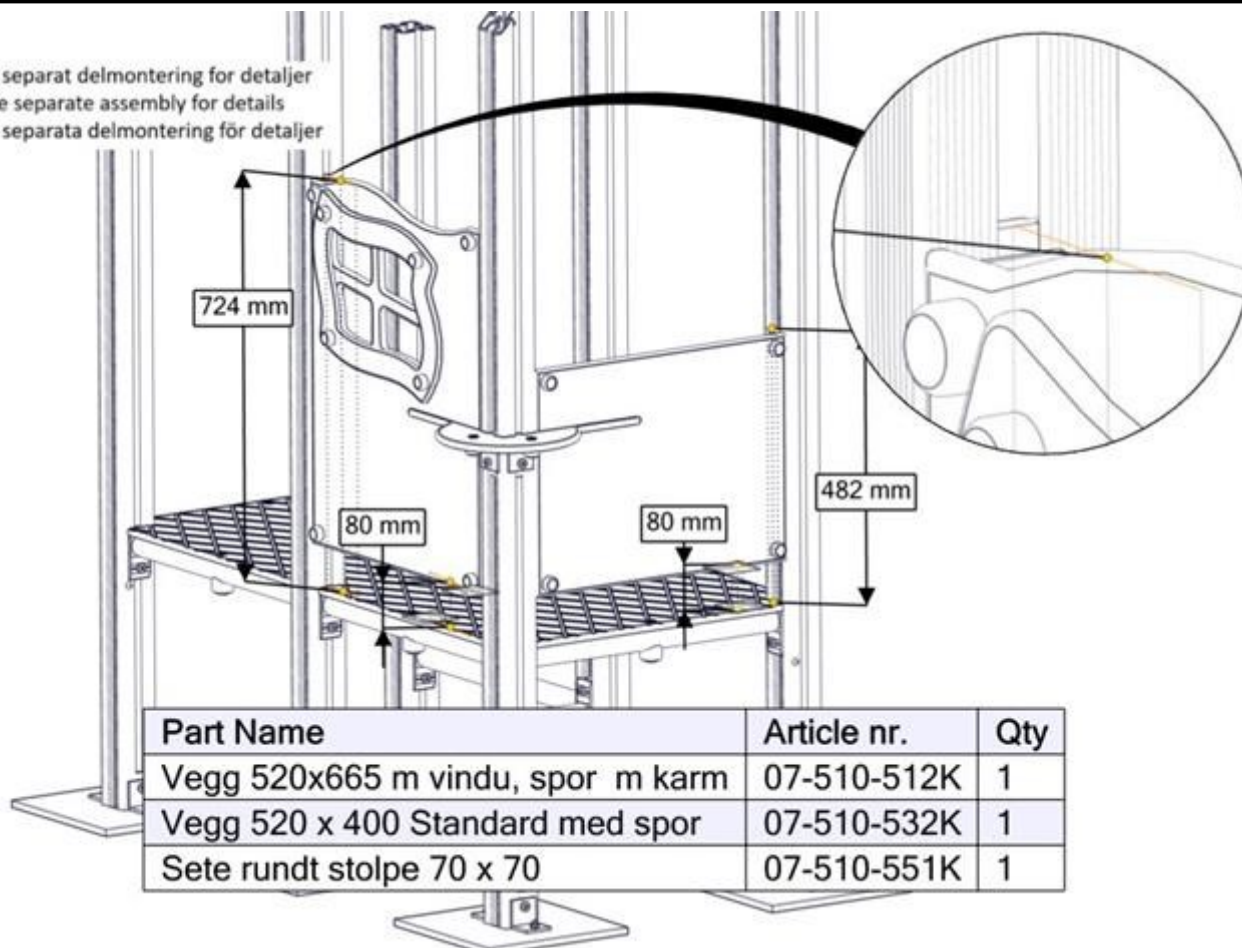

Montering av lekeapparatet / Assembly instructions / Montering av lekredskapet

Se separat delmontering for detaljer
See separate assembly for details
Se separata delmontering för detaljer

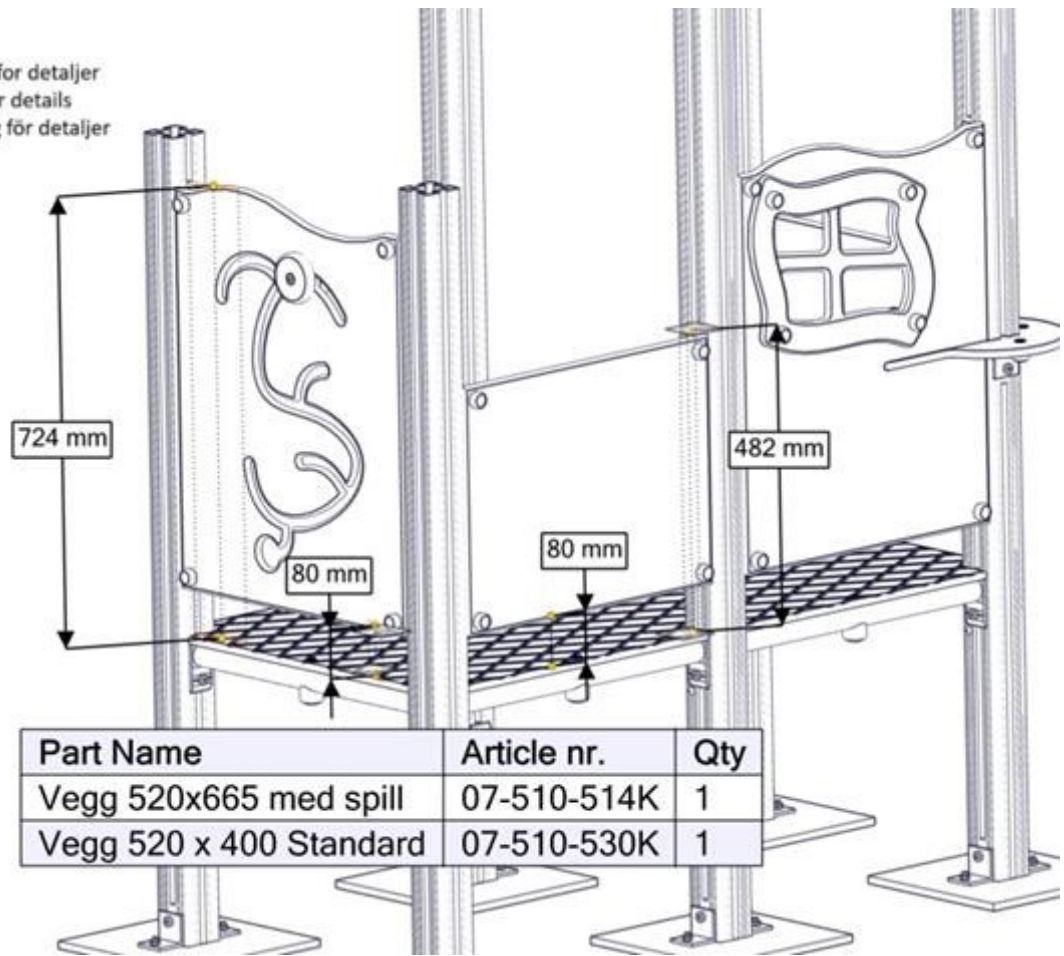

Se separat delmontering for detaljer
See separate assembly for details
Se separata delmontering för detaljer

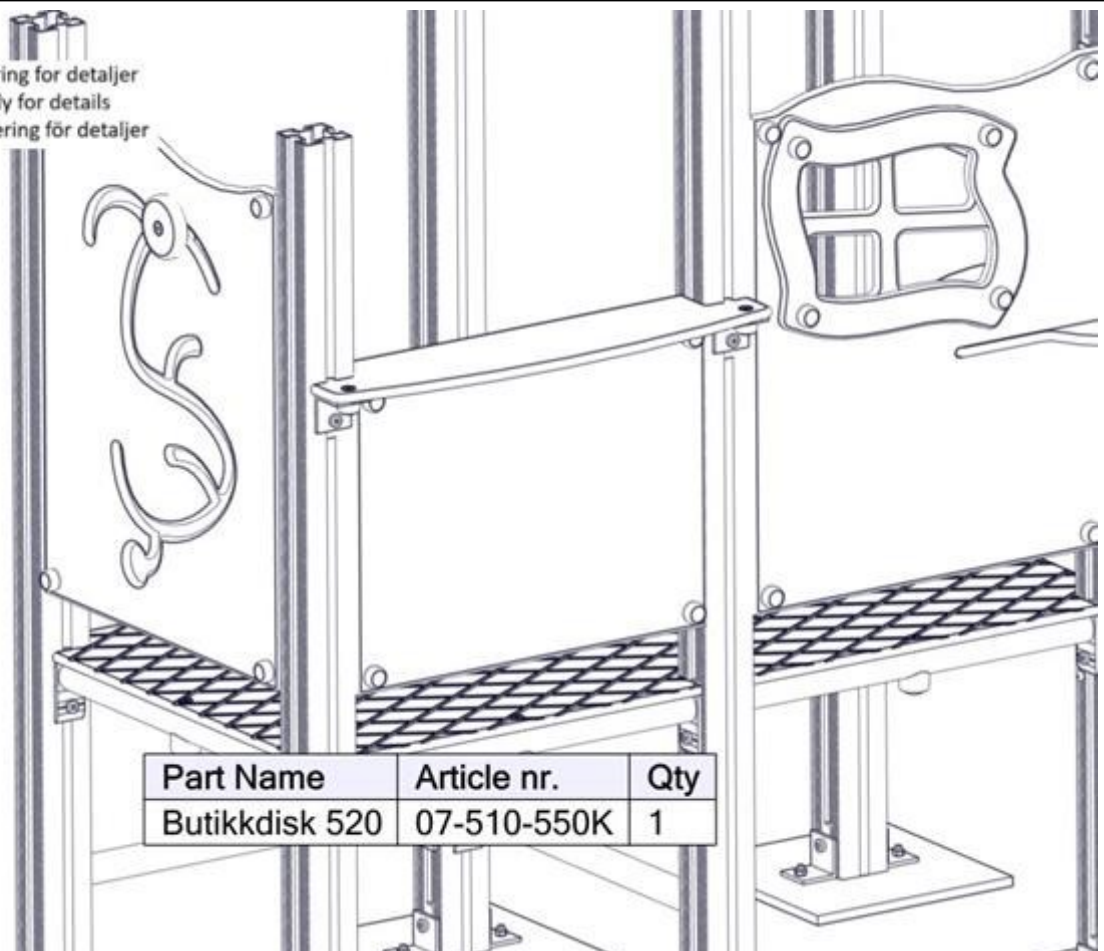

Montering av lekeapparatet / Assembly instructions / Montering av lekredskapet

Se separat delmontering for detaljer
See separate assembly for details
Se separata delmontering för detaljer

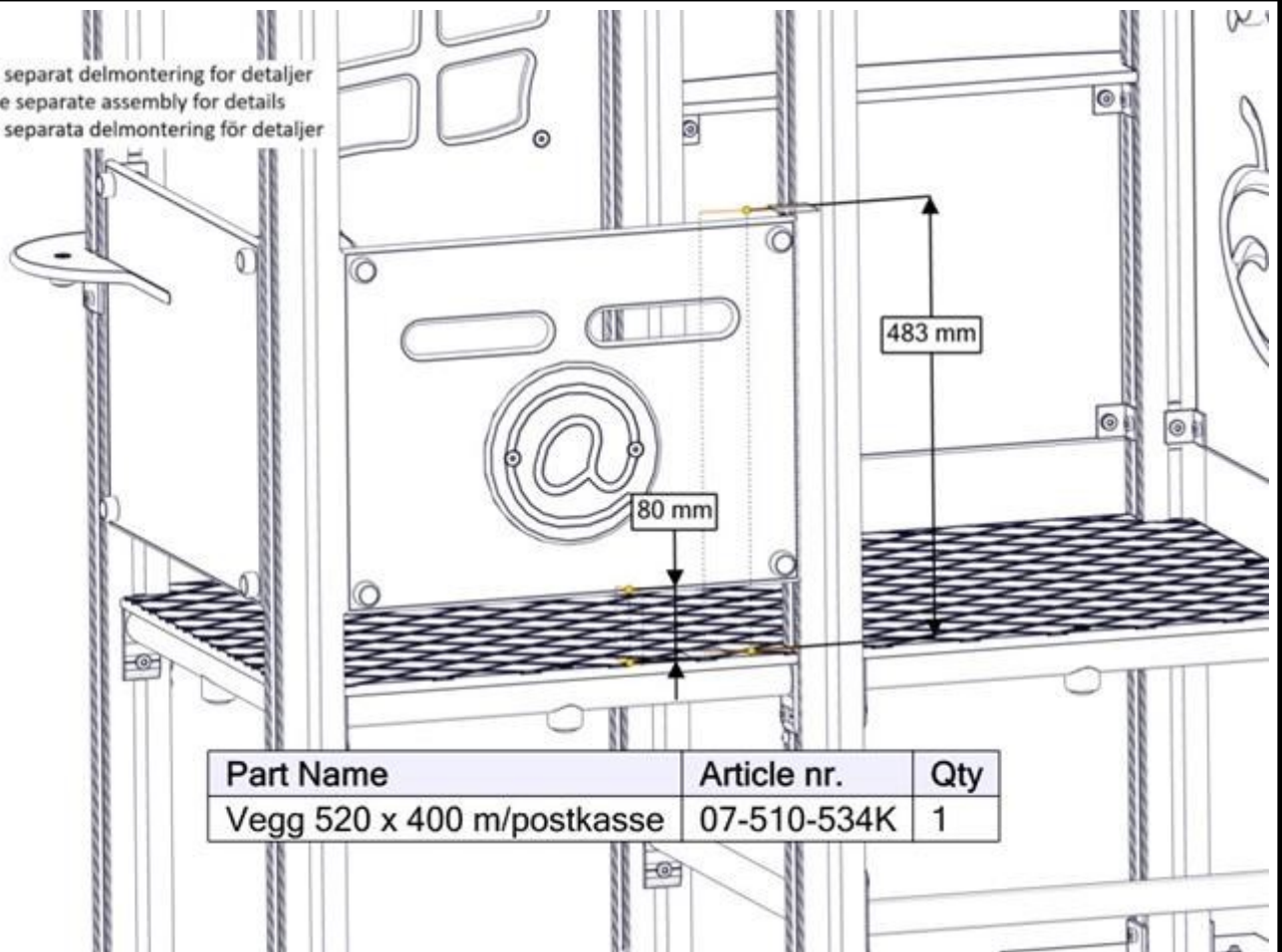

Part Name	Article nr.	Qty
Vegg 520 x 400 m/postkasse	07-510-534K	1

Se separat delmontering for detaljer
See separate assembly for details
Se separata delmontering för detaljer

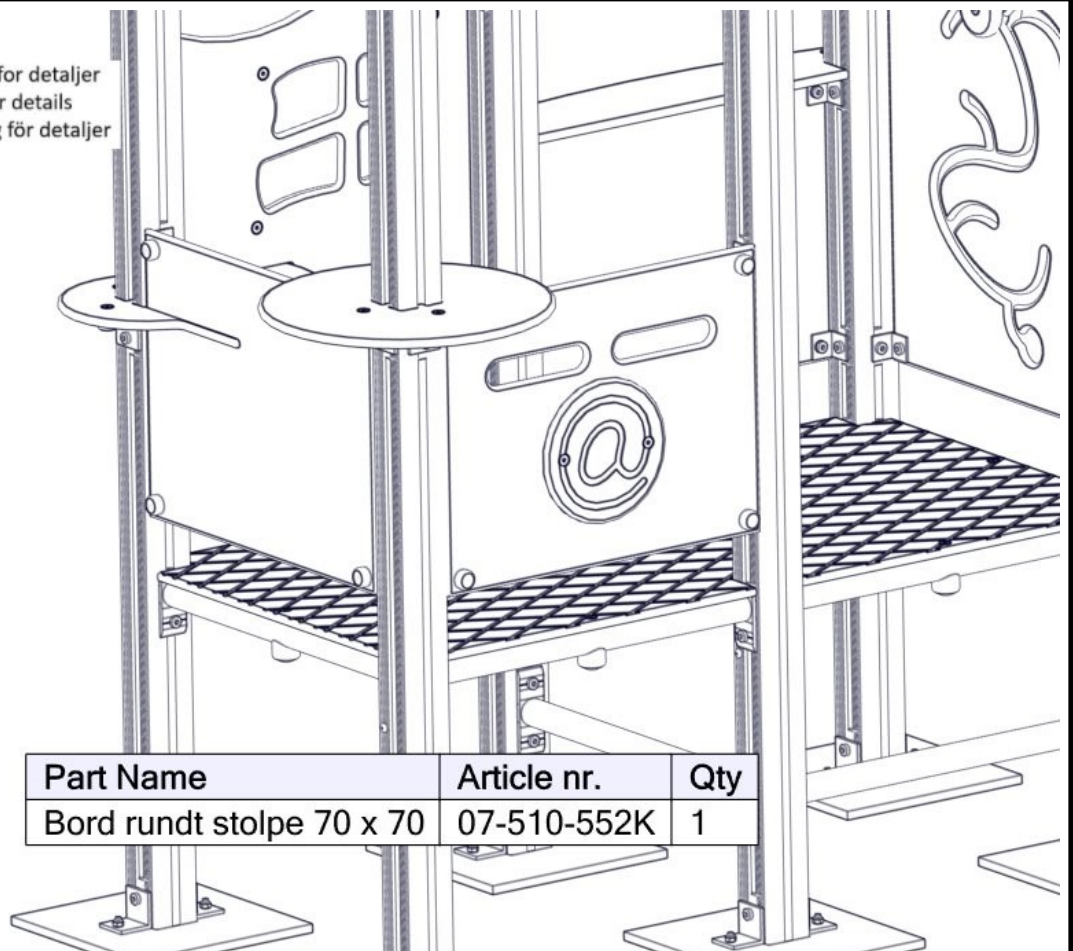





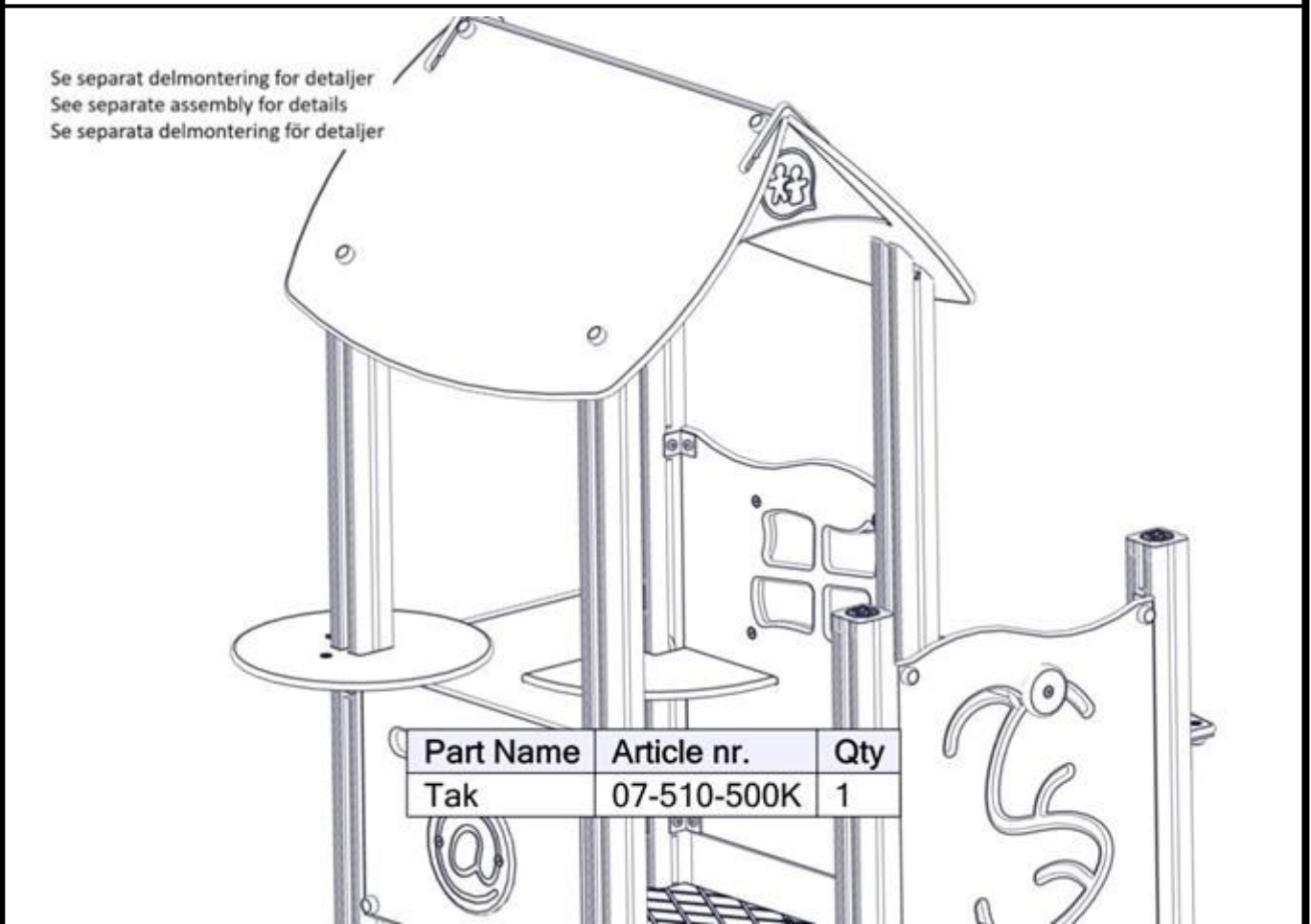
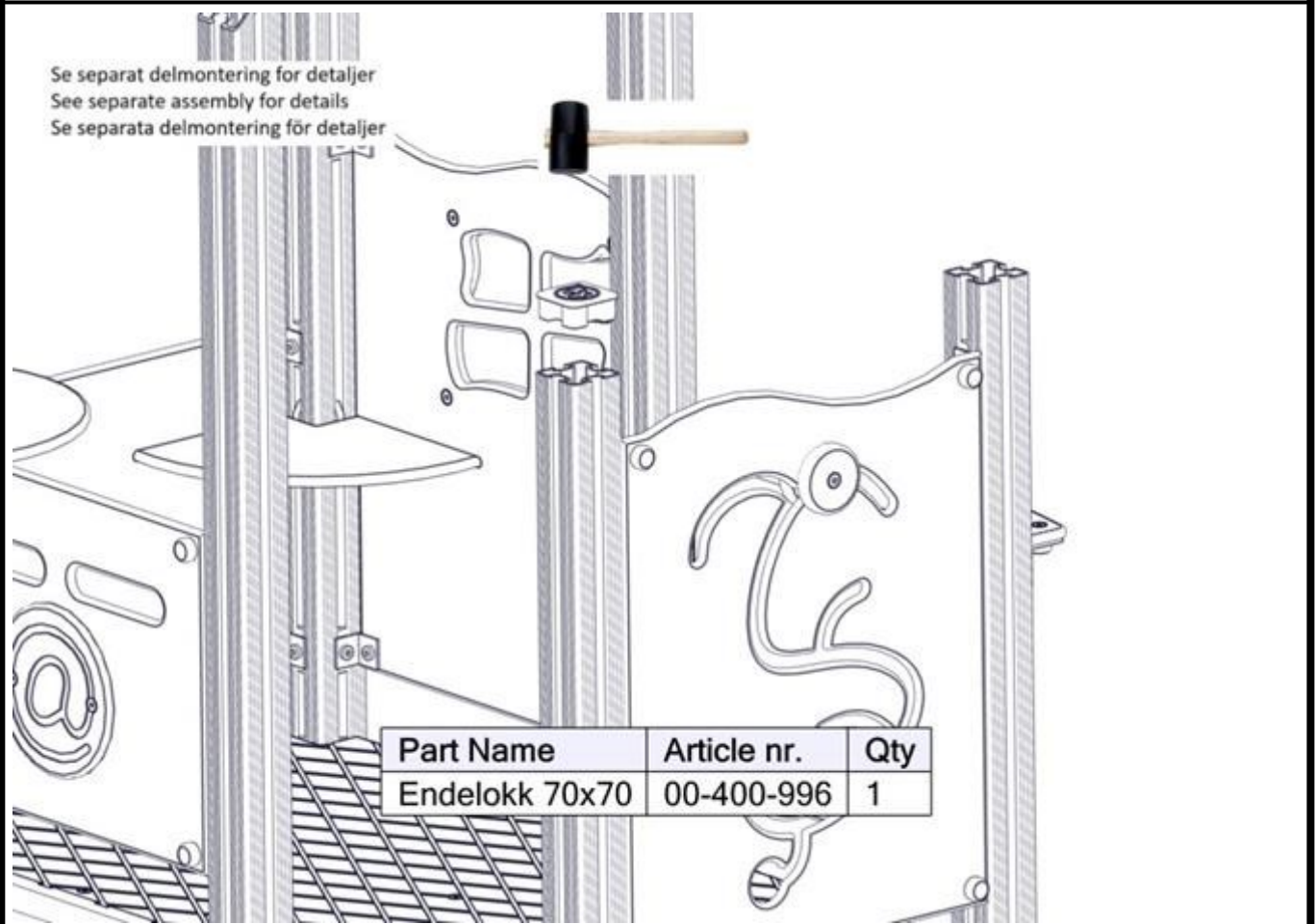

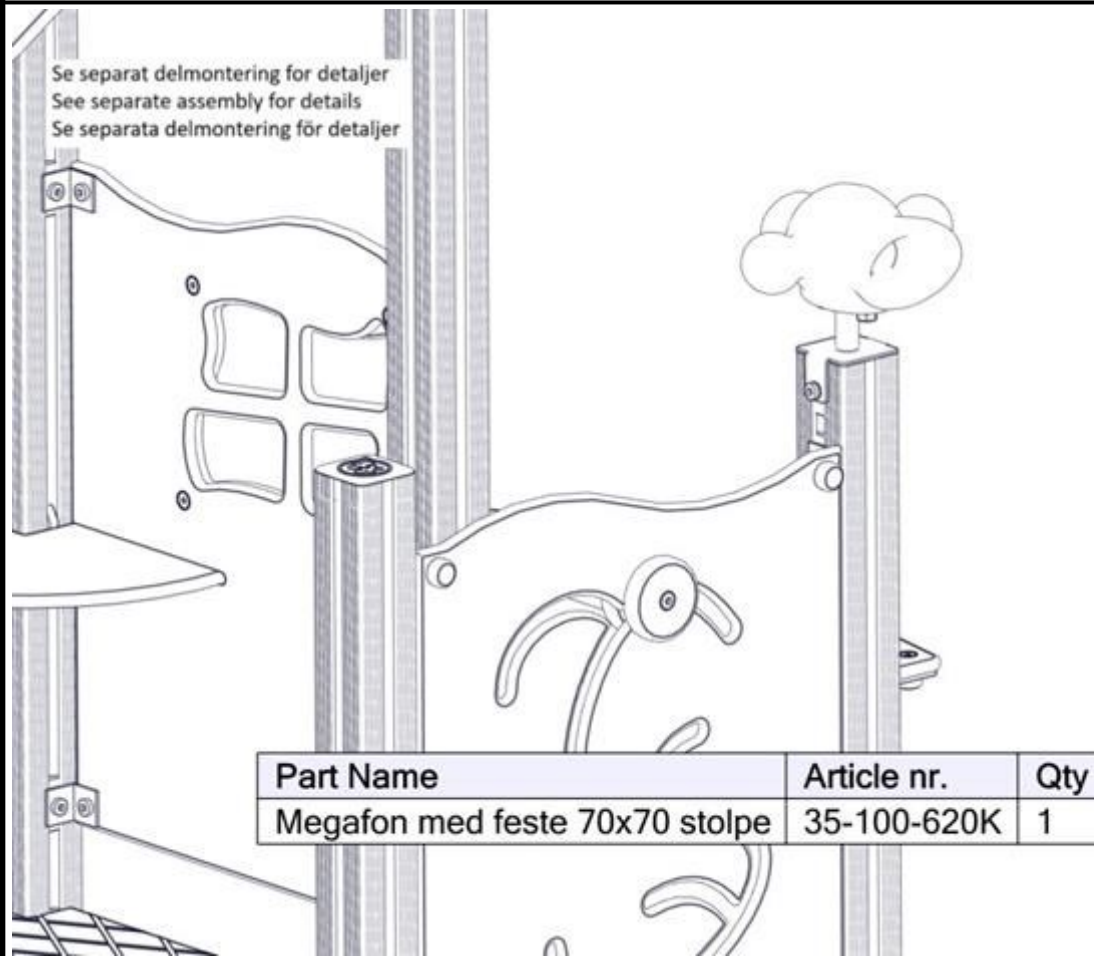
Part Name	Article nr.	Qty
Bord rundt stolpe 70 x 70	07-510-552K	1

Montering av lekeapparatet / Assembly instructions / Montering av lekredskapet

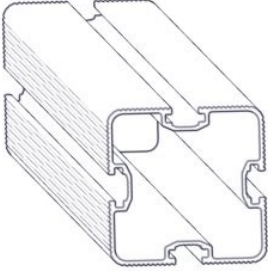





Montering av lekeapparatet / Assembly instructions / Montering av lekredskapet

Før utstyret tas i bruk / Before play begins // Innan lekredskapet tas i bruk	
N	<ul style="list-style-type: none"> ● Påse at fallunderlag er utlagt i henhold til gjeldende regler eller vår anbefaling ● Fjern alle monteringshjelpemidler (rester av betong, planker, paller, plast, og lignende) ● Før utstyret tas i bruk, burde man sjekke at det ikke er fare for at anorakksnorer og lignende som kan hekte seg fast noen steder på lekeapparatet. (Vedlagte snor med dobbe (kneledd) kan brukes til å sjekke at dette er i orden. Se vedlagte veiledning for bruk av denne. Dette gjøres for å oppdage eventuelle feilmonteringer.?) ● NB! Bør stå i 2-3 dager før bruk
EN	<ul style="list-style-type: none"> ● Make sure the area and depth of safer surfacing are according to the current standard, or to the manufacturer's recommendation ● Make sure all tools and surplus materials are removed before play begins ● PS! When complete, allow 2-3 days for the concrete to set before use
S	<ul style="list-style-type: none"> ● Kontrollera att fallunderlag är utlagt enligt gällande regler eller vårt rekommendation ● Ta bort alla monteringshjälpmedel (rester av betong, plankor, pallar, plast och liknande) ● Innan lekredskapet används, kontrollera att anoracksnoddar eller kläder/delar av kläder eller liknande inte kan fastna i några delar på redskapet. (Den bipackade "knävringen" kan man med fördel användas för denna kontroll. ● Detta görs för att upptäcka eventuella felmonteringar.)

Boltepakker for / Boltpackage for / Bultpaket för		Sign. _____		
Lovisa m/gulv Rød-Grå 25-200-371	Navn	Artnr/ dimensjon	Ant	Lev
	Stolpe 70 x70 Skrå L = 1650 (400-1250) Sort	07-510-152	4	
	Stolpe 70 x 70 L = 1300 (400-900) Sort	SFA5123/1	2	
	Vegg Standard med spor 520 x 400 Rød	07-510-532K (se egen del- montering)	1	
	Vegg med vindu, spor med karm 520 x 665 Rød	07-510-512K (se egen del- montering)	1	
	Vegg med postkasse 520 x 400 Rød	07-510-534K (se egen del- montering)	1	
	Vegg med spill 520 x 665 Rød	07-510-514K (se egen del- montering)	1	
	Vegg standard 520 x 400 Rød	07-510-530K (se egen del- montering)	1	

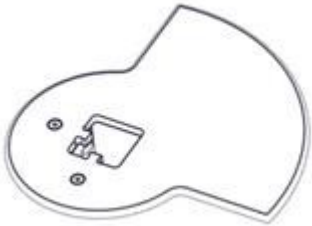
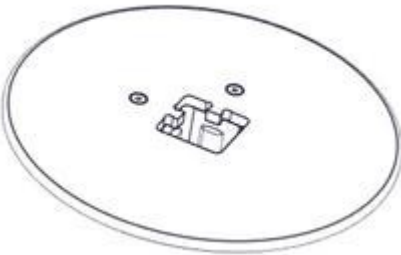
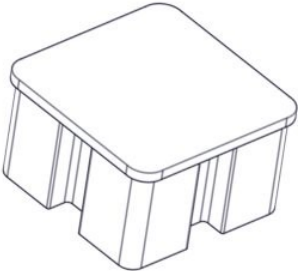

Boltepakker for / Boltpackage for / Bultpaket för





Sign. _____

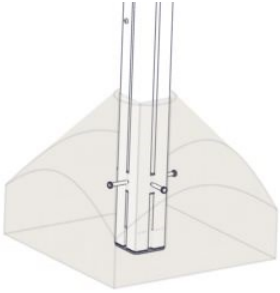

Lovisa m/gulv, Rød-Grå 25-200-371	Navn	Artnr/ dimensjon	Ant	Lev
	Sete rundt stolpe 70 x 70 Grå	07-510-551K (se egen del- montering)	1	
	Bord rundt stolpe 70 x 70 Grå	07-510-552K (se egen del- montering)	1	
	Endelokk 70 x 70 stolpe Sort	00-400-996	1	
	Butikkdisk L = 520 Grå	07-510-550K (Se egen del- montering)	1	
	Tak Steelmat / Rød	07-510-500K (Se egen del- montering)	1	
	Megafon med feste 70 x 70 Blå	35-100-620K (se egen del- montering)	1	

Boltepakker for / Boltpackage for / Bultpaket för

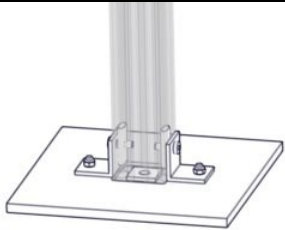
Sign. _____.

Lovisa m/ gulv, Rød-Grå 25-200-371	Navn	Artnr/ dimensjon	Ant	Lev
	Produktmerke	00-100-400 (montert hos Søve)	0	
	Mini gulv dobbelt 1230x684 Grå	07-510-584K (se egen del- montering)	1	
	Sperrerør rett L=520 for gulv Sort	07-510-161K (Se egen del- montering)	7	

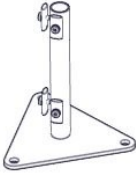
Boltepakker for / Boltpackage for / Bultpaket för		Sign. _____.		
Lovisa m/gulv, Rød-Grå 25-200-371	Navn	Artnr/ dimensjon	Ant	Lev
	Fundament Støp			
	Støpefundament 70 x 70 stolpe	00-003-112K (se egen del- montering)	6	
	Sperrerør standard L = 520 Sort	07-510-160K (se egen del- montering)	2	
	Fundament Nedgraving			
	Fundamentskive 70 x 70 stolpe	07-510-207K (se egen del- montering)	6	
	Sperrerør standard L = 520 Sort	07-510-160K (se egen del- montering)	2	

Boltepakker for / Boltpackage for / Bultpaket för		Sign. _____.		
Lovisa m/gulv, Rød-Grå 25-200-371	Navn	Artnr/ dimensjon	Ant	Lev
	Overflate- montering			
	Fundament 70x70stolpe for be- tongdekke	00-003-129k	6	
	Stolpe kappes Stolpe 70 x70 Skrå L = 1650 (400-1250) Sort	07-510-152	4	
	Stolpe 70 x 70 L = 1300 (400-900) Sort	SFA5123/1	2	
	Torx M8x20 Bruk korte bolter på nedeste festepunkter	04-000-020	24	

Overflatemontering / surface mounting / ytmontering

Ref
NS-EN 1176-1
§4.2.8.5

(N) (EN) (S)
Bakkenivå Ground level marknivå

Tykkelse/Thickness

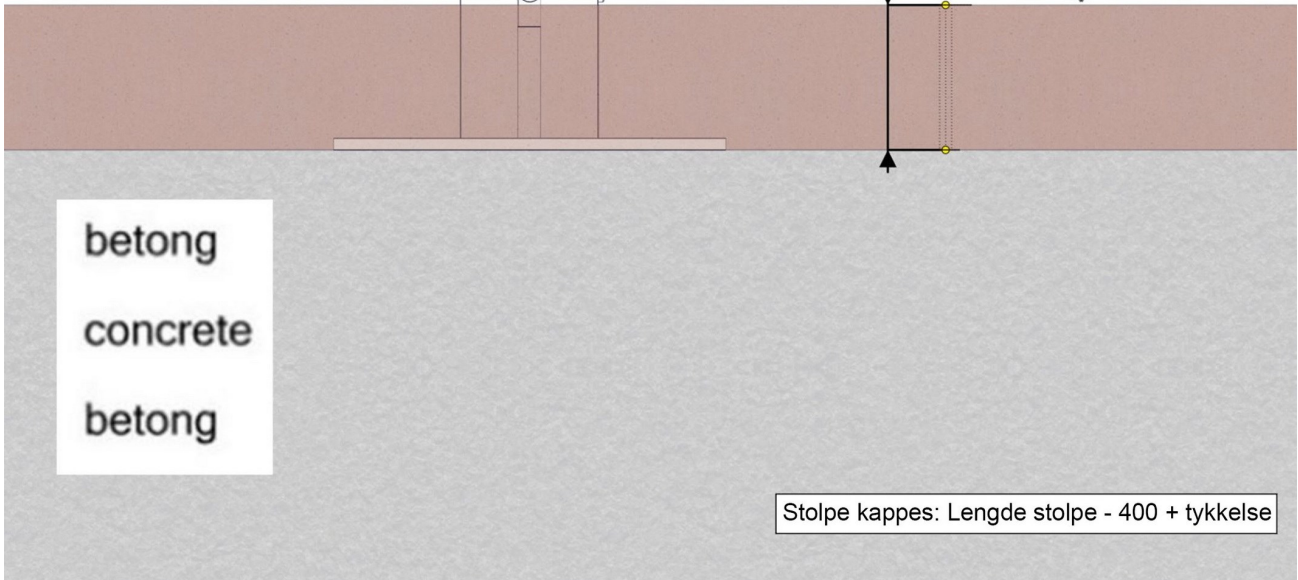

Torx M8x20

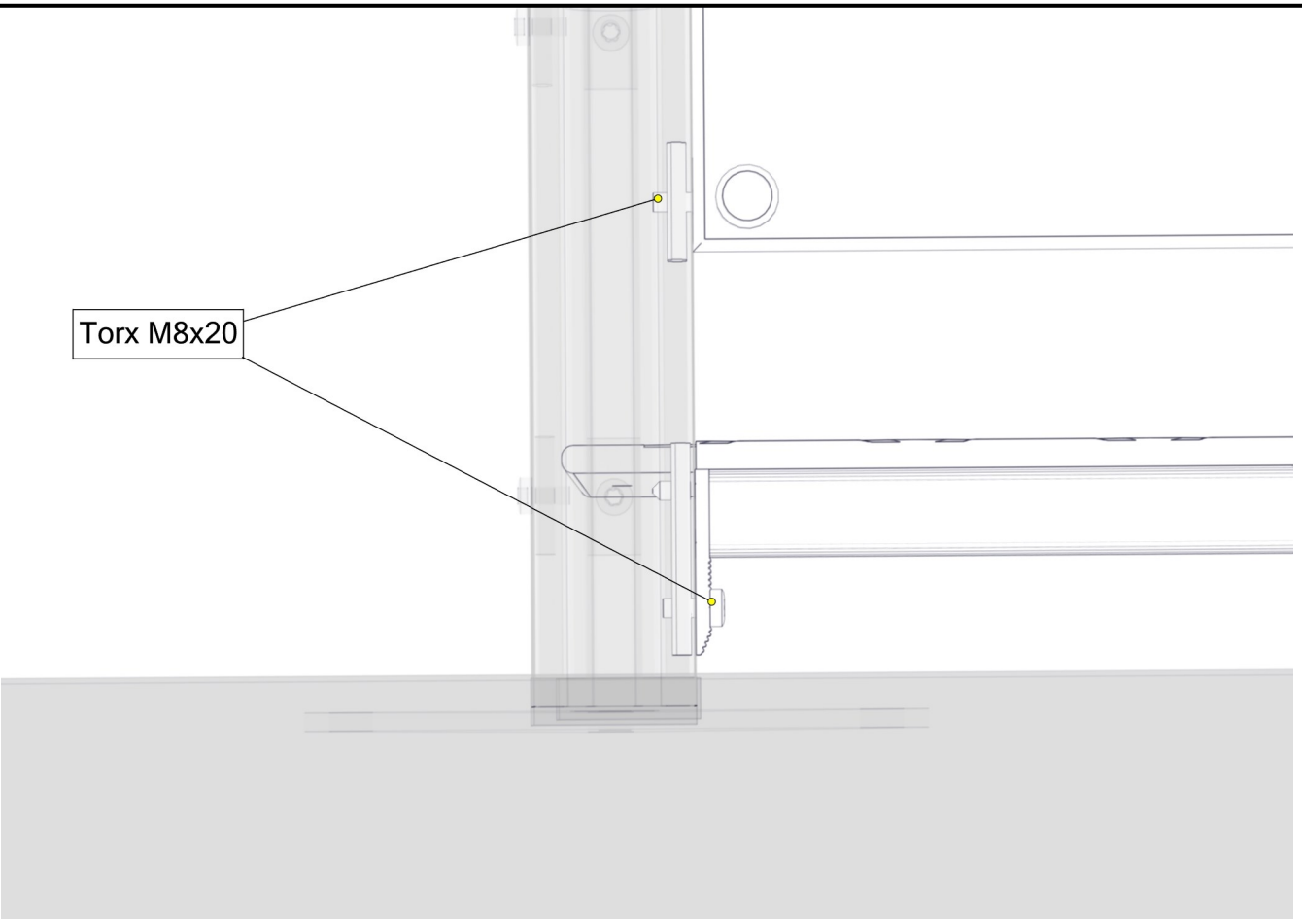

08.05.2023 MNO
Overflatemontering