



Monteringsanvisning



Assembly Instructions



Monteringsanvisning

Produkt nr. / Product no. / Produkt nr.

25-300-070

Ordr. nr. _____

Dato. _____

Sign. _____

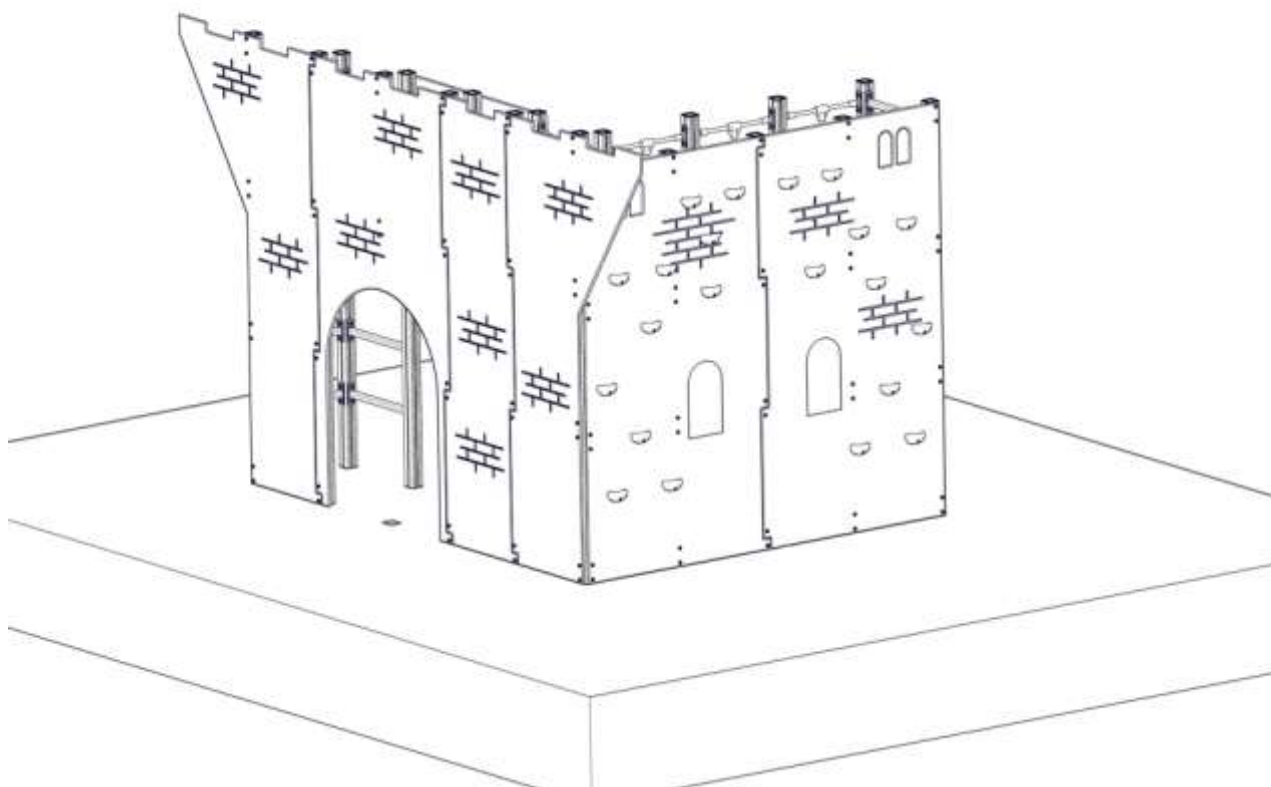

sove

Søve AS
3830 Ulefoss - Norway
Tlf: +47 35 94 65 65
www.sove.no



Søve AB
EA Rosengrensgatan 32
421 31 Västra Frölunda
Phone: +46 (0)31 773 97 00
www.sove.se

Monteringstips / Assembly Advice / Monteringsstips

N

- Les monteringsanvisningen nøye før montering.
- Monter elementene i rekkefølgen som vist.
- Boltene bør ikke skrues for hardt til før alt er montert, vatret og loddet. Skru så boltene til.
- NB! Ved bruk av drill, kan boltene ryke.
- På grunn av at solen kan gjøre rutsjeplaten veldig varm, bør rutsjebanens utløp vende mot nord-øst eller nord-vest.
- Er lekeutstyret plassert i naturlige ferdselstraséer må området sikres mot gjennomgang.
- Innspringningshinder bør vurderes rundt lekeapparater hvor det er stor bevegelse, f.eks. ved huskestativ.
- Det bør være fritt innsyn til lekeutstyr som er beregnet for barn under 3 år.

NB! Under monteringsarbeidet må utstyr, som ikke er forankret forsvarlig i bakken, sikres slik at det ikke velte.

Området må avstenges under montering av apparatene med sperrebånd eller lignende.

UK

- Read the instruction carefully before assembling the play unit..
- Assemble the components in the sequence shown in these instructions.
- Fixings must not be fully tightened during assembly. Before casting the foundations, the structure must be level and plumb, at which point all fixings are tightened.
- PSI If use of drill, the bolts may be wrecked.
- Avoid positioning the slide facing due south because of overheating – ideal positions are facing north-east or north-west.
- Secure the construction-area to prevent people from walking through it.
- Consider installing barriers around play-equipment which gives rise to a lot of activity – i.e.swings.
- Ensure that clear vision is possible across the play area so that supervision is possible from any position, particularly where children under 3 years of age will be playing.

NB! During assembly of the equipment, ensure that all structures are securely propped, especially when left overnight. Also ensure that equipment is supported whilst concrete foundations are setting and enclose the area securely to prevent access.

Monteringstips / Assembly Advice / Monteringsstips**S**

- Läs monteringsanvisningen noga före montering.
- Montera delarna i den ordningen som anvisas
- Skruvarna bör inte skruvas för hårt tills allt är monterat, i våg och lodat.









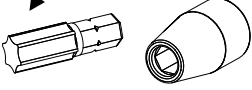

OBS! Används elektrisk skruvdragare, kan bulten gå sönder. Hårdra därför manuellt!

- Solen kan göra att rutchbanan blir väldigt varm. Banans nedfart rekommenderas att vändas i norrlig riktning
- Om lekplatsen placeras vid en gångväg mm bör området säkras mot genomfart av gående och cyklister.
- Insprängningshinder bör placeras runt lekutrustning med stor rörelse, t ex, gungställning.
- Det bör vara fri insyn till lekutrustning beräknat till barn under 3 år.

OBS! Under monteringsarbete bör utrustningen som inte ska förankras i marken, ställs så att den inte kan välta.

Området måste spärras när lekutrustningen byggs upp, med avspärrningsband eller liknande.

Nødvendig verktøy / Tools required / Nödvändiga verktyg

<p>(N)</p> <p>(UK)</p> <p>(S)</p>	<p>(A)</p> 	<p>(B)</p>  <p>Torx Nr 45 High quality</p> 	<p>(C)</p> <p>5 mm 6 mm</p> 	<p>(D)</p> 	<p>(E)</p> 
		<p>Metermål Metric measure Tumstoc</p> 	<p>16 V</p> 	<p>Merkebånd Mark ribbon Märkeband</p> 	<p>13 + 17mm</p> 

Nødvendig antall personer / Number of persons required / Lämpligt antal personer





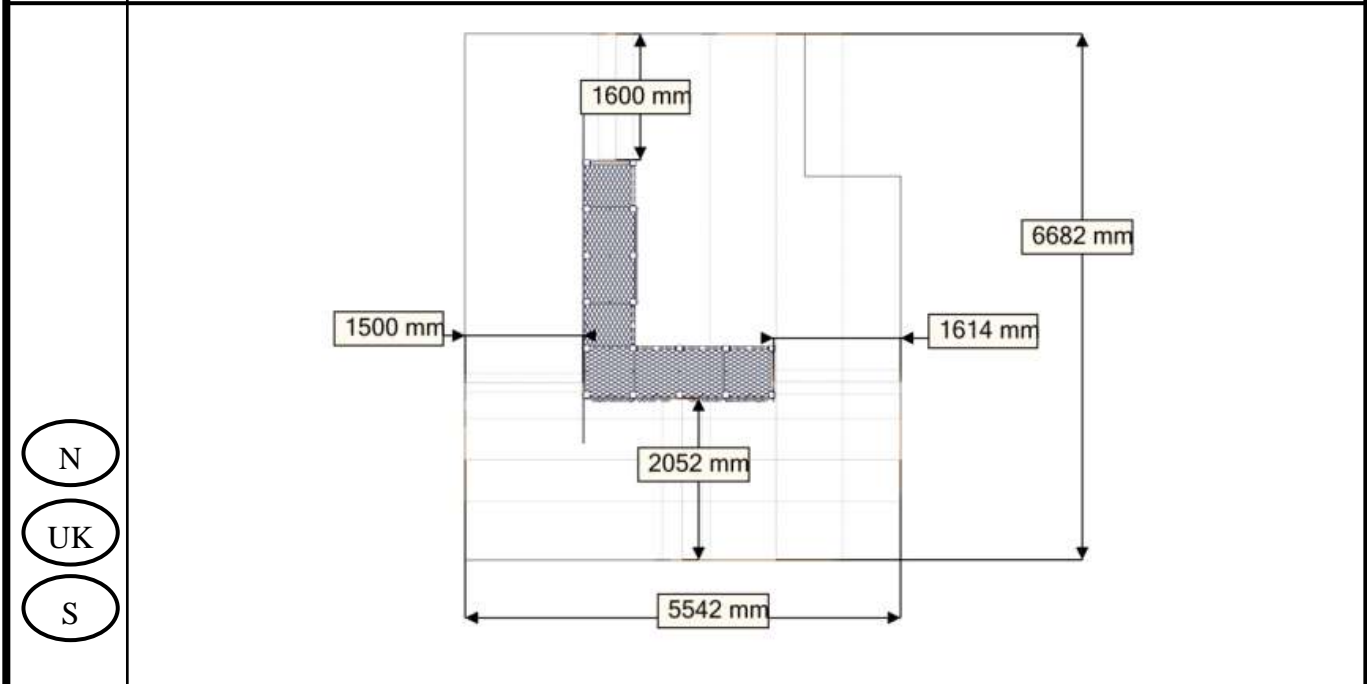









Anbefalt arealbehov ved montering / Recommended working space / Rekommenderad arealbehov vid montering

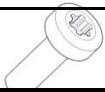



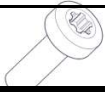





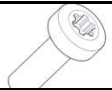

Boltepakker for / Boltpackage for / Bultpaket för

Sign. _____

Stolpe 70x70	Ant=	Navn	Artnr/dimensjon	Ant	Lev
		VK70 2500-600(5) L=3100 Brikke på stolpe!	07-510-152	5	
		VK70 2300-600(11) L=2900 Brikke på stolpe!	07-510-154	11	
		VK70 L=1100 VK70 L=900		1	1
		Stolpende	00-400-996	20	
FundamentMini 660	Ant= 8	Navn	Artnr/dimensjon	Ant	Lev
		miniSprosse 660 (1)	07-510-200	8	
			Brikke 50_1T (2)	04-060-050	16
			Torx M8x35 (2)	04-000-035	16
FundamentMini 1250	Ant= 6	Navn	Artnr/dimensjon	Ant	Lev
		miniSprosse 1250 (1)	07-510-202	6	
			Brikke 50_1T (3)	04-060-050	18
			Torx M8x35 (3)	04-000-035	18
FundamentSkive	Ant= 16	Navn	Artnr/dimensjon	Ant	Lev
		Skive (1)	07-510-201	16	







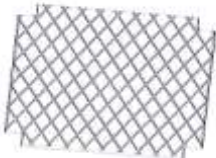

Boltepakker for / Boltpackage for / Bultpaket för

Sign. _____.

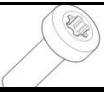
Sperrerør 520	Ant= 12	Navn	Artnr/dimensjon	Ant	Lev
		Sperrerør 520 (1)	07-510-160	12	
		Brikke 120_3T (2)	04-060-120	24	
		Torx M8x25 (4)	04-000-025	48	
Sperrerør 520 gulv	Ant= 30	Navn	Artnr/dimensjon	Ant	Lev
		Sperrerør 520 (1)	07-510-161	30	
		Brikke 90_2T (2)	04-060-090	0 På stolpe	
		Torx M8x25 (2)	04-000-025	60	
Krakeness Nett Kort	Ant= 4	Navn	Artnr/dimensjon	Ant	Lev
		Krakeness nett kort (1)	07-510-511	4	
		Torx M8x25 (8)	04-000-25	32	
		Brikke 120_3T (4)	04-060-120	16	



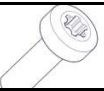
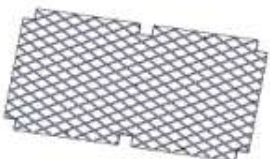
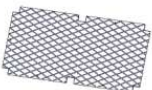



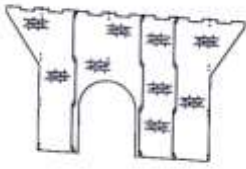

Boltepakker for / Boltpackage for / Bultpaket för

Sign. _____.

Gulv mini	Ant= 3	Navn	Artnr/dimensjon	Ant	Lev
		Gulv Mini 520(1) LANG for klatre- vegg	07-510-104	3	
		Møbelknapp (4)	04-030-011	12	
		Torx M8x45 (4)	04-000-045	12	
Gulv mini	Ant= 1	Navn	Artnr/dimensjon	Ant	Lev
		Gulv Mini 520(1) LANG på 2 side (hjørne) for klatre- vegg	07-510-114	1	
		Møbelknapp (4)	04-030-011	4	
		Torx M8x45 (4)	04-000-045	4	
Gulv mini dobbelt	Ant= 2	Navn	Artnr/dimensjon	Ant	Lev
		Gulv Mini 520(1) LANG på langside for klatrevegg	07-510-115	2	
		Møbelknapp (7)	04-030-011	14	
		Torx M8x45 (7)	04-000-045	14	



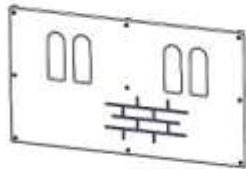
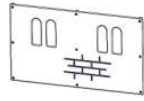



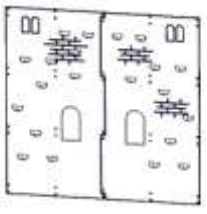

Boltepakker for / Boltpackage for / Bultpaket för

Sign. _____.

Tårn krakenes	Ant= 1	Navn	Artnr/dimensjon	Ant	Lev
		Krakenes Venstre (1)	07-510-501	1	
		Krakenes høyre (1)	07-510-502	1	
		Krakenes port(1)	07-510-503	1	
		Krakenes mellomdel (1)	07-510-504	1	
		Torx M8x35 (44)	04-000-035	44	
		Brikke 120_T3(20)	04-060-120	22	
Vegg Krakenes	Ant= 1	Navn	Artnr/dimensjon	Ant	Lev
		Vegg Borg Krakenes	07-510-505	1	
		Torx M8x35 (9)	04-000-35	9	
		Brikke 50_1T (9)	04-060-050	9	

Boltepakker for / Boltpackage for / Bultpaket för

Sign. _____.

Klatreveggen Borg Krakenes	Ant= 1	Navn	Artnr/dimensjon	Ant	Lev
		Klatreveggen Krakenes Venstre (1)	07-510-506	1	
		Klatreveggen Krakenes Høyre (1)	07-510-507	1	
		Torx M8x35 (40)	04-000-035	40	
		Brikke 120_3T (20)	04-060-120	20	
Krakeness Nett Lang	Ant= 3	Navn	Artnr/dimensjon	Ant	Lev
		Krakeness nett lang (1)	07-510-510	3	
		Torx M8x25 (12)	04-000-25	36	
		Brikke 120_3T (6)	04-060-120	18	

Fundamentering med betong / Foundation concrete / Förankring med betong

(N)	Støtsand		(N)	(UK)	(S)
(UK)	Safer surface		Bakkenivå	Ground level	Marknivå
(S)	Stridsan			↓	Ref NS-EN 177
(N)	Komprimert masse.	betong			
(UK)	Compressed mass.	concrete			
(S)	Komprimerad massa.	betong			

Fundamentering uten betong / Foundation without concrete / Förankring utan betong

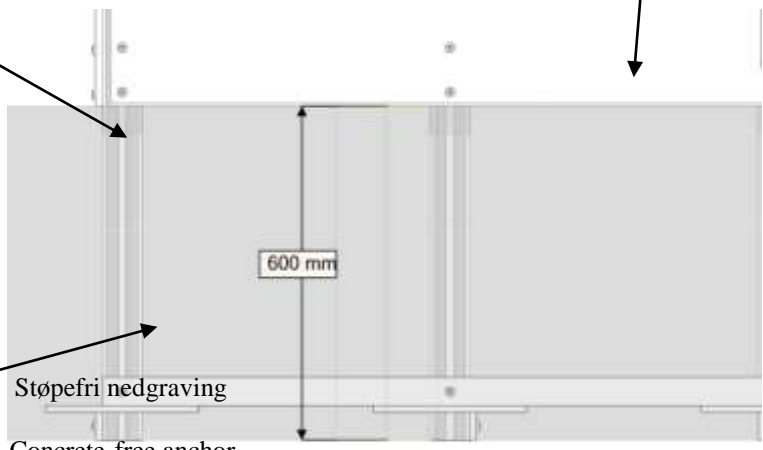
(N)	Støtsand		(N)	(UK)	(S)
(UK)	Safer surface		Bakkenivå	Ground level	Marknivå
(S)	Stridsan			↓	Ref NS-EN 1177
(N)	Komprimert masse	Støpefri nedgraving			
(UK)	Compressed mass	Concrete-free anchor			
(S)	Komprimerad massa	Nedgrävningfundament			

(N)	Alle mål er oppgitt i millimeter
(UK)	Scale measured in mm
(S)	Alla mått är i millimeter.

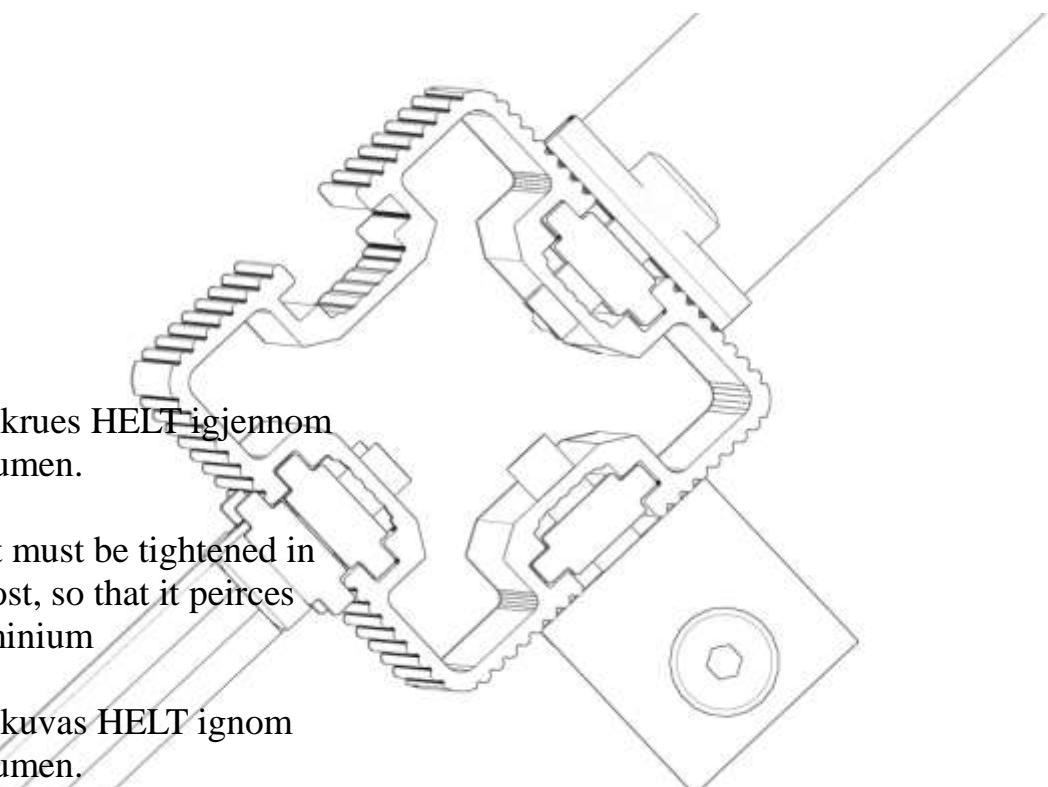
<p data-bbox="119 1556 215 1624">N</p> <p data-bbox="119 1691 215 1758">UK</p> <p data-bbox="119 1848 215 1915">S</p>	 <p data-bbox="239 1579 702 1668">Bolten skrues HELT igjennom aluminiumen.</p> <p data-bbox="239 1713 686 1836">The bolt must be tightened in to the post, so that it peirces the aluminium</p> <p data-bbox="239 1881 662 1971">Bulten skruvas HELT ignom aluminiumen.</p>

Fallhøyder / Free height of fall / Fallhöjder

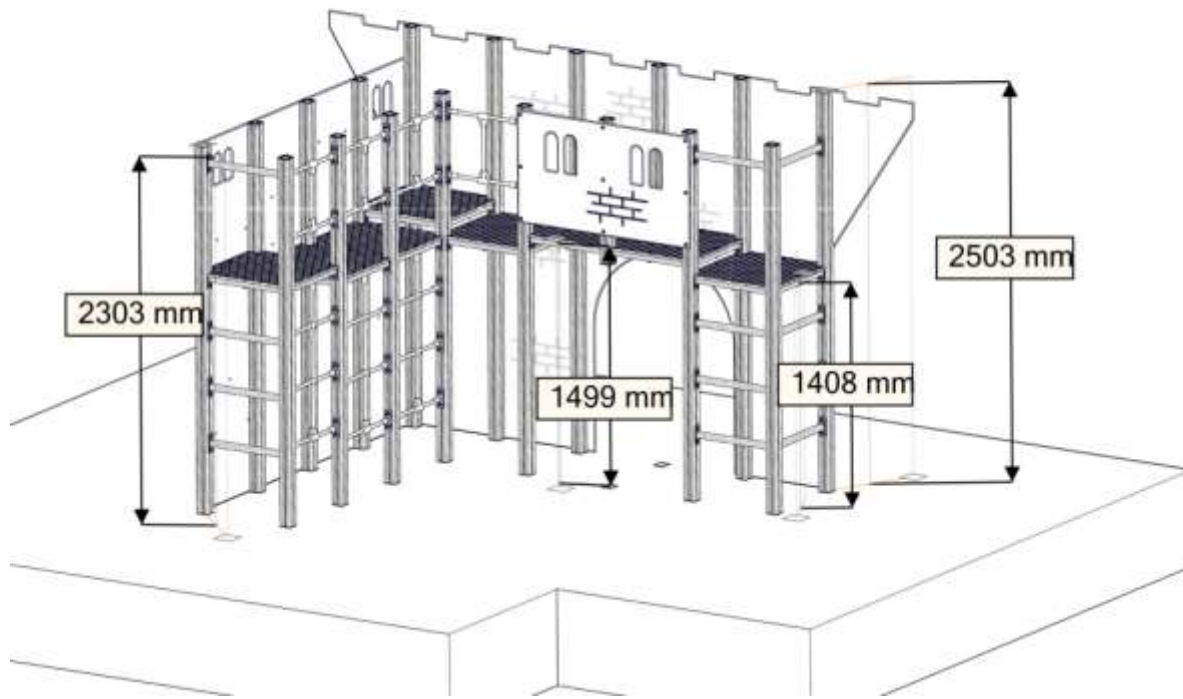

Sikkerhetszone / Safety zone / Säkerhetszon

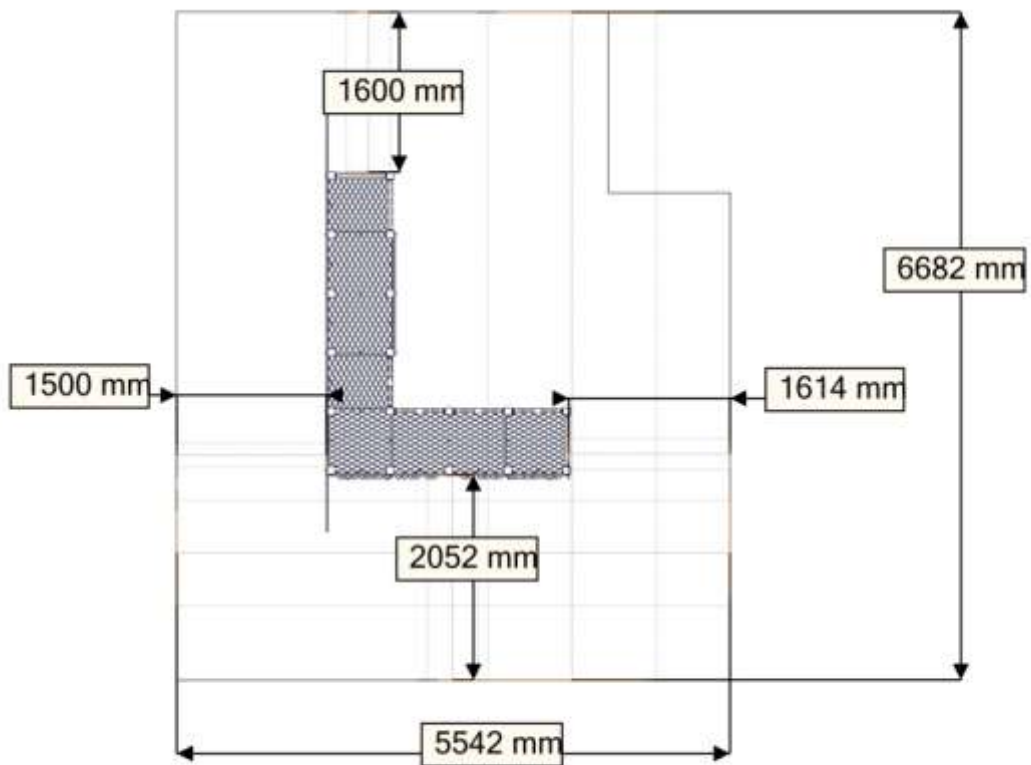

Plassering av forankringer / Ground plan / Placering av förankringar

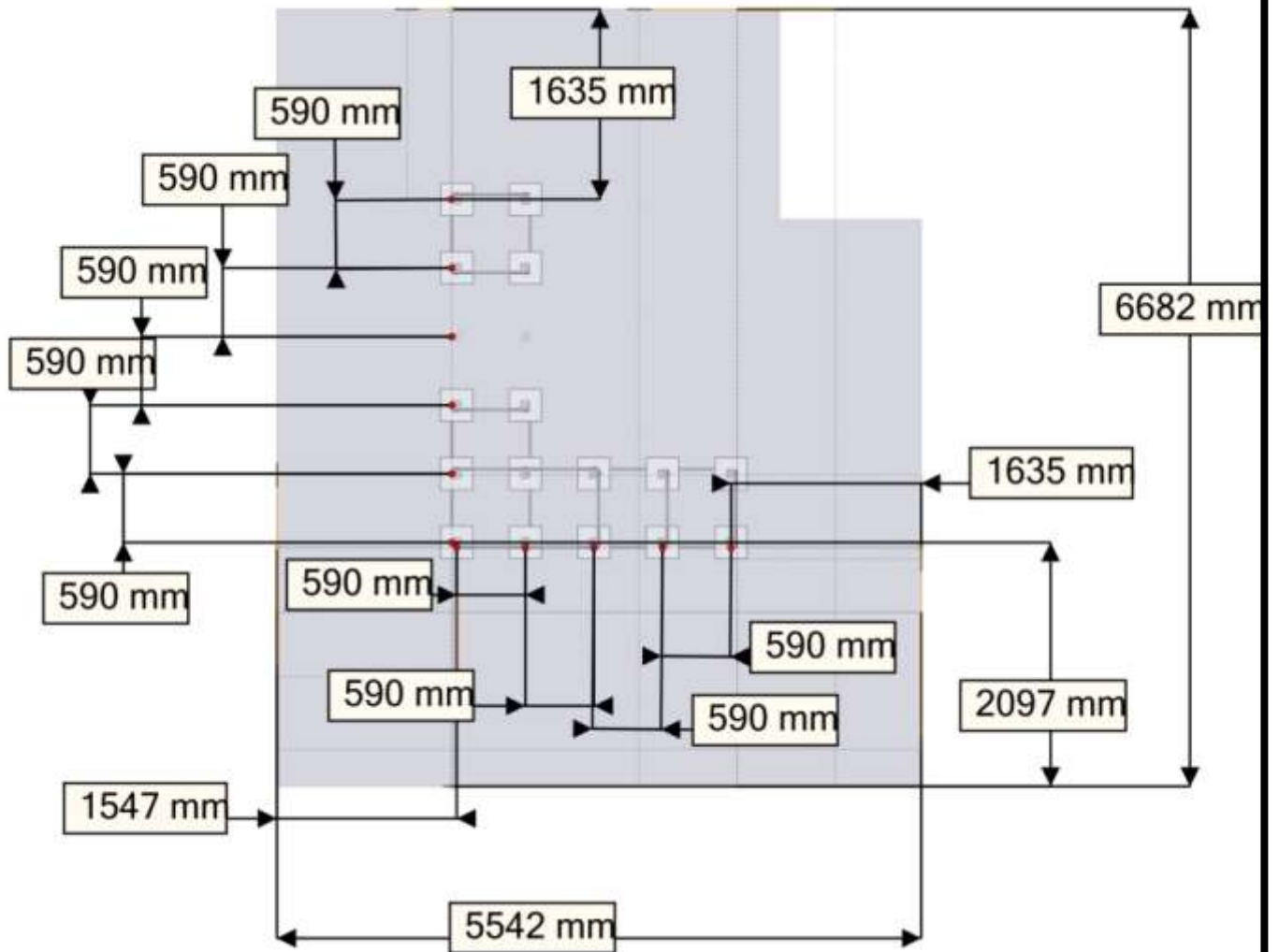

N

Alle mål er oppgitt i millimeter

UK

Scale measured in mm

S

Alla mått är i millimeter.

Montering av lekeapparatet / Assembly instructions / Montering av lekredskapet

Brikke påmontert hos Søve

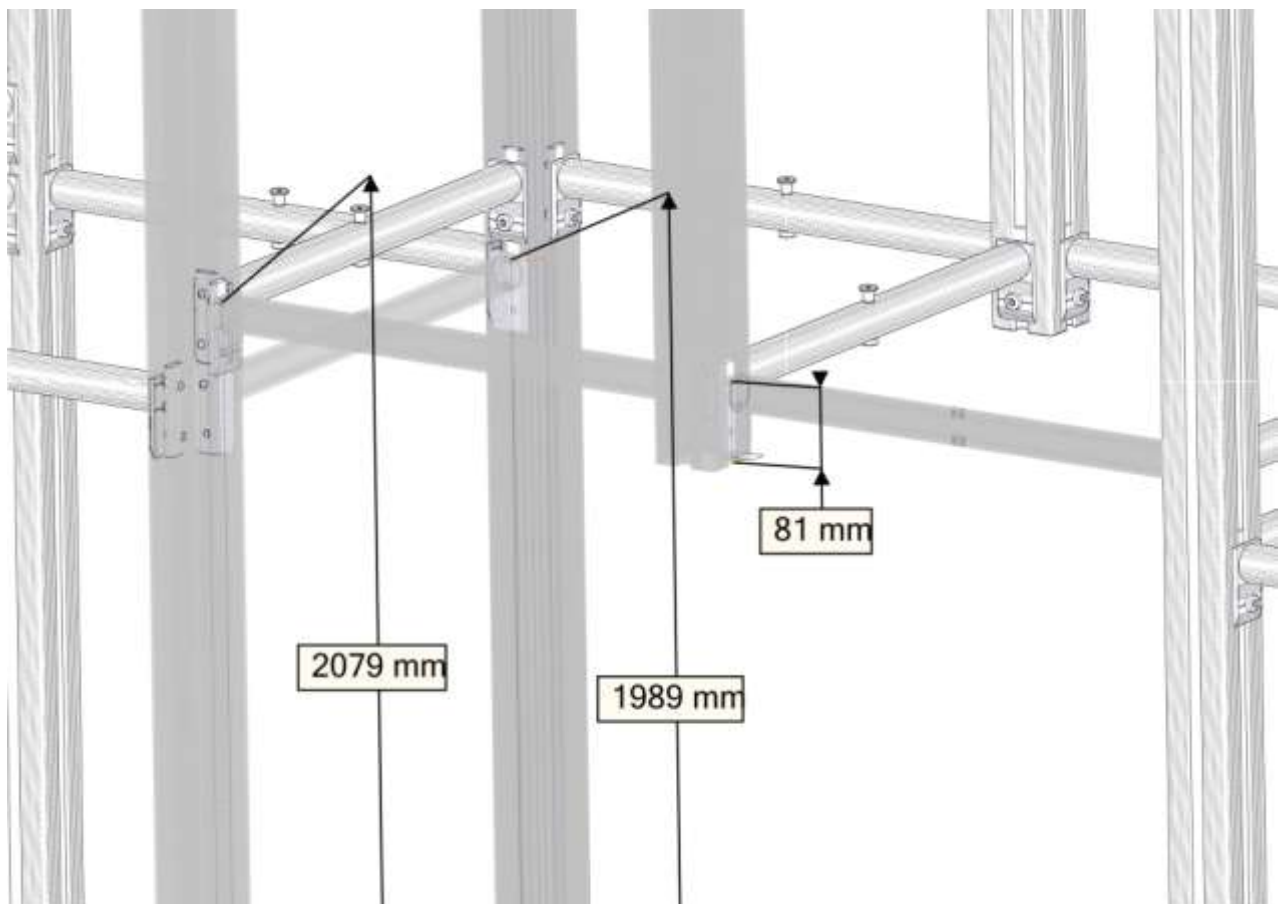
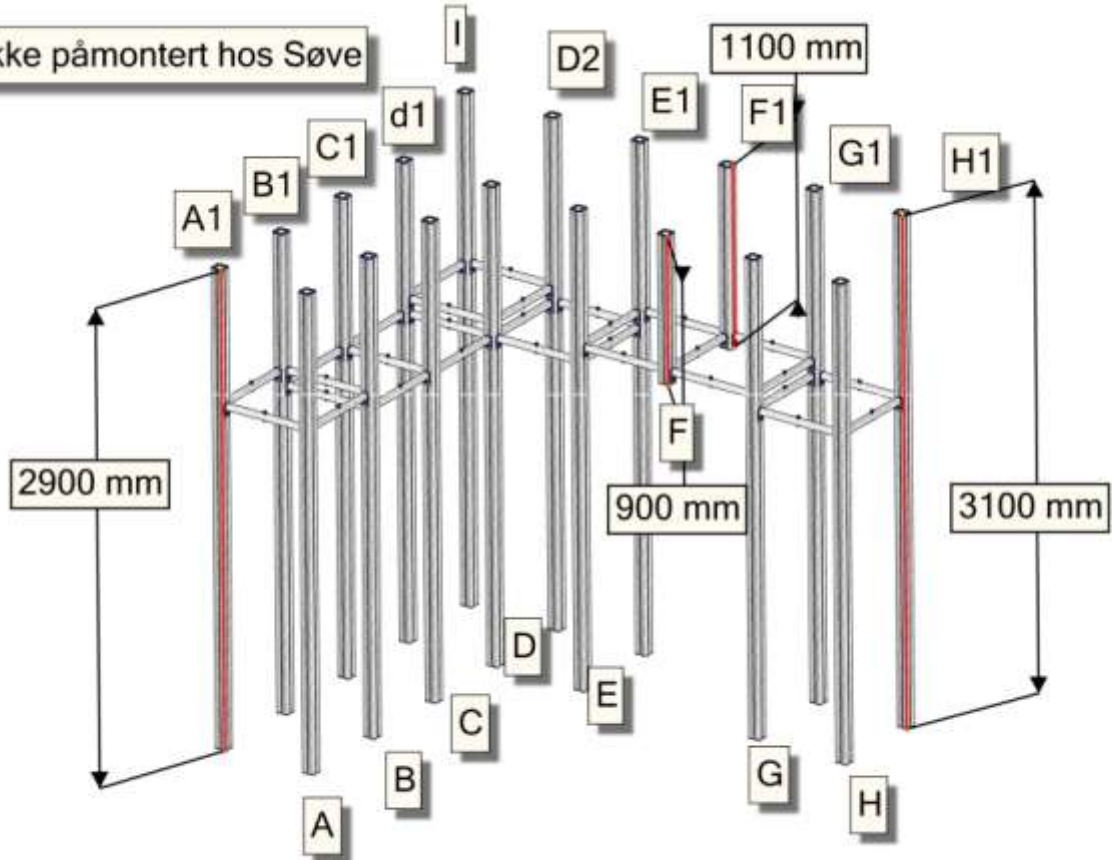

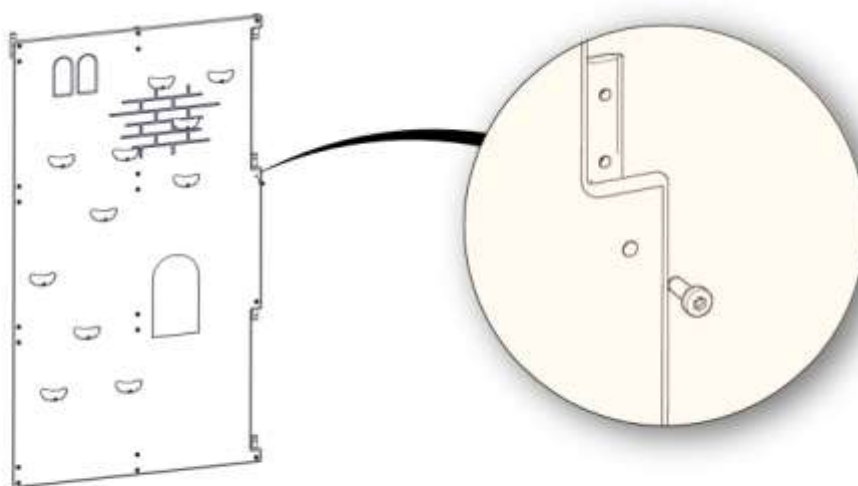
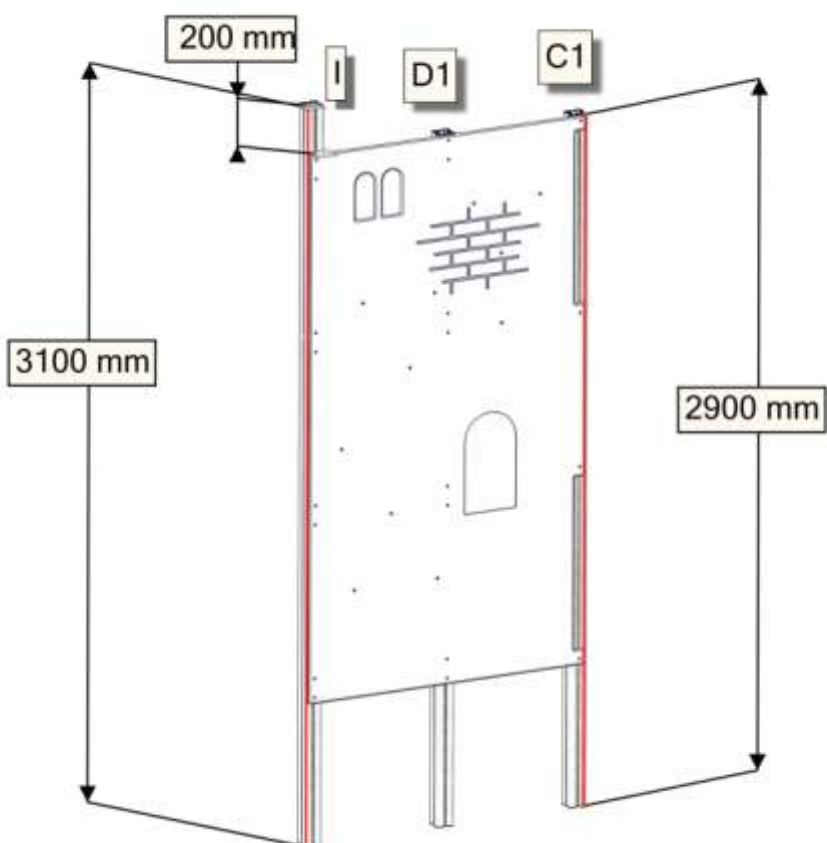

BOM ID	Name	SW Configuration	Artnr (config)	Qty
1	TorxM8-	TXM8x35	04-000-035	20
2	brikke_SFA5116-	120_3T	04-060-120	12
3	Borge klatring_jim-1	Venstre	07-510-506	1
4	VK70_SFA5123_miniserie-1	2500-600	07-510-153	1
5	VK70_SFA5123_miniserie-1	2300-600	1000	2

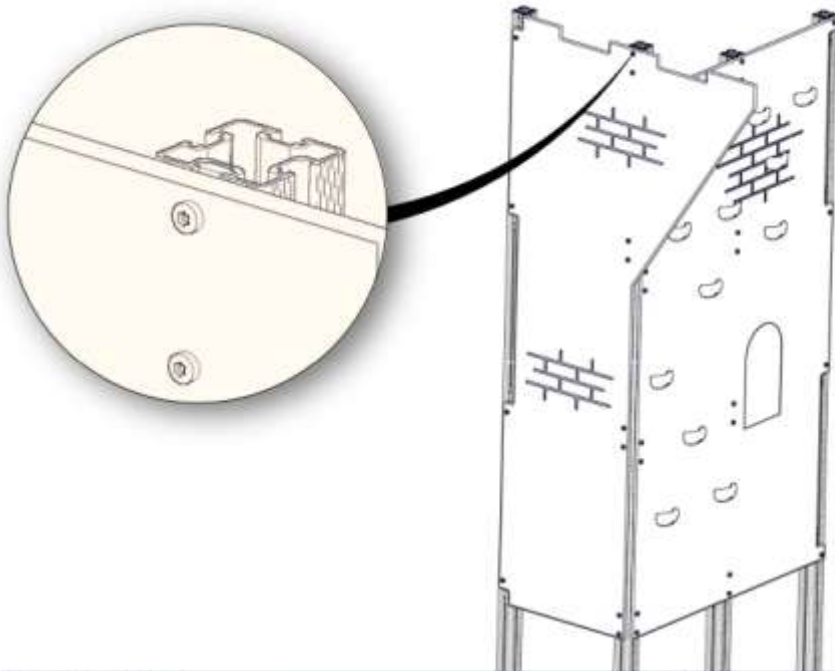

BOM ID	Name	SW Configuration	Artnr (config)	Qty
1	TorxM8-	TXM8x35	04-000-035	12
2	brikke_SFA5116-1	120_3T	04-060-120	8
3	VK70_SFA5123_miniserie-1	2500-600	07-510-153	1

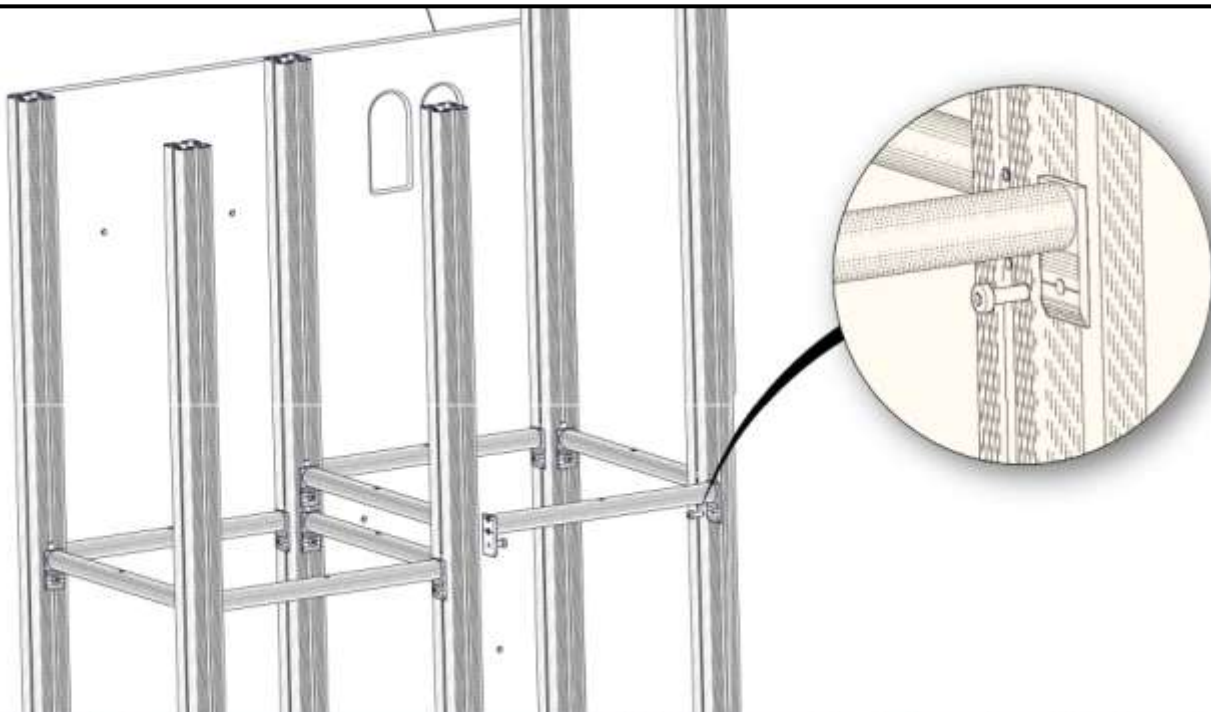

BOM ID	Name	SW Configuration	Artnr (config)	Qty
1	TorxM8-	TXM8x25	04-000-025	16
2	VK70_SFA5123_miniserie-1	2300-600	1000	2
3	Sperror_MINI508-1	520_Gulv	07-510-161	8

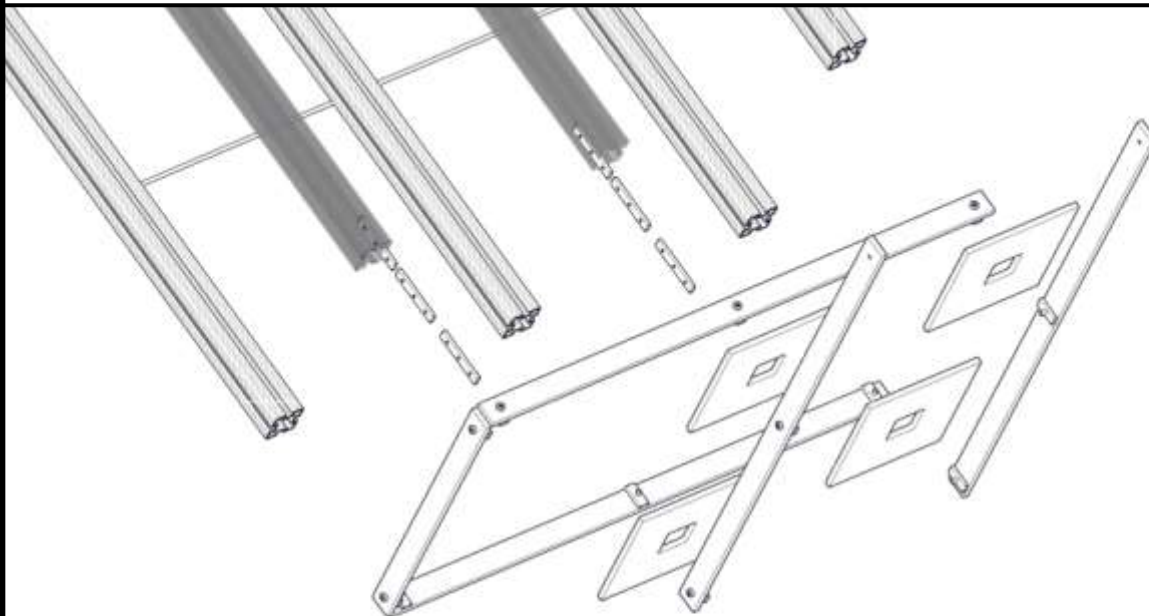
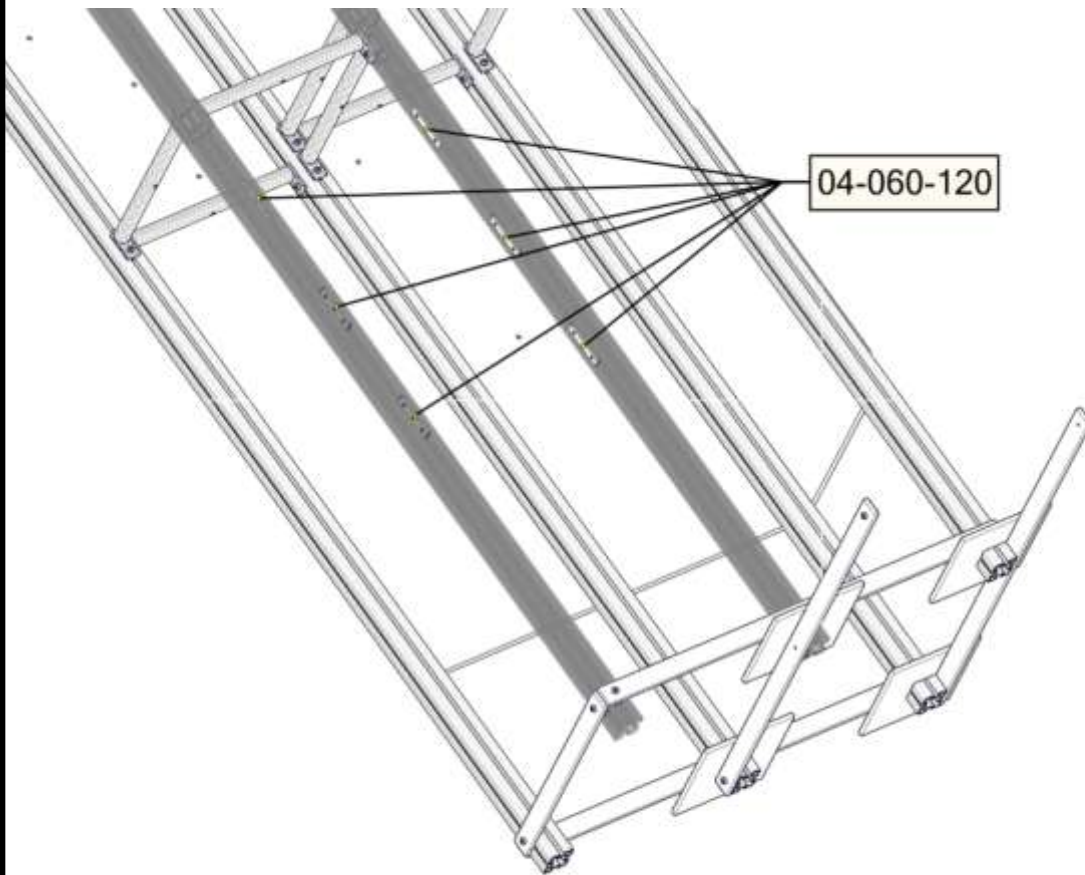

BOM ID	Name	SW Configuration	Artnr (config)	Qty
1	brikke_SFA5116-1	120_3T	04-060-120	6
2	TorxM8-	TXM8x35	04-000-035	12
3	brikke_SFA5116-	50_1T	04-060-050	12
4	minifun_sprosse-1	660	07-510-200	1
5	minifunSkive-	Default	07-510-201	4
6	minifun_sprosse-1	1250	07-510-202	4

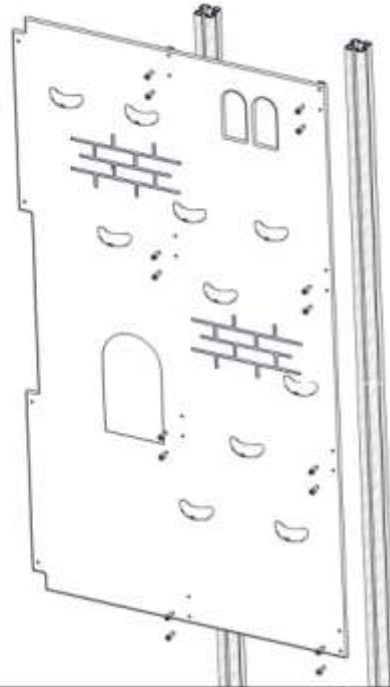

BOM ID	Name	SW Configuration	Artnr (config)	Qty
1	TorxM8-1	TXM8x35	04-000-035	16
2	brikke_SFA5116-1	120_3T	04-060-120	8
3	Borge_klatring_jim-2	hoyre	07-510-507	1
4	VK70_SFA5123_miniserie-1	2300-600	1000	2

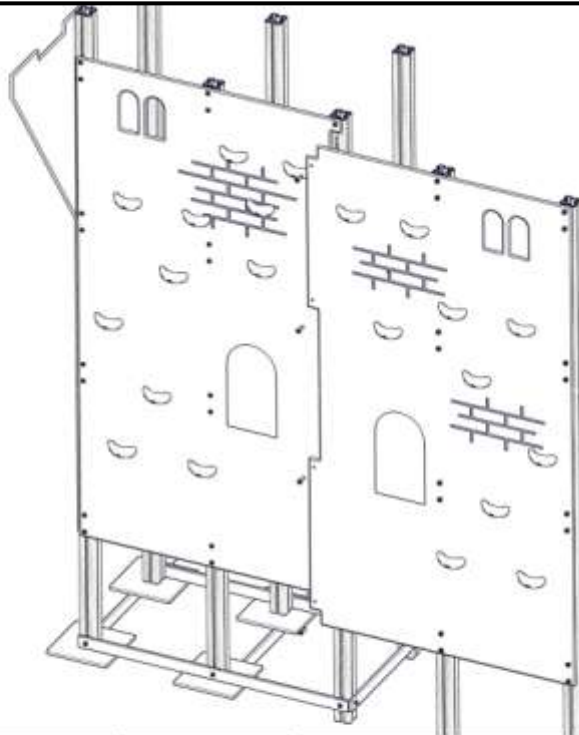

BOM ID	Name	SW Configuration	Artnr (config)	Qty
1	TorxM8-1	TXM8x35	04-000-035	4

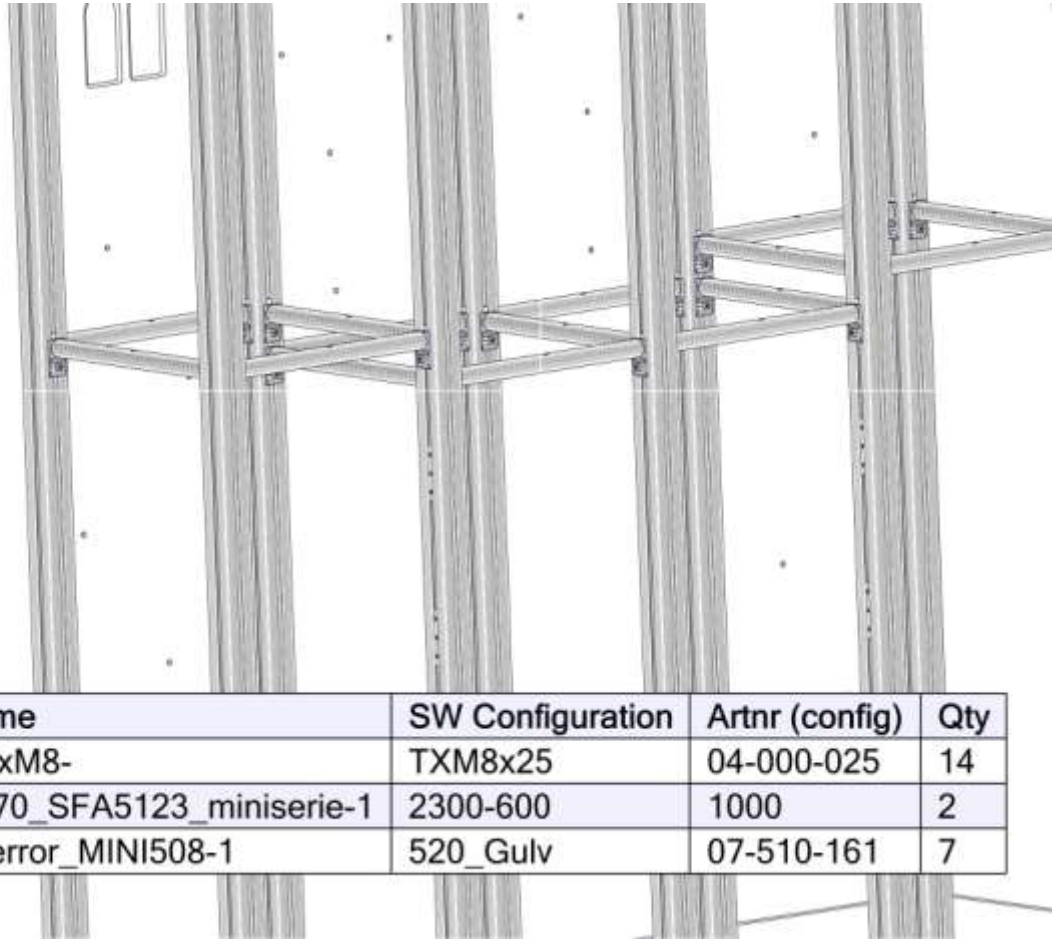

BOM ID	Name	SW Configuration	Artnr (config)	Qty
1	TorxM8-	TXM8x25	04-000-025	14
2	VK70_SFA5123_miniserie-1	2300-600	1000	2
3	Sperror_MINI508-1	520_Gulv	07-510-161	7

04-060-120

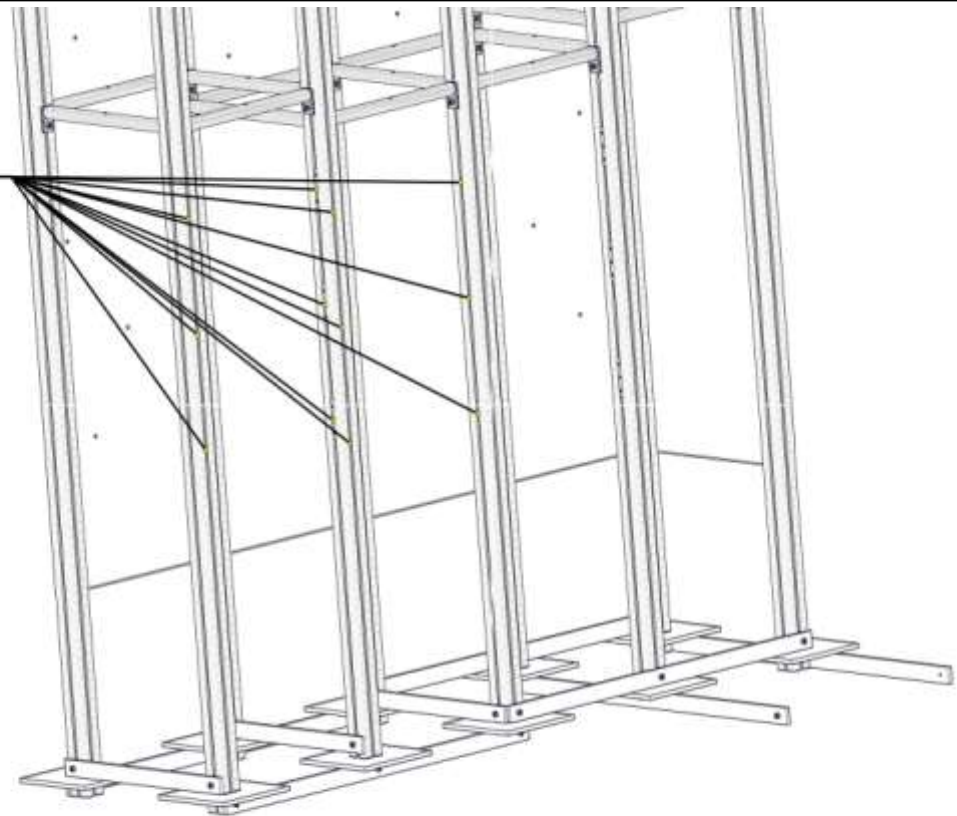

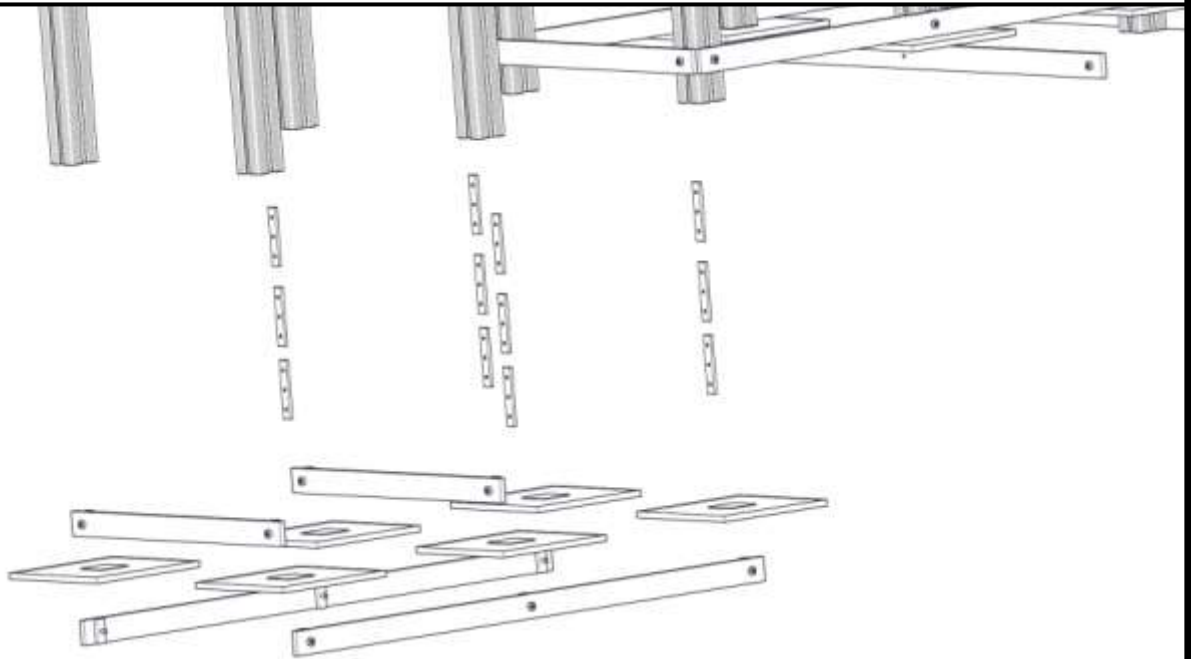

BOM ID	Name	SW Configuration	Artnr (config)	Qty
1	TorxM8-	TXM8x35	04-000-035	10
2	brikke_SFA5116-	50_1T	04-060-050	10
3	brikke_SFA5116-1	120_3T	04-060-120	12
4	minifun_sprosse-1	660	07-510-200	2
5	minifunSkive-	Default	07-510-201	6
6	minifun_sprosse-1	1250	07-510-202	2

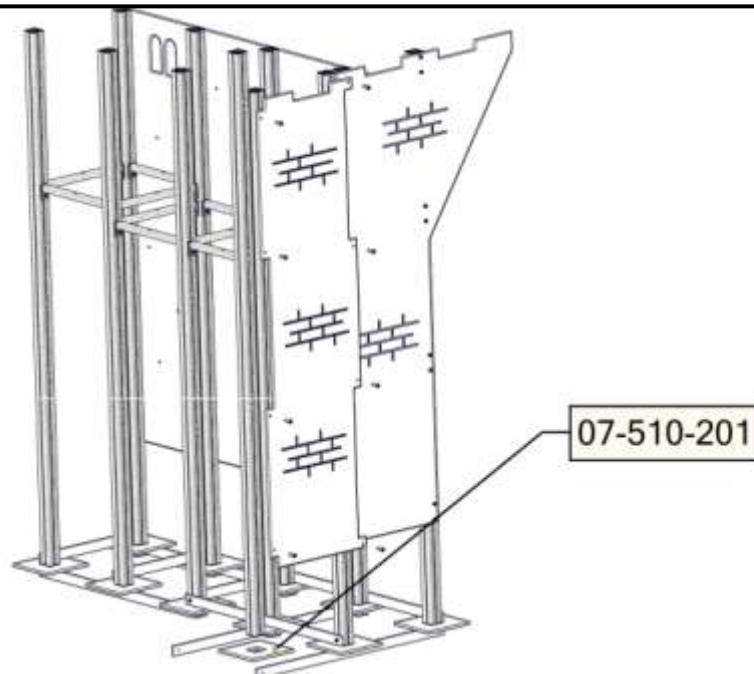

BOM ID	Name	SW Configuration	Artnr (config)	Qty
1	brikke_SFA5116-1	120_3T	04-060-120	4
2	VK70_SFA5123_miniserie-1	2500-600	07-510-153	1
3	TorxM8-1	TXM8x35	04-000-035	8
4	minifunSkive-13	Default	07-510-201	1

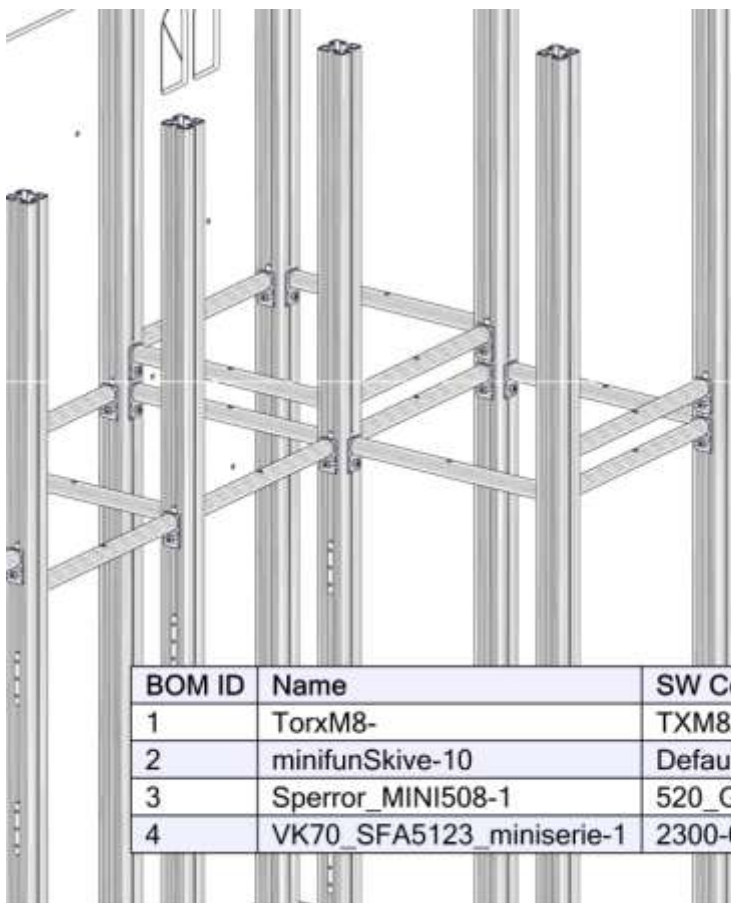
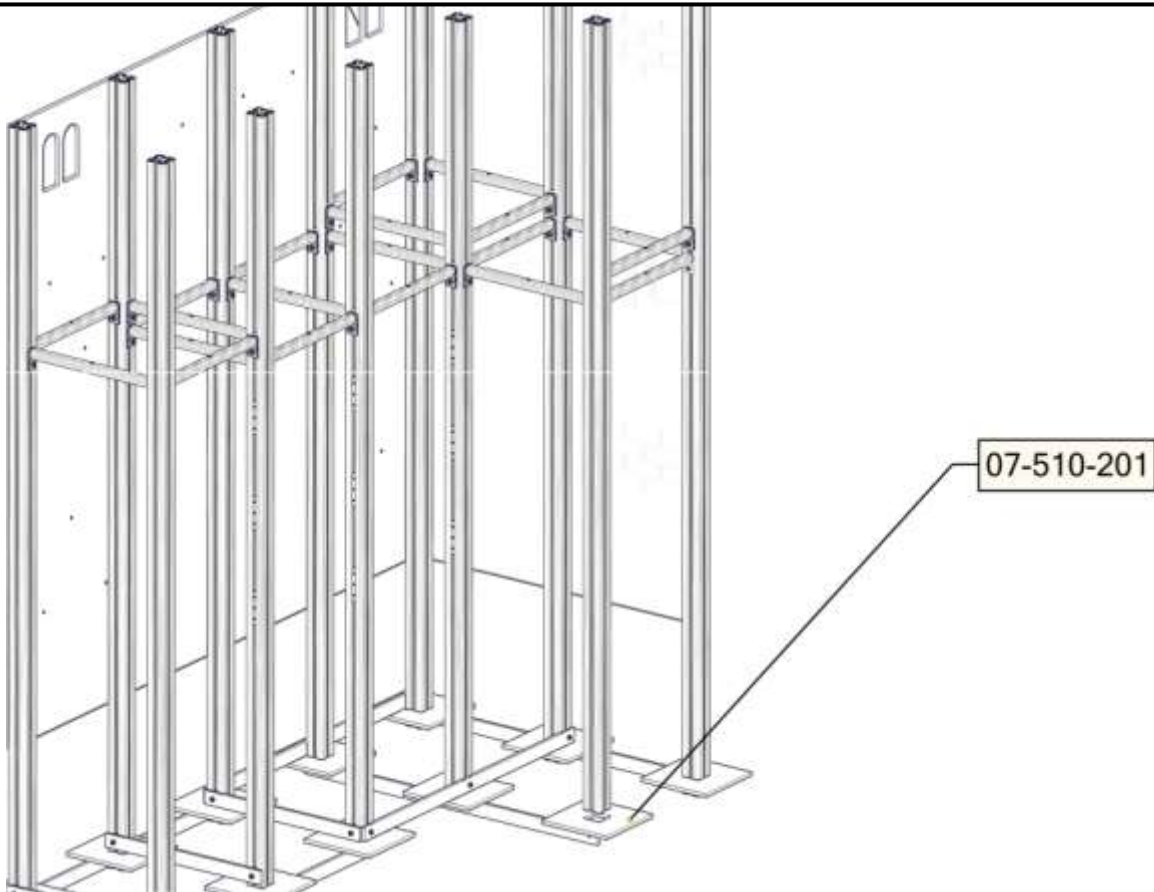

BOM ID	Name	SW Configuration	Artnr (config)	Qty
1	TorxM8-	TXM8x25	04-000-025	10
2	minifunSkive-10	Default	07-510-201	1
3	Sperror_MINI508-1	520_Gulv	07-510-161	5
4	VK70_SFA5123_miniserie-1	2300-600	1000	1

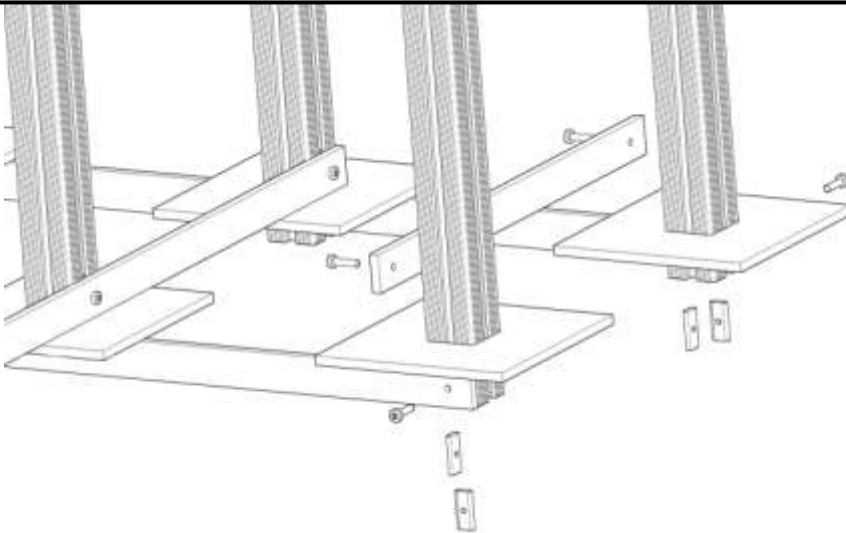

BOM ID	Name	SW Configuration	Artnr (config)	Qty
1	Torxm8-	TXM8x35	04-000-035	4
2	brikke_SFA5116-	50_1T	04-060-050	4
3	minifun_sprosse-1	660	07-510-200	1

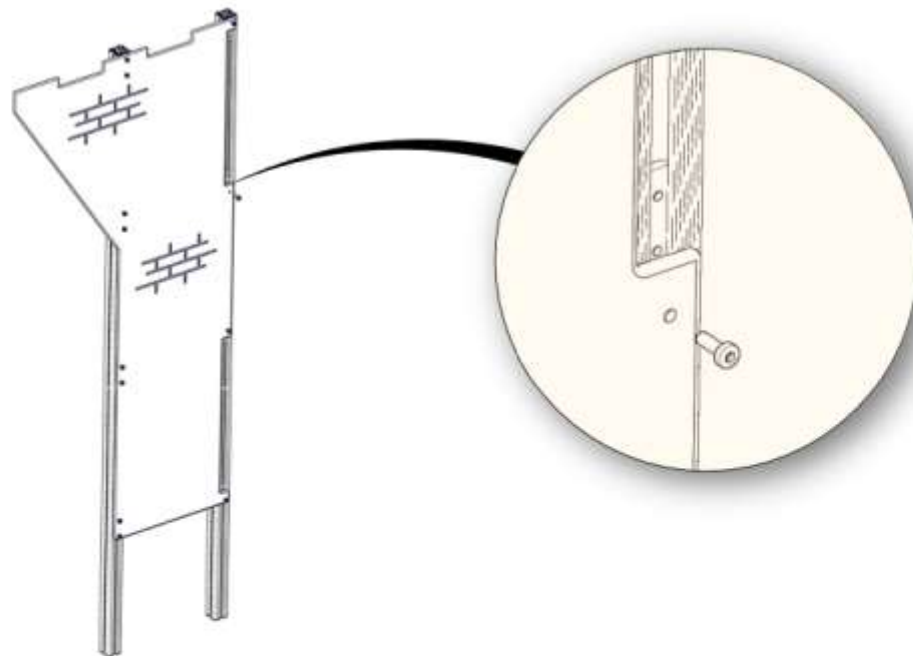

BOM ID	Name	SW Configuration	Artnr (config)	Qty
2	Torxm8-	TXM8x35	04-000-035	12
3	brikke_SFA5116-	120_3T	04-060-120	8
4	Borge_tarn_jim-1	Venstre	07-510-501	1
5	VK70_SFA5123_miniserie-1	2500-600	07-510-153	2

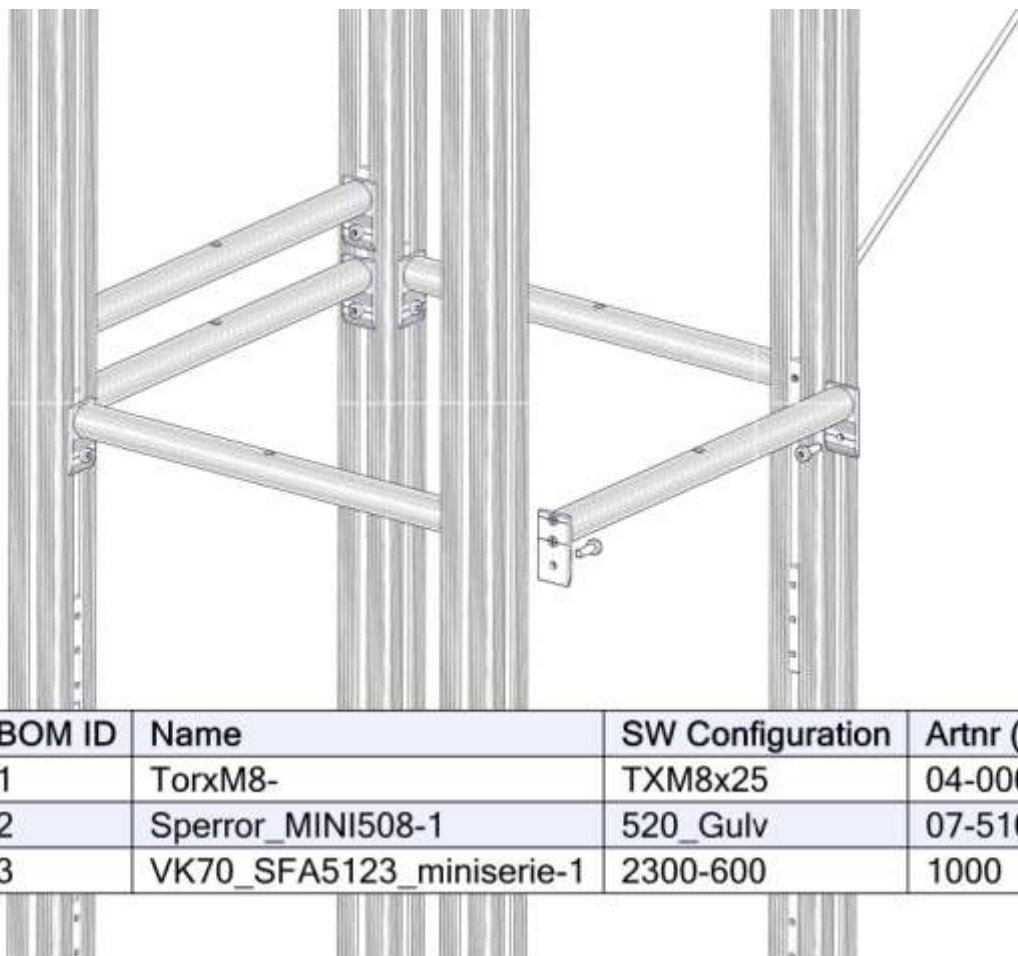
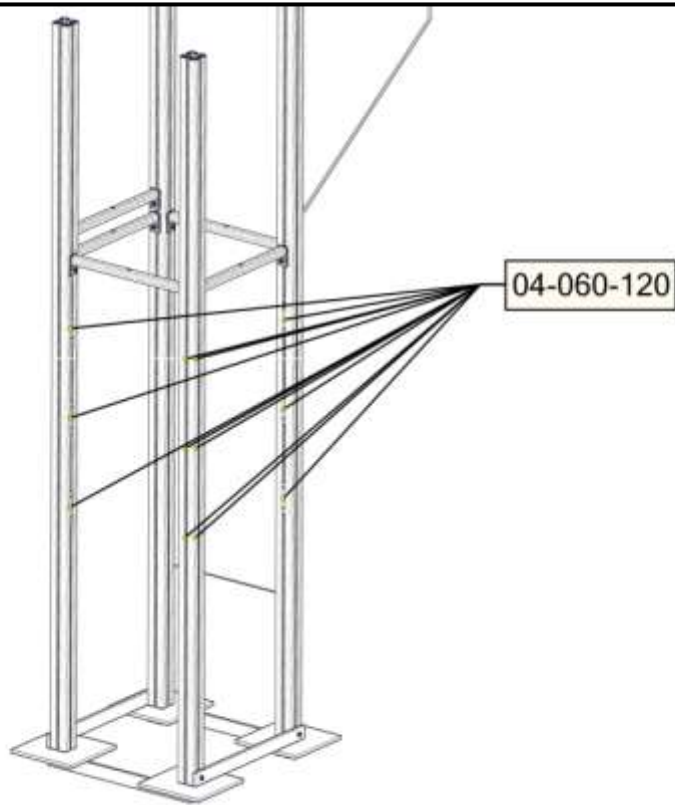

BOM ID	Name	SW Configuration	Artnr (config)	Qty
1	TorxM8-	TXM8x25	04-000-025	10
2	Sperror_MINI508-1	520_Gulv	07-510-161	5
3	VK70_SFA5123_miniserie-1	2300-600	1000	2

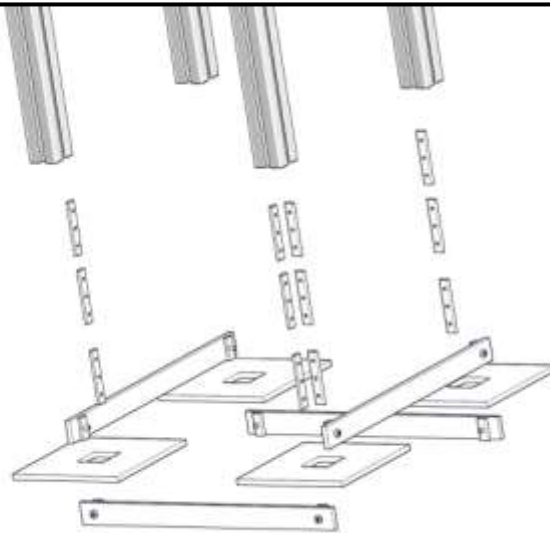

BOM ID	Name	SW Configuration	Artnr (config)	Qty
1	brikke_SFA5116-	120_3T	04-060-120	12
2	TorxM8-	TXM8x35	04-000-035	8
3	brikke_SFA5116-	50_1T	04-060-050	8
4	minifun_sprosse-1	660	07-510-200	4
5	minifunSkive-	Default	07-510-201	4

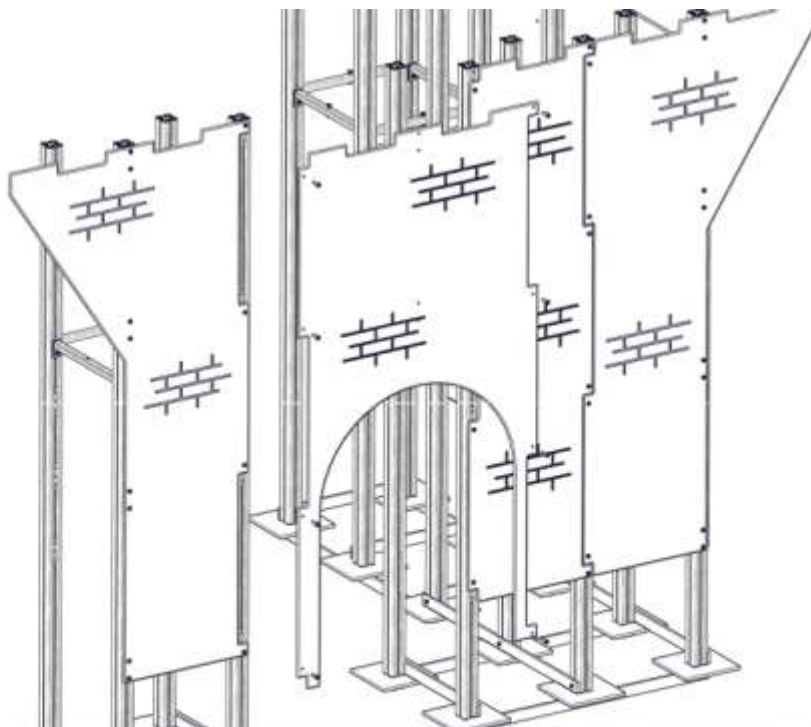

BOM ID	Name	SW Configuration	Artnr (config)	Qty
1	TorxM8-	TXM8x35	04-000-035	8
2	Borge_tarn_poort_jim-1	Default	07-510-503	1

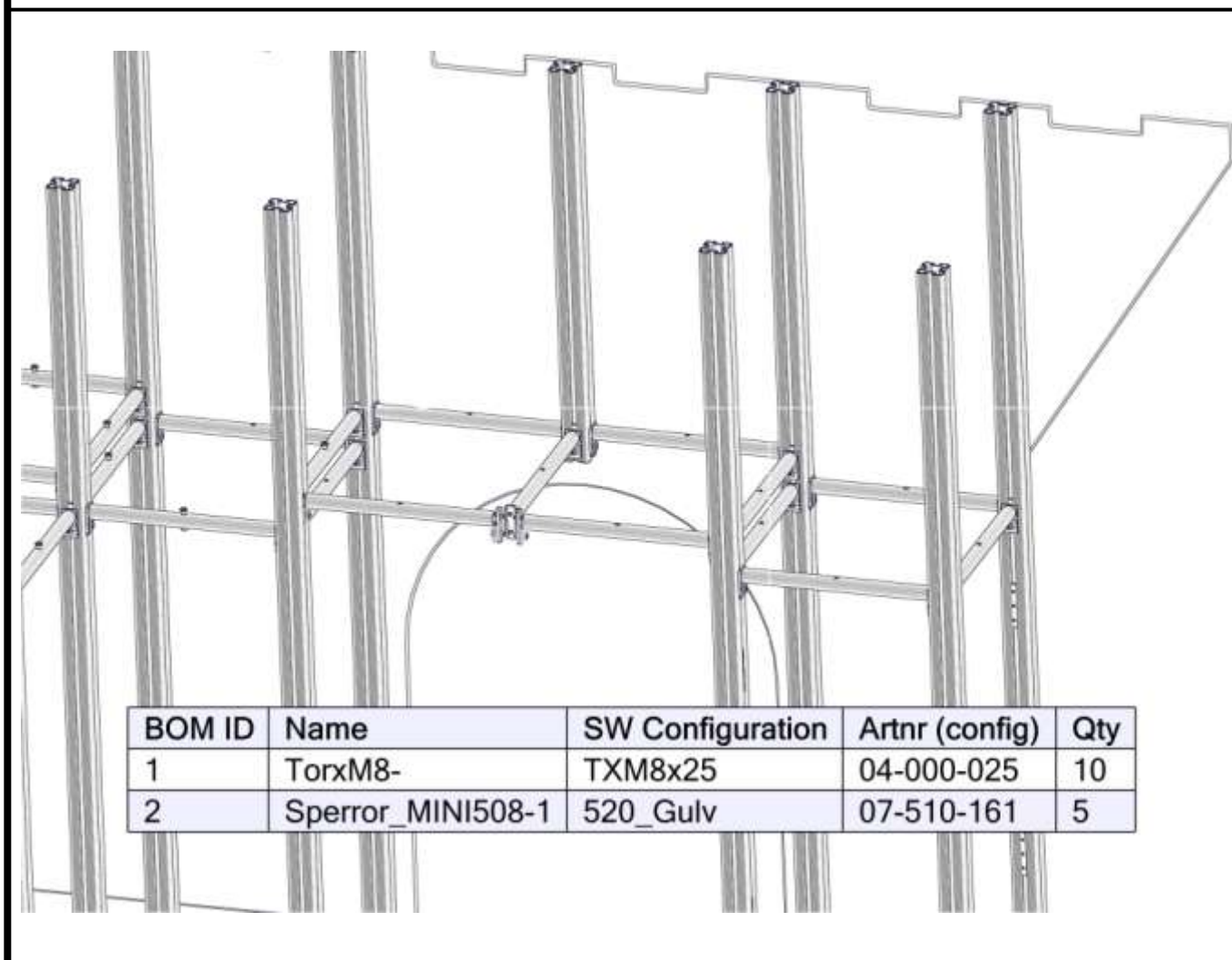
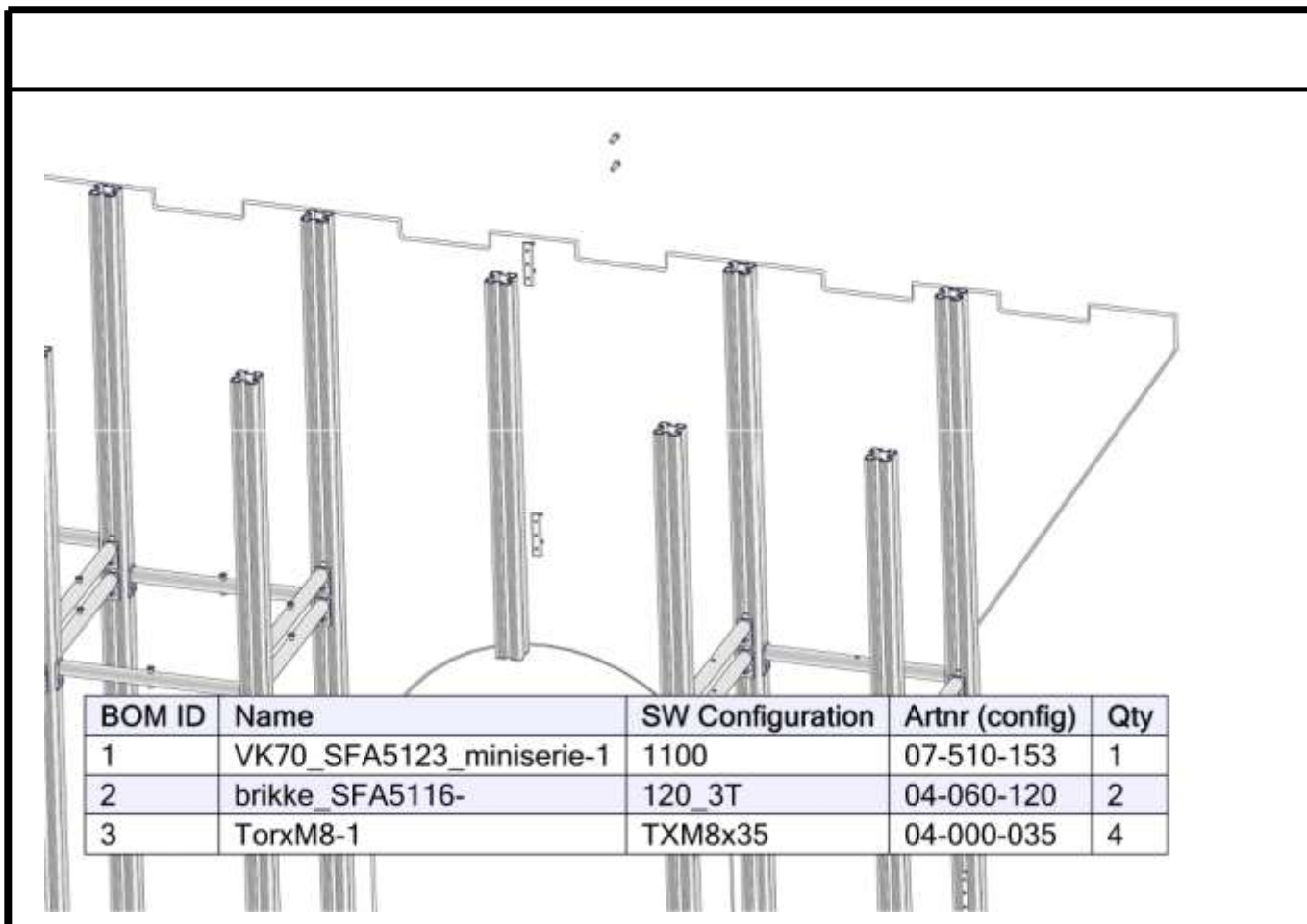

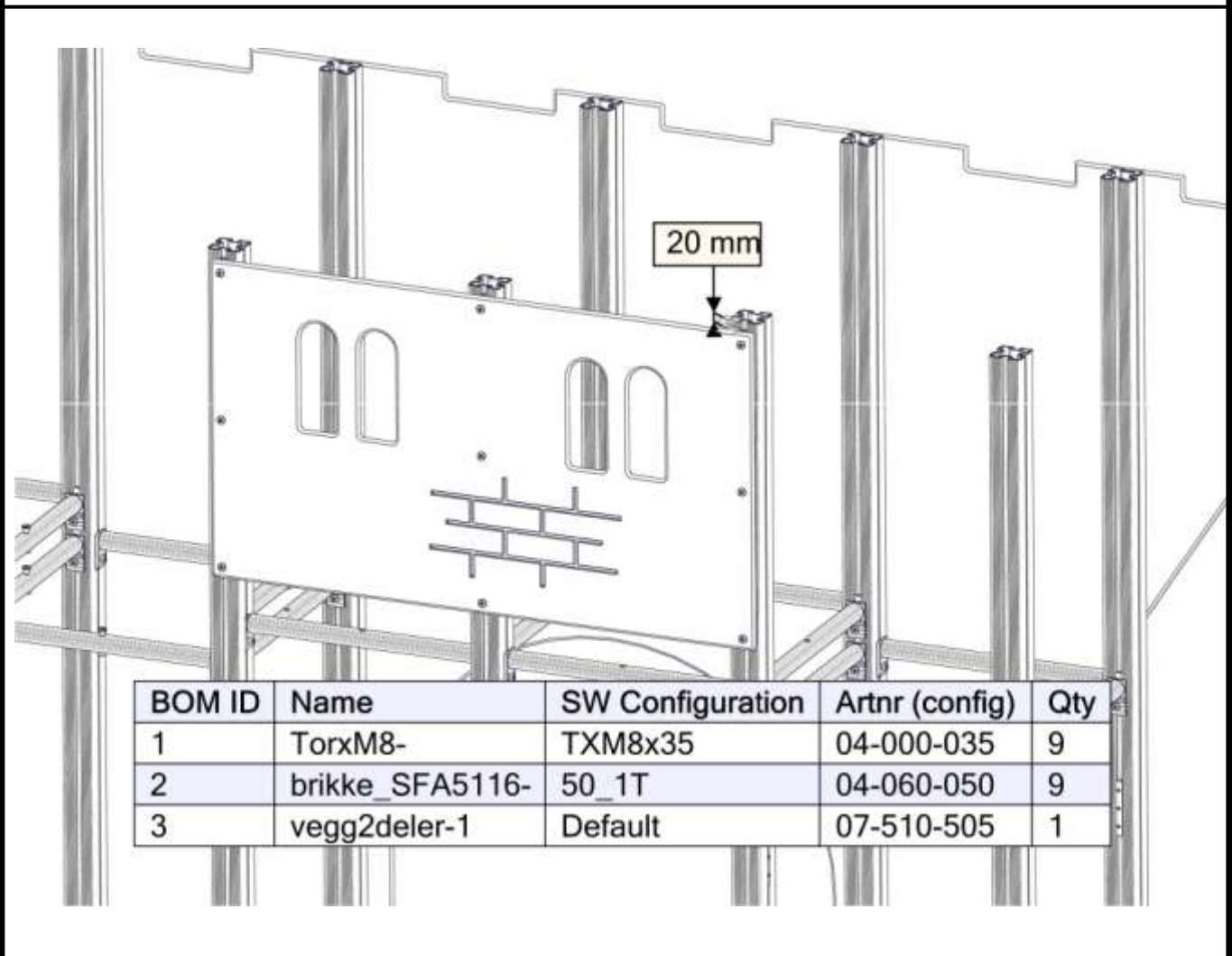
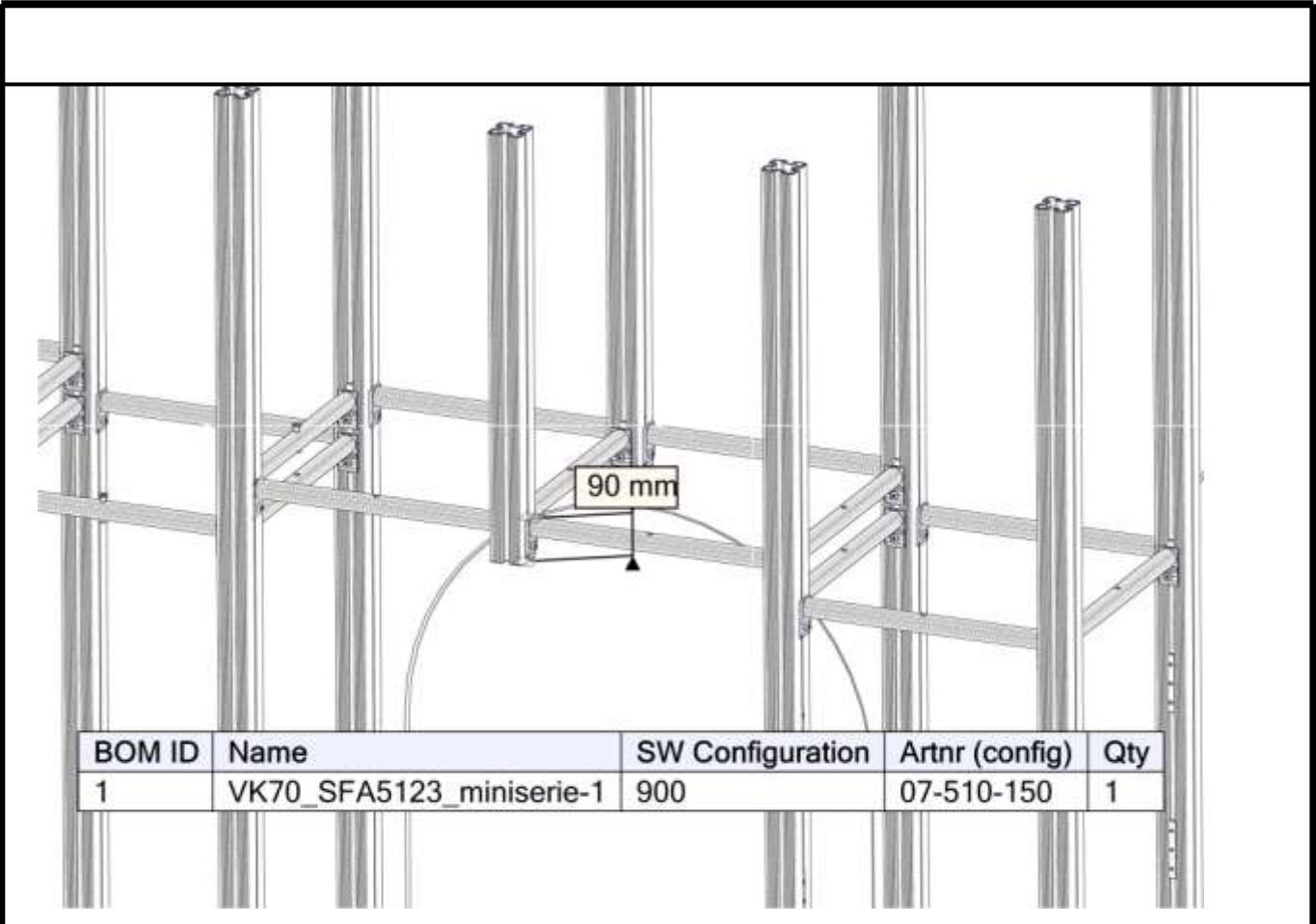

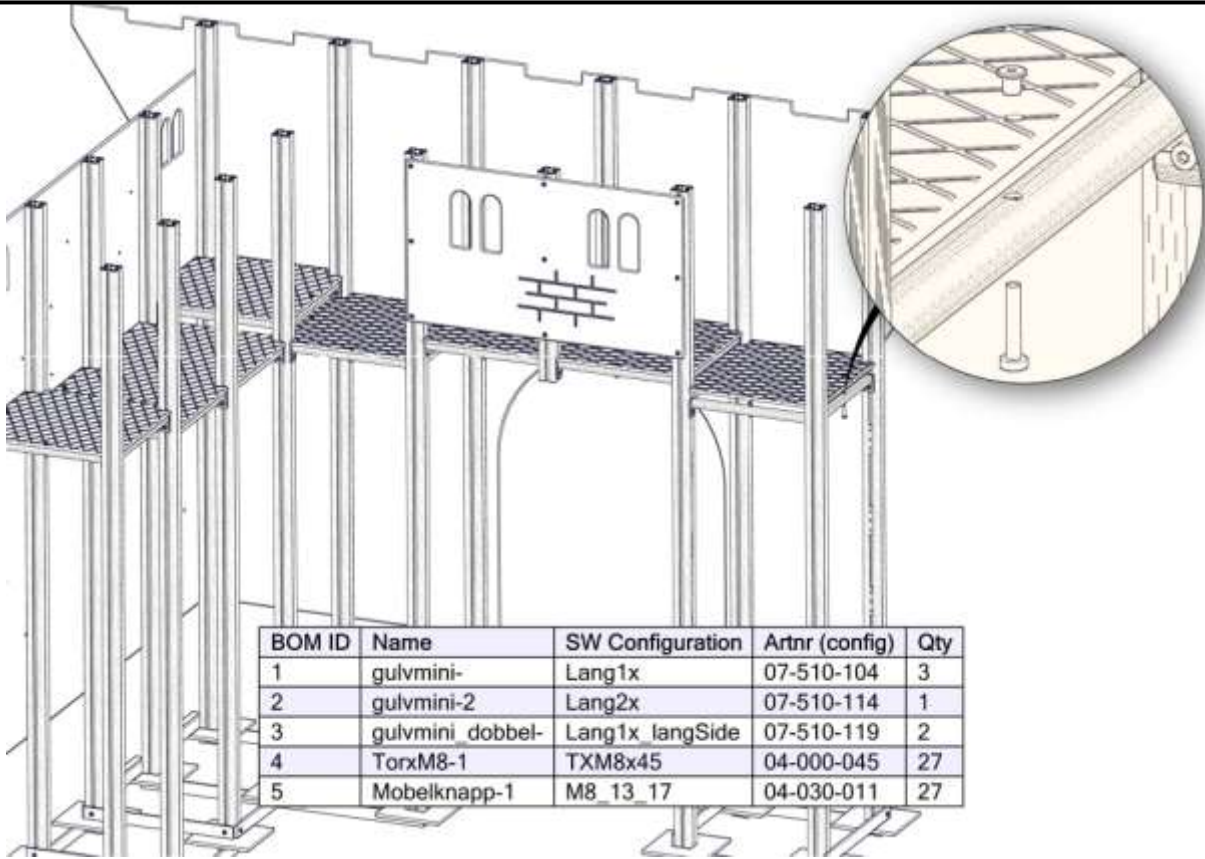

BOM ID	Name	SW Configuration	Artnr (config)	Qty
1	gulvmini-	Lang1x	07-510-104	3
2	gulvmini-2	Lang2x	07-510-114	1
3	gulvmini dobbel-	Lang1x langSide	07-510-119	2
4	TorxM8-1	TXM8x45	04-000-045	27
5	Mobelknapp-1	M8_13_17	04-030-011	27

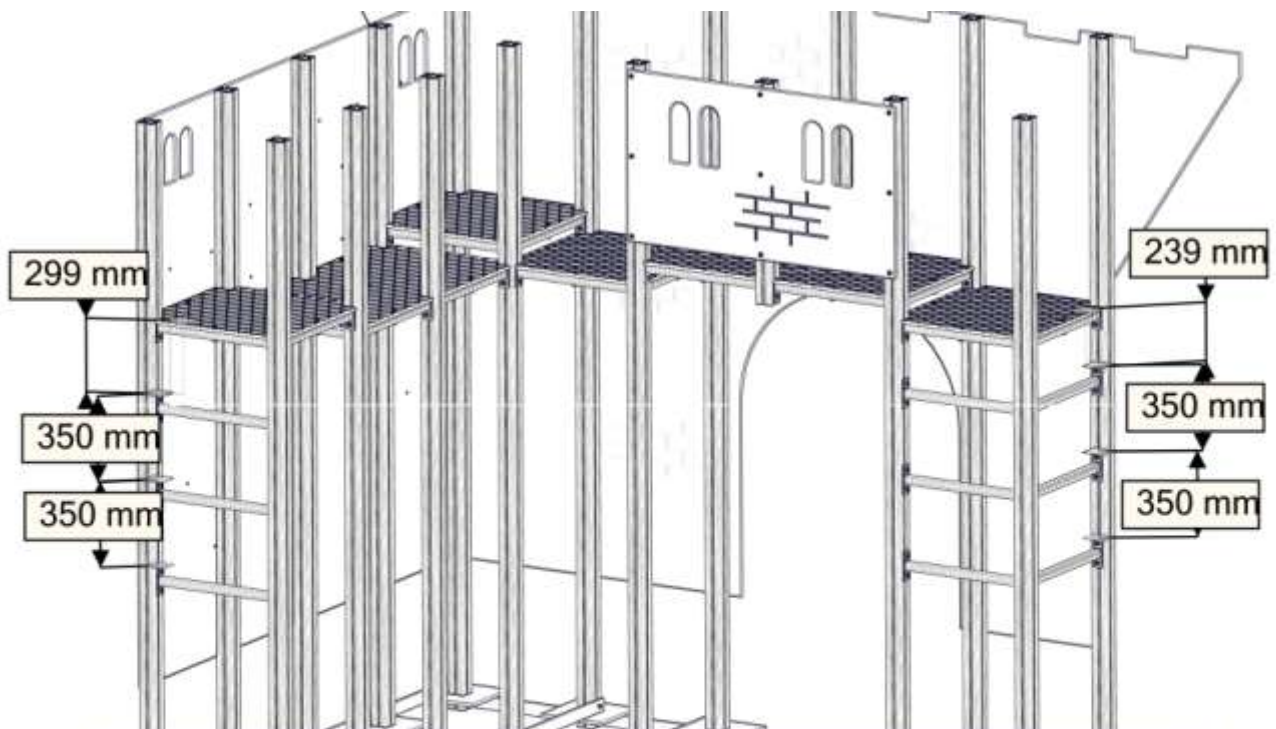

BOM ID	Name	SW Configuration	Artnr (config)	Qty
1	TorxM8-	TXM8x25	04-000-025	36
2	Sperror_MINI508-1	520	07-510-160	9

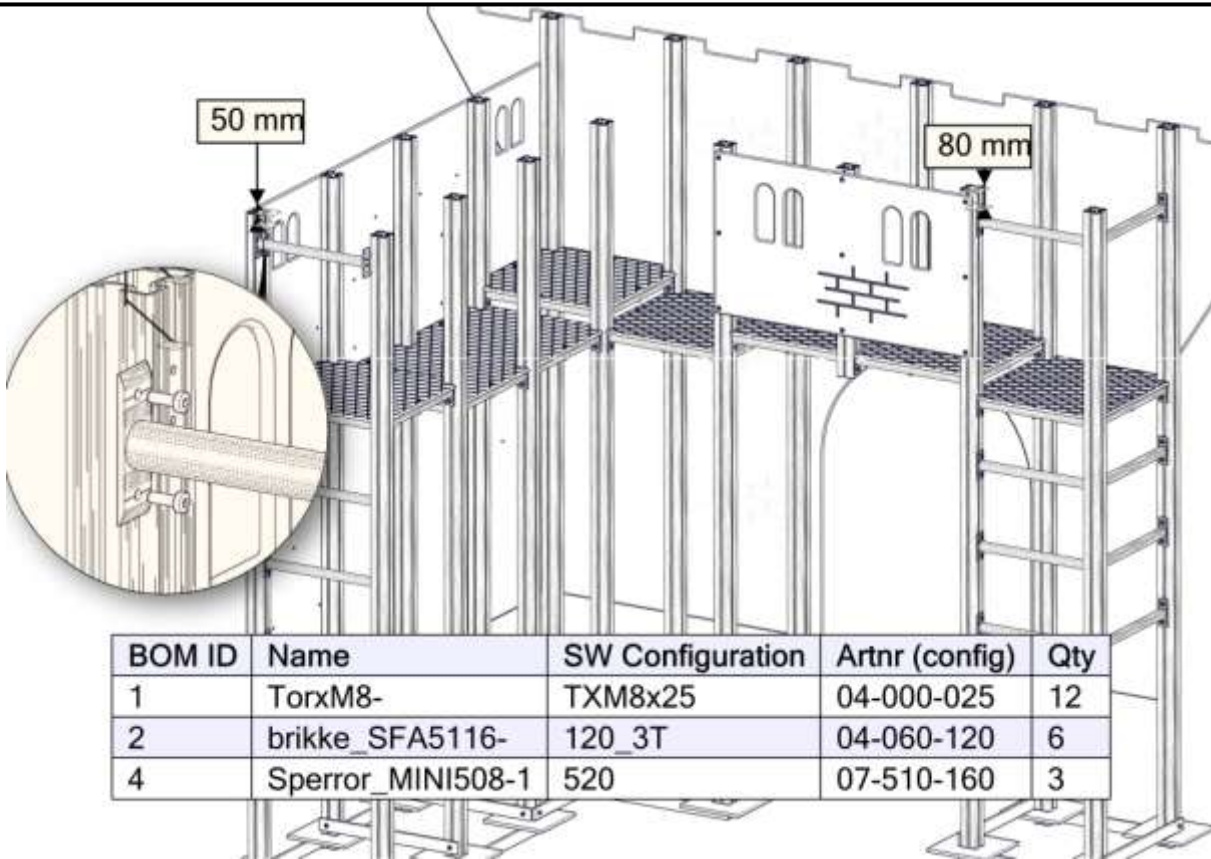



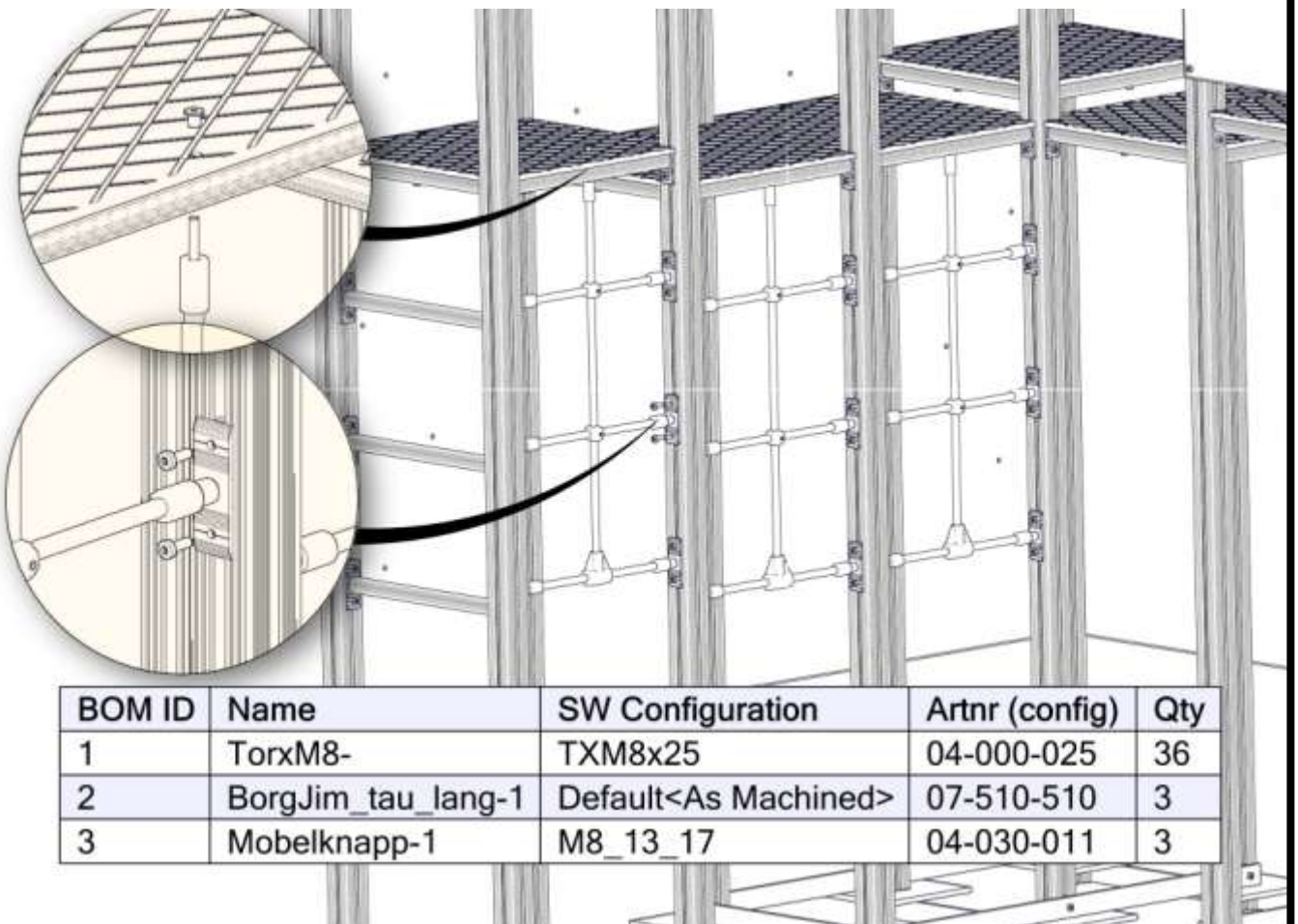

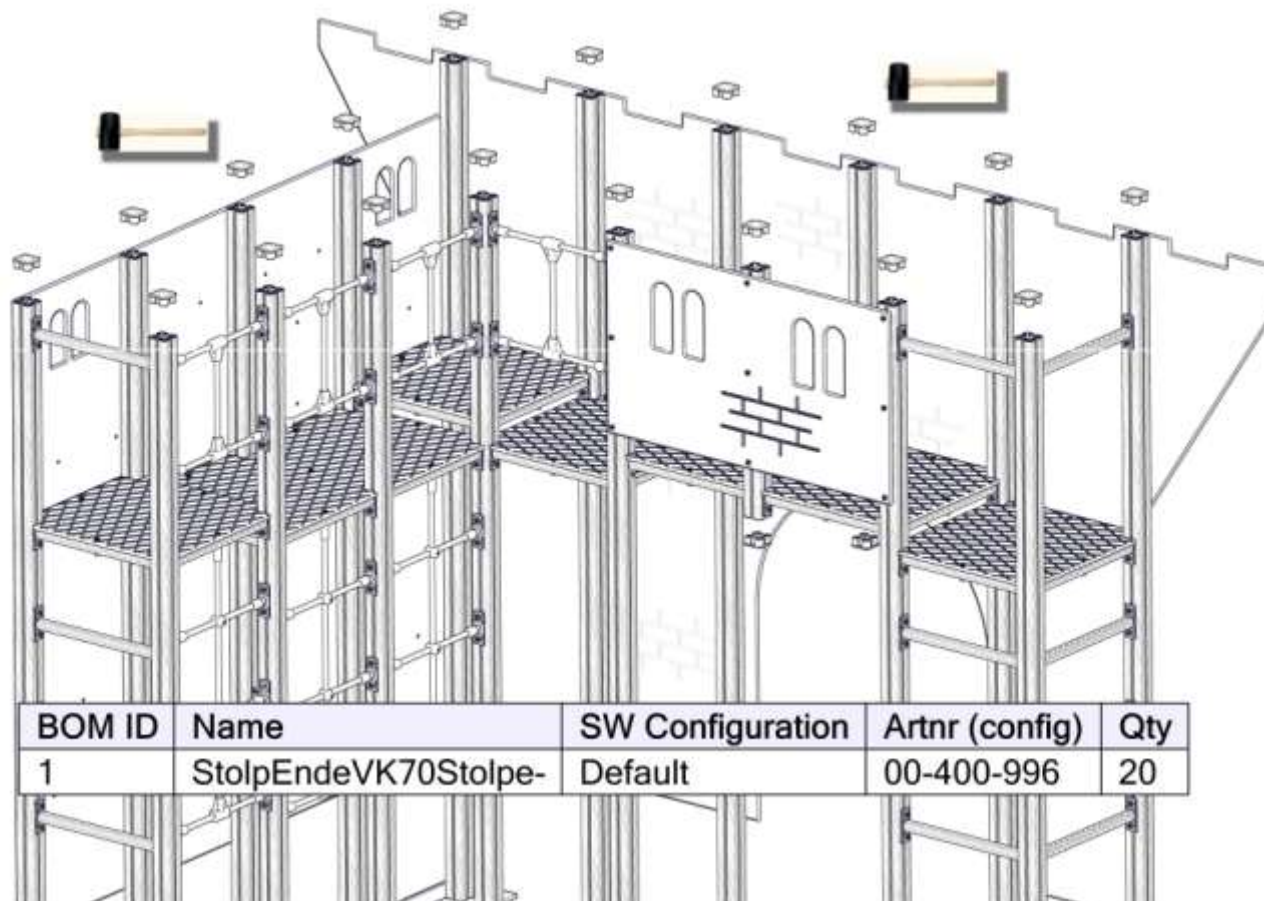
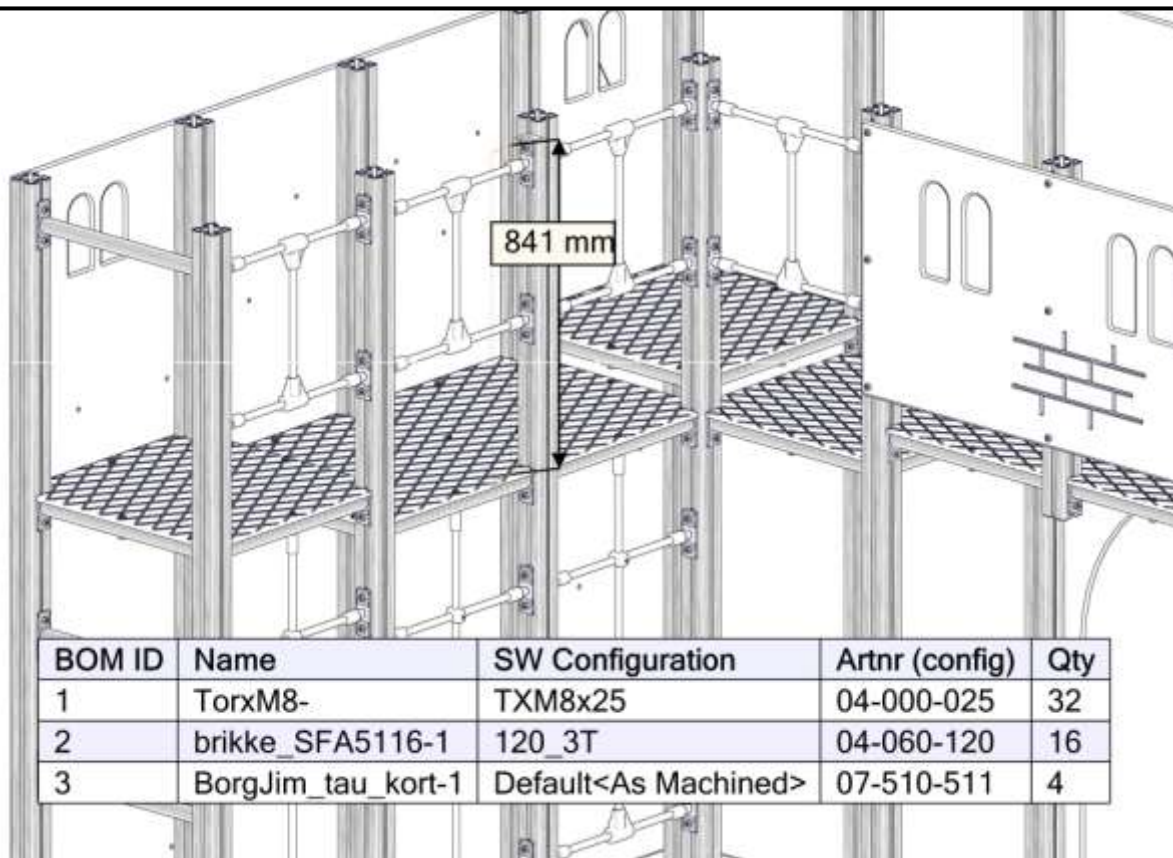

BOM ID	Name	SW Configuration	Artnr (config)	Qty
1	TorxM8-	TXM8x25	04-000-025	12
2	brikke_SFA5116-	120_3T	04-060-120	6
4	Sperror_MINI508-1	520	07-510-160	3













BOM ID	Name	SW Configuration	Artnr (config)	Qty
1	TorxM8-	TXM8x25	04-000-025	36
2	BorgJim_tau_lang-1	Default<As Machined>	07-510-510	3
3	Mobelknapp-1	M8_13_17	04-030-011	3

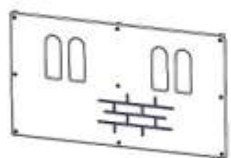

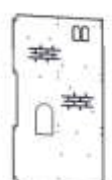
Før utstyret tas i bruk / Before play begins / Innan lekredskapet tas i bruk	
N	<ul style="list-style-type: none"> ● Påse at fallunderlag er utlagt i henhold til gjeldende regler eller vår anbefaling ● Fjern alle monteringshjelpemidler (rester av betong, planker, paller, plast, og lignende) ● Før utstyret tas i bruk, burde man sjekke at det ikke er fare for at anorakksnorer og lignende som kan hekte seg fast noen steder på lekeapparatet. (Vedlagte snor med dobbe (kneledd) kan brukes til å sjekke at dette er i orden. Se vedlagte veiledning for bruk av denne. Dette gjøres for å oppdage eventuelle feilmonteringer.?) ● NB! Bor stå i 2-3 dager før bruk
UK	<ul style="list-style-type: none"> ● Make sure the area and depth of safer surfacing are according to the current standard, or to the manufacturer's recommendation ● Make sure all tools and surplus materials are removed before play begins ● PS! When complete, allow 2-3 days for the concrete to set before use
S	<ul style="list-style-type: none"> ● Kontrollera att fallunderlag är utlagt enligt gällande regler eller vårt rekommendation ● Ta bort alla monteringshjälpmedel (rester av betong, plankor, pallar, plast och liknande) ● Innan lekredskapet används, kontrollera att anoracksnoddar eller kläder/delar av kläder eller liknande inte kan fastna i några delar på redskapet. (Den bipackade "knävringen" kan man med fördel användas för denna kontroll. ● Detta görs för att upptäcka eventuella felmonteringar.)

komponenter		Sign. _____.
	VK70 stolpe L=3100 5	Stolpend VK70 20
	VK70 stolpe L=2900 11	00-400-996
	VK70 stolpe L=1100 1	Fundament mini Skive 16
	VK70 stolpe L=900 1	07-510-201
	Fundament mini 660 8	Fundament mini 1250 6
	07-510-200	07-510-202
	Sperrerør 520 12	Sperrerør gulv 520 30
	07-510-160	07-510-161
	Gulv Mini 1 lang side 3	Gulv Mini 2 lang side hjørne 1
	07-510-104	07-510-114
	Gulv Mini dobbelt 1- lang på langside 2	
	07-510-115	
	Kort krakeness nett 4	Lang krakeness nett 3
	07-510-511	07-510-510

komponenter		Sign. _____.
	Krakeness borg 07-510-501	
	Krakeness borg 07-510-503	
	Krakeness borg 07-510-505	
	Krakeness borg 07-510-506 Med klatregripp	
	Torx M8x25 176 04-000-025	
	Torx M8x35 127 04-000-035	
	Torx M8x45 30 04-000-045	
	Møbelknapp 30 M8x13x17 04-030-011	