

N

**Monteringsanvisning**

EN

**Assembly Instructions**

S

**Monteringsanvisning**

Produkt nr. / Product no. / Produkt nr.

**26-100-022****Grå—trestruktur**

Ord. nr. \_\_\_\_\_

Dato. \_\_\_\_\_

Sign. \_\_\_\_\_

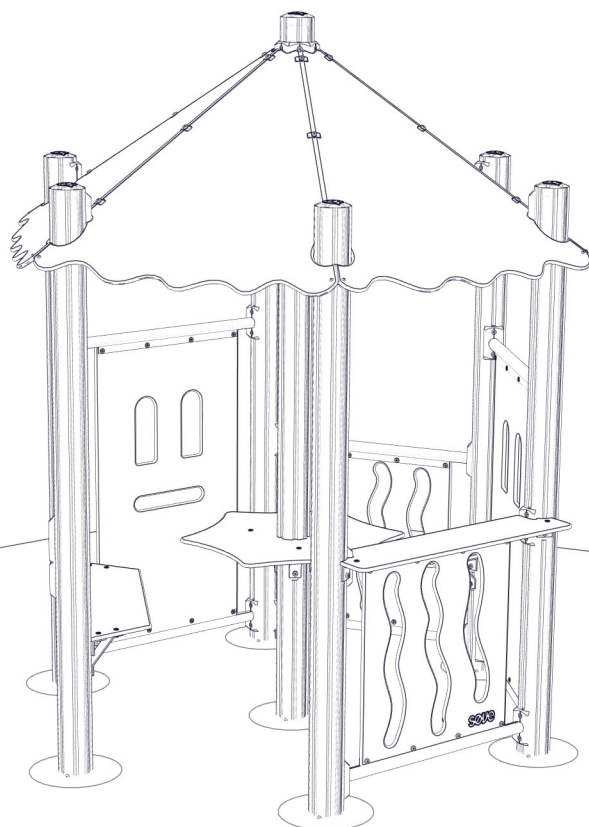
**søve**

Søve AS  
Grønnvoldveien 290  
3830 Ulefoss - Norway  
Tlf: +47 35 94 65 65  
www.sove.no



Søve AB  
EA Rosengrensgatan 32  
421 31 Västra Frölunda  
Phone: +46 (0)31 773 97 00  
www.sove.se

## Monteringstips / Assembly Advice / Monteringsstips

N

- Les monteringsanvisningen nøye før montering.
- Monter elementene i rekkefølgen som vist.
- Boltene bør ikke skrues for hardt til før alt er montert, vatret og loddet. Skru så boltene til.
- NB! Ved bruk av drill, kan boltene ryke.
- På grunn av at solen kan gjøre rutsjeflaten veldig varm, bør rutsjebanens utløp vende mot nord-øst eller nord-vest.
- Er lekeutstyret plassert i naturlige ferdselstraséer må området sikres mot gjennomgang.
- Innspringningshinder bør vurderes rundt lekeapparater hvor det er stor bevegelse, f.eks. ved huskestativ.
- Det bør være fritt innsyn til lekeutstyr som er beregnet for barn under 3 år.

**NB! Under monteringsarbeidet må utstyr, som ikke er forankret forsvarlig i bakken, sikres slik at det ikke velte.**

**Området må avstenges under montering av apparatene med sperrebånd eller lignende.**

EN

- Read the instruction carefully before assembling the play unit.
- Assemble the components in the sequence shown in these instructions. Fixings must not be fully tightened during assembly. Before casting the foundations, the structure must be level and plumb, at which point all fixings are tightened. PS! If use of drill, the bolts may be wrecked.
- Avoid positioning the slide facing due south because of overheating – ideal positions are facing north-east or north-west. Secure the construction-area to prevent people from walking through it.
- Consider installing barriers around play-equipment which gives rise to a lot of activity – i.e. swings.
- Ensure that clear vision is possible across the play area so that supervision is possible from any position, particularly where children under 3 years of age will be playing.

**NB! During assembly of the equipment, ensure that all structures are securely propped, especially when left overnight. Also ensure that equipment is supported**

## Monteringstips / Assembly Advice / Monteringsstips

**S**

- Läs monteringsanvisningen noga före montering.

- Montera delarna i den ordningen som anvisas
- Skruvarna bör inte skruvas för hårt tills allt är monterat, i våg och lodat.









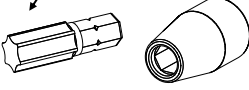

OBS! Används elektrisk skruvdragare, kan bulten gå sönder. Hårdra därför manuellt!

- Solen kan göra att rutchbanan blir väldigt varm. Banans nedfart rekommenderas att vändas i norrlig riktning
- Om lekplatsen placeras vid en gångväg mm bör området säkras mot genomfart av gående och cyklister.
- Insprängningshinder bör placeras runt lekutrustning med stor rörelse, t ex, gungställning.
- Det bör vara fri insyn till lekutrustning beräknat till barn under 3 år.

**OBS! Under monteringsarbete bör utrustningen som inte ska förankras i marken, ställs så att den inte kan välta.**

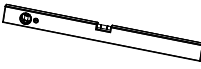
**Området måste spärras när lekutrustningen byggs upp, med avspärrningsband eller liknande.**

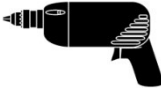
**Nødvendig verktøy / Tools required / Nödvändiga verktyg**

<p>(N)</p> <p>(EN)</p> <p>(S)</p>	<p>(A)</p> 	<p>(B)</p>  <p>Torx Nr 45 High quality</p> 	<p>(C)</p>  <p>13 + 17mm</p> 	<p>(D)</p> 	<p>(E)</p> 
		<p>Metermål</p> <p>Metric measure</p> <p>Tumstock</p> 	<p>16 V</p> 	<p>Merkebånd</p> <p>Mark ribbon</p> <p>Märkeband</p> 	<p>5 mm</p> <p>6 mm</p> 

**Nødvendig antall personer / Number of persons required / Rekommenderad antal personer**



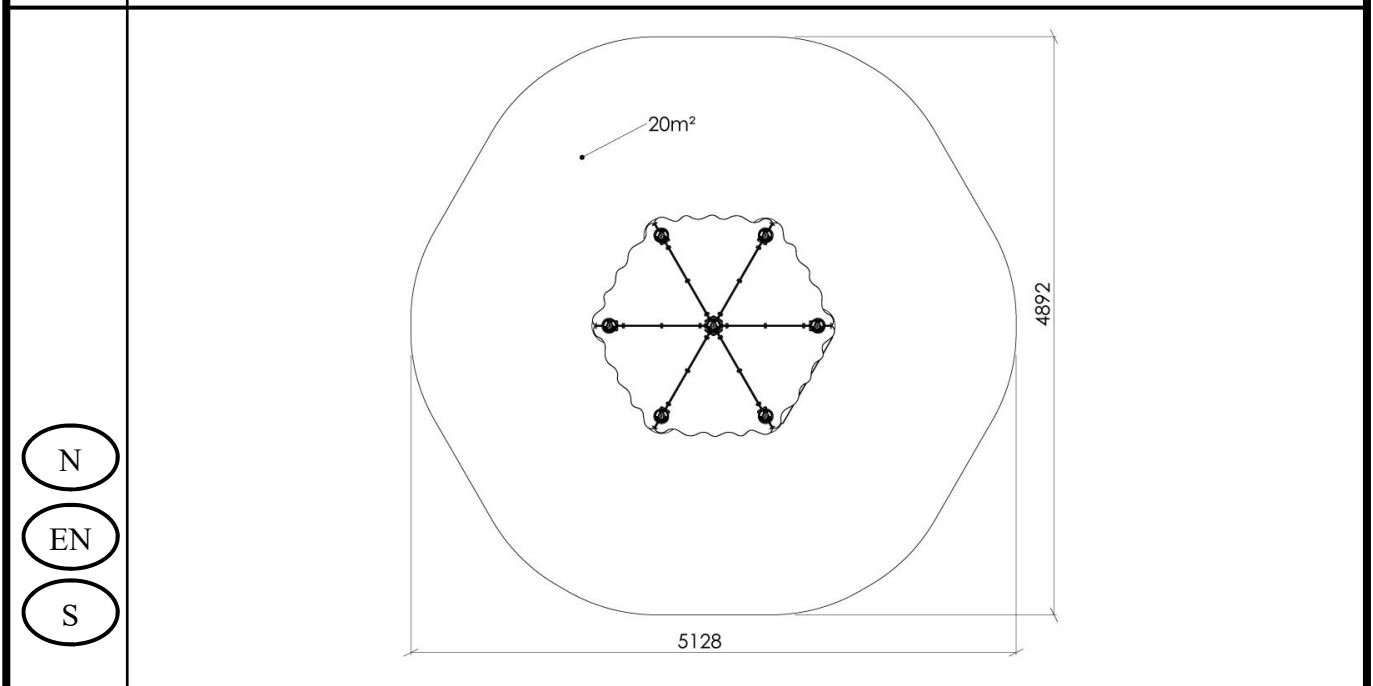

<p>(N)</p> <p>(EN)</p> <p>(S)</p>	
-----------------------------------	--

**Anbefalt arealbehov ved montering / Recommended working space / Rekommenderad arealbehov vid montering**



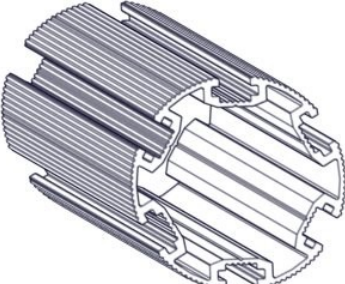

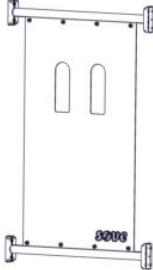
**Boltepakker for / Boltpackage for / Bultpaket för**



Sign. \_\_\_\_\_.

Villmark lekehus 6-kant 2 26-100-022	Navn	Artnr/ dimensjon	Ant	Lev
	Stolpe Ø110 L=2500 Grå 600-1900  Stolpe Ø110 L=3000 Grå 600-2400	SFA5126/2  SFA5126/2	6  1	
	Endelokk til stolpe Ø110	00-400-995	7	
	Rekkverk 770x1100 cc880 Postkasse Trestruktur	07-302-182K (se egen delmontering)	1	
	Rekkverk 620x100 med vindu Trestruktur	07-302-181K (se egen delmontering)	1	
	Rekkverk 655x610 cc880 Trestruktur	07-302-180K (se egen delmontering)	3	

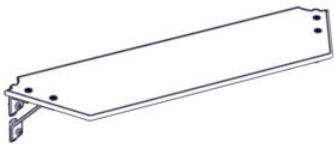
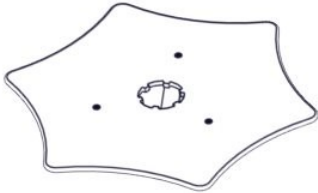
**Boltepakker for / Boltpackage for / Bultpaket för**

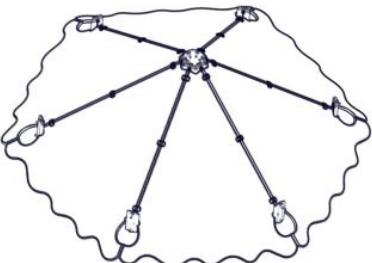
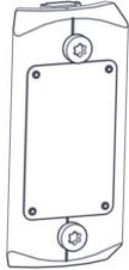
Sign. \_\_\_\_\_.

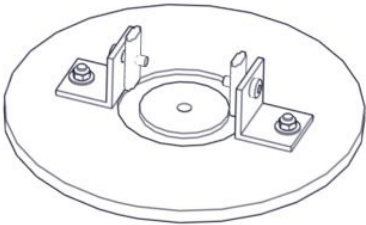
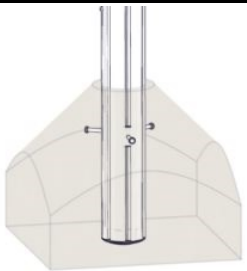
Villmark lekehus 6-kant 2 26-100-022	Navn	Artnr/ dimensjon	Ant	Lev
	Sitebenk 6kant hus Grå	07-520-609K (se egen delmontering)	2	
	Bord 6kant hus Grå	07-520-606K (se egen delmontering)	1	
	Butikdisk cc880 Grå	07-520-622K (se egen delmontering)	1	
	Tak 6-kant CC = 880 Steel material	07-520-750K (se egen delmontering)	1	
	Produkt merke Made in Norway merke	07-500-500 (se egen delmontering)	1	

<b>Boltepakker for / Boltpackage for / Bultpaket för</b>		Sign. _____.		
Villmark lekehus 6-kant 2 26-100-022	Navn	Artnr/ dimensjon	Ant	Lev
	<b>Nedgravnings fundament</b>			
	Sperrør rett Lengde = 750 Uten hull Sort	07-500-075K (Se egen del- montering)	12	
	Fundamentplate 1xØ110 stolpe	07-400-101K (Se egen del- montering)	7	
	<b>Fundament Støp</b>			
	Fundament betong Stolpe Ø110	00-003-111K (Se egen del- montering)	7	
	Sperrør rett Lengde = 750 Uten hull Sort	07-500-075K (se egen del- montering)	12	

**Boltepakker for / Boltpackage for / Bultpaket för**

Sign. \_\_\_\_\_.

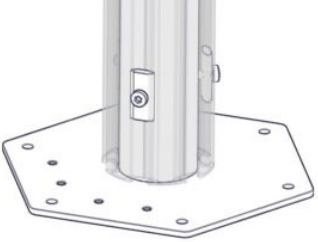
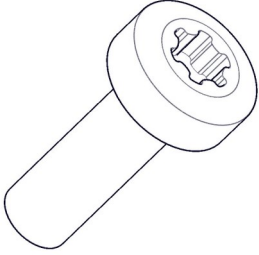
Villmark lekehus 6-kant 2 26-100-022	Navn	Artnr/ dimensjon	Ant	Lev
	<b>Overflate monte- ring</b>			
	Fundament 1xØ110 stolpe for Betongdekke	00-003-113K (se egen dele- montering)	7	
	Stolpe kappes	SFA5126/1	7	
	Korte bolter	00-003-132K	24	



**Fundamentering med betong // Foundation concrete // Förankring med betong**

- (N) Komprimert masse Ref NS-EN 1176-1 §4.2.8.5
- (EN) Compressed mass
- (S) Komprimerad massa



- (N) Bakkenivå
- (EN) Ground level
- (S) marknivå

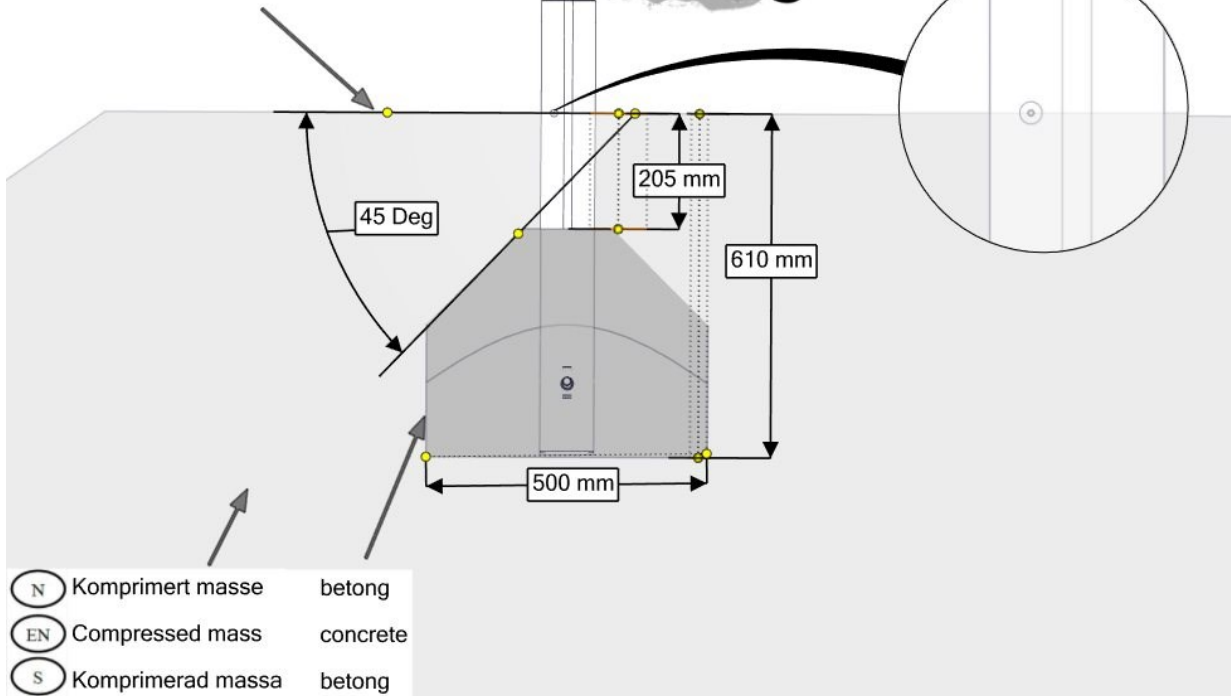

**Fundamentering uten betong // Foundation without concrete // Förankring utan betong**

- (N) Støtdempende materialer Ref NS-EN 1176-1 §4.2.8.5
- (EN) Impact attenuating materials
- (S) Støtdämpande material



- (N) Bakkenivå
- (EN) Ground level
- (S) marknivå

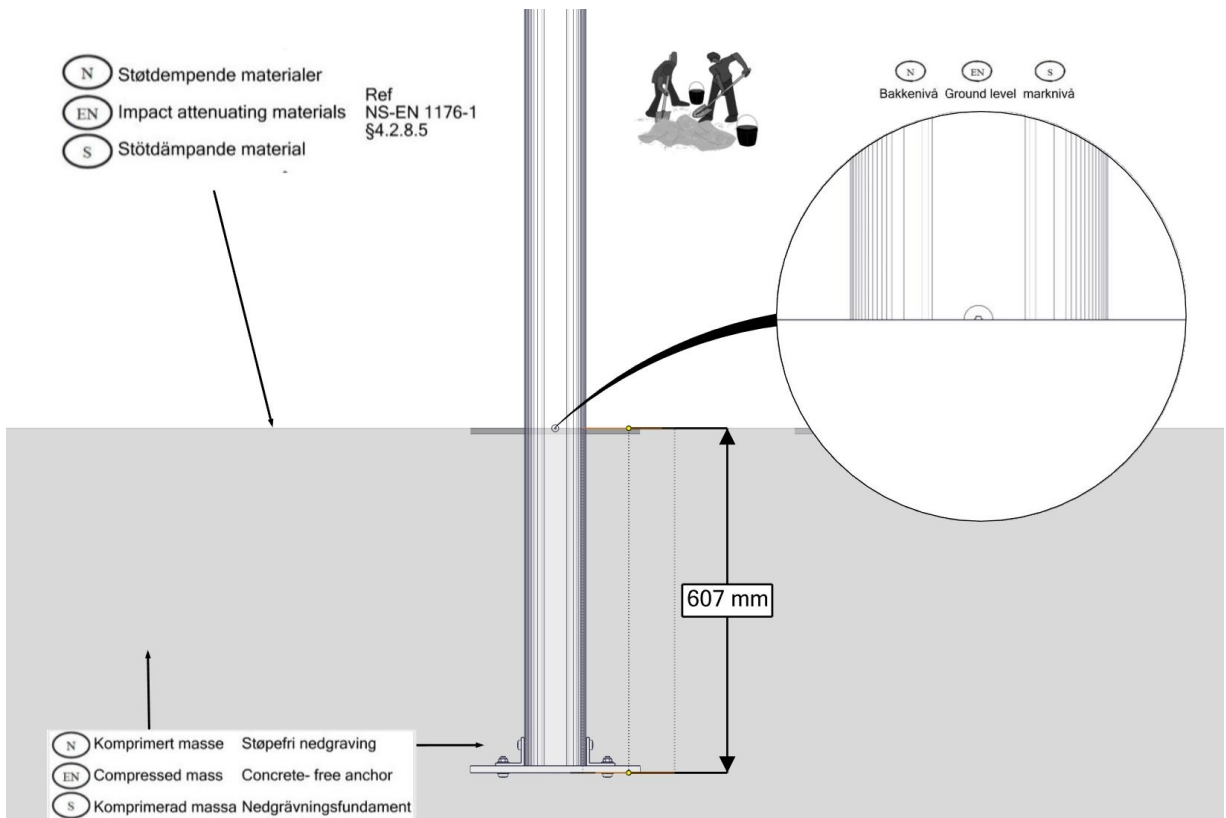

### Overflatemontering/ Surface mounting/ Ytmontering

Ref.  
NS-EN 1176-1  
§4.2.8.5

(N) (EN) (S)  
Bakkenivå Ground level marknivå

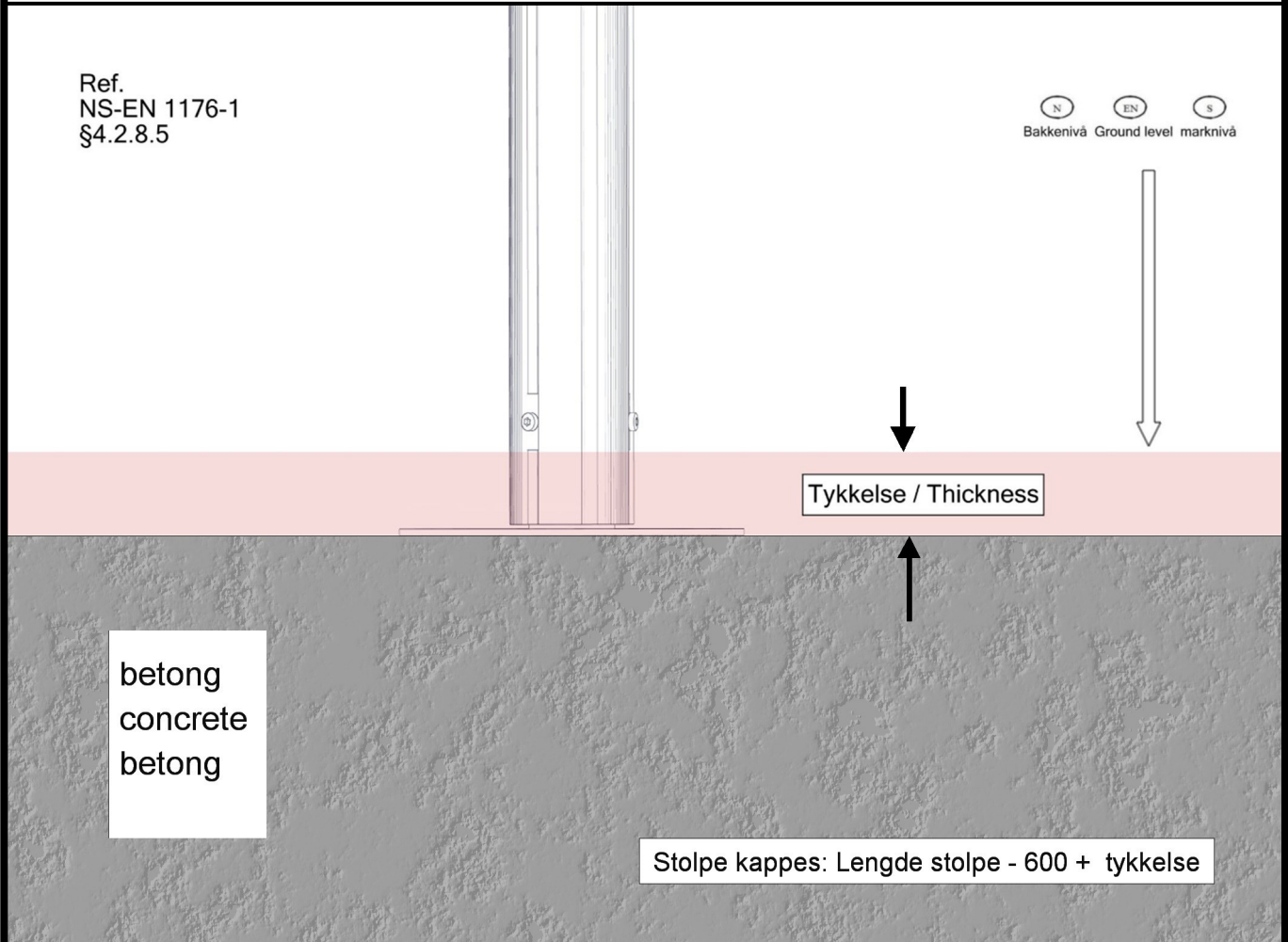

betong  
concrete  
betong

Stolpe kappes: Lengde stolpe - 600 + tykkelse

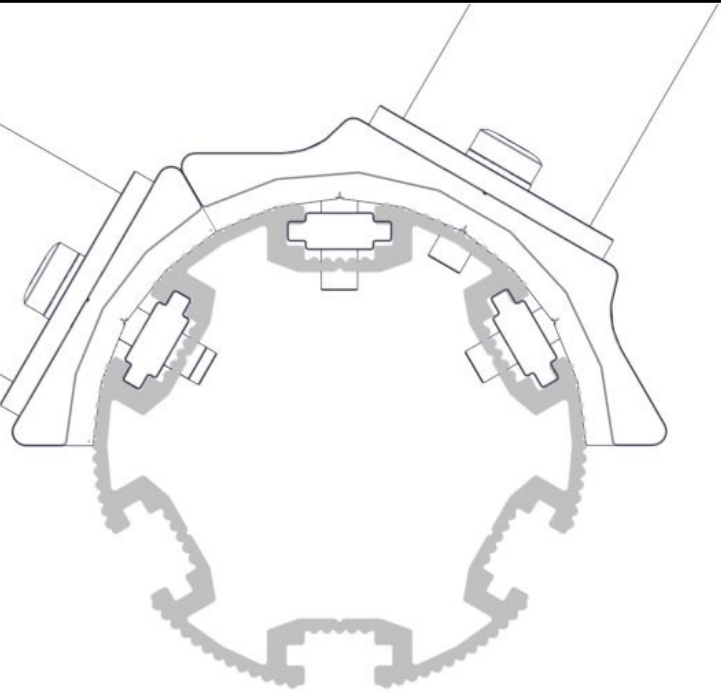
<p><b>N</b></p> <p>Bolten skrues HELT igjennom aluminiumen. Maks moment: 30Nm</p> <p><b>EN</b></p> <p>The bolt must be tightened in to the post, so that it peirces the aluminium Max torque: 30Nm</p> <p><b>S</b></p> <p>Bulten skivas HELT igjennom aluminiumen. Maks vridmoment: 30Nm</p>				
NO	Betongkvalitet	C25/30		
SE	Betongkvalitet			
EN	Concrete quality			
NO	Mengde betong		0,7	m <sup>3</sup>
SE	Mängd betong			
EN	Amount of concrete			
NO	Fundament størrelse		0,5 x 0,5 x 0,4	m
SE	Stiftelsestorlek			
EN	Foundation size			
NO	For sikkerhet må fundamentene med sand eller myk jord være minst 50% større i areal			
SE	För säkerheten måste grunden med sand eller mjuk jord vara minst 50% större i området			
EN	For safety, the foundations with sand or soft soil must be at least 50% larger in area			
NO	Tyngste element	07-302-102	11	Kg
SE	Tyngsta element			
EN	Heaviest element			
NO	Største element	07-302-102 SFA5126/1	1,1x0,6x0,02 L=3,0 Ø=0,11	m
SE	Största element			
EN	Biggest element			

### Fallhøyder / Free height of fall / Fallhöjder

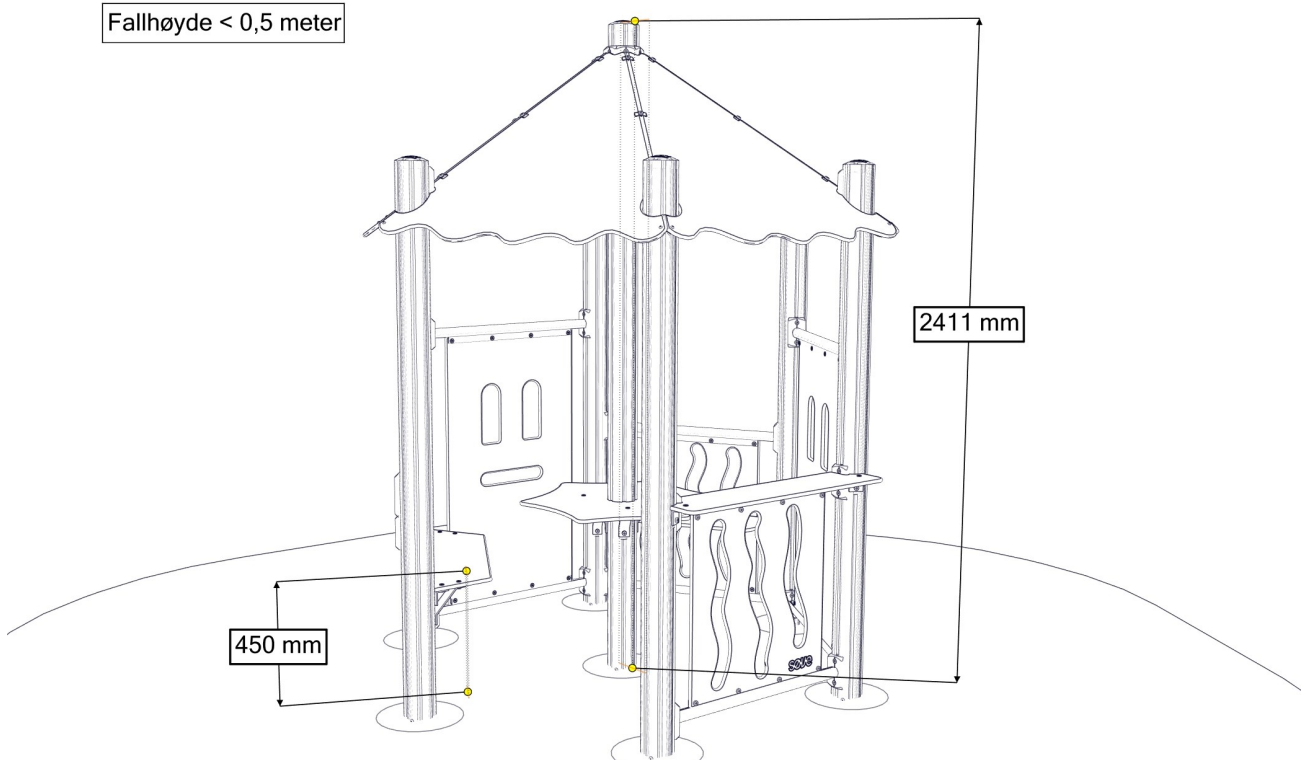

### Sikkerhetszone / Safety zone / Säkerhetszon

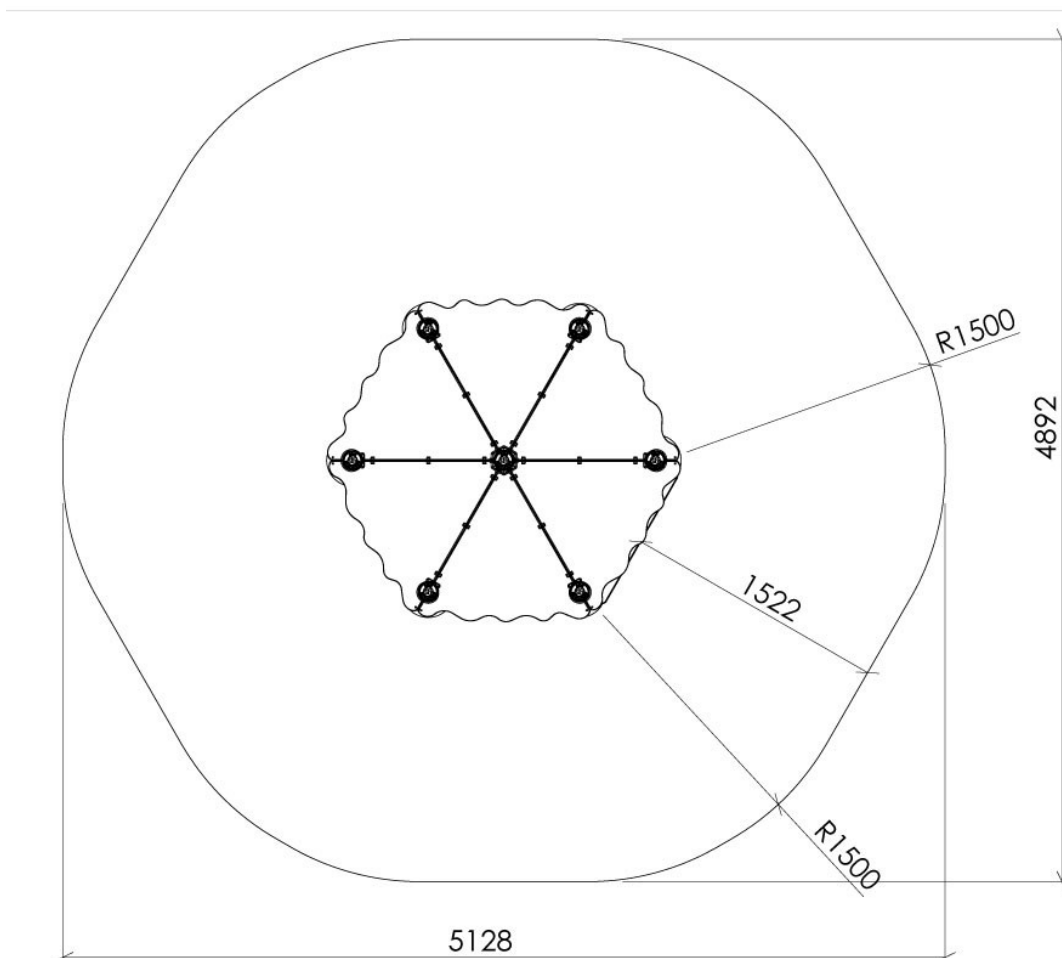

### Plassering av forankringer / Ground plan / Placering av förankringar

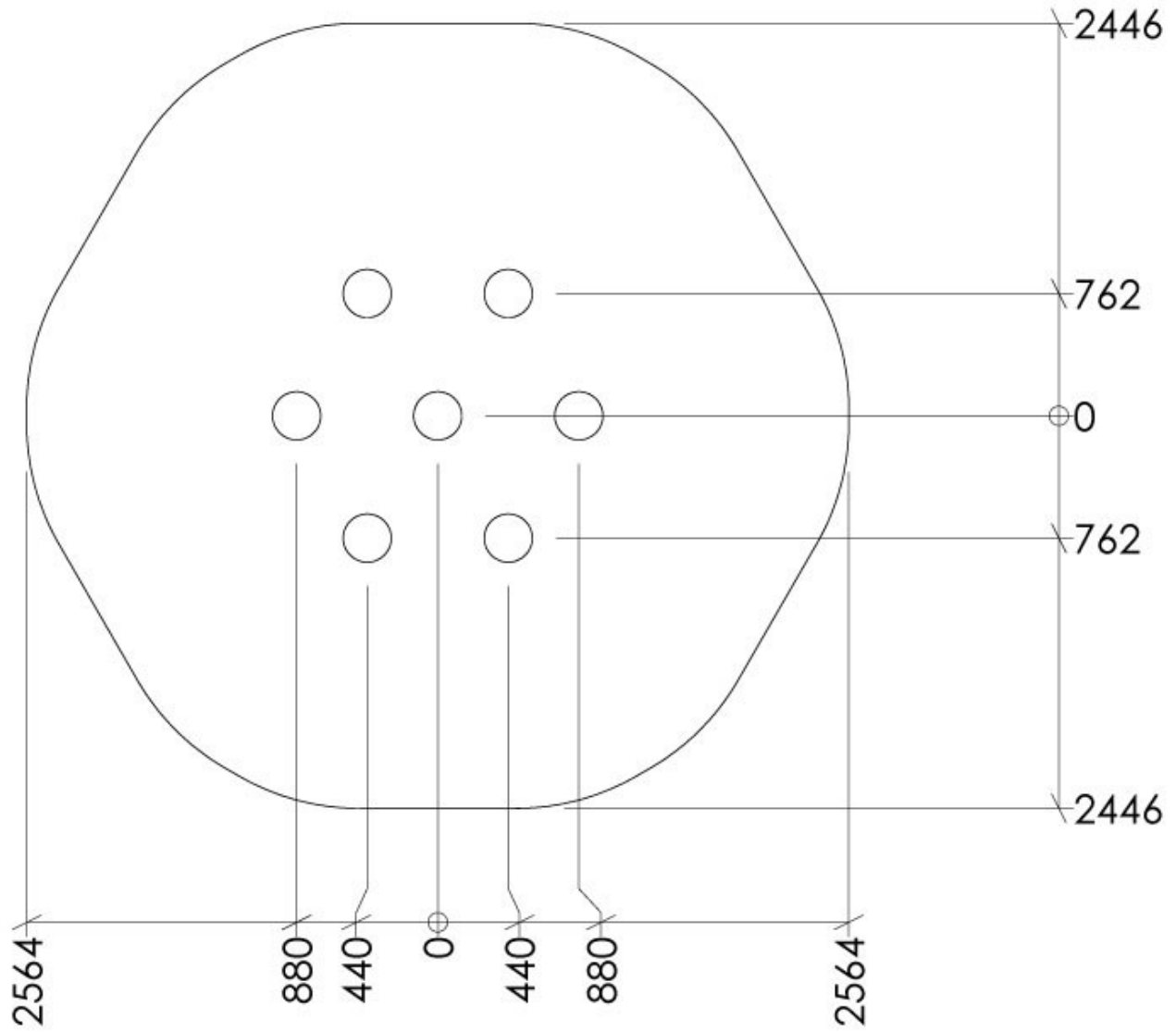

N

Alle mål er oppgitt i millimeter

EN

Scale measured in mm

S

Alla mått är i millimeter.

## Montering av lekeapparatet / Assembly instructions / Montering av lekredskapet

Se separat delmontering for detaljer  
 See separate assembly for details  
 Se separata delmontering för detaljer

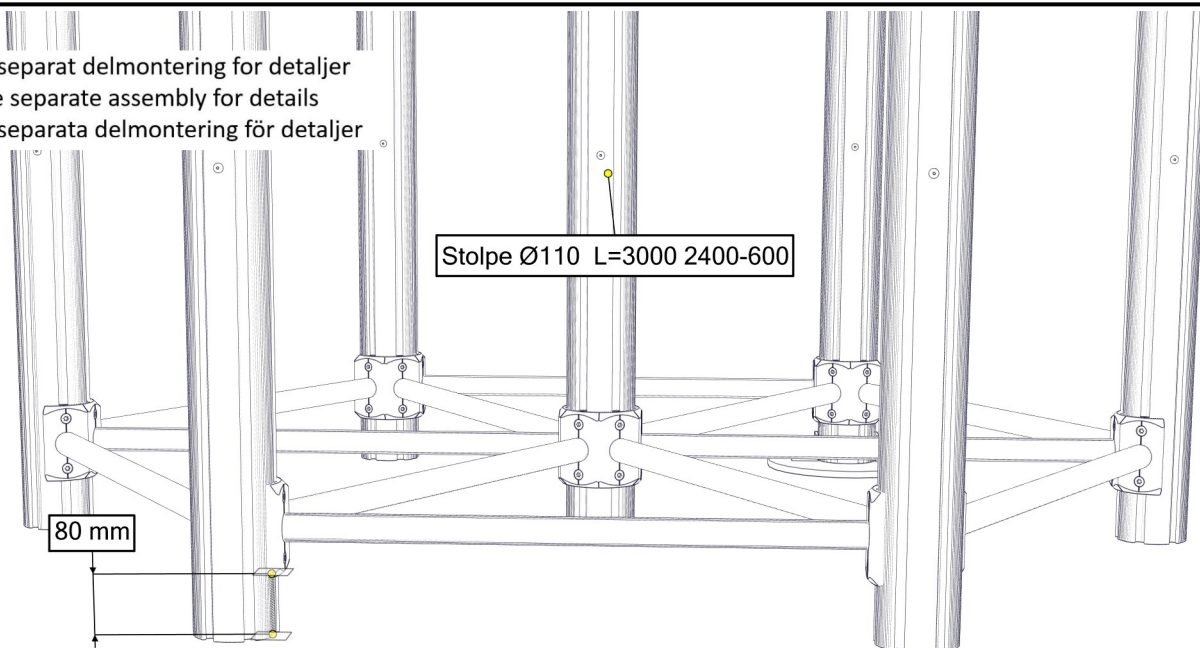

PartName	Artnr	Antall
Sperrerør rett L=750 uten hull	07-500-075K	12
Stolpe Ø110 L=2500 600-1900	SFA5126/2	6
Stolpe Ø110 L=3000 2400-600	SFA5126/2	1

Se separat delmontering for detaljer  
 See separate assembly for details  
 Se separata delmontering för detaljer

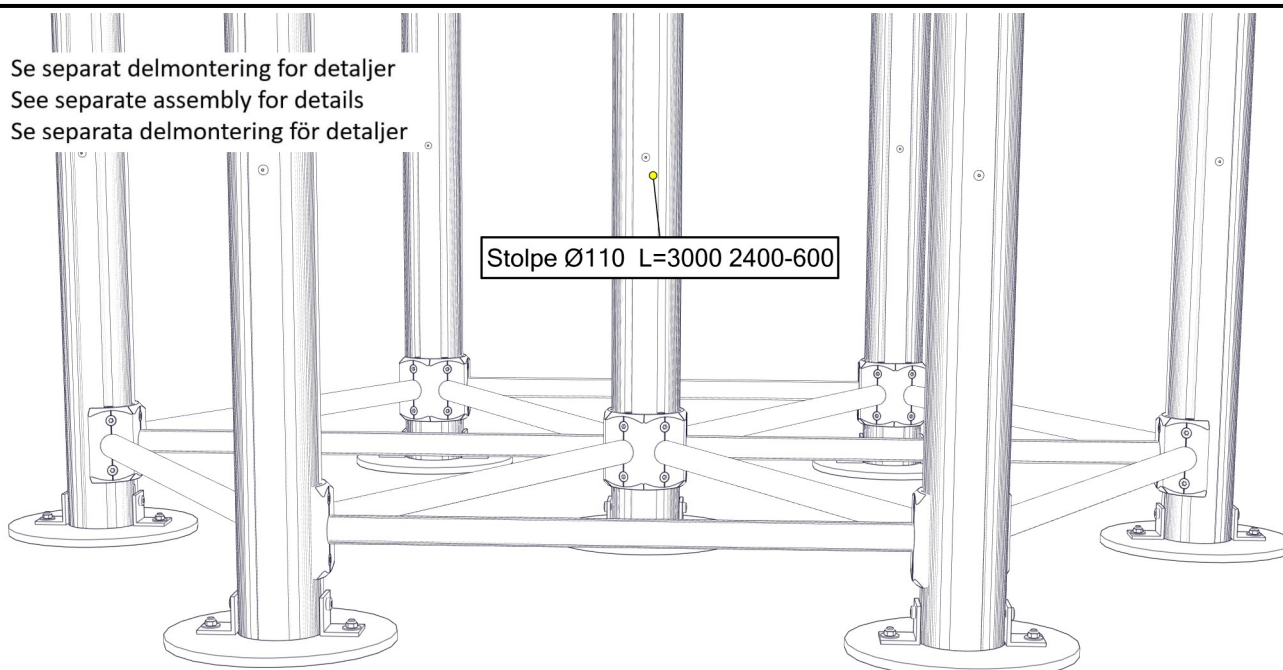

PartName	Artnr	Antall
Fundamentplate 1x110 stolpe komplett	07-400-101K	7

## Montering av lekeapparatet / Assembly instructions / Montering av lekredskapet

Se separat delmontering for detaljer  
 See separate assembly for details  
 Se separata delmontering för detaljer

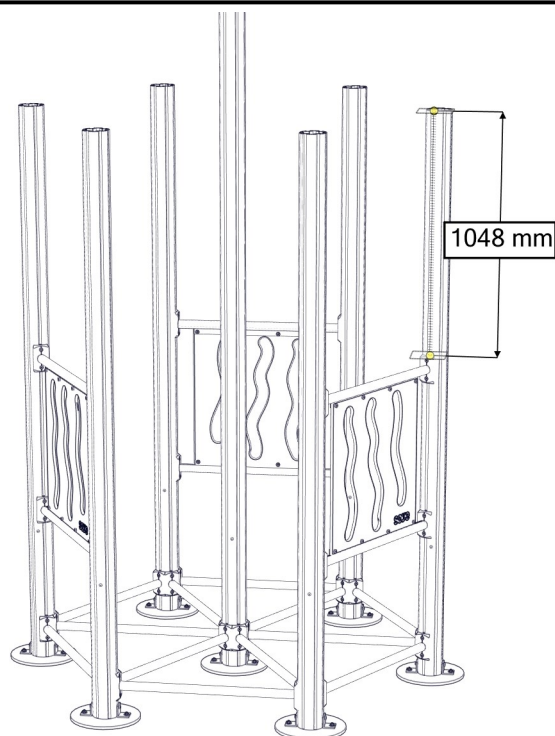

PartName	Artnr	Antall
Rekkverk åpen 655x610 cc880	07-302-180K	3

Se separat delmontering for detaljer  
 See separate assembly for details  
 Se separata delmontering för detaljer

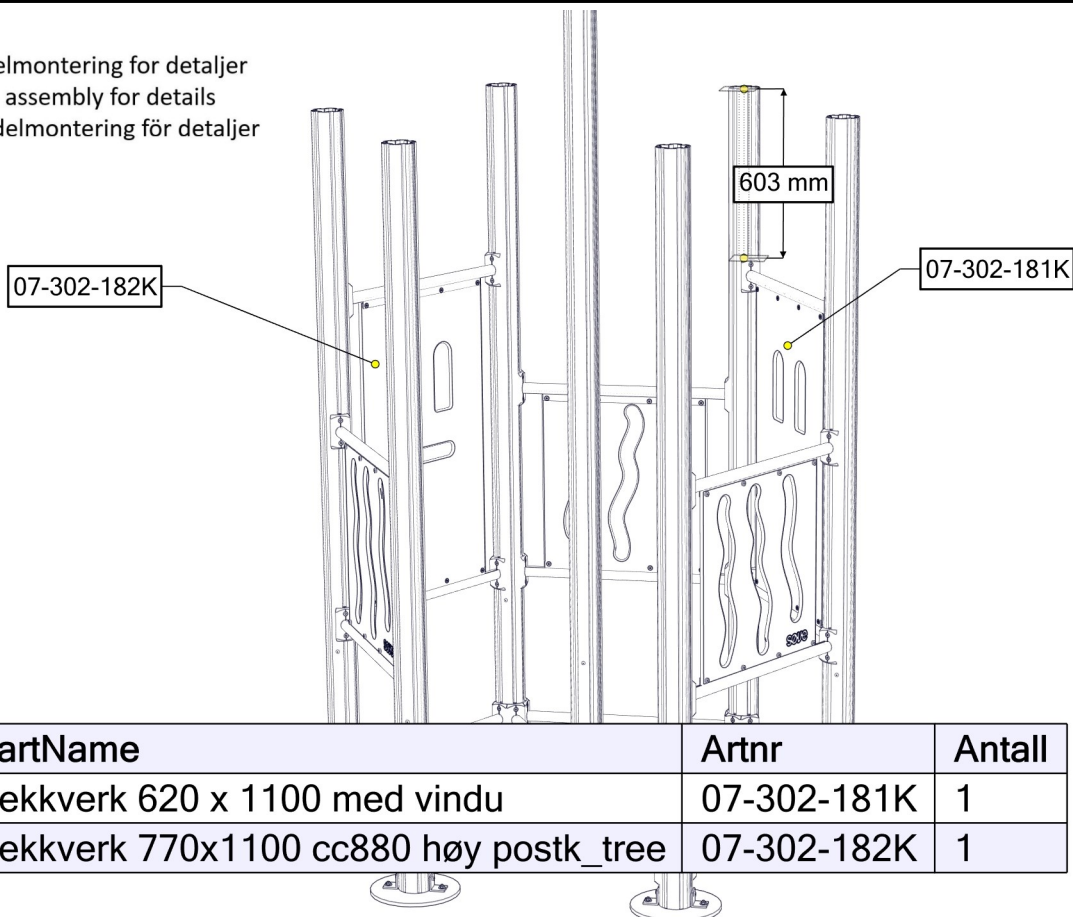

PartName	Artnr	Antall
Rekkverk 620 x 1100 med vindu	07-302-181K	1
Rekkverk 770x1100 cc880 høy postk_tree	07-302-182K	1

## Montering av lekeapparatet / Assembly instructions / Montering av lekredskapet

Se separat delmontering for detaljer  
 See separate assembly for details  
 Se separata delmontering för detaljer

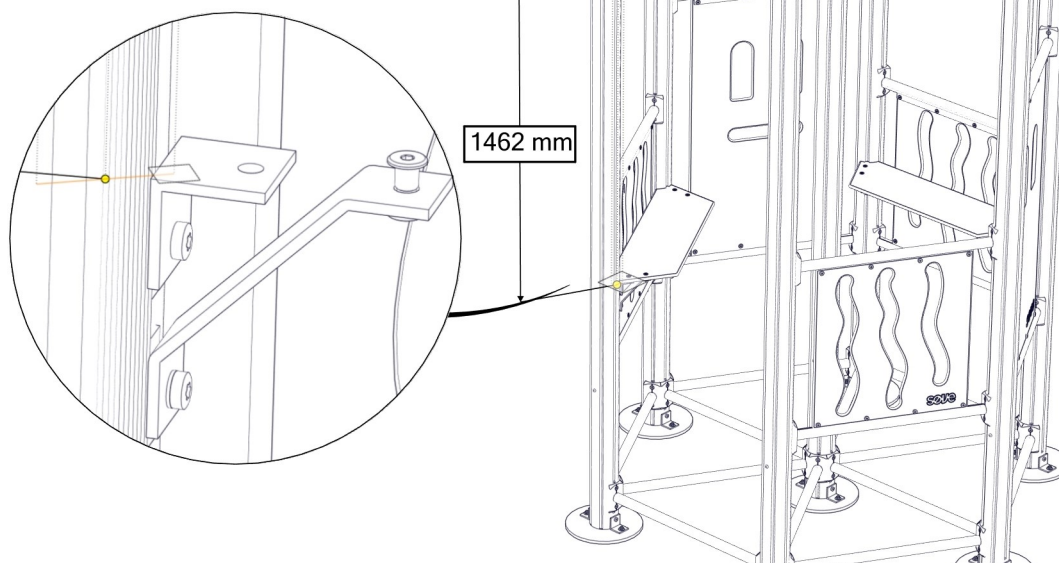

PartName	Artnr	Antall
Sittebenk 6kant hus grå komplett	07-520-623K	2

Se separat delmontering for detaljer  
 See separate assembly for details  
 Se separata delmontering för detaljer

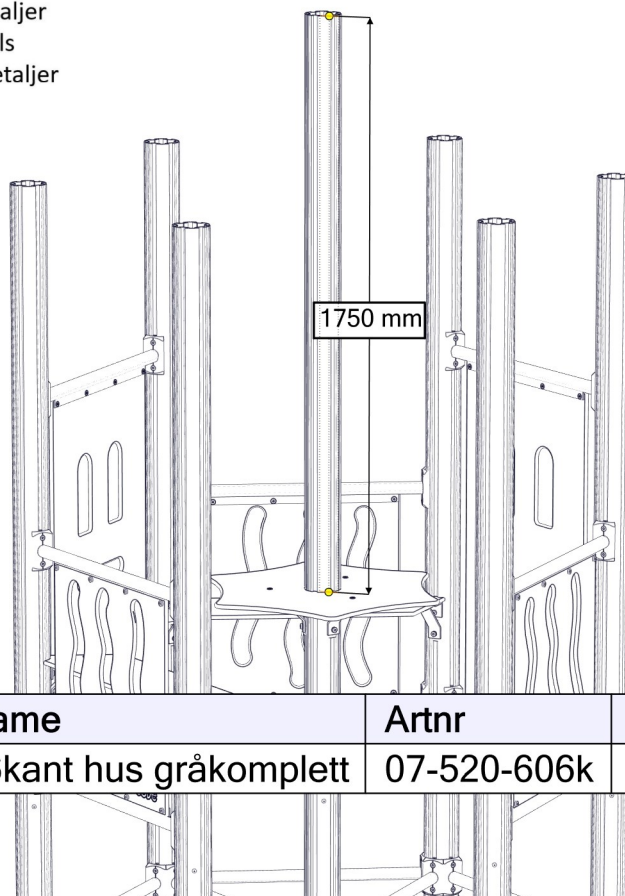

PartName	Artnr	Antall
Bord 6kant hus gråkomplett	07-520-606k	1



## Montering av lekeapparatet / Assembly instructions / Montering av lekredskapet

Se separat delmontering for detaljer  
 See separate assembly for details  
 Se separata delmontering för detaljer

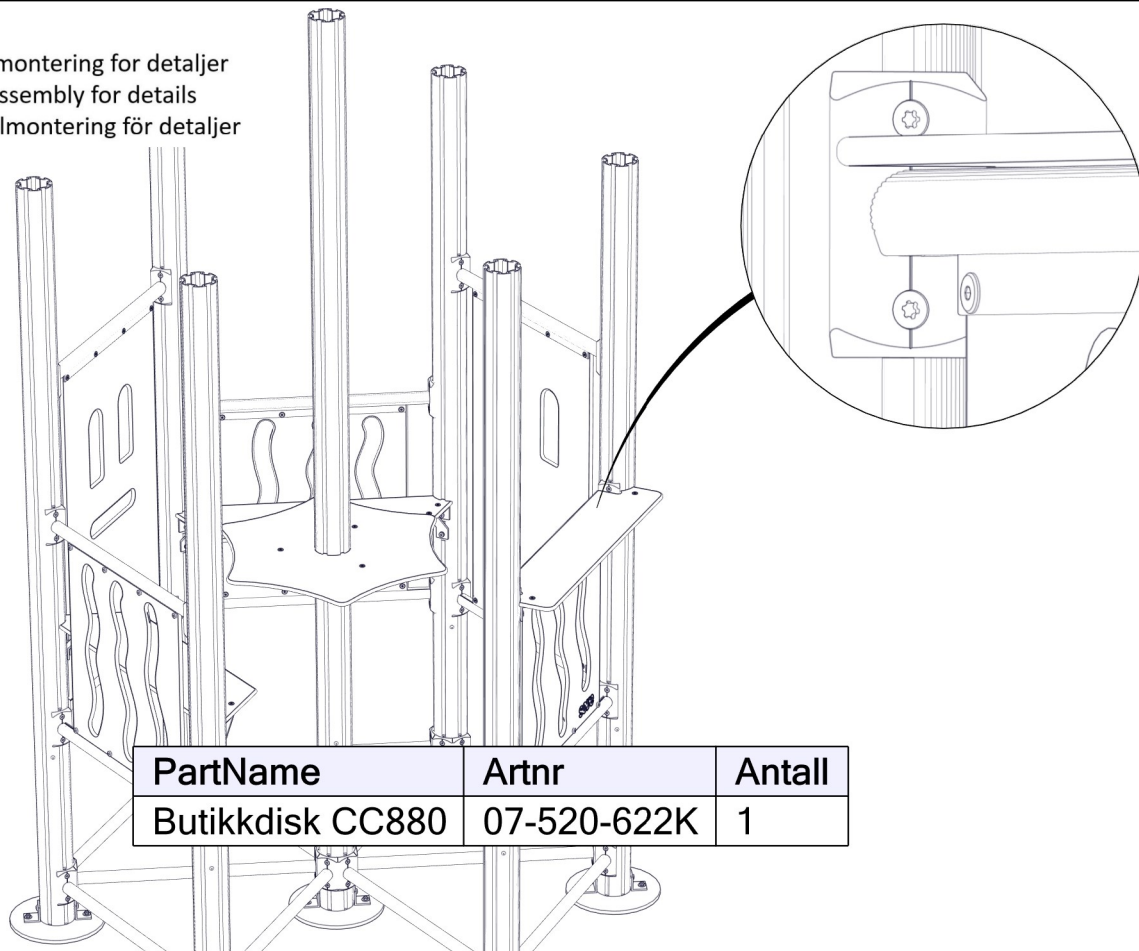

Se separat delmontering for detaljer  
 See separate assembly for details  
 Se separata delmontering för detaljer

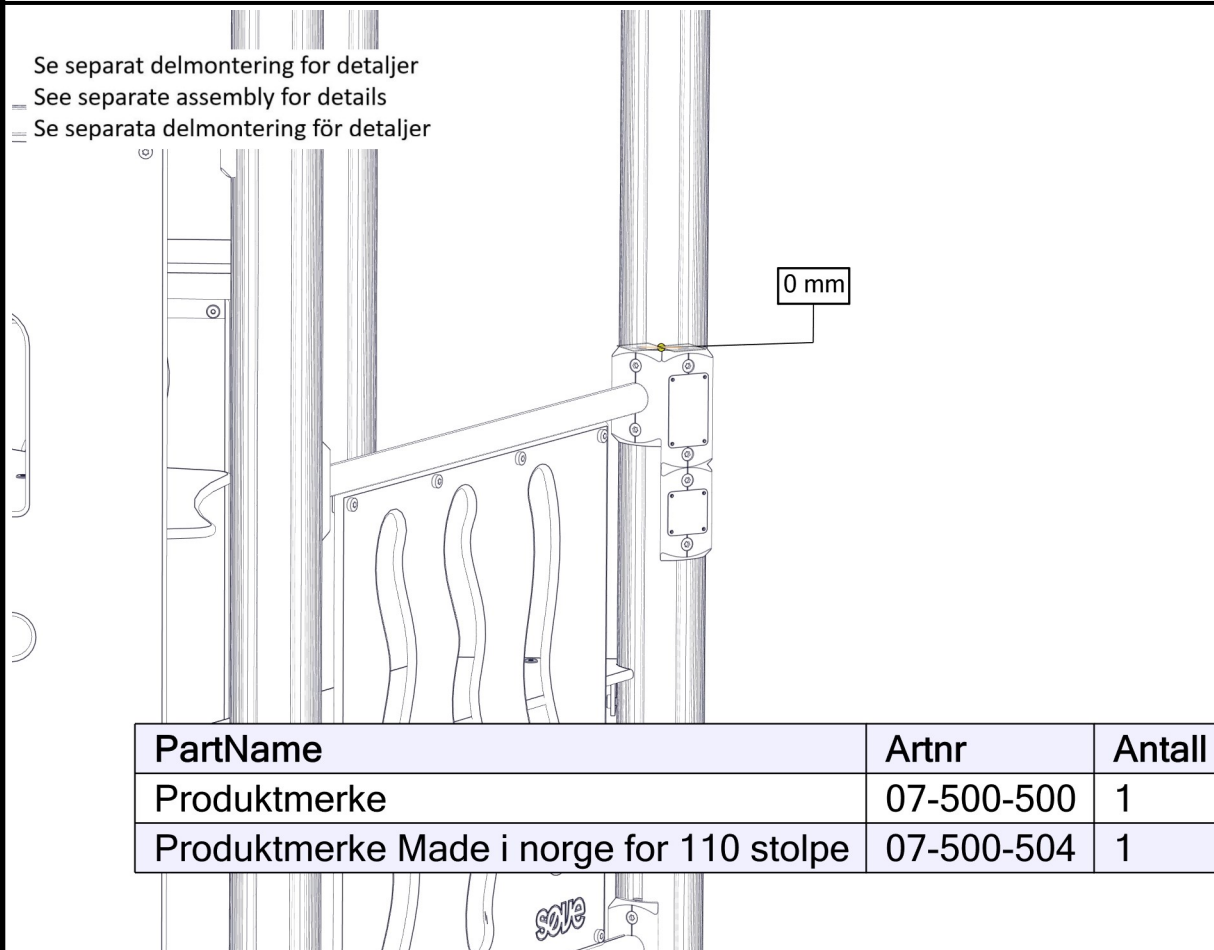

## Montering av lekeapparatet / Assembly instructions / Montering av lekredskapet

Se separat delmontering for detaljer  
 See separate assembly for details  
 Se separata delmontering för detaljer

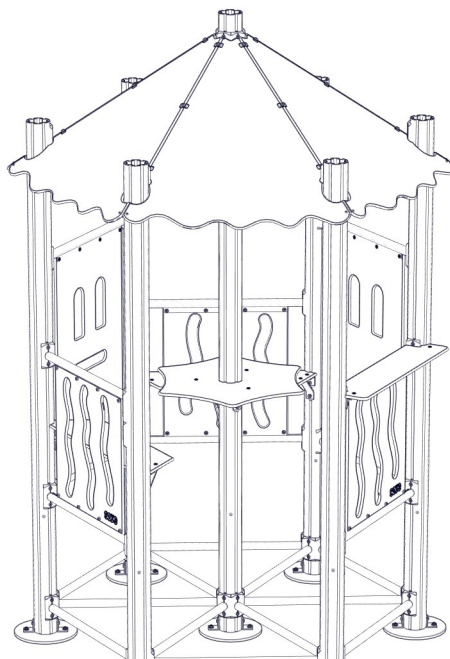

PartName	Artnr	Antall
Tak 6-kant komplett	07-520-750K	1

Se separat delmontering for detaljer  
 See separate assembly for details  
 Se separata delmontering för detaljer

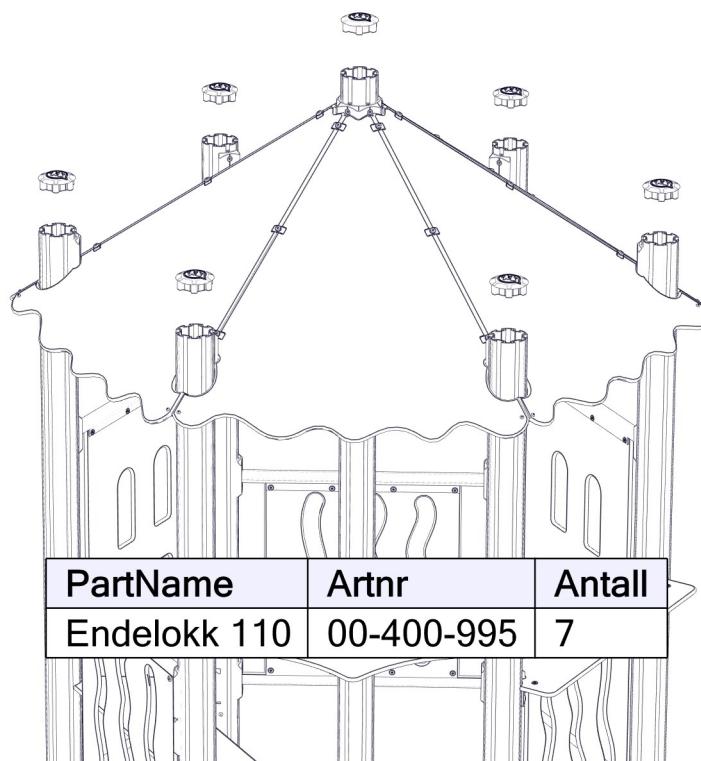

PartName	Artnr	Antall
Endelokk 110	00-400-995	7

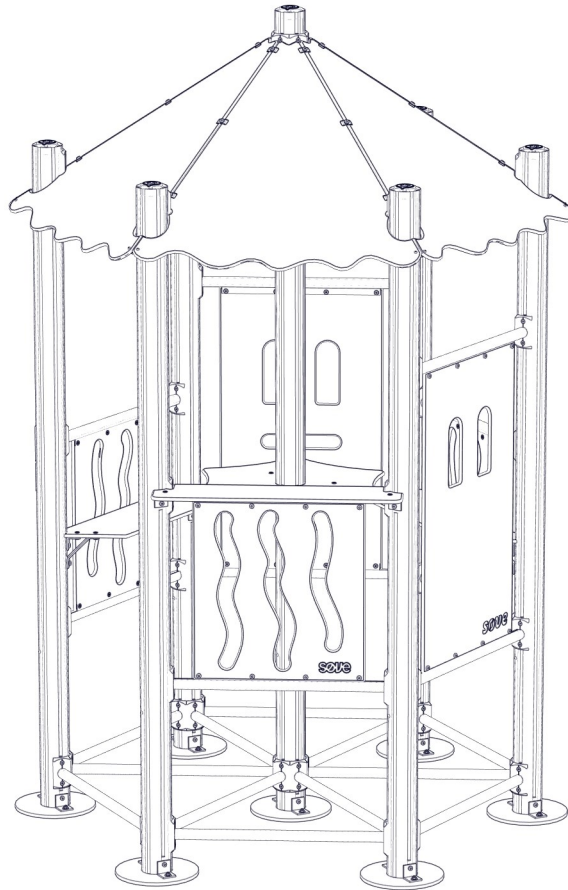



**Montering av lekeapparatet / Assembly instructions / Montering av lekredskapet**



Må støpes  
Må gjutes  
Use concret

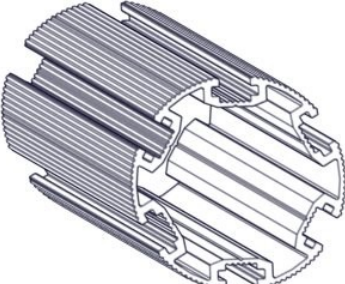

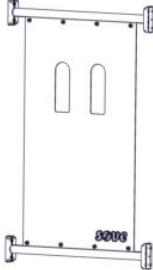
<b>Før utstyret tas i bruk / Before play begins // Innan lekredskapet tas i bruk</b>	
<b>N</b>	<ul style="list-style-type: none"> <li>● Påse at fallunderlag er utlagt i henhold til gjeldende regler eller vår anbefaling</li> <li>● Fjern alle monteringshjelpemidler ( rester av betong, planker, paller, plast, og lignende)</li> <li>● Før utstyret tas i bruk, burde man sjekke at det ikke er fare for at anorakksnorer og lignende som kan hekte seg fast noen steder på lekeapparatet. (Vedlagte snor med dobbe (kneledd) kan brukes til å sjekke at dette er i orden. Se vedlagte veiledning for bruk av denne. Dette gjøres for å oppdage eventuelle feilmonteringer.?</li> <li>● NB! Bør stå i 2-3 dager før bruk</li> </ul>
<b>EN</b>	<ul style="list-style-type: none"> <li>● Make sure the area and depth of safer surfacing are according to the current standard, or to the manufacturer's recommendation</li> <li>● Make sure all tools and surplus materials are removed before play begins</li> <li>● PS! When complete, allow 2-3 days for the concrete to set before use</li> </ul>
<b>S</b>	<ul style="list-style-type: none"> <li>● Kontrollera att fallunderlag är utlagt enligt gällande regler eller vårt rekommendation</li> <li>● Ta bort alla monteringshjälpmedel (rester av betong, plankor, pallar, plast och liknande)</li> <li>● Innan lekredskapet används, kontrollera att anoracksnoddar eller kläder/delar av kläder eller liknande inte kan fastna i några delar på redskapet. (Den bipackade "knävringen" kan man med fördel användas för denna kontroll.</li> <li>● Detta görs för att upptäcka eventuella felmonteringar.)</li> </ul>

**Boltepakker for / Boltpackage for / Bultpaket för**

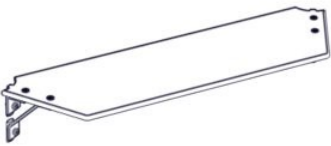
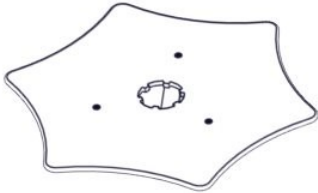
Sign. \_\_\_\_\_.

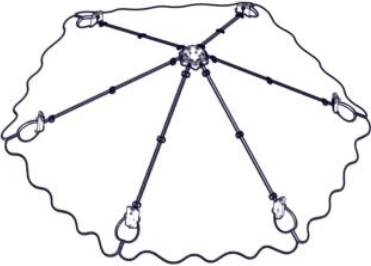
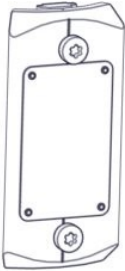
Villmark lekehus 6-kant 2 26-100-022	Navn	Artnr/ dimensjon	Ant	Lev
	Stolpe Ø110 L=2500 Grå 600-1900  Stolpe Ø110 L=3000 Grå 600-2400	SFA5126/2  SFA5126/2	6  1	
	Endelokk til stolpe Ø110	00-400-995	7	
	Rekkverk 770x1100 cc880 Postkasse Trestruktur	07-302-182K (se egen delmontering)	1	
	Rekkverk 620x100 med vindu Trestruktur	07-302-181K (se egen delmontering)	1	
	Rekkverk 655x610 cc880 Trestruktur	07-302-180K (se egen delmontering)	3	

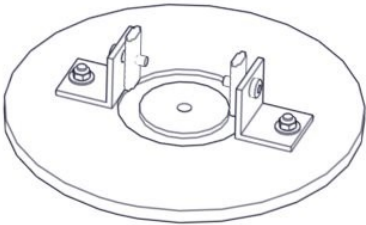
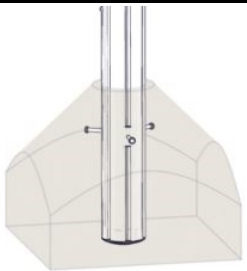
<b>Boltepakker for / Boltpackage for / Bultpaket för</b>		Sign. _____.		
<b>Villmark lekehus 6-kant 2 26-100-022</b>	<b>Navn</b>	<b>Artnr/ dimensjon</b>	<b>Ant</b>	<b>Lev</b>
	Sitebenk 6kant hus Grå	07-520-609K (se egen delmontering)	2	
	Bord 6kant hus Grå	07-520-606K (se egen delmontering)	1	
	Butikkdisk cc880 Grå	07-520-622K (se egen delmontering)	1	
	Tak 6-kant CC = 880 Steel material	07-520-750K (se egen delmontering)	1	
	Produkt merke Made in Norway merke	07-500-500 (se egen delmontering)	1	

<b>Boltepakker for / Boltpackage for / Bultpaket för</b>		Sign. _____.		
Villmark lekehus 6-kant 2 26-100-022	Navn	Artnr/ dimensjon	Ant	Lev
	<b>Nedgravnings fundament</b>			
	Sperrerør rett Lengde = 750 Uten hull Sort	07-500-075K (Se egen del- montering)	12	
	Fundamentplate 1xØ110 stolpe	07-400-101K (Se egen del- montering)	7	
	<b>Fundament Støp</b>			
	Fundament betong Stolpe Ø110	00-003-111K (Se egen del- montering)	7	
	Sperrerør rett Lengde = 750 Uten hull Sort	07-500-075K (se egen del- montering)	12	

**Boltepakker for / Boltpackage for / Bultpaket för**

Sign. \_\_\_\_\_.

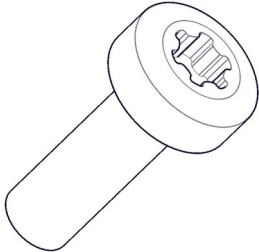
Villmark lekehus 6-kant 2 26-100-022	Navn	Artnr/ dimensjon	Ant	Lev
	<b>Overflate monte- ring</b>			
	Fundament 1xØ110 stolpe for Betongdekke	00-003-113K (se egen dele- montering)	7	
	Stolpe kappes	SFA5126/1	7	
	Korte bolter	00-003-132K	24	