

N

Monteringsanvisning

EN

Assembly Instructions

S

Monteringsanvisning

Produkt nr. / Product no. / Produkt nr.

26-100-040**Grønn**

Ord. nr. _____

Dato. _____

Sign. _____

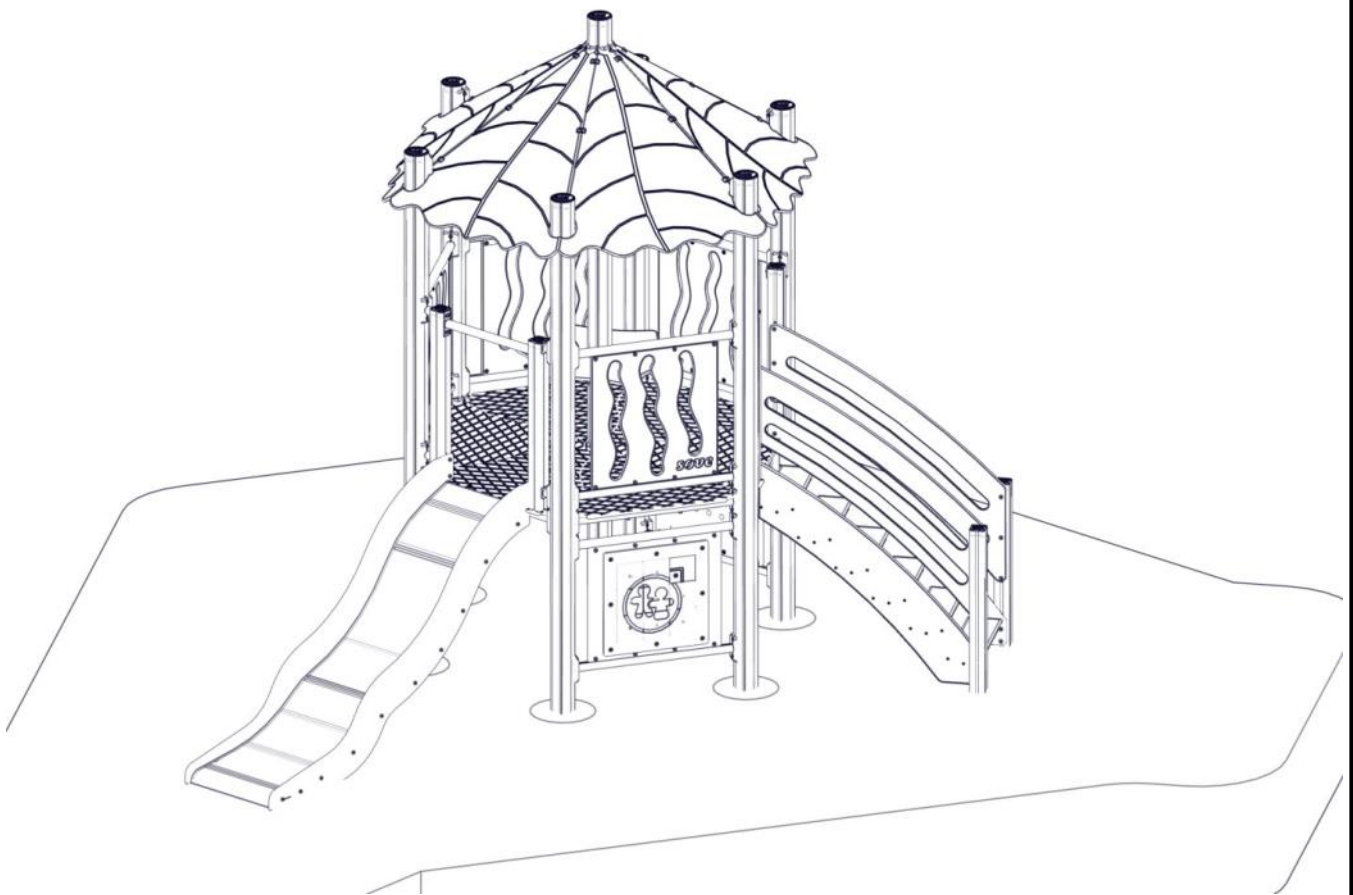
**sove**

Søve AS
Grønnvoldveien 290
3830 Ulefoss - Norway
Tlf: +47 35 94 65 65
www.sove.no

**sove**

Søve AB
EA Rosengrensgatan 32
421 31 Västra Frölunda
Phone: +46 (0)31 773 97 00
www.sove.se

Monteringstips / Assembly Advice / Monteringsstips

N

- Les monteringsanvisningen nøye før montering.
- Monter elementene i rekkefølgen som vist.
- Boltene bør ikke skrues for hardt til før alt er montert, vatret og loddet. Skru så boltene til.
- NB! Ved bruk av drill, kan boltene ryke.
- På grunn av at solen kan gjøre rutsjeflaten veldig varm, bør rutsjebanens utløp vende mot nord-øst eller nord-vest.
- Er lekeutstyret plassert i naturlige ferdselstraséer må området sikres mot gjennomgang.
- Innspringningshinder bør vurderes rundt lekeapparater hvor det er stor bevegelse, f.eks. ved huskestativ.
- Det bør være fritt innsyn til lekeutstyr som er beregnet for barn under 3 år.

NB! Under monteringsarbeidet må utstyr, som ikke er forankret forsvarlig i bakken, sikres slik at det ikke velte.

Området må avstenges under montering av apparatene med sperrebånd eller lignende.

EN

- Read the instruction carefully before assembling the play unit.
- Assemble the components in the sequence shown in these instructions. Fixings must not be fully tightened during assembly. Before casting the foundations, the structure must be level and plumb, at which point all fixings are tightened. PS! If use of drill, the bolts may be wrecked.
- Avoid positioning the slide facing due south because of overheating – ideal positions are facing north-east or north-west. Secure the construction-area to prevent people from walking through it.
- Consider installing barriers around play-equipment which gives rise to a lot of activity – i.e. swings.
- Ensure that clear vision is possible across the play area so that supervision is possible from any position, particularly where children under 3 years of age will be playing.

NB! During assembly of the equipment, ensure that all structures are securely propped, especially when left overnight. Also ensure that equipment is supported

Monteringstips / Assembly Advice / Monteringsstips**S**

- Läs monteringsanvisningen noga före montering.

- Montera delarna i den ordningen som anvisas
- Skruvarna bör inte skruvas för hårt tills allt är monterat, i våg och lodat.









OBS! Används elektrisk skruvdragare, kan bulten gå sönder. Hårdra därför manuellt!

- Solen kan göra att rutchbanan blir väldigt varm. Banans nedfart rekommenderas att vändas i norrlig riktning
- Om lekplatsen placeras vid en gångväg mm bör området säkras mot genomfart av gående och cyklister.
- Insprängningshinder bör placeras runt lekutrustning med stor rörelse, t ex, gungställning.
- Det bör vara fri insyn till lekutrustning beräknat till barn under 3 år.

OBS! Under monteringsarbete bör utrustningen som inte ska förankras i marken, ställs så att den inte kan välta.

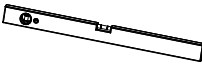
Området måste spärras när lekutrustningen byggs upp, med avspärrningsband eller liknande.

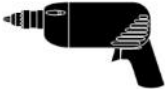
Nødvendig verktøy / Tools required / Nödvändiga verktyg





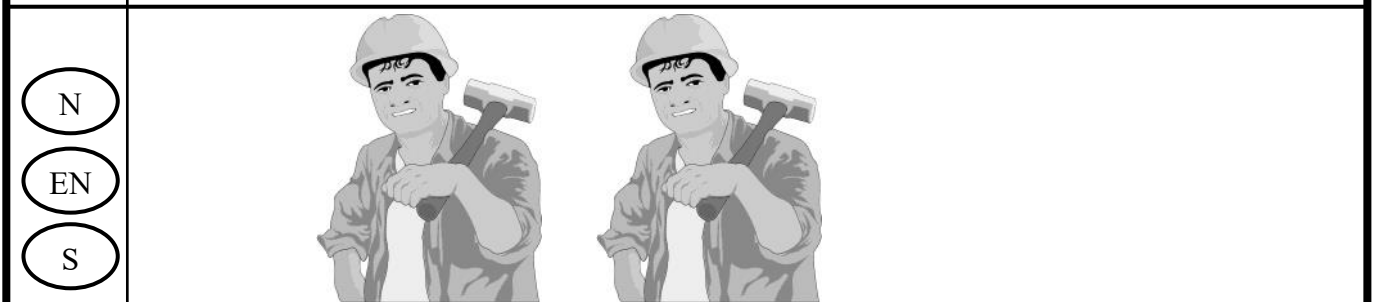

<p>(N)</p> <p>(EN)</p> <p>(S)</p>	<p>(A)</p> 	<p>(B)</p> <p>Torx Nr 45 High quality</p> 	<p>(C)</p> <p>13 + 17mm</p> 	<p>(D)</p> 	<p>(E)</p> 
		<p>Metermål Metric measure Tumstock</p> 	<p>16 V</p> 	<p>Merkebånd Mark ribbon Märkeband</p> 	<p>5 mm 6 mm</p> 

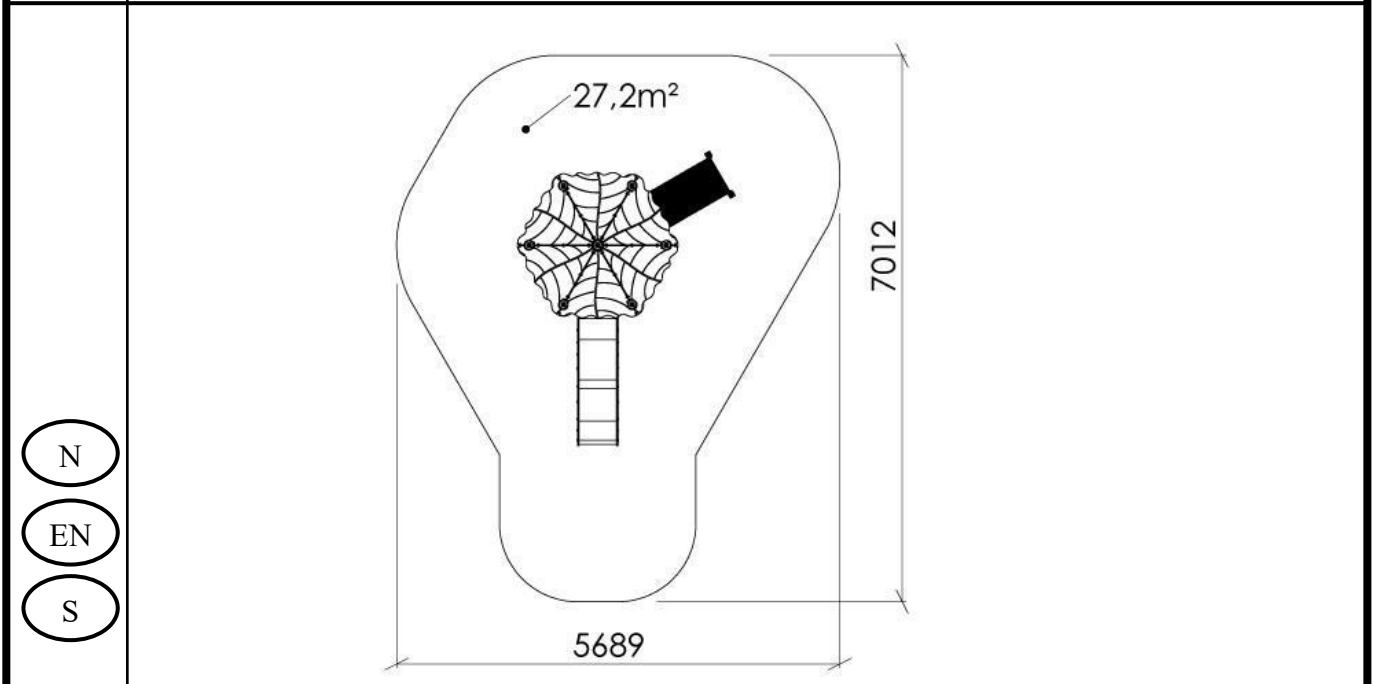

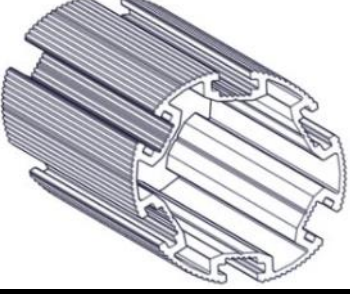

Nødvendig antall personer / Number of persons required / Rekommenderad antal personer



Anbefalt arealbehov ved montering / Recommended working space / Rekommenderad arealbehov vid montering

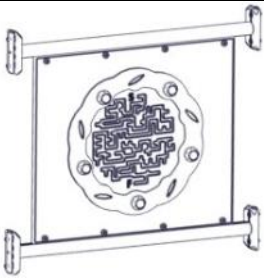
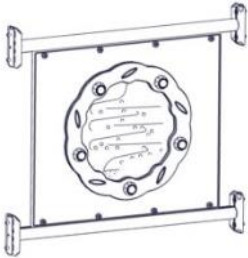

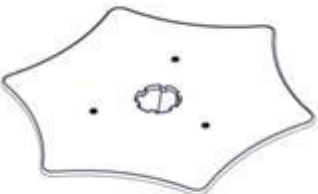



Boltepakker for / Boltpackage for / Bultpaket för		Sign. _____.		
Villmark leketårn 6-kant høy 26-100-040	Navn	Artnr/ dimensjon	Ant	Lev
	Stolpe Ø110 L=3100 Brun 600-2500	SFA5126/1	6	
	Stolpe Ø110 L=3650 Brun 600-3050	SFA5126/1	1	
	Endelokk til stolpe Ø110	00-400-995	7	
	Gulv 6-kant standard CC = 880 Brun	07-301-130K (se egen delmontering)	2	
	Gulv 6-kant Rett/Bro/Tunell CC = 880 Brun	07-301-132K (se egen delmontering)	2	
	Gulv 6-kant Protal trap/rutsje CC = 880 Brun	07-301-133K (se egen delmontering)	2	
	Rekkverk åpen 655x610 cc880	07-302-130K (se egen delmontering)	4	

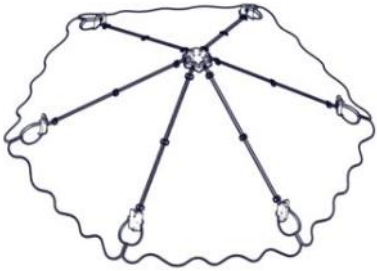

Boltepakker for / Boltpackage for / Bultpaket för		Sign. _____		
Villmark leketårn 6-kant høy 26-100-040	Navn	Artnr/ dimensjon	Ant	Lev
	Labiring Maze på grønn plate CC880 med rør	07-511-021K (se egen delmontering)	1	
	Twist Bearing på grønn plate Cc880 med rør	07-511-022K (se egen delmontering)	1	
	Sitebenk 6kant hus Grønn	07-520-607K (se egen delmontering)	2	
	Bord 6kant hus Grønn	07-520-604K (se egen delmontering)	1	
	Rutjebane H95 m/portal Grønn bane sort portal	07-510-312K (se egen delmontering)	1	
	Trapp H95 m/portal Grønn trapp sort portal	07-510-449K (se egen delmontering)	1	

Boltepakker for / Boltpackage for / Bultpaket för

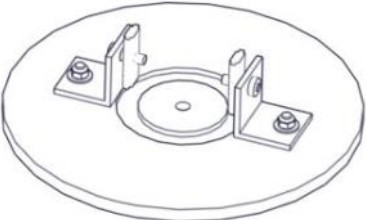
Sign. _____.

Villmark leketårn 6-kant høy 26-100-040	Navn	Artnr/ dimensjon	Ant	Lev
	Tak 6-kant CC = 880 Grønn	07-520-619K (se egen delmontering)	1	
	Produkt merke	07-500-500 (se egen delmontering)	1	

Boltepakker for / Boltpackage for / Bultpaket för		Sign. _____		
Villmark leketårn 6-kant høy 26-100-040	Navn	Artnr/ dimensjon	Ant	Lev
	Nedgravnings fundament			
	Sperrerør rett Lengde = 750 Uten hull Sort	07-500-075K (Se egen delmontering)	12	
	Fundamentplate 1xØ110 stolpe	07-400-101K (Se egen delmontering)	7	
	Fundament Støp			
	Fundament betong Stolpe Ø110	00-003-111K (Se egen delmontering)	7	
	Sperrerør rett Lengde = 750 Uten hull Sort	07-500-075K (se egen delmontering)	12	

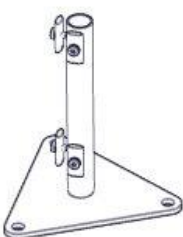
Boltepakker for / Boltpackage for / Bultpaket för		Sign. _____		
Villmark leketårn 6-kant høy 26-100-040	Navn	Artnr/ dimensjon	Ant	Lev
	Overflate montering			
	Fundament 3xØ110 for Betongdekke	00-003-115K (se egen delemontering)	1	
	Fundament 2xØ110 for Betongdekke	00-003-114K (se egen delemontering)	2	
	Fundament 70x70 for Betongdekke	00-003-129K (se egen delemontering)	2	
	Stolpe kappes		7	
	Rutsjebane kappes	07-510-312K	1	
	Trapp kappes	07-510-449K	1	
	Korte bolter	04-000-016	8	

Fundamentering med betong / Foundation concrete / Förankring med betong

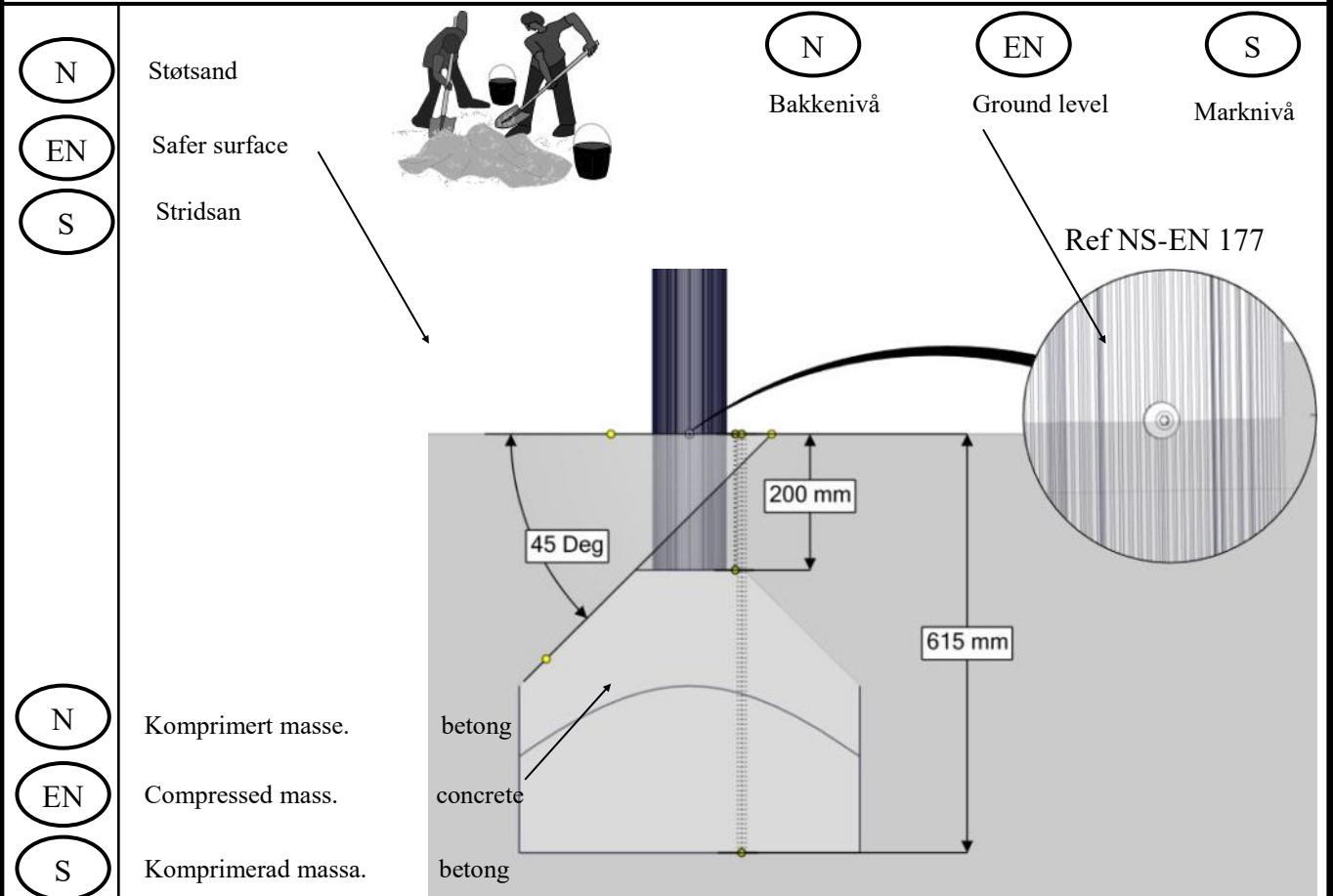

Fundamentering uten betong / Foundation without concrete / Förankring utan betong

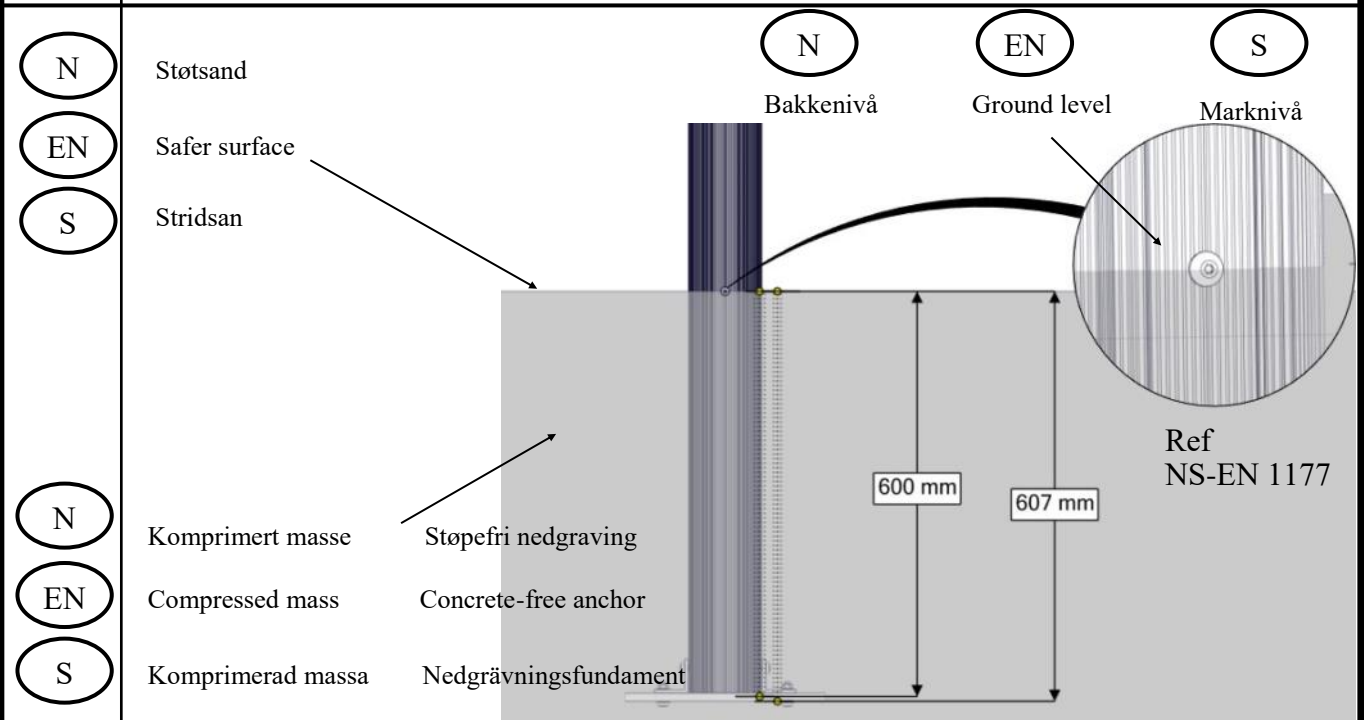

(N)	Alle mål er oppgitt i millimeter
(EN)	Scale measured in mm
(S)	Alla mått är i millimeter.

Overflatemontering/ Surface mounting/ Ytmontering

Ref.
NS-EN 1176-1
§4.2.8.5

N EN S
Bakkenivå Ground level marknivå

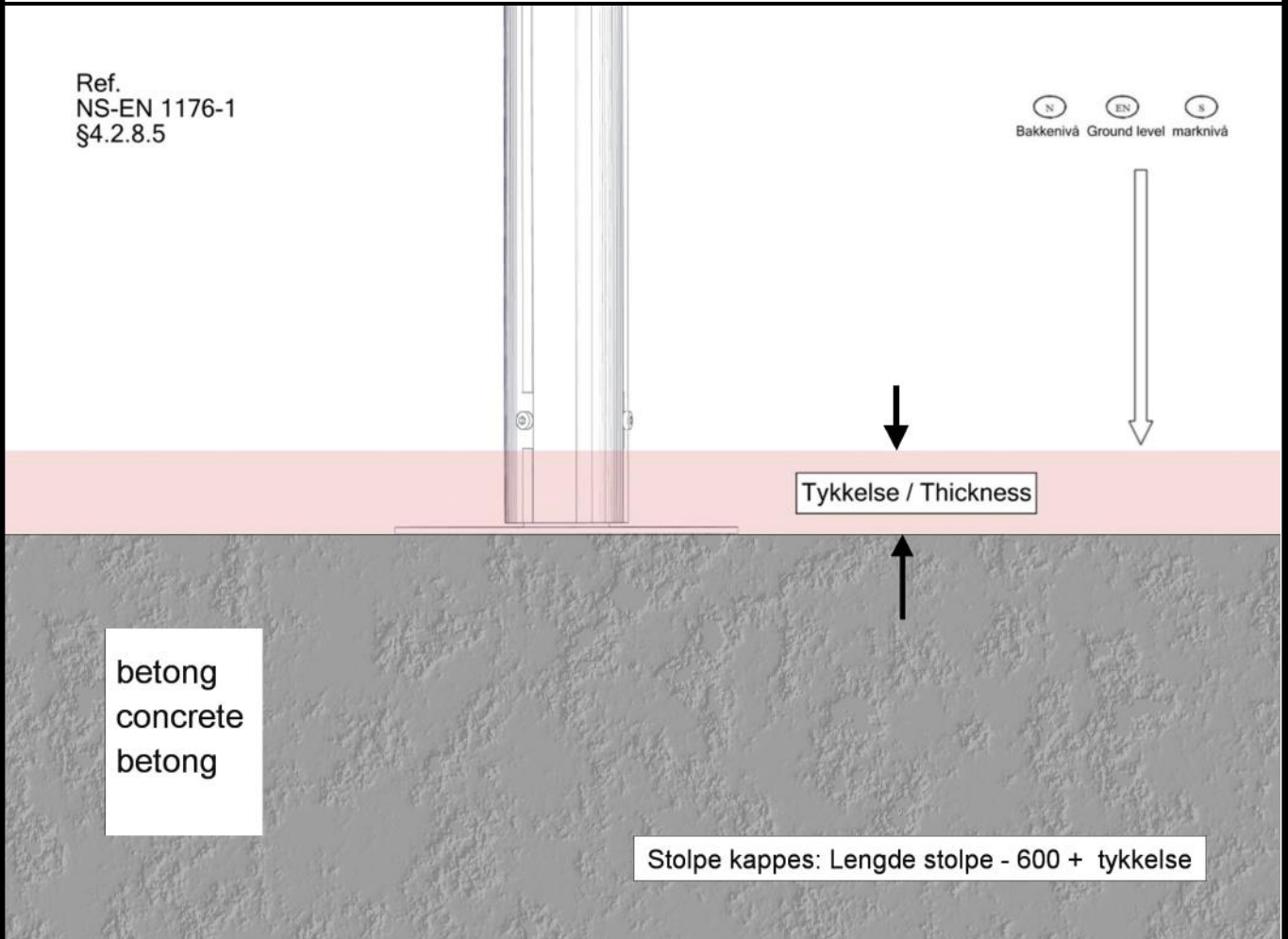

betong
concrete
betong

Stolpe kappes: Lengde stolpe - 600 + tykkelse

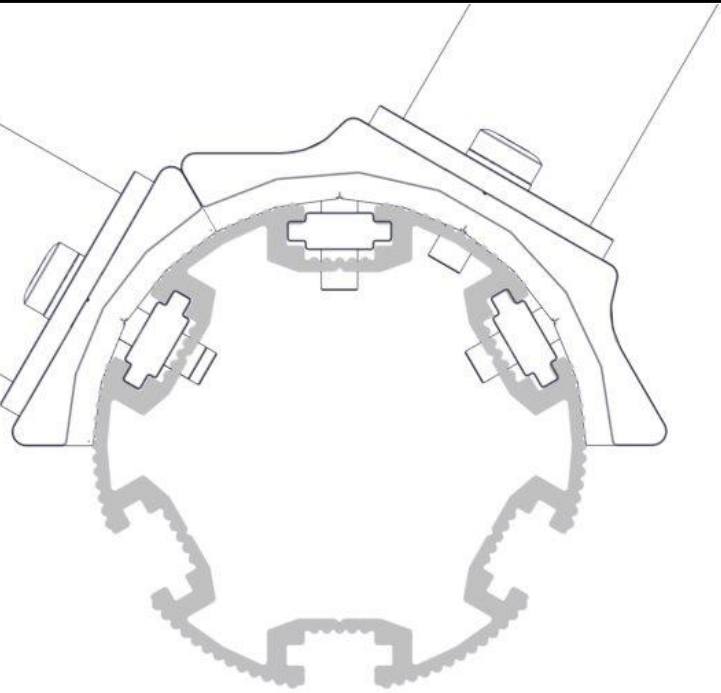
<p>(N) Bolten skrues HELT igjennom aluminiumen. Maks moment: 30Nm</p> <p>(EN) The bolt must be tightened in to the post, so that it peirces the aluminium Max torque: 30Nm</p> <p>(S) Bulten skivas HELT ignom aluminiumen. Maks vridmoment: 30Nm</p>				
NO	Betongkvalitet	C25/30		
SE	Betongkvalitet			
EN	Concrete quality			
NO	Mengde betong		0,7	m ³
SE	Mängd betong			
EN	Amount of concrete			
NO	Fundament størrelse		0,5 x 0,5 x 0,4	m
SE	Stiftelsestorlek			
EN	Foundation size			
NO	For sikkerhet må fundamentene med sand eller myk jord være minst 50% større i areal			
SE	För säkerheten måste grunden med sand eller mjuk jord vara minst 50% större i området			
EN	For safety, the foundations with sand or soft soil must be at least 50% larger in area			
NO	Tyngste element	07-510-311	36	Kg
SE	Tyngsta element			
EN	Heaviest element			
NO	Største element	07-510-311 SFA5126/1	2,13x0,56x0,36 L=3,6 Ø=0,11	m
SE	Största element			
EN	Biggest element			

Fallhøyder / Free height of fall / Fallhöjder

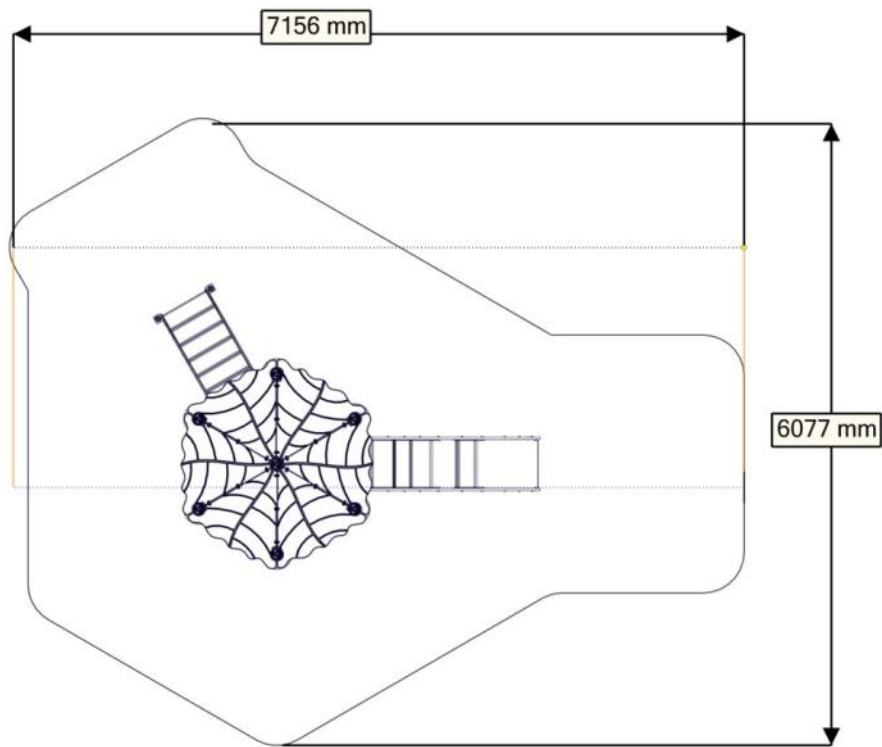

Sikkerhetszone / Safety zone / Säkerhetszon

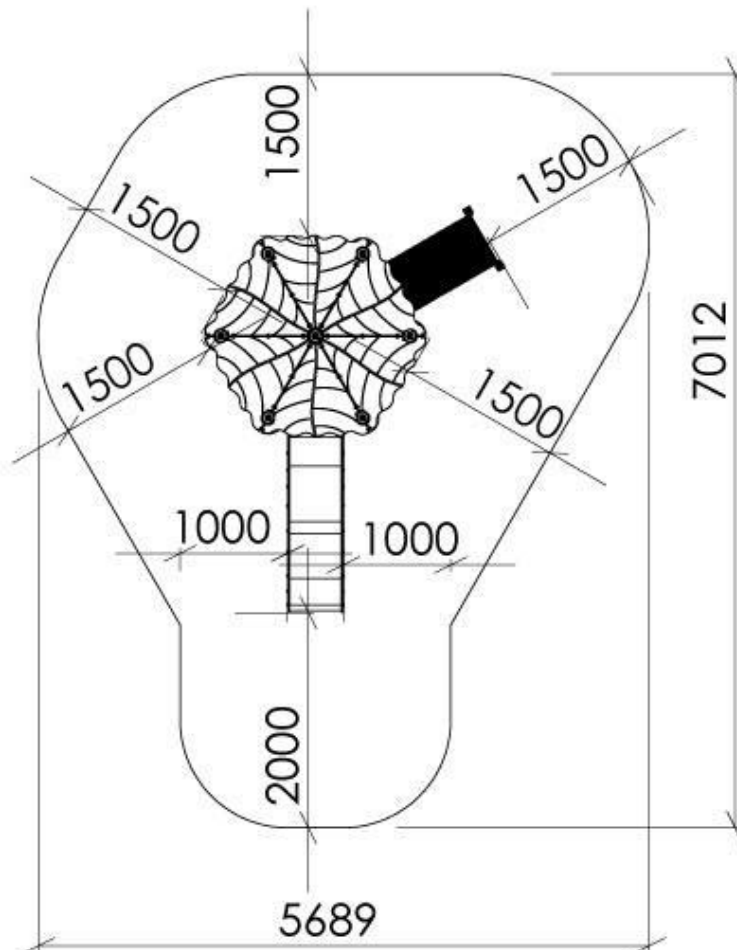

Plassering av forankringer / Ground plan / Placering av förankringar

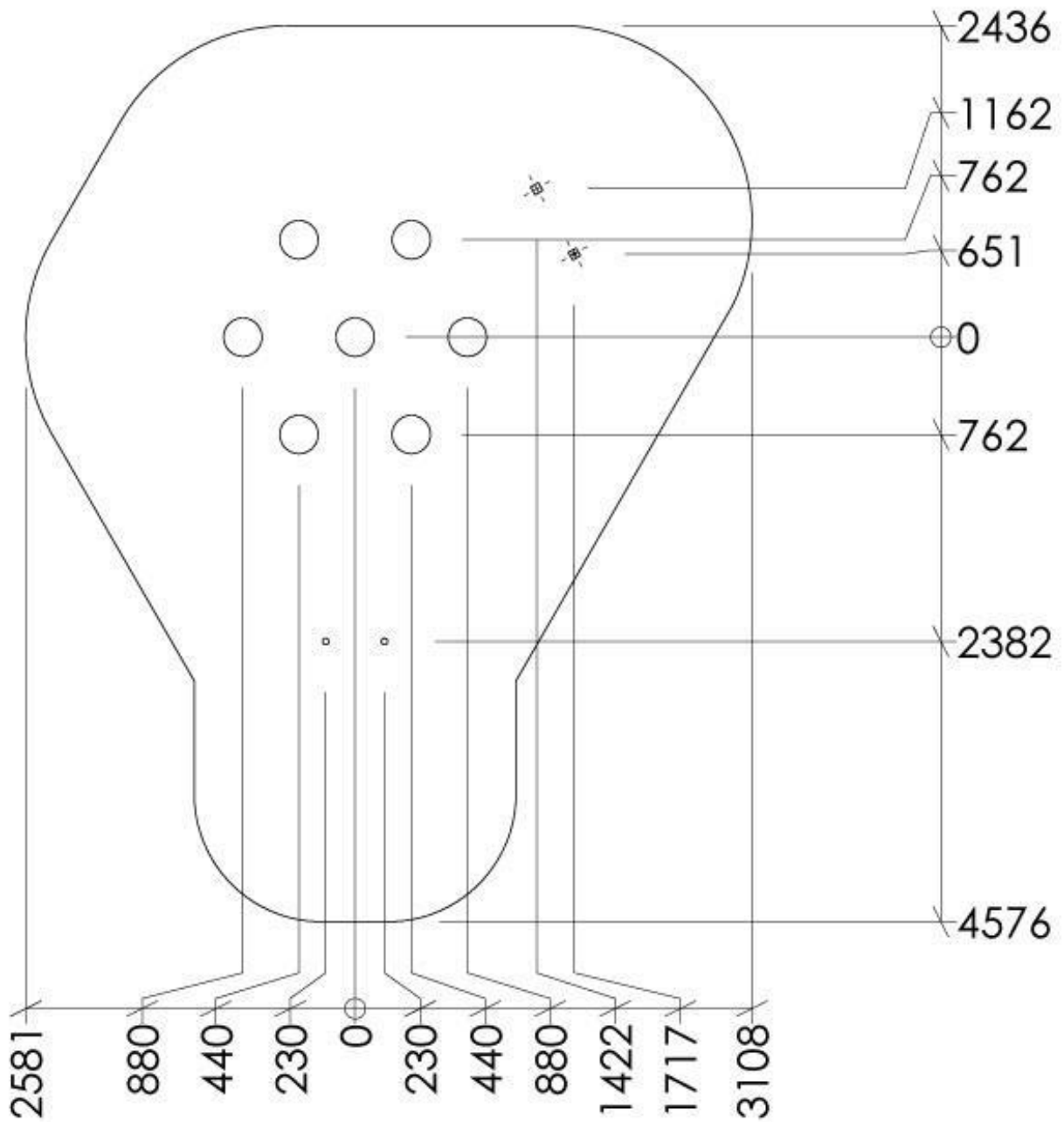

N

Alle mål er oppgitt i millimeter

EN

Scale measured in mm

S

Alla mått är i millimeter.

Montering av lekeapparatet / Assembly instructions / Montering av lekredskapet

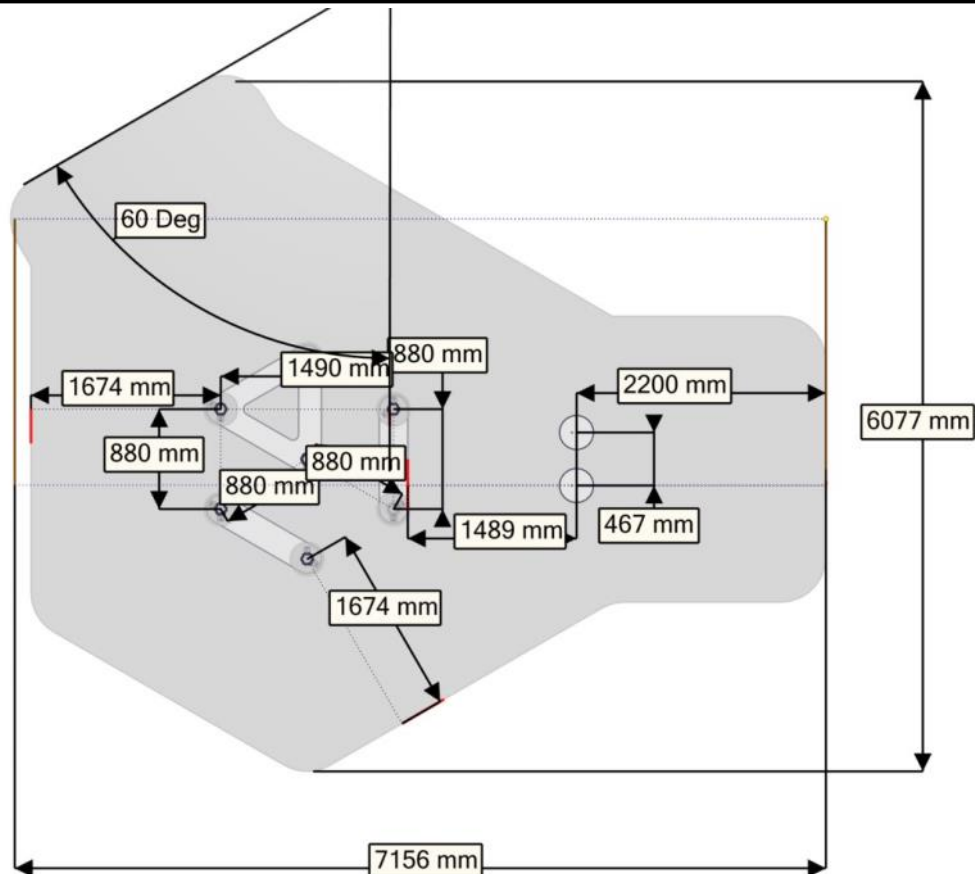
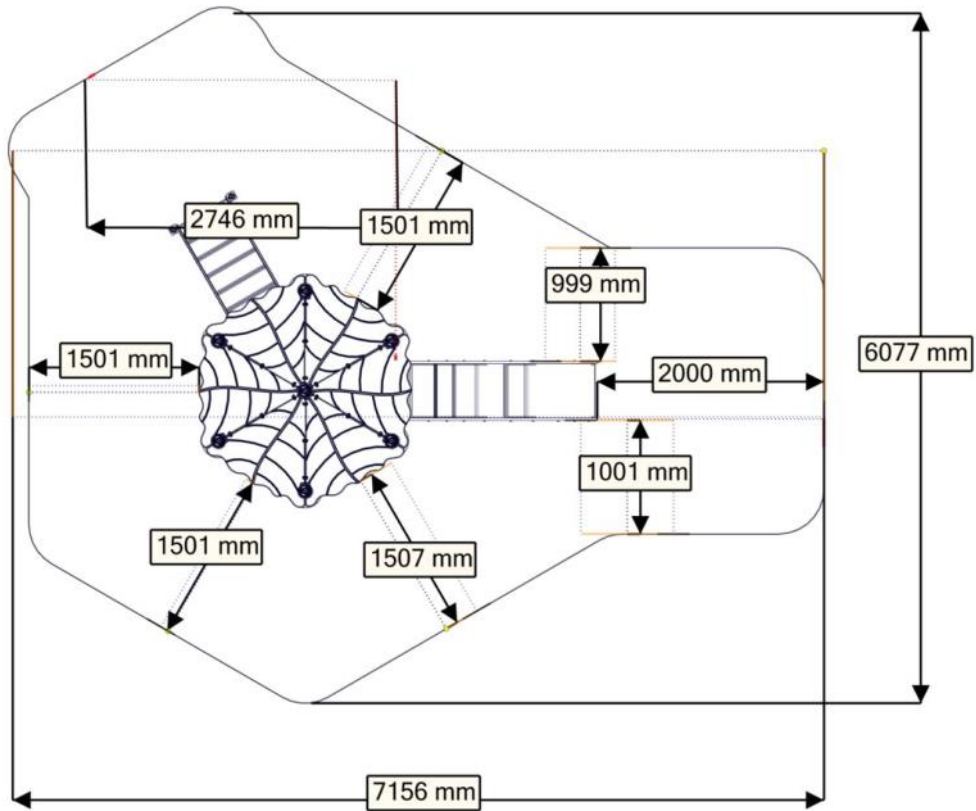

Fallhøyde = 1 meter

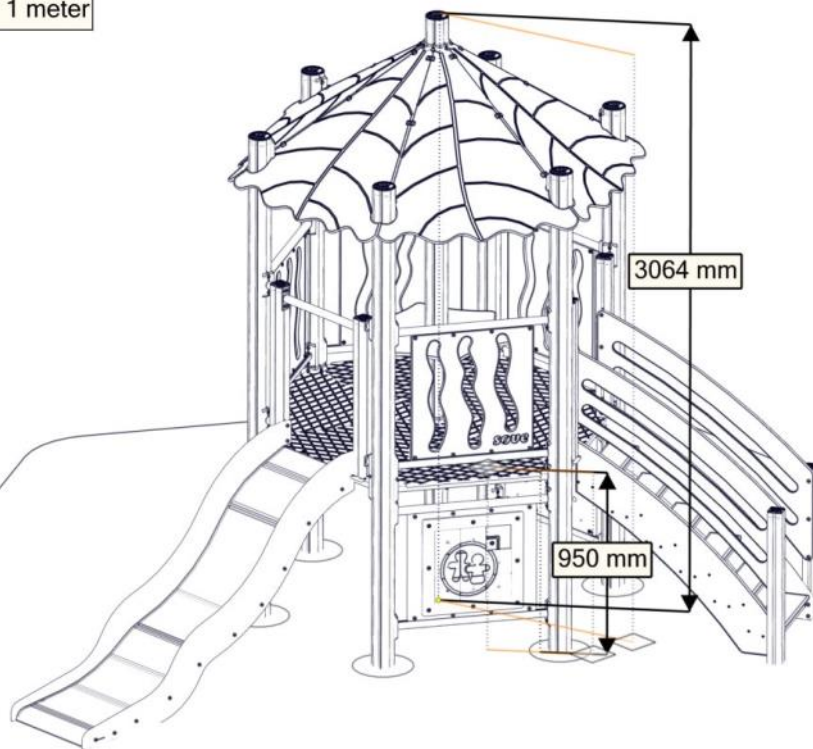

Brikke montert hos Søve

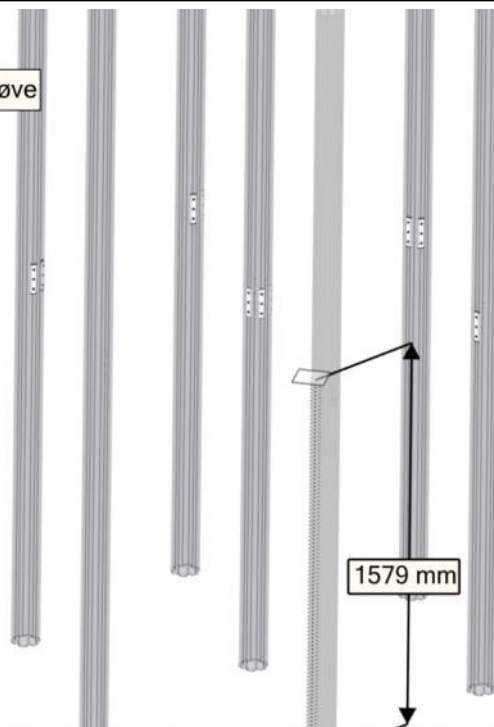

nr	PartName	Artnr	Antall
1	Stolpe 110 600-2500 L=3100	07-100-334	6
2	Stolpe 110 600-3050 L=3650	07-100-334	1

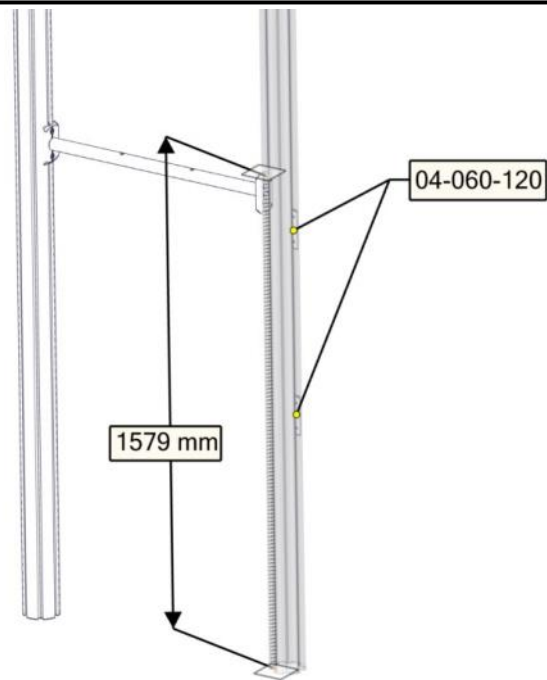

nr	PartName	Artnr	Antall
5	Torx M8x25	04-000-025	4
6	Brikke 120 3xM8	04-060-120	2
8	Stolpe 110 600-2500 L=3100	07-100-334	2
9	Sperrerør 6kant gulv 2 hull	07-500-064	1

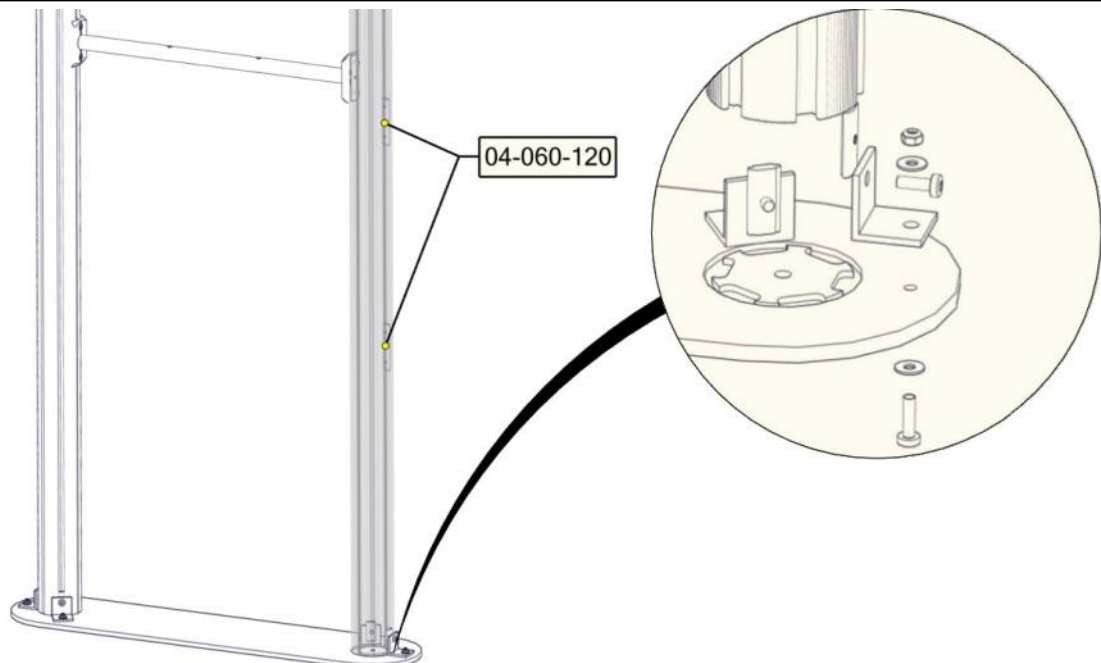

nr	PartName	Artnr	Antall
1	Torx M8x25	04-000-025	4
2	Låsemutter M8	04-040-008	4
3	Skive M8 stor	04-055-008	8
4	Brikke50 1XM8	04-060-050	4

nr	PartName	Artnr	Antall
5	Vinkel 50x50x50x5 11mm hull	04-070-050	4
6	Fundamentplate 2 stolper	07-400-012	1

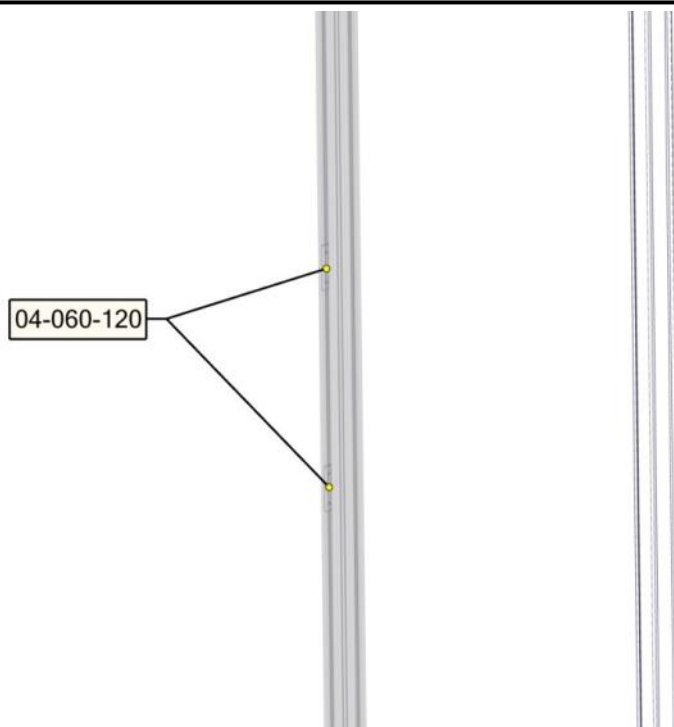

nr	PartName	Artnr	Antall
7	Brikke 120 3xM8	04-060-120	2
2	Stolpe 110 600-2500 L=3100	07-100-334	2

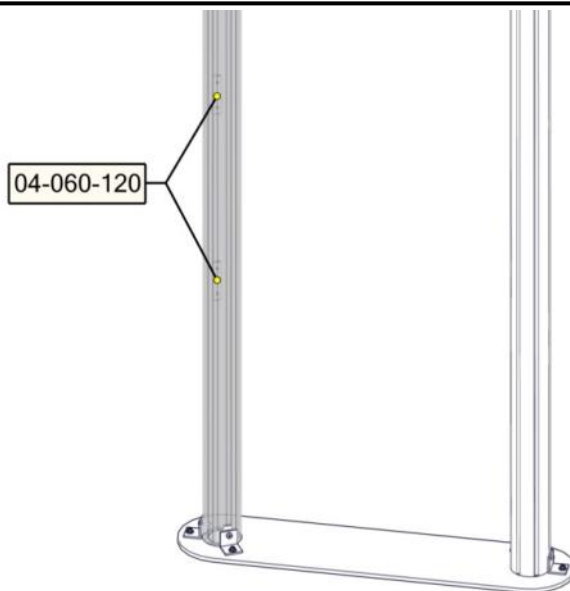

nr	PartName	Artnr	Antall
1	Torx M8x25	04-000-025	4
2	Torx M8x30	04-000-030	4
3	Låsemutter M8	04-040-008	4
4	Skive M8 stor	04-055-008	8

nr	PartName	Artnr	Antall
5	Brikke50 1XM8	04-060-050	4
6	Vinkel 50x50x50x5 11mm hull	04-070-050	4
7	Fundamentplate 2 stolper	07-400-012	1

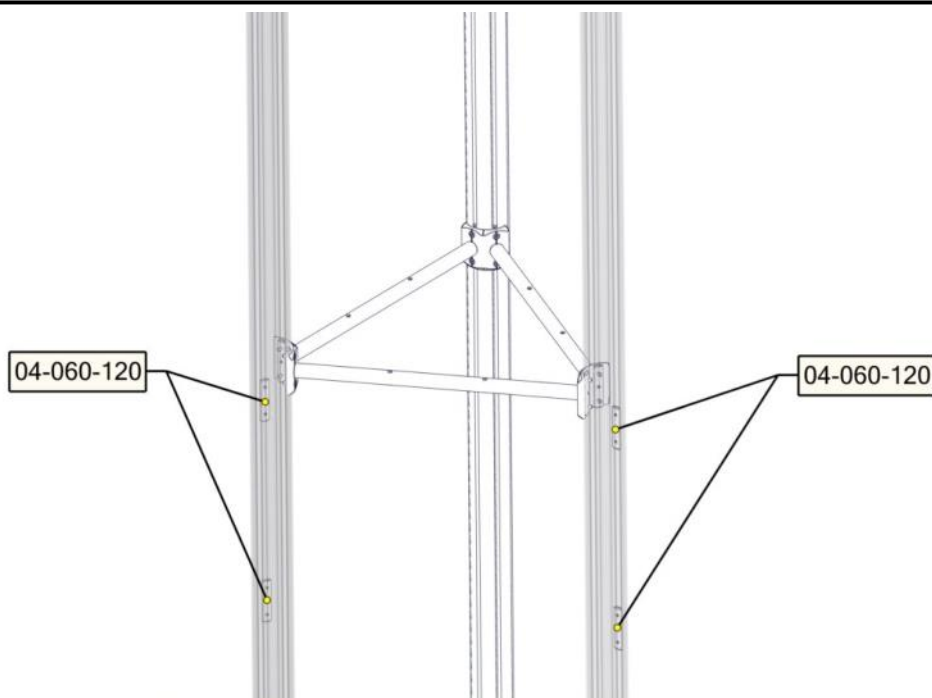



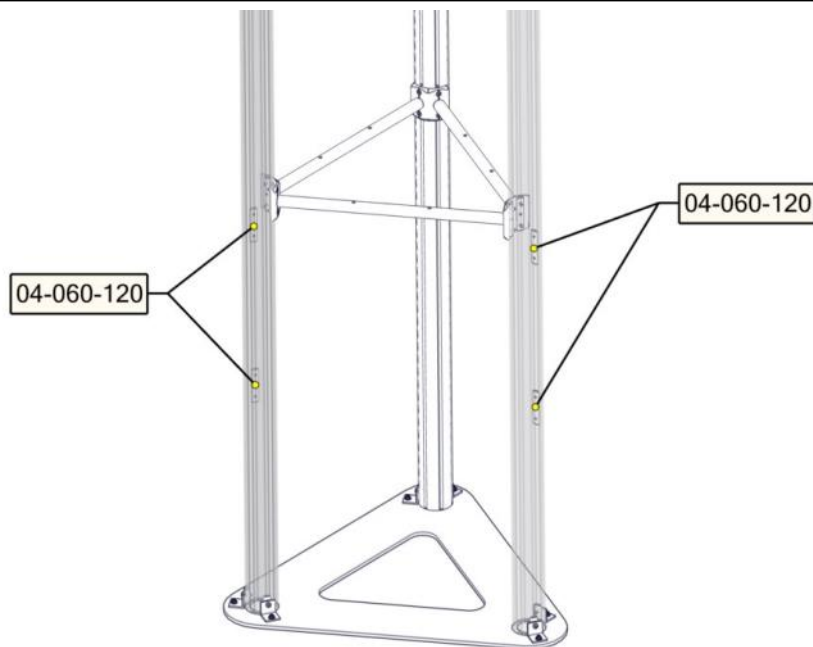



nr	PartName	Artnr	Antall
1	Torx M8x25	04-000-025	12
2	Brikke 120 3xM8	04-060-120	4
3	Stolpe 110 600-	07-100-334	3
4	Sperrerør 6kant gulv 2 hull	07-500-064	3



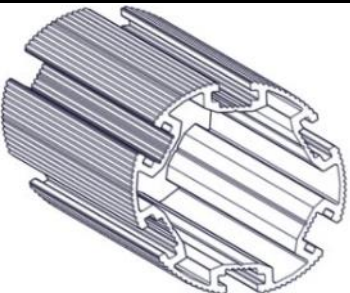



nr	PartName	Artnr	Antall
1	Torx M8x25	04-000-025	6
2	Torx M8x30	04-000-030	6
3	Låsemutter M8	04-040-008	6
4	Skive M8 stor	04-055-008	12

nr	PartName	Artnr	Antall
5	Brikke50 1XM8	04-060-050	6
6	Vinkel 50x50x50x5 11mm hull	04-070-050	6
7	Fundamentplate 3 stolper	07-400-013	1

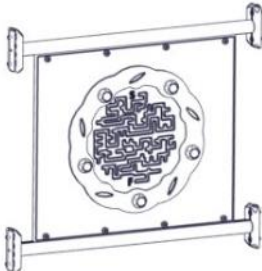
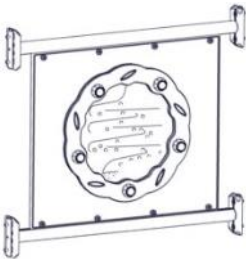

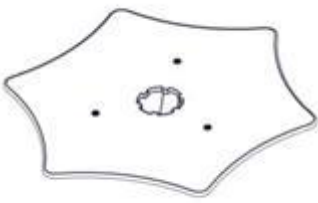
Før utstyret tas i bruk / Before play begins / Innan lekredskapet tas i bruk	
N	<ul style="list-style-type: none"> ● Påse at fallunderlag er utlagt i henhold til gjeldende regler eller vår anbefaling ● Fjern alle monteringshjelpemidler (rester av betong, planker, paller, plast, og lignende) ● Før utstyret tas i bruk, burde man sjekke at det ikke er fare for at anorakksnorer og lignende som kan hekte seg fast noen steder på lekeapparatet. (Vedlagte snor med dobbe (kneledd) kan brukes til å sjekke at dette er i orden. Se vedlagte veiledning for bruk av denne. Dette gjøres for å oppdage eventuelle feilmonteringer.) ● NB! Bør stå i 2-3 dager før bruk
EN	<ul style="list-style-type: none"> ● Make sure the area and depth of safer surfacing are according to the current standard, or to the manufacturer's recommendation ● Make sure all tools and surplus materials are removed before play begins ● PS! When complete, allow 2-3 days for the concrete to set before use
S	<ul style="list-style-type: none"> ● Kontrollera att fallunderlag är utlagt enligt gällande regler eller vårt rekommendation ● Ta bort alla monteringshjälpmedel (rester av betong, plankor, pallar, plast och liknande) ● Innan lekredskapet används, kontrollera att anoracksnoddar eller kläder/delar av kläder eller liknande inte kan fastna i några delar på redskapet. (Den bipackade "knävringen" kan man med fördel användas för denna kontroll. ● Detta görs för att upptäcka eventuella felmonteringar.)



Boltepakker for / Boltpackage for / Bultpaket för		Sign. _____.		
Villmark leketårn 6-kant høy 26-100-040	Navn	Artnr/ dimensjon	Ant	Lev
	Stolpe Ø110 L=3100 Brun 600-2500	SFA5126/1	6	
	Stolpe Ø110 L=3650 Brun 600-3050	SFA5126/1	1	
	Endelokk til stolpe Ø110	00-400-995	7	
	Gulv 6-kant standard CC = 880 Brun	07-301-130K (se egen delmontering)	2	
	Gulv 6-kant Rett/Bro/Tunell CC = 880 Brun	07-301-132K (se egen delmontering)	2	
	Gulv 6-kant Protal trap/rutsje CC = 880 Brun	07-301-133K (se egen delmontering)	2	
	Rekkverk åpen 655x610 cc880	07-302-130K (se egen delmontering)	4	

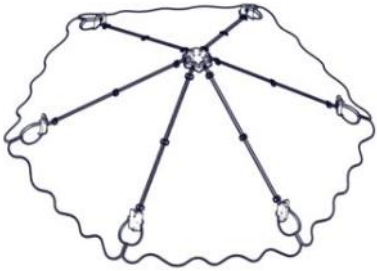

Boltepakker for / Boltpackage for / Bultpaket för		Sign. _____		
Villmark leketårn 6-kant høy 26-100-040	Navn	Artnr/ dimensjon	Ant	Lev
	Labiring Maze på grønn plate CC880 med rør	07-511-021K (se egen delmontering)	1	
	Twist Bearing på grønn plate Cc880 med rør	07-511-022K (se egen delmontering)	1	
	Sitebenk 6kant hus Grønn	07-520-607K (se egen delmontering)	2	
	Bord 6kant hus Grønn	07-520-604K (se egen delmontering)	1	
	Rutjebane H95 m/portal Grønn bane sort portal	07-510-312K (se egen delmontering)	1	
	Trapp H95 m/portal Grønn trapp sort portal	07-510-449K (se egen delmontering)	1	

Boltepakker for / Boltpackage for / Bultpaket för

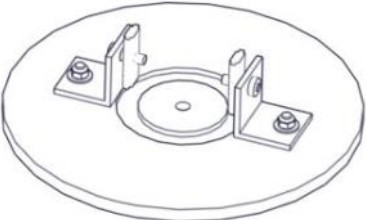
Sign. _____.

Villmark leketårn 6-kant høy 26-100-040	Navn	Artnr/ dimensjon	Ant	Lev
	Tak 6-kant CC = 880 Grønn	07-520-619K (se egen delmontering)	1	
	Produkt merke	07-500-500 (se egen delmontering)	1	

Boltepakker for / Boltpackage for / Bultpaket för		Sign. _____.		
Villmark leketårn 6-kant høy 26-100-040	Navn	Artnr/ dimensjon	Ant	Lev
	Nedgravnings fundament			
	Sperrerør rett Lengde = 750 Uten hull Sort	07-500-075K (Se egen delmontering)	12	
	Fundamentplate 1xØ110 stolpe	07-400-101K (Se egen delmontering)	7	
	Fundament Støp			
	Fundament betong Stolpe Ø110	00-003-111K (Se egen delmontering)	7	
	Sperrerør rett Lengde = 750 Uten hull Sort	07-500-075K (se egen delmontering)	12	

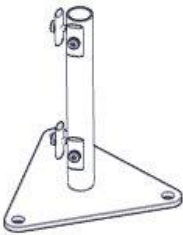
Boltepakker for / Boltpackage for / Bultpaket för		Sign. _____		
Villmark leketårn 6-kant høy 26-100-040	Navn	Artnr/ dimensjon	Ant	Lev
	Overflate montering			
	Fundament 3xØ110 for Betongdekke	00-003-115K (se egen delemontering)	1	
	Fundament 2xØ110 for Betongdekke	00-003-114K (se egen delemontering)	2	
	Fundament 70x70 for Betongdekke	00-003-129K (se egen delemontering)	2	
	Stolpe kappes		7	
	Rutsjebane kappes	07-510-312K	1	
	Trapp kappes	07-510-449K	1	
	Korte bolter	04-000-016	8	

MTK : 22-10-2020
Endert Søve spill med Fahr Inserrts

SV
29-01-2021
Endret navn på produkt