

(N) Monteringsanvisning

(UK) Assembly Instructions

(S) Monteringsanvisning

Produkt nr. / Product no. / Produkt nr.

26-104-060

Ordr. nr. _____

Dato. _____

Sign. _____



Søve Lekemiljø AS
3830 Ulefoss - Norway
Tlf: +47 35 94 65 65
www.sove.no



Søve AB
412 50 Göteborg
Phone: +46 (0)31 773 97 001
www.sove.se

17.10.2011

- ☒ Les monteringsanvisningen nøye før montering.
- ☒ Monter elementene i rekkefølgen som vist.
- ☒ Boltene bør ikke skrues for hardt til før alt er montert, vatret og loddet. Skru så boltene til.
NB! Ved bruk av drill, kan boltene ryke.
- ☒ På grunn av at solen kan gjøre rutsjeflaten veldig varm, bør rutsjebanens utløp vende mot nord-øst eller nord-vest.
- ☒ Er lekeutstyret plassert i naturlige ferdselstraséer må området sikres mot spontan gjennomgang.
- ☒ Innspringningshinder bør vurderes rundt lekeapparater hvor det er stor bevegelse, f.eks. ved huskestativ.
- ☒ Det bør være fritt innsyn til lekeutstyr som er beregnet for barn under 3 år.

**NB! Under monteringsarbeidet må utstyr, som ikke er forankret forsvarlig i bakken, avstives slik at det ikke velte.
Området må avstenges under oppsettelse av apparatene med sperrebånd eller lignende.**

- ☒ Read the instruction carefully before assembling the play unit.
- ☒ Assemble the components in the sequence shown in these instructions.
- ☒ Fixings must not be fully tightened during assembly. Before casting the foundations, the structure must be level and plumb, at which point all fixings are tightened.
- PS! If use of drill, the bolts may be wrecked.
- ☒ Avoid positioning the slide facing due south because of overheating – ideal positions are facing north-east or north-west.
- ☒ Secure the construction-area to prevent people from walking through it.
- ☒ Consider installing barriers around play-equipment which gives rise to a lot of activity – i.e. swings.
- ☒ Ensure that clear vision is possible across the play area so that supervision is possible from any position, particularly where children under 3 years of age will be playing.

NB! During assembly of the equipment, ensure that all structures are securely propped, especially when left overnight. Also ensure that equipment is supported whilst concrete foundations are setting and enclose the area securely to prevent access.

☒ Läs monteringsanvisningen noga före montering.

☒ Montera delarna i den ordningen som anvisas

☒ Skruvarna bör inte skruvas för hårt tills allt är monterat, i våg och lodat.

OBS! Används elektrisk skruvdragare, kan bulten gå sönder. Hårdra därför manuellt!

☒ Solen kan göra att rutchbanan blir väldigt varm. Banans nedfart rekommenderas att vändas i norrlig riktning

☒ Om lekplatsen placeras vid en gångväg mm bör området säkras mot genomfart av gående och cyklister.

☒ Inspringningshinder bör placeras runt lekutrustning med stor rörelse, t ex, gungställning.









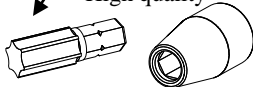

☒ Det bör vara fri insyn till lekutrustning beräknat till barn under 3 år.

OBS! Under monteringsarbete bör utrustningen som inte ska förankras i marken, ställs så att den inte kan välta.

Området måste spärras när lekutrustningen byggs upp, med avspärrningsband eller liknande.

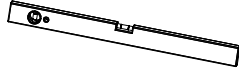
2

Nødvendig værktøj / Tools required / Nödvändiga verktyg

<p>A</p> 	<p>B</p>  <p>Torx Nr 45 High quality</p> 	<p>C</p>  <p>13 mm 17 mm</p> 	<p>D</p> 	<p>E</p> 
<p>F</p> 	<p>G</p> <p>Metermål Metric measure Tumstock</p> 	<p>H</p> <p>18V</p> 	<p>I</p> <p>Merkebånd Mark ribbon Märkeband</p> 	<p>J</p> <p>5 mm</p> 

3

Nødvendig antal personer / Number of persons required / Lämpligt antal personer



4



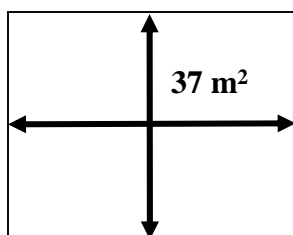

Anbefalt arealbehov ved montering / Recommended working space / Rekommenderad arealbehov vid montering





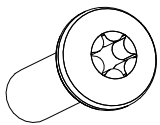
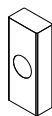







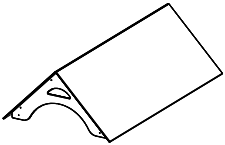

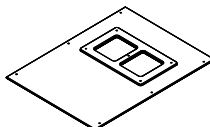





5

**Pakkliste for / Parts list for / Packlista för :
26-104-060**

Sign. _____

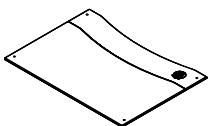
N UK S	Bolter/skruer Bolts/Screws Komponenter	Dimensjon Dimension Dimension	Ant Qty Ant	Lev Lev Lev	Bolter/skruer Bolts/Screws Bultar/Skruvar	Dimensjon Dimension Dimension	Ant Qty Ant	Lev Lev Lev
		04-000-012 8 x 12 mm Torx	8				04-060-050 50 x 15 x 8 mm	4
	04-000-035 8 x 35 mm Torx	28						
		04-090-002	24		(N) Produkt merking (UK) Product marking (S) Produkt märkning		1	
		04-030-016 8 x 16 mm	8					
		04-070-050 50 x 50 x 5 mm 11mm hull	2		Monteringsanvisning Assembly Instructions Monteringsanvisning		1	

Boltepakker for / Boltpackage for / Bultpaket för 26-104-060

01-128-050  Antall Number Antal		04-060-050 50 x 15 x 8 mm	6		01-125-004  Antall Number Antal		04-060-050 50 x 15 x 8 mm	6 X 2
		04-000-012 8 x 12 mm Torx	32				04-000-025 8 x 25 mm Torx	12 X 2
		04-000-035 8 x 35 mm Torx	6				04-000-012 8 x 12 mm Torx	5 X 2
		04-070-035 35 x 35 x 3 mm	16				04-076-050 9mm hull 50 x 50 x 5 mm	6 X 2
		04-030-011 8 x 11 mm	32				04-040-008 8 mm	6 X 2
		04-050-008 8 mm	32				04-030-016 8 x 16mm	5 X 2
01-125-001  Antall Number Antal		04-060-050 50 x 15 x 8 mm	4 X 3					
		04-000-025 8 x 25 mm Torx	8 X 3					
		04-076-050 9mm hull 50 x 50 x 5 mm	4 X 3					
		04-040-008 8 mm	4 X 3					

5

Pakkliste for / Parts list for / Packlista för :
26-104-060

Sign. _____

Forankring / Foundations / Markförankring

00-003-003

N Er bestilt Ikke bestilt
 UK In order Not in order
 S Beställt Ej beställt

00-400-997

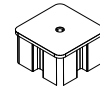

-6

00-003-100 00-003-101 00-003-102	6	04-000-035 8 x 35 mm Torx	18	
		04-050-008 8 mm	18	
		04-060-120 120 x 15 x 8 mm	12	
00-003-103 	0	04-000-040 8 x 40 mm Torx	0	
		04-040-008 8 mm	0	
		04-050-008 8 mm	0	
00-003-105 00-003-106 	0	04-010-035 10 x 35 mm	0	
		04-040-010 10 mm	0	
		04-050-010 10 mm	0	

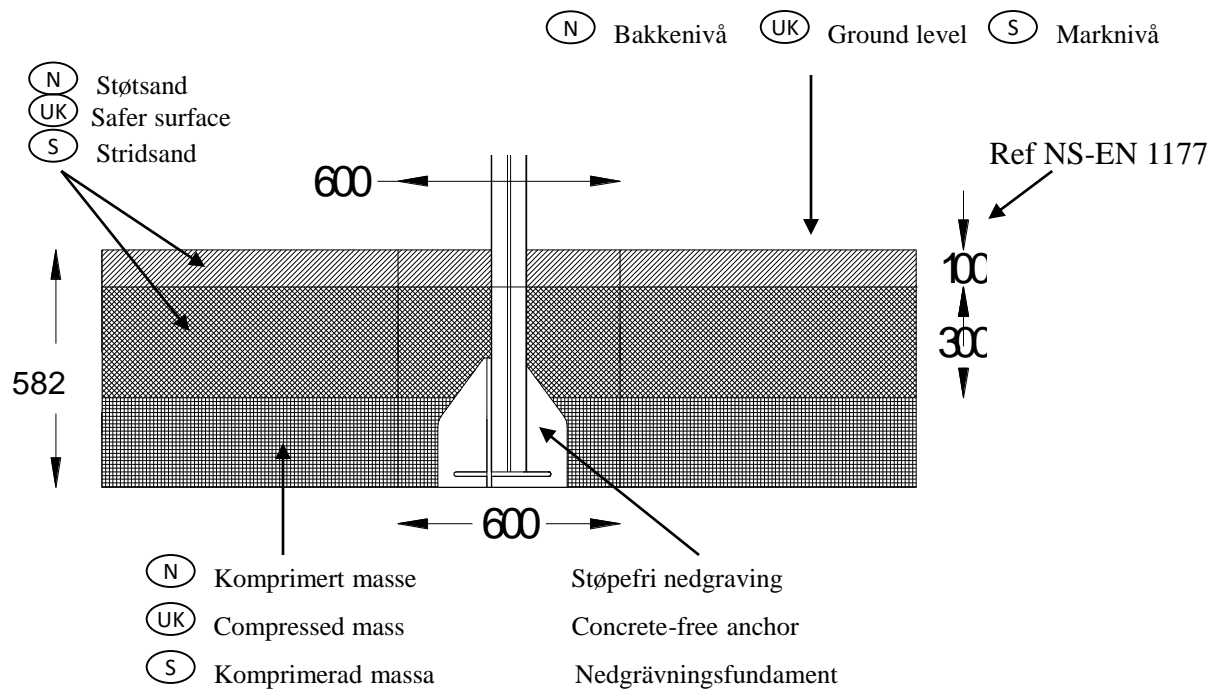
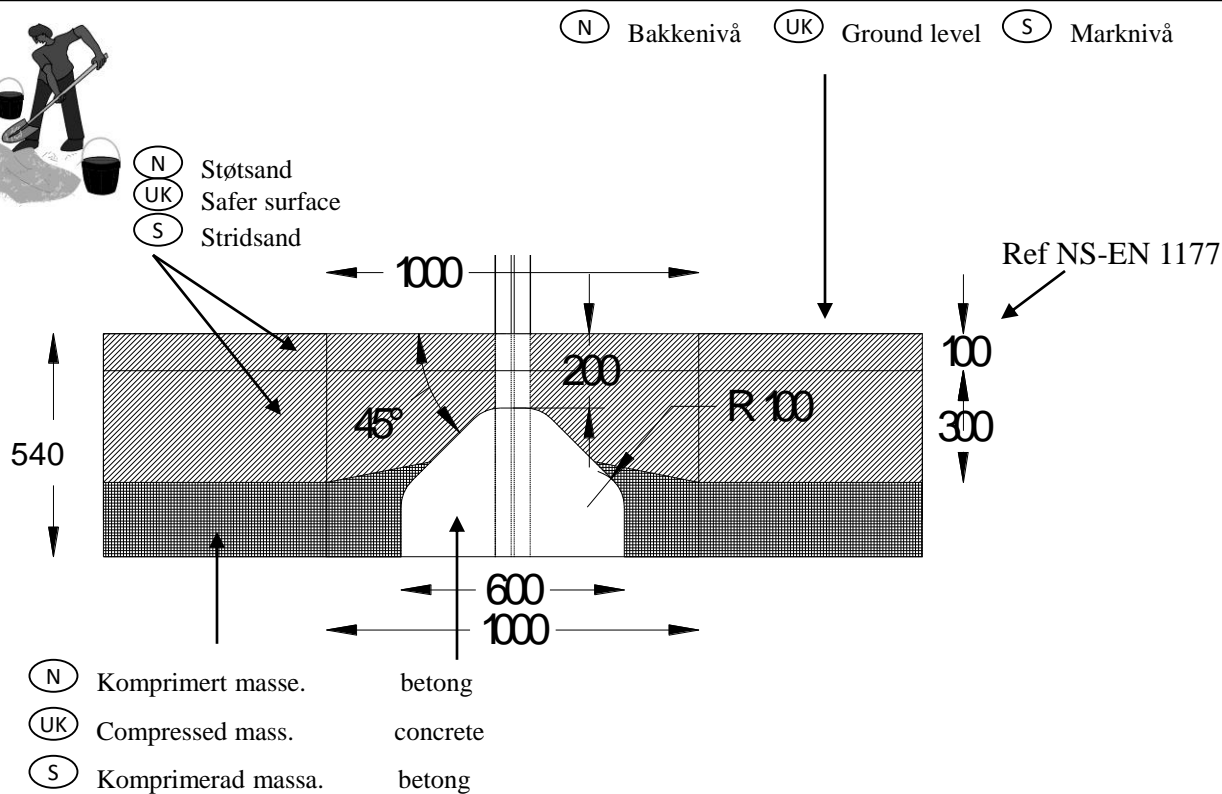

- (N) For klatrenett
- (UK) For climbing net
- (S) För klätternät

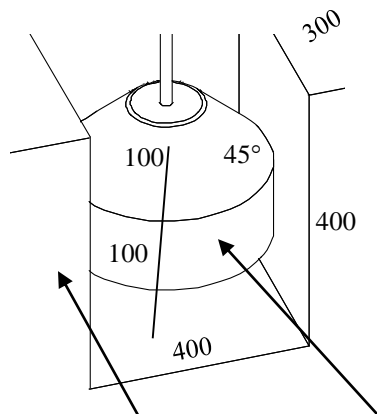

- (N) Komprimert masse. betong
- (UK) Compressed mass. concrete
- (S) Komprimerad massa. betong

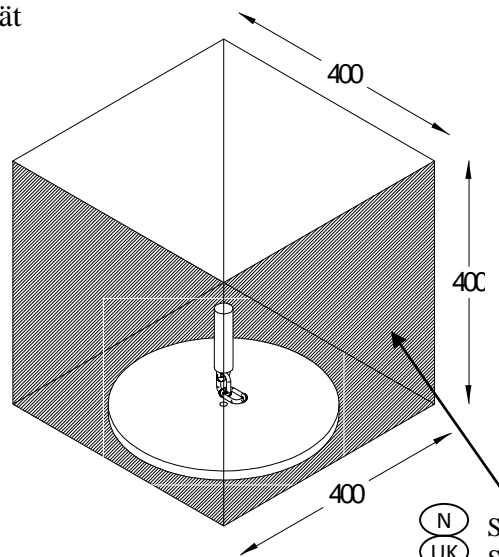

- (N) Støtsand
- (UK) Safer surface
- (S) Stridsand

(N) Alle mål er oppgitt i millimeter

(UK) Scale measured in mm

(S) Alla mått är i millimeter.

6

(N) Dybde for støping og forankring

(UK) Depth of foundations /

(S) Djup för gjutning och markförankring

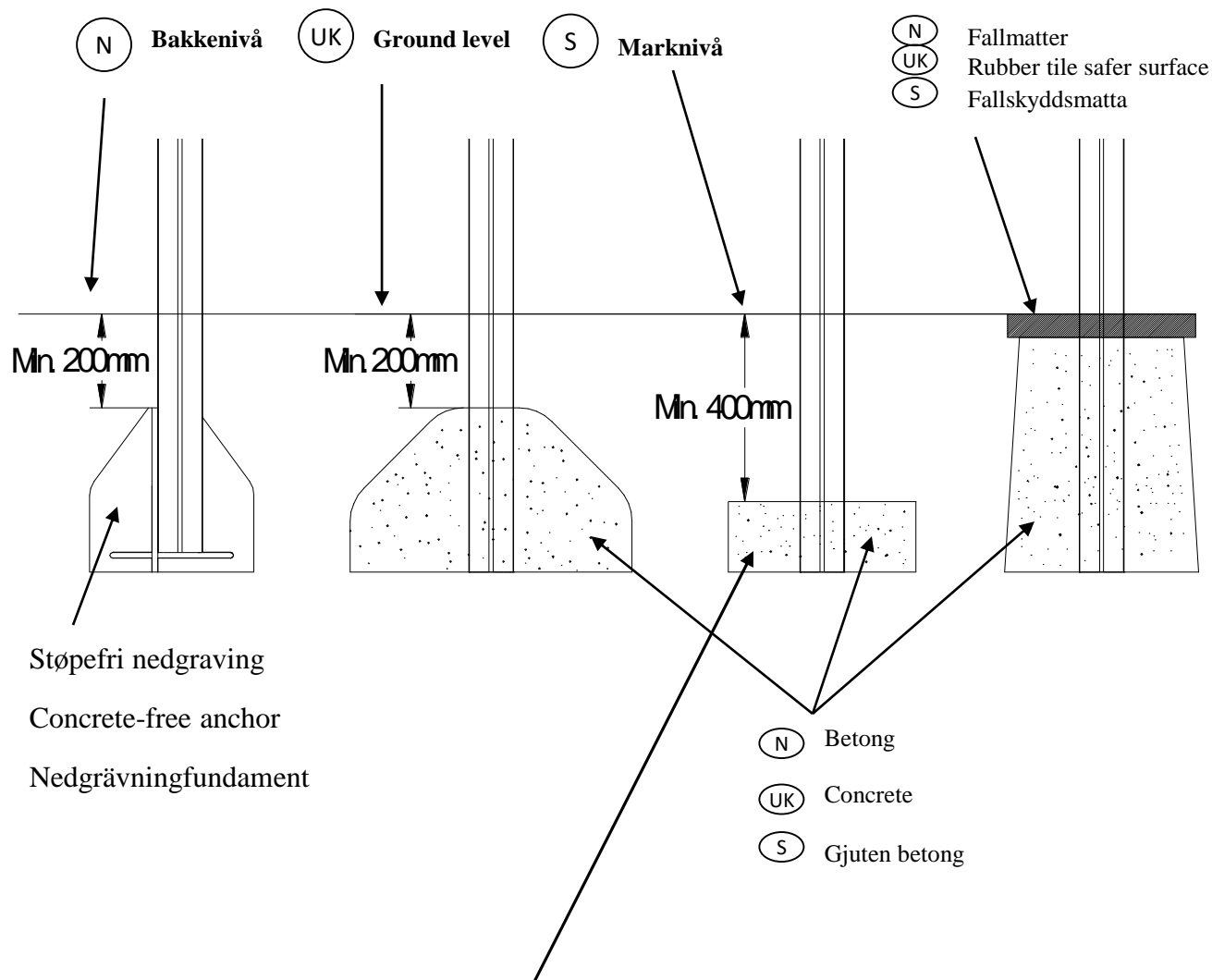

(N) Denne støpemetoden anbefales ikke grunnet dårlig stabilitet av lekeapparatet.

(UK) This anchor is recommend not to use because of poor stability of the play unit.

(S) Denna förankring avrådes från att användas, därför att lekutrustningen får dålig fäste.

1

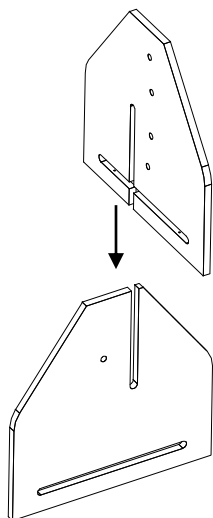

2

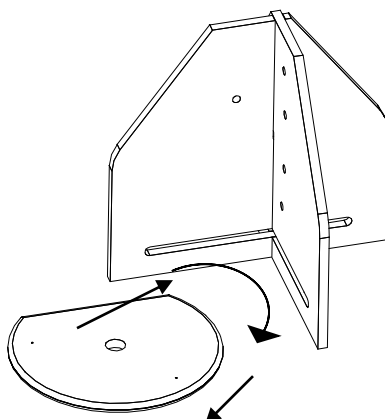

3

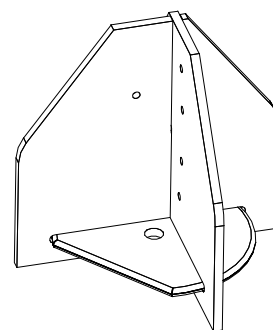

4

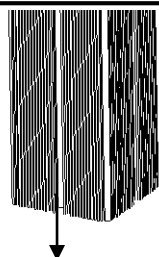

04-060-120 x 2
120 x 15 x 8 mm



04-000-035 x 3
8 x 35 mm Torx

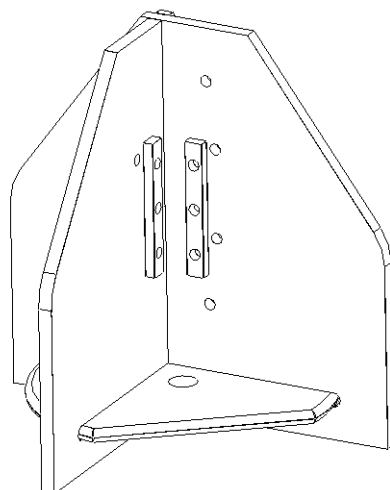

7

Plassering av forankringer / Ground plan / Placering av förankringar

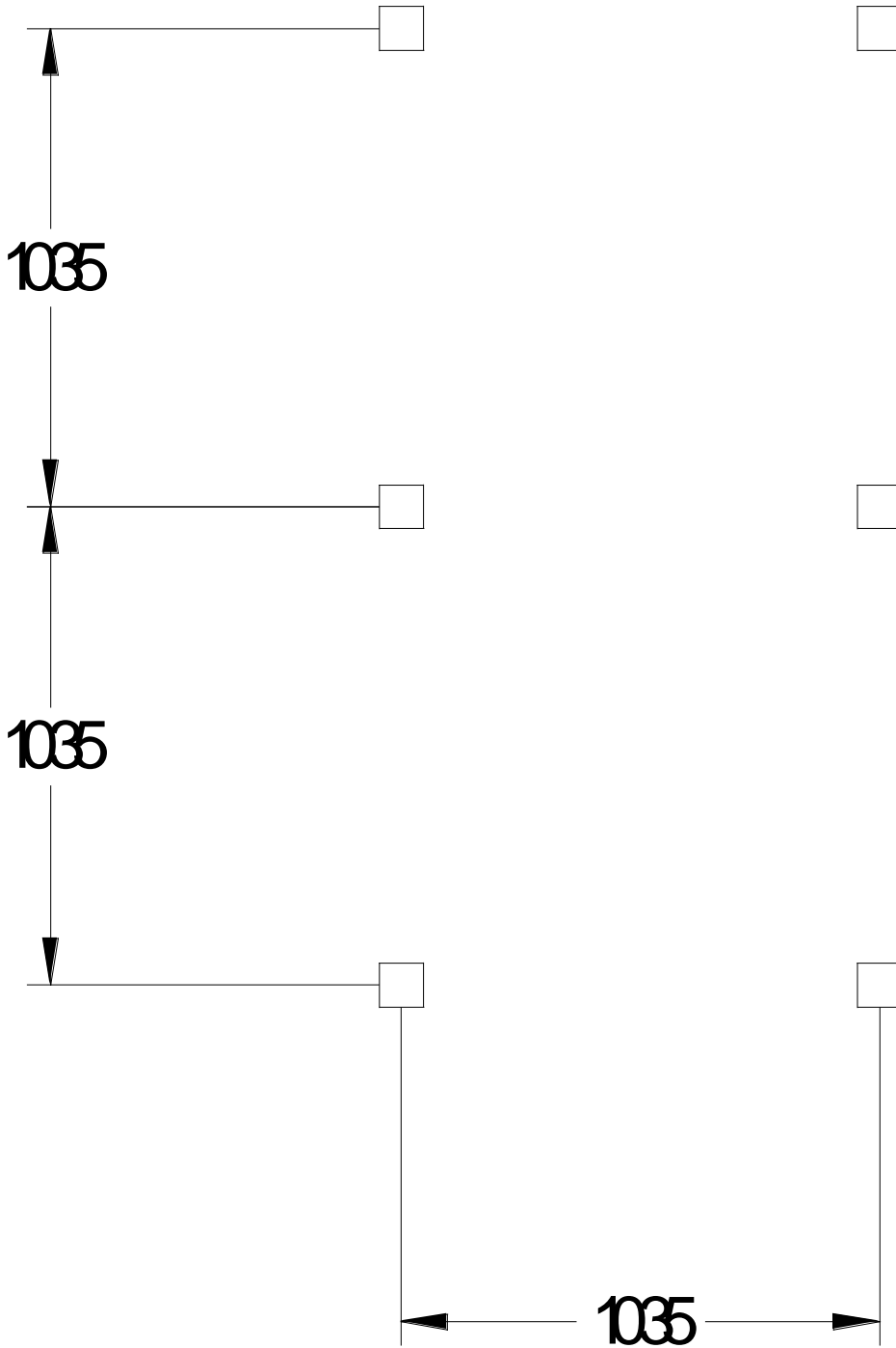

N

Alle mål er oppgitt i millimeter

UK

Scale measured in mm

S

Alla mått är i millimeter.

8

Sikkerhetszone / Safety zone / Säkerhetszon

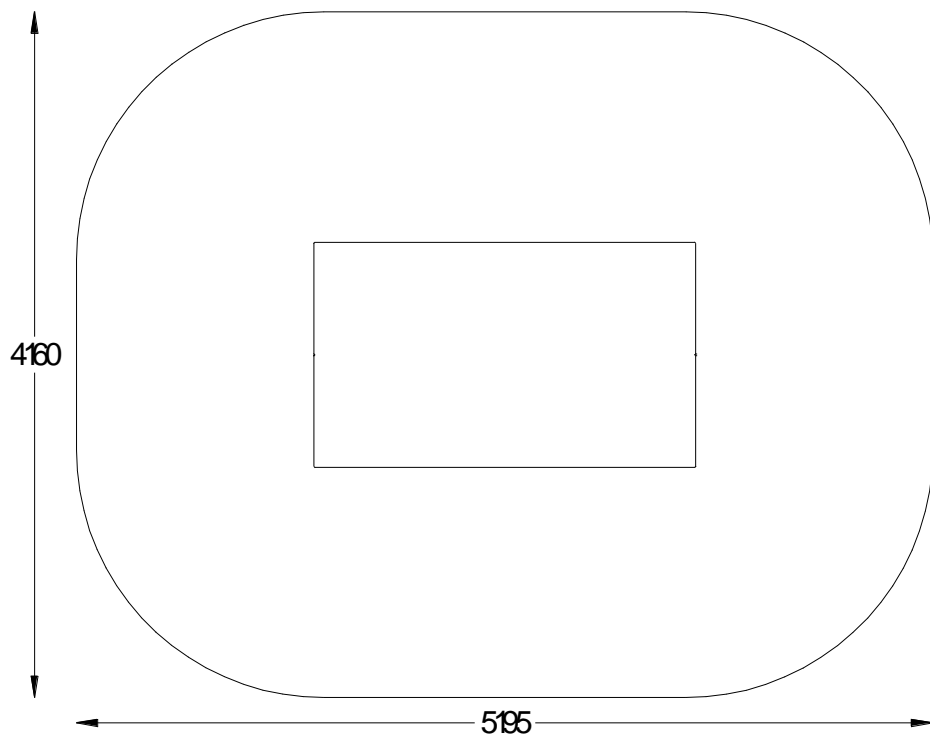

(N)

Alle mål er oppgitt i millimeter

(UK)

Scale measured in mm

(S)

Alla mått är i millimeter.

9

Fallhøyder / Free height of fall / Fallhöjder



(N)

Alle mål er oppgitt i millimeter

(UK)

Scale measured in mm

(S)

Alla mått är i millimeter.

210

OBS !

- Ⓝ Bolter skrues helt igjennom aluminiumstolpene. Om elektrisk drill brukes anbefales 18 V
- ⓊⓀ Bolts must be tightened through the post, so that it pierces the aluminium.
- Ⓢ Bultarna skruvas rakt igenom aluminiumstolparna. Om elektrisk skruvdragare används rekommenderas 18 V

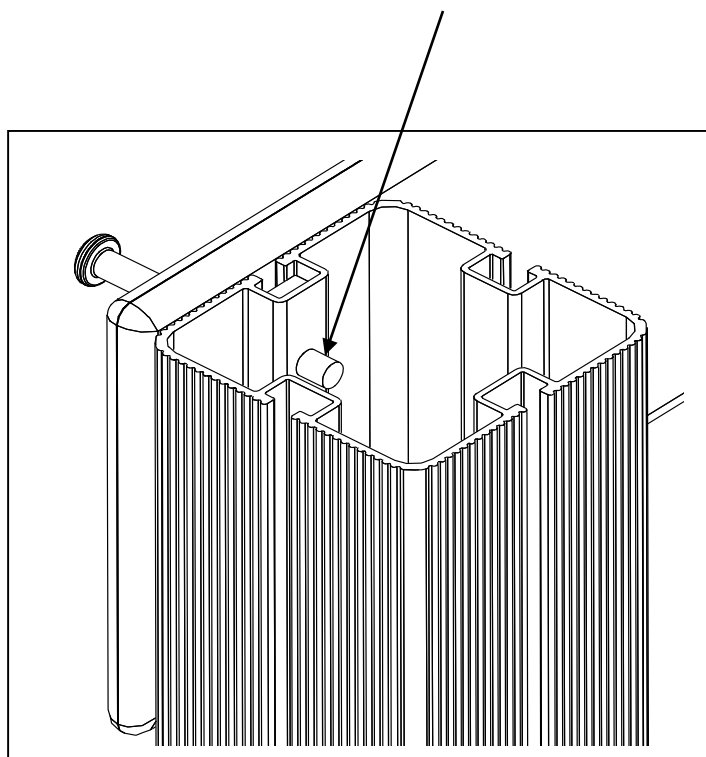

- (N) Med bruk av betong
- (UK) With use of concrete
- (S) Med bruk av betong

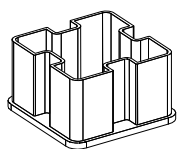
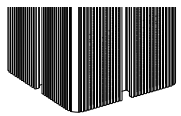

00-400-997

00-400-031 x 6

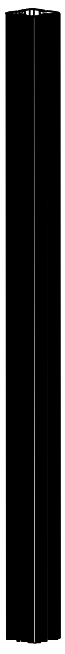
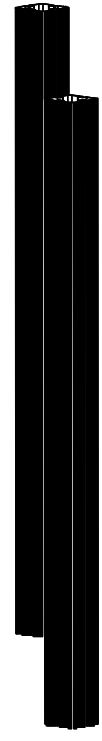
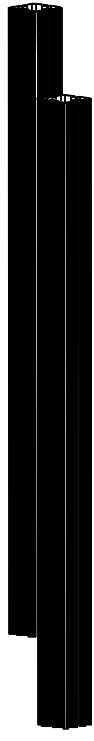

1

- (N) Utan betong
- (UK) Without concrete
- (S) Utan betong

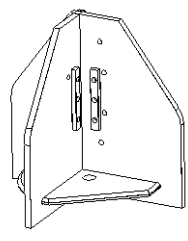

00-003-003

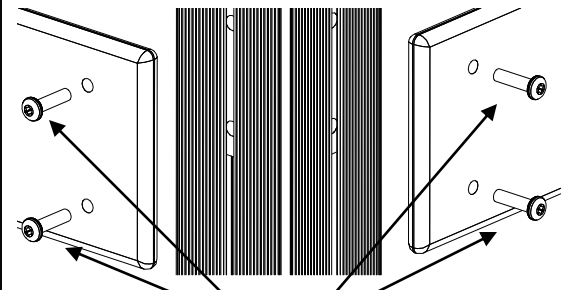

04-000-035
8 x 35 mm Torx

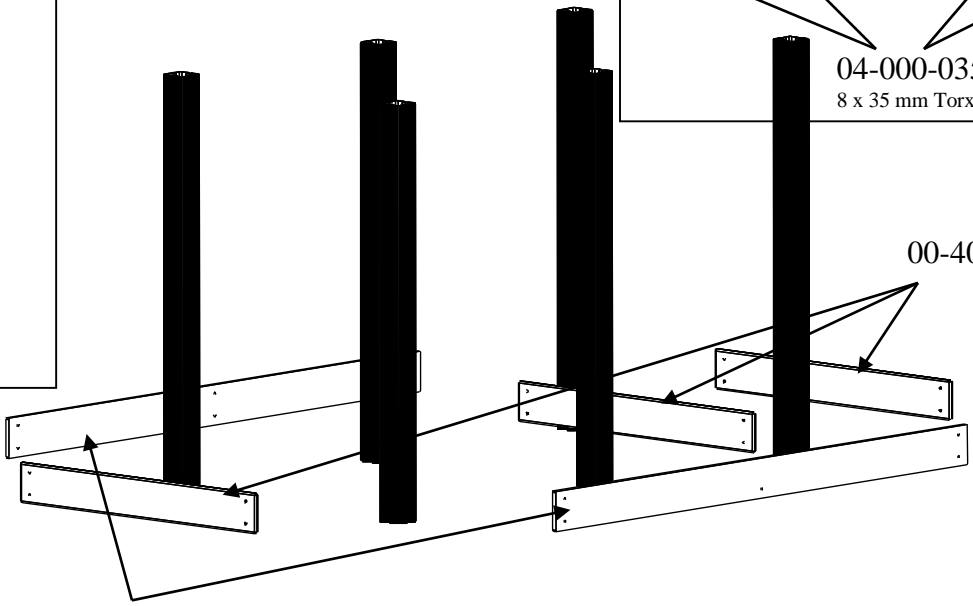

01-400-201

2

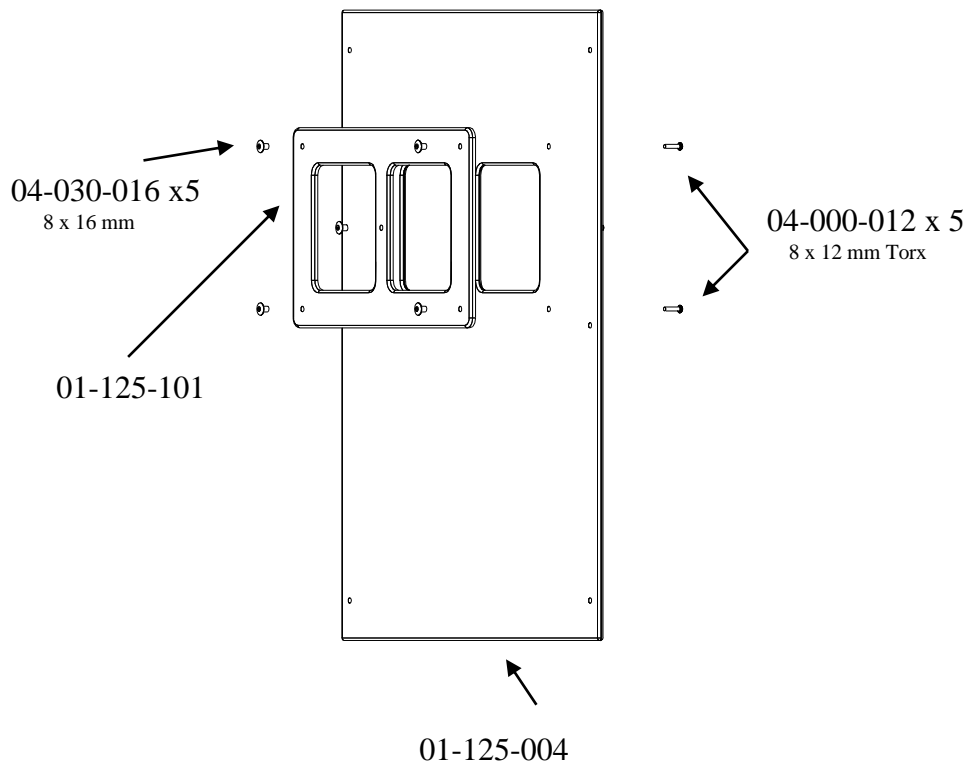

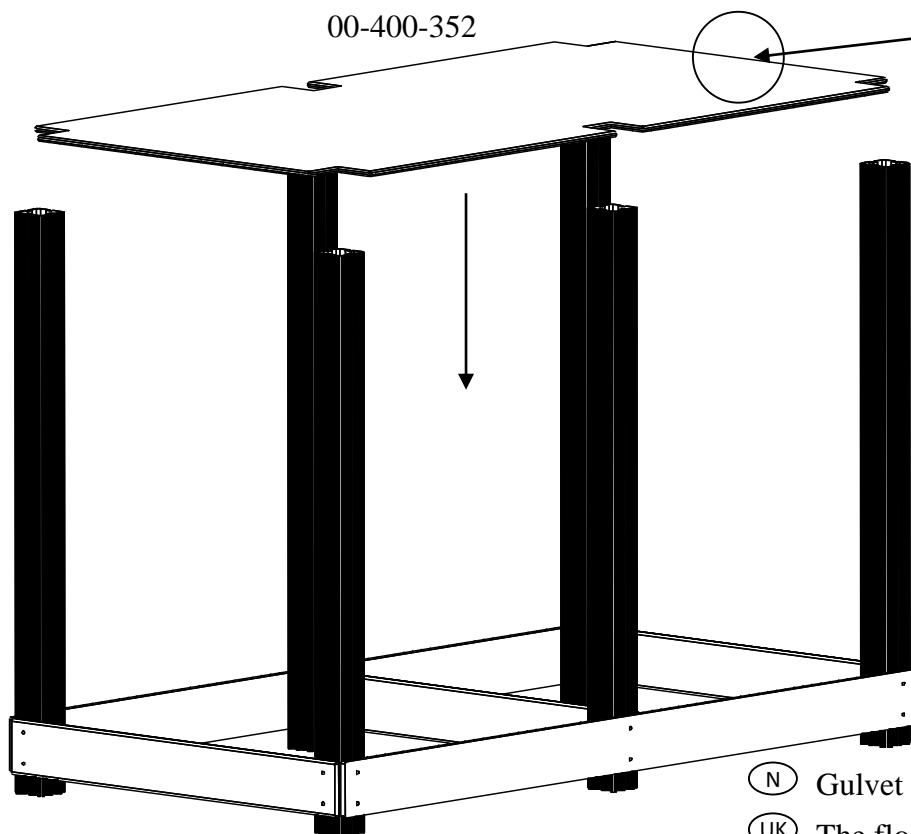

04-090-002 x 24



- (N) Gulvet festes ikke med vinkler
- (UK) The floor is not connected
- (S) Golvet fästes inte med vinklar

4

01-125-004

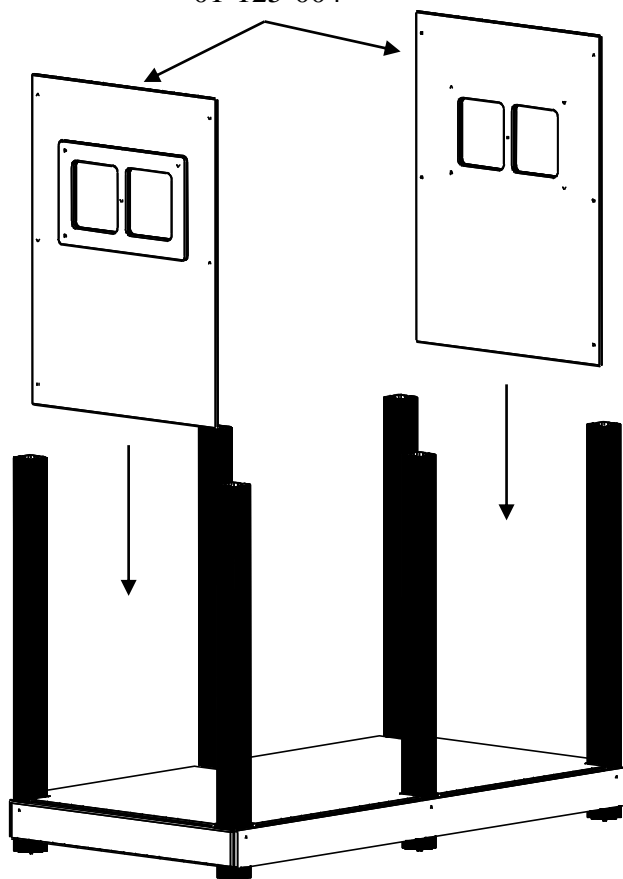

04-060-040

40 x 15 x 8 mm

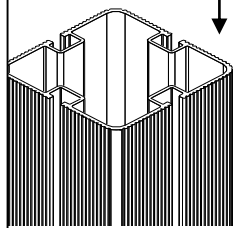

04-000-025

8 x 25 mm Torx



04-076-050

50 x 50 x 5 mm

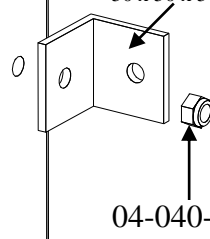

04-040-008

8 mm

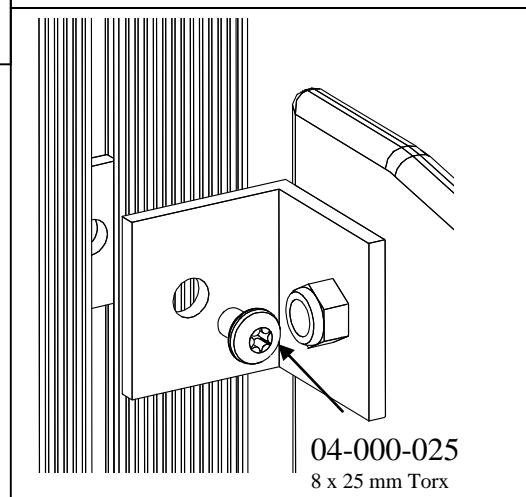

04-000-025

8 x 25 mm Torx

5

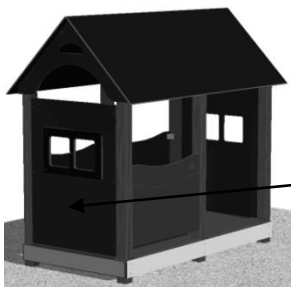

01-400-384

00-450-155

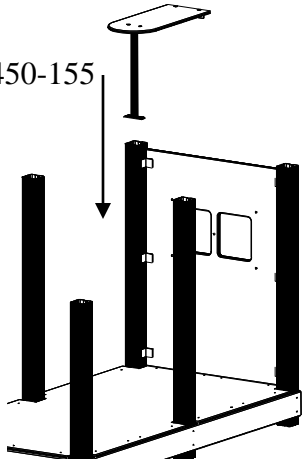

04-000-012
8 x 12 mm Torx



04-030-016
8 x 16mm

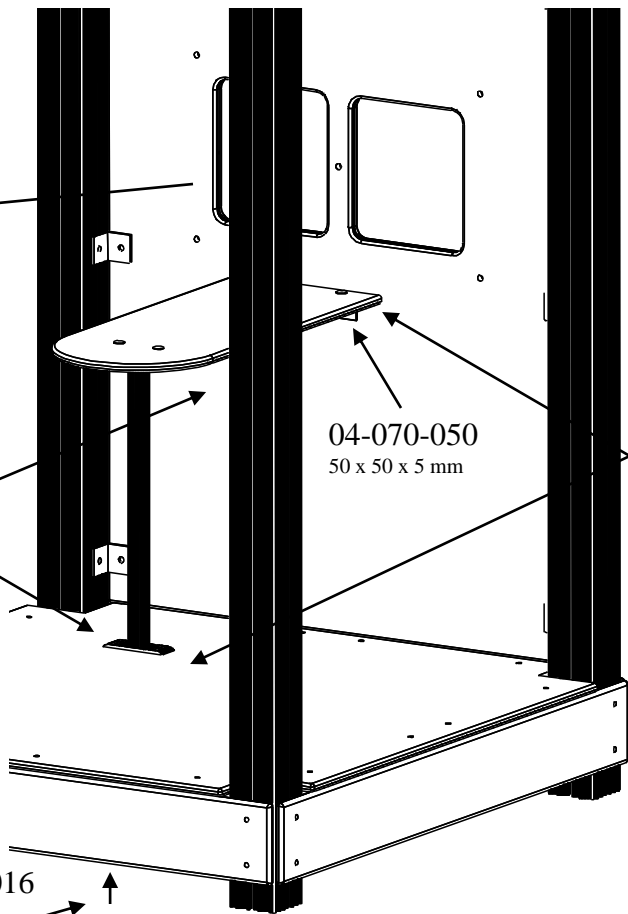

04-030-016
8 x 16mm

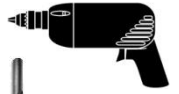

Ø 11 mm

04-070-050
50 x 50 x 5 mm

6

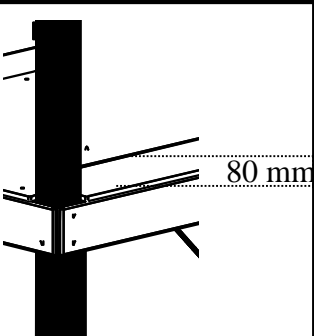

80 mm

01-125-001

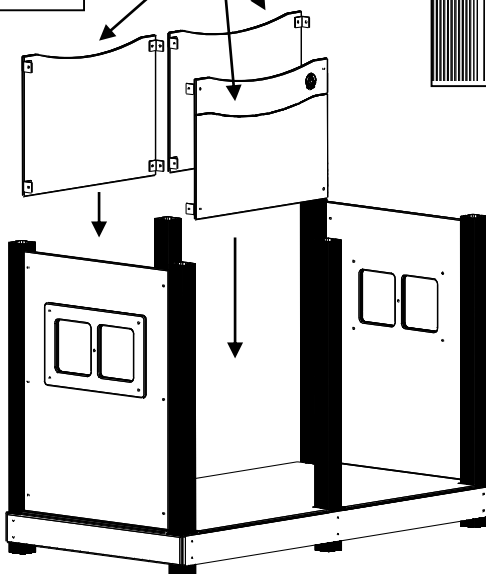

04-060-040
40 x 15 x 8 mm

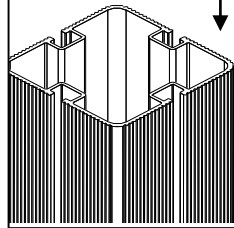

04-000-025
8 x 25 mm Torx

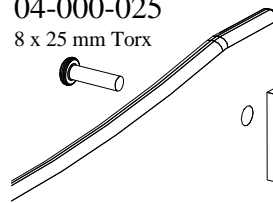

04-076-050
50 x 50 x 5 mm

04-040-008
8 mm

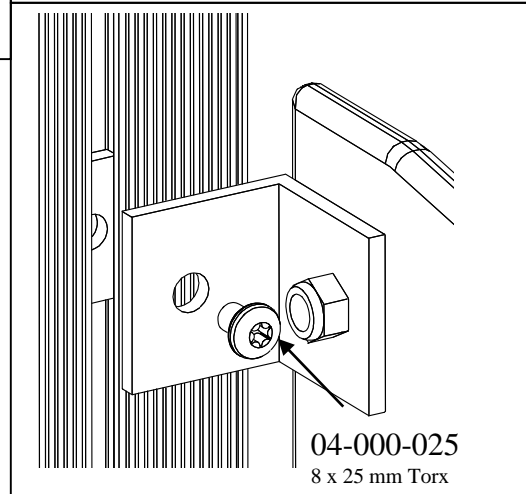

04-000-025
8 x 25 mm Torx

7

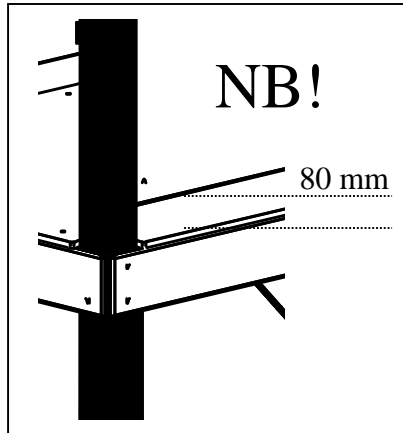
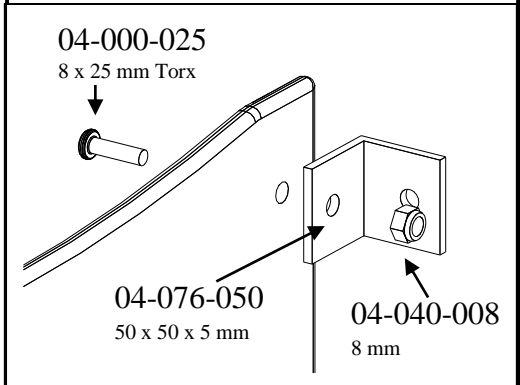
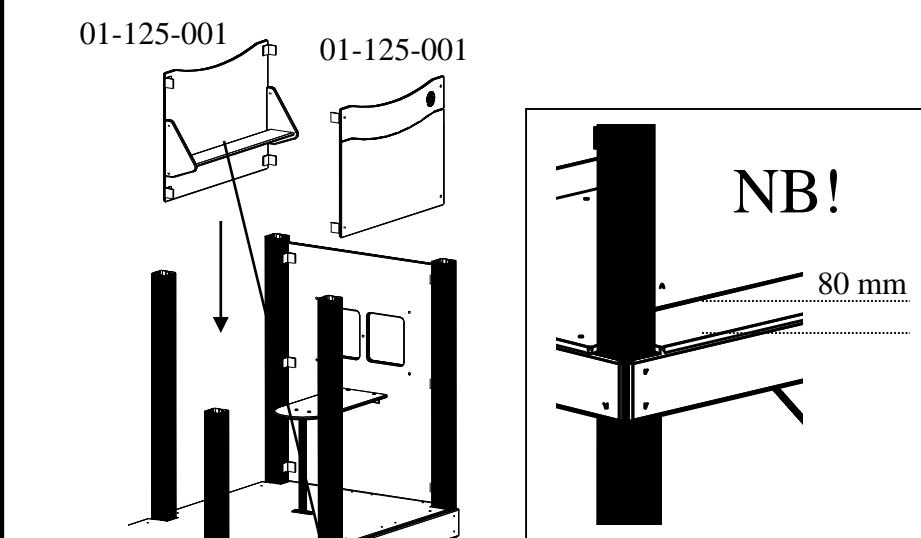
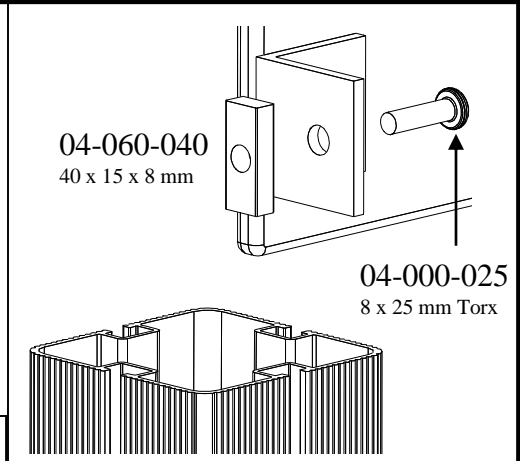
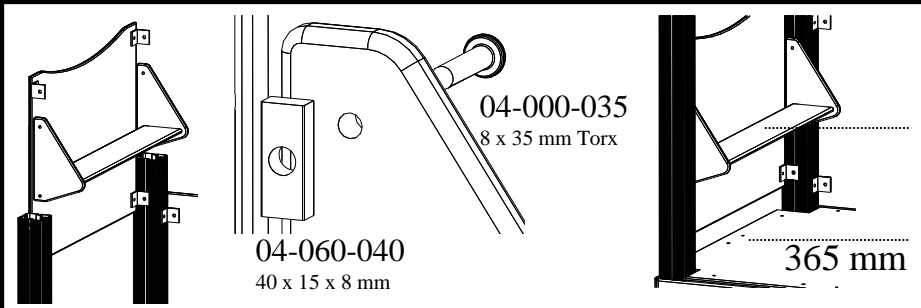

8

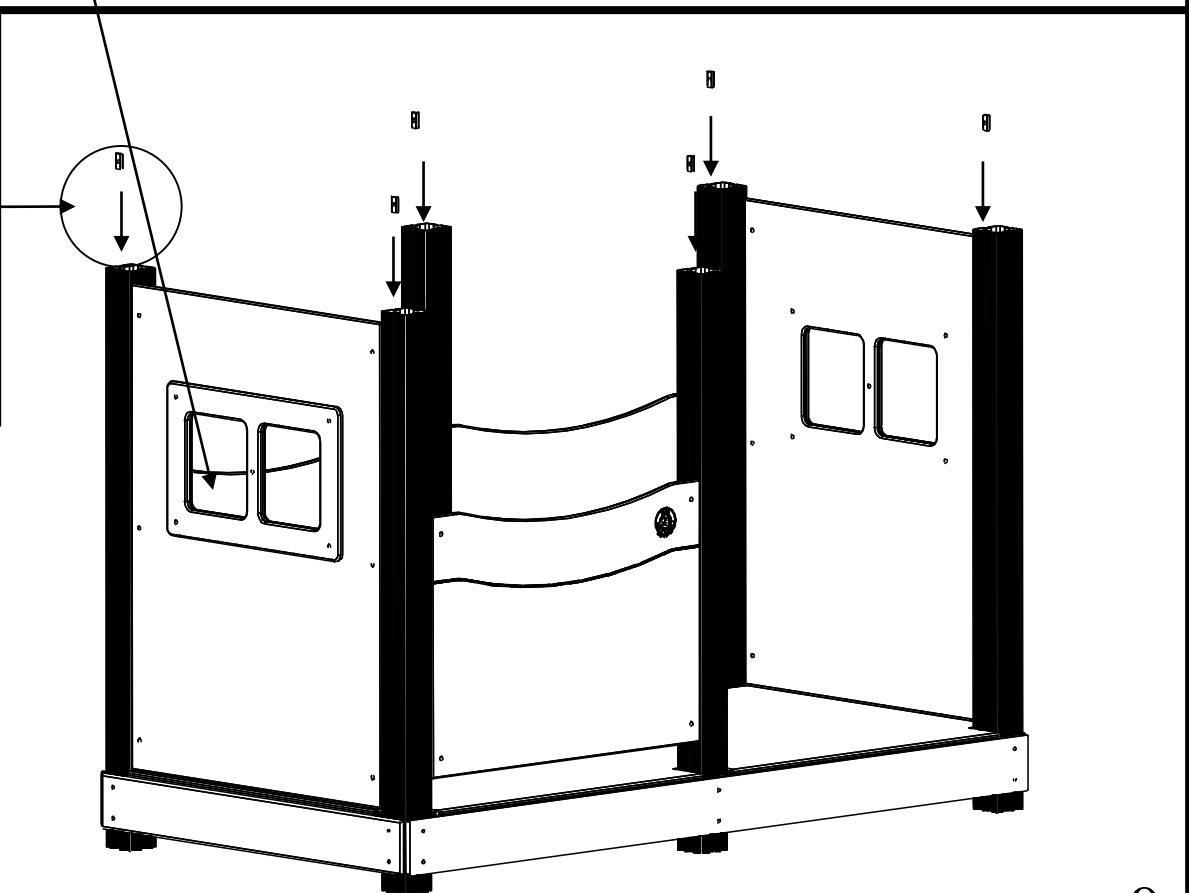
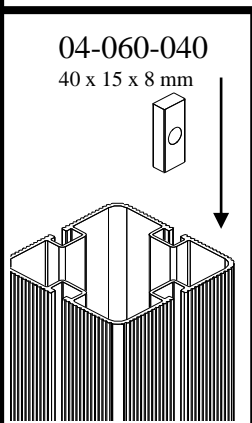

9

00-400-998 x 6

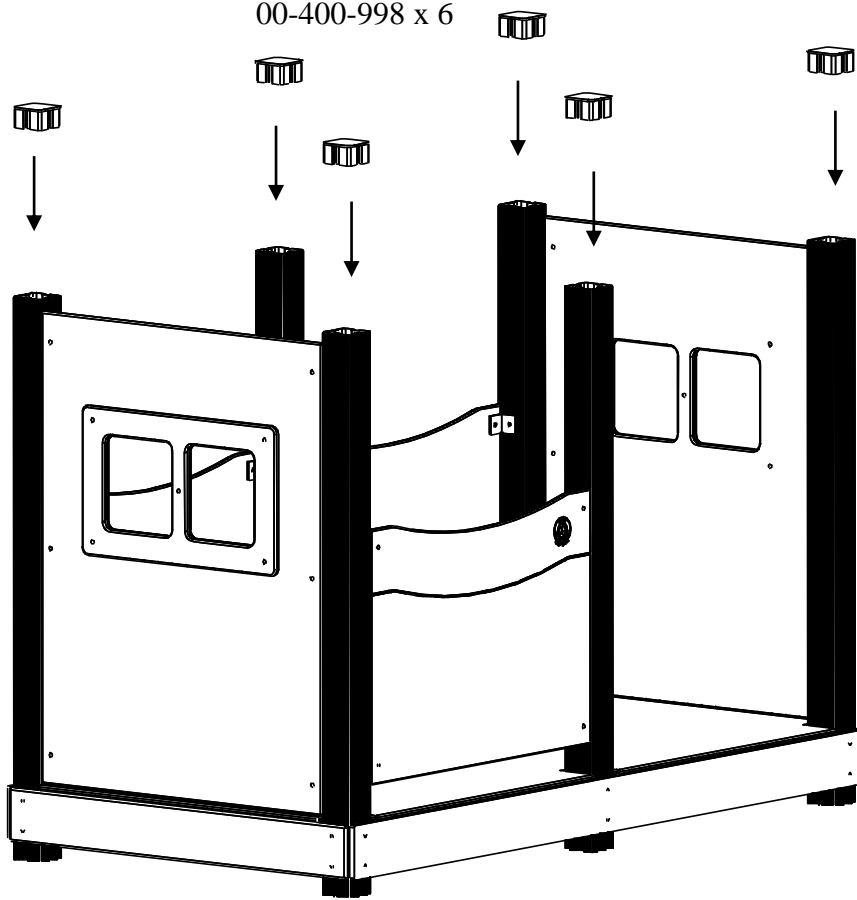

10

- (N) Se neste side for montering av taket
- (UK) See next page for assembly the roof
- (S) Se nesta side för montering av taket

01-128-050

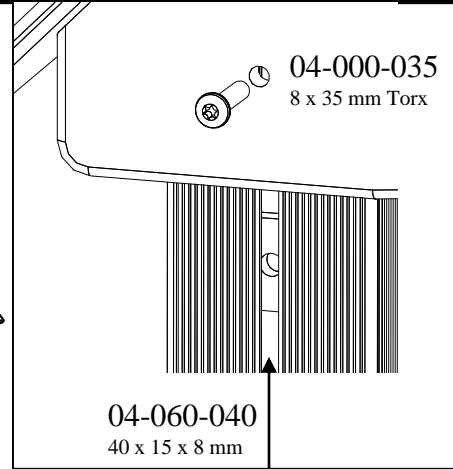
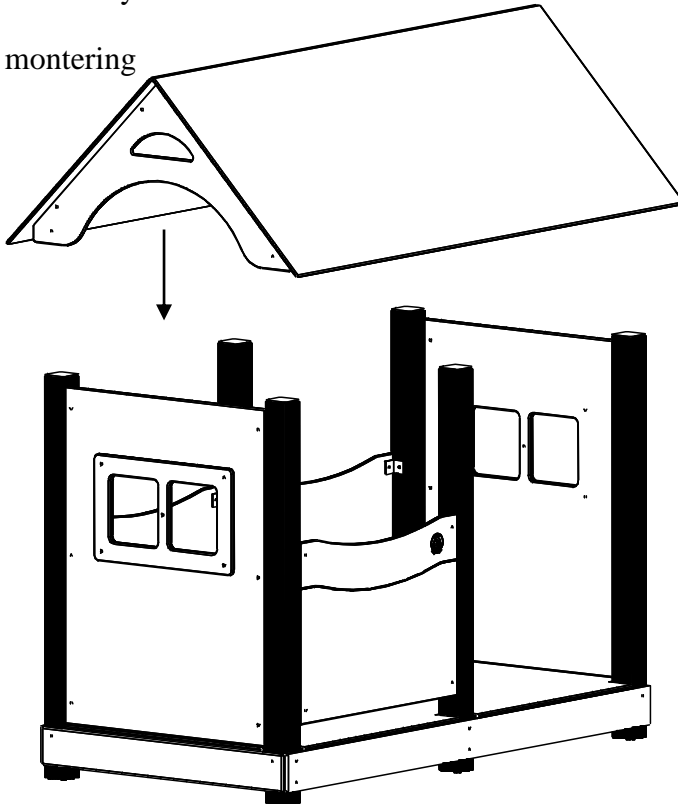

11

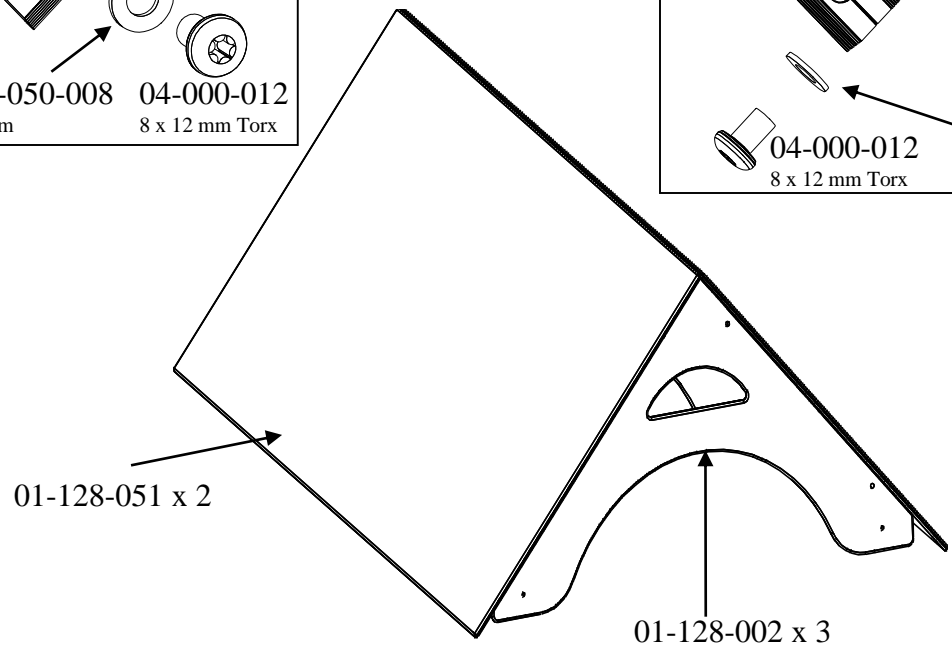
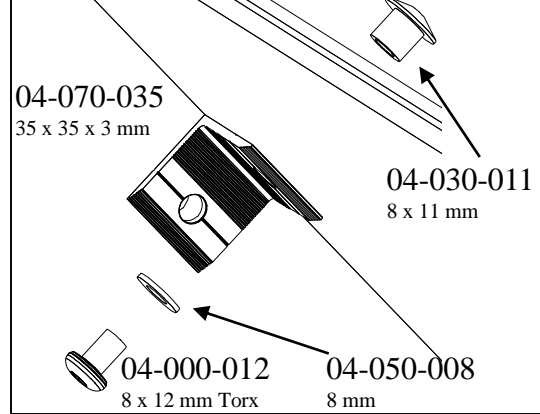
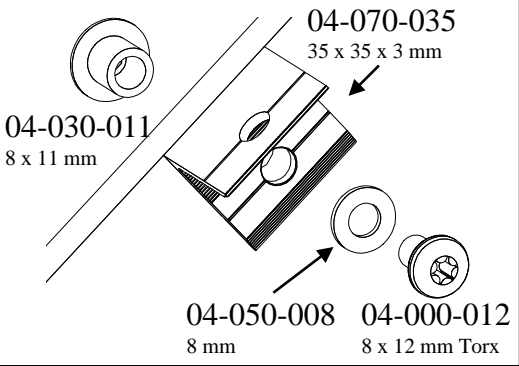

N

- ☑ Påse at fallunderlag er lagt i henhold til gjeldende regler eller vår anbefaling
- ☑ Fjern alle monteringshjelpemidler (rester av betong, planker, paller, plast, og lignende)
- ☑ Før utstyret tas i bruk, sjekk at det ikke er hektefare for anorakksnorer og lignende noen steder på lekeapparatet.

NB! Bør stå i 2-3 dager før bruk når forankring støpes.

UK

- ☑ Make sure the area and depth of safer surfacing are according to the current standard, or to the manufacturer's recommendation
- ☑ Make sure all tools and surplus materials are removed before play begins

PS! When complete, allow 2-3 days for the concrete to set before use.



S

- ☑ Kontrollera att fallunderlag är utlagt enligt gällande regler eller vår rekommendation
- ☑ Ta bort alla monteringshjälpmedel (rester av betong, plankor, pallar, plast och liknande)
- ☑ Innan lekredskapet används, kontrollera att anoracksnoddar eller kläder/delar av kläder eller liknande inte kan fastna i några delar på redskapet.

- ☑ OBS! Bör stå i 2-3 dagar innan användning när det gjuts

5
**Pakkliste for / Parts list for / Packlista för :
26-104-060**

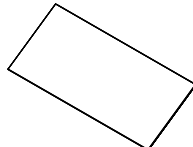
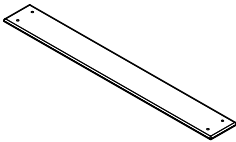
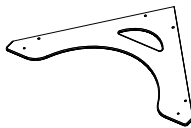
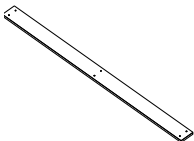
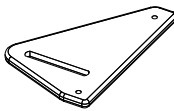
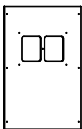

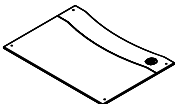
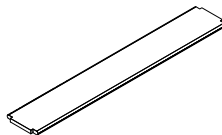
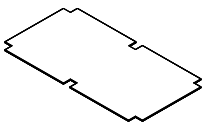
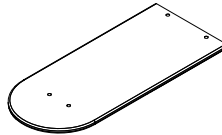
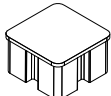
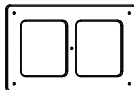
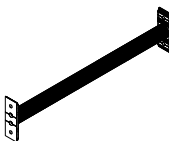

Sign. _____

N UK S	Komponenter	Dimensjon	Ant	Lev	Komponenter	Dimensjon	Ant	Lev
	Components	Dimension	Qty	Lev	Components	Dimension	Qty	Lev
	Komponenter	Dimension	Ant	Lev	Komponenter	Dimension	Ant	Lev
	00-400-031 	2150 x 95x 95	6		01-128-001 	2315 x 960 x 12	2	
	00-400-101 	1130 x 145 x 15	3		01-128-002 	1216 x 668 x 12	3	
	01-400-201 	2165 x 145 x 15	2		01-400-381 	300 x 194 x 12	1	
	01-125-004 	1240 x 940 x 24	2		01-400-382 		1	
	01-125-001 	940 x 686 x 12	3		01-400-379 	930 x 150 x 12	1	
	00-400-352 	2195 x 1160 x 15	1		01-400-384 	700 x 300 x 15	1	
	00-400-998 	55 x 95 x 95	6		01-125-101 	680 x 400	2	
	00-400-997 Med hull		6		00-450-155 	520 x 120 x 40	1	



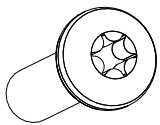
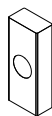







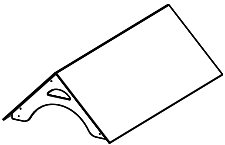

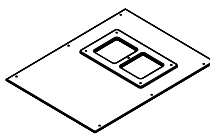





5

**Pakkliste for / Parts list for / Packlista för :
26-104-060**

Sign. _____

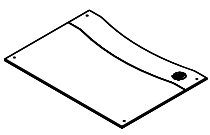
N UK S	Bolter/skruer Bolts/Screws Komponenter	Dimensjon Dimension Dimension	Ant Qty Ant	Lev Lev Lev	Bolter/skruer Bolts/Screws Bultar/Skruvar	Dimensjon Dimension Dimension	Ant Qty Ant	Lev Lev Lev
		04-000-012 8 x 12 mm Torx	8				04-060-050 50 x 15 x 8 mm	4
	04-000-035 8 x 35 mm Torx	28						
		04-090-002	24		(N) Produkt merking (UK) Product marking (S) Produkt märkning		1	
		04-030-016 8 x 16 mm	8					
		04-070-050 50 x 50 x 5 mm 11mm hull	2		Monteringsanvisning Assembly Instructions Monteringsanvisning		1	

Boltepakker for / Boltpackage for / Bultpaket för 26-104-060

01-128-050  Antall Number Antal <input type="checkbox"/>		04-060-050 50 x 15 x 8 mm	6		01-125-004  Antall Number Antal <input type="checkbox"/>		04-060-050 50 x 15 x 8 mm	6 X 2
		04-000-012 8 x 12 mm Torx	32				04-000-025 8 x 25 mm Torx	12 X 2
		04-000-035 8 x 35 mm Torx	6				04-000-012 8 x 12 mm Torx	5 X 2
		04-070-035 35 x 35 x 3 mm	16				04-076-050 50 x 50 x 5 mm 9mm hull	6 X 2
		04-030-011 8 x 11 mm	32				04-040-008 8 mm	6 X 2
		04-050-008 8 mm	32				04-030-016 8 x 16mm	5 X 2
01-125-001  Antall Number Antal <input type="checkbox"/>		04-060-050 50 x 15 x 8 mm	4 X 3					
		04-000-025 8 x 25 mm Torx	8 X 3					
		04-076-050 50 x 50 x 5 mm 9mm hull	4 X 3					
		04-040-008 8 mm	4 X 3					

5

Pakkliste for / Parts list for / Packlista för :
26-104-060

Sign. _____

Forankring / Foundations / Markförankring

00-003-003

N Er bestilt Ikke bestilt
 UK In order Not in order
 S Beställt Ej beställt

00-400-997



-6

00-003-100 00-003-101 00-003-102	6		04-000-035 8 x 35 mm Torx	18		
				04-050-008 8 mm	18	
				04-060-120 120 x 15 x 8 mm	12	
00-003-103 	0		04-000-040 8 x 40 mm Torx	0		
				04-040-008 8 mm	0	
				04-050-008 8 mm	0	
00-003-105 00-003-106 	0		04-010-035 10 x 35 mm	0		
				04-040-010 10 mm	0	
				04-050-010 10 mm	0	