

(N) Monteringsanvisning

(UK) Assembly Instructions

(S) Monteringsanvisning

Produkt nr. / Product no. / Produkt nr.

26-233-025

Ordr. nr. _____

Dato. _____

Sign. _____



Søve Lekemiljø AS
3830 Ulefoss - Norway
Tlf: +47 35 94 65 65
www.sove.no



Søve AB
412 50 Göteborg
Phone: +46 (0)31 773 97 00
www.sove.se

17.10.2011

N

- ▣ Les monteringsanvisningen nøye før montering.
- ▣ Monter elementene i den rekkefølge som vist.
- ▣ Boltene bør ikke skrues for hardt til før alt er montert, vatret og loddet.
Skru så boltene til. NB! Ved bruk av drill, kan boltene ryke.
- ▣ På grunn av at solen kan gjøre rutsjebanen veldig varm, bør banens utløp vendes mot nord-øst eller nord-vest.
- ▣ Er lekeutstyret plassert i naturlige ferdselstraseer må området sikres mot spontan gjennomgang.
- ▣ Innspringningshinder bør vurderes rundt lekeapparater hvor det er stor bevegelse, f.eks. huskestativ.
- ▣ Det bør være fritt innsyn til lekeutstyr som er beregnet for barn under 36 mnd.

NB! Under monteringsarbeidet må utstyret som ikke er forankret forsvarlig i bakken Avstives slik at det ikke kan velte som følge av vind og lignende, eller ukontrollert bruk. Området må avstenges under oppsettelse av apparatene med sperrebånd og lignende.

UK

- ▣ Read the instruction carefully before assembling the play unit.
- ▣ Assemble the components in the sequence shown in these instructions.
- ▣ Fixings must not be fully tightened during assembly. Before casting the foundations, the structure must be level and plumb, at which point all fixings are tightened. PS! If use of drill, the bolts will be wrecked.
- ▣ Avoid positioning the slide facing due south because of overheating – ideal positions are facing north-east or north-west.
- ▣ Secure the construction area to prevent people from walking through it.
- ▣ Consider installing barriers around play equipment which gives rise to a lot of activity – i.e. swings.
- ▣ Ensure that clear vision is possible across the play area so that supervision is possible from any position, particularly where children under 3 years of age will be playing.

NB! During assembly of the equipment, ensure that all structures are securely propped, especially when left overnight. Also ensure that equipment is supported whilst concrete foundations are setting and enclose the area securely to prevent access.

- ▣ Läs monteringsanvisningen noga före montering.
- ▣ Montera delarna i den ordningen som anvisas
- ▣ Skruvarna bör inte skruvas för hårt tills allt är monterat, i våg och lodat. OBS! Vid användning av elektisk skruvdragare, kan bulten gå sönder.
- ▣ Solen kan göra att rutchbanan blir väldigt varm. Banans nedfart bör vändas mot norr.
- ▣ Om lekplatsen placeras vid en gångväg mm bör området säkras mot genomfart av gående och cyklister.
- ▣ Inspringshinder bör placeras runt lekutrustningen ifall det är utrustning som är, t ex, gungställning.
- ▣ Det bör vara fri insyn till lekutrustningen som är beräknat till barn under 36 månader.

OBS! Under monteringsarbete bör utrustningen som inte ska förankras i marken ställas så att det inte kan välta av vind eller liknande. Området måste spärras när lekutrustningen byggs upp, med avspärrningsband eller liknande.

2

Nødvendig verktøy / Tools required / Nödvändiga verktyg

N
UK
S

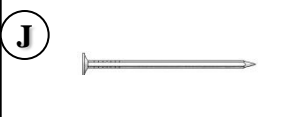
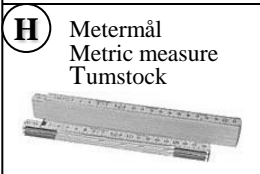
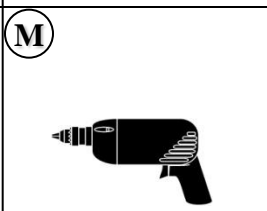
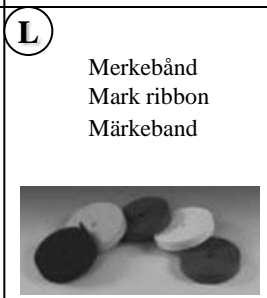
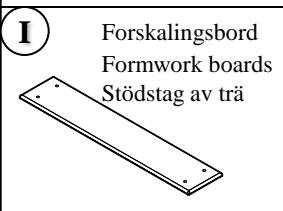
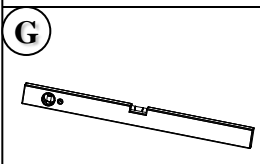
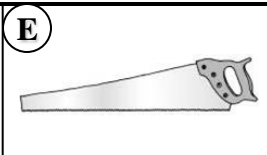
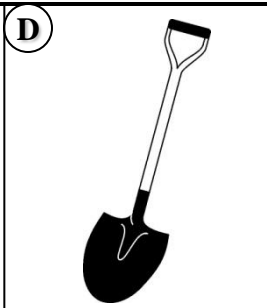
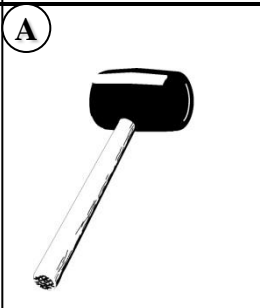

3

Nødvendig antall personer / Number of persons required / Lämpligt antal personer

N
UK
S

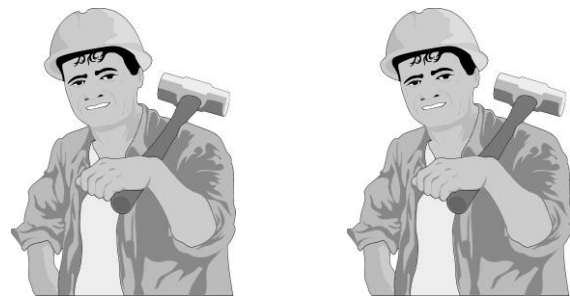

4



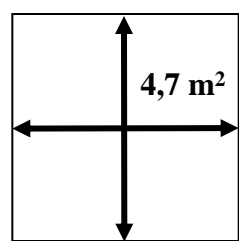

Anbefalt arealbehov ved montering / Recommended working space / Rekommenderad arealbehov vid montering

N
UK
S

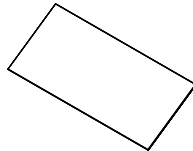
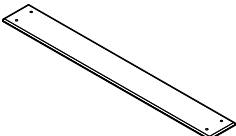
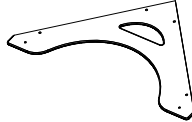
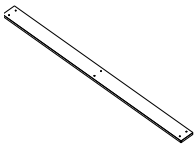
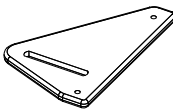
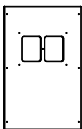
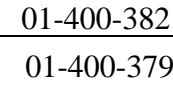

5
**Pakkliste for / Parts list for / Packlista för :
26-233-025**

Sign. _____

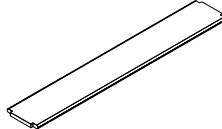
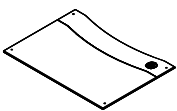
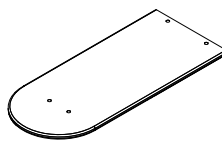
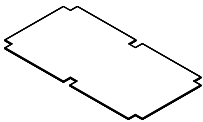
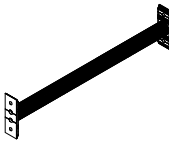
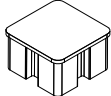
	Komponenter	Dimensjon	Ant	Lev	Komponenter	Dimensjon	Ant	Lev
	Components	Dimension	Qty	Lev	Components	Dimension	Qty	Lev
	Komponenter	Dimension	Ant	Lev	Komponenter	Dimension	Ant	Lev
	00-400-031 	2150 x 95x 95	6		01-128-001 	2315 x 960 x 12	2	
	00-400-101 	1130 x 145 x 15	3		01-128-002 	1216 x 668 x 12	3	
	01-400-201 	2165 x 145 x 15	2		01-400-381 	300 x 194 x 12	1	
	01-125-004 	1240 x 940 x 24	3		01-400-382 	300 x 194 x 12	1	
	01-125-003 	1260 x 940 x 36	1		01-400-379 	930 x 150 x 12	1	
	01-125-001 	940 x 686 x 12	2		01-400-384 	700 x 300 x 15	1	
	00-400-352 	2195 x 1160 x 15	1		00-450-155 	520 x 120 x 40	1	
	00-400-998 	55 x 95 x 95	6					
	00-400-997 Med hull		6					5

5

Pakkliste for / Parts list for / Packlista för :
26-233-025

Sign. _____



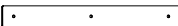
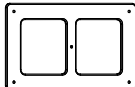



N
UK
S

Komponenter Components Komponenter	Dimensjon Dimension Dimension	Ant Qty Ant	Lev Lev Lev	Bolter/skruer Bolts/Screws Bultar/Skruvar	Dimensjon Dimension Dimension	Ant Qty Ant	Lev Lev Lev
01-125-103 	350 x 160	1					
01-125-102 	800 x 90	1					
01-125-101 	680 x 400	3					

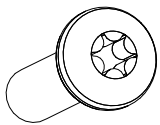









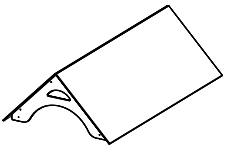

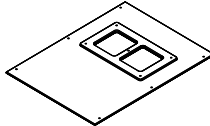











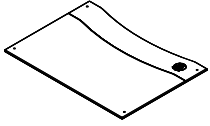

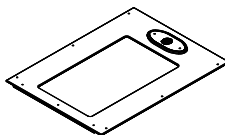
5

Pakkliste for / Parts list for / Packlista för :
26-233-025

Sign. _____

	Bolter/skruer Bolts/Screws Komponenter	Dimensjon Dimension Dimension	Ant Qty Ant	Lev Lev Lev	Bolter/skruer Bolts/Screws Bultar/Skruvar	Dimensjon Dimension Dimension	Ant Qty Ant	Lev Lev Lev
		04-000-012 8 x 12 mm Torx	8			04-060-040 50 x 15 x 8 mm	4	
		04-000-035 8 x 35 mm Torx	24					
		04-090-002	24		 Produkt merking Product marking Produkt märkning		1	
		04-030-016 8 x 16 mm	8					
		04-070-050 50 x 50 x 5 mm	2		Monteringsanvisning Assembly Instructions Monteringsanvisning		1	

Boltepakker for / Boltpackage for / Bultpaket för 26-233-025

01-128-050  Antall Number Antal <input type="checkbox"/>		04-060-040 50 x 15 x 8 mm	6		01-125-004  Antall Number Antal <input type="checkbox"/>		04-060-040 50 x 15 x 8 mm	6	X 3
		04-000-012 8 x 12 mm Torx	32				04-000-025 8 x 25 mm Torx	12	X 3
		04-000-035 8 x 35 mm Torx	6				04-000-012 8 x 12 mm Torx	5	X 3
		04-070-035 35 x 35 x 3 mm	16				04-076-050 50 x 50 x 5 mm	6	X 3
		04-030-011 8 x 11 mm	32				04-030-016 8 x 16 mm	5	X 3
		04-050-008 8 mm	32			04-040-008 8 mm	6	X 3	
01-125-001  Antall Number Antal <input type="checkbox"/>		04-060-040 50 x 15 x 8 mm	4	X 2	01-125-003  Antall Number Antal <input type="checkbox"/>		04-060-040 50 x 15 x 8 mm	6	
		04-000-025 8 x 25 mm Torx	8	X 2			04-000-025 8 x 25 mm Torx	15	
		04-076-050 50 x 50 x 5 mm	4	X 2			04-000-012 8 x 12 mm Torx	2	
		04-040-008 8 mm	4	X 2			04-030-016 8 x 16 mm	5	
						04-076-050 50 x 50 x 5 mm	6		
						04-040-008 8 mm	6		

5 Pakkliste for / Parts list for / Packlista för :
26-233-025

Sign. _____

Forankring / Foundations / Markförankring

00-003-003

N Er bestilt Ikke bestilt
 UK In order Not in order
 S Beställt Ej beställt

00-400-997

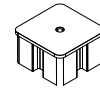

-6

00-003-100 00-003-101 00-003-102	6	04-000-035 8 x 35 mm Torx 04-050-008 8 mm 04-060-120 120 x 15 x 8 mm	18	18	12						
						00-003-103 	0	04-000-040 8 x 40 mm Torx 04-040-008 8 mm 04-050-008 8 mm	0	0	0
Eller Or Eller											

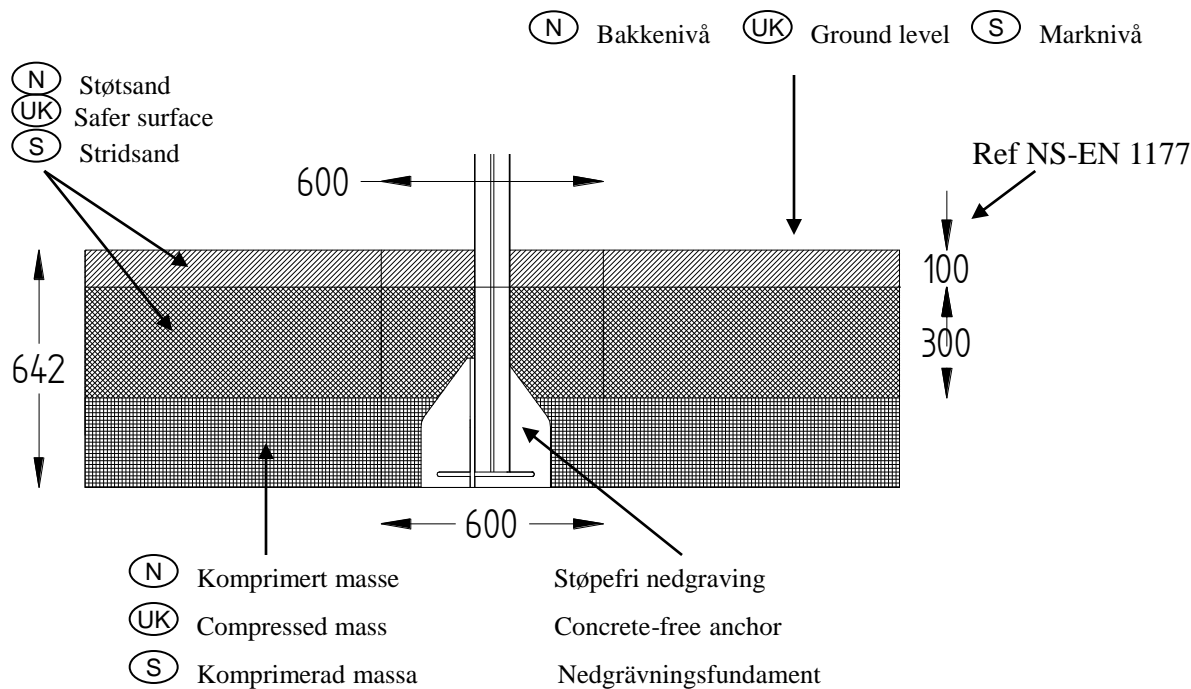
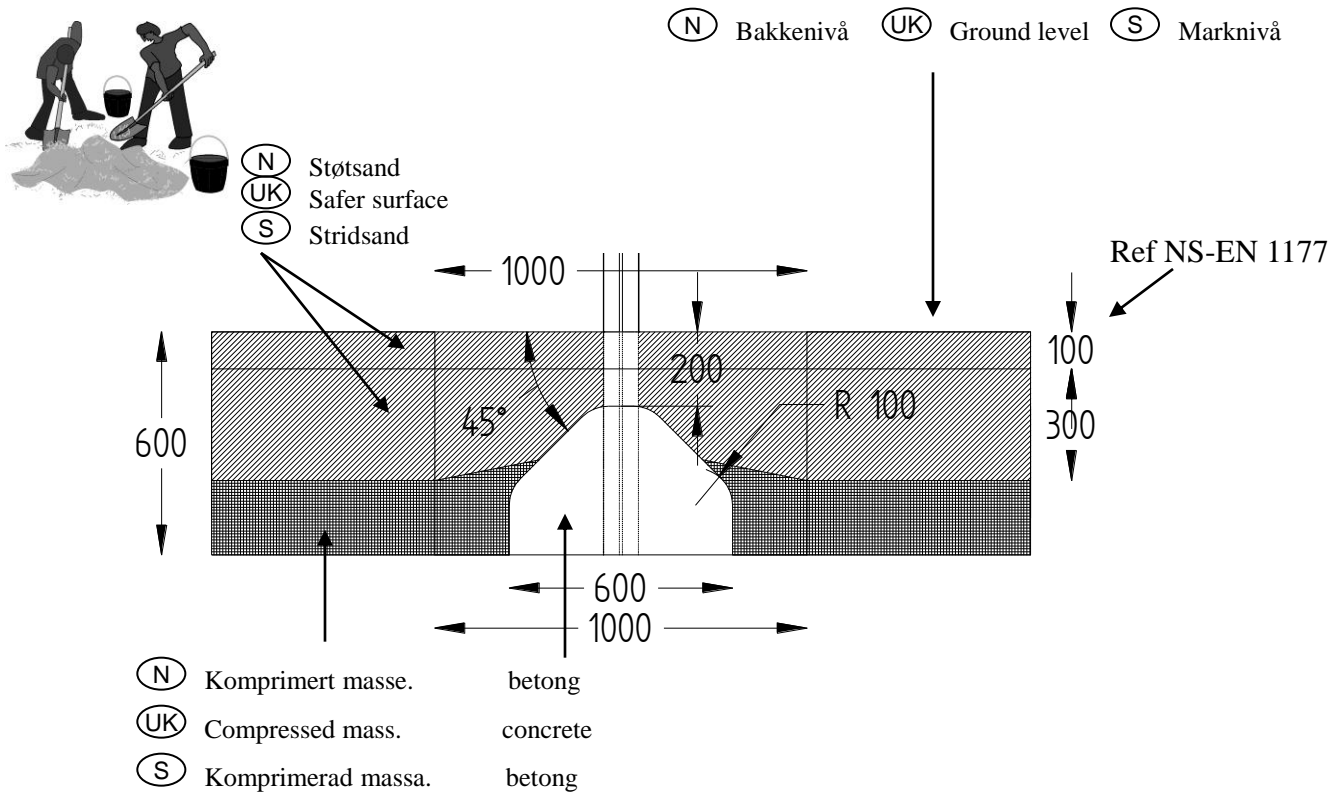

(N) Alle mål er oppgitt i millimeter

(UK) Scale measured in mm

(S) Alla mått är i millimeter.

- (N) For klatrenett
- (UK) For climbing net
- (S) För klätternät

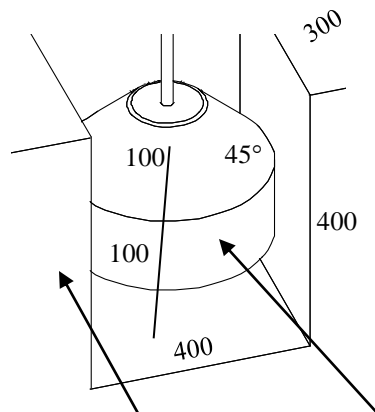

- (N) Komprimert masse. betong
- (UK) Compressed mass. concrete
- (S) Komprimerad massa. betong

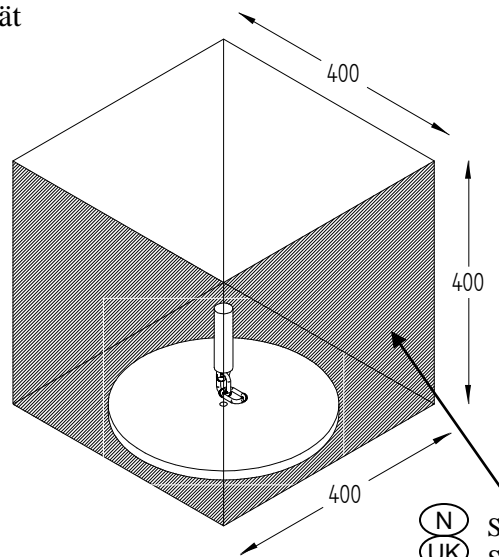

- (N) Støtsand
- (UK) Safer surface
- (S) Stridsand

- (N) Alle mål er oppgitt i millimeter
- (UK) Scale measured in mm
- (S) Alla mått är i millimeter.

6

(N) Dybde for støping og forankring

(UK) Depth of foundations /

(S) Djup för gjutning och markförankring

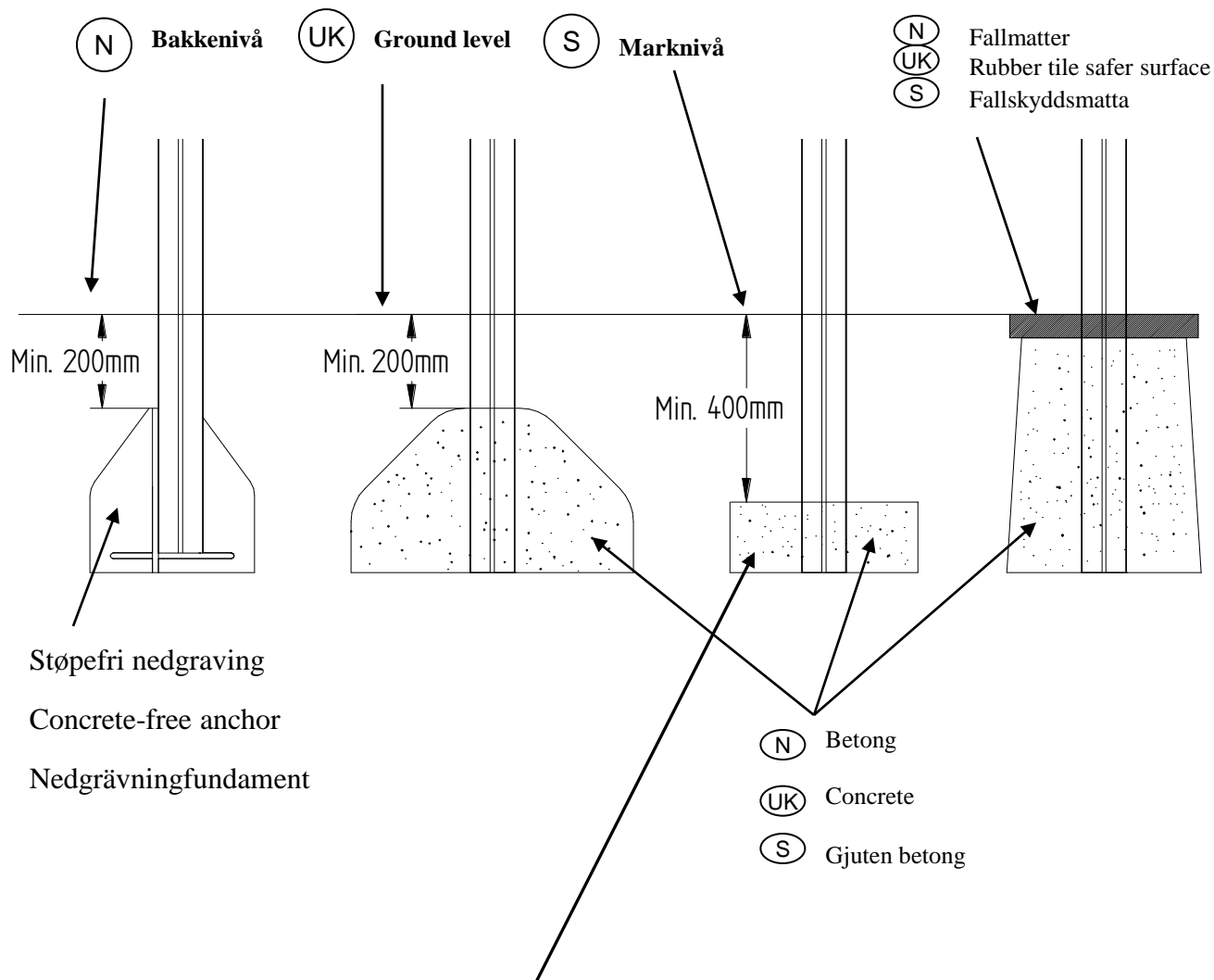

(N) Denne støpemetoden anbefales ikke grunnet dårlig stabilitet av lekeapparatet.

(UK) This anchor is recommend not to use because of poor stability of the play unit.

(S) Denna förankring avrådes från att användas, därför att lekutrustningen får dålig fäste.

1

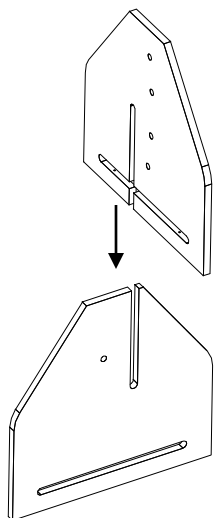

2

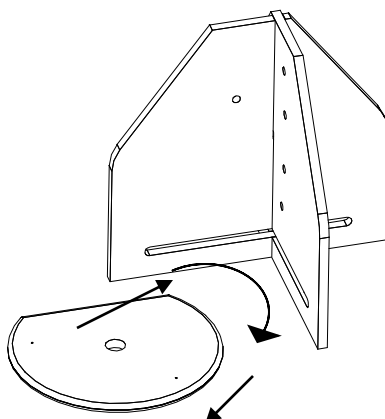

3

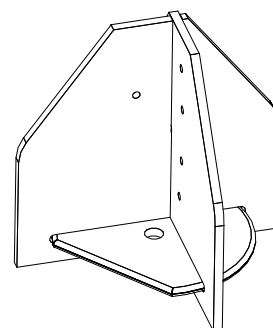

4

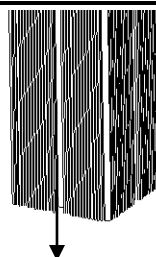

04-060-120 x 2
120 x 15 x 8 mm



04-000-035 x 3
8 x 35 mm Torx

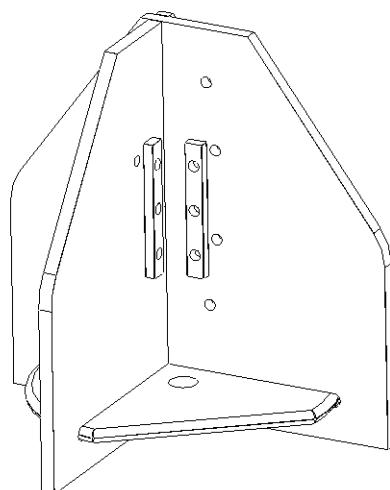

7

Plassering av forankringer / Ground plan / Placering av förankringar

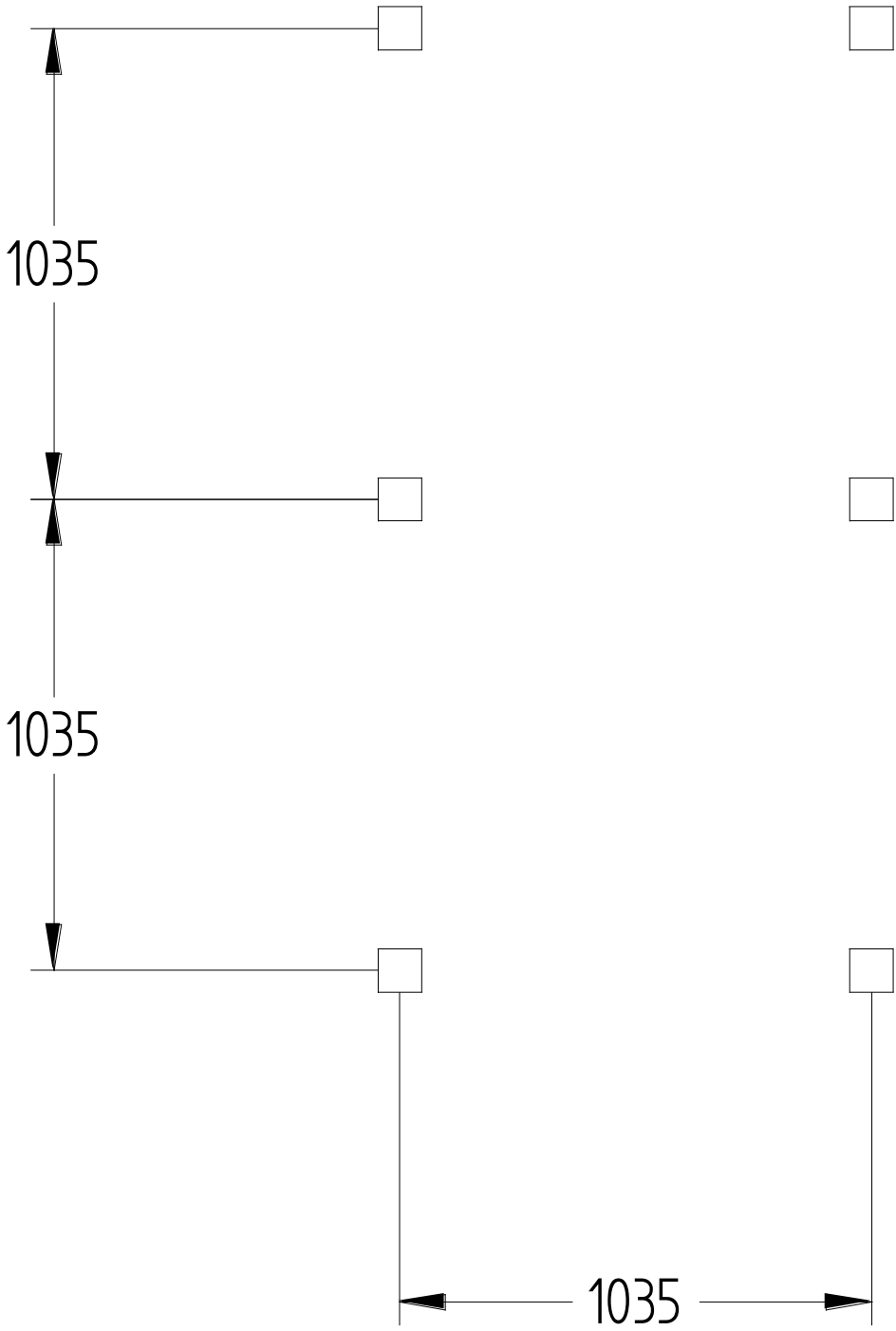

(N)

Alle mål er oppgitt i millimeter

(UK)

Scale measured in mm

(S)

Alla mått är i millimeter.

8

Sikkerhetszone / Safety zone / Säkerhetszon

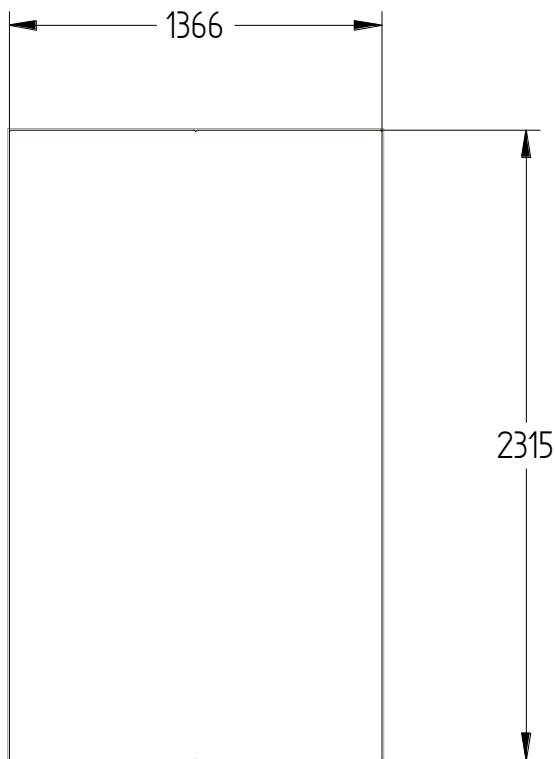

N

Alle mål er oppgitt i millimeter

UK

Scale measured in mm

S

Alla mått är i millimeter.

9

Fallhøyder / Free height of fall / Fallhöjder



N

Alle mål er oppgitt i millimeter

UK

Scale measured in mm

S

Alla mått är i millimeter.

OBS !

- Ⓝ Bolter skrues helt igjennom aluminiumstolpene. Om elektrisk drill brukes anbefales 18 V
- ⓊⓀ Bolts must be tightened through the post, so that it pierces the aluminium.
- Ⓢ Bultarna skruvas rakt igenom aluminiumstolparna. Om elektrisk skruvdragare används rekommenderas 18 V

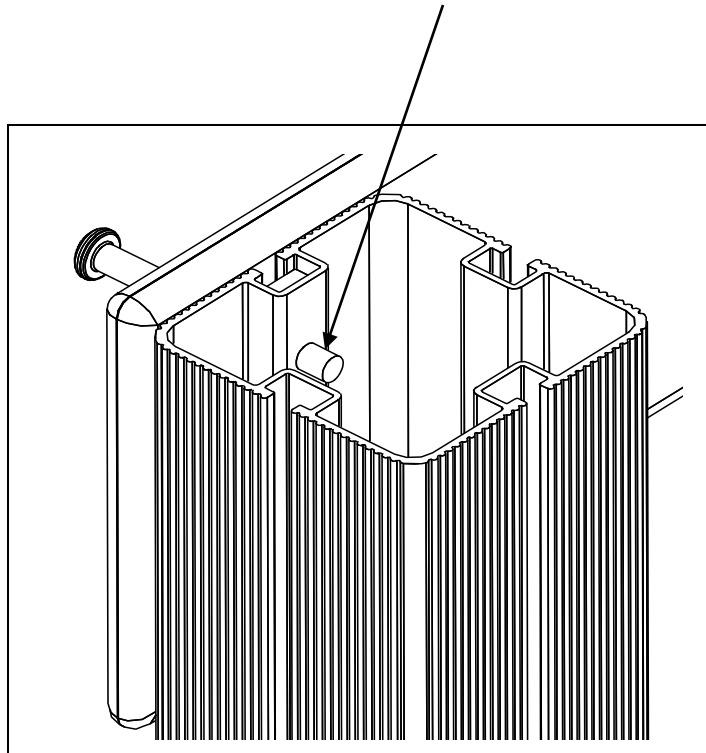

- (N) Uten betong
- (UK) Without concrete
- (S) Utan betong

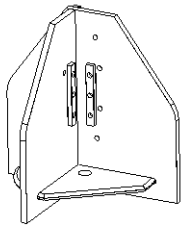

00-003-003

- (N) Med bruk av betong
- (UK) With use of concrete
- (S) Användning av betong

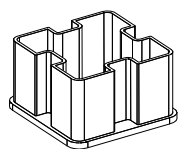
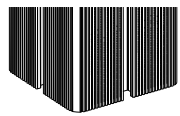

00-400-997

00-400-031 x 6

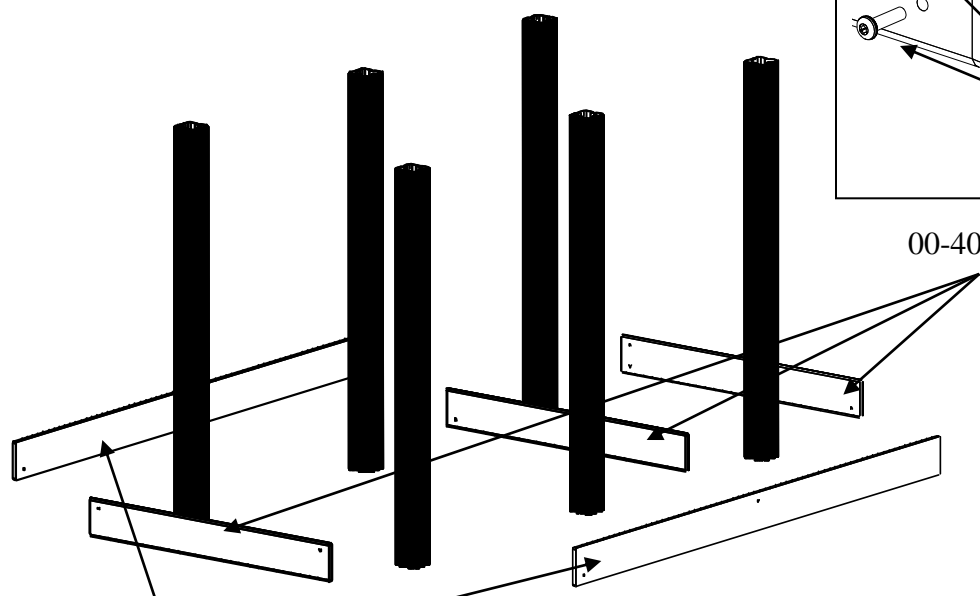
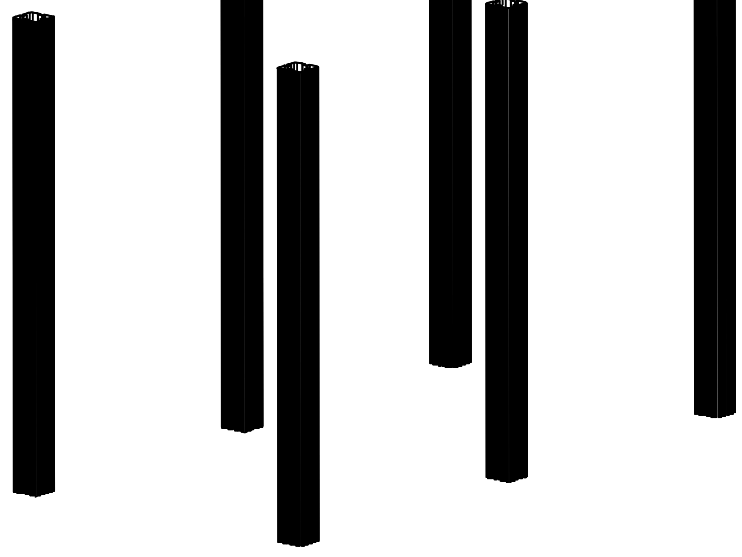

01-400-201

00-400-101

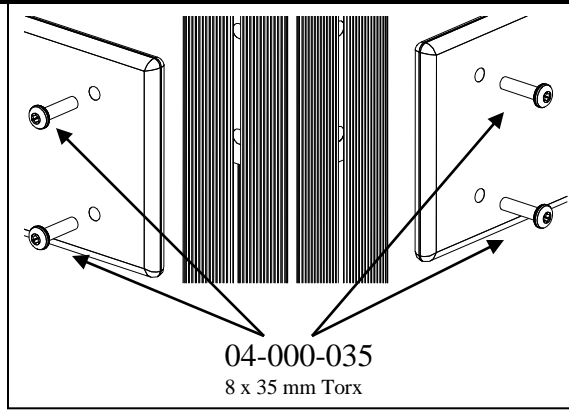

04-000-035
8 x 35 mm Torx

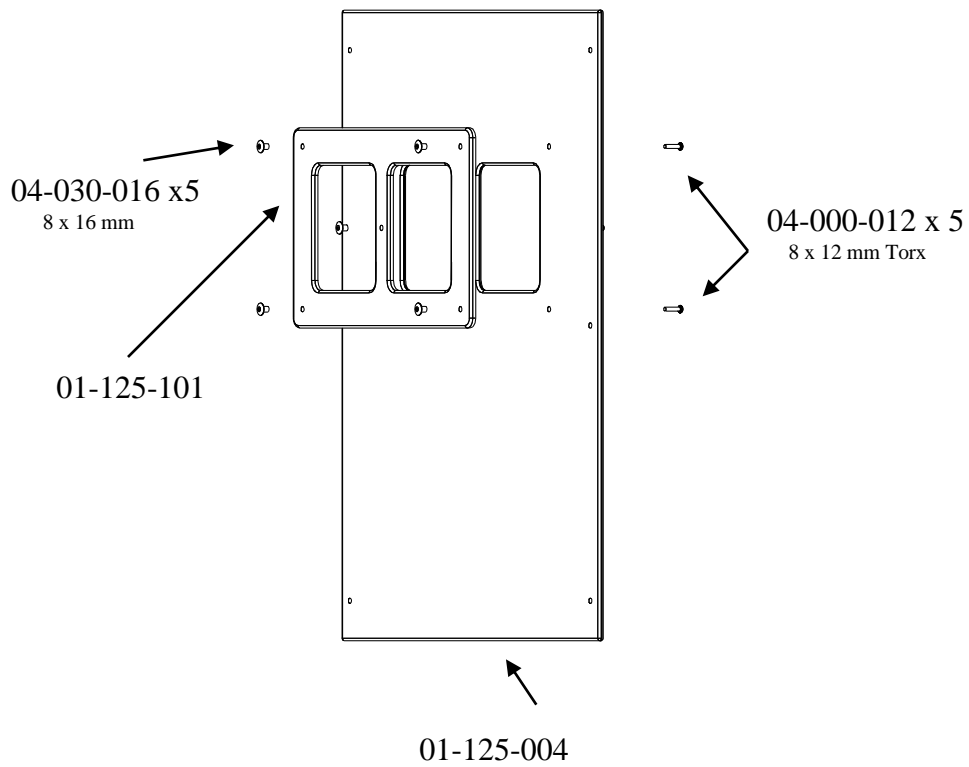

3

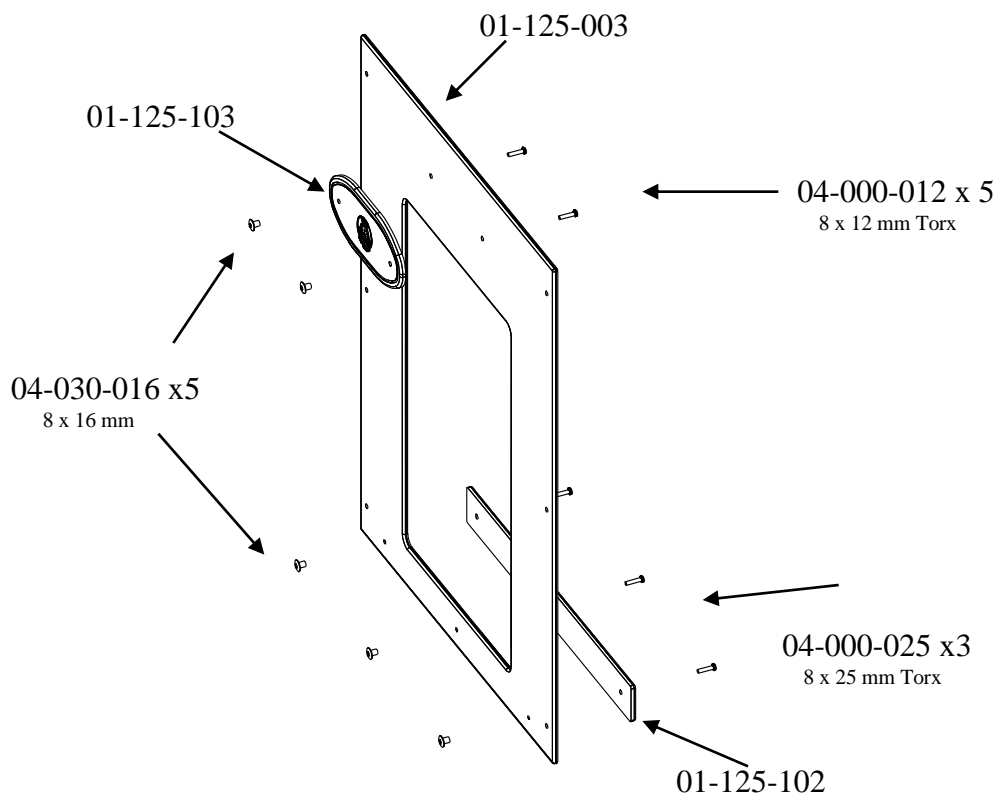

4

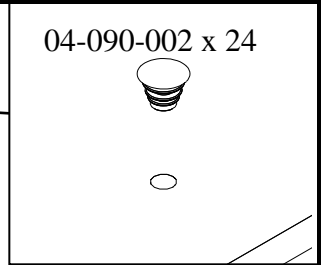
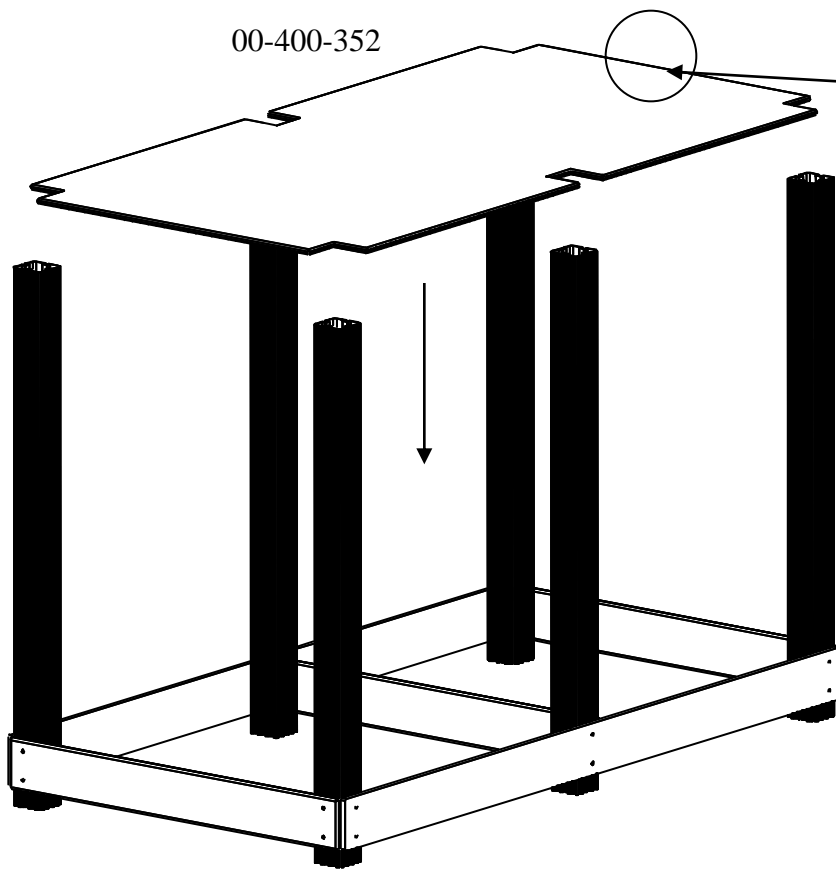

5

01-125-003

01-125-004

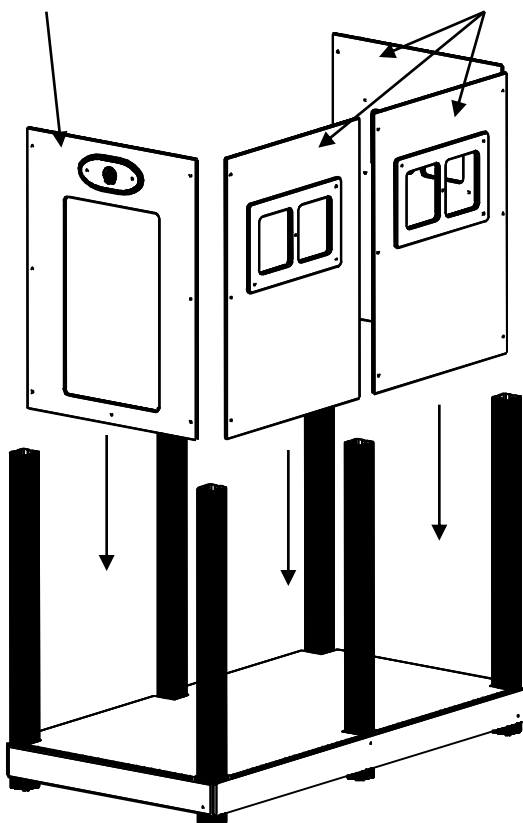

04-060-040
40 x 15 x 8 mm

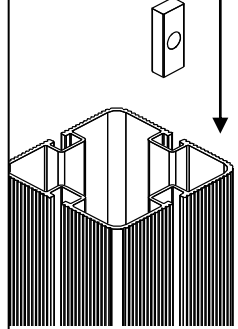

04-000-025
8 x 25 mm Torx

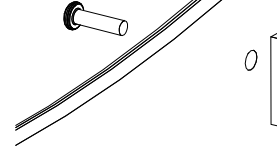

04-076-050
50 x 50 x 5 mm

04-040-008
8 mm

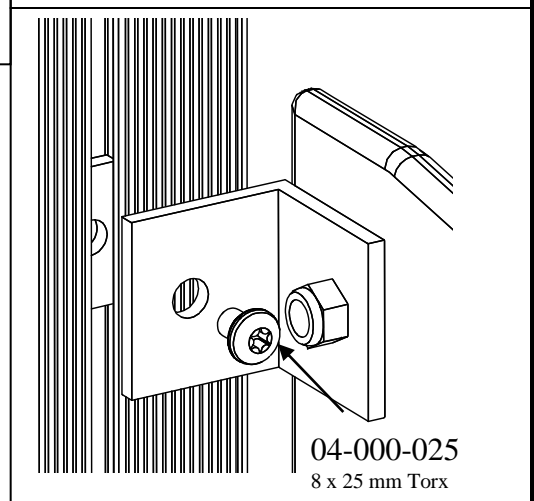
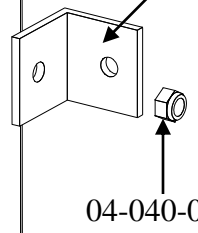

6

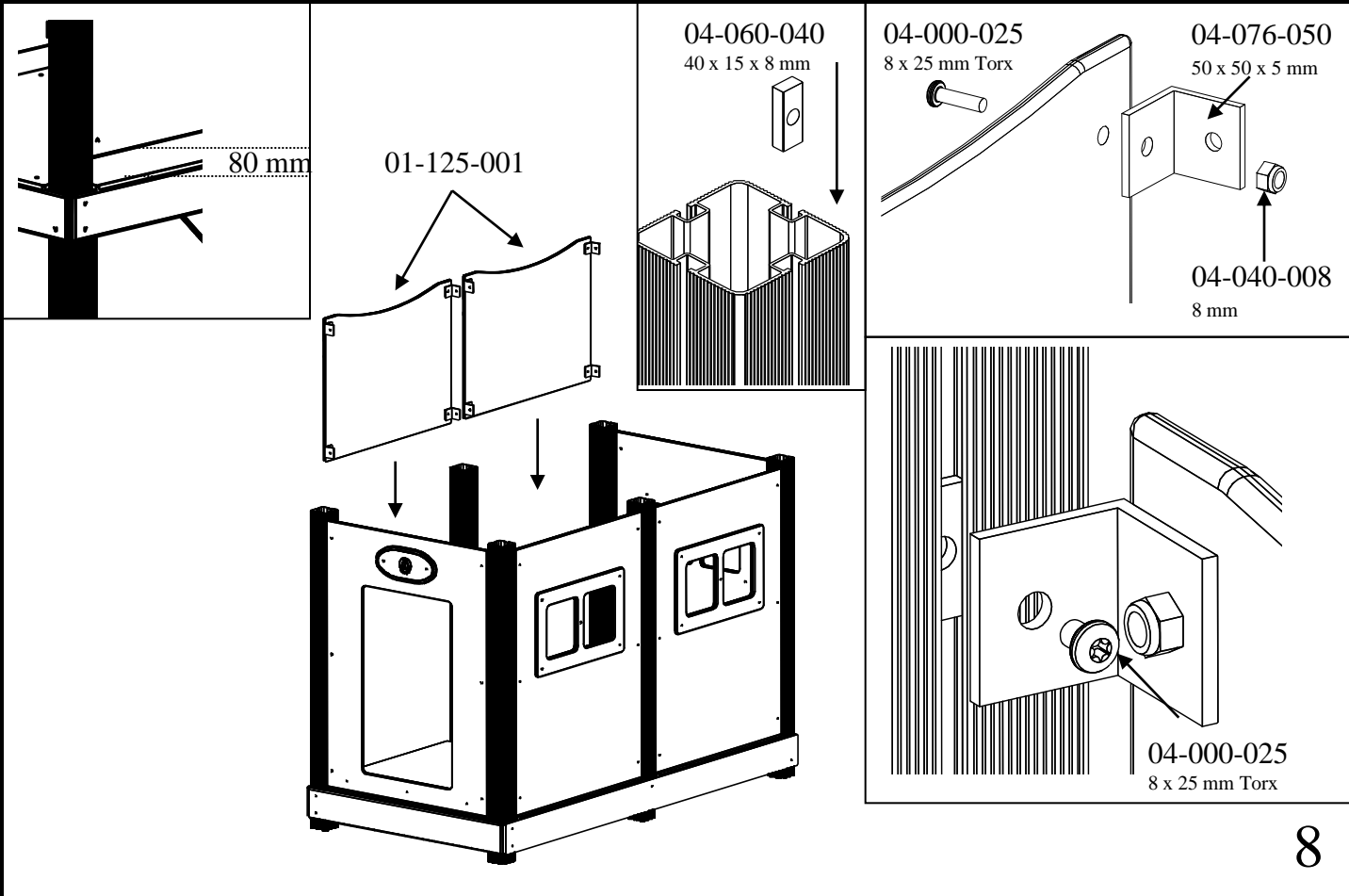
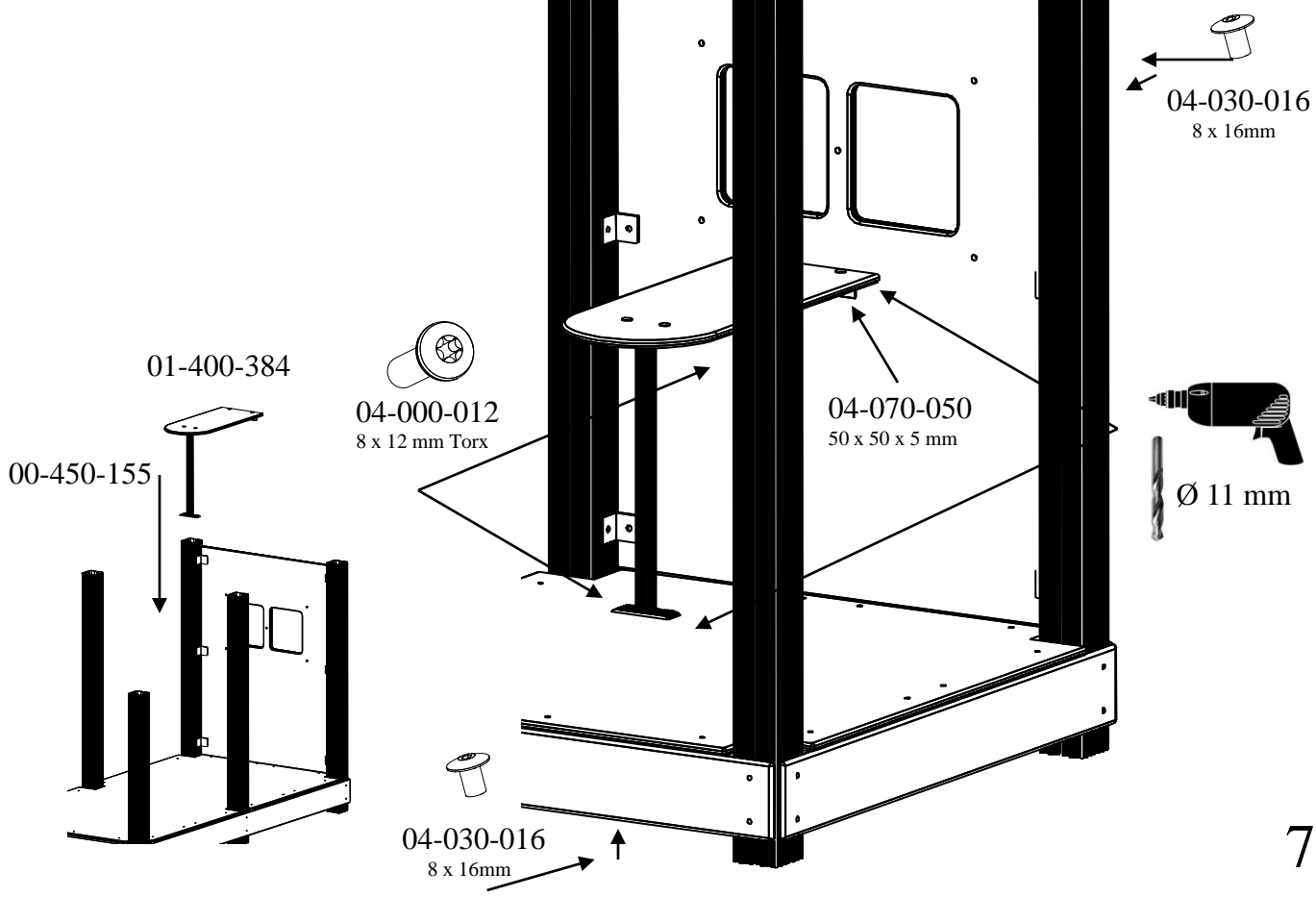

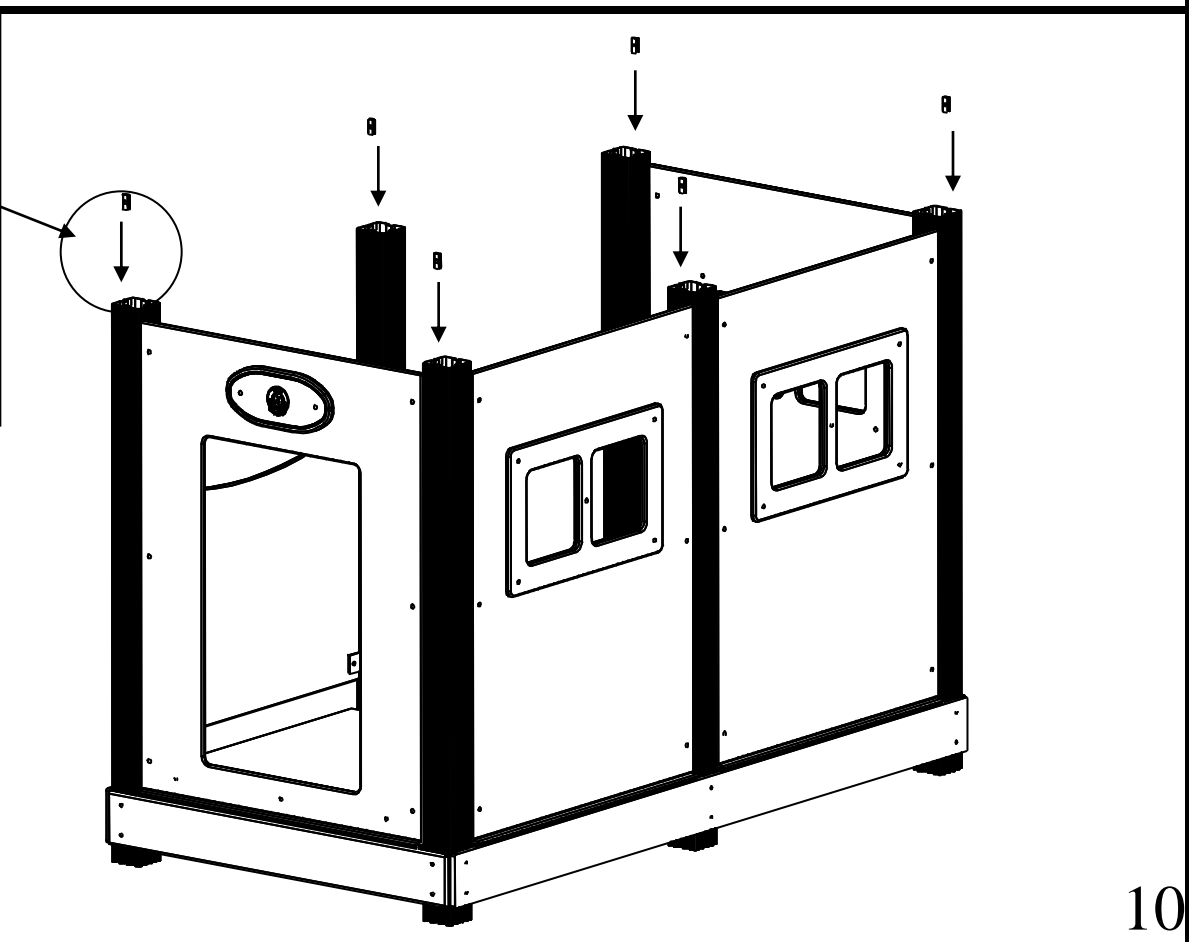
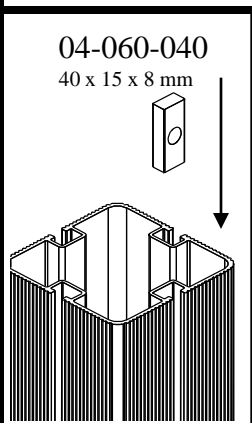
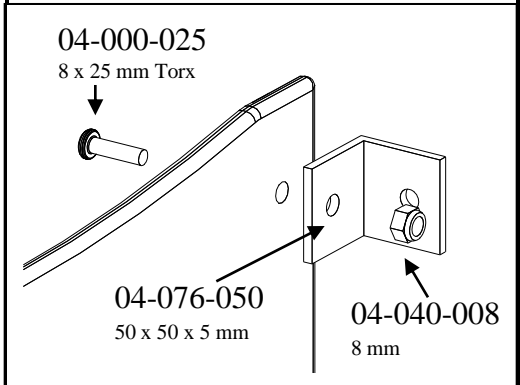
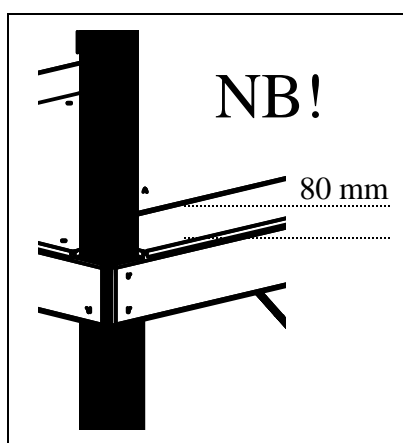
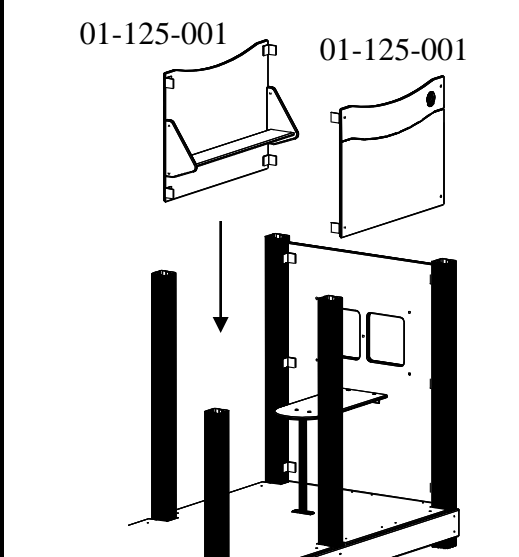
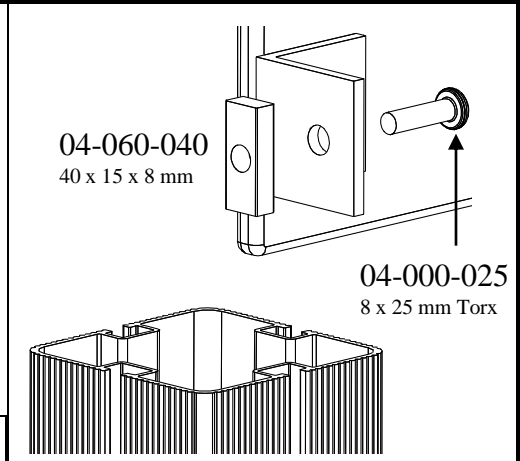
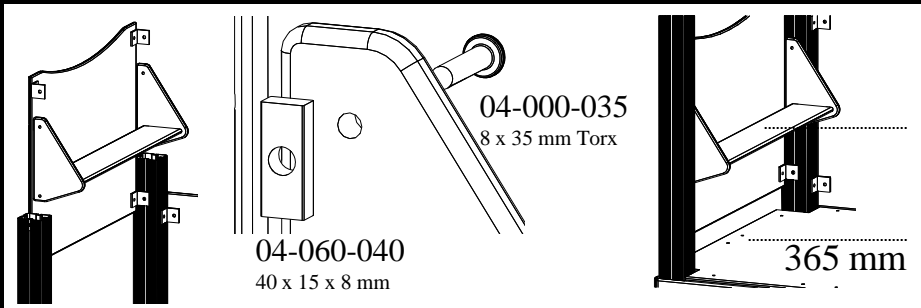

00-400-998 x 6

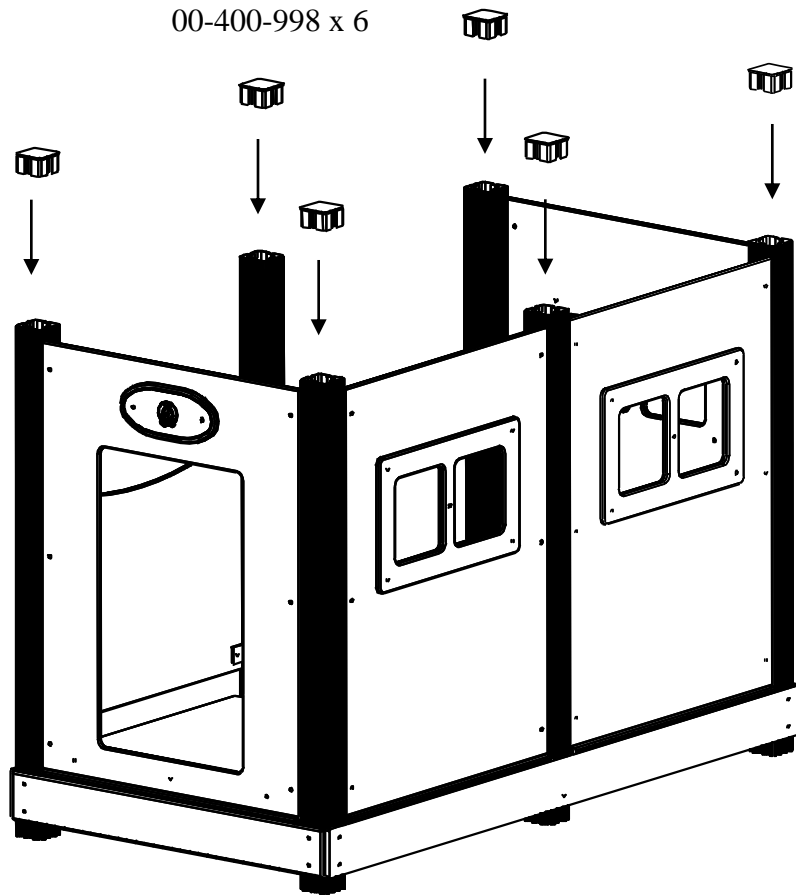

11

- (N) Se neste side for montering av taket
- (UK) See next page for assembly the roof
- (S) Se nesta side för montering av taket

01-128-050

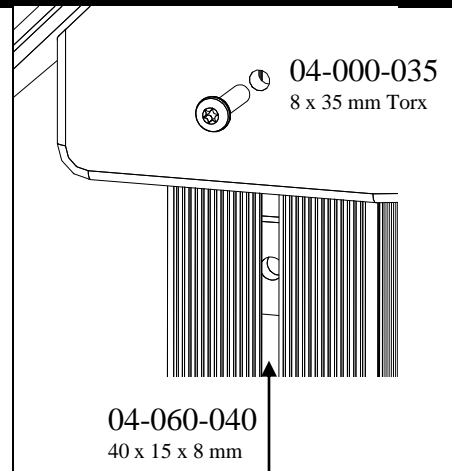
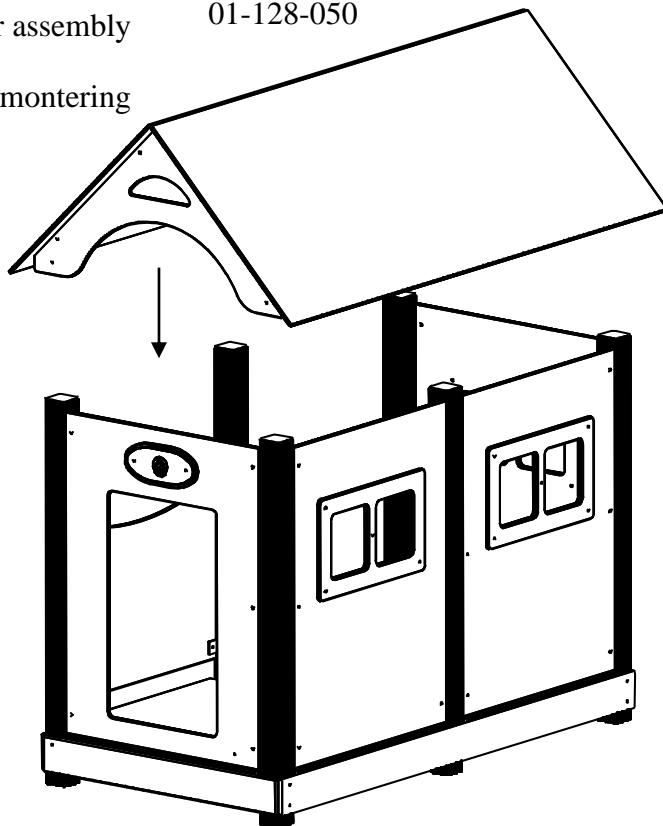

04-000-035
8 x 35 mm Torx

04-060-040
40 x 15 x 8 mm

12

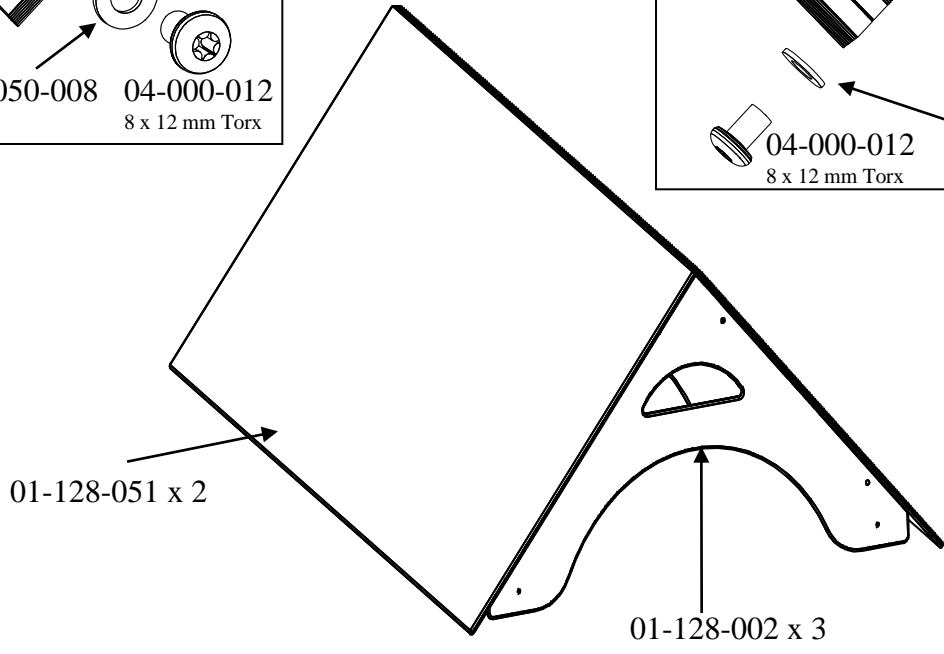
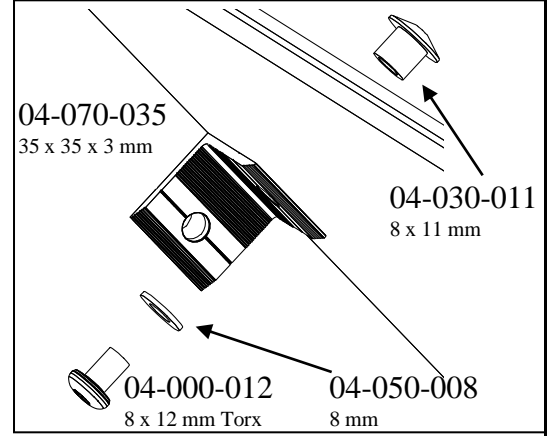
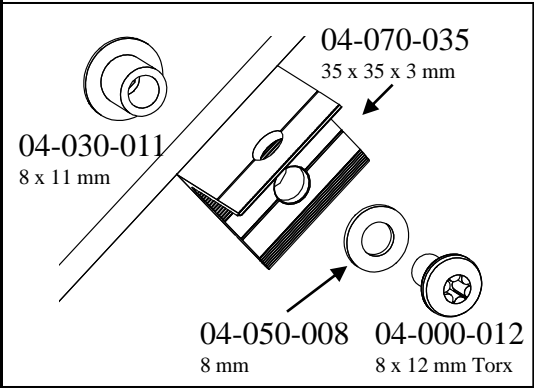

N

- ▣ Påse at fallunderlag er utlagt i henhold til gjeldende regler eller vår anbefaling (se punkt 8)
- ▣ Fjern alle monteringshjelpemidler (rester av betong, planker, paller, plast, og lignende)
- ▣ Før utstyret tas i bruk, burde man sjekke at det ikke er fare for at anorakksnorer og lignende som kan hekte seg fast noen steder på lekeapparatet. (Vedlagte snor med dobbe (kneledd) kan brukes til å sjekke at dette er i orden. Se vedlagte veiledning for bruk av denne. Dette gjøres for å oppdage eventuelle feilmonteringer.?)
- ▣ NB! Bør stå i 2-3 dager før bruk.

UK





- ▣ Make sure the area and depth of safer surfacing are according to the current standard, or to the manufacturer's recommendation
- ▣ Make sure all tools and surplus materials are removed before play begins
- ▣ PS! When complete, allow 2-3 days for the concrete to set before use.

S

- ▣ Kontrollera att fallunderlag är utlagt enligt gällande regler eller vårt rekommendation (se punkt 8)
- ▣ Ta bort alla monteringshjälpmedel (rester av betong, plankor, pallar, plast och liknande)
- ▣ Innan Redskapet tas i bruk, skal man kontrollera att anoracksnoddar eller kläder/delar av kläder eller liknande inte kan fastna i några delar på redskapet. (Den bipackade "knävringen" kan man med fördel användas för denna kontroll. Detta görs för att upptäcka eventuella felmonteringar.)
- ▣ OBS! Bör stå i 2-3 dagar för bruk

5
Pakkliste for / Parts list for / Packlista för :
26-233-025

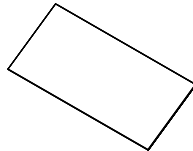
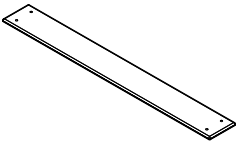
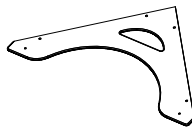
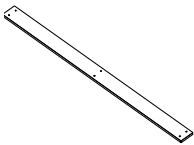
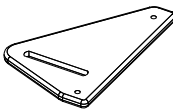
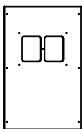
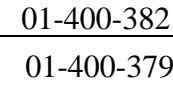
Sign. _____

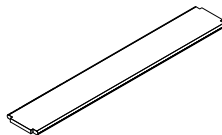
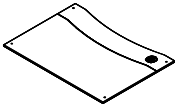
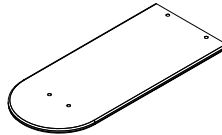
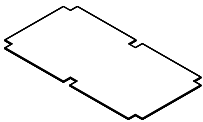
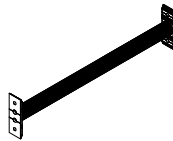
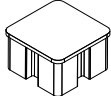
	Komponenter	Dimensjon	Ant	Lev	Komponenter	Dimensjon	Ant	Lev
	Components	Dimension	Qty	Lev	Components	Dimension	Qty	Lev
	Komponenter	Dimension	Ant	Lev	Komponenter	Dimension	Ant	Lev
	00-400-031 	2150 x 95x 95	6		01-128-001 	2315 x 960 x 12	2	
	00-400-101 	1130 x 145 x 15	3		01-128-002 	1216 x 668 x 12	3	
	01-400-201 	2165 x 145 x 15	2		01-400-381 	300 x 194 x 12	1	
	01-125-004 	1240 x 940 x 24	3		01-400-382 	300 x 194 x 12	1	
	01-125-003 	1260 x 940 x 36	1		01-400-379 	930 x 150 x 12	1	
	01-125-001 	940 x 686 x 12	2		01-400-384 	700 x 300 x 15	1	
	00-400-352 	2195 x 1160 x 15	1		00-450-155 	520 x 120 x 40	1	
	00-400-998 	55 x 95 x 95	6					
	00-400-997 Med hull		6					24

5

**Pakkliste for / Parts list for / Packlista för :
26-233-025**

Sign. _____



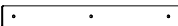
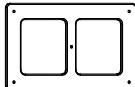

N
UK
S

Komponenter Components Komponenter	Dimensjon Dimension Dimension	Ant Qty Ant	Lev Lev Lev	Bolter/skruer Bolts/Screws Bultar/Skruvar	Dimensjon Dimension Dimension	Ant Qty Ant	Lev Lev Lev
01-125-103 	350 x 160	1					
	800 x 90	1					
01-125-101 	680 x 400	3					



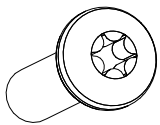
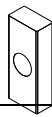







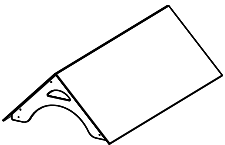

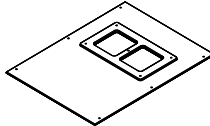











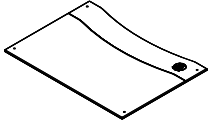

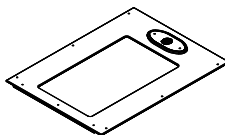
5

Pakkliste for / Parts list for / Packlista för :
26-233-025

Sign. _____

	Bolter/skruer	Dimensjon	Ant	Lev	Bolter/skruer	Dimensjon	Ant	Lev
	Bolts/Screws	Dimension	Qty	Lev	Bultar/Skruvar	Dimension	Qty	Lev
	Komponenter	Dimension	Ant	Lev		Dimension	Ant	Lev
		04-000-012 8 x 12 mm Torx	8			04-060-040 50 x 15 x 8 mm	4	
		04-000-035 8 x 35 mm Torx	24					
		04-090-002	24		(N) Produkt merking (UK) Product marking (S) Produkt märkning		1	
		04-030-016 8 x 16 mm	8					
		04-070-050 50 x 50 x 5 mm	2		Monteringsanvisning Assembly Instructions		1	
					Monteringsanvisning			

Boltepakker for / Boltpackage for / Bultpaket för 26-233-025

01-128-050  Antall Number Antal <input type="checkbox"/>		04-060-040 50 x 15 x 8 mm	6		01-125-004  Antall Number Antal <input type="checkbox"/>		04-060-040 50 x 15 x 8 mm	6	X 3
		04-000-012 8 x 12 mm Torx	32				04-000-025 8 x 25 mm Torx	12	X 3
		04-000-035 8 x 35 mm Torx	6				04-000-012 8 x 12 mm Torx	5	X 3
		04-070-035 35 x 35 x 3 mm	16				04-076-050 50 x 50 x 5 mm	6	X 3
		04-030-011 8 x 11 mm	32				04-030-016 8 x 16 mm	5	X 3
		04-050-008 8 mm	32				04-040-008 8 mm	6	X 3
01-125-001  Antall Number Antal <input type="checkbox"/>		04-060-040 50 x 15 x 8 mm	4	X 2	01-125-003  Antall Number Antal <input type="checkbox"/>		04-060-040 50 x 15 x 8 mm	6	
		04-000-025 8 x 25 mm Torx	8	X 2			04-000-025 8 x 25 mm Torx	15	
		04-076-050 50 x 50 x 5 mm	4	X 2			04-000-012 8 x 12 mm Torx	2	
		04-040-008 8 mm	4	X 2			04-030-016 8 x 16 mm	5	
						04-076-050 50 x 50 x 5 mm	6		
						04-040-008 8 mm	6		

5 Pakkliste for / Parts list for / Packlista för :
26-233-025

Sign. _____

Forankring / Foundations / Markförankring

00-003-003

N Er bestilt Ikke bestilt
 UK In order Not in order
 S Beställt Ej beställt

00-400-997

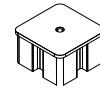

-6

00-003-100 00-003-101 00-003-102	6	04-000-035 8 x 35 mm Torx 04-050-008 8 mm 04-060-120 120 x 15 x 8 mm	18	18	12						
						00-003-103 	0	04-000-040 8 x 40 mm Torx 04-040-008 8 mm 04-050-008 8 mm	0	0	0
Eller Or Eller											