

**(N) Monteringsanvisning**

**(UK) Assembly Instructions**

**(S) Monteringsanvisning**

Produkt nr. / Product no. / Produkt nr.

**26-233-050**

Ordr. nr. \_\_\_\_\_

Dato. \_\_\_\_\_

Sign. \_\_\_\_\_

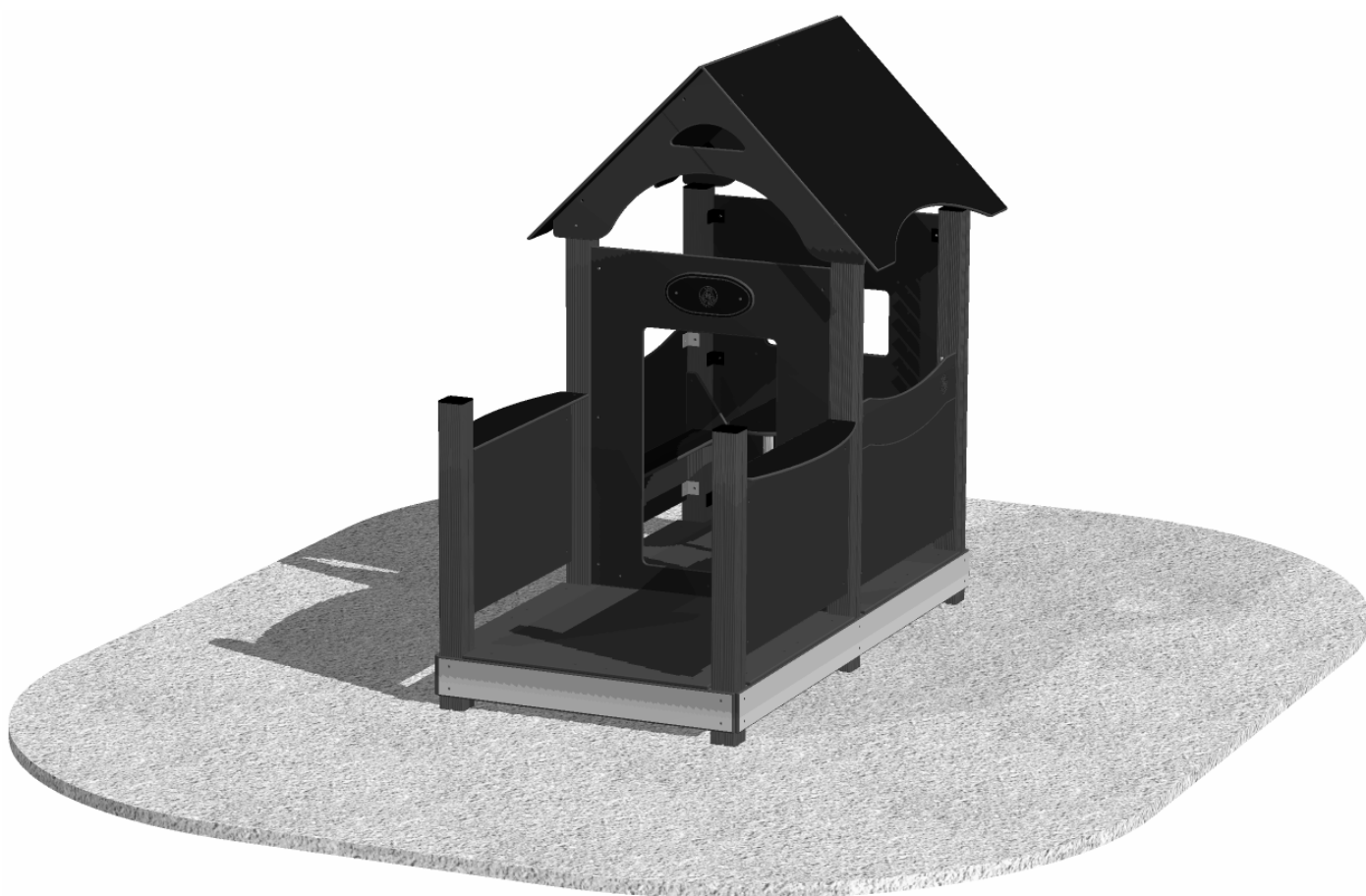

**Søve Lekemiljø AS**  
3830 Ulefoss - Norway  
Tlf: +47 35 94 65 65  
[www.sove.no](http://www.sove.no)



**Søve AB**  
412 50 Göteborg  
Phone: +46 (0)31 773 97 00  
[www.sove.se](http://www.sove.se)

22.02.2010

**1****Monteringstips / Assembly Advice / Monteringstips****N**

- ▣ Les monteringsanvisningen nøye før montering.
- ▣ Monter elementene i den rekkefølge som vist.
- ▣ Boltene bør ikke skrues for hardt til før alt er montert, vatret og loddet.  
Skru så boltene til. NB! Ved bruk av drill, kan boltene ryke.
- ▣ På grunn av at solen kan gjøre rutsjebanen veldig varm, bør banens utløp vendes mot nord-øst eller nord-vest.
- ▣ Er lekeutstyret plassert i naturlige ferdselstraseer må området sikres mot spontan gjennomgang.
- ▣ Innspringningshinder bør vurderes rundt lekeapparater hvor det er stor bevegelse, f.eks. huskestativ.
- ▣ Det bør være fritt innsyn til lekeutstyr som er beregnet for barn under 36 mnd.

**NB! Under monteringsarbeidet må utstyret som ikke er forankret forsvarlig i bakken avstives slik at det ikke kan velte som følge av vind og lignende, eller ukontrollert bruk. Området må avstenges under oppsettelse av apparatene med sperrebånd og lignende.**

**UK**











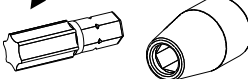

- ▣ Read the instruction carefully before assembling the play unit.
- ▣ Assemble the components in the sequence shown in these instructions.
- ▣ Fixings must not be fully tightened during assembly. Before casting the foundations, the structure must be level and plumb, at which point all fixings are tightened. PS! If use of drill, the bolts will be wrecked.
- ▣ Avoid positioning the slide facing due south because of overheating – ideal positions are facing north-east or north-west.
- ▣ Secure the construction area to prevent people from walking through it.
- ▣ Consider installing barriers around play equipment which gives rise to a lot of activity – i.e. swings.
- ▣ Ensure that clear vision is possible across the play area so that supervision is possible from any position, particularly where children under 3 years of age will be playing.

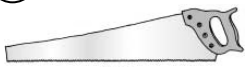
**NB! During assembly of the equipment, ensure that all structures are securely propped, especially when left overnight. Also ensure that equipment is supported whilst concrete foundations are setting and enclose the area securely to prevent access.**

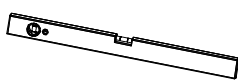
S

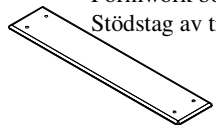
- ▣ Läs monteringsanvisningen noga före montering.
- ▣ Montera delarna i den ordningen som anvisas
- ▣ Skruvarna bör inte skruvas för hårt tills allt är monterat, i våg och lodat. OBS! Vid användning av elektisk skruvdragare, kan bulten gå sönder.
- ▣ Solen kan göra att rutchbanan blir väldigt varm. Banans nedfart bör vändas mot norr.
- ▣ Om lekplatsen placeras vid en gångväg mm bör området säkras mot genomfart av gående och cyklister.
- ▣ Inspringningshinder bör placeras runt lekutrustningen ifall det är utrustning som är, t ex, gungställning.
- ▣ Det bör vara fri insyn till lekutrustningen som är beräknat till barn under 36 månader.

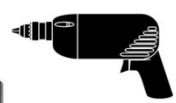
**OBS! Under monteringsarbete bör utrustningen som inte ska förankras i marken ställas så att det inte kan välta av vind eller liknande.  
Området måste spärras när lekutrustningen byggs upp, med avspärrningsband eller liknande.**



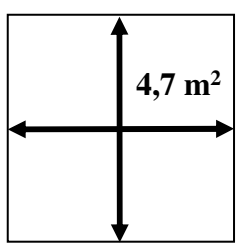

<p><b>2</b></p> <p>N U K S</p>	<p><b>Nødvendig verktøy / Tools required / Nödvändiga verktyg</b></p>			
<p><b>A</b></p> 	<p><b>B</b></p>  <p>Torx Nr 45 High quality</p> 		<p><b>D</b></p> 	<p><b>E</b></p>  <p><b>F</b></p> 
<p><b>G</b></p>  <p><b>H</b></p> <p>Metermål Metric measure Tumstock</p> 	<p><b>I</b></p> <p>Forskalingsbord Formwork boards Stödstag av trä</p>  <p><b>J</b></p> 	<p><b>L</b></p> <p>Merkebånd Mark ribbon Märkeband</p> 		<p><b>M</b></p>   <p>Ø 11 mm</p>

<p><b>3</b></p> <p>N U K S</p>	<p><b>Nødvendig antall personer / Number of persons required / Lämpligt antal personer</b></p>			
				

<p><b>4</b></p> <p>N U K S</p>	<p><b>Anbefalt arealbehov ved montering / Recommended working space / Rekommenderad arealbehov vid montering</b></p>			
				

**5**
**Pakkliste for / Parts list for / Packlista för :  
 26-233-050**

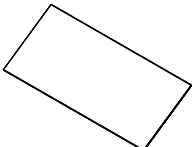

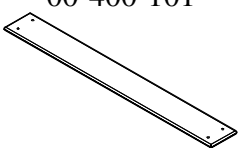
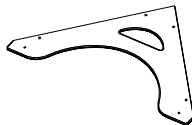
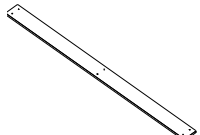
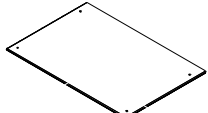
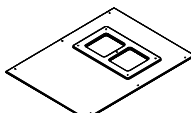
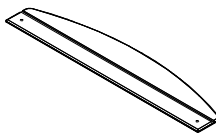
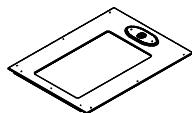
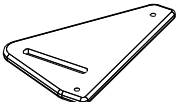
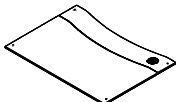
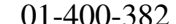
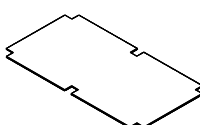
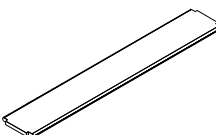
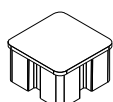
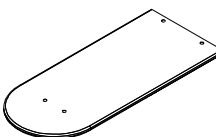
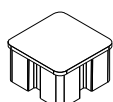
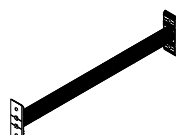





Sign. \_\_\_\_\_

	Komponenter	Dimensjon	Ant	Lev	Komponenter	Dimensjon	Ant	Lev
	Components	Dimension	Qty	Lev	Components	Dimension	Qty	Lev
	Komponenter	Dimension	Ant	Lev	Komponenter	Dimension	Ant	Lev
	00-400-031 	2150 x 95x 95	4		01-128-001 	2315 x 960 x 12	2	
	00-400-034 	1610 x 95x 95	2					
	00-400-101 	1130 x 145 x 15	3		01-128-002 	1216 x 668 x 12	3	
	01-400-201 	2165 x 145 x 15	2		01-125-013 	940 x 630 x 12	2	
	01-125-004 	1240 x 940 x 24	1		01-125-014 	940 x 195 x 12	2	
	01-125-003 	1260 x 940 x 36	1		01-400-381 	300 x 194 x 12	1	
	01-125-001 	940 x 686 x 12	2		01-400-382 		1	
	00-400-352 	2195 x 1160 x 15	1		01-400-379 	930 x 150 x 12	1	
	00-400-998 	55 x 95 x 95	6		01-400-384 	700 x 300 x 15	1	
	00-400-997 	Med hull	6		00-450-155 	520 x 120 x 40 <sup>5</sup>	1	

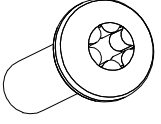
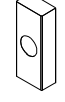
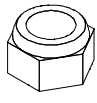











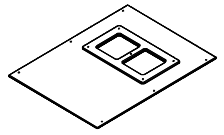







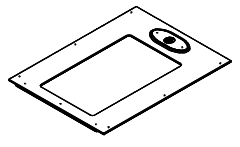

**5**

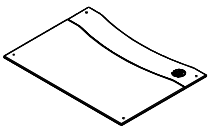
**Pakkliste for / Parts list for / Packlista för :  
26-233-050**

Sign. \_\_\_\_\_

  	<b>Bolter/skruer</b>	<b>Dimensjon</b>	<b>Ant</b>	<b>Lev</b>	<b>Bolter/skruer</b>	<b>Dimensjon</b>	<b>Ant</b>	<b>Lev</b>
	<b>Bolts/Screws</b>	<b>Dimension</b>	<b>Qty</b>	<b>Ant</b>	<b>Bultar/Skruvar</b>	<b>Dimension</b>	<b>Ant</b>	<b>Lev</b>
	04-000-012 8 x 12 mm Torx	<b>6</b>			04-060-040 40 x 15 x 8 mm	<b>16</b>		
	04-000-025 8 x 25 mm Torx	<b>12</b>				04-040-008 8 mm	<b>12</b>	
	04-000-035 8 x 35 mm Torx	<b>28</b>						
04-090-002	<b>24</b>							
04-076-050 50 x 50 x 5 mm	<b>12</b>							
04-070-050 50 x 50 x 5 mm	<b>2</b>							
	04-030-016 8 x 16 mm	<b>6</b>						
					 Produkt merking  Product marking  Produkt märkning		<b>1</b>	

**Boltepakker for / Boltpackage for / Bultpaket för 26-233-050**

01-128-000    Antall Number Antal <input type="text"/>	 04-060-040 40 x 15 x 8 mm <b>4</b>	01-125-004    Antall Number Antal <input type="text"/>	 04-060-040 40 x 15 x 8 mm <b>6</b>	
	 04-000-012 8 x 12 mm Torx <b>22</b>		 04-000-025 8 x 25 mm Torx <b>12</b>	
	 04-000-035 8 x 35 mm Torx <b>4</b>		 04-076-050 50 x 50 x 5 mm <b>6</b>	
	 04-070-035 35 x 35 x 3 mm <b>11</b>		 04-040-008 8 mm <b>6</b>	
	 04-030-011 8 x 11 mm <b>22</b>		01-125-003    Antall Number Antal <input type="text"/>	 04-060-040 40 x 15 x 8 mm <b>6</b>
	 04-050-008 8 mm <b>22</b>			 04-000-025 8 x 25 mm Torx <b>12</b>
01-125-001    Antall Number Antal <input type="text"/>	 04-060-040 40 x 15 x 8 mm <b>4</b> X 2	Antall Number Antal <input type="text"/>	 04-000-025 8 x 25 mm Torx <b>12</b>	
	 04-000-025 8 x 25 mm Torx <b>8</b> X 2		 04-076-050 50 x 50 x 5 mm <b>6</b>	
	 04-076-050 50 x 50 x 5 mm <b>4</b> X 2		 04-040-008 8 mm <b>6</b>	
	 04-040-008 8 mm <b>4</b> X 2			
		Monteringsanvisning Assembly Instructions Monteringsanvisning	<b>1</b>	
			<b>6</b>	

**5**

**Pakkliste for / Parts list for / Packlista för :**  
**26-233-050**

3 av 3

Sign. \_\_\_\_\_

### Forankring / Foundations / Markförankring

### 00-003-003

**N** Er bestilt       Ikke bestilt  
 **UK** In order       Not in order  
 **S** Bestållt       Ej bestållt

00-400-997

**-6**

00-003-100 00-003-101 00-003-102	<b>6</b>			04-000-035 8 x 35 mm Torx	<b>18</b>	
				04-050-008 8 mm	<b>18</b>	
				04-060-120 120 x 15 x 8 mm	<b>12</b>	
00-003-103 	<b>0</b>			04-000-040 8 x 40 mm Torx	<b>0</b>	
				04-040-008 8 mm	<b>0</b>	
				04-050-008 8 mm	<b>0</b>	
Eller Or Eller 00-003-105  00-003-106 	<b>0</b>			04-010-035 10 x 35 mm	<b>0</b>	
				04-040-010 10 mm	<b>0</b>	
				04-050-010 10 mm	<b>0</b>	

# 6

## Fundamentering / Foundation / Förankring



- (N) Bakkenivå
- (UK) Ground level
- (S) Marknivå

- (N) For stolper
- (UK) For posts
- (S) För stulpar

- (N) Støtsand
- (UK) Safer surface
- (S) Stridsand

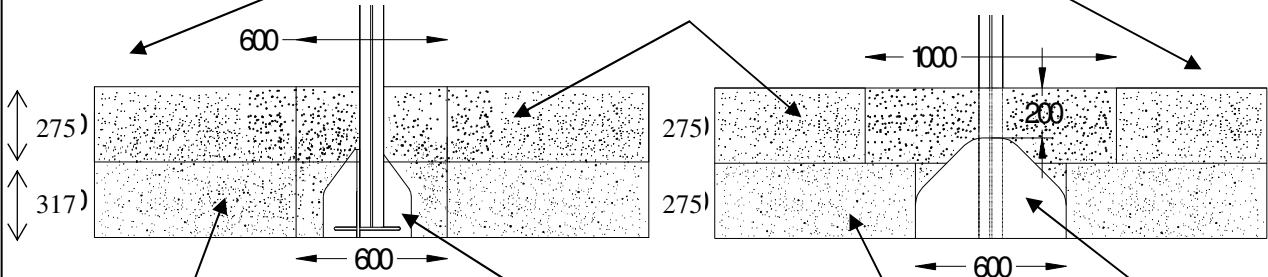

- (N) Komprimert masse
  - (UK) Compressed mass
  - (S) Komprimerad masse
- Støpefri nedgraving  
Concrete-free anchor  
Nedgrävningfundament

- (N) Komprimert masse.
  - (UK) Compressed mass.
  - (S) Komprimerad masse.
- betong  
concrete  
betong

- (N) Alle mål er oppgitt i millimeter
- (UK) Scale measured in mm
- (S) Alla mått är i millimeter.



7

Plassering av forankringer / Ground plan / Placering av förankringar

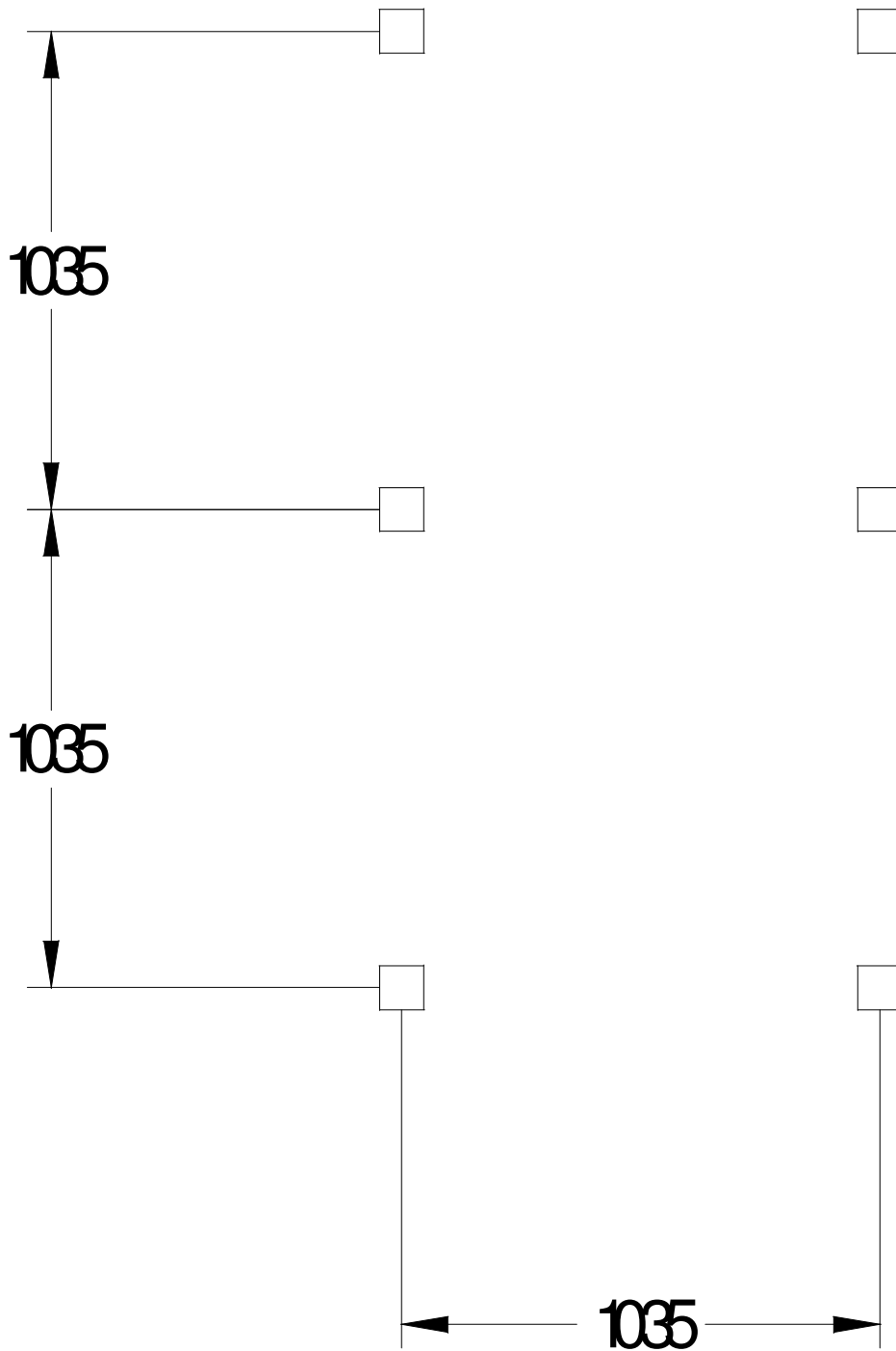

- (N) Alle mål er oppgitt i millimeter
- (UK) Scale measured in mm
- (S) Alla mått är i millimeter.

8

### Sikkerhetszone / Safety zone / Säkerhetszon

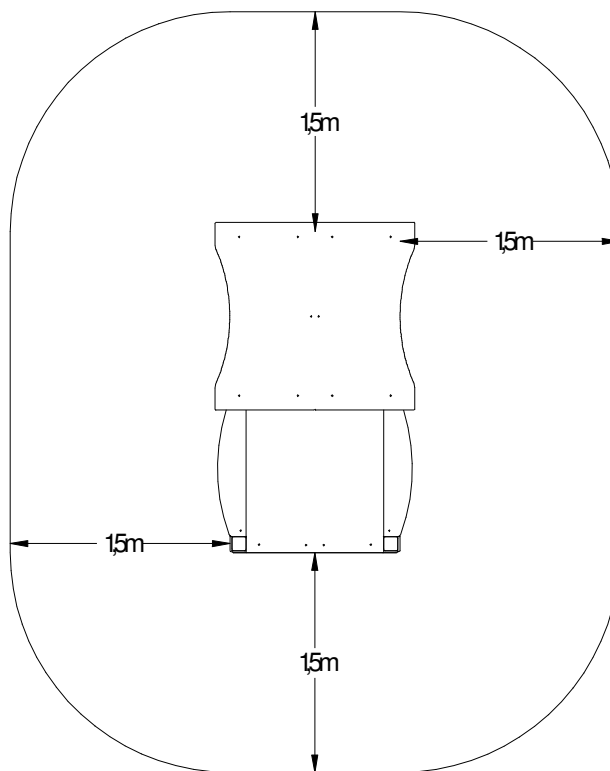

(N)

Alle mål er oppgitt i millimeter

(UK)

Scale measured in mm

(S)

Alla mått är i millimeter.

9

### Fallhøyder / Free height of fall / Fallhöjder

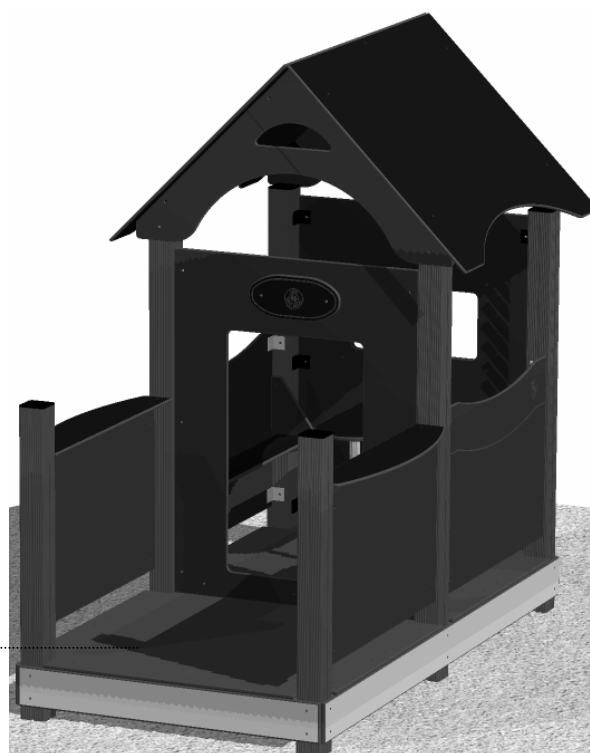

(N)

Alle mål er oppgitt i millimeter

(UK)

Scale measured in mm

(S)

Alla mått är i millimeter.

210

**OBS !**

- Ⓝ Bolter skrues helt igjennom aluminiumstolpene. Om elektrisk drill brukes anbefales 18 V
- Ⓚ Bolts must be tightened through the post, so that it pierces the aluminium.
- Ⓢ Bultarna skruvas rakt igenom aluminiumstolparna. Om elektrisk skruvdragare används rekommenderas 18 V

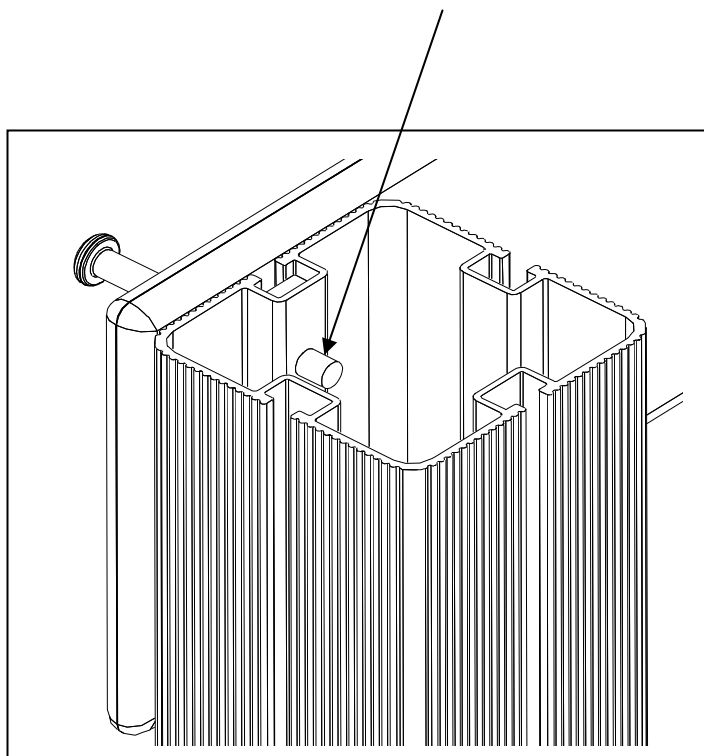

# 10

## Montering av lekeapparatet / Assembly instructions / Montering av lekredskapet

- (N) Uten betong
- (UK) Without concrete
- (S) Utan betong

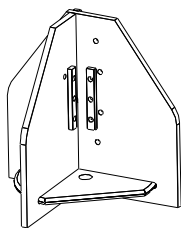

00-003-003

- (N) Med bruk av betong
- (UK) With use of concrete
- (S) Användning av betong

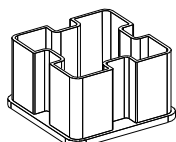
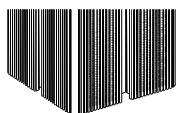

00-400-997

00-400-031 x 4

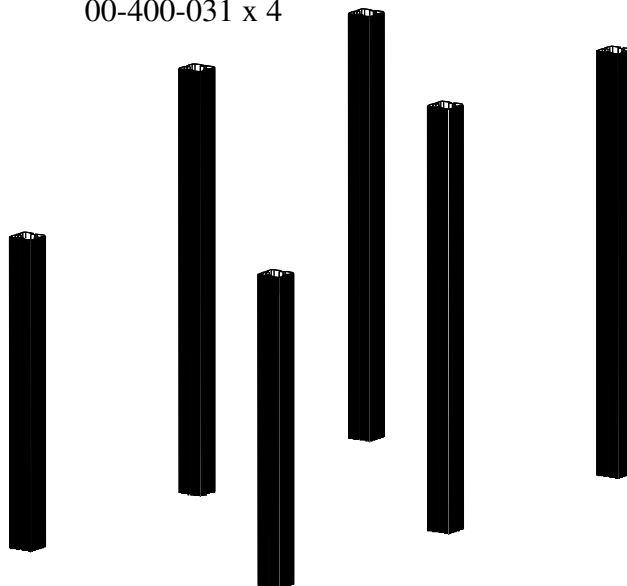

00-400-034 x 2

1

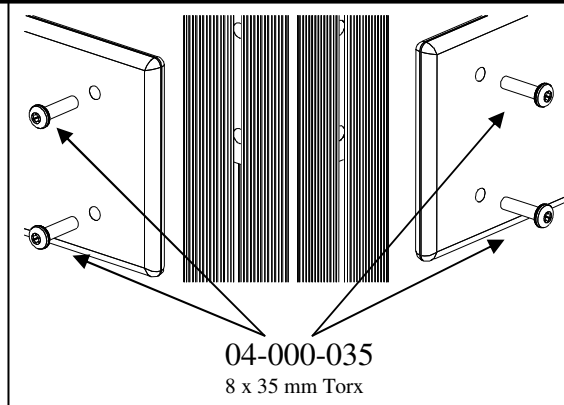

04-000-035  
8 x 35 mm Torx

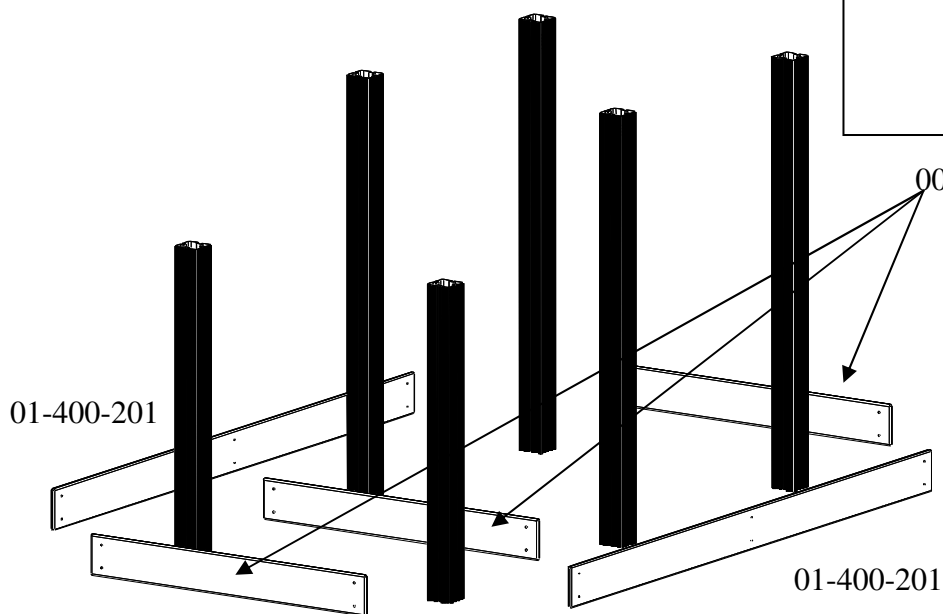

01-400-201

00-400-101

01-400-201

2

00-400-352

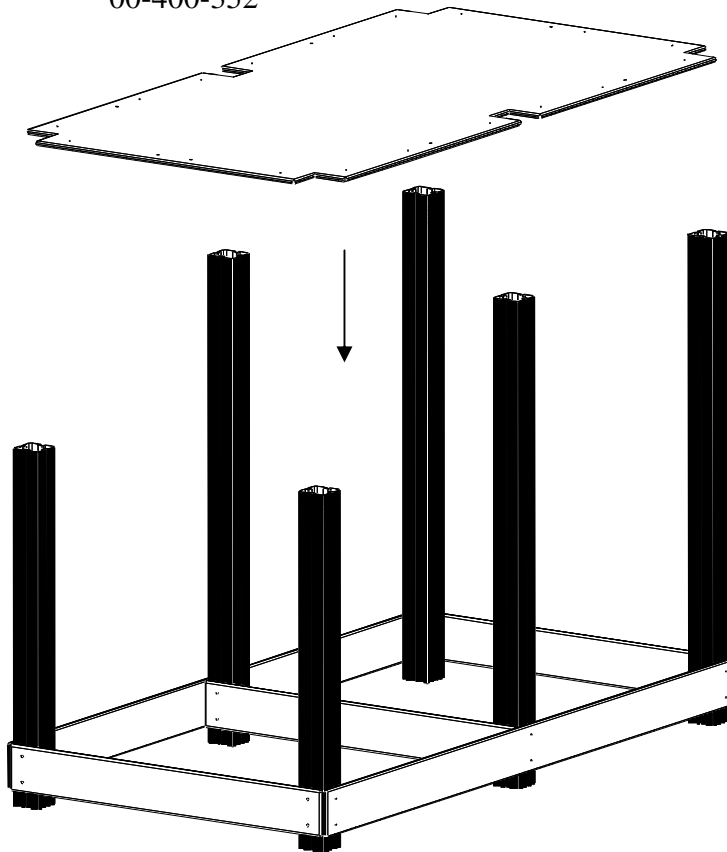

- (N) Gulvet festes ikke med vinkler
- (UK) The floor is not connected at points
- (S) Golvet fästes inte med vinklar

3

01-125-004

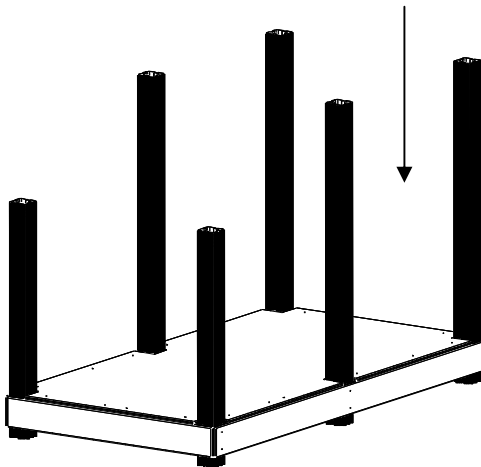
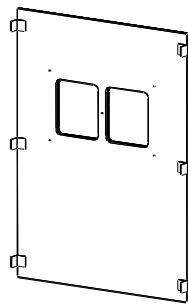

04-060-040  
40 x 15 x 8 mm

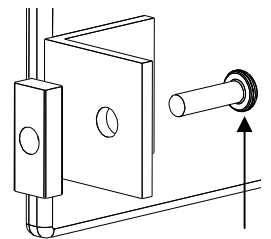

04-000-025  
8 x 25 mm Torx

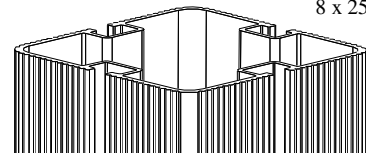

04-000-025  
8 x 25 mm Torx

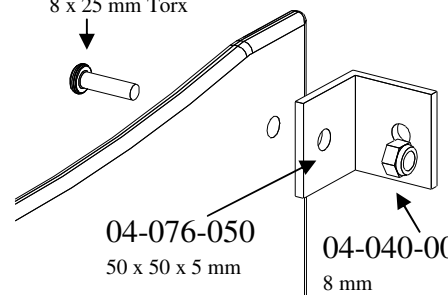

04-076-050  
50 x 50 x 5 mm

04-040-008  
8 mm

4

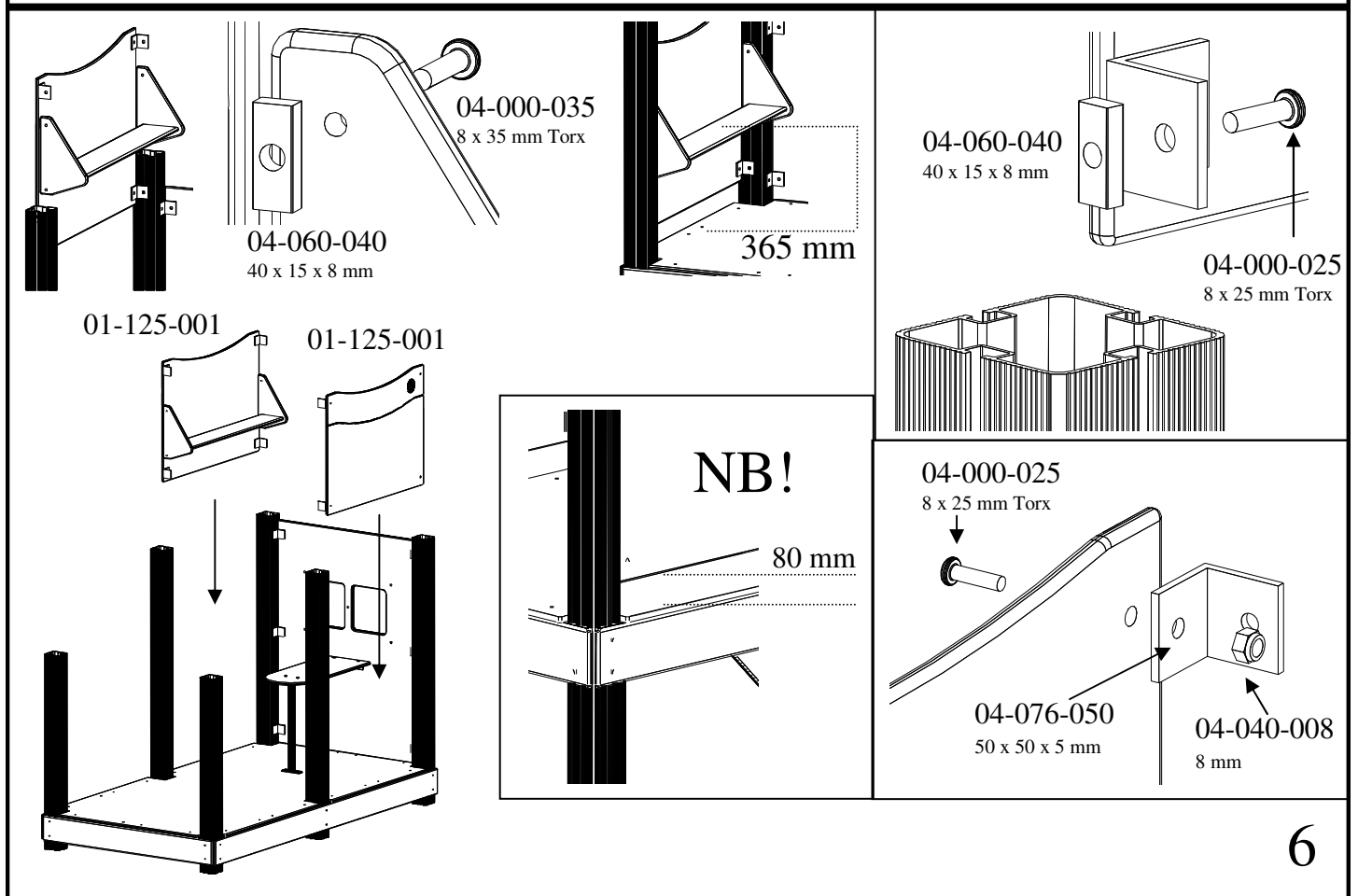
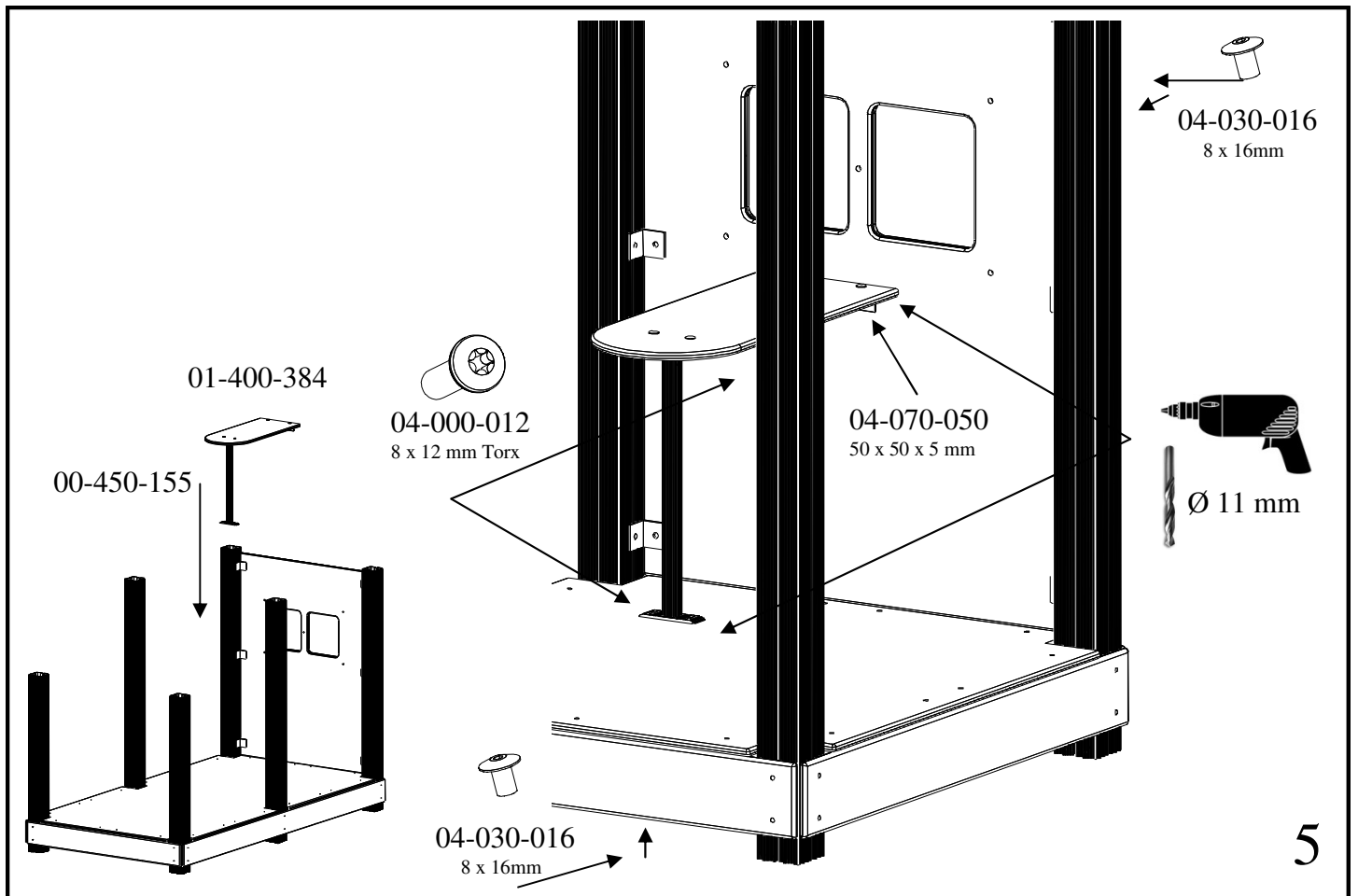

01-125-003

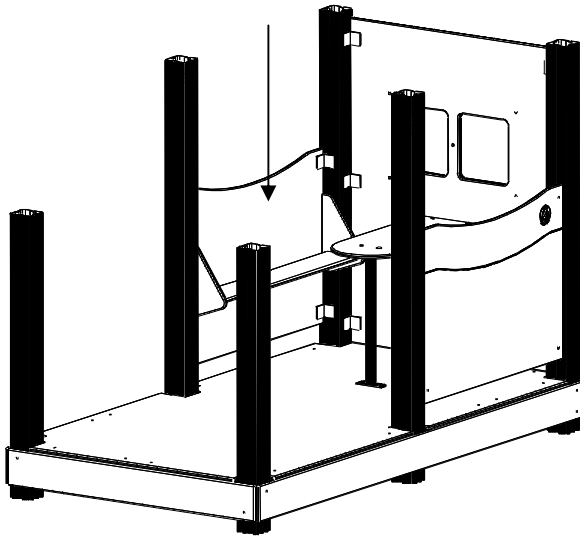
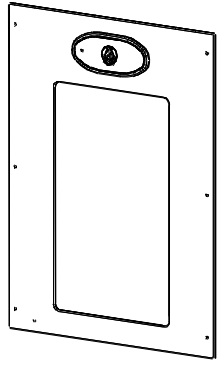

04-060-040  
40 x 15 x 8 mm

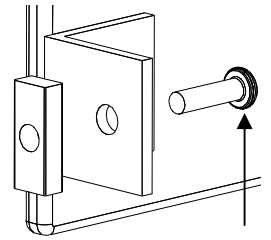

04-000-025  
8 x 25 mm Torx

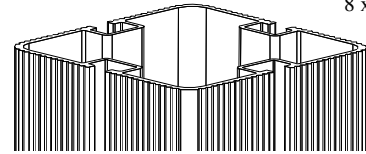

04-000-025  
8 x 25 mm Torx

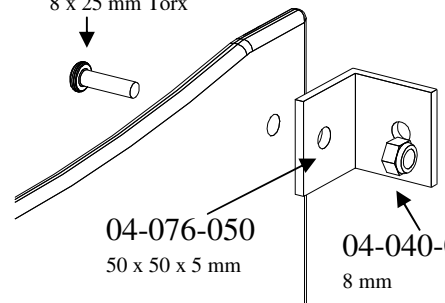

04-076-050  
50 x 50 x 5 mm

04-040-008  
8 mm

7

04-000-025  
8 x 25 mm Torx

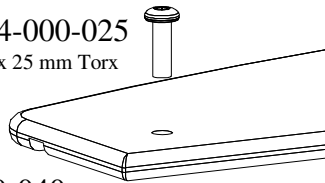

04-060-040  
40 x 15 x 8 mm

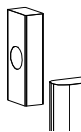

04-000-025  
8 x 25 mm Torx



04-040-008  
8 mm

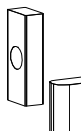

04-060-040  
40 x 15 x 8 mm

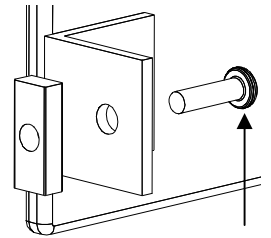

04-000-025  
8 x 25 mm Torx

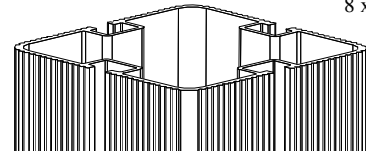

04-000-025  
8 x 25 mm Torx

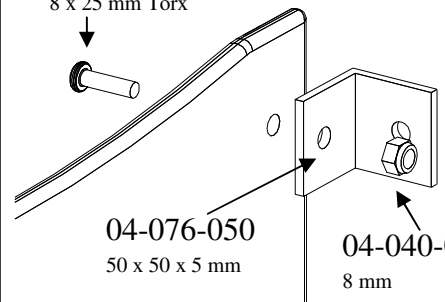

04-076-050  
50 x 50 x 5 mm

04-040-008  
8 mm

01-125-014

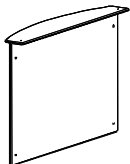

01-125-014

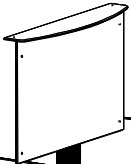

01-125-013

01-125-013

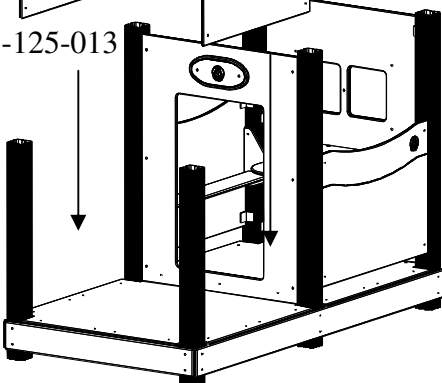

**NB!**

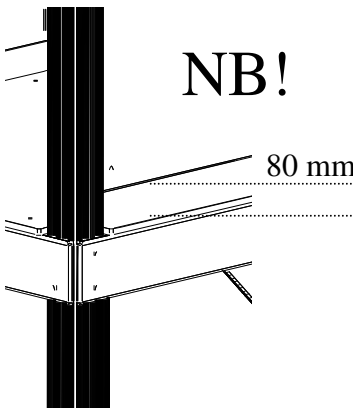

80 mm

8

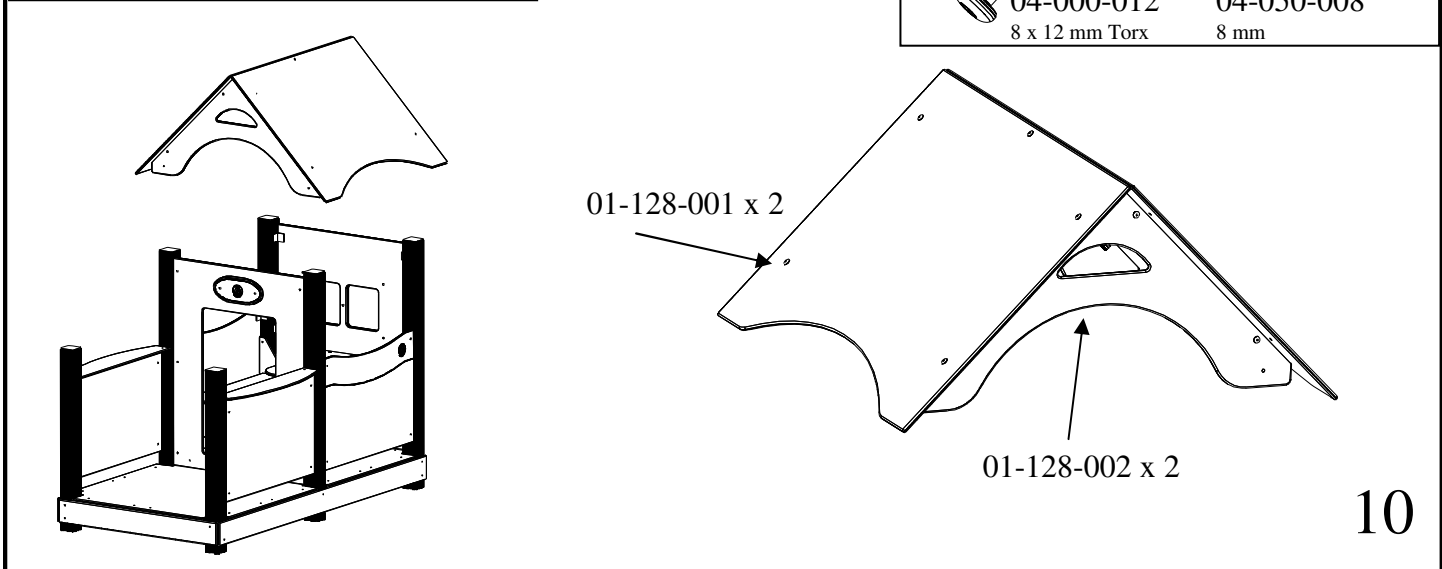
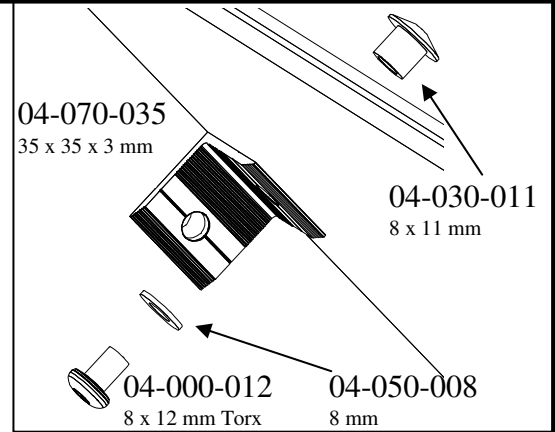
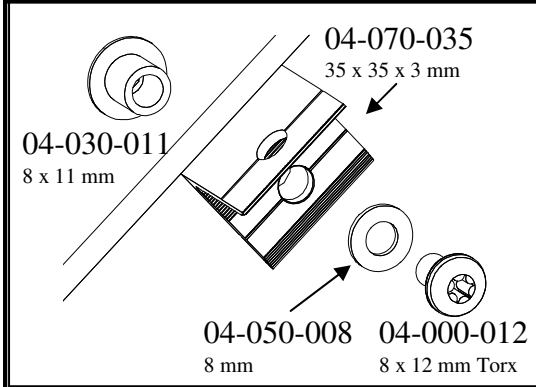
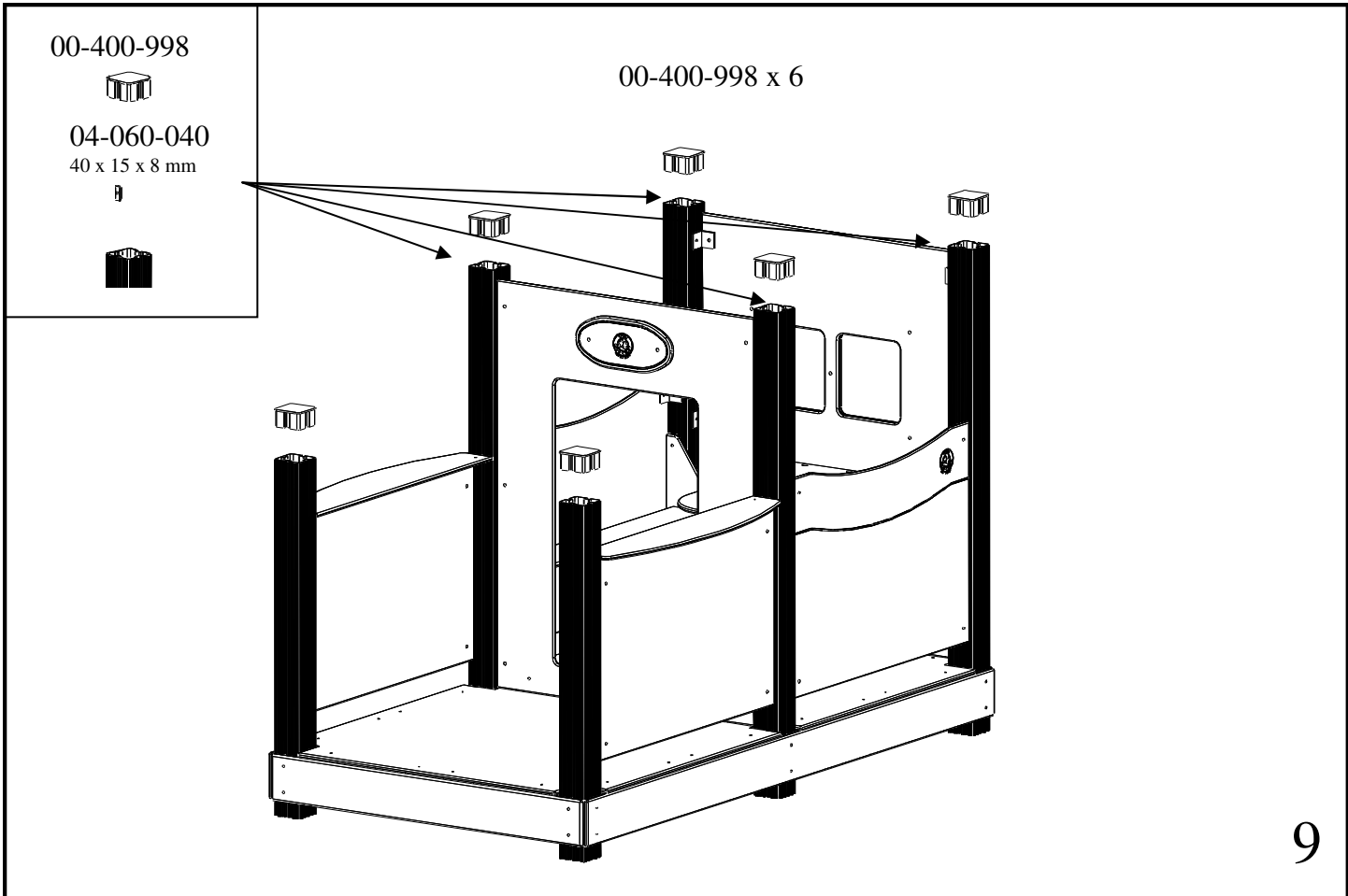



## 11 Før utstyret tas i bruk / Before play begins / Innan lekredskapet används

- ☐ N ☐ Påse at fallunderlag er lagt i henhold til gjeldende regler eller vår anbefaling
- ☐ Fjern alle monteringshjelpemidler ( rester av betong, planker, paller, plast, og lignende)
- ☐ Før utstyret tas i bruk, sjekk at det ikke er hektefare for anorakksnorer og lignende noen steder på lekeapparatet.

NB! Bør stå i 2-3 dager før bruk når forankring støpes.

- ☐ UK ☐ Make sure the area and depth of safer surfacing are according to the current standard, or to the manufacturer's recommendation
- ☐ Make sure all tools and surplus materials are removed before play begins

PS! When complete, allow 2-3 days for the concrete to set before use.

- ☐ S ☐ Kontrollera att fallunderlag är utlagt enligt gällande regler eller vår rekommendation
- ☐ Ta bort alla monteringshjälpmiddel (rester av betong, plankor, pallar, plast och liknande)
- ☐ Innan lekredskapet används, kontrollera att anoracksnoddar eller kläder/delar av kläder eller liknande inte kan fastna i några delar på redskapet.

- ☐ OBS! Bör stå i 2-3 dagar innan användning när det gjuts



**5**

**Pakkliste for / Parts list for / Packlista för :  
26-233-050**

Sign. \_\_\_\_\_

  	Bolter/skruer Bolts/Screws Komponenter	Dimensjon Dimension Dimension	Ant Qty Ant	Lev Lev	Bolter/skruer Bolts/Screws Bultar/Skruvar	Dimensjon Dimension Dimension	Ant Qty Ant	Lev Lev
		04-000-012 8 x 12 mm Torx	<b>6</b>				04-060-040 40 x 15 x 8 mm	<b>16</b>
	04-000-025 8 x 25 mm Torx	<b>12</b>						
	04-000-035 8 x 35 mm Torx	<b>28</b>				04-040-008 8 mm	<b>12</b>	
	04-090-002	<b>24</b>						
	04-076-050 50 x 50 x 5 mm	<b>12</b>			Produkt merking Product marking Produkt märkning			
	04-070-050 50 x 50 x 5 mm	<b>2</b>						
	04-030-016 8 x 16 mm	<b>6</b>						<b>1</b>

**Boltepakker for / Boltpackage for / Bultpaket för 26-233-050**

01-128-000    Antall Number Antal <input type="checkbox"/>		04-060-040 40 x 15 x 8 mm	<b>4</b>		01-125-004    Antall Number Antal <input type="checkbox"/>		04-060-040 40 x 15 x 8 mm	<b>6</b>	
		04-000-012 8 x 12 mm Torx	<b>22</b>				04-000-025 8 x 25 mm Torx	<b>12</b>	
		04-000-035 8 x 35 mm Torx	<b>4</b>				04-076-050 50 x 50 x 5 mm	<b>6</b>	
		04-070-035 35 x 35 x 3 mm	<b>11</b>				04-040-008 8 mm	<b>6</b>	
		04-030-011 8 x 11 mm	<b>22</b>						
		04-050-008 8 mm	<b>22</b>						
01-125-001    Antall Number Antal <input type="checkbox"/>		04-060-040 40 x 15 x 8 mm	<b>4</b>	X 2	01-125-003    Antall Number Antal <input type="checkbox"/>		04-060-040 40 x 15 x 8 mm	<b>6</b>	
		04-000-025 8 x 25 mm Torx	<b>8</b>	X 2			04-000-025 8 x 25 mm Torx	<b>12</b>	
		04-076-050 50 x 50 x 5 mm	<b>4</b>	X 2			04-076-050 50 x 50 x 5 mm	<b>6</b>	
		04-040-008 8 mm	<b>4</b>	X 2			04-040-008 8 mm	<b>6</b>	
					Monteringsanvisning Assembly Instructions Monteringsanvisning			<b>1</b>	
									<b>19</b>

**5**

**Pakkliste for / Parts list for / Packlista för :**  
**26-233-050**

3 av 3

Sign. \_\_\_\_\_

### Forankring / Foundations / Markförankring

### 00-003-003

N Er bestilt       Ikke bestilt  
 UK In order       Not in order  
 S Bestållt       Ej bestållt

00-400-997

**-6**

00-003-100 00-003-101 00-003-102	<b>6</b>	04-000-035 8 x 35 mm Torx	<b>18</b>	
		04-050-008 8 mm	<b>18</b>	
		04-060-120 120 x 15 x 8 mm	<b>12</b>	
00-003-103 	<b>0</b>	04-000-040 8 x 40 mm Torx	<b>0</b>	
		04-040-008 8 mm	<b>0</b>	
		04-050-008 8 mm	<b>0</b>	
Eller Or Eller 00-003-105  00-003-106 	<b>0</b>	04-010-035 10 x 35 mm	<b>0</b>	
		04-040-010 10 mm	<b>0</b>	
		04-050-010 10 mm	<b>0</b>	