



Monteringsanvisning



Assembly Instructions



Monteringsanvisning

Produkt nr. / Product no. / Produkt nr.

30-189-210

Ordr. nr. _____

Dato. _____

Sign. _____

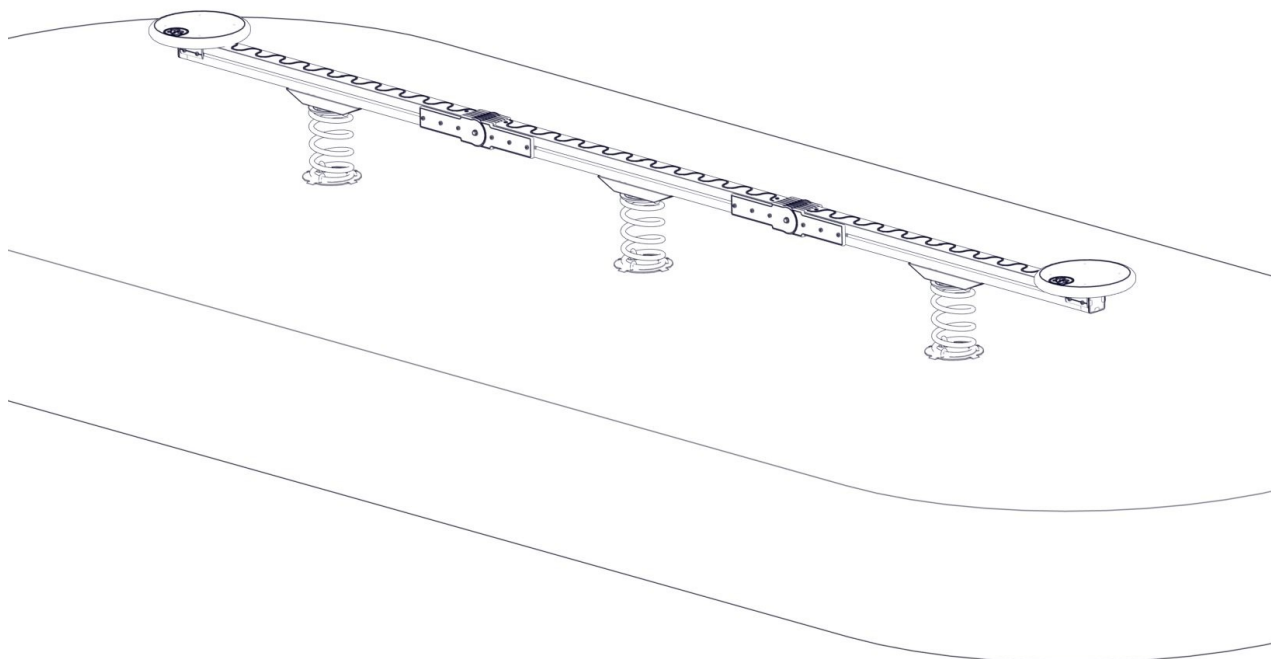

søve

Søve AS
Grønnvoldveien 290
3830 Ulefoss - Norway
Tlf: +47 35 94 65 65
www.sove.no



søve

Søve AB
EA Rosengrensgatan 32
421 31 Västra Frölunda
Phone: +46 (0)31 773 97 00
www.sove.se

Monteringstips / Assembly Advice / Monteringsstips**N**

- Les monteringsanvisningen nøye før montering.
- Monter elementene i rekkefølgen som vist.
- Boltene bør ikke skrues for hardt til før alt er montert, vatret og loddet. Skru så boltene til.
- NB! Ved bruk av drill, kan boltene ryke.
- Er lekeutstyret plassert i naturlige ferdselstraséer må området sikres mot gjennomgang.
- Innspringningshinder bør vurderes rundt lekeapparater hvor det er stor bevegelse, f.eks. ved huskestativ.
- Det bør være fritt innsyn til lekeutstyr som er beregnet for barn under 3 år.

NB! Under monteringsarbeidet må utstyr, som ikke er forankret forsvarlig i bakken, sikres slik at det ikke velte.

Området må avstenges under montering av apparatene med sperrebånd eller lignende.

EN

- Read the instruction carefully before assembling the play unit..
- Assemble the components in the sequence shown in these instructions.
- Fixings must not be fully tightened during assembly. Before casting the foundations, the structure must be level and plumb, at which point all fixings are tightened.
- PS! If use of drill, the bolts may be wrecked.
- Secure the construction-area to prevent people from walking through it.
- Consider installing barriers around play-equipment which gives rise to a lot of activity – i.e.swings.
- Ensure that clear vision is possible across the play area so that supervision is possible from any position, particularly where children under 3 years of age will be playing.

NB! During assembly of the equipment, ensure that all structures are securely propped, especially when left overnight. Also ensure that equipment is supported whilst concrete foundations are setting and enclose the area securely to prevent access.

Monteringstips / Assembly Advice / Monteringsstips**S**

- Läs monteringsanvisningen noga före montering.
- Montera delarna i den ordningen som anvisas
- Skruvarna bör inte skruvas för hårt tills allt är monterat, i våg och lodat.







OBS! Används elektrisk skruvdragare, kan bulten gå sönder. Hårdra därför manuellt!

- Om lekplatsen placeras vid en gångväg mm bör området säkras mot genomfart av gående och cyklister.
- Inspringshinder bör placeras runt lekutrustning med stor rörelse, t ex, gungställning.
- Det bör vara fri insyn till lekutrustning beräknat till barn under 3 år.

OBS! Under monteringsarbete bör utrustningen som inte ska förankras i marken, ställs så att den inte kan välta.

Området måste spärras när lekutrustningen byggs upp, med avspärrningsband eller liknande.

Nødvendig verktøy / Tools required / Nödvändiga verktyg

<p>(N)</p> <p>(EN)</p> <p>(S)</p>		<p>Pozidriv</p> 	 <p>13 + 17mm</p>		
		<p>Metermål</p> <p>Metric measure</p> <p>Tumstock</p> 		<p>Merkebånd</p> <p>Mark ribbon</p> <p>Märkeband</p> 	

Nødvendig antall personer / Number of persons required / Rekommenderad antal personer





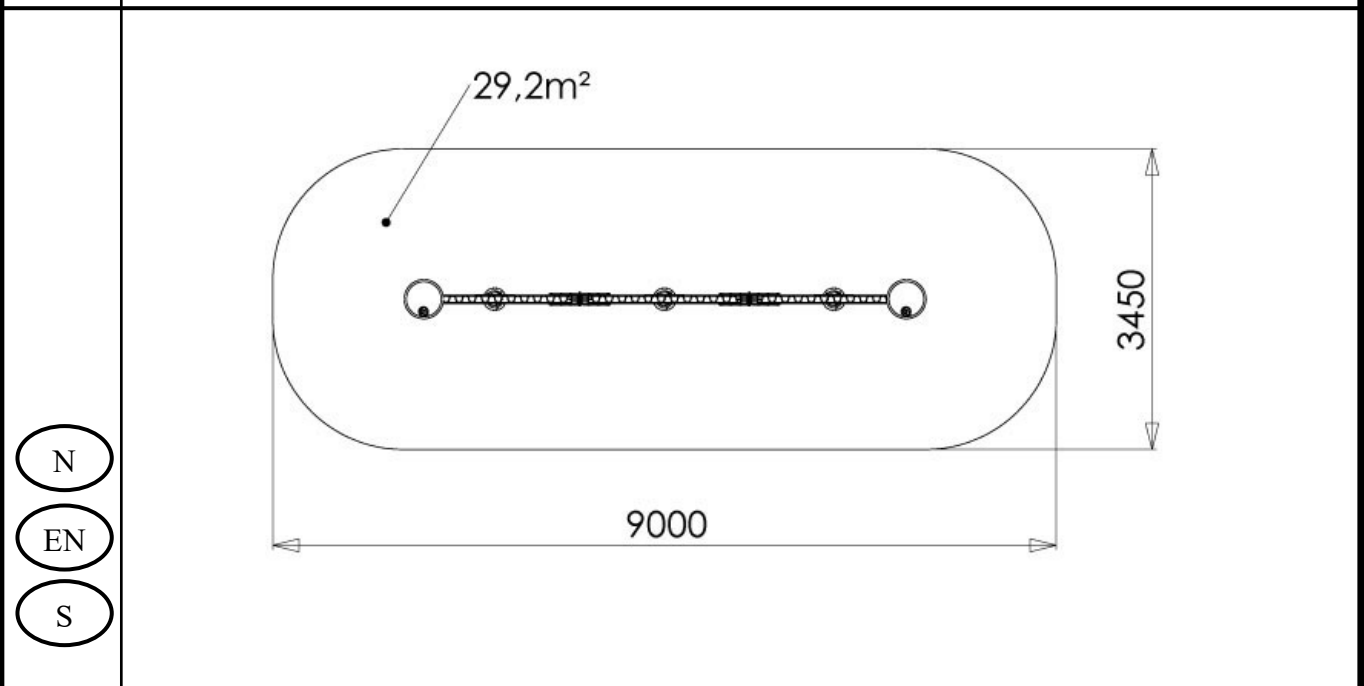

<p>(N)</p> <p>(EN)</p> <p>(S)</p>	
-----------------------------------	---

Anbefalt arealbehov ved montering / Recommended working space / Rekommenderad arealbehov vid montering

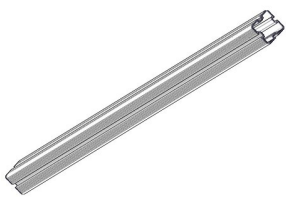

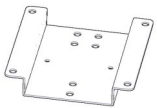









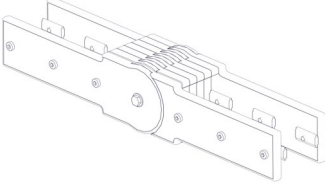
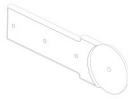

Boltepakker for / Boltpackage for / Bultpaket för

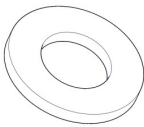
Sign. _____

Stolpe 95x95	Ant= 3	Navn	Artnr/dimensjon	Ant	Lev
		Stolpe VK95 L=1800 (1) På montert	00-400-018	0	
Stolpende 95x95	Ant= 2	Navn	Artnr/dimensjon	Ant	Lev
		End lokk VK95(1) På montert	00-400-998	0	
Hoppesopp	Ant= 2	Navn	Artnr/dimensjon	Ant	Lev
		Hoppesopp (1) På montert	03-191-010	0	
		Lav Beslag med ekstra hull (1) På montert	03-191-009	0	
		Sekskant M10x20 (4) På montert	04-010-020	0	
		Skive M10 (4) På montert	04-050-010	0	
		Torx M8x20 (2) På montert	04-000-020	0	
		Brikke 50-1T (2) På montert	04-060-050	0	







Boltepakker for / Boltpackage for / Bultpaket för

Sign. _____

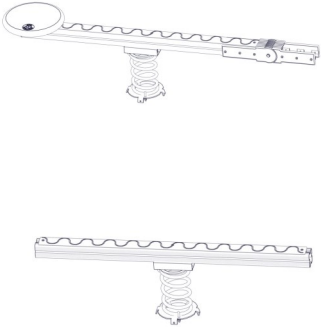
Kobling vippebalanse	Ant= 2	Navn	Artnr/dimensjon	Ant	Lev
		HPL kobling side(4) På montert	07-540-010	0	
		HPL kobling midt (10) På montert	07-540-011	0	
		Sekskant M10x150 (1) På montert	04-010-150	0	
		Mutter M10 (2) På montert	04-045-010	0	
		Skive M10 (4) På montert	04-050-010	0	
		Torx M8x35 (12) På montert	04-000-035	0	
		Brikke 50_1T (12) På montert	04-060-050	0	
HPL topplate	Ant= 1	Navn	Artnr/dimensjon	Ant	Lev
		HPL Topplate Side (1) L=1750 På montert	07-540-013	0	
		HPL Topplate Side (1) L= 1605 På montert	07-540-012	0	
		Torx M8x25 (9) På montert	04-000-025	0	
		Brikke 50_1T (9) På montert	04-060-050	0	

Boltepakker for / Boltpackage for / Bultpaket för

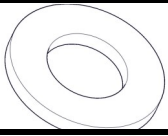
Sign. _____.

Hoppesopp	Ant= 3	Navn	Artnr/dimensjon	Ant	Lev
		Fjear med lavtopp- beslag til 95x95 stolpe	03-191-000a	2	
		Fjear med lavtopp- beslag til 95x95 stolpe	03-191-000b	1	
		Beslag til forankring (4)	03-191-017	12	
		Bunnplate (1)	03-191-018	3	
		Låssemutter M10 (8)	04-040-010	24	
		Sekskant M10x25 (8)	04-010-025	24	
		Skive M10 stor(4)	04-055-010	12	
		Torx M8x25 (2) På montert	04-000-025	0	
		Brikke 120_3T (1) På montert	04-060-120	0	

Fundamentering uten betong / Foundation without concrete / Förankring utan betong

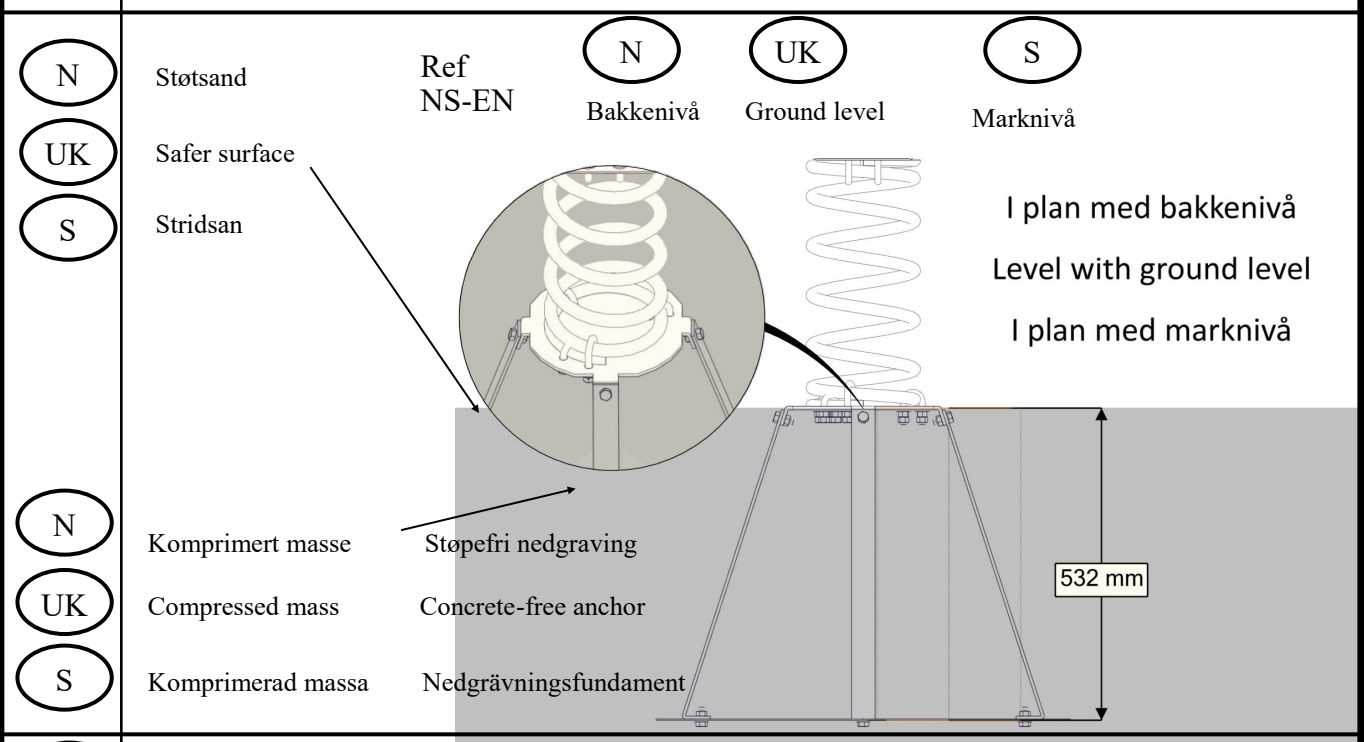

N Alle mål er oppgitt i millimeter
 UK Scale measured in mm
 S Alla mått är i millimeter.

Fallhøyder / Free height of fall / Fallhöjder

Fallhøyde < 0,6 meter

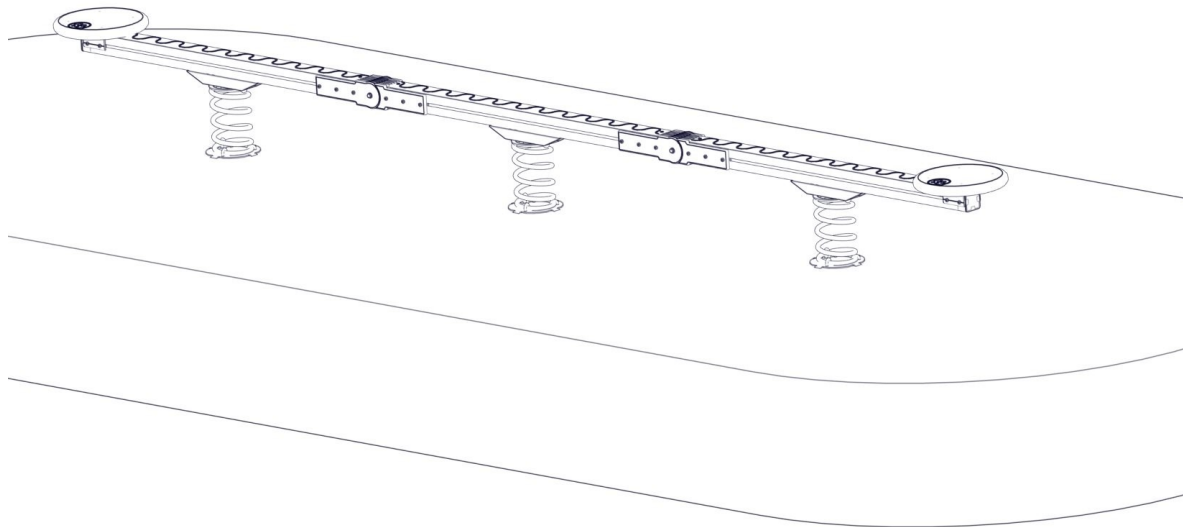

Sikkerhetszone / Safety zone / Säkerhetszon

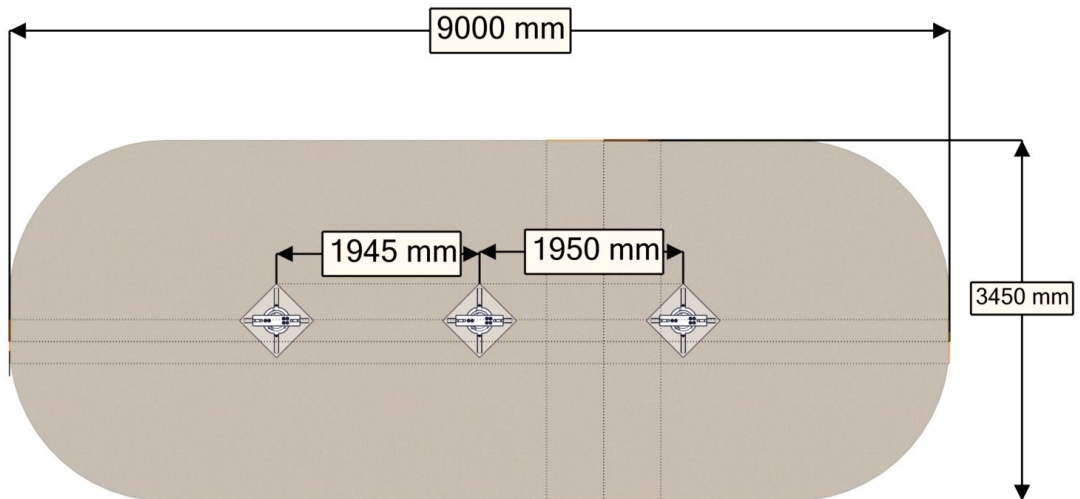

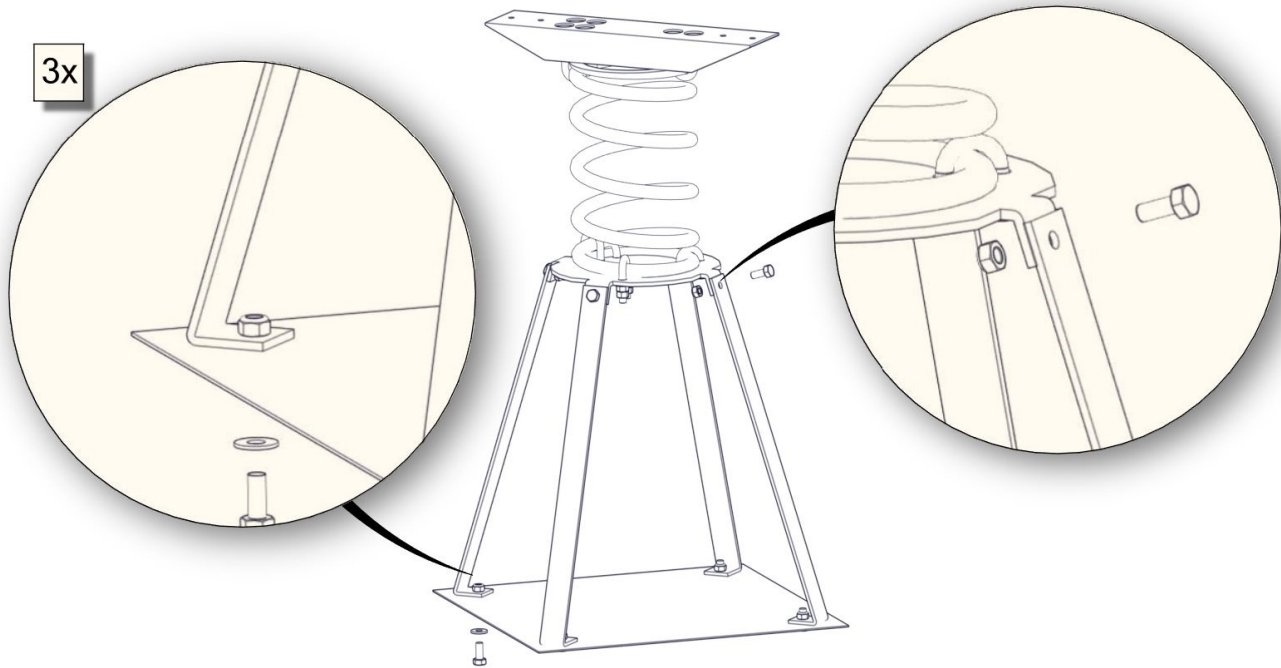
Montering av lekeapparatet / Assembly instructions / Montering av lekredskapet

nr	PartName	Artnr	Antall
1	Beslag 550x40	03-191-017	4
2	Bunn plate 500x500	03-191-018	1
3	Sekskant skrue M10x25	04-010-025	8

nr	PartName	Artnr	Antall
4	Låsemutter M10	04-040-010	8
5	Skive M10 stor	04-055-010	4

3x

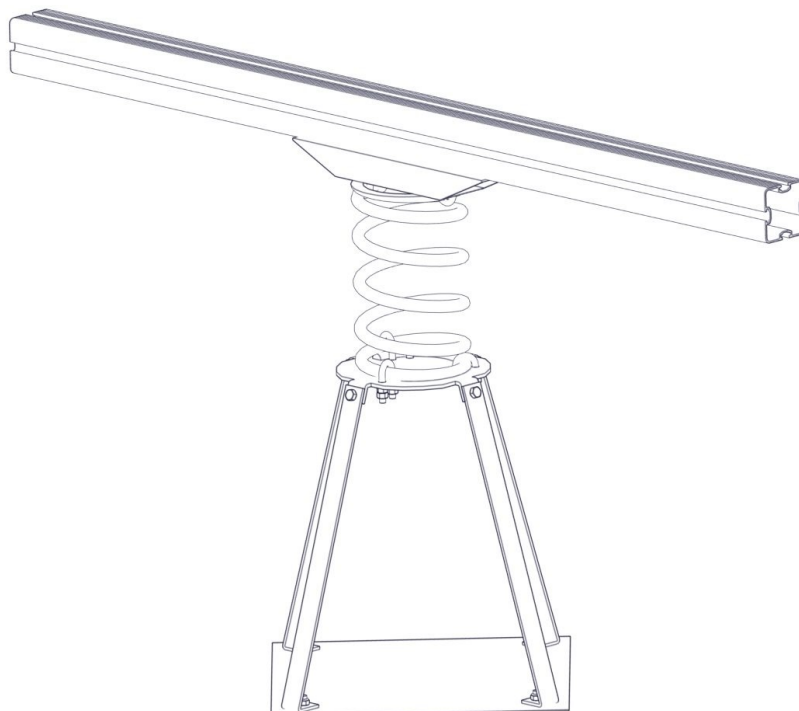

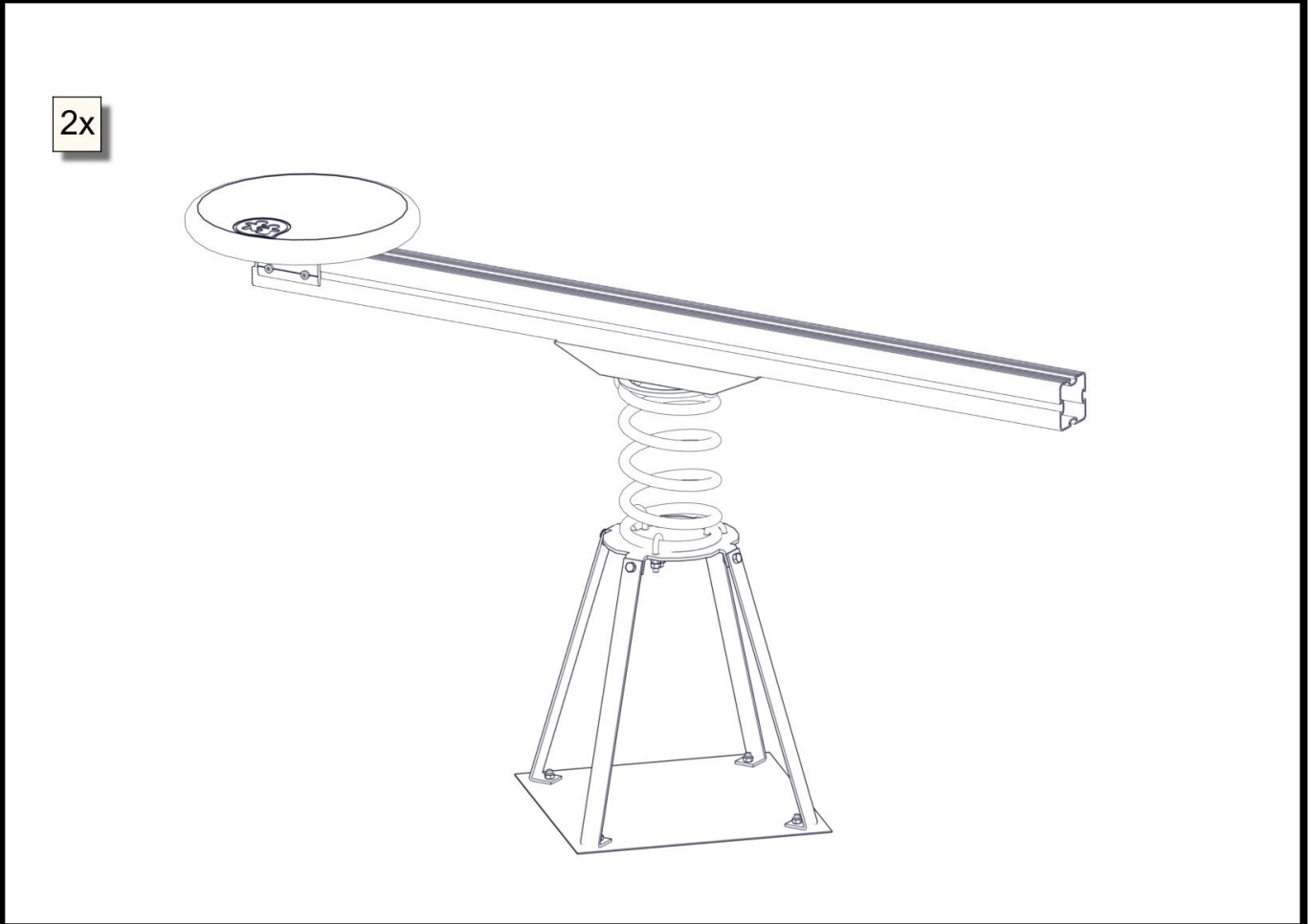
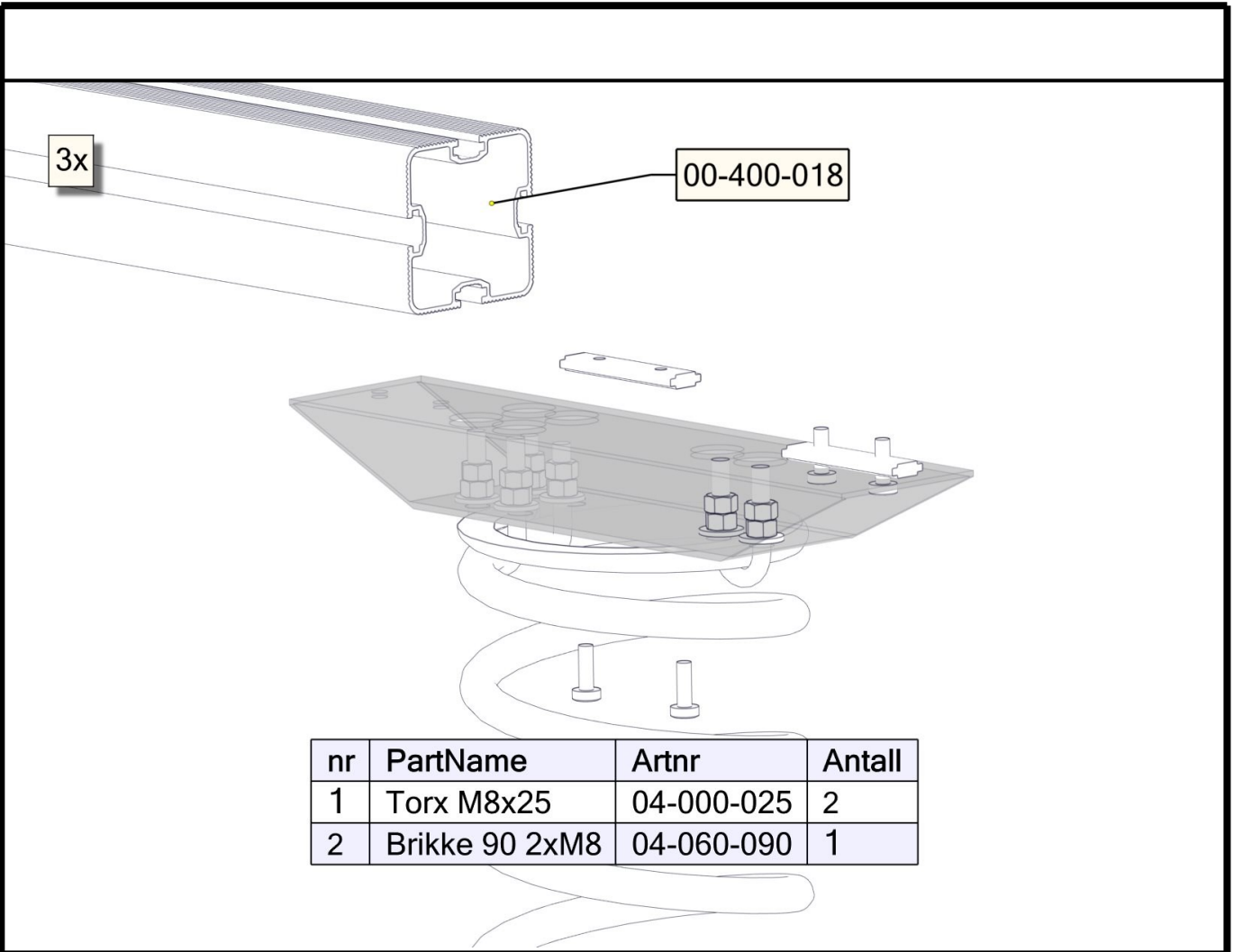

2x



2x

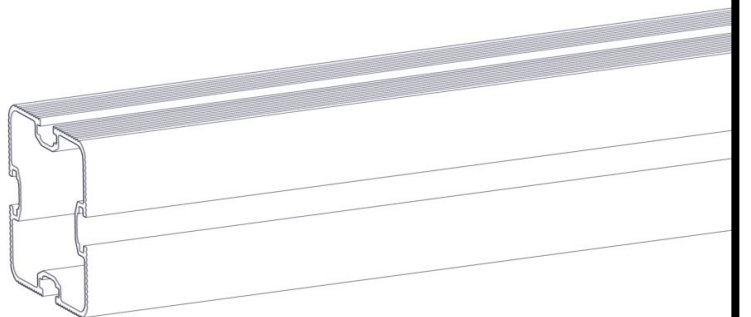

2x

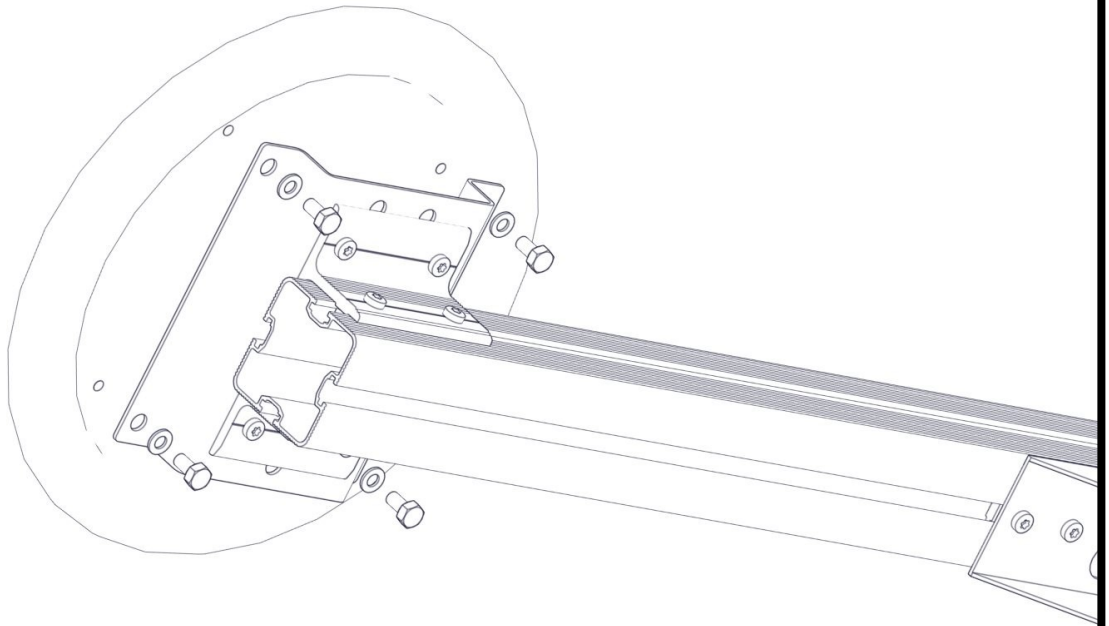

nr	PartName	Artnr	Antall
1	Hoppesop topplate Ø 450	03-191-010	1
2	Sekskant skrue M10x20	04-010-020	4
3	Skive M10	04-050-010	4

2x

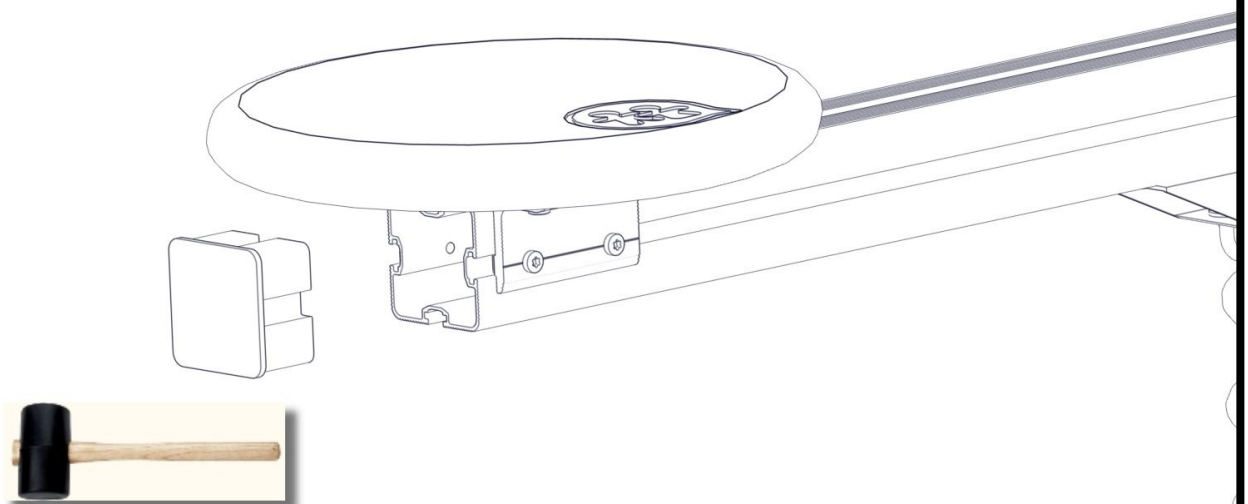

nr	PartName	Artnr	Antall
1	Endelukk 95x95	00-400-998	1

2x

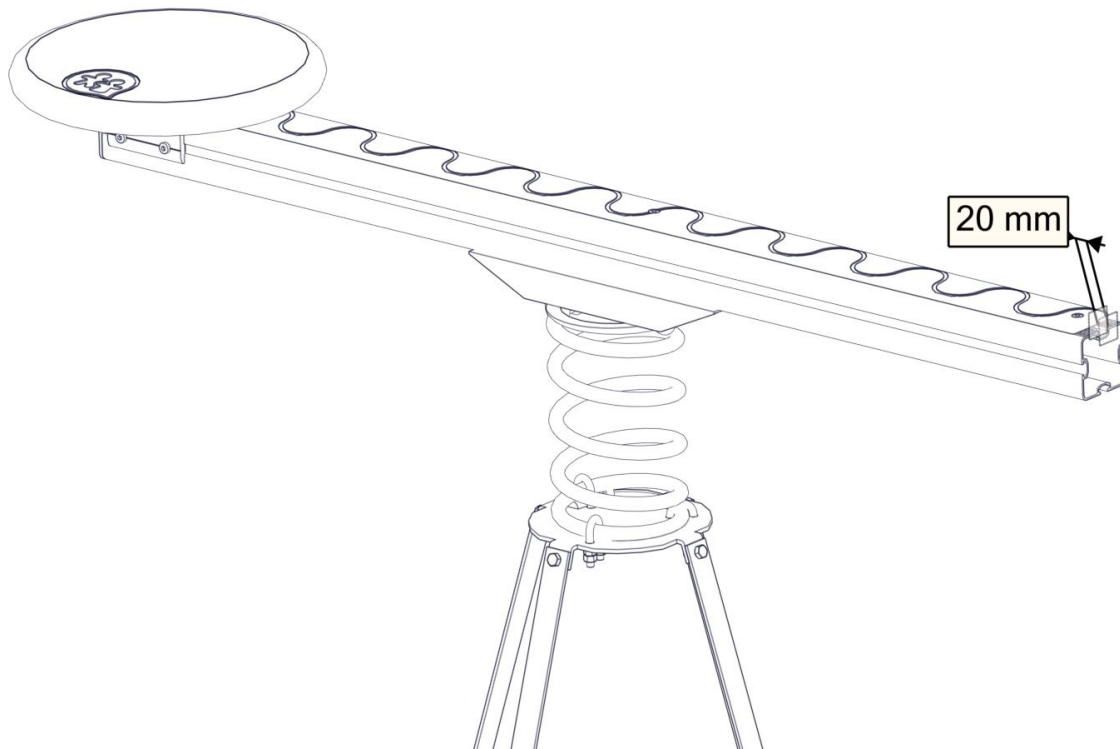

2x

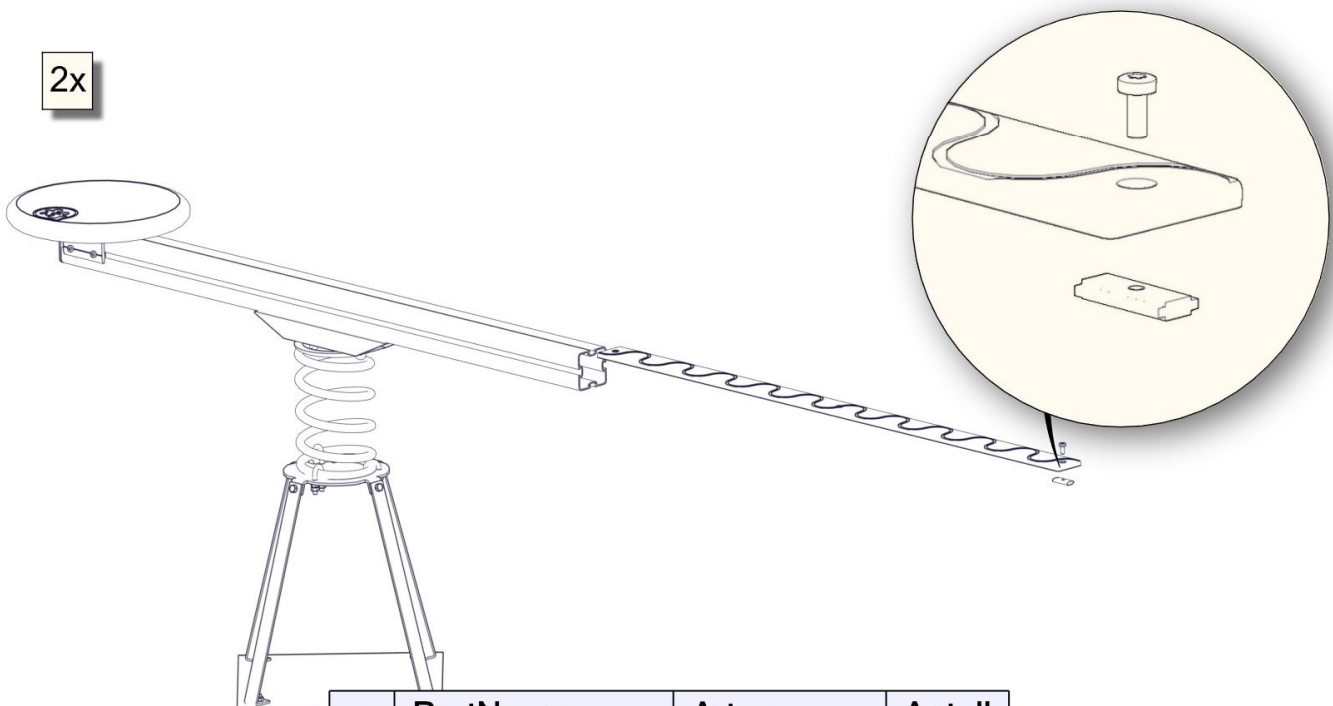

nr	PartName	Artnr	Antall
1	Torx M8x20	04-000-020	3
2	Brikke 50 1XM8	04-060-050	3
3		07-540-012	1

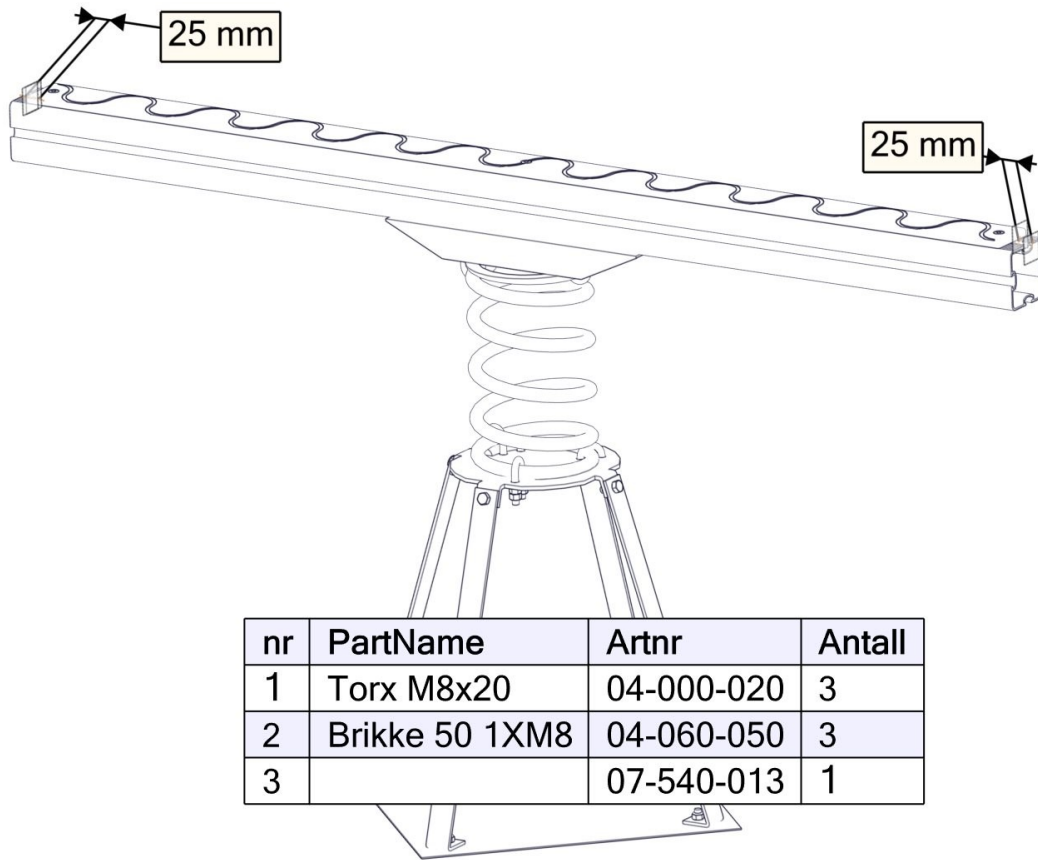

nr	PartName	Artnr	Antall
1	Torx M8x20	04-000-020	3
2	Brikke 50 1XM8	04-060-050	3
3		07-540-013	1

2x

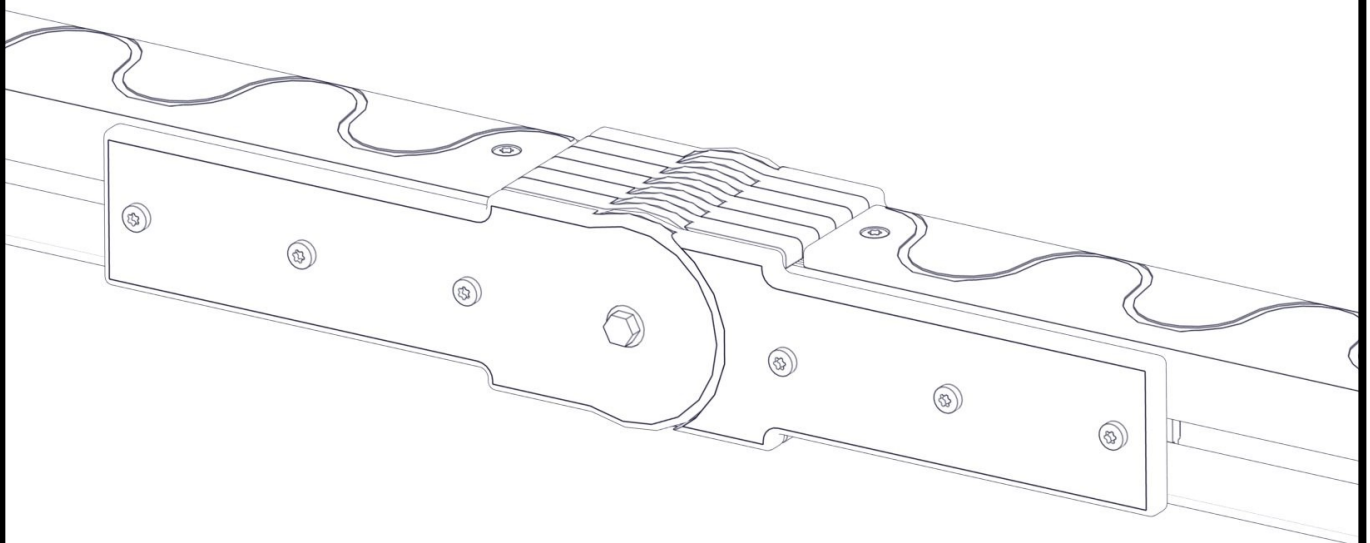

2x

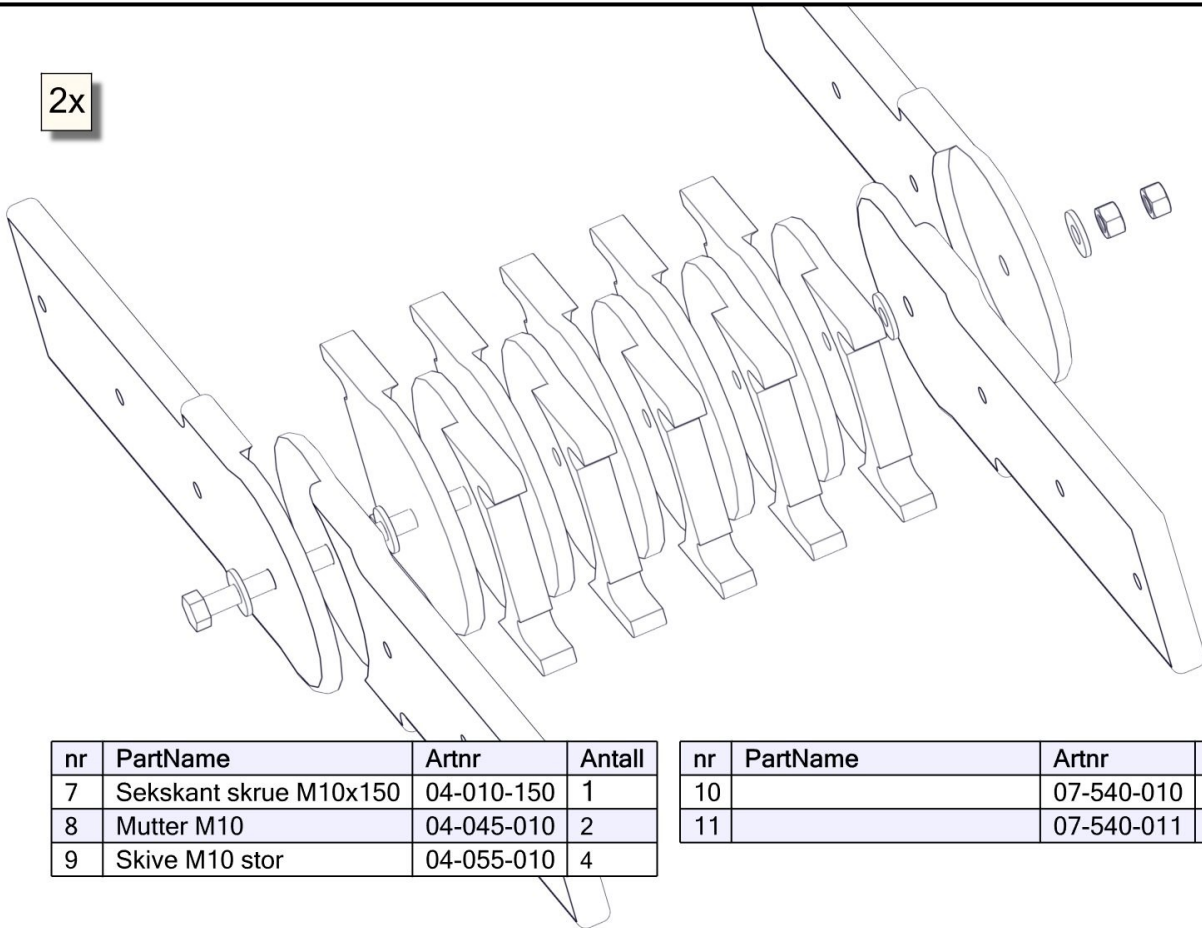

nr	PartName	Artnr	Antall
7	Sekskant skrue M10x150	04-010-150	1
8	Mutter M10	04-045-010	2
9	Skive M10 stor	04-055-010	4

nr	PartName	Artnr	Antall
10		07-540-010	4
11		07-540-011	10

2x

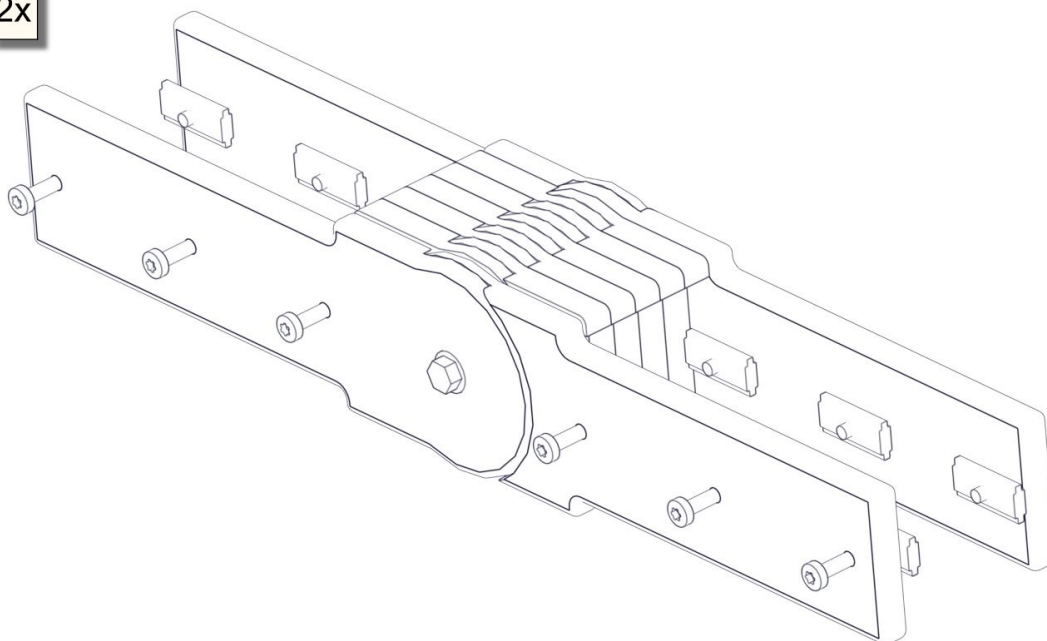



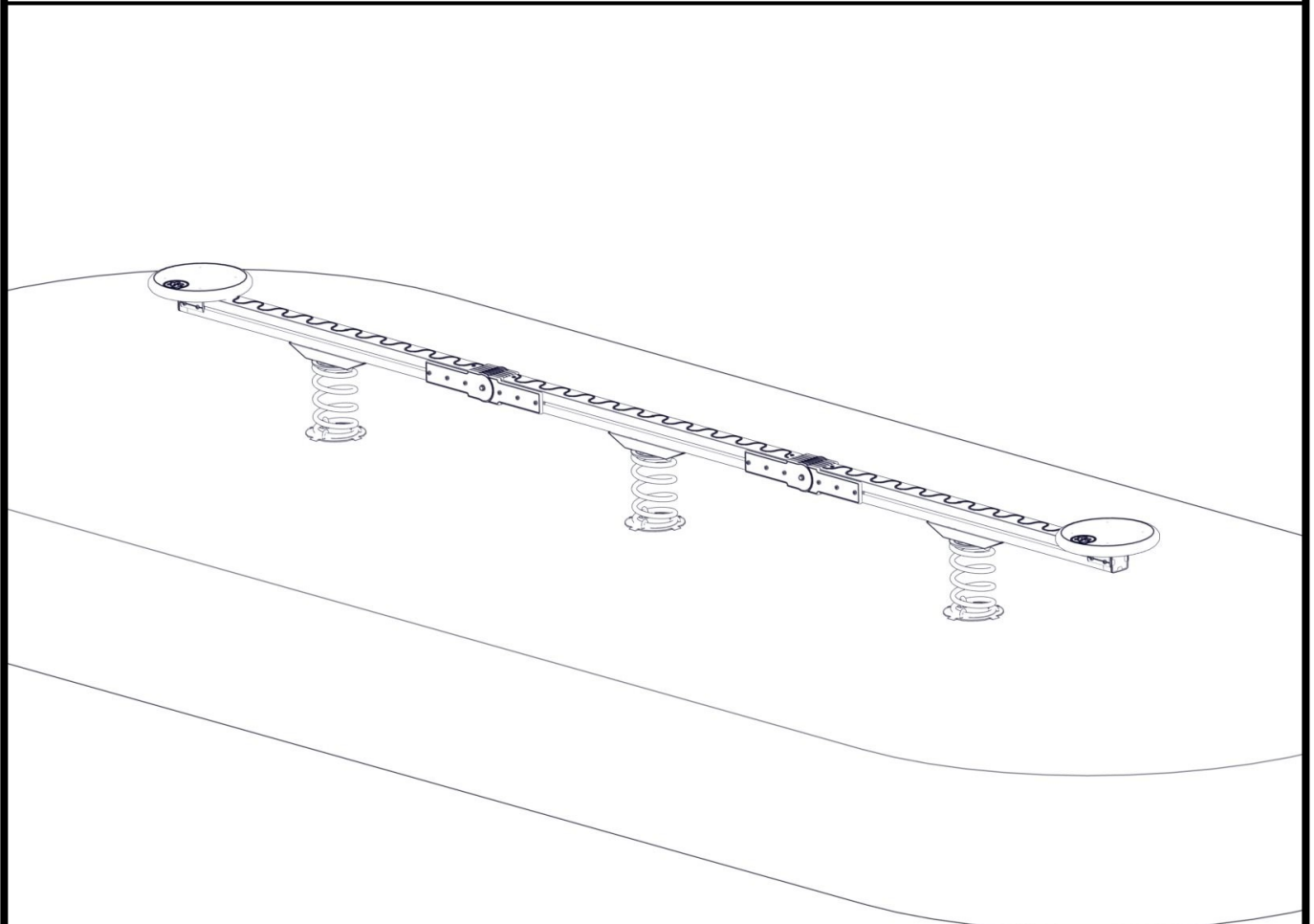
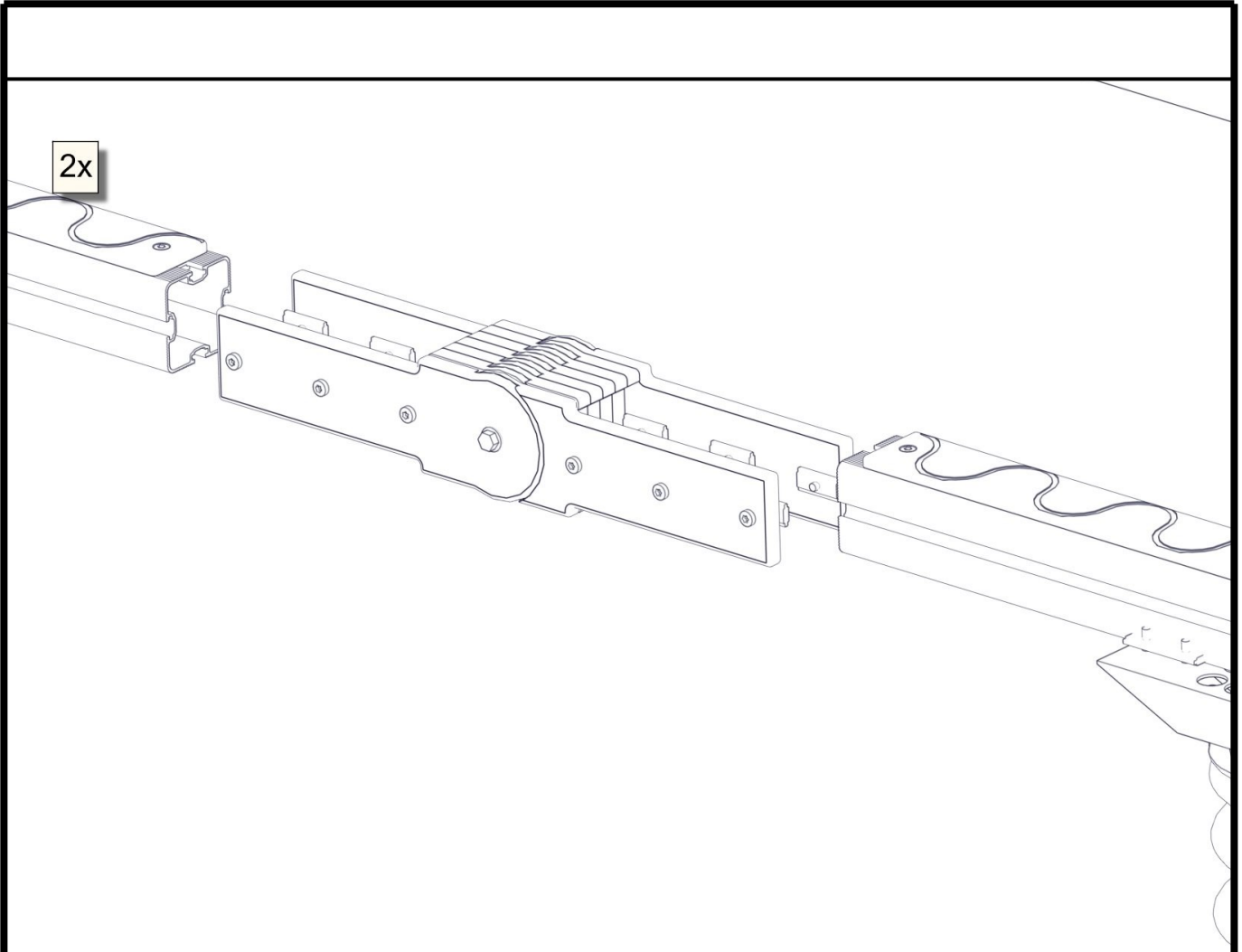



nr	PartName	Artnr	Antall
1	Torx M8x35	04-000-035	12
2	Brikke 50 1XM8	04-060-050	12

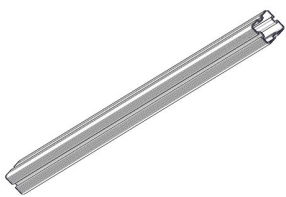

Før utstyret tas i bruk / Before play begins / Innan lekredskapet tas i bruk	
N	<ul style="list-style-type: none"> • Påse at fallunderlag er utlagt i henhold til gjeldende regler eller vår anbefaling • Fjern alle monteringshjelpemidler (rester av betong, planker, paller, plast, og lignende) • Før utstyret tas i bruk, burde man sjekke at det ikke er fare for at anorakksnorer og lignende som kan hekte seg fast noen steder på lekeapparatet. (Vedlagte snor med dobbe (kneledd) kan brukes til å sjekke at dette er i orden. Se vedlagte veiledning for bruk av denne. Dette gjøres for å oppdage eventuelle feilmonteringer.?) • NB! Bør stå i 2-3 dager før bruk
UK	<ul style="list-style-type: none"> • Make sure the area and depth of safer surfacing are according to the current standard, or to the manufacturer's recommendation • Make sure all tools and surplus materials are removed before play begins • PS! When complete, allow 2-3 days for the concrete to set before use
S	<ul style="list-style-type: none"> • Kontrollera att fallunderlag är utlagt enligt gällande regler eller vårt rekomenation • Ta bort alla monteringshjälpmedel (rester av betong, plankor, pallar, plast och liknande) • Innan lekredskapet används, kontrollera att anoracksnoddar eller kläder/delar av kläder eller liknande inte kan fastna i några delar på redskapet. (Den bipackade "knävringen" kan man med fördel användas för denna kontroll. • Detta görs för att upptäcka eventuella felmonteringar.)

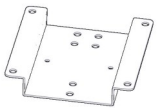









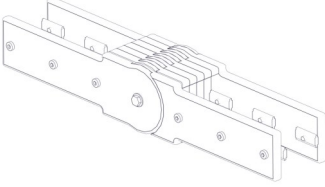
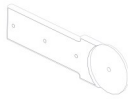

Boltepakker for / Boltpackage for / Bultpaket för

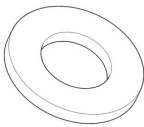
Sign. _____

Stolpe 95x95	Ant= 3	Navn	Artnr/dimensjon	Ant	Lev
		Stolpe VK95 L=1800 (1) På montert	00-400-018	0	
Stolpende 95x95	Ant= 2	Navn	Artnr/dimensjon	Ant	Lev
		End lokk VK95(1) På montert	00-400-998	0	
Hoppesopp	Ant= 2	Navn	Artnr/dimensjon	Ant	Lev
		Hoppesopp (1) På montert	03-191-010	0	
		Lav Beslag med ekstra hull (1) På montert	03-191-009	0	
		Sekskant M10x20 (4) På montert	04-010-020	0	
		Skive M10 (4) På montert	04-050-010	0	
		Torx M8x20 (2) På montert	04-000-020	0	
		Brikke 50-1T (2) På montert	04-060-050	0	







Boltepakker for / Boltpackage for / Bultpaket för

Sign. _____

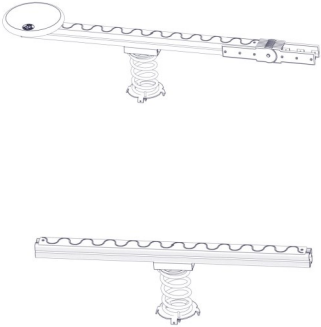
Kobling vippebalanse	Ant= 2	Navn	Artnr/dimensjon	Ant	Lev
		HPL kobling side(4) På montert	07-540-010	0	
		HPL kobling midt (10) På montert	07-540-011	0	
		Sekskant M10x150 (1) På montert	04-010-150	0	
		Mutter M10 (2) På montert	04-045-010	0	
		Skive M10 (4) På montert	04-050-010	0	
		Torx M8x35 (12) På montert	04-000-035	0	
		Brikke 50_1T (12) På montert	04-060-050	0	
HPL topplate	Ant= 1	Navn	Artnr/dimensjon	Ant	Lev
		HPL Topplate Side (1) L=1750 På montert	07-540-013	0	
		HPL Topplate Side (1) L= 1605 På montert	07-540-012	0	
		Torx M8x25 (9) På montert	04-000-025	0	
		Brikke 50_1T (9) På montert	04-060-050	0	

Boltepakker for / Boltpackage for / Bultpaket för

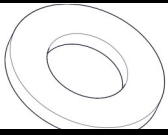
Sign. _____.

Hoppesopp	Ant= 3	Navn	Artnr/dimensjon	Ant	Lev
		Fjear med lavtopp- beslag til 95x95 stolpe	03-191-000a	2	
		Fjear med lavtopp- beslag til 95x95 stolpe	03-191-000b	1	
		Beslag til forankring (4)	03-191-017	12	
		Bunnplate (1)	03-191-018	3	
		Låssemutter M10 (8)	04-040-010	24	
		Sekskant M10x25 (8)	04-010-025	24	
		Skive M10 stor(4)	04-055-010	12	
		Torx M8x25 (2) På montert	04-000-025	0	
		Brikke 120_3T (1) På montert	04-060-120	0	