

N**Monteringsanvisning****EN****Assembly Instructions****S****Monteringsanvisning**

Produkt nr. / Product no. / Produkt nr.

30-191-112**Trestruktur**

Ord.. nr. _____

Dato. _____

Sign. _____

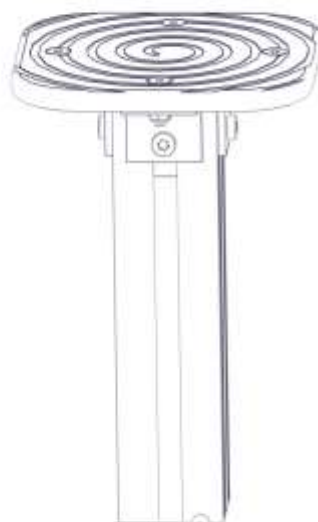

Søve AS
Grønnvoldveien 290
3830 Ulefoss - Norway
Tlf: +47 35 94 65 65
www.sove.no



Søve AB
EA Rosengrensgatan 32
421 31 Västra Frölunda
Phone: +46 (0)31 773 97 00
www.sove.se

Monteringstips / Assembly Advice / Monteringsstips

N

- Les monteringsanvisningen nøye før montering.
- Monter elementene i rekkefølgen som vist.
- Boltene bør ikke skrues for hardt til før alt er montert, vatret og loddet. Skru så boltene til.
- NB! Ved bruk av drill, kan boltene ryke.
- Er lekeutstyret plassert i naturlige ferdselstraséer må området sikres mot gjennomgang.
- Innspringningshinder bør vurderes rundt lekeapparater hvor det er stor bevegelse, f.eks. ved huskestativ.
- Det bør være fritt innsyn til lekeutstyr som er beregnet for barn under 3 år.

NB! Under monteringsarbeidet må utstyr, som ikke er forankret forsvarlig i bakken, sikres slik at det ikke velte.

Området må avstenges under montering av apparatene med sperrebånd eller lignende.

EN

- Read the instruction carefully before assembling the play unit..
- Assemble the components in the sequence shown in these instructions.
- Fixings must not be fully tightened during assembly. Before casting the foundations, the structure must be level and plumb, at which point all fixings are tightened.
- PS! If use of drill, the bolts may be wrecked.
- Secure the construction-area to prevent people from walking through it.
- Consider installing barriers around play-equipment which gives rise to a lot of activity – i.e.swings.
- Ensure that clear vision is possible across the play area so that supervision is possible from any position, particularly where children under 3 years of age will be playing.

NB! During assembly of the equipment, ensure that all structures are securely propped, especially when left overnight. Also ensure that equipment is supported whilst concrete foundations are setting and enclose the area securely to prevent access.

Monteringstips / Assembly Advice / Monteringsstips

S

- Läs monteringsanvisningen noga före montering.
- Montera delarna i den ordningen som anvisas
- Skruvarna bör inte skruvas för hårt tills allt är monterat, i våg och lodat.









OBS! Används elektrisk skruvdragare, kan bulten gå sönder. Hårdra därför manuellt!

- Om lekplatsen placeras vid en gångväg mm bör området säkras mot genomfart av gående och cyklister.
- Insprängningshinder bör placeras runt lekutrustning med stor rörelse, t ex, gungställning.
- Det bör vara fri insyn till lekutrustning beräknat till barn under 3 år.

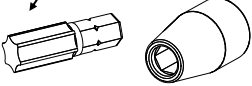
OBS! Under monteringsarbete bör utrustningen som inte ska förankras i marken, ställs så att den inte kan välta.

Området måste spärras när lekutrustningen byggs upp, med avspärrningsband eller liknande.

Nødvendig verktøy / Tools required / Nödvändiga verktyg





| | | | | | |
|-----------------------------------|--|---|---|--|------------|
| <p>(N)</p> <p>(EN)</p> <p>(S)</p> | <p>(A)</p>  | <p>(B)</p>  <p>Torx Nr 45 High quality</p>  | <p>(C)</p> | <p>(D)</p>  | <p>(E)</p> |
| |  | <p>Metermål</p> <p>Metric measure</p> <p>Tumstock</p>  | <p>16 V</p>  | <p>Merkebånd</p> <p>Mark ribbon</p> <p>Märkeband</p>  | |

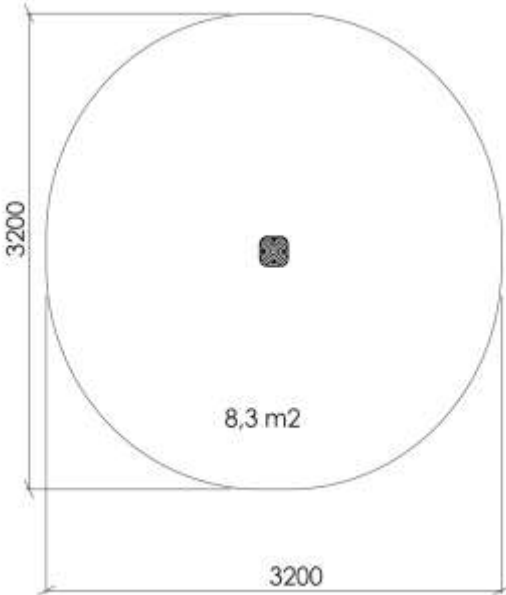

Nødvendig antall personer / Number of persons required / Rekommenderad antal personer

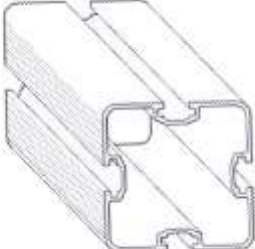
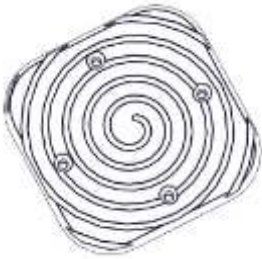
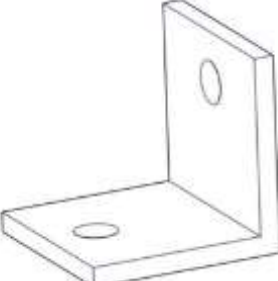
| | |
|-----------------------------------|---|
| <p>(N)</p> <p>(EN)</p> <p>(S)</p> |  |
|-----------------------------------|---|

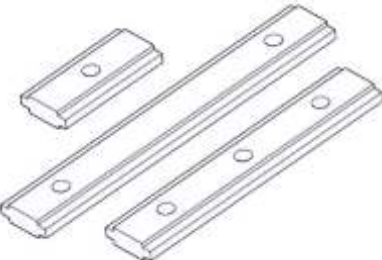
Anbefalt arealbehov ved montering / Recommended working space / Rekommenderad arealbehov vid montering

| | |
|-----------------------------------|--|
| <p>(N)</p> <p>(EN)</p> <p>(S)</p> |  |
|-----------------------------------|--|

| Boltepakker for / Boltpackage for / Bultpaket för | | Sign. _____. | | |
|---|---|-----------------------------|------------|------------|
| Stepper 300mm Trestruktur, 30-191-112 | Navn | Artnr/ dimensjon | Ant | Lev |
|  | Stolpe 70x70 L=900 (600-300) Sort | SFA5123/1 | 1 | |
|  | Stepper plate 200x200x15 Trestruktur | 06-100-102 | 1 | |
|  | Vinkel 50x50x50x5mm 11mm hull | 04-070-050 | 4 | |
|  | Torx M8x20 | 04-000-020 | 4 | |
|  | Brikke alu 50x8x23 m/ 1hull | 04-060-050 | 4 | |
|  | Mutter M8 Låsemutter | 04-040-008 | 4 | |

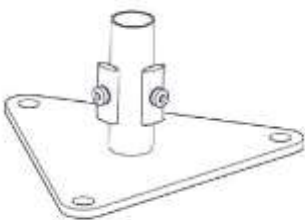
| Boltepakker for / Boltpackage for / Bultpaket för | | Sign. _____ | | |
|---|--|-------------------------------------|------------|------------|
| Stepper 300mm Trestruktur, 30-191-112 | Navn | Artnr/ dimensjon | Ant | Lev |
|  | Unbrako skrue M8x30 Forsenket hode | 04-034-030 | 4 | |
|  | Merkesilt | 00-100-402 (montert hos Søve) | 0 | |
| Fundament Støp | | | | |
|  | Fundament Betong 70x70 lokk_bolter_brikker | 00-003-112k | 1 | |
| Overflate- montering | | | | |
|  | Fundament 70x70stolpe for Betongdekke L=180 | 00-003-145K | 1 | |

Fundamentering med betong / Foundation with concrete

- (N) Støtdempende materialer
- (EN) Impact attenuating materials
- (S) Støtdåmpende material Ref NS-EN 1176-1 §4.2.8.5



- (N) Bakkenivå
- (EN) Ground level
- (S) Marknivå

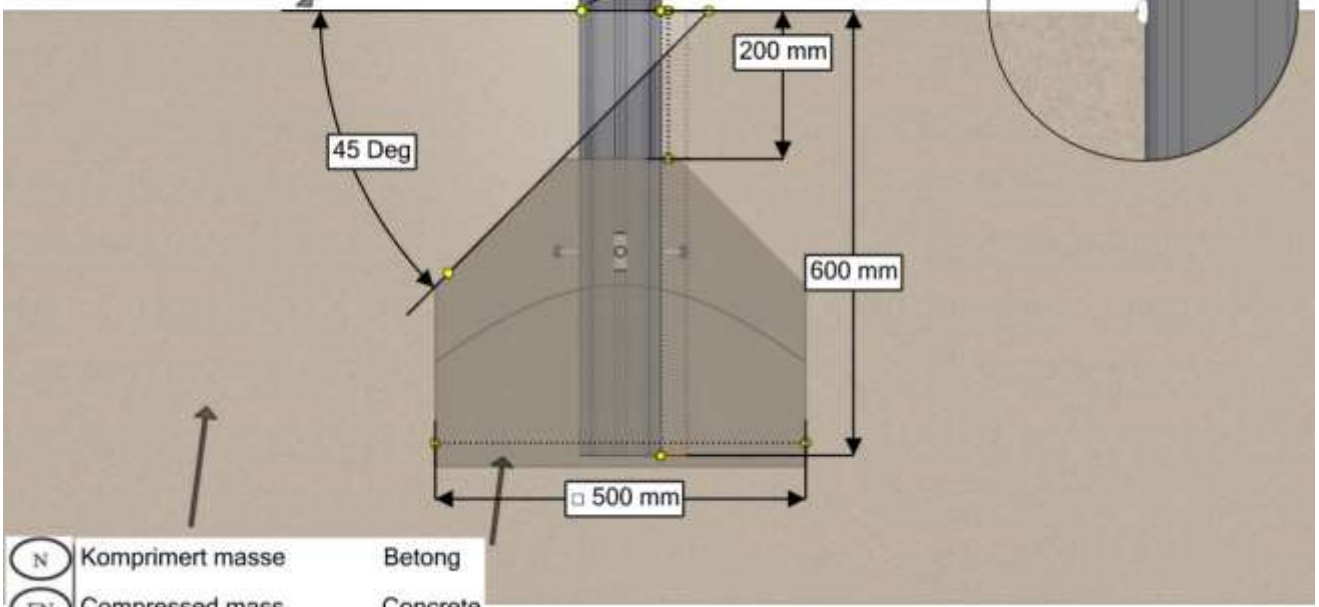

- (N) Komprimert masse Betong
- (EN) Compressed mass Concrete
- (S) Komprimerad massa Betong

Ref NS-EN 1176-1 §4.2.8.5

- (N) Bakkenivå
- (EN) Ground level
- (S) marknivå

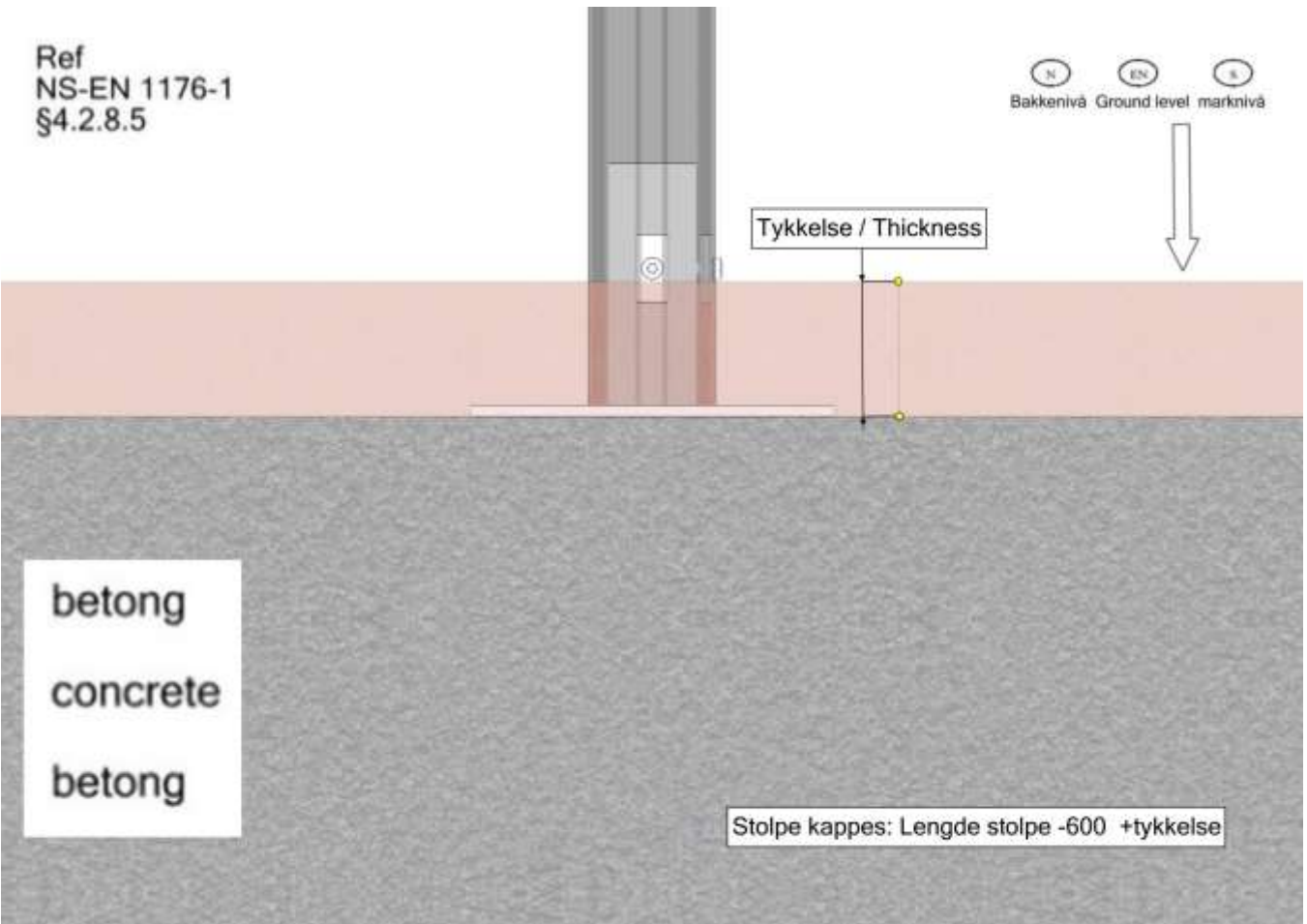

| | | | | |
|----|--|---|--|----|
| NO | Betongkvalitet | C25/30 | | |
| SE | Betongkvalitet | | | |
| EN | Concrete quality | | | |
| NO | Mengde betong | 0,15 | m ³ | |
| SE | Mängd betong | | | |
| EN | Amount of concrete | | | |
| NO | Fundament størrelse | 0,5 x 0,5 x 0,6 | m | |
| SE | Stiftelsestorlek | | | |
| EN | Foundation size | | | |
| NO | For sikkerhet må fundamentene med sand eller myk jord være minst 50% større i areal | | | |
| SE | För säkerheten måste grunden med sand eller mjuk jord vara minst 50% större i området | | | |
| EN | For safety, the foundations with sand or soft soil must be at least 50% larger in area | | | |
| NO | Tyngste element | SFA5123/1 | 2,6 | Kg |
| SE | Tyngsta element | | | |
| EN | Heaviest element | | | |
| NO | Største element | SFA5123/1 | 0,9 x 0,1 x 0,1 | m |
| SE | Största element | | | |
| EN | Biggest element | | | |
| N | Bolten skrues HELT igjennom aluminiumen. Maks moment: 30Nm | | | |
| | EN | The bolt must be tightened in to the post, so that it peirces the aluminium Max torque: 30Nm | | |
| | | S | Bulten skuvas HELT genom aluminiumen. Maks vridmoment: 30Nm | |

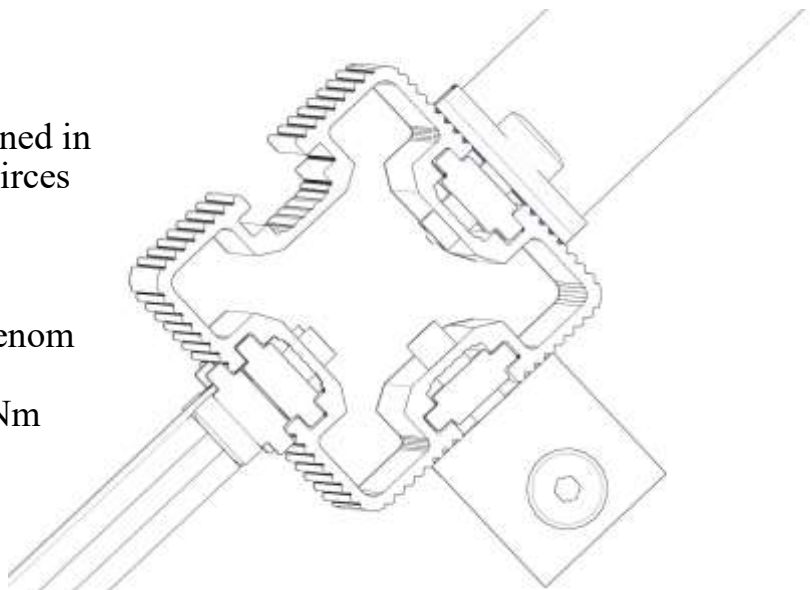

Fallhøyder / Free height of fall / Fallhöjder

Fallhøyde = 0,3 meter

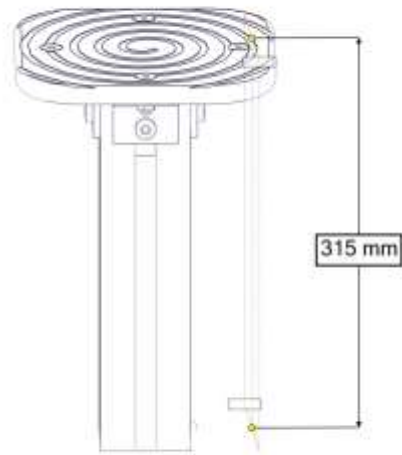
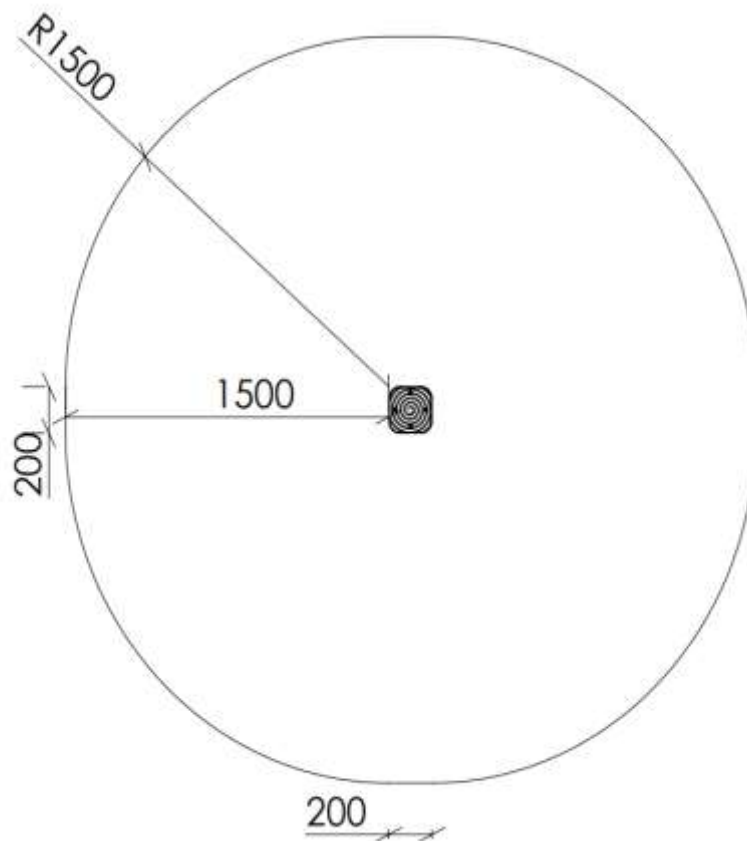
**Sikkerhetssone / Safety zone / Säkerhetszon**

Montering av lekeapparatet / Assembly instructions / Montering av lekredskapet

Se separat delmontering for detaljer
 See separate assembly for details
 Se separata delmontering för detaljer



| PartName | Artnr | Antall |
|----------------------------|-------------|--------|
| Betongfundament 70x70 | 00-003-112K | 1 |
| Stolpe 70x70 600-300 L=900 | SFA5123/1 | 1 |

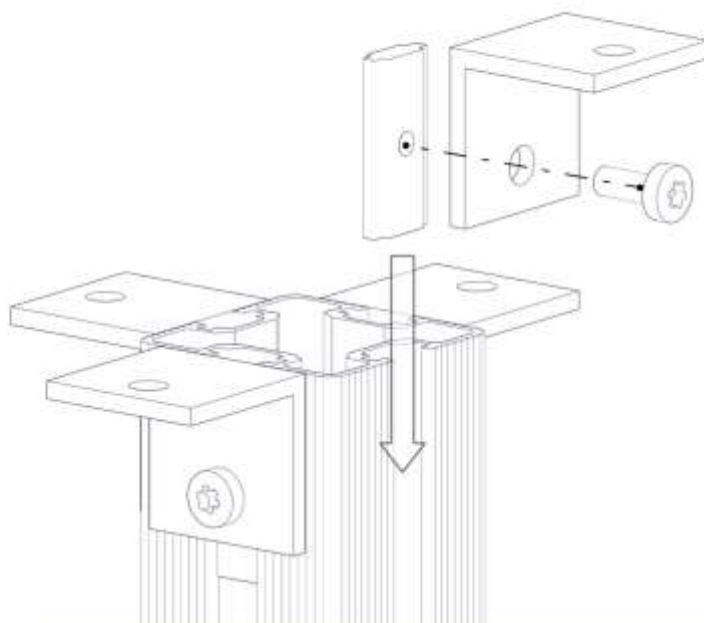

| PartName | Artnr | Antall |
|-----------------------------|------------|--------|
| Brikke 50 1XM8 | 04-060-050 | 4 |
| Torx M8x20 | 04-000-020 | 4 |
| Vinkel 50x50x50x5 11mm hull | 04-070-050 | 4 |

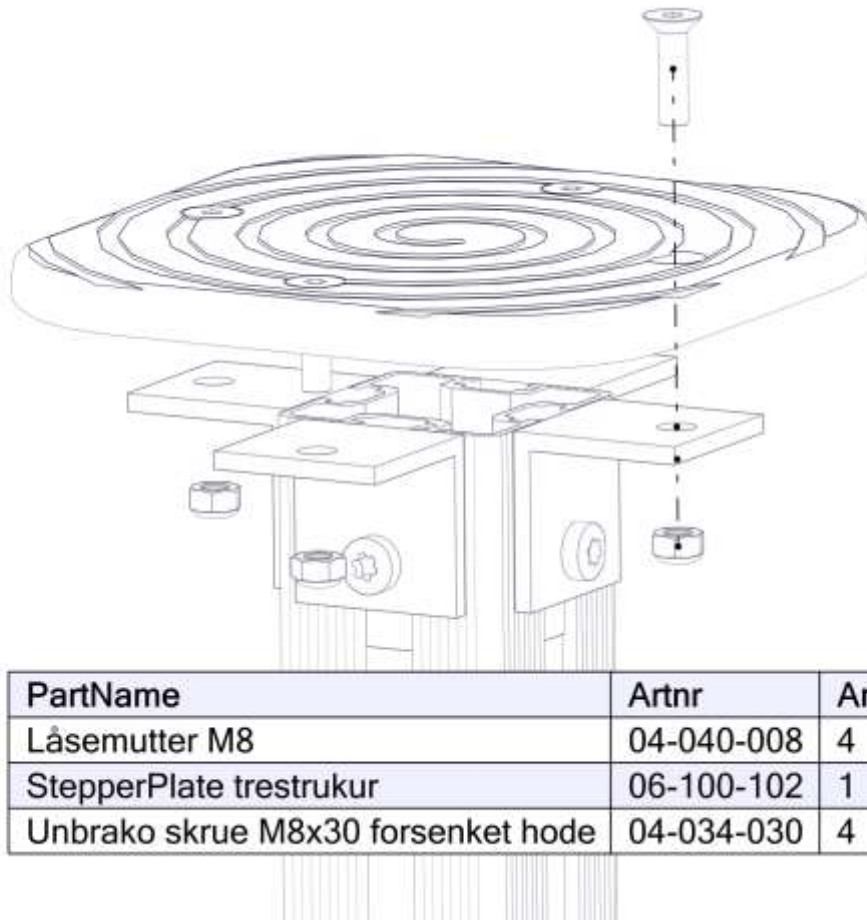

Montering av lekeapparatet / Assembly instructions / Montering av lekredskapet



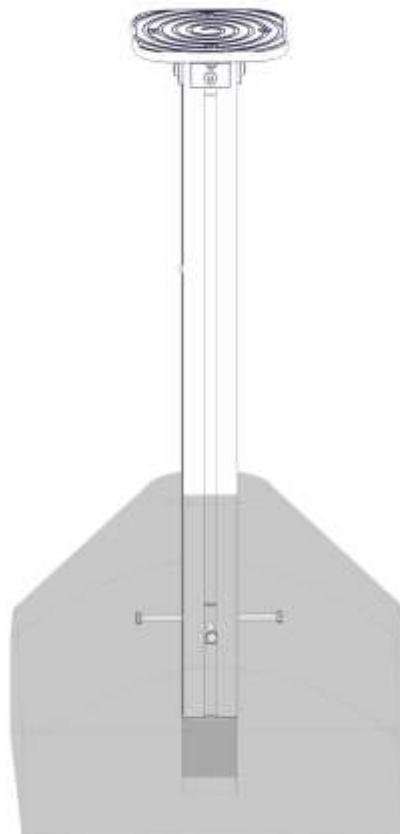





| PartName | Artnr | Antall |
|------------------------------------|------------|--------|
| Låsemutter M8 | 04-040-008 | 4 |
| StepperPlate trestruktur | 06-100-102 | 1 |
| Unbrako skrue M8x30 forsenket hode | 04-034-030 | 4 |

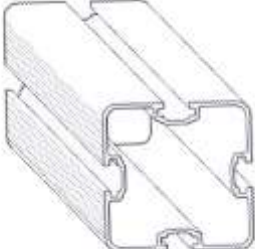
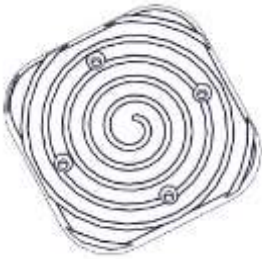
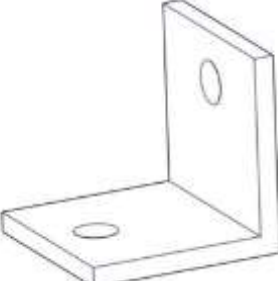

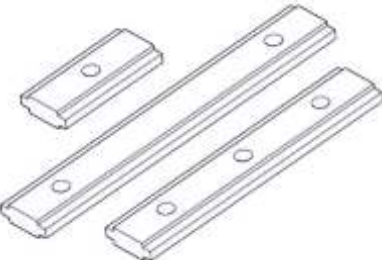
Må støpes
Må gjutes
Use concret

| Før utstyret tas i bruk / Before play begins / Innan lekredskapet tas i bruk | |
|---|--|
|  | <ul style="list-style-type: none"> ● Påse at fallunderlag er utlagt i henhold til gjeldende regler eller vår anbefaling ● Fjern alle monteringshjelpemidler (rester av betong, planker, paller, plast, og lignende) ● Før utstyret tas i bruk, burde man sjekke at det ikke er fare for at anorakksnorer og lignende som kan hekte seg fast noen steder på lekeapparatet. (Vedlagte snor med dobbe (kneledd) kan brukes til å sjekke at dette er i orden. Se vedlagte veiledning for bruk av denne. Dette gjøres for å oppdage eventuelle feilmonteringer.?) ● NB! Bor stå i 2-3 dager før bruk |
|  | <ul style="list-style-type: none"> ● Make sure the area and depth of safer surfacing are according to the current standard, or to the manufacturer's recommendation ● Make sure all tools and surplus materials are removed before play begins ● PS! When complete, allow 2-3 days for the concrete to set before use |
|  | <ul style="list-style-type: none"> ● Kontrollera att fallunderlag är utlagt enligt gällande regler eller vårt rekommendation ● Ta bort alla monteringshjälpmedel (rester av betong, plankor, pallar, plast och liknande) ● Innan lekredskapet används, kontrollera att anoracksnoddar eller kläder/delar av kläder eller liknande inte kan fastna i några delar på redskapet. (Den bipackade "knävringen" kan man med fördel användas för denna kontroll. ● Detta görs för att upptäcka eventuella felmonteringar.) |

| Boltepakker for / Boltpackage for / Bultpaket för | | Sign. _____. | | |
|---|---|-----------------------------|------------|------------|
| Stepper 300mm Trestruktur, 30-191-112 | Navn | Artnr/ dimensjon | Ant | Lev |
|  | Stolpe 70x70 L=900 (600-300) Sort | SFA5123/1 | 1 | |
|  | Stepper plate 200x200x15 Trestruktur | 06-100-102 | 1 | |
|  | Vinkel 50x50x50x5mm 11mm hull | 04-070-050 | 4 | |
|  | Torx M8x20 | 04-000-020 | 4 | |
|  | Brikke alu 50x8x23 m/ 1hull | 04-060-050 | 4 | |
|  | Mutter M8 Låsemutter | 04-040-008 | 4 | |

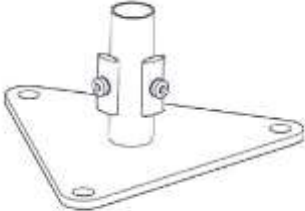
| Boltepakker for / Boltpackage for / Bultpaket för | | Sign. _____ | | |
|---|--|-------------------------------------|------------|------------|
| Stepper 300mm Trestruktur, 30-191-112 | Navn | Artnr/ dimensjon | Ant | Lev |
|  | Unbrako skrue M8x30 Forsenket hode | 04-034-030 | 4 | |
|  | Merkesilt | 00-100-402 (montert hos Søve) | 0 | |
| Fundament Støp | | | | |
|  | Fundament Betong 70x70 lokk_bolter_brikker | 00-003-112k | 1 | |
| Overflate- montering | | | | |
|  | Fundament 70x70stolpe for Betongdekke L=180 | 00-003-145K | 1 | |