

N**Monteringsanvisning****EN****Assembly Instructions****S****Monteringsanvisning**

Produkt nr. / Product no. / Produkt nr.

30-191-115**Gul**

Ord.. nr. _____

Dato. _____

Sign. _____

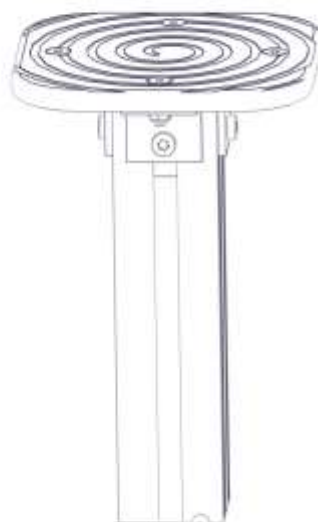

Søve AS
Grønnvoldveien 290
3830 Ulefoss - Norway
Tlf: +47 35 94 65 65
www.sove.no



Søve AB
EA Rosengrensgatan 32
421 31 Västra Frölunda
Phone: +46 (0)31 773 97 00
www.sove.se

Monteringstips / Assembly Advice / Monteringsstips

N

- Les monteringsanvisningen nøye før montering.
- Monter elementene i rekkefølgen som vist.
- Boltene bør ikke skrues for hardt til før alt er montert, vatret og loddet. Skru så boltene til.
- NB! Ved bruk av drill, kan boltene ryke.
- Er lekeutstyret plassert i naturlige ferdselstraséer må området sikres mot gjennomgang.
- Innspringningshinder bør vurderes rundt lekeapparater hvor det er stor bevegelse, f.eks. ved huskestativ.
- Det bør være fritt innsyn til lekeutstyr som er beregnet for barn under 3 år.

NB! Under monteringsarbeidet må utstyr, som ikke er forankret forsvarlig i bakken, sikres slik at det ikke velte.

Området må avstenges under montering av apparatene med sperrebånd eller lignende.

EN

- Read the instruction carefully before assembling the play unit..
- Assemble the components in the sequence shown in these instructions.
- Fixings must not be fully tightened during assembly. Before casting the foundations, the structure must be level and plumb, at which point all fixings are tightened.
- PS! If use of drill, the bolts may be wrecked.
- Secure the construction-area to prevent people from walking through it.
- Consider installing barriers around play-equipment which gives rise to a lot of activity – i.e.swings.
- Ensure that clear vision is possible across the play area so that supervision is possible from any position, particularly where children under 3 years of age will be playing.

NB! During assembly of the equipment, ensure that all structures are securely propped, especially when left overnight. Also ensure that equipment is supported whilst concrete foundations are setting and enclose the area securely to prevent access.

Monteringstips / Assembly Advice / Monteringsstips

S

- Läs monteringsanvisningen noga före montering.
- Montera delarna i den ordningen som anvisas
- Skruvarna bör inte skruvas för hårt tills allt är monterat, i våg och lodat.







OBS! Används elektrisk skruvdragare, kan bulten gå sönder. Hårdra därför manuellt!

- Om lekplatsen placeras vid en gångväg mm bör området säkras mot genomfart av gående och cyklister.
- Insprängningshinder bör placeras runt lekutrustning med stor rörelse, t ex, gungställning.
- Det bör vara fri insyn till lekutrustning beräknat till barn under 3 år.

OBS! Under monteringsarbete bör utrustningen som inte ska förankras i marken, ställs så att den inte kan välta.

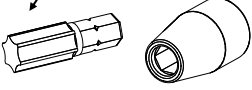
Området måste spärras när lekutrustningen byggs upp, med avspärrningsband eller liknande.

Nødvendig verktøy / Tools required / Nödvändiga verktyg





<p>(N)</p> <p>(EN)</p> <p>(S)</p>	<p>(A)</p> 	<p>(B)</p>  <p>Torx Nr 45 High quality</p>	<p>(C)</p>	<p>(D)</p> 	<p>(E)</p>
		<p>Metermål</p> <p>Metric measure</p> <p>Tumstock</p> 	<p>16 V</p> 	<p>Merkebånd</p> <p>Mark ribbon</p> <p>Märkeband</p> 	

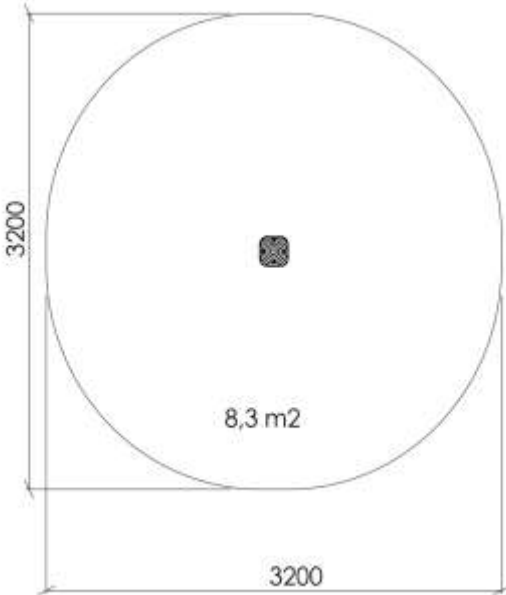

Nødvendig antall personer / Number of persons required / Rekommenderad antal personer

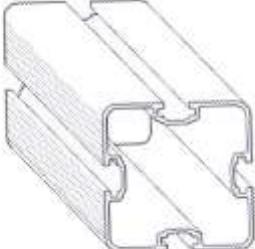
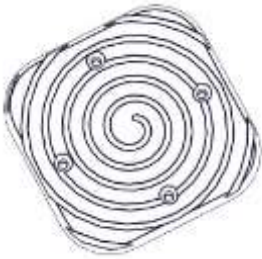
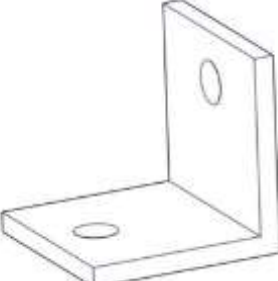
<p>(N)</p> <p>(EN)</p> <p>(S)</p>	
-----------------------------------	---

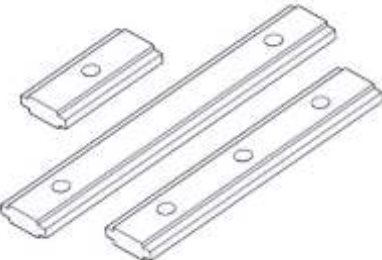
Anbefalt arealbehov ved montering / Recommended working space / Rekommenderad arealbehov vid montering

<p>(N)</p> <p>(EN)</p> <p>(S)</p>	
-----------------------------------	--

Boltepakker for / Boltpackage for / Bultpaket för		Sign. _____.		
Stepper 300mm Gul, 30-191-115	Navn	Artnr/ dimensjon	Ant	Lev
	Stolpe 70x70 L=900 (600-300) Sort	SFA5123/1	1	
	Stepper plate 200x200x15 Gul	06-100-105	1	
	Vinkel 50x50x50x5mm 11mm hull	04-070-050	4	
	Torx M8x20	04-000-020	4	
	Brikke alu 50x8x23 m/ 1hull	04-060-050	4	
	Mutter M8 Låsemutter	04-040-008	4	

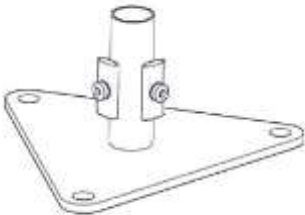
Boltepakker for / Boltpackage for / Bultpaket för		Sign. _____		
Stepper 300mm Gul, 30-191-115	Navn	Artnr/ dimensjon	Ant	Lev
	Unbrako skrue M8x30 Forsenket hode	04-034-030	4	
	Merkesilt	00-100-402 (montert hos Søve)	0	
Fundament Støp				
	Fundament Betong 70x70 lokk_bolter_brikker	00-003-112k	1	
Overflate- montering				
	Fundament 70x70stolpe for Betongdekke L=180	00-003-145K	1	

Fundamentering med betong / Foundation with concrete

- (N) Støtdempende materialer
- (EN) Impact attenuating materials
- (S) Støtdåmpende material Ref NS-EN 1176-1 §4.2.8.5



- (N) Bakkenivå
- (EN) Ground level
- (S) Marknivå

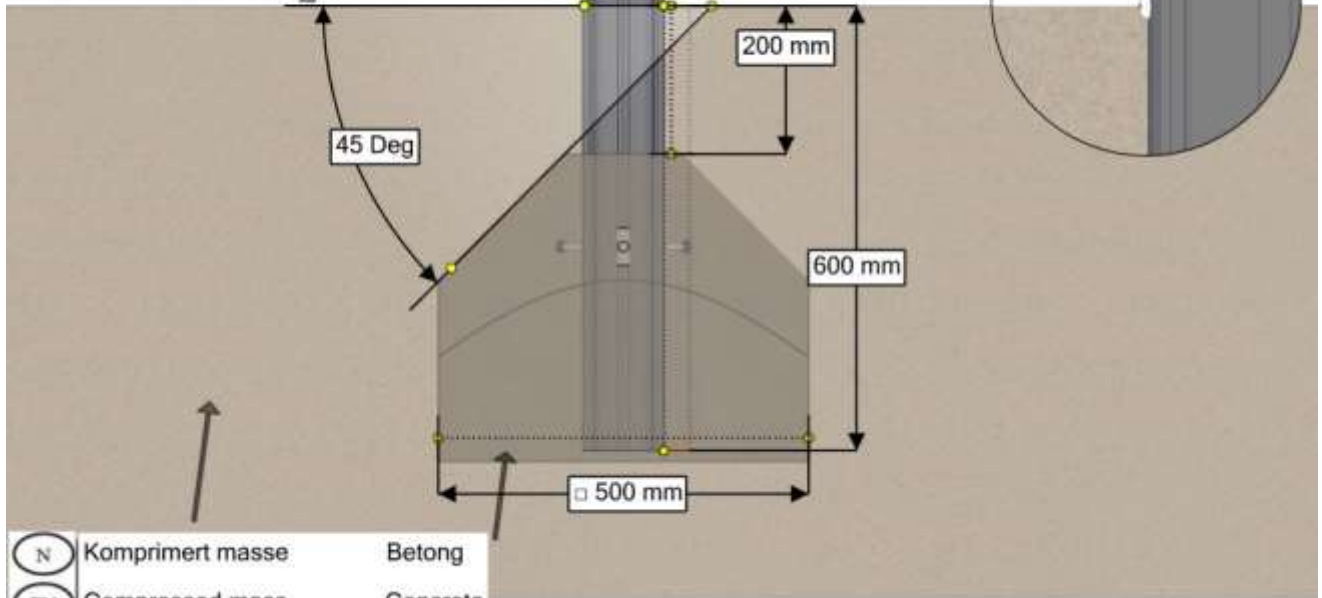

- (N) Komprimert masse Betong
- (EN) Compressed mass Concrete
- (S) Komprimerad massa Betong

Ref NS-EN 1176-1 §4.2.8.5

- (N) Bakkenivå
- (EN) Ground level
- (S) marknivå

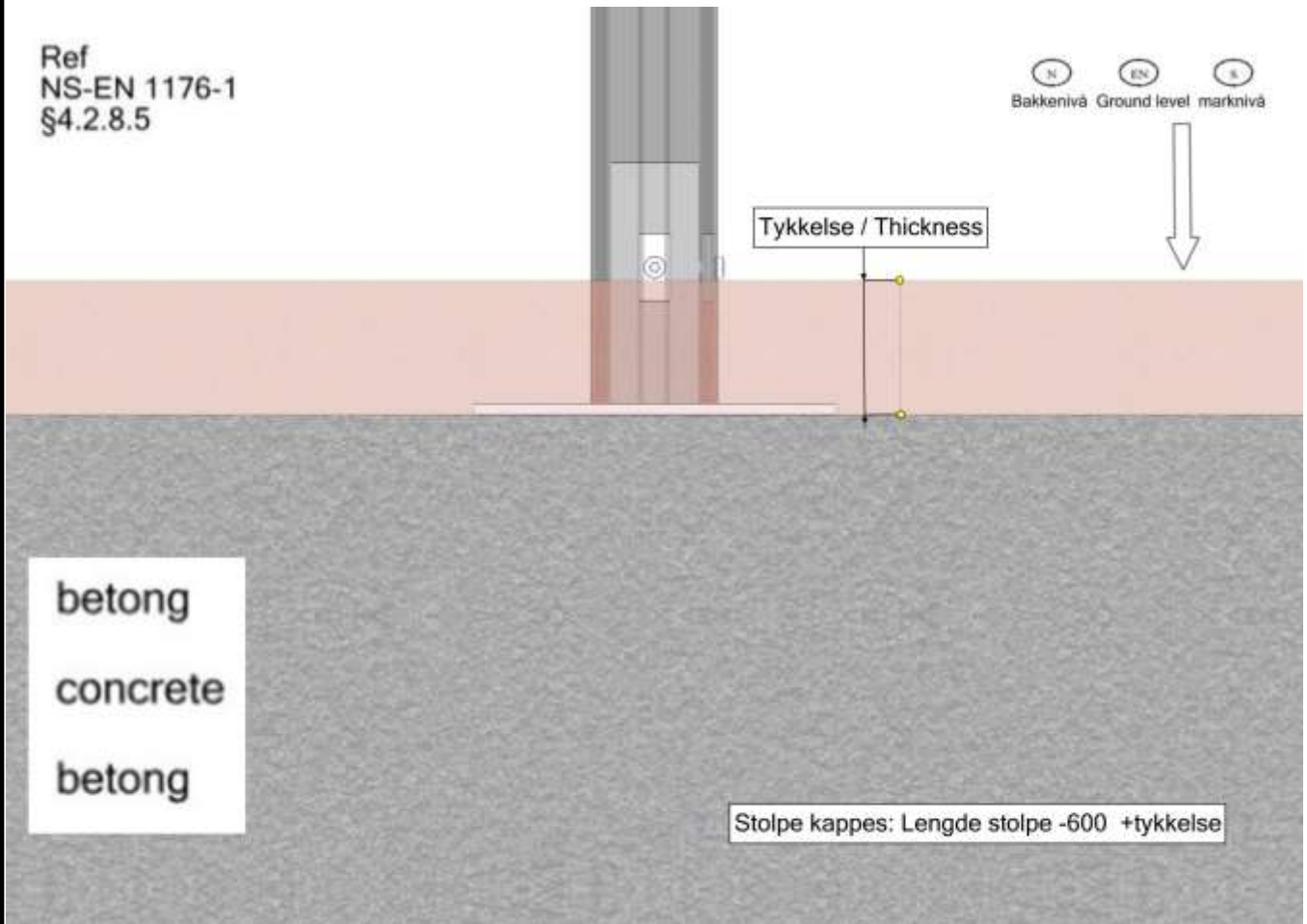

NO	Betongkvalitet	C25/30		
SE	Betongkvalitet			
EN	Concrete quality			
NO	Mengde betong		0,15	m ³
SE	Mängd betong			
EN	Amount of concrete			
NO	Fundament størrelse		0,5 x 0,5 x 0,6	m
SE	Stiftelsestorlek			
EN	Foundation size			
NO	For sikkerhet må fundamentene med sand eller myk jord være minst 50% større i areal			
SE	För säkerheten måste grunden med sand eller mjuk jord vara minst 50% större i området			
EN	For safety, the foundations with sand or soft soil must be at least 50% larger in area			
NO	Tyngste element	SFA5123/1	2,6	Kg
SE	Tyngsta element			
EN	Heaviest element			
NO	Største element	SFA5123/1	0,9 x 0,1 x 0,1	m
SE	Största element			
EN	Biggest element			
N	<p>Bolten skrues HELT igjennom aluminiumen. Maks moment: 30Nm</p>			
EN	<p>The bolt must be tightened in to the post, so that it peirces the aluminium Max torque: 30Nm</p>			
S	<p>Bulten skivas HELT genom aluminiumen. Maks vridmoment: 30Nm</p>			

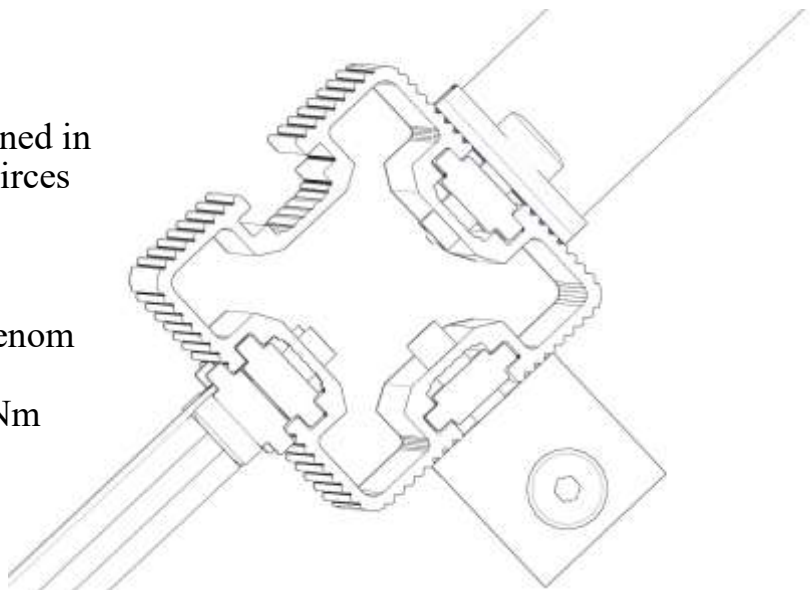

Fallhøyder / Free height of fall / Fallhöjder

Fallhøyde = 0,3 meter

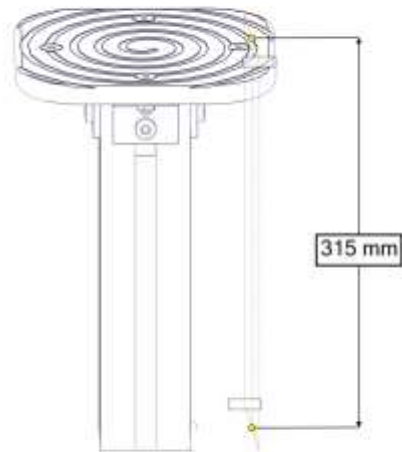
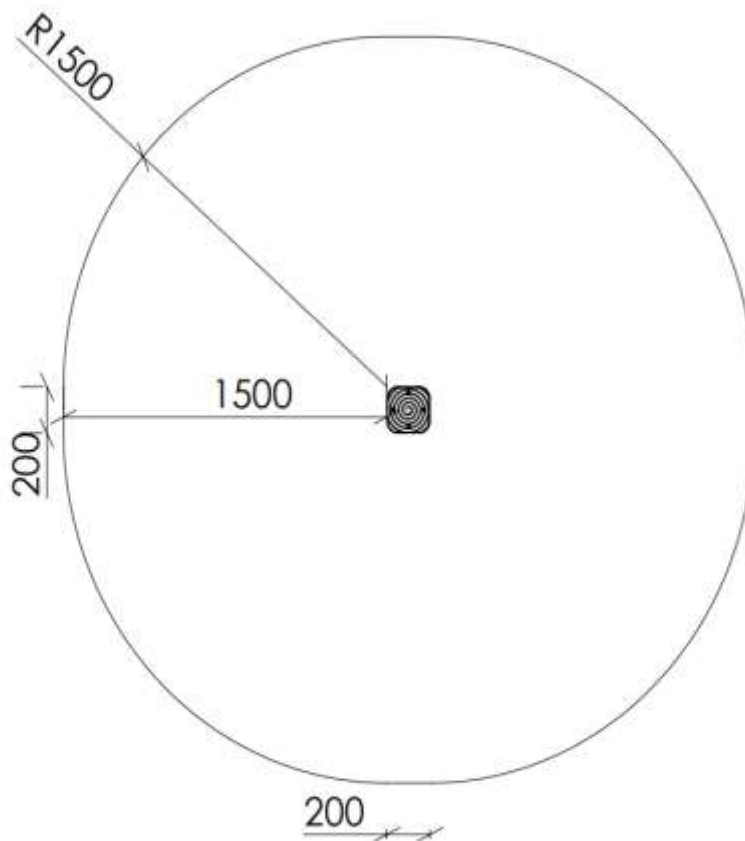
**Sikkerhetssone / Safety zone / Säkerhetszon**

Montering av lekeapparatet / Assembly instructions / Montering av lekredskapet

Se separat delmontering for detaljer
 See separate assembly for details
 Se separata delmontering för detaljer



PartName	Artnr	Antall
Betongfundament 70x70	00-003-112K	1
Stolpe 70x70 600-300 L=900	SFA5123/1	1

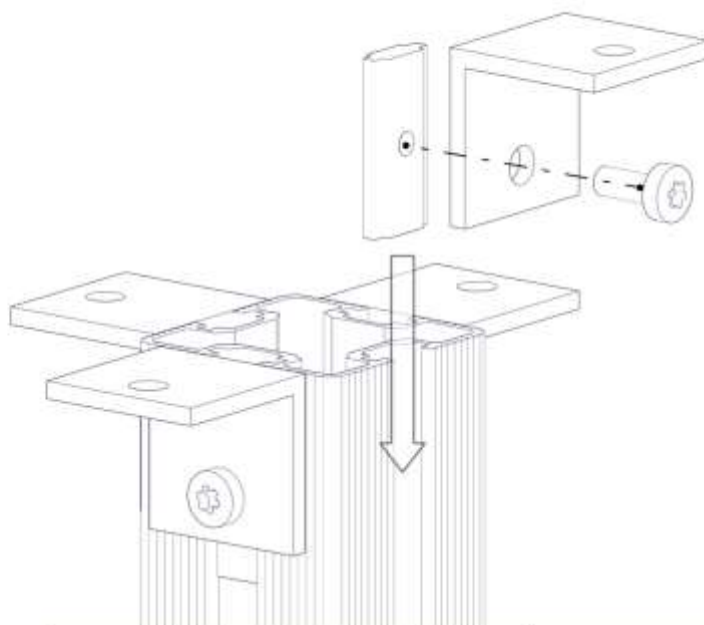

PartName	Artnr	Antall
Brikke 50 1XM8	04-060-050	4
Torx M8x20	04-000-020	4
Vinkel 50x50x50x5 11mm hull	04-070-050	4

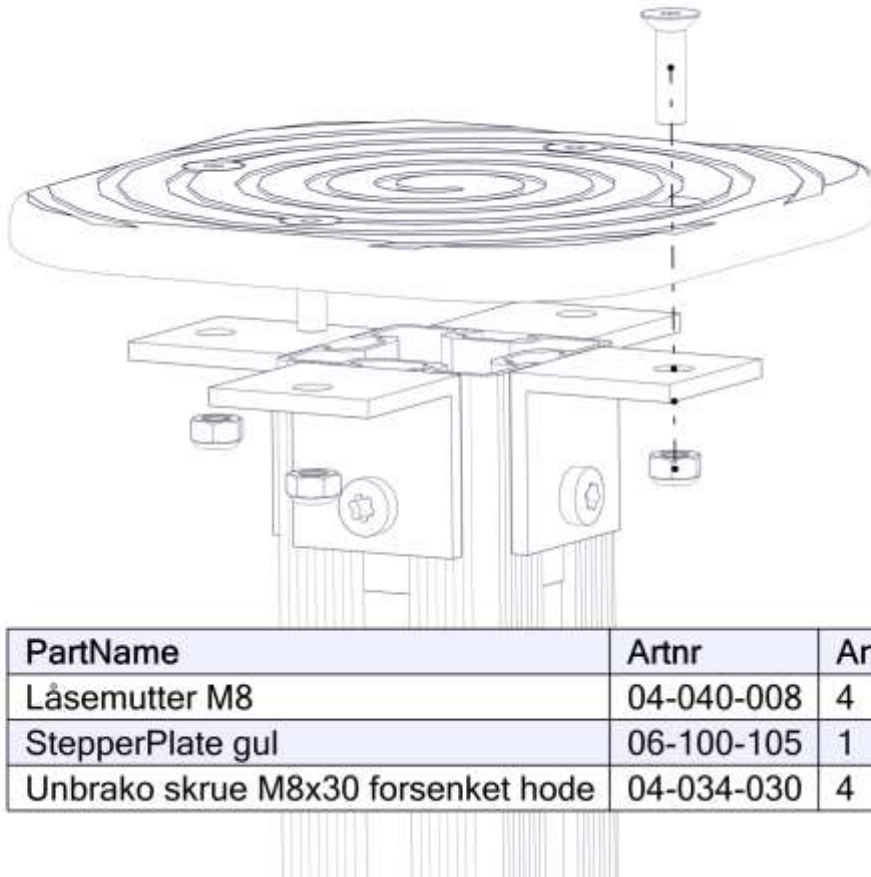

Montering av lekeapparatet / Assembly instructions / Montering av lekredskapet



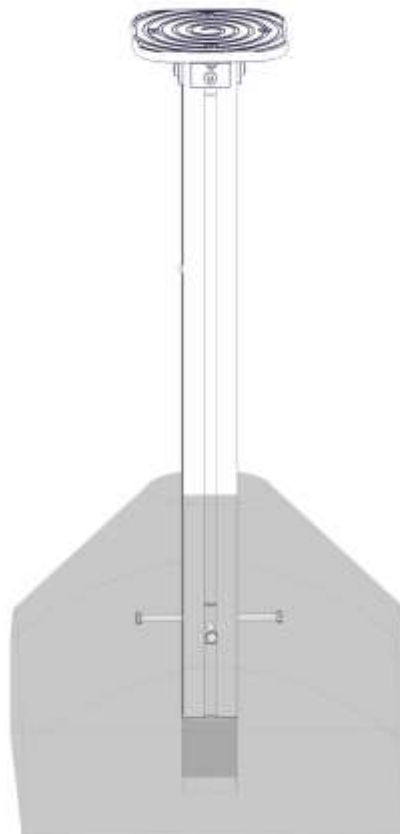





PartName	Artnr	Antall
Låsemutter M8	04-040-008	4
StepperPlate gul	06-100-105	1
Unbrako skrue M8x30 forsenket hode	04-034-030	4

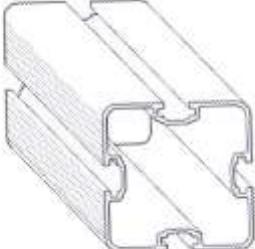
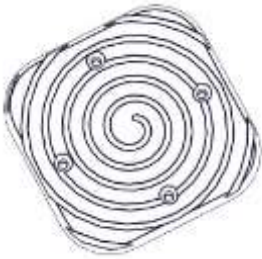
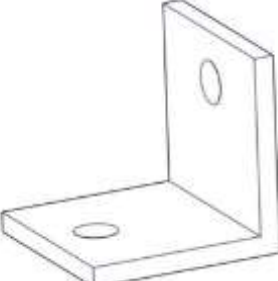

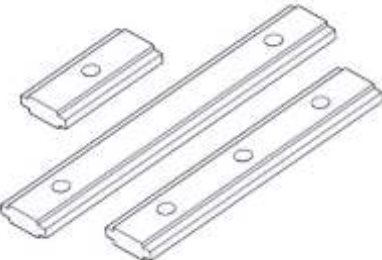
Må støpes
Må gjutes
Use concret

Før utstyret tas i bruk / Before play begins / Innan lekredskapet tas i bruk	
	<ul style="list-style-type: none"> ● Påse at fallunderlag er utlagt i henhold til gjeldende regler eller vår anbefaling ● Fjern alle monteringshjelpemidler (rester av betong, planker, paller, plast, og lignende) ● Før utstyret tas i bruk, burde man sjekke at det ikke er fare for at anorakksnorer og lignende som kan hekte seg fast noen steder på lekeapparatet. (Vedlagte snor med dobbe (kneledd) kan brukes til å sjekke at dette er i orden. Se vedlagte veiledning for bruk av denne. Dette gjøres for å oppdage eventuelle feilmonteringer.?) ● NB! Bor stå i 2-3 dager før bruk
	<ul style="list-style-type: none"> ● Make sure the area and depth of safer surfacing are according to the current standard, or to the manufacturer's recommendation ● Make sure all tools and surplus materials are removed before play begins ● PS! When complete, allow 2-3 days for the concrete to set before use
	<ul style="list-style-type: none"> ● Kontrollera att fallunderlag är utlagt enligt gällande regler eller vårt rekommendation ● Ta bort alla monteringshjälpmedel (rester av betong, plankor, pallar, plast och liknande) ● Innan lekredskapet används, kontrollera att anoracksnoddar eller kläder/delar av kläder eller liknande inte kan fastna i några delar på redskapet. (Den bipackade "knävringen" kan man med fördel användas för denna kontroll. ● Detta görs för att upptäcka eventuella felmonteringar.)

Boltepakker for / Boltpackage for / Bultpaket för		Sign. _____.		
Stepper 300mm Gul, 30-191-115	Navn	Artnr/ dimensjon	Ant	Lev
	Stolpe 70x70 L=900 (600-300) Sort	SFA5123/1	1	
	Stepper plate 200x200x15 Gul	06-100-105	1	
	Vinkel 50x50x50x5mm 11mm hull	04-070-050	4	
	Torx M8x20	04-000-020	4	
	Brikke alu 50x8x23 m/ 1hull	04-060-050	4	
	Mutter M8 Låsemutter	04-040-008	4	

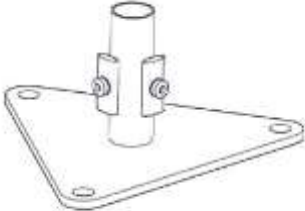
Boltepakker for / Boltpackage for / Bultpaket för		Sign. _____		
Stepper 300mm Gul, 30-191-115	Navn	Artnr/ dimensjon	Ant	Lev
	Unbrako skrue M8x30 Forsenket hode	04-034-030	4	
	Merkesilt	00-100-402 (montert hos Søve)	0	
Fundament Støp				
	Fundament Betong 70x70 lokk_bolter_brikker	00-003-112k	1	
Overflate- montering				
	Fundament 70x70stolpe for Betongdekke L=180	00-003-145K	1	