

N

Monteringsanvisning

EN

Assembly Instructions

S

Monteringsanvisning

Produkt nr. / Product no. / Produkt nr.

30-800-060**Brun / Rød**

Ord. nr. _____

Dato. _____

Sign. _____

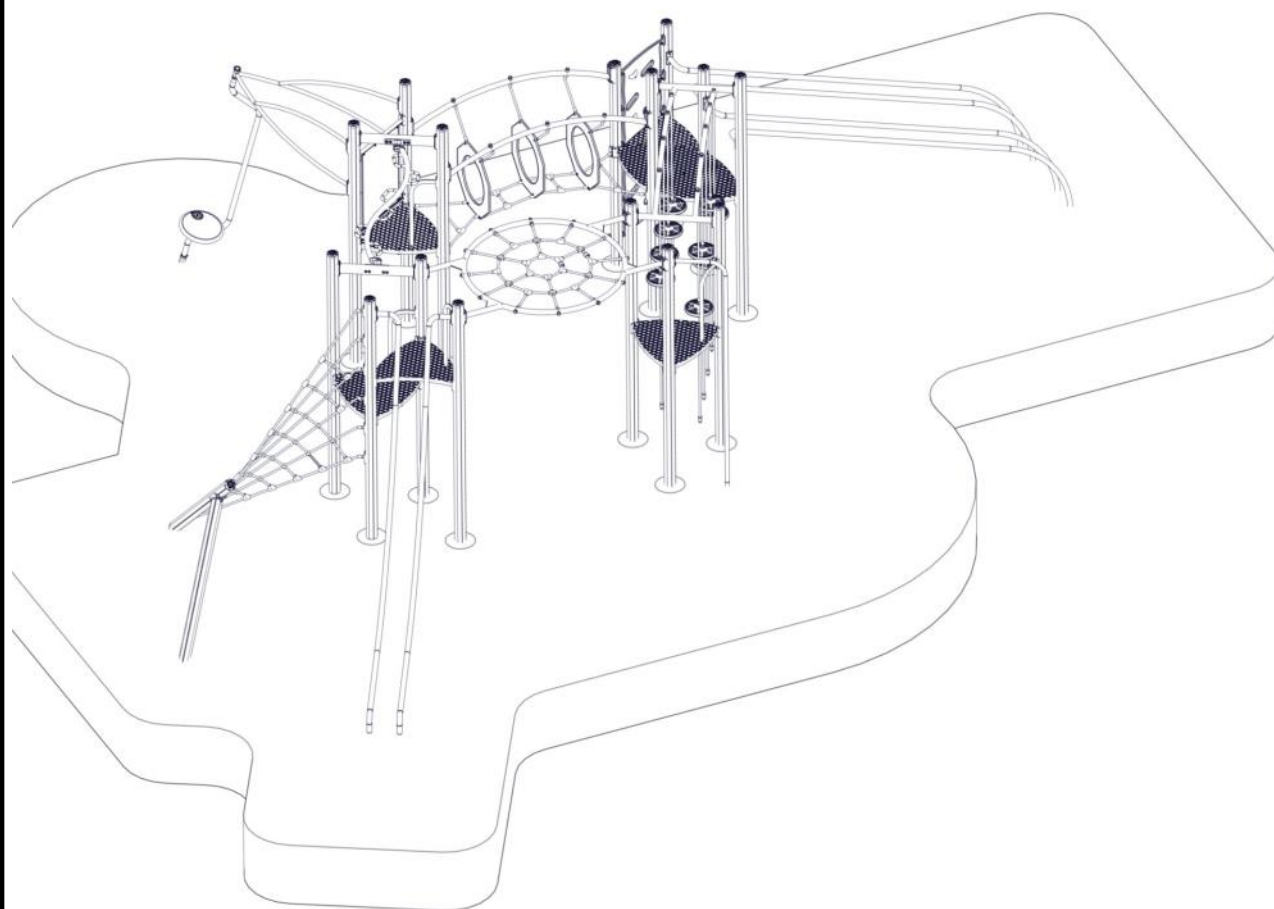
**søve**

Søve AS
Grønnvoldveien 290
3830 Ulefoss - Norway
Tlf: +47 35 94 65 65
www.sove.no

**søve**

Søve AB
EA Rosengrensgatan 32
421 31 Västra Frölunda
Phone: +46 (0)31 773 97 00
www.sove.se

Monteringstips / Assembly Advice / Monteringsstips**N**

- Les monteringsanvisningen nøye før montering.
- Monter elementene i rekkefølgen som vist.
- Boltene bør ikke skrues for hardt til før alt er montert, vatret og loddet. Skru så boltene til.
- NB! Ved bruk av drill, kan boltene ryke.
- På grunn av at solen kan gjøre rutsjeflaten veldig varm, bør rutsjebanens utløp vende mot nord-øst eller nord-vest.
- Er lekeutstyret plassert i naturlige ferdselstraséer må området sikres mot gjennomgang.
- Innspringningshinder bør vurderes rundt lekeapparater hvor det er stor bevegelse, f.eks. ved huskestativ.
- Det bør være fritt innsyn til lekeutstyr som er beregnet for barn under 3 år.

NB! Under monteringsarbeidet må utstyr, som ikke er forankret forsvarlig i bakken, sikres slik at det ikke velte.

Området må avstenges under montering av apparatene med sperrebånd eller lignende.

EN

- Read the instruction carefully before assembling the play unit.
- Assemble the components in the sequence shown in these instructions. Fixings must not be fully tightened during assembly. Before casting the foundations, the structure must be level and plumb, at which point all fixings are tightened. PS! If use of drill, the bolts may be wrecked.
- Avoid positioning the slide facing due south because of overheating – ideal positions are facing north-east or north-west. Secure the construction-area to prevent people from walking through it.
- Consider installing barriers around play-equipment which gives rise to a lot of activity – i.e. swings.
- Ensure that clear vision is possible across the play area so that supervision is possible from any position, particularly where children under 3 years of age will be playing.

NB! During assembly of the equipment, ensure that all structures are securely propped, especially when left overnight. Also ensure that equipment is supported

Monteringstips / Assembly Advice / Monteringsstips**S**

- Läs monteringsanvisningen noga före montering.

- Montera delarna i den ordningen som anvisas
- Skruvarna bör inte skruvas för hårt tills allt är monterat, i våg och lodat.









OBS! Används elektrisk skruvdragare, kan bulten gå sönder. Hårdra därför manuellt!

- Solen kan göra att rutchbanan blir väldigt varm. Banans nedfart rekommenderas att vändas i norrlig riktning
- Om lekplatsen placeras vid en gångväg mm bör området säkras mot genomfart av gående och cyklister.
- Insprängningshinder bör placeras runt lekutrustning med stor rörelse, t ex, gungställning.
- Det bör vara fri insyn till lekutrustning beräknat till barn under 3 år.

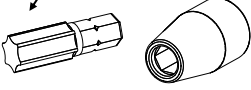
OBS! Under monteringsarbete bör utrustningen som inte ska förankras i marken, ställs så att den inte kan välta.

Området måste spärras när lekutrustningen byggs upp, med avspärrningsband eller liknande.

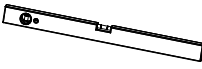
Nødvendig verktøy / Tools required / Nödvändiga verktyg

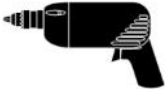
| | | | | | |
|-----------------------------------|--|---|---|--|--|
| <p>(N)</p> <p>(EN)</p> <p>(S)</p> | <p>(A)</p>  | <p>(B)</p> <p>Torx Nr 45 High quality</p>  | <p>(C)</p> <p>13 + 17mm</p>  | <p>(D)</p>  | <p>(E)</p>  |
| |  | <p>Metermål Metric measure Tumstock</p>  | <p>16 V</p>  | <p>Merkebånd Mark ribbon Märkeband</p>  | <p>5 mm 6 mm</p>  |

Nødvendig antall personer / Number of persons required / Rekommenderad antal personer

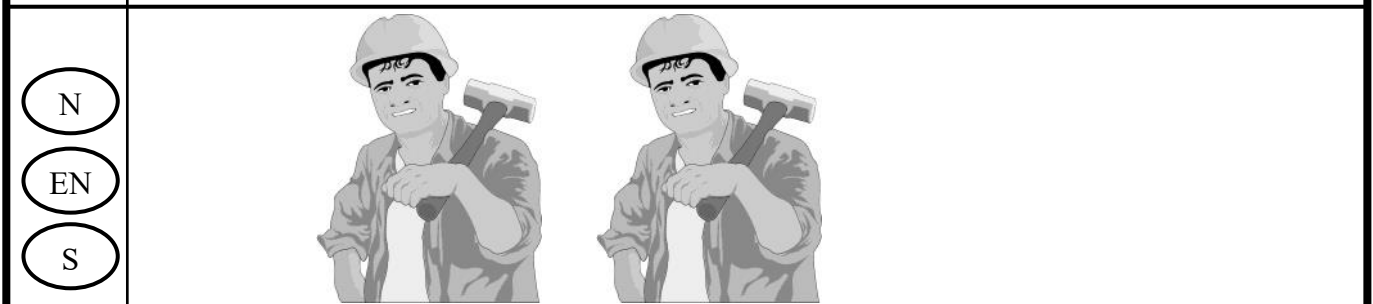



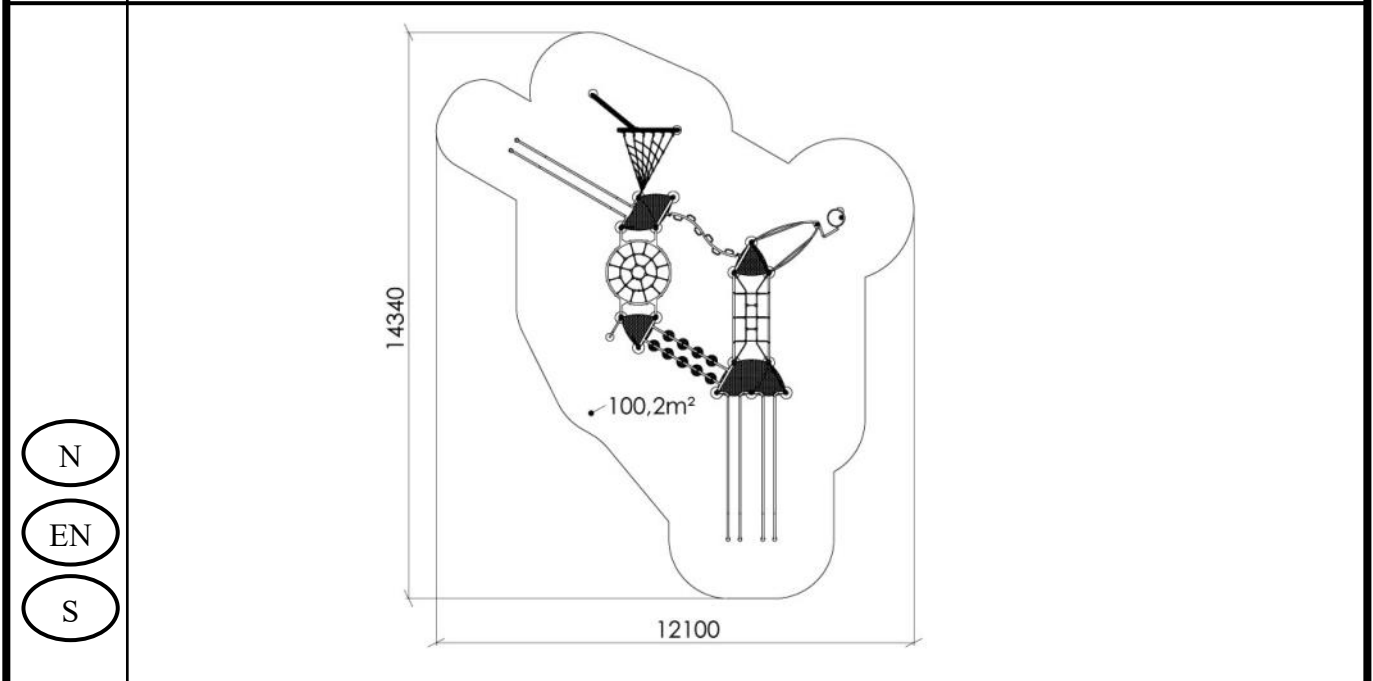



Anbefalt arealbehov ved montering / Recommended working space / Rekommenderad arealbehov vid montering

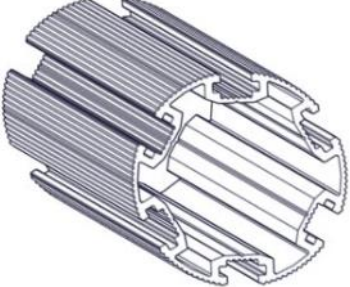

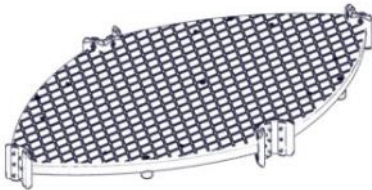
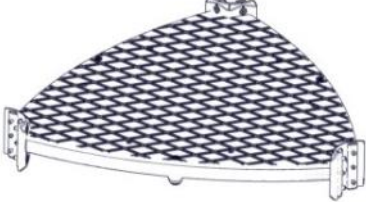
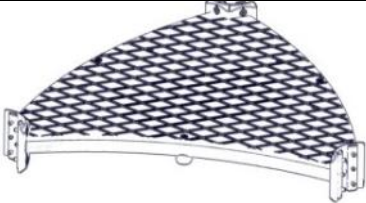
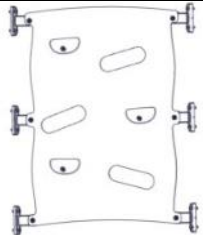

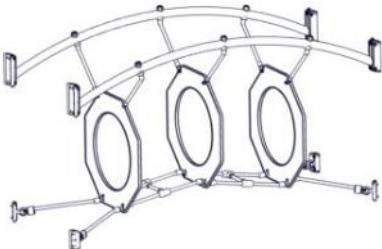
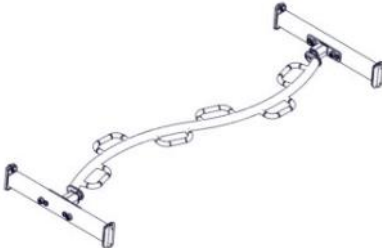
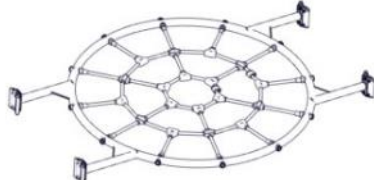

Boltepakker for / Boltpackage for / Bultpaket för

Sign. _____

| Blåhø, Brun-Rød 30-800-060 | Navn | Artnr/ dimensjon | Ant | Lev |
|---|--|--|--------------|-----|
|  | Stolpe Ø110 L=3450 (2850-600) Brun L=3100 (2500-600) Brun L=3000 (2400-600) Brun | SFA5126/1 SFA5126/1 SFA5126/1 | 12 1 2 | |
|  | Endelokk til stolpe Ø110 | 00-400-995 | 15 | |
|  | Gulv 3-kant dobbel standard Brun | 07-301-101K (Se egen del- montering) | 1 | |
|  | Gulv 3-kant standard 880 x 880 Brun | 07-300-101K (Se egen del- montering) | 4 | |
|  | Gulv 3-kant 1 konkav 880 x 880 Brun | 07-300-102K (Se egen del- montering) | 1 | |
|  | Klatreplate CC880 Rød | 07-500-470K (Se egen del- montering) | 2 | |



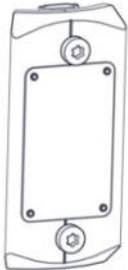

| Boltepakker for / Boltpackage for / Bultpaket för | | Sign. _____ | | |
|---|---|--|-----|-----|
| Blåhø, Brun-Rød 30-800-060 | Navn | Artnr/ dimensjon | Ant | Lev |
|  | Rekkverk 620 x 900 CC880 | 07-302-104K (se egen del- montering) | 1 | |
|  | Bro HPL plate komplett Rød | 07-500-430K (Se egen del- montering) | 1 | |
|  | Bevegelig armgang komplett Rød | 07-500-280K (se egen del- montering) | 1 | |
|  | Bro rundgang komplett CC880 L=2200 Rød | 07-200-255K (se egen del- montering) | 1 | |
|  | Slider rør 2stk komplett | 07-200-010K (se egen del- montering) | 1 | |
|  | Twistnett Inkludert beslag og stolper Rød | 07-500-443K (se egen del- montering) | 1 | |

| Boltepakker for / Boltpackage for / Bultpaket för | | Sign. _____. | | |
|---|---|--|-----|-----|
| Blåhø, Brun-Rød 30-800-060 | Navn | Artnr/ dimensjon | Ant | Lev |
|  | Sluse H= 790 komplett Rød | 07-500-062K (se egen del- montering) | 7 | |
|  | Swing CC880 komplett Rød | 07-250-000K (se egen del- montering) | 1 | |
|  | Dobbel monkeyseats bro Komplett Rød | 07-500-420K (Se egen del- montering) | 1 | |
|  | Slider rør Ivar | 07-200-011K (se egen del- montering) | 2 | |
|  | Brannstang gulv 1,9m L=3000 Grå | 07-200-037K (Se egen del- montering) | 1 | |
|  | Produktmerke | 07-500-500 (se egen del- montering) | 1 | |

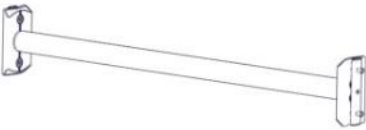
Boltepakker for / Boltpackage for / Bultpaket för

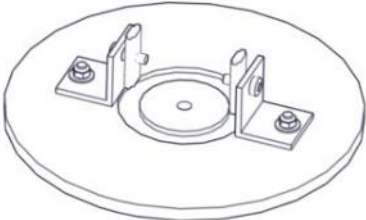
Sign. _____.

| Blåhø, Brun-Rød 30-800-060 | Navn | Artnr/ dimensjon | Ant | Lev |
|---|--|--|-----|-----|
|  | Sperrerør rett uten hull L=750 Rød | 07-500-061K (se egen del- montering) | 2 | |
| | | | | |
| | | | | |
| | | | | |
| | | | | |
| | | | | |

| Boltepakker for / Boltpackage for / Bultpaket för | | Sign. _____ | | |
|---|--|--|-----|-----|
| Blåhø, Brun-Rød 30-800-060 | Navn | Artnr/ dimensjon | Ant | Lev |
| | Nedgravnings fundament | | | |
|  | Fundamentplate for 1 x Ø110 stolpe | 07-400-101K (se egen del- montering) | 15 | |
|  | Sperrerør rett L = 750 Uten hull | 07-500-075K (se egen del- montering) | 17 | |
| | Støp fundament | | | |
|  | Støpefundament pakke Til Ø110 stolpe Bolter, brikker og lokk | 00-003-111K (se egen del- montering) | 15 | |
|  | Sperrerør rett L = 750 Uten hull | 07-500-075K (se egen del- montering) | 17 | |

Fundamentering med betong / Foundation concrete / Förankring med betong

(N) Støtdempende materialer

(EN) Impact attenuating materials

(S) Støtdämpande material Ref NS-EN 1176-1 §4.2.8.5

(N) (EN) (S)
Bakkenivå Ground level Marknivå

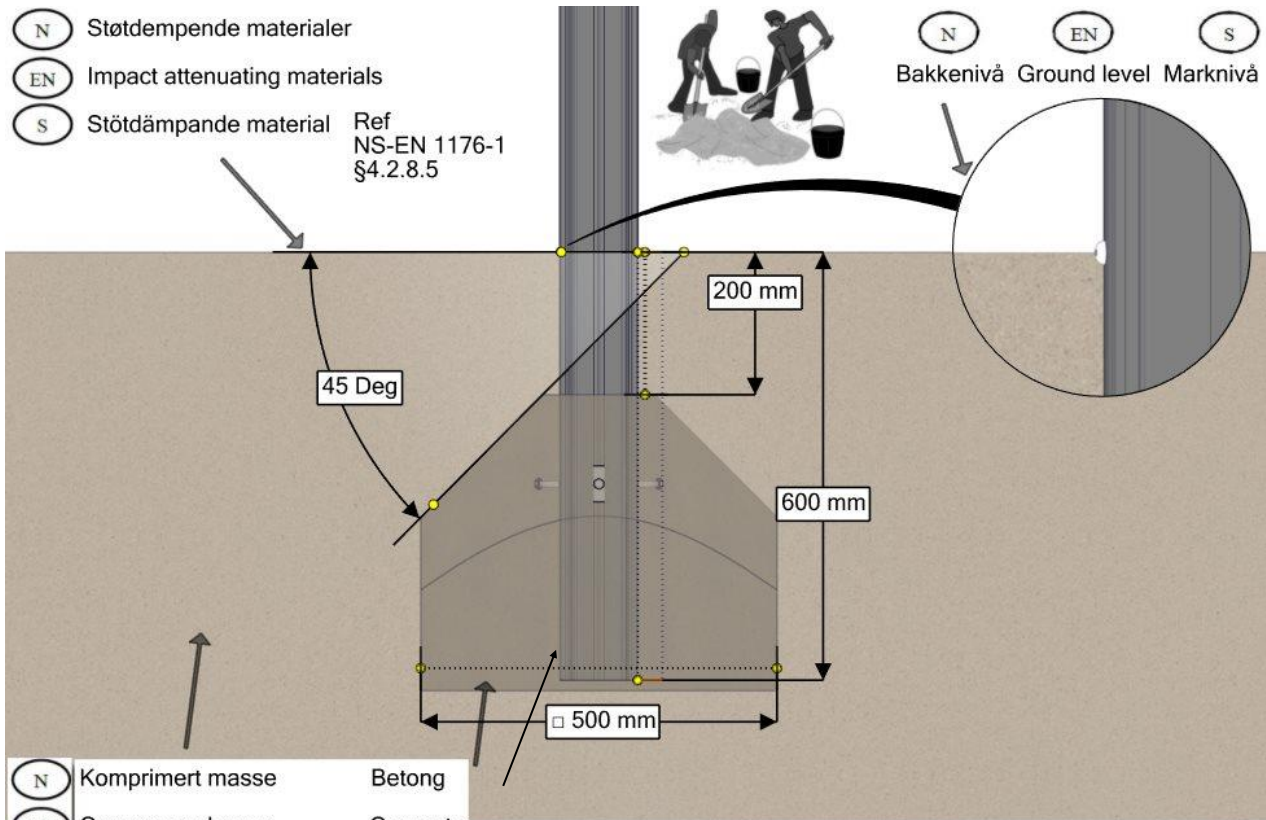

(N) Komprimert masse Betong
(EN) Compressed mass Concrete
(S) Komprimerad massa Betong

Fundamentering uten betong / Foundation without concrete / Förankring utan betong

(N) Støtdempende materialer Ref NS-EN 1176-1 §4.2.8.5
(EN) Impact attenuating materials
(S) Støtdämpande material

(N) (EN) (S)
Bakkenivå Ground level Marknivå

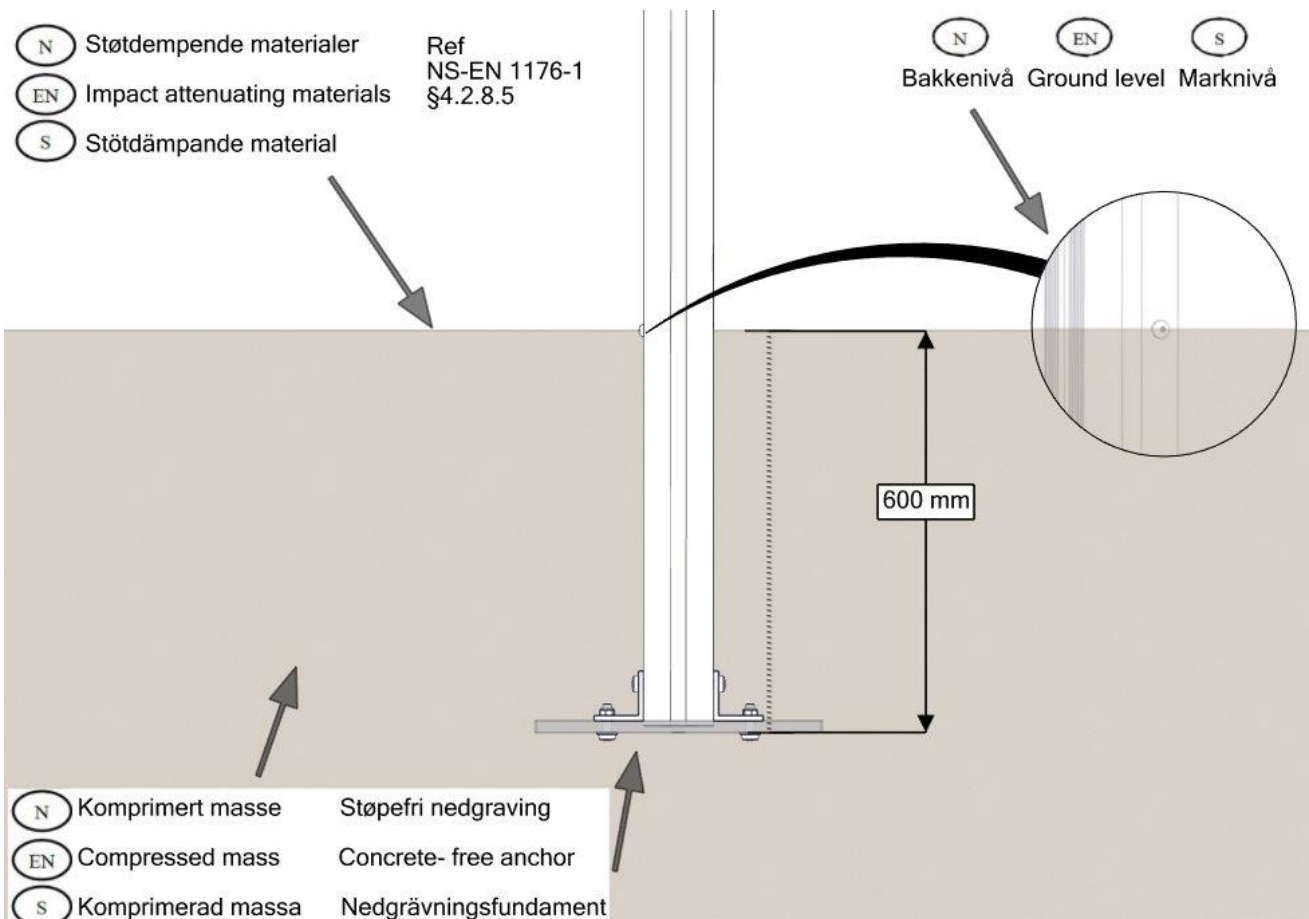

(N) Komprimert masse Støpefri nedgraving
(EN) Compressed mass Concrete-free anchor
(S) Komprimerad massa Nedgravningsfundament

N

Alle mål er oppgitt i millimeter

EN

Scale measured in mm

S

Alla mått är i millimeter.

N

Bolten skrues HELT igjennom aluminiumen.
Maks moment: 30Nm

EN

The bolt must be tightened in to the post, so that it pierces the aluminium
Max torque: 30Nm

S

Bulten skruvas HELT igjennom aluminiumen.
Maks vridmoment: 30Nm

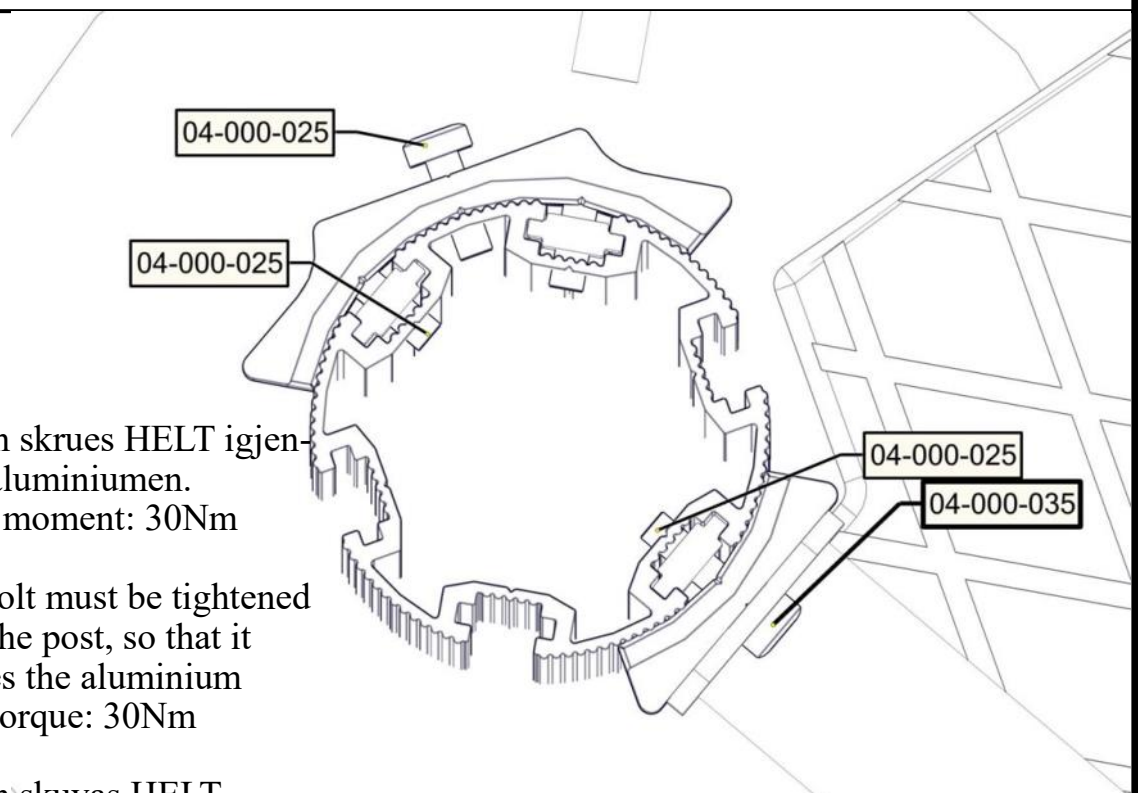

Fallhøyder / Free height of fall / Fallhöjder

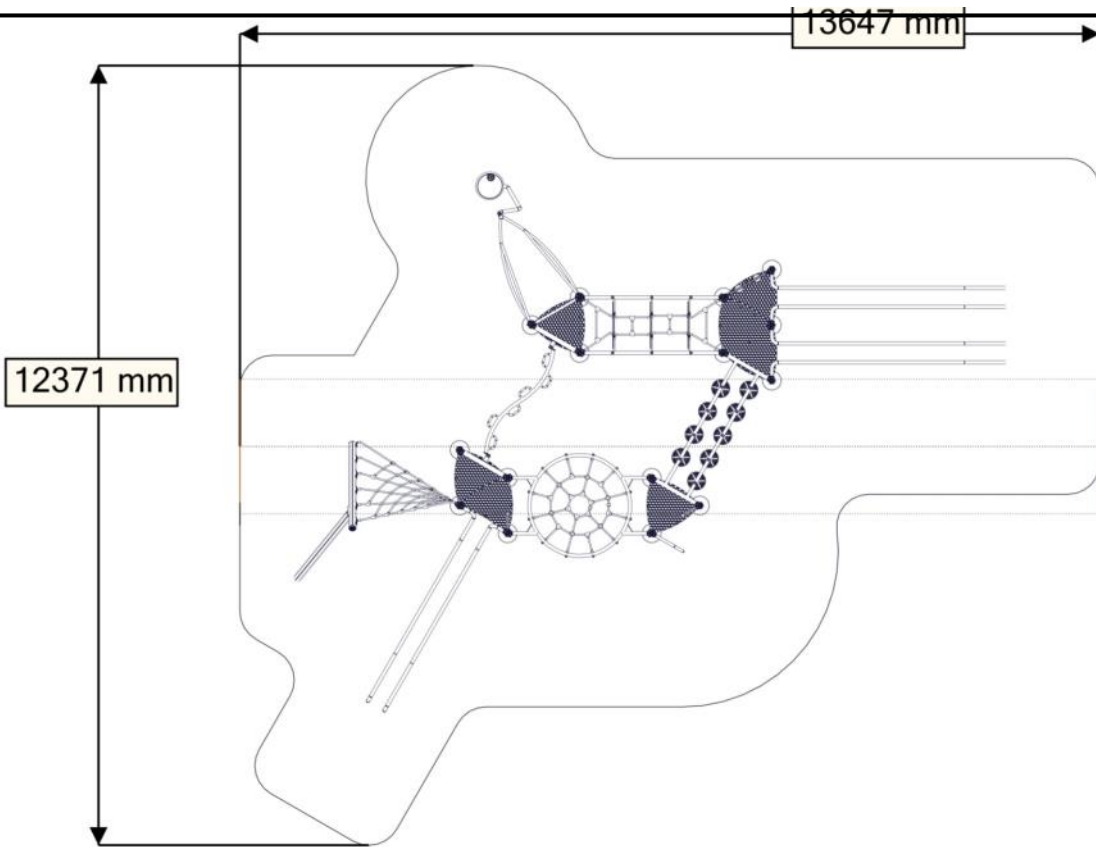

Sikkerhetszone / Safety zone / Säkerhetszon

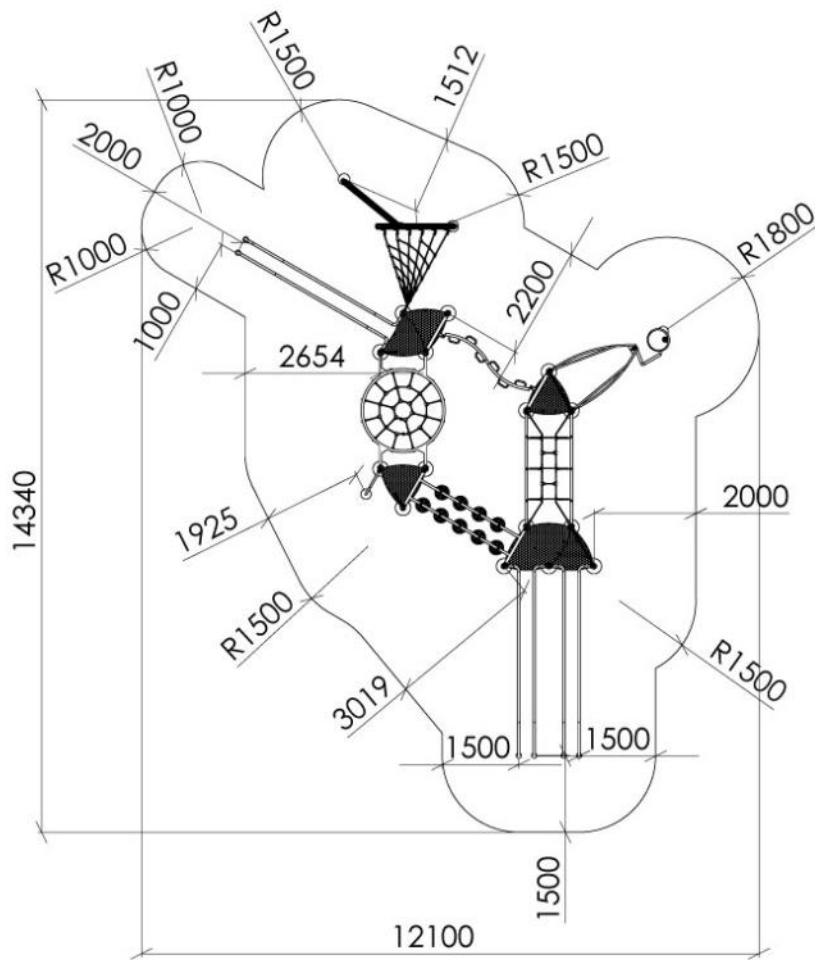

Plassering av forankringer / Ground plan / Placering av förankringar

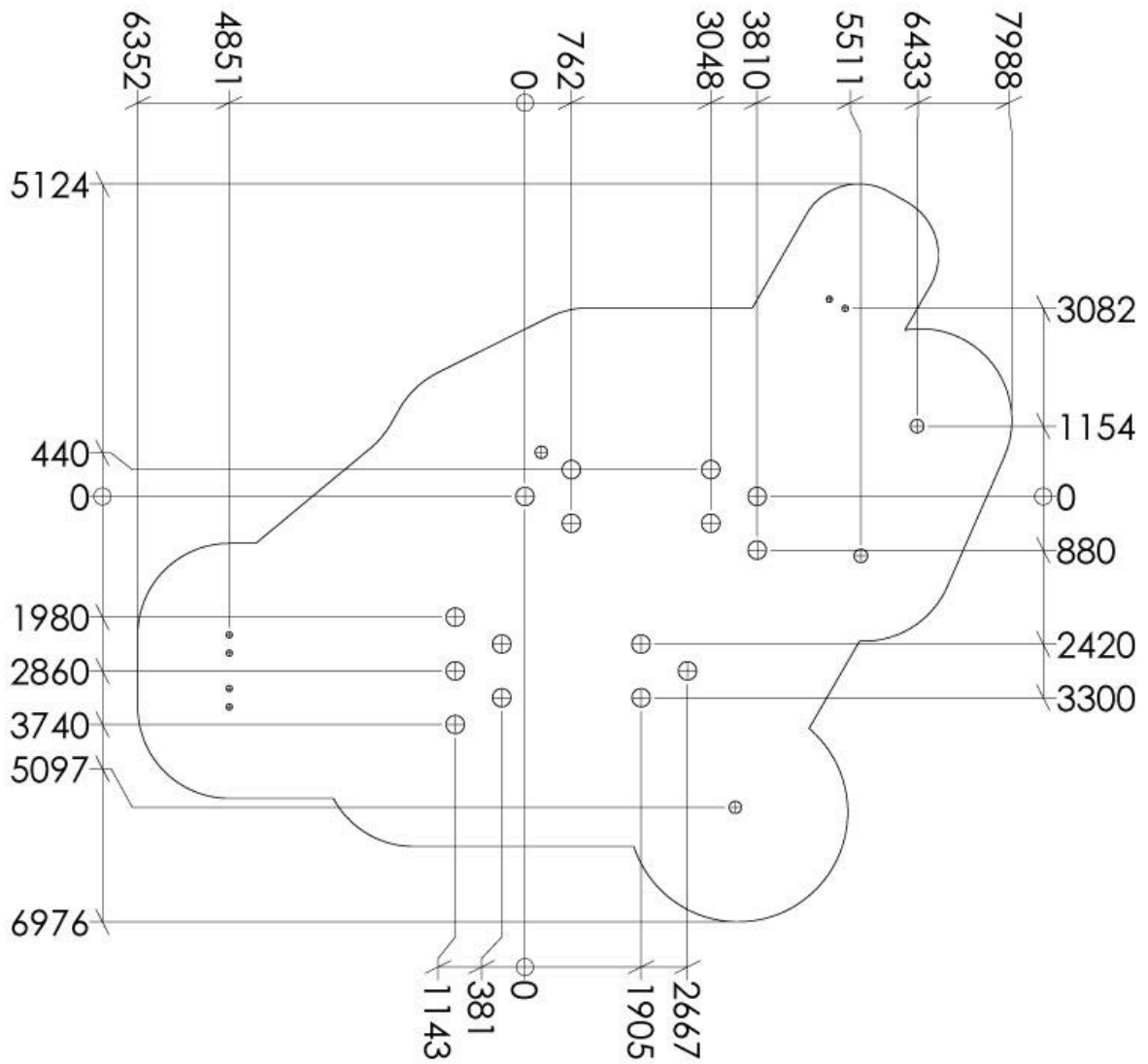

Montering av lekeapparatet / Assembly instructions / Montering av lekredskapet

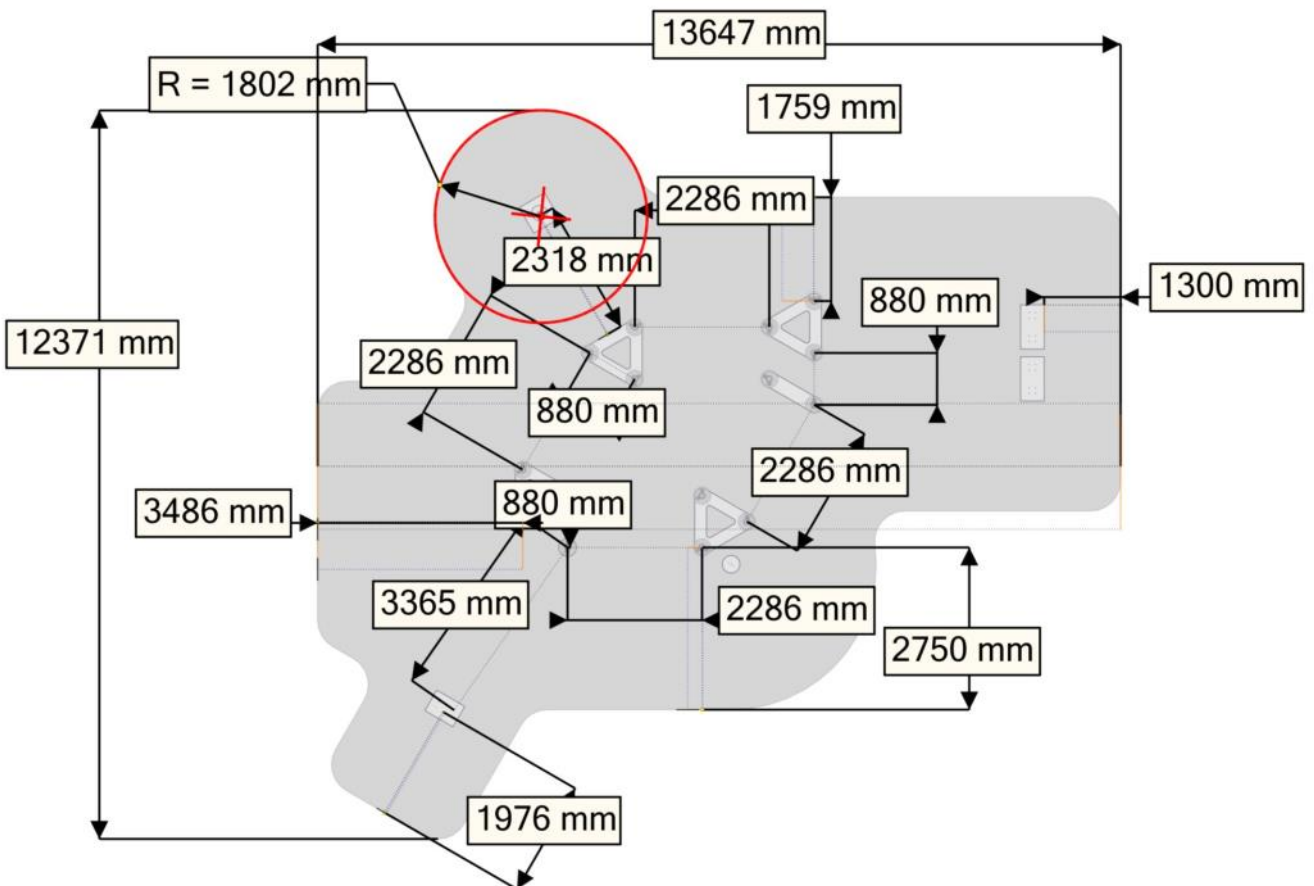
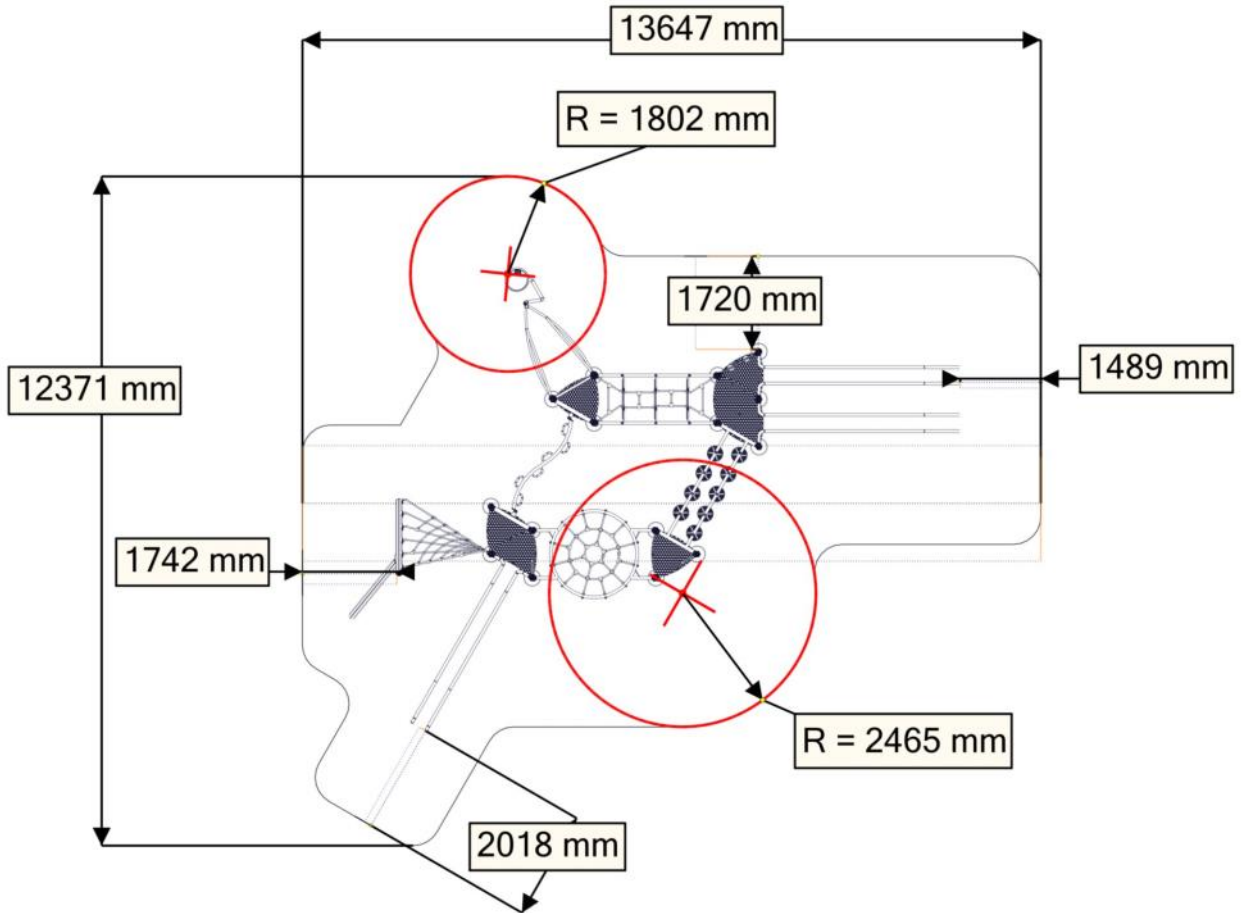

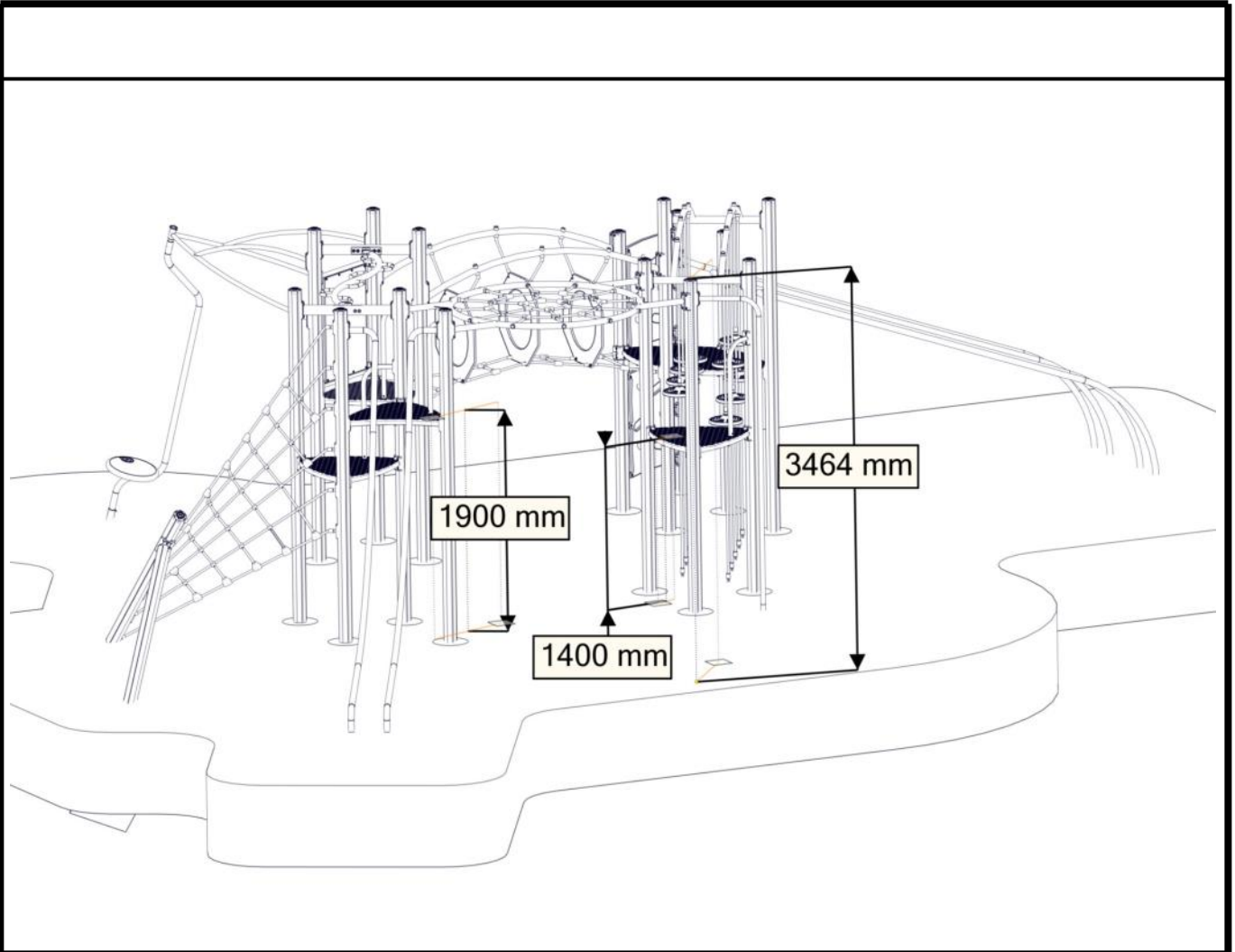

Brikke montert hos Søve

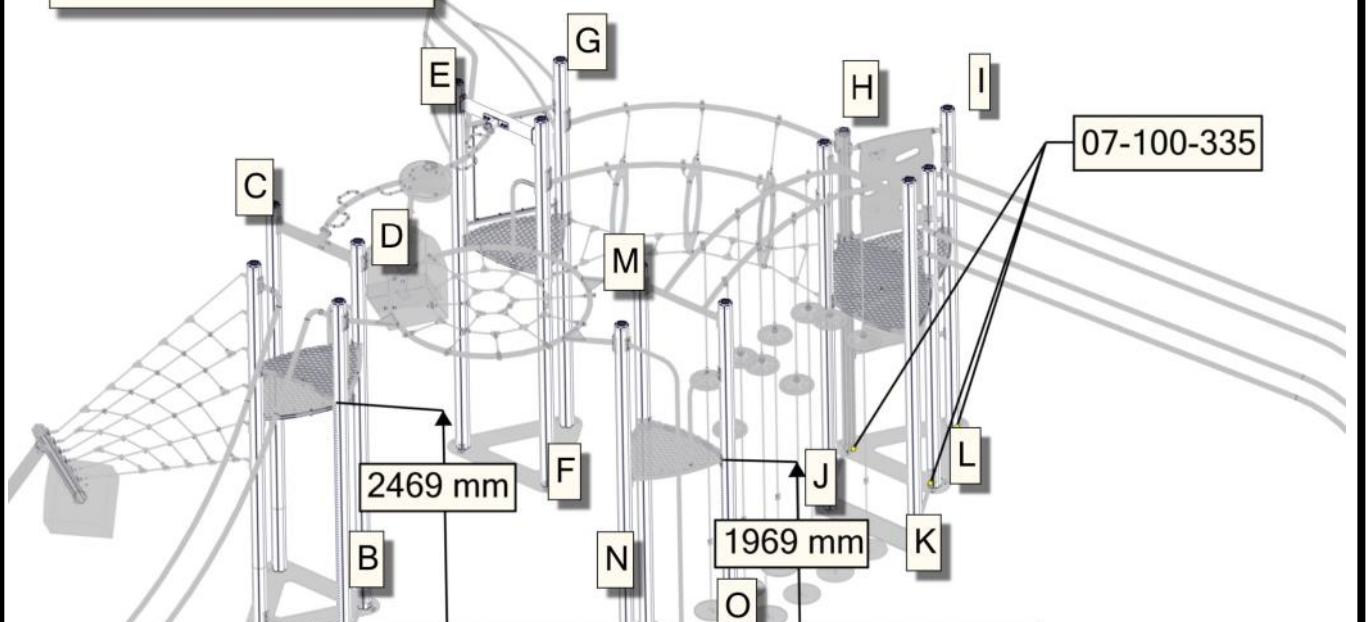

| nr | PartName (config) | Artnr (config) | Antall |
|----|-------------------|----------------|--------|
| 2 | Stolpe L=3000 | 07-100-335 | 3 |
| 1 | Stolpe L=3450 | 07-100-334 | 12 |

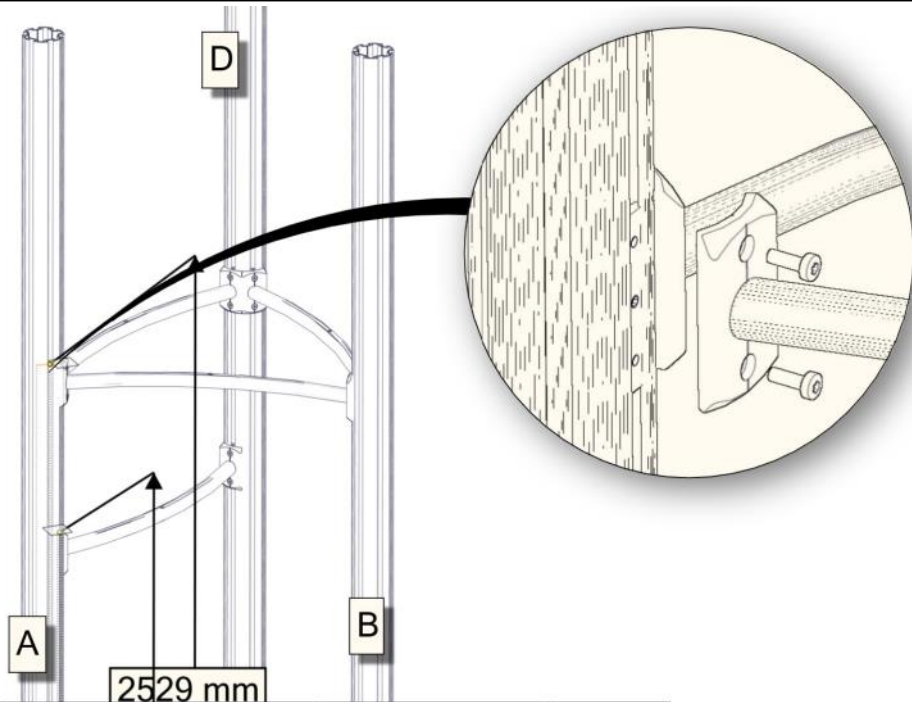

| nr | PartName (config) | Artnr (config) | Antall |
|----|---------------------|----------------|--------|
| 3 | Sperrerør hull gulv | 07-150-061 | 4 |
| 1 | Stolpe L=3450 | 07-100-334 | 3 |
| 2 | Torx M8x25 | 04-000-025 | 16 |

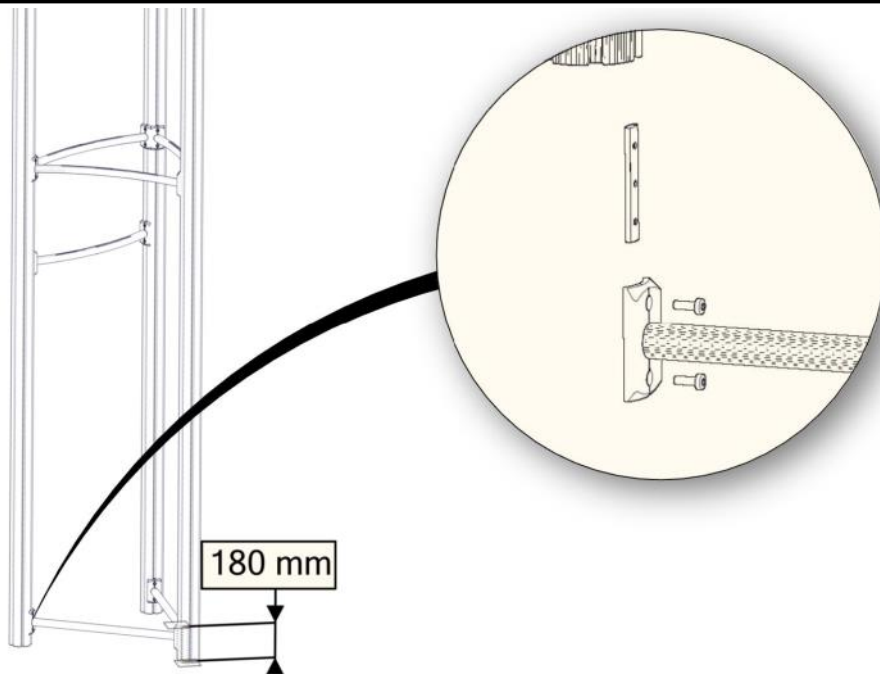

| nr | PartName (config) | Artnr (config) | Antall |
|----|-------------------|----------------|--------|
| 2 | Brikke 120 3xM8 | 04-060-120 | 4 |
| 3 | Sperrerør rett | 07-150-062 | 2 |
| 1 | Torx M8x25 | 04-000-025 | 8 |

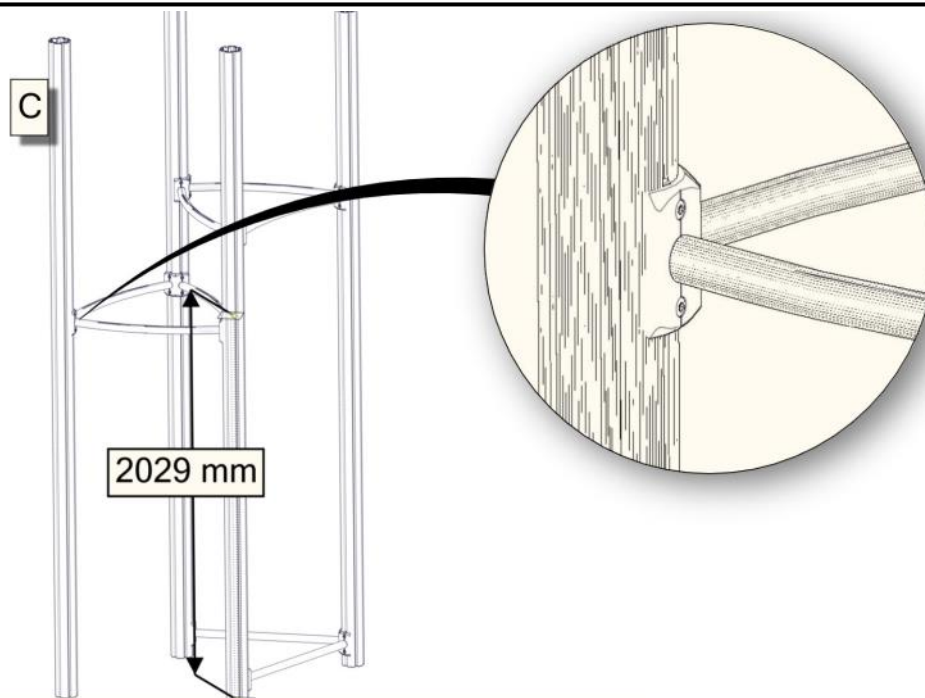

| nr | PartName (config) | Artnr (config) | Antall |
|----|---------------------|----------------|--------|
| 2 | Sperrerør hull gulv | 07-150-061 | 2 |
| 3 | Stolpe L=3450 | 07-100-334 | 1 |
| 1 | Torx M8x25 | 04-000-025 | 8 |

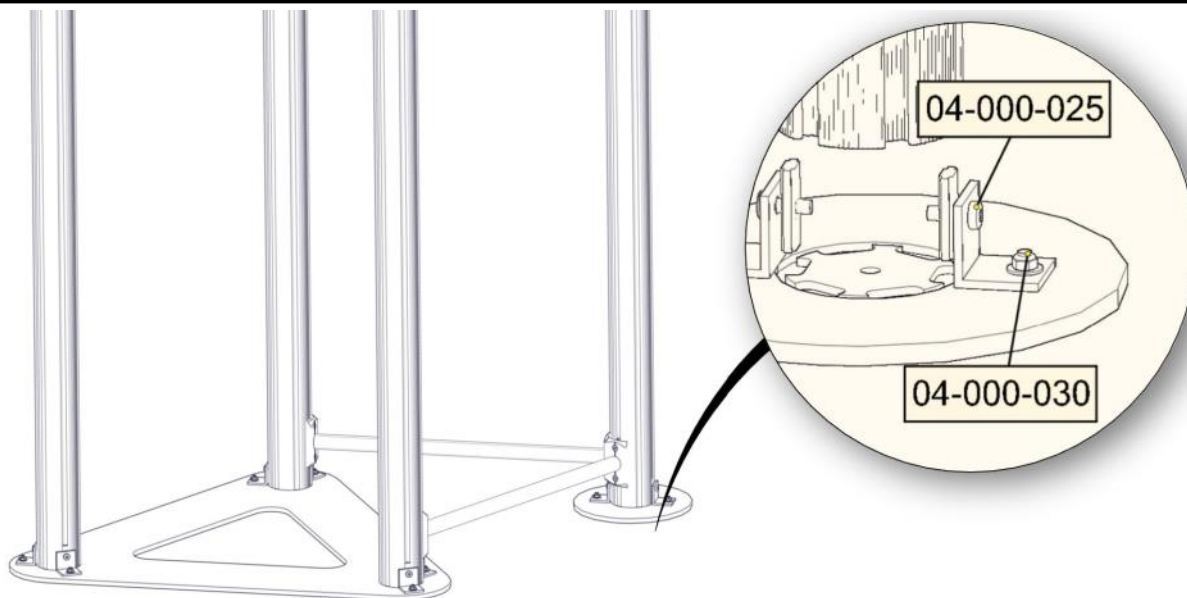

| nr | PartName (config) | Artnr (config) | Antall |
|----|--------------------------|----------------|--------|
| 5 | Brikke50 1XM8 | 04-060-050 | 8 |
| 7 | Fundamentplate 1 stolpe | 07-400-011 | 1 |
| 8 | Fundamentplate 3 stolper | 07-400-013 | 1 |
| 3 | Låsemutter M8 | 04-040-008 | 8 |
| 4 | Skive M8 stor | 04-055-008 | 16 |

| nr | PartName (config) | Artnr (config) | Antall |
|----|-----------------------------|----------------|--------|
| 1 | Torx M8x25 | 04-000-025 | 8 |
| 2 | Torx M8x30 | 04-000-030 | 8 |
| 6 | Vinkel 50x50x50x5 11mm hull | 04-070-050 | 8 |

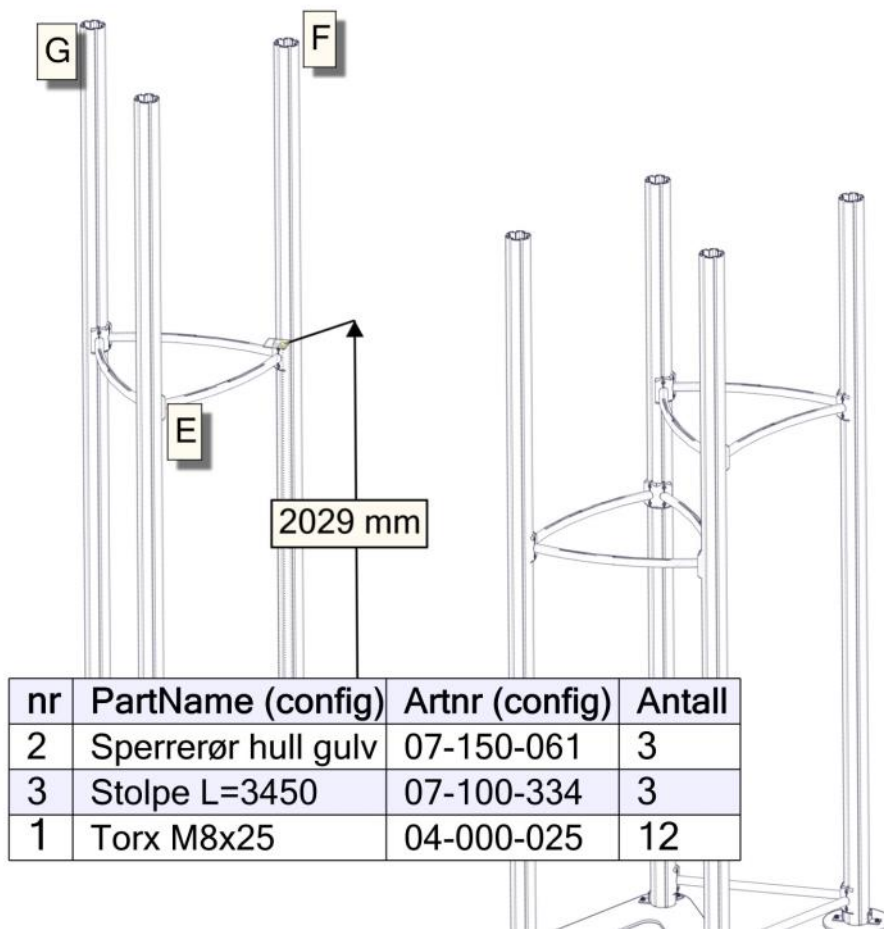

| nr | PartName (config) | Artnr (config) | Antall |
|----|---------------------|----------------|--------|
| 2 | Sperrerør hull gulv | 07-150-061 | 3 |
| 3 | Stolpe L=3450 | 07-100-334 | 3 |
| 1 | Torx M8x25 | 04-000-025 | 12 |

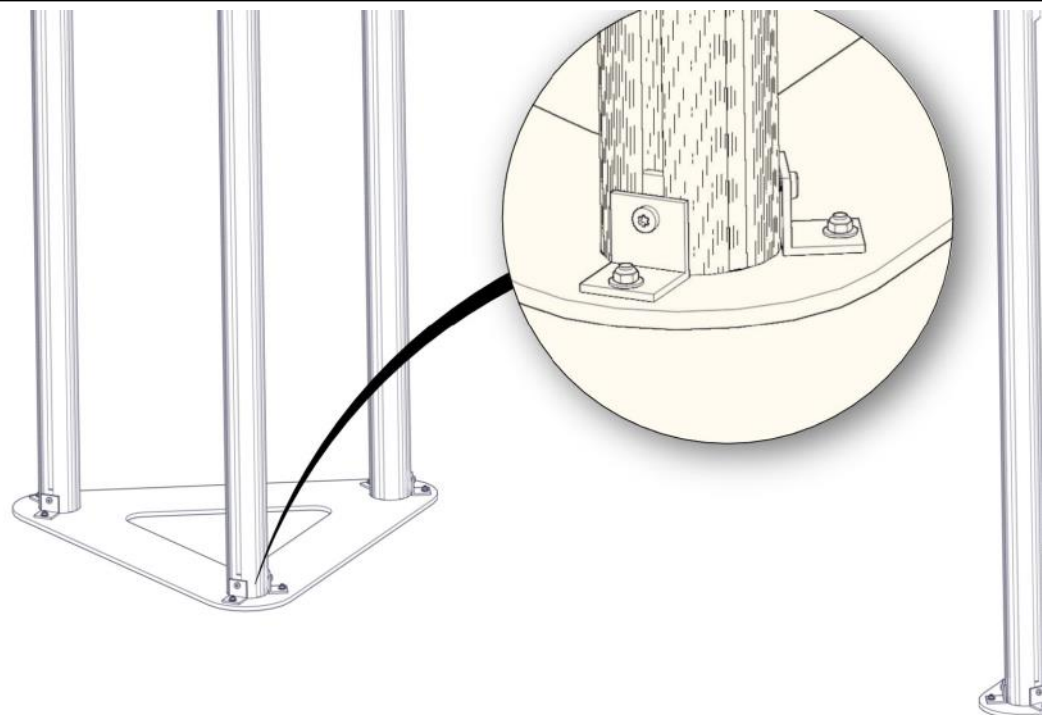

| nr | PartName (config) | Artnr (config) | Antall |
|----|--------------------------|----------------|--------|
| 5 | Brikke50 1XM8 | 04-060-050 | 6 |
| 7 | Fundamentplate 3 stolper | 07-400-013 | 1 |
| 3 | Låsemutter M8 | 04-040-008 | 6 |
| 4 | Skive M8 stor | 04-055-008 | 12 |

| nr | PartName (config) | Artnr (config) | Antall |
|----|-----------------------------|----------------|--------|
| 1 | Torx M8x25 | 04-000-025 | 6 |
| 2 | Torx M8x30 | 04-000-030 | 6 |
| 6 | Vinkel 50x50x50x5 11mm hull | 04-070-050 | 6 |

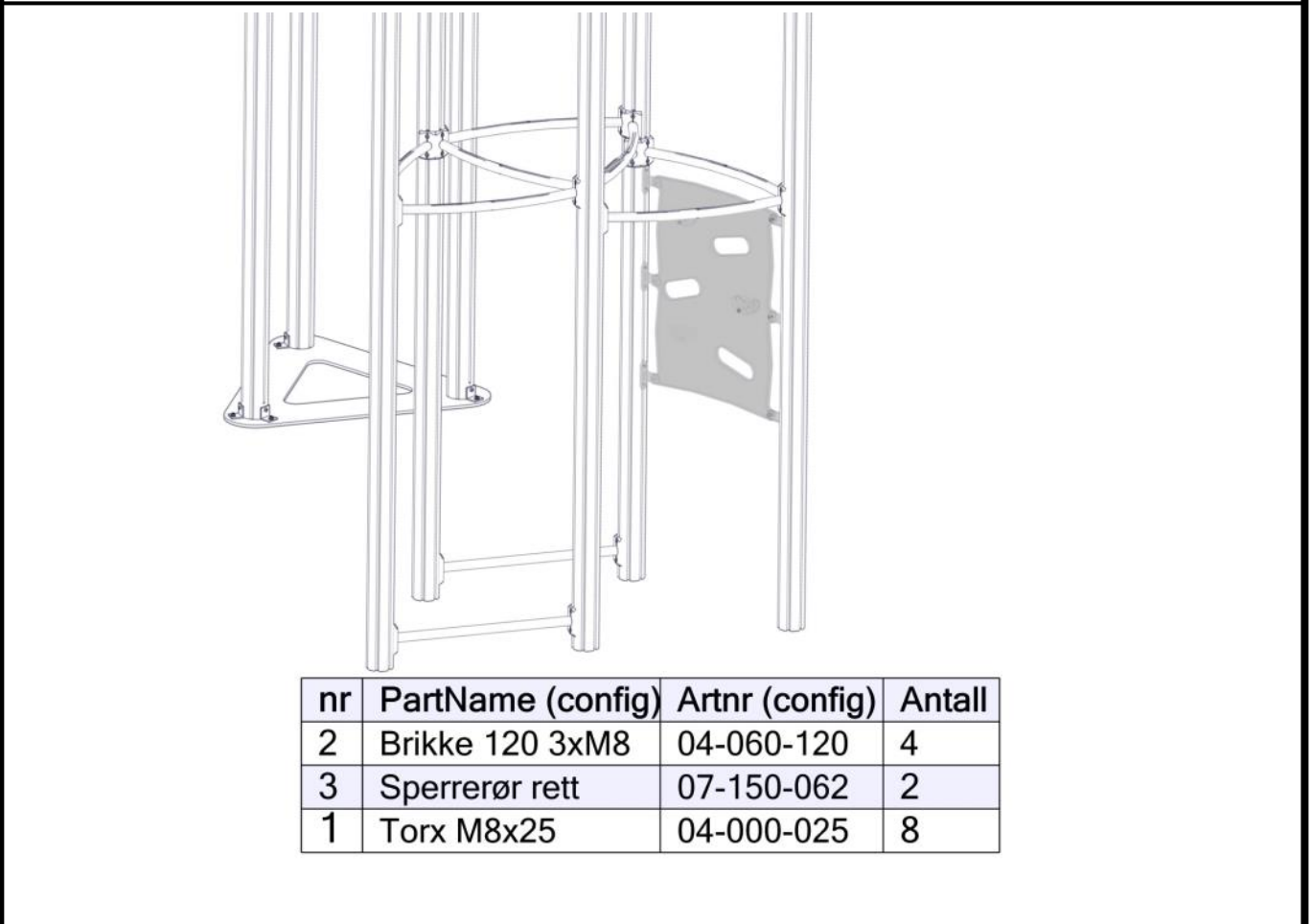
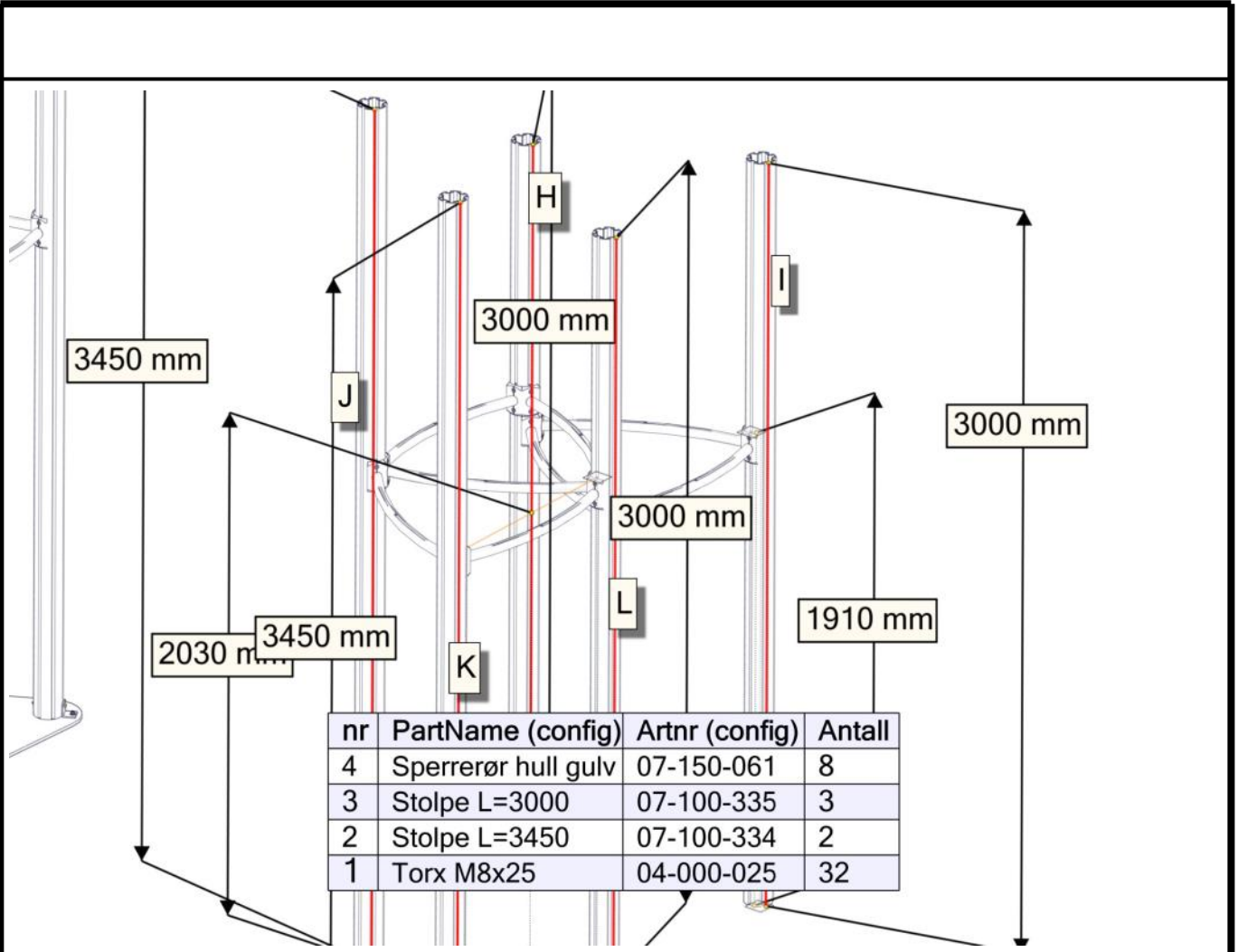

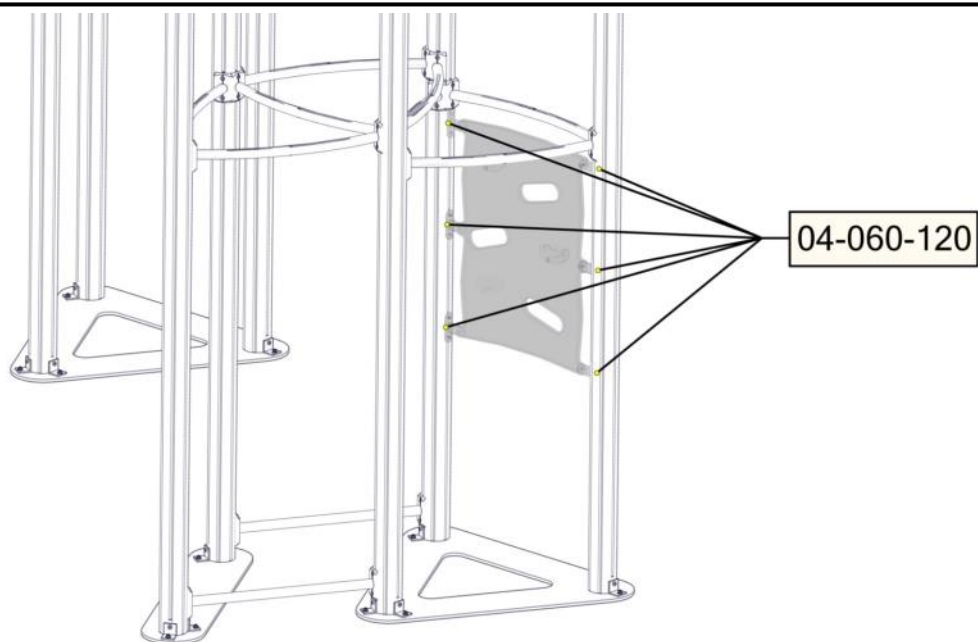

| nr | PartName (config) | Artnr (config) | Antall |
|----|--------------------------|----------------|--------|
| 9 | Brikke 120 3xM8 | 04-060-120 | 6 |
| 5 | Brikke50 1XM8 | 04-060-050 | 10 |
| 7 | Fundamentplate 2 stolper | 07-400-012 | 1 |
| 8 | Fundamentplate 3 stolper | 07-400-013 | 1 |
| 3 | Låsemutter M8 | 04-040-008 | 10 |

| nr | PartName (config) | Artnr (config) | Antall |
|----|-----------------------------|----------------|--------|
| 4 | Skive M8 stor | 04-055-008 | 20 |
| 1 | Torx M8x25 | 04-000-025 | 10 |
| 2 | Torx M8x30 | 04-000-030 | 10 |
| 6 | Vinkel 50x50x50x5 11mm hull | 04-070-050 | 10 |

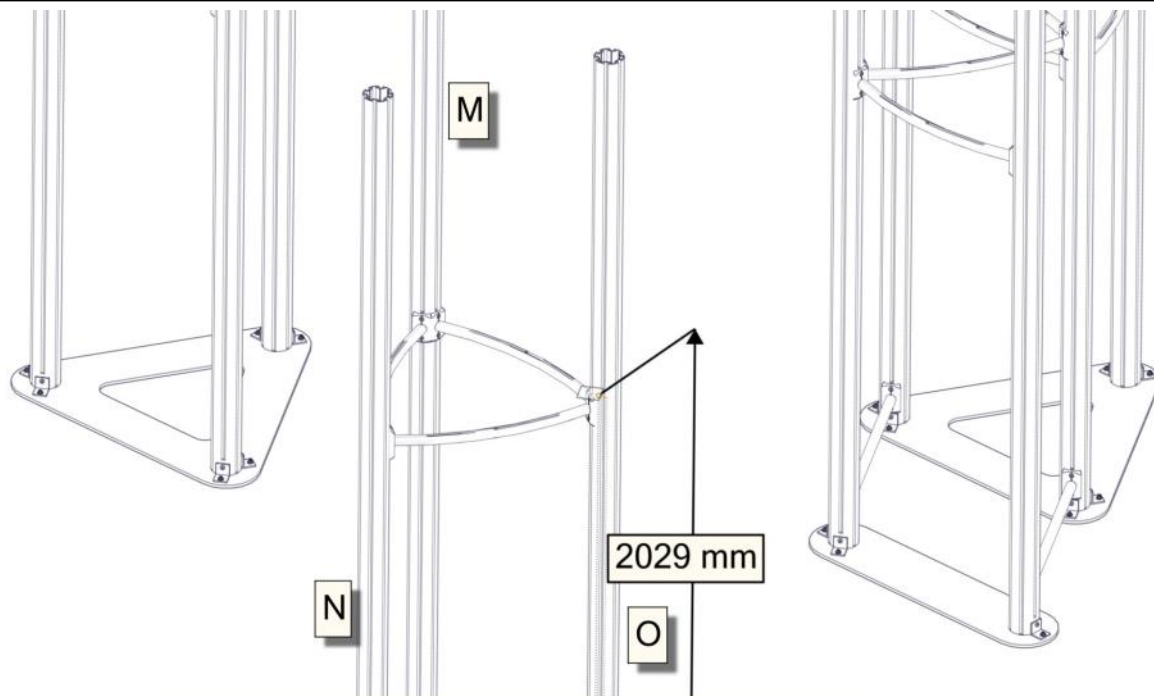

| nr | PartName (config) | Artnr (config) | Antall |
|----|---------------------|----------------|--------|
| 2 | Sperrørør hull gulv | 07-150-061 | 3 |
| 3 | Stolpe L=3450 | 07-100-334 | 3 |
| 1 | Torx M8x25 | 04-000-025 | 12 |

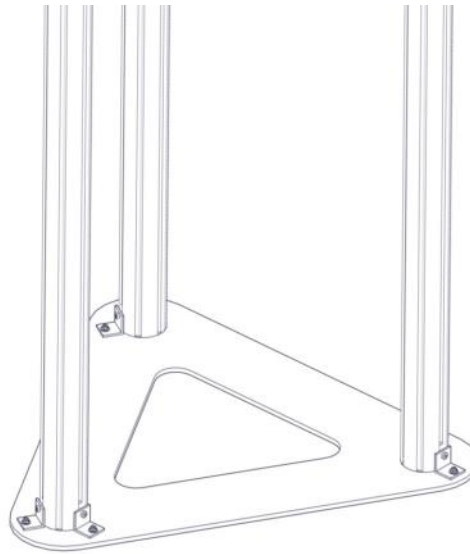

| nr | PartName (config) | Artnr (config) | Antall |
|----|--------------------------|----------------|--------|
| 5 | Brikke50 1XM8 | 04-060-050 | 6 |
| 7 | Fundamentplate 3 stolper | 07-400-013 | 1 |
| 3 | Låsemutter M8 | 04-040-008 | 6 |
| 4 | Skive M8 stor | 04-055-008 | 12 |

| nr | PartName (config) | Artnr (config) | Antall |
|----|-----------------------------|----------------|--------|
| 1 | Torx M8x25 | 04-000-025 | 6 |
| 2 | Torx M8x30 | 04-000-030 | 6 |
| 6 | Vinkel 50x50x50x5 11mm hull | 04-070-050 | 6 |

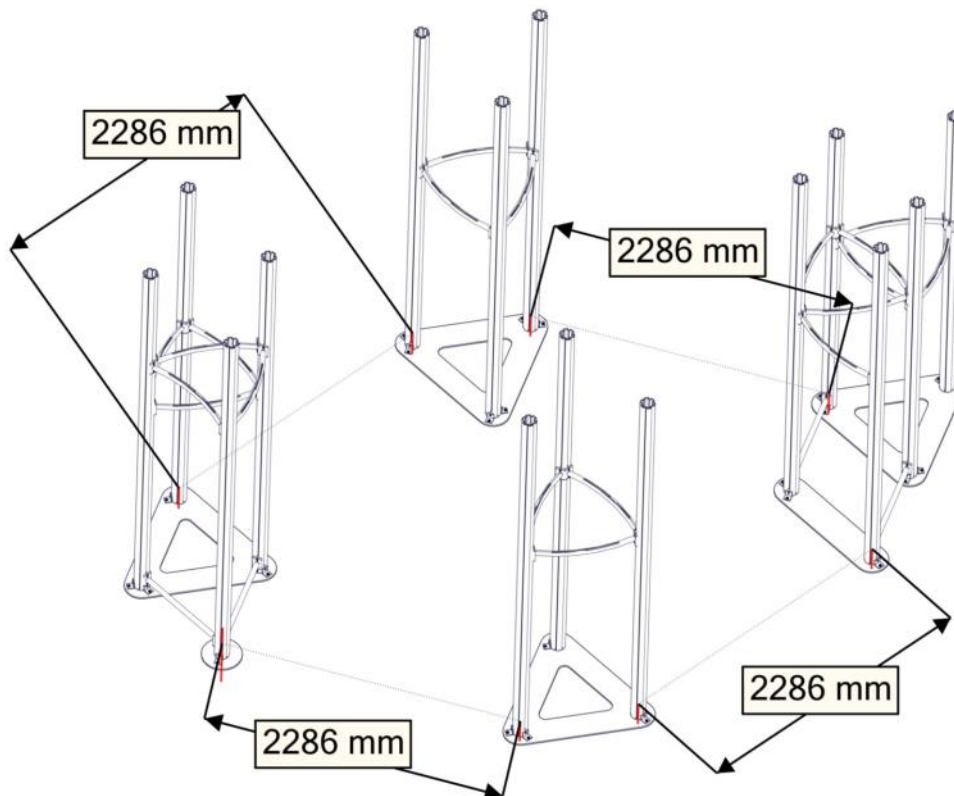

07-300-101

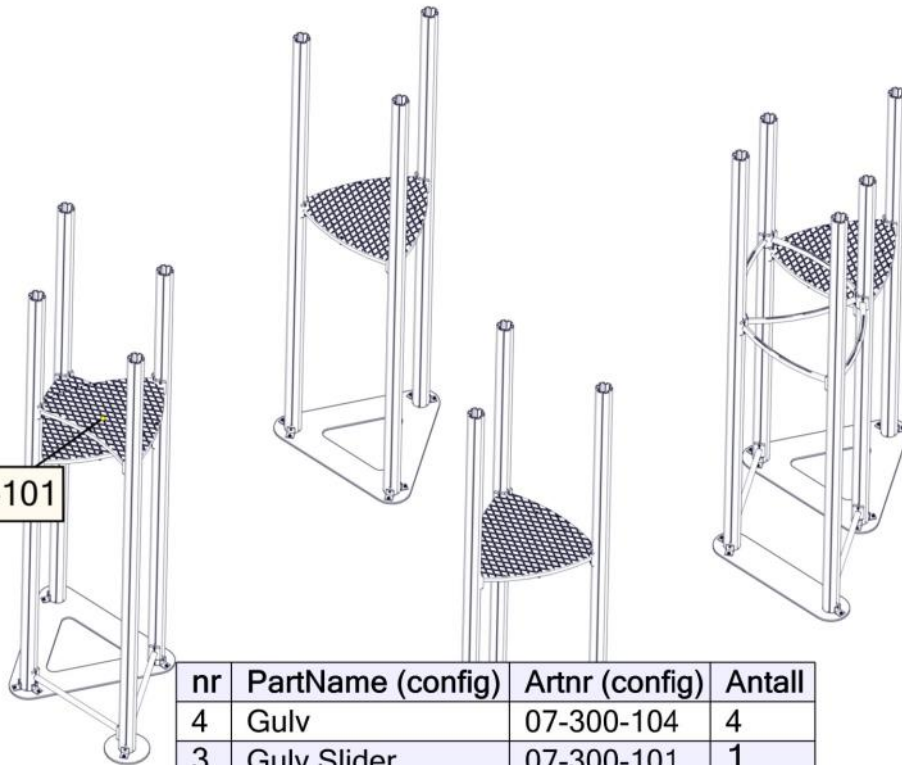

| nr | PartName (config) | Artnr (config) | Antall |
|----|-------------------|----------------|--------|
| 4 | Gulv | 07-300-104 | 4 |
| 3 | Gulv Slider | 07-300-101 | 1 |
| 2 | Møbelknapp 16x11 | 04-030-011 | 15 |
| 1 | Torx M8x45 | 04-000-045 | 15 |

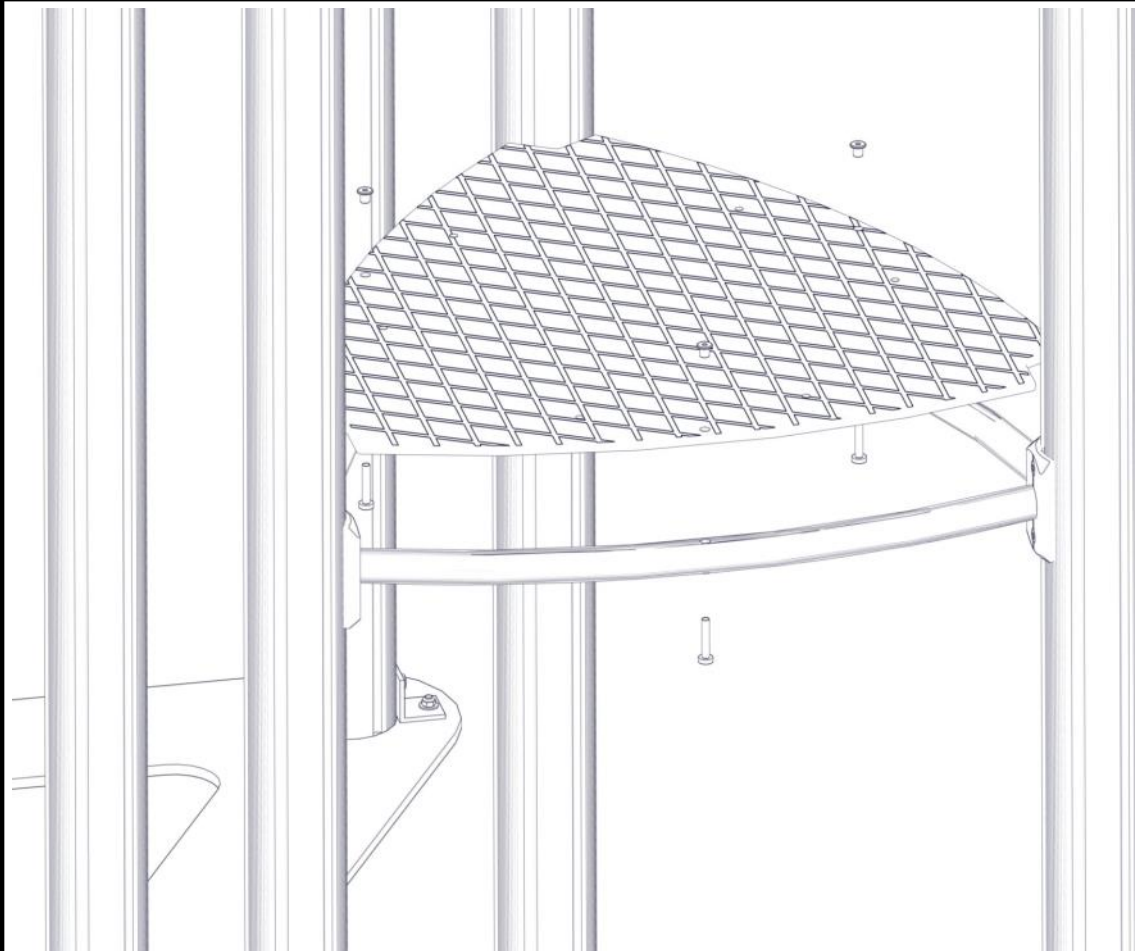

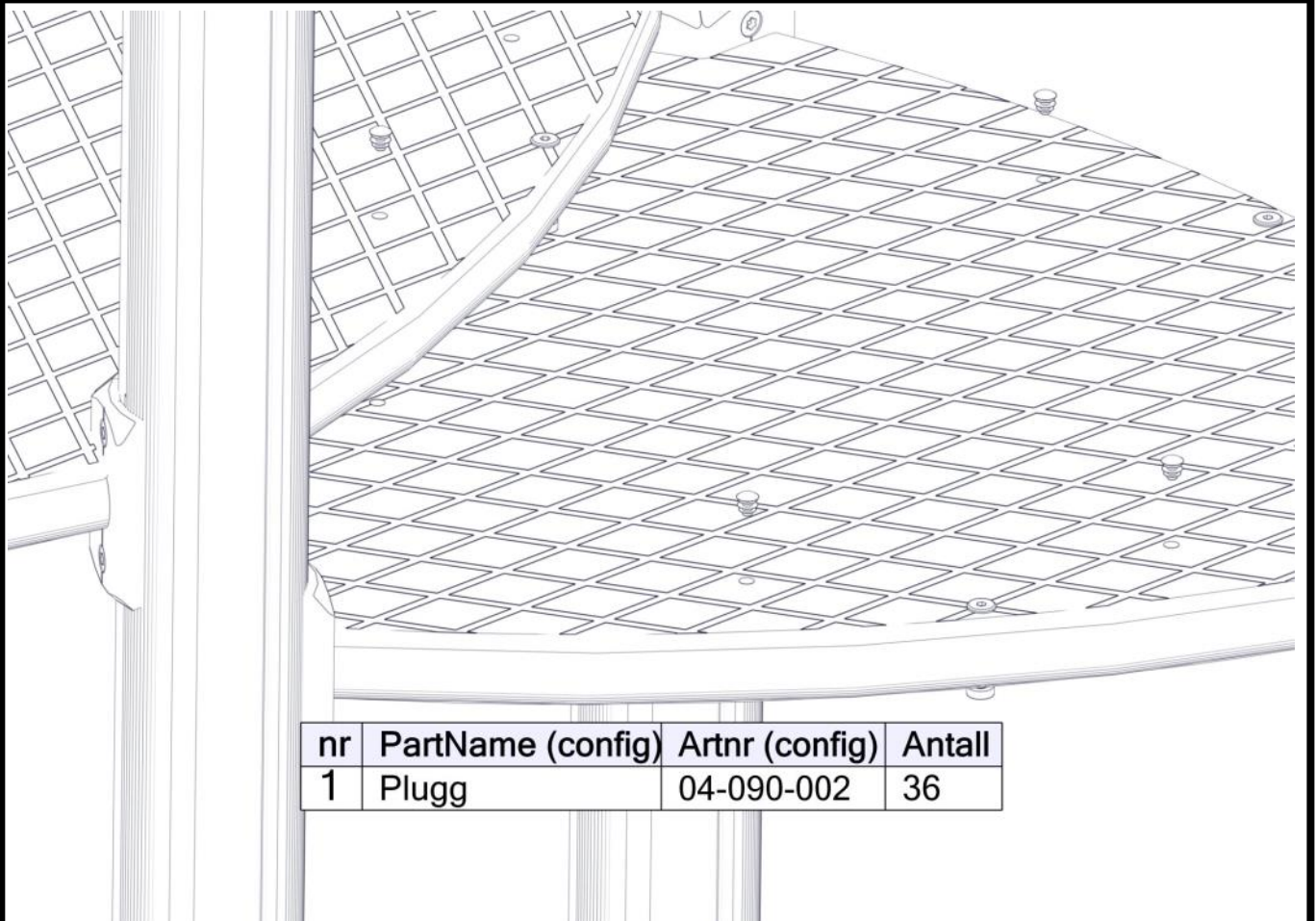
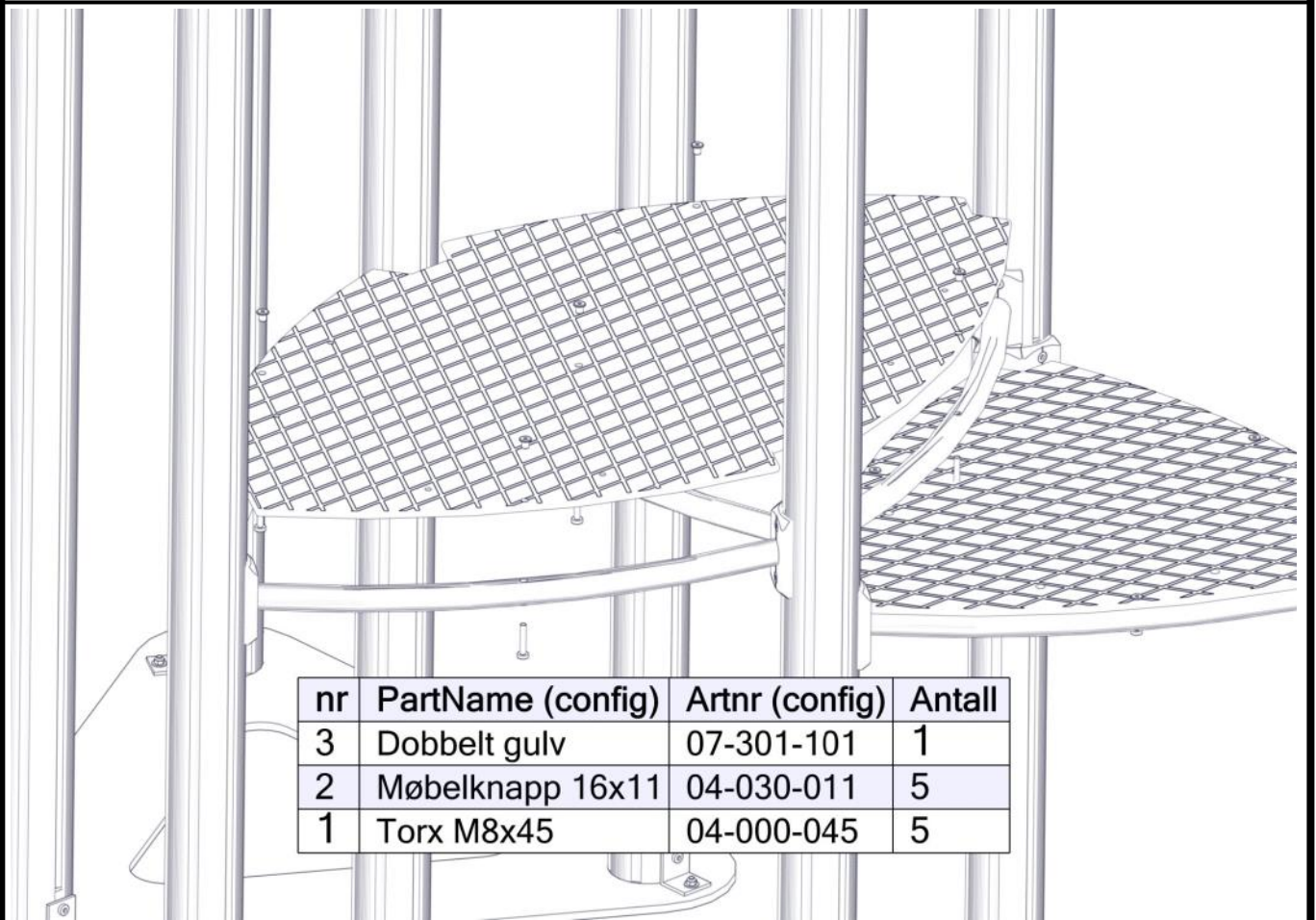

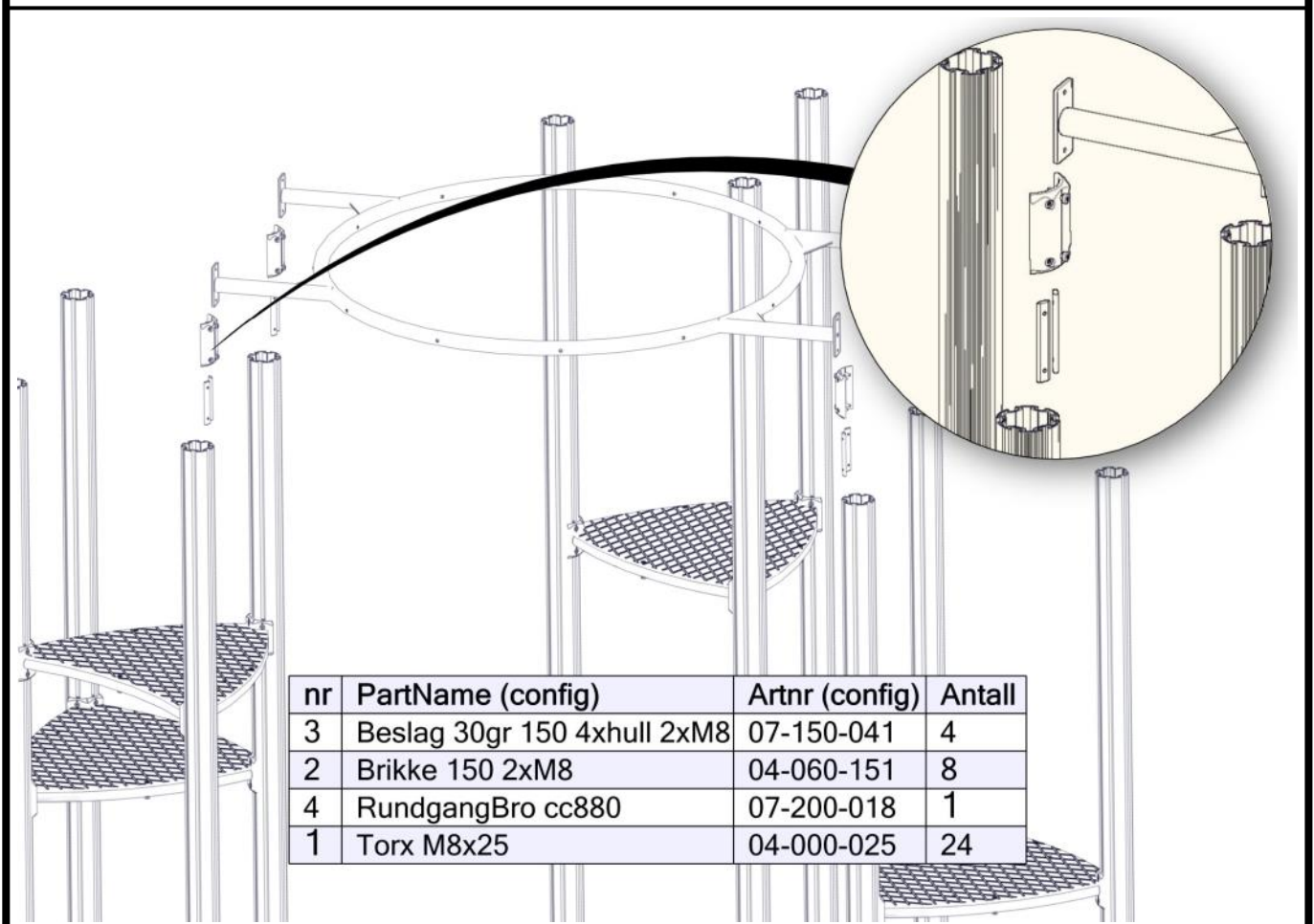
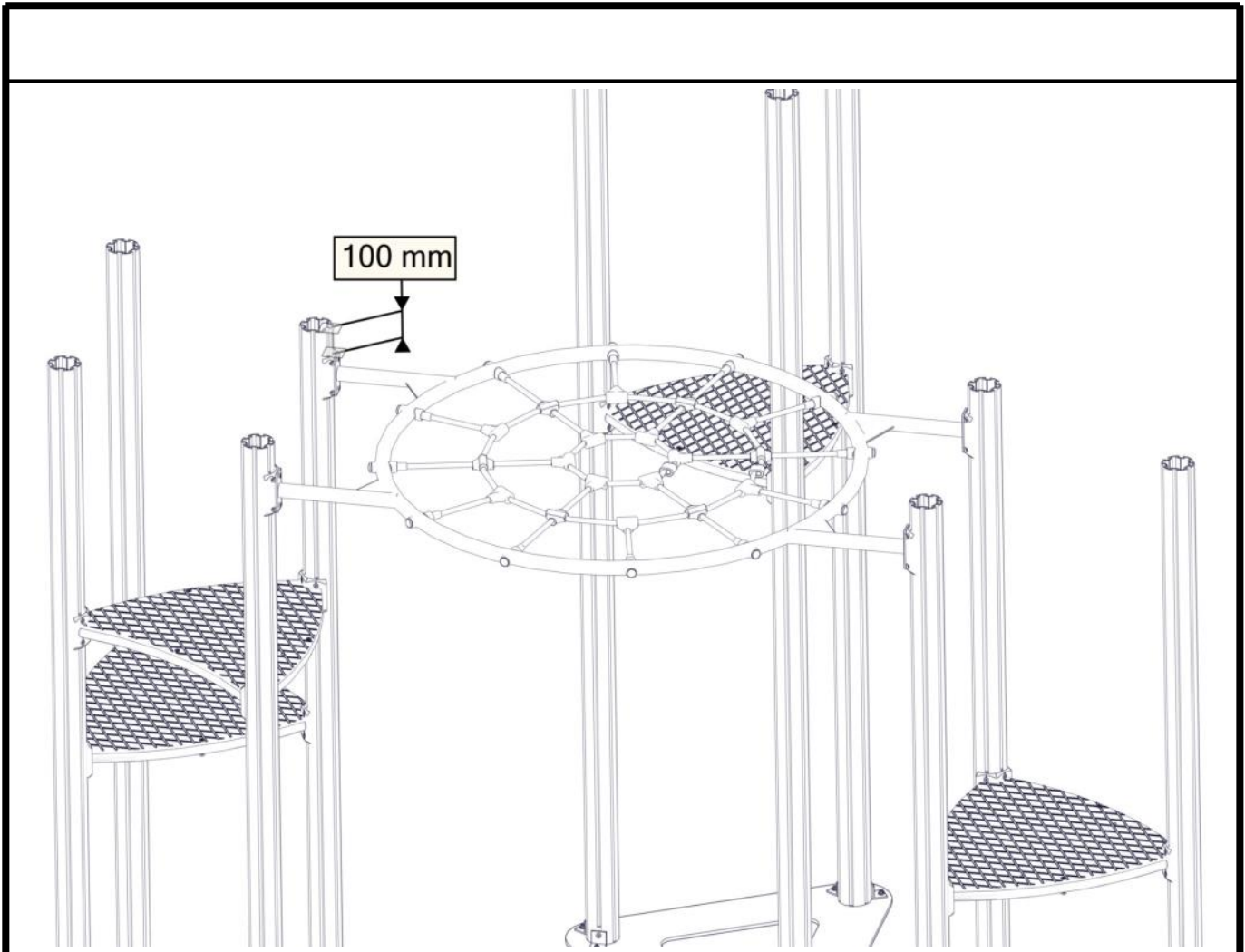

| nr | PartName (config) | Artnr (config) | Antall |
|----|-----------------------------|----------------|--------|
| 3 | Beslag 30gr 150 4xhull 2xM8 | 07-150-041 | 4 |
| 2 | Brikke 150 2xM8 | 04-060-151 | 8 |
| 4 | RundgangBro cc880 | 07-200-018 | 1 |
| 1 | Torx M8x25 | 04-000-025 | 24 |

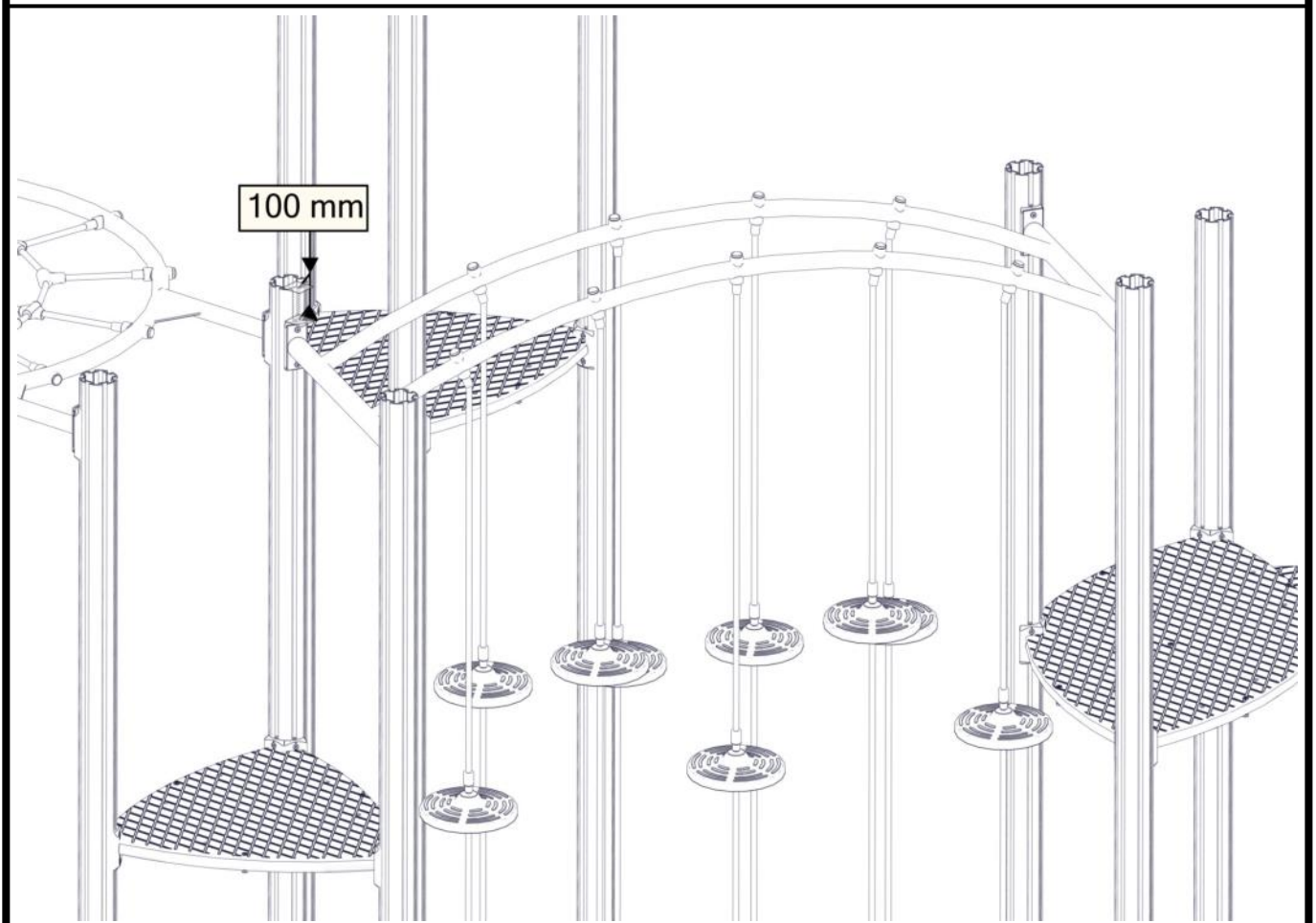
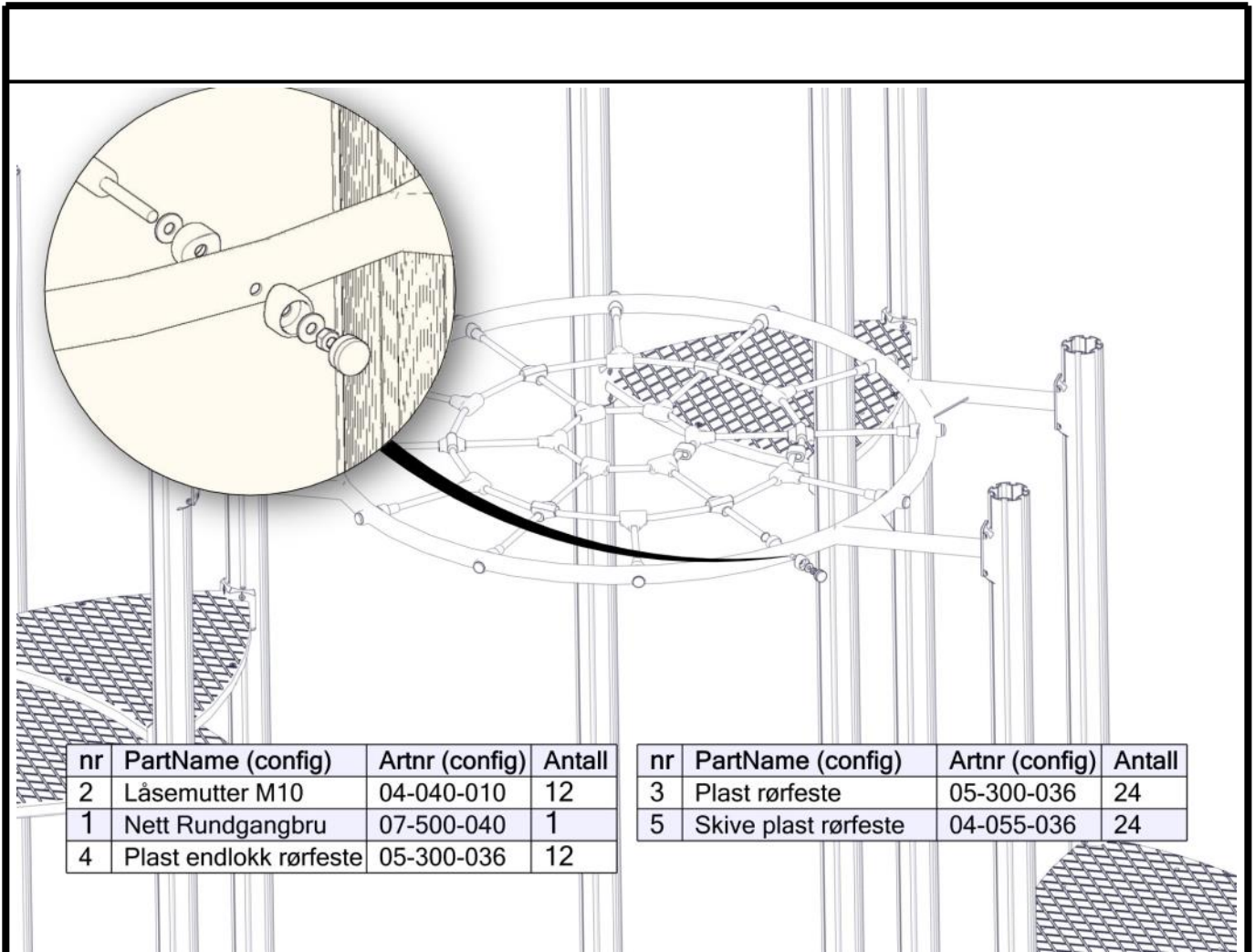

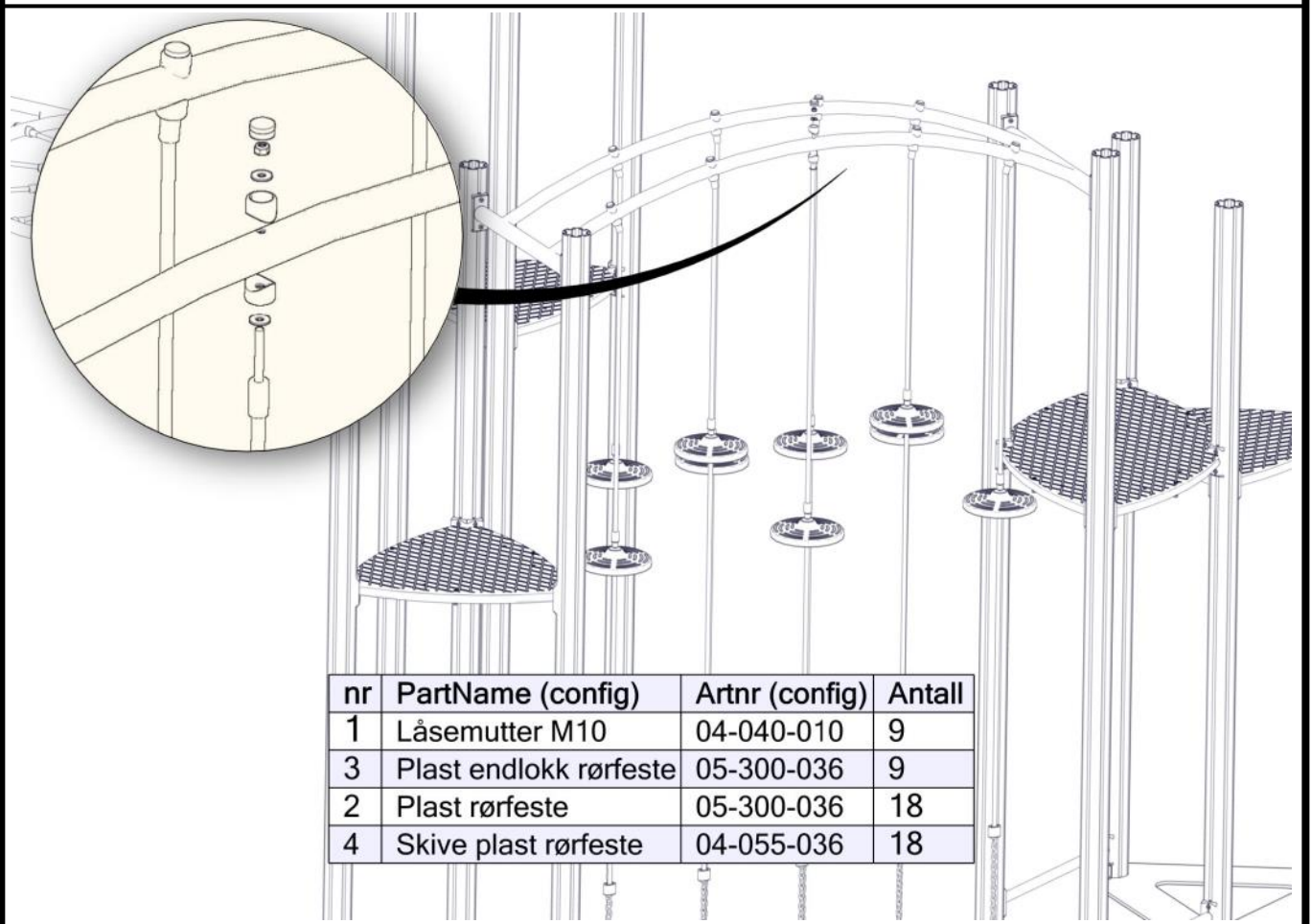
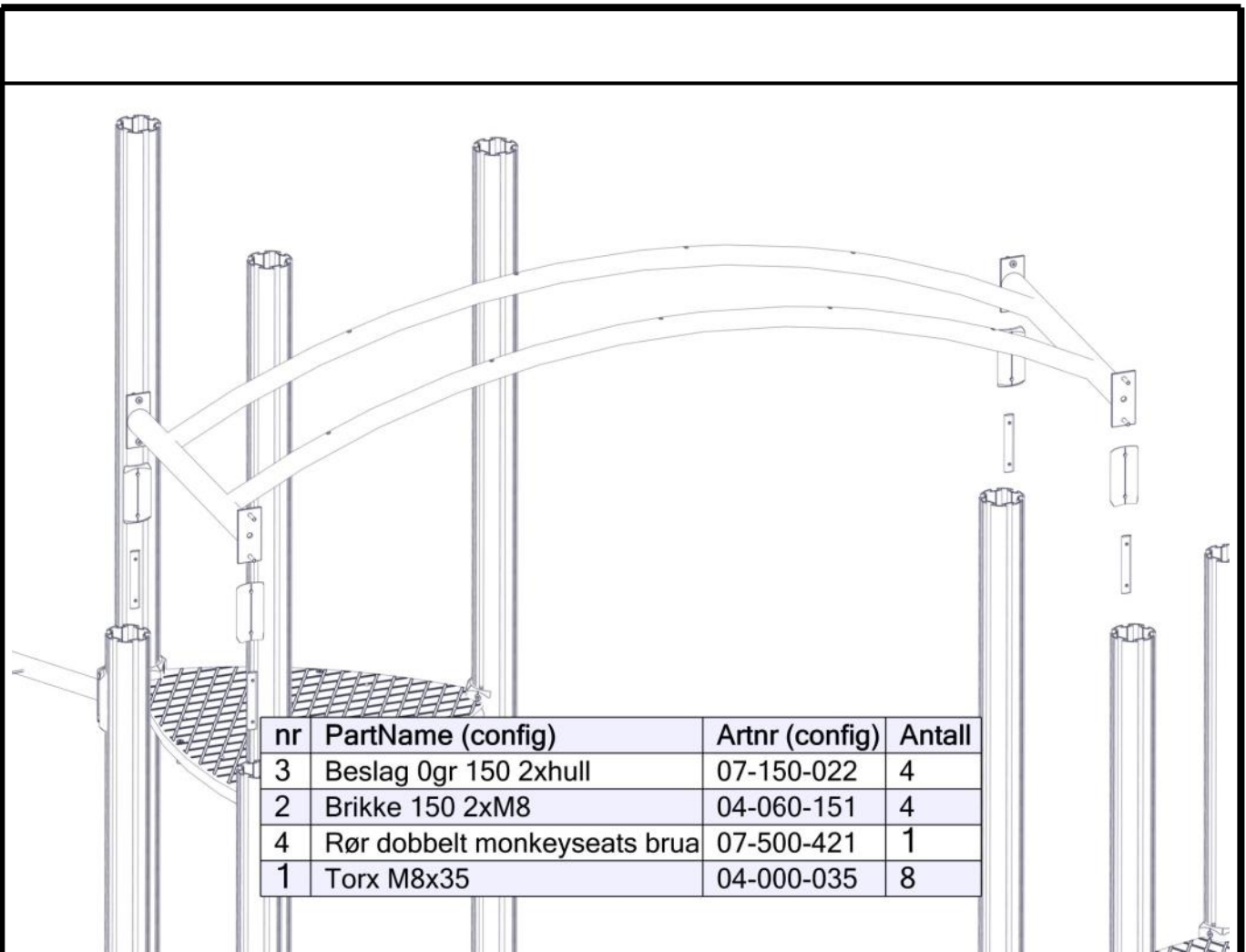

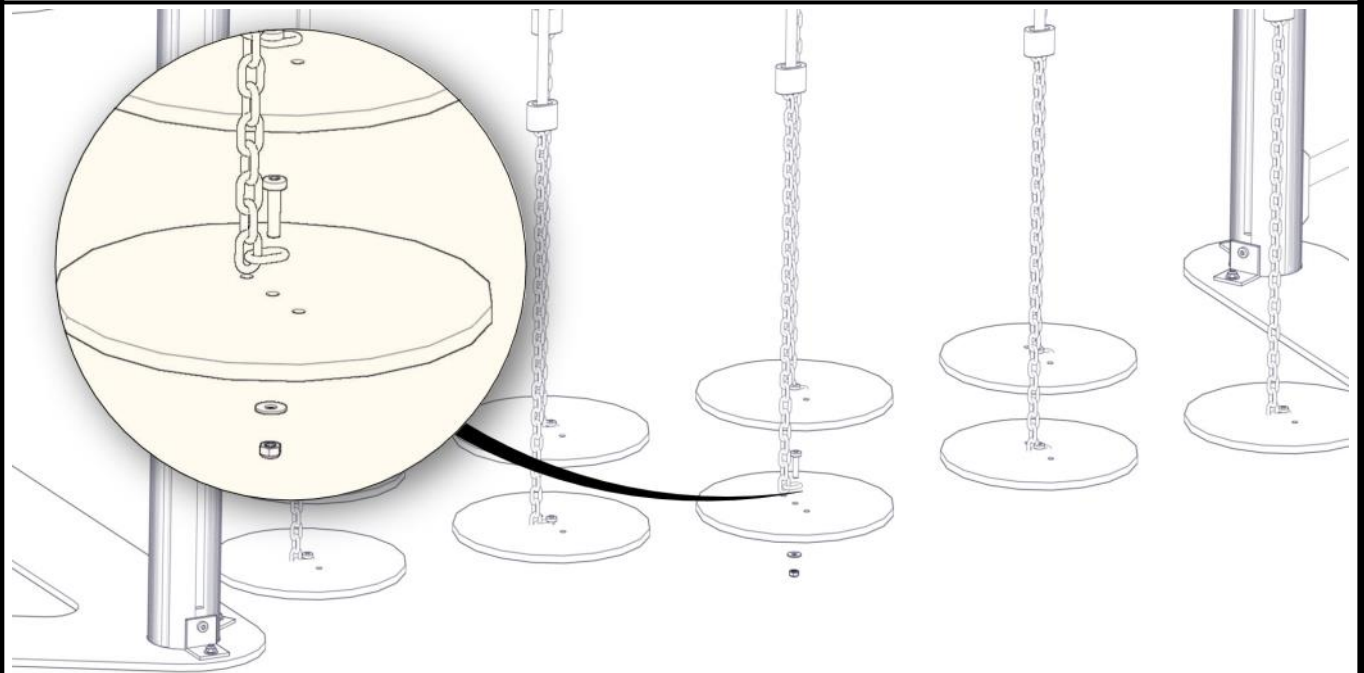

| nr | PartName (config) | Artnr (config) | Antall |
|----|-------------------|----------------|--------|
| 1 | Fundament plate | 00-003-106 | 9 |
| 3 | Låsemutter M8 | 04-040-008 | 9 |
| 4 | Skive M8 stor | 04-055-008 | 9 |
| 2 | Torx M8x35 | 04-000-035 | 9 |

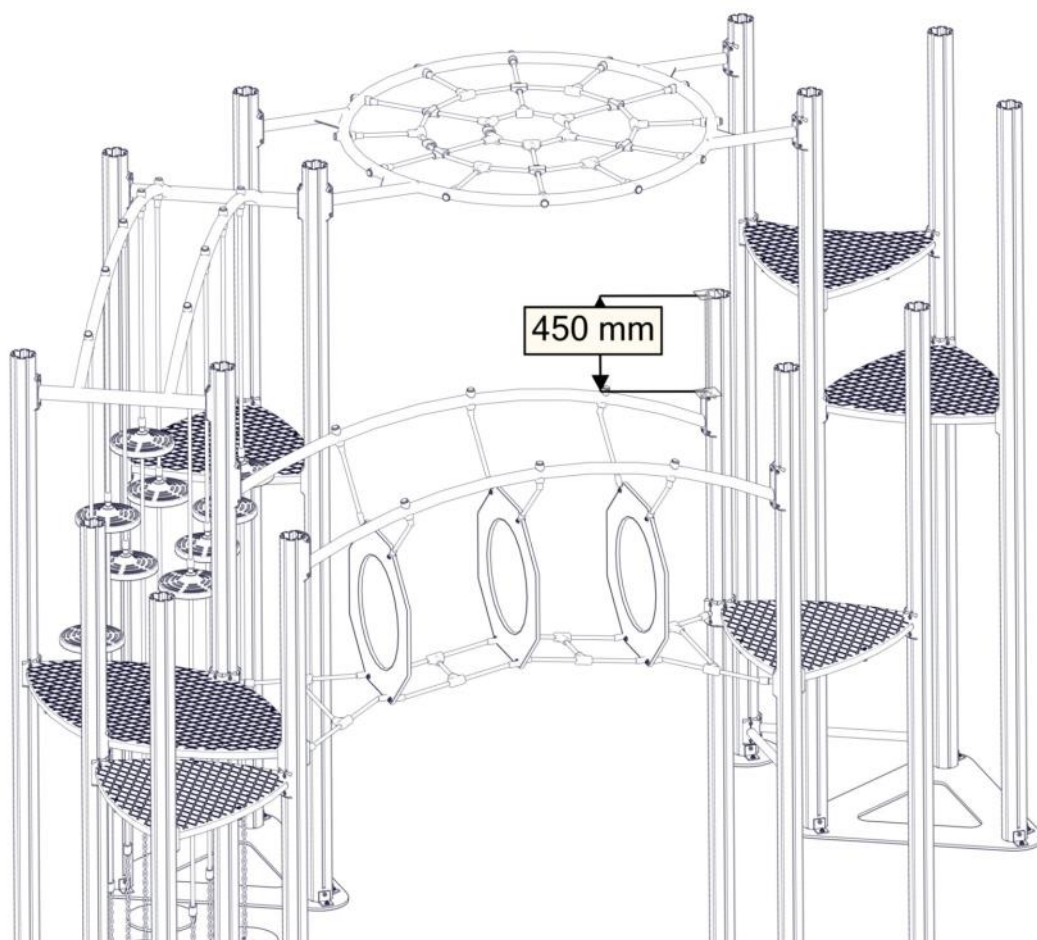

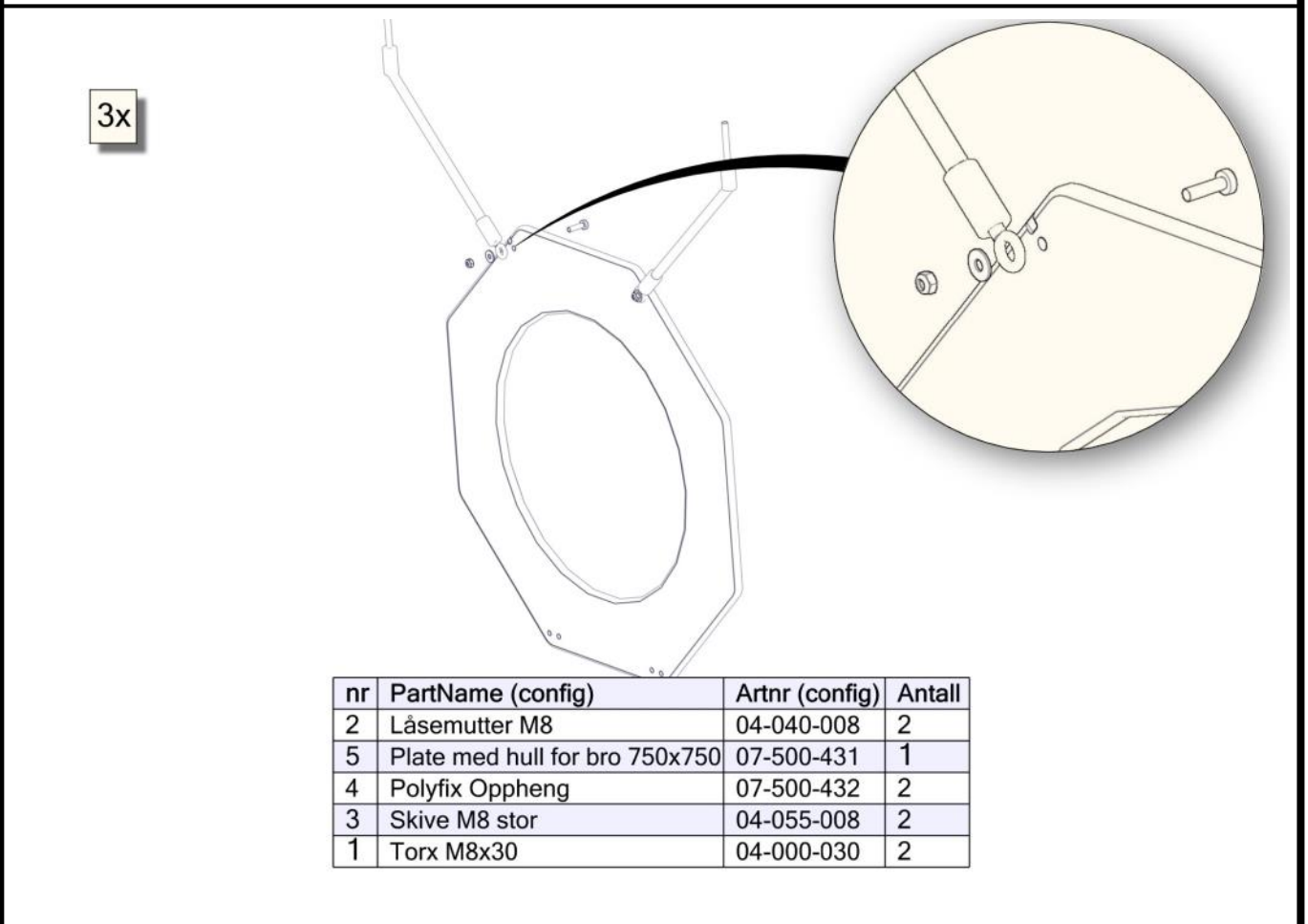
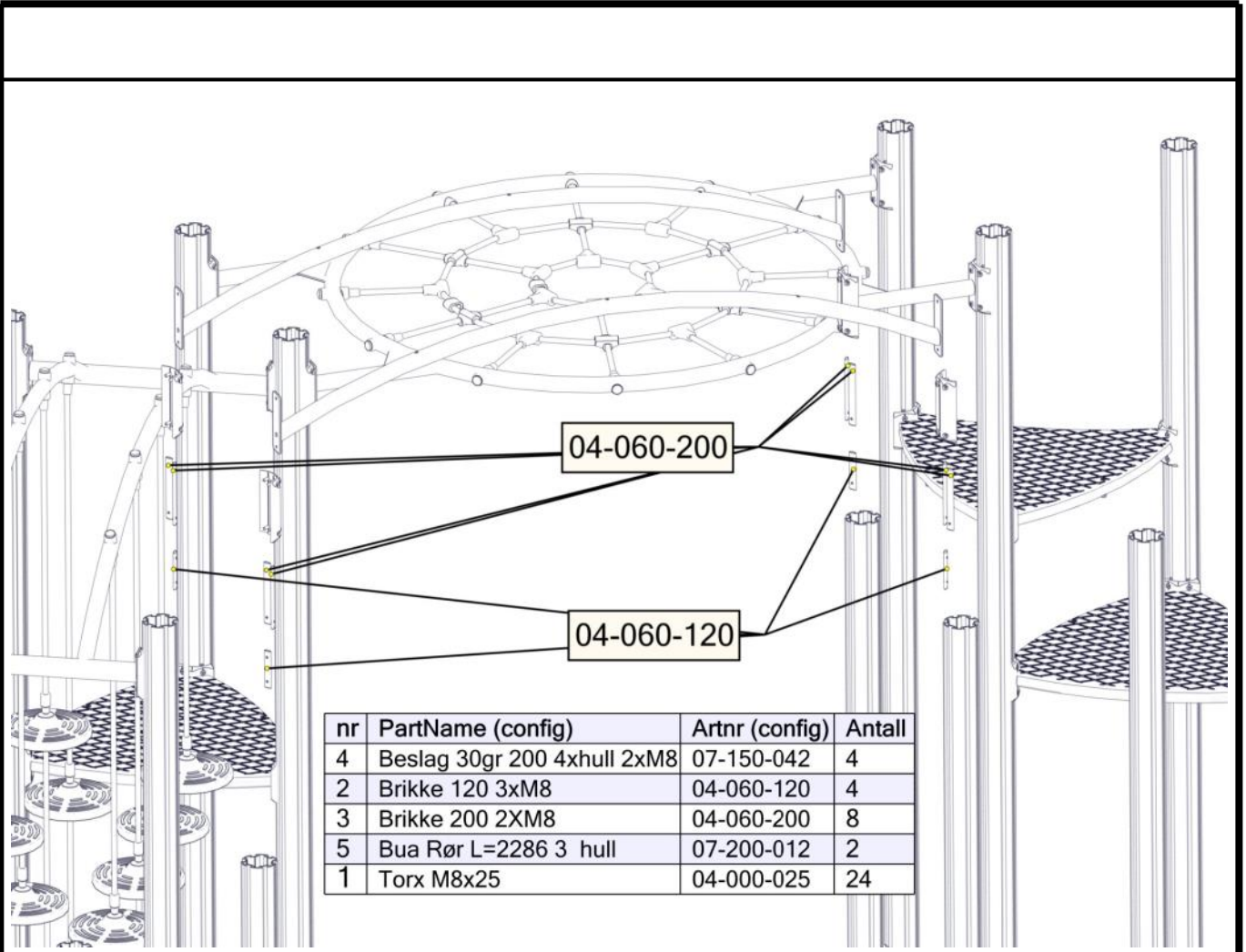







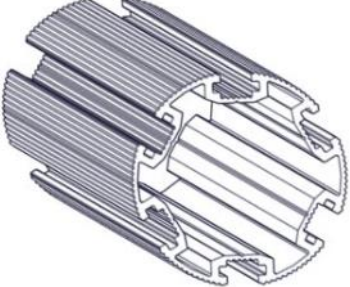

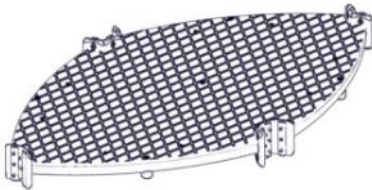
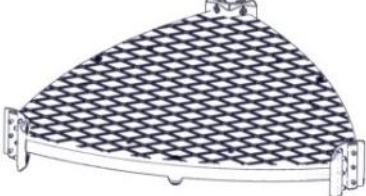
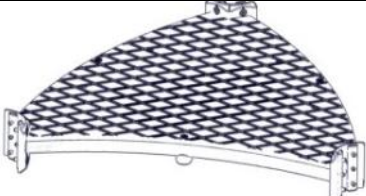
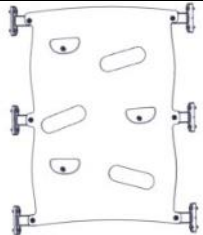

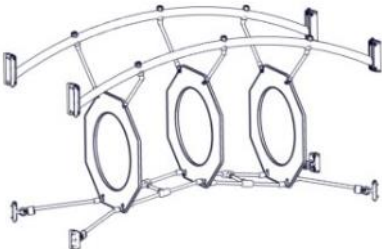
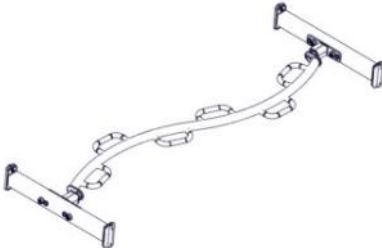
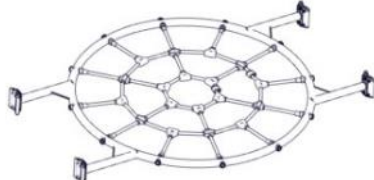

| Før utstyret tas i bruk / Before play begins / Innan lekredskapet tas i bruk | |
|---|---|
| N | <ul style="list-style-type: none"> ● Påse at fallunderlag er utlagt i henhold til gjeldende regler eller vår anbefaling ● Fjern alle monteringshjelpemidler (rester av betong, planker, paller, plast, og lignende) ● Før utstyret tas i bruk, burde man sjekke at det ikke er fare for at anorakksnorer og lignende som kan hekte seg fast noen steder på lekeapparatet. (Vedlagte snor med dobbe (kneledd) kan brukes til å sjekke at dette er i orden. Se vedlagte veiledning for bruk av denne. Dette gjøres for å oppdage eventuelle feilmonteringer.? ● NB! Bør stå i 2-3 dager før bruk |
| EN | <ul style="list-style-type: none"> ● Make sure the area and depth of safer surfacing are according to the current standard, or to the manufacturer's recommendation ● Make sure all tools and surplus materials are removed before play begins ● PS! When complete, allow 2-3 days for the concrete to set before use |
| S | <ul style="list-style-type: none"> ● Kontrollera att fallunderlag är utlagt enligt gällande regler eller vårt rekommendation ● Ta bort alla monteringshjälpmedel (rester av betong, plankor, pallar, plast och liknande) ● Innan lekredskapet används, kontrollera att anoracksnoddar eller kläder/delar av kläder eller liknande inte kan fastna i några delar på redskapet. (Den bipackade "knävringen" kan man med fördel användas för denna kontroll. ● Detta görs för att upptäcka eventuella felmonteringar.) |

Boltepakker for / Boltpackage for / Bultpaket för

Sign. _____

| Blåhø, Brun-Rød 30-800-060 | Navn | Artnr/ dimensjon | Ant | Lev |
|---|--|--|--------------|-----|
|  | Stolpe Ø110 L=3450 (2850-600) Brun L=3100 (2500-600) Brun L=3000 (2400-600) Brun | SFA5126/1 SFA5126/1 SFA5126/1 | 12 1 2 | |
|  | Endelokk til stolpe Ø110 | 00-400-995 | 15 | |
|  | Gulv 3-kant dobbel standard Brun | 07-301-101K (Se egen del- montering) | 1 | |
|  | Gulv 3-kant standard 880 x 880 Brun | 07-300-101K (Se egen del- montering) | 4 | |
|  | Gulv 3-kant 1 konkav 880 x 880 Brun | 07-300-102K (Se egen del- montering) | 1 | |
|  | Klatreplate CC880 Rød | 07-500-470K (Se egen del- montering) | 2 | |



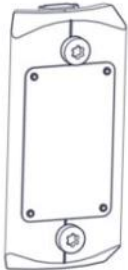

| Boltepakker for / Boltpackage for / Bultpaket för | | Sign. _____ | | |
|---|---|--|-----|-----|
| Blåhø, Brun-Rød 30-800-060 | Navn | Artnr/ dimensjon | Ant | Lev |
|  | Rekkverk 620 x 900 CC880 | 07-302-104K (se egen del- montering) | 1 | |
|  | Bro HPL plate komplett Rød | 07-500-430K (Se egen del- montering) | 1 | |
|  | Bevegelig armgang komplett Rød | 07-500-280K (se egen del- montering) | 1 | |
|  | Bro rundgang komplett CC880 L=2200 Rød | 07-200-255K (se egen del- montering) | 1 | |
|  | Slider rør 2stk komplett | 07-200-010K (se egen del- montering) | 1 | |
|  | Twistnett Inkludert beslag og stolper Rød | 07-500-443K (se egen del- montering) | 1 | |

| Boltepakker for / Boltpackage for / Bultpaket för | | Sign. _____. | | |
|---|---|--|-----|-----|
| Blåhø, Brun-Rød 30-800-060 | Navn | Artnr/ dimensjon | Ant | Lev |
|  | Sluse H= 790 komplett Rød | 07-500-062K (se egen del- montering) | 7 | |
|  | Swing CC880 komplett Rød | 07-250-000K (se egen del- montering) | 1 | |
|  | Dobbel monkeyseats bro Komplett Rød | 07-500-420K (Se egen del- montering) | 1 | |
|  | Slider rør Ivar | 07-200-011K (se egen del- montering) | 2 | |
|  | Brannstang gulv 1,9m L=3000 Grå | 07-200-037K (Se egen del- montering) | 1 | |
|  | Produktmerke | 07-500-500 (se egen del- montering) | 1 | |

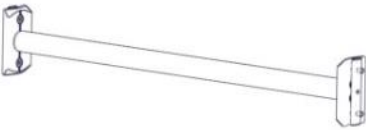
Boltepakker for / Boltpackage for / Bultpaket för

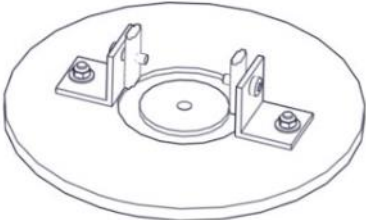
Sign. _____.

| Blåhø, Brun-Rød 30-800-060 | Navn | Artnr/ dimensjon | Ant | Lev |
|---|--|--|-----|-----|
|  | Sperrerør rett uten hull L=750 Rød | 07-500-061K (se egen del- montering) | 2 | |
| | | | | |
| | | | | |
| | | | | |
| | | | | |
| | | | | |

| Boltepakker for / Boltpackage for / Bultpaket för | | Sign. _____ | | |
|---|--|--|-----|-----|
| Blåhø, Brun-Rød 30-800-060 | Navn | Artnr/ dimensjon | Ant | Lev |
| | Nedgravnings fundament | | | |
|  | Fundamentplate for 1 x Ø110 stolpe | 07-400-101K (se egen del- montering) | 15 | |
|  | Sperrerør rett L = 750 Uten hull | 07-500-075K (se egen del- montering) | 17 | |
| | Støp fundament | | | |
|  | Støpefundament pakke Til Ø110 stolpe Bolter, brikker og lokk | 00-003-111K (se egen del- montering) | 15 | |
|  | Sperrerør rett L = 750 Uten hull | 07-500-075K (se egen del- montering) | 17 | |