

**N****Monteringsanvisning****EN****Assembly Instructions****S****Monteringsanvisning**

Produkt nr. / Product no. / Produkt nr.

**30-801-070****Grå / Grønn**

Ord. nr. \_\_\_\_\_

Dato. \_\_\_\_\_

Sign. \_\_\_\_\_

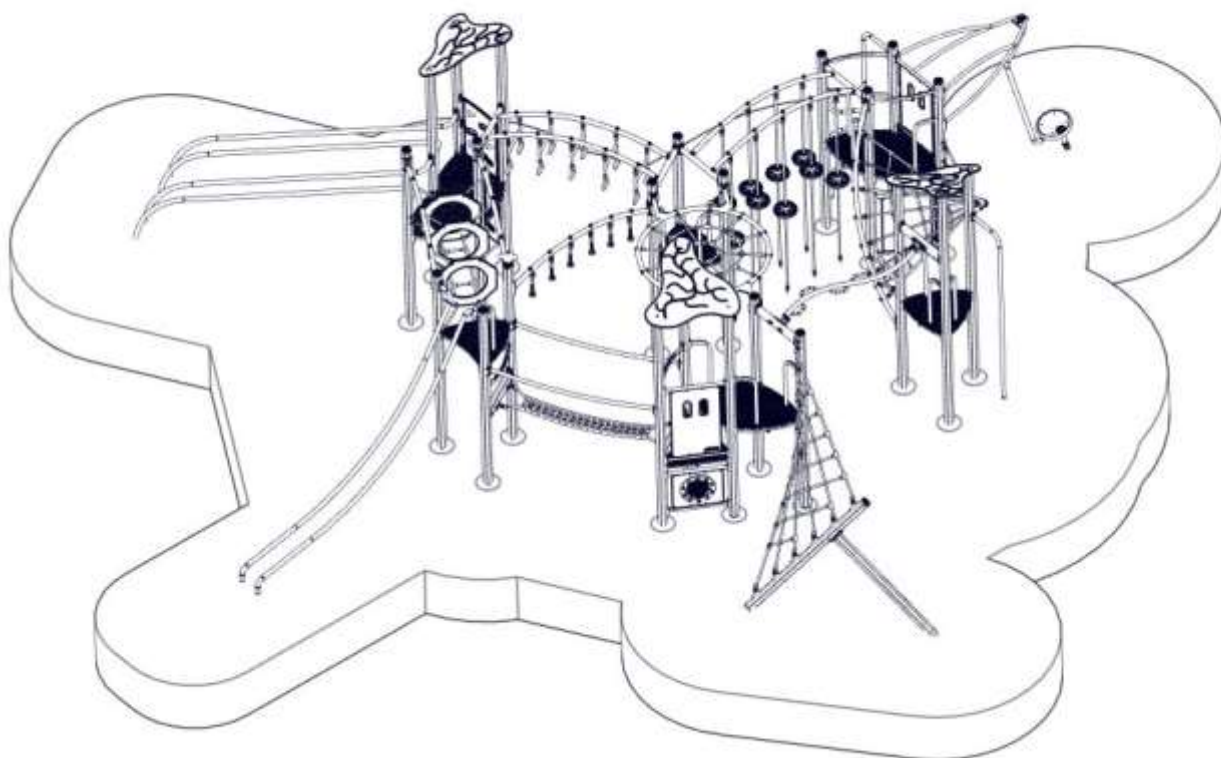

Søve AS  
Grønnvoldveien 290  
3830 Ulefoss - Norway  
Tlf: +47 35 94 65 65  
[www.sove.no](http://www.sove.no)



Søve AB  
EA Rosengrensgatan 32  
421 31 Västra Frölunda  
Phone: +46 (0)31 773 97 00  
[www.sove.se](http://www.sove.se)

## Monteringstips / Assembly Advice / Monteringsstips

N

- Les monteringsanvisningen nøye før montering.
- Monter elementene i rekkefølgen som vist.
- Boltene bør ikke skrues for hardt til før alt er montert, vatret og loddet. Skru så boltene til.
- NB! Ved bruk av drill, kan boltene ryke.
- På grunn av at solen kan gjøre rutsjeplaten veldig varm, bør rutsjebanens utløp vende mot nord-øst eller nord-vest.
- Er lekeutstyret plassert i naturlige ferdselstraséer må området sikres mot gjennomgang.
- Innspringningshinder bør vurderes rundt lekeapparater hvor det er stor bevegelse, f.eks. ved huskestativ.
- Det bør være fritt innsyn til lekeutstyr som er beregnet for barn under 3 år.

**NB! Under monteringsarbeidet må utstyr, som ikke er forankret forsvarlig i bakken, sikres slik at det ikke velte.**

**Området må avstenges under montering av apparatene med sperrebånd eller lignende.**

EN

- Read the instruction carefully before assembling the play unit.
- Assemble the components in the sequence shown in these instructions. Fixings must not be fully tightened during assembly. Before casting the foundations, the structure must be level and plumb, at which point all fixings are tightened. PS! If use of drill, the bolts may be wrecked.
- Avoid positioning the slide facing due south because of overheating – ideal positions are facing north-east or north-west. Secure the construction-area to prevent people from walking through it.
- Consider installing barriers around play-equipment which gives rise to a lot of activity – i.e. swings.
- Ensure that clear vision is possible across the play area so that supervision is possible from any position, particularly where children under 3 years of age will be playing.

**NB! During assembly of the equipment, ensure that all structures are securely propped, especially when left overnight. Also ensure that equipment is supported**

## Monteringstips / Assembly Advice / Monteringsstips

**S**

- Läs monteringsanvisningen noga före montering.

- Montera delarna i den ordningen som anvisas
- Skruvarna bör inte skruvas för hårt tills allt är monterat, i våg och lodat.









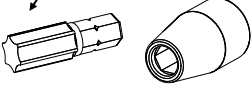

OBS! Används elektrisk skruvdragare, kan bulten gå sönder. Hårdra därför manuellt!

- Solen kan göra att rutchbanan blir väldigt varm. Banans nedfart rekommenderas att vändas i norrlig riktning
- Om lekplatsen placeras vid en gångväg mm bör området säkras mot genomfart av gående och cyklister.
- Insprängningshinder bör placeras runt lekutrustning med stor rörelse, t ex, gungställning.
- Det bör vara fri insyn till lekutrustning beräknat till barn under 3 år.

**OBS! Under monteringsarbete bör utrustningen som inte ska förankras i marken, ställs så att den inte kan välta.**

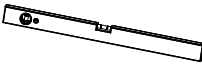
**Området måste spärras när lekutrustningen byggs upp, med avspärrningsband eller liknande.**

**Nødvendig verktøy / Tools required / Nödvändiga verktyg**

<p>(N)</p> <p>(UK)</p> <p>(S)</p>	<p>(A)</p> 	<p>(B)</p>  <p>Torx Nr 45 High quality</p> 	<p>(C)</p>  <p>13 + 17mm</p> 	<p>(D)</p> 	<p>(E)</p> 
		<p>Metermål</p> <p>Metric measure</p> <p>Tumstock</p> 	<p>16 V</p> 	<p>Merkebånd</p> <p>Mark ribbon</p> <p>Märkeband</p> 	<p>5 mm</p> <p>6 mm</p> 

**Nødvendig antall personer / Number of persons required / Lämpligt antal personer**

<p>(N)</p> <p>(UK)</p> <p>(S)</p>	
-----------------------------------	---

**Anbefalt arealbehov ved montering / Recommended working space / Rekommenderad arealbehov vid montering**

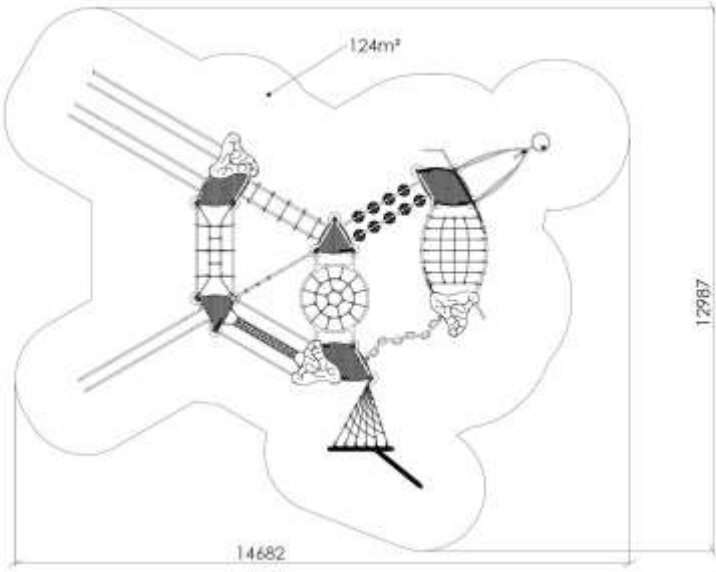
<p>(N)</p> <p>(UK)</p> <p>(S)</p>	
-----------------------------------	--

### Fallhøyder / Free height of fall / Fallhöjder

Fallhøyde = 3m

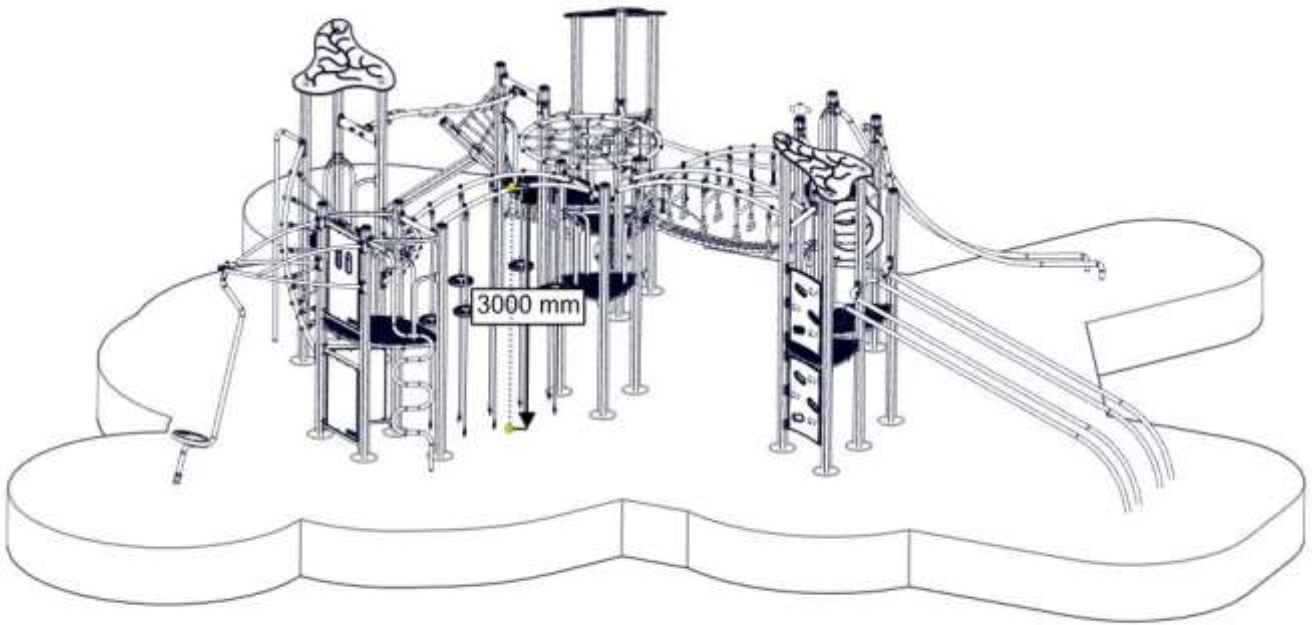

### Sikkerhetszone / Safety zone / Säkerhetszon

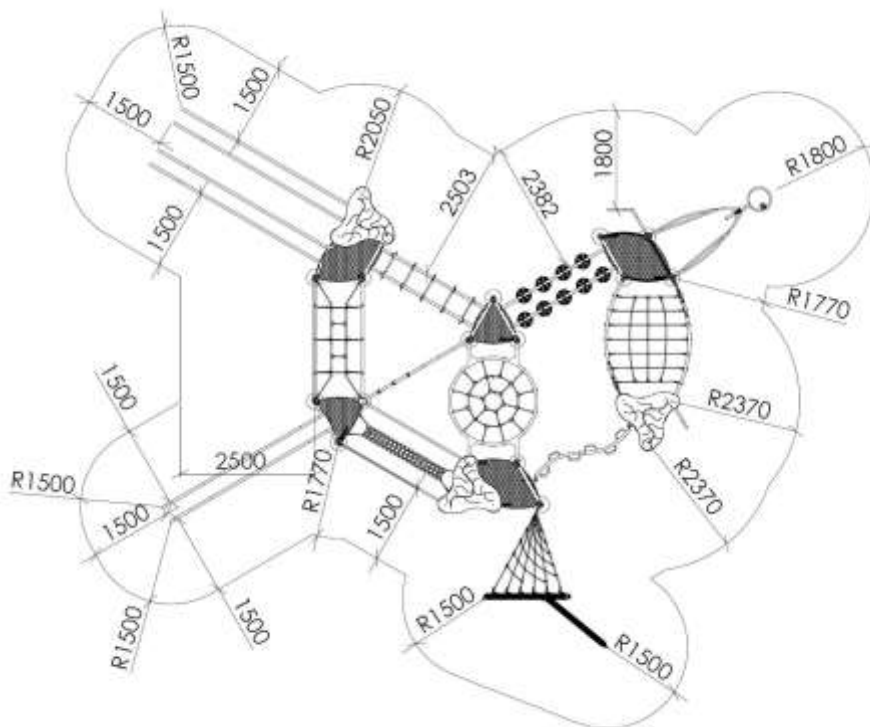



**Plassering av forankringer / Ground plan / Placering av förankringar**

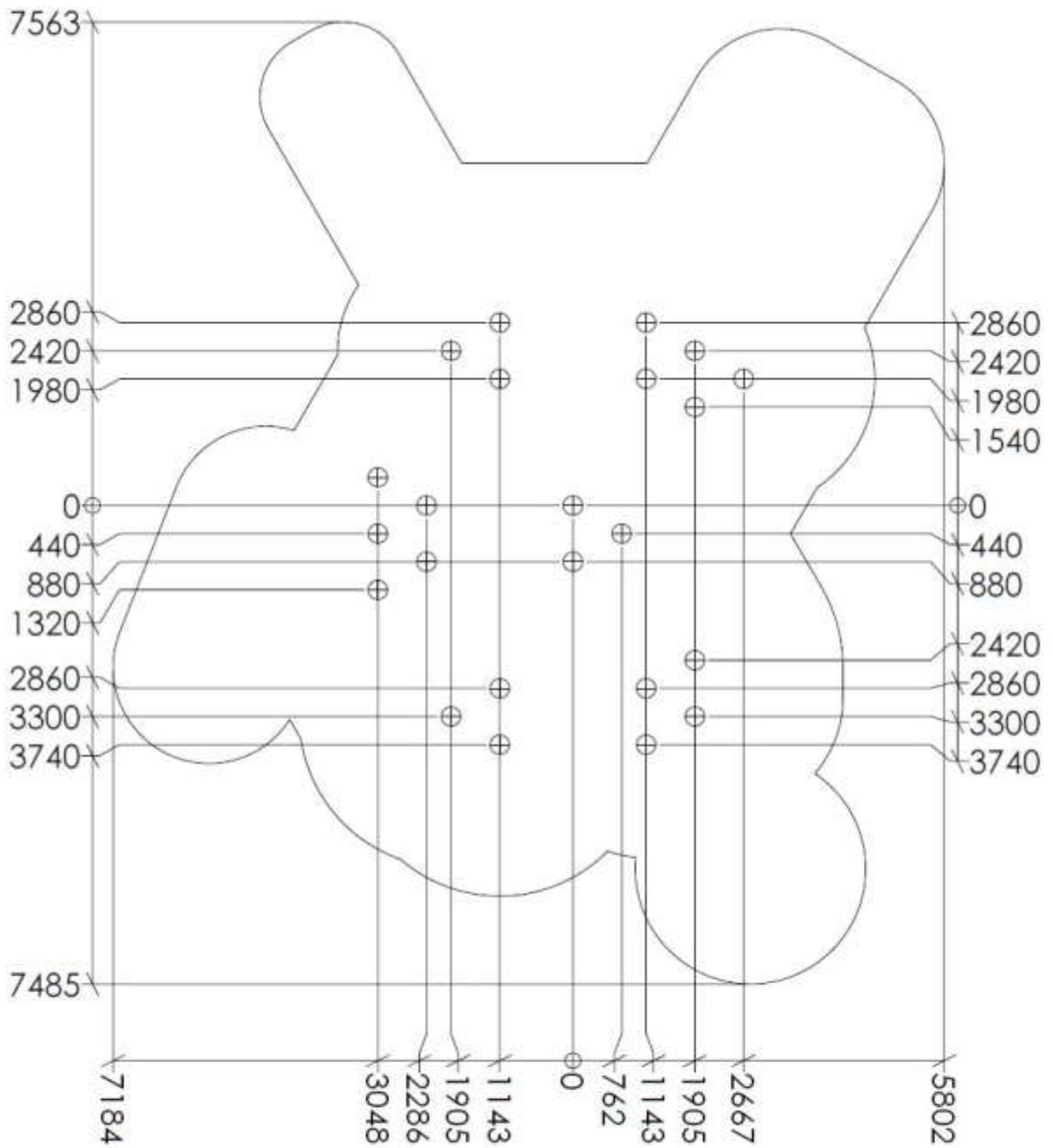

N

Alle mål er oppgitt i millimeter

UK

Scale measured in mm

S

Alla mått är i millimeter.

**Fundamentering uten betong / Foundation without concrete / Förankring utan betong**

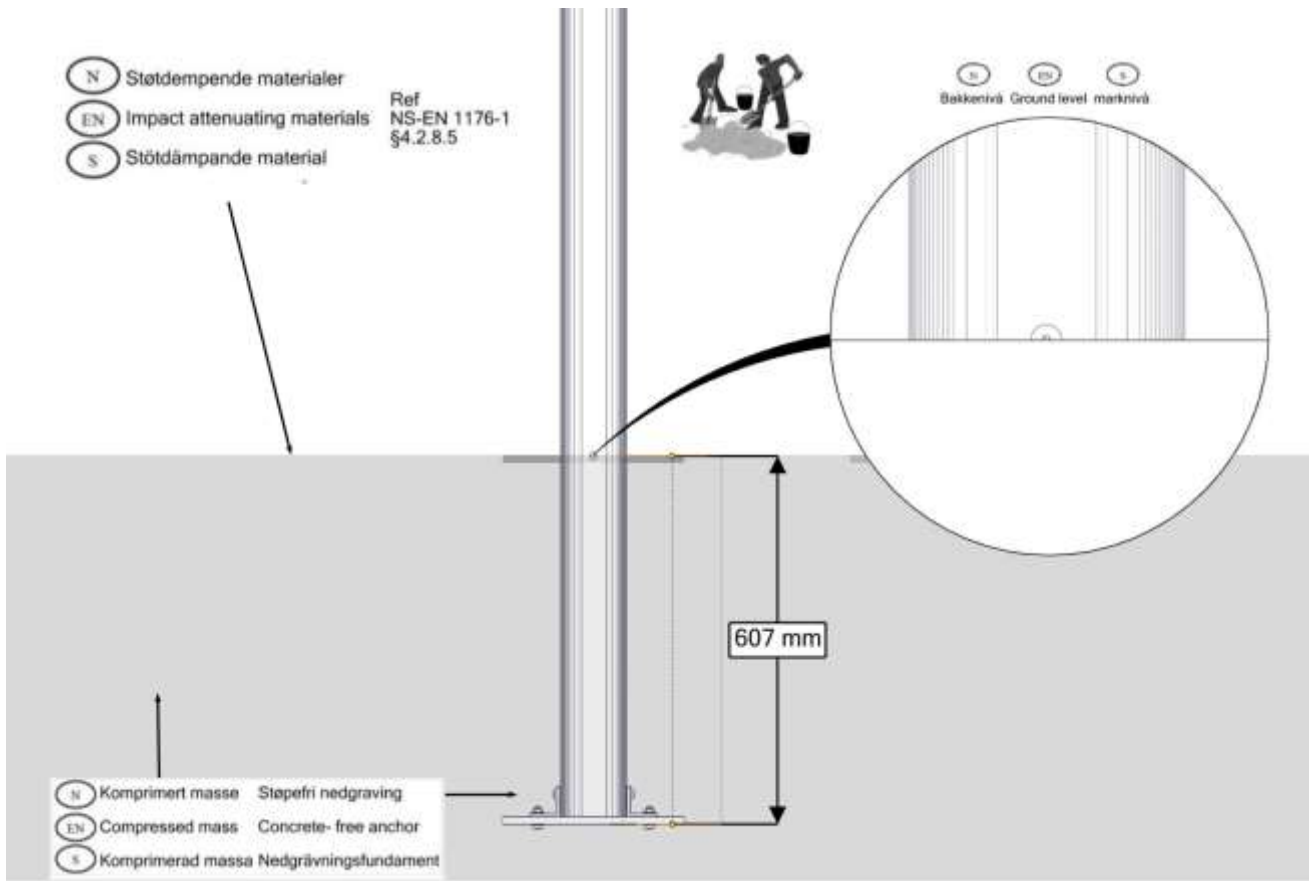



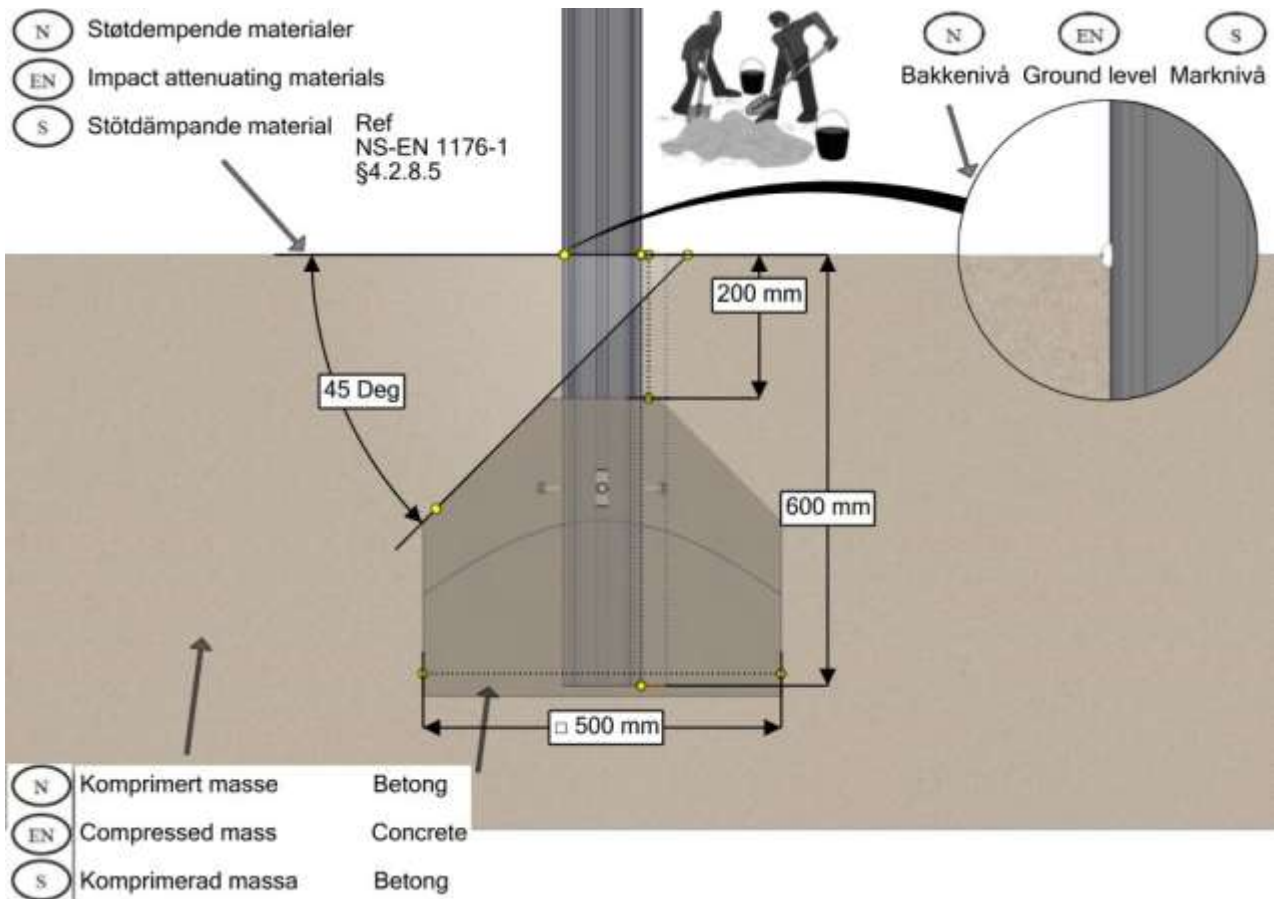

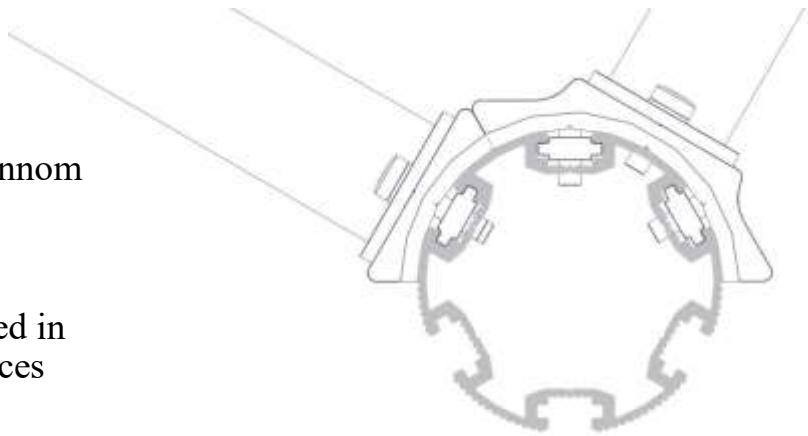



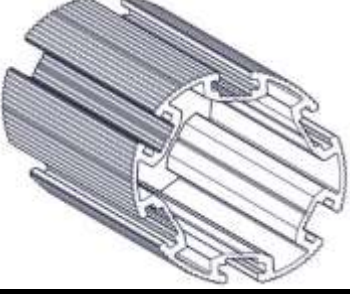

**Fundamentering med betong / Foundation concrete / Förankring med betong**





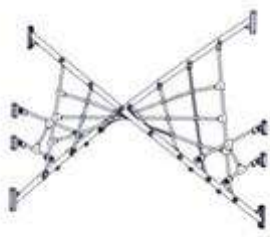





<p>(N) Bolten skrues HELT igjennom aluminiumen. Maks moment: 30Nm</p> <p>(EN) The bolt must be tightened in to the post, so that it peirces the aluminium Max torque: 30Nm</p> <p>(S) Bulten skivas HELT genom aluminiumen. Maks vridmoment: 30Nm</p>						
NO	Betongkvalitet	C25/30				
SE	Betongkvalitet					
EN	Concrete quality					
NO	Menge betong		2,6	m <sup>3</sup>		
SE	Mängd betong					
EN	Amount of concrete					
NO	Fundament størrelse		0,5 x 0,5 x 0,4	m		
SE	Stiftelsestorlek					
EN	Foundation size					
NO	For sikkerhet må fundamentene med sand eller myk jord være minst 50% større i areal					
SE	För säkerheten måste grunden med sand eller mjuk jord vara minst 50% större i området					
EN	For safety, the foundations with sand or soft soil must be at least 50% larger in area					
NO	Tyngste element	07-100-353	20	Kg		
SE	Tyngsta element					
EN	Heaviest element					
NO	Største element	07-100-353 07-200-010	4,4 x Ø0,11 4,2 x 0,7 x 0,5	m		
SE	Största element					
EN	Biggest element					



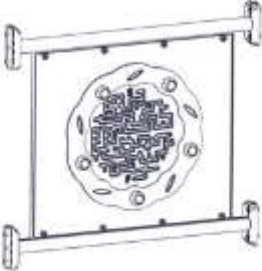

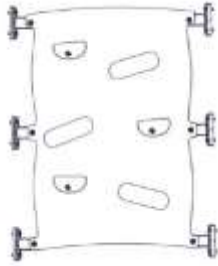

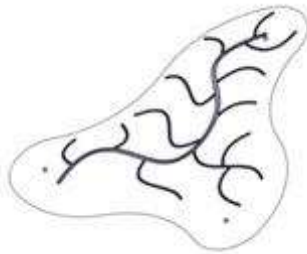
<b>Boltepakker for / Boltpackage for / Bultpaket för</b>		Sign. _____		
<b>Prekestolen 30-801-070</b>	<b>Navn</b>	<b>Artnr/ dimensjon</b>	<b>Ant</b>	<b>Lev</b>
	Stolpe Ø110 L=3450 Grå	SFA5126/2	14	
	Stolpe Ø110 L= 4050 Grå Skrå	07-100-352	6	
	Stolpe Ø110 L=4405 Grå Skrå	07-100-353	3	
	Gulv 3-kant CC880 Standard Grå	07-300-104K (se egen delmontering)	3	
	Gulv 3-kant CC880 1 Konkav Grå	07-300-105K (se egen delmontering)	1	
	Gulv 3-kant CC880 1 Rett Grå	07-300-106K (se egen delmontering)	1	
	Gulv 3-kant CC880 Dobbel Grå	07-301-102K (se egen delmontering)	3	
	Bevegelig Armgang CC880 Grønn	07-500-281K (se egen delmontering)	1	



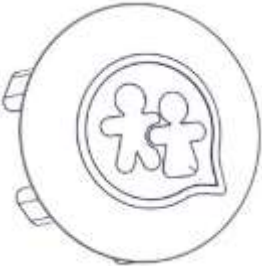

<b>Boltepakker for / Boltpackage for / Bultpaket för</b>		Sign. _____.		
<b>Prekestolen 30-801-070</b>	<b>Navn</b>	<b>Artnr/ dimensjon</b>	<b>Ant</b>	<b>Lev</b>
	Sluse H=790 Grønn	07-500-074K (se egen delmontering)	13	
	Bro tordert nett CC880 Grønn	07-500-311K (se egen delmontering)	1	
	Dobbel monkeyseat CC880 Grønn	07-500-425K (se egen delmontering)	1	
	Twistnett Grønn	07-500-440K (se egen delmontering)	1	
	HPL Bro CC880 Grønn	07-500-436K (se egen delmontering)	1	
	Bro med ringer CC880 Grønn	07-500-293K (se egen delmontering)	1	

<b>Boltepakker for / Boltpackage for / Bultpaket för</b>		Sign. _____		
<b>Prekestolen 30-801-070</b>	<b>Navn</b>	<b>Artnr/ dimensjon</b>	<b>Ant</b>	<b>Lev</b>
	Slider CC880	07-200-010K (se egen delmontering)	1	
	Brannstang Grå	07-200-037K (se egen delmontering)	1	
	Klatrestang Grå	07-200-038K (se egen delmontering)	1	
	Sperrerør bøyd CC880 Uten hull Grønn	07-500-072K (se egen delmontering)	4	
	Kikkert Beslag til Ø110 stolpe Rød	35-100-616K (se egen delmontering)	1	
	Labyrint / Maze CC880 Grønn plate	07-511-021K (se egen delmontering)	1	

<b>Boltepakker for / Boltpackage for / Bultpaket för</b>		Sign. _____.		
<b>Prekestolen 30-801-070</b>	<b>Navn</b>	<b>Artnr/ dimensjon</b>	<b>Ant</b>	<b>Lev</b>
	Klatreplate CC880 Grønn	07-500-476K (se egen delmontering)	2	
	Slider CC880 Grå	07-200-011K (se egen delmontering)	2	
	Produktmerke Med beslag til Ø110 stolpe	07-500-500 (se egen delmontering)	1	
	Tak 3-kant CC880 Grå	07-302-120K (se egen delmontering)	3	
	Rekkverk med vindu 620 x 1100 CC880 Grønn	07-302-102K (se egen delmontering)	2	
	Rekkverk 620 x 900 CC880 Grønn	07-302-105K (se egen delmontering)	2	

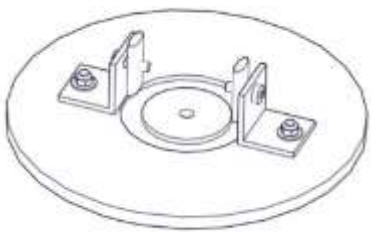
<b>Boltepakker for / Boltpackage for / Bultpaket för</b>		Sign. _____.		
<b>Prekestolen 30-801-070</b>	<b>Navn</b>	<b>Artnr/ dimensjon</b>	<b>Ant</b>	<b>Lev</b>
	Gangbro smal tett CC880 Grønn	07-500-364K (se egen delmontering)	1	
	Armgang med håndtak 30gr beslag Grønn	07-500-454K (se egen delmontering)	1	
	Stolpelokk Ø110	00-400-995	13	
	Swing CC880 Grønn	07-250-013K (se egen delmontering)	1	
	Bro rundgang CC880 Grønn	07-200-261K (se egen delmontering)	1	



<b>Boltepakker for / Boltpackage for / Bultpaket för</b>		Sign. _____		
<b>Prekestolen 30-801-070</b>	<b>Navn</b>	<b>Artnr/ dimensjon</b>	<b>Ant</b>	<b>Lev</b>
	<b>Fundament nedgraving</b>			
	Fundamentplate 1 x Ø110 stolpe	07-400-101K (se egen delmonering)	23	
	Sperrerør rett L=750mm Uten hull Sort	07-500-075K (Se egen delmontering)	28	
	<b>Fundament Støp</b>			
	Støpefundament Stolpe Ø110	00-003-111K (Se egen delmontering)	23	
	Sperrerør rett L=750mm Uten hull Sort	07-500-075K (Se egen delmontering)	28	

**Montering av lekeapparatet / Assembly instructions / Montering av lekredskapet**

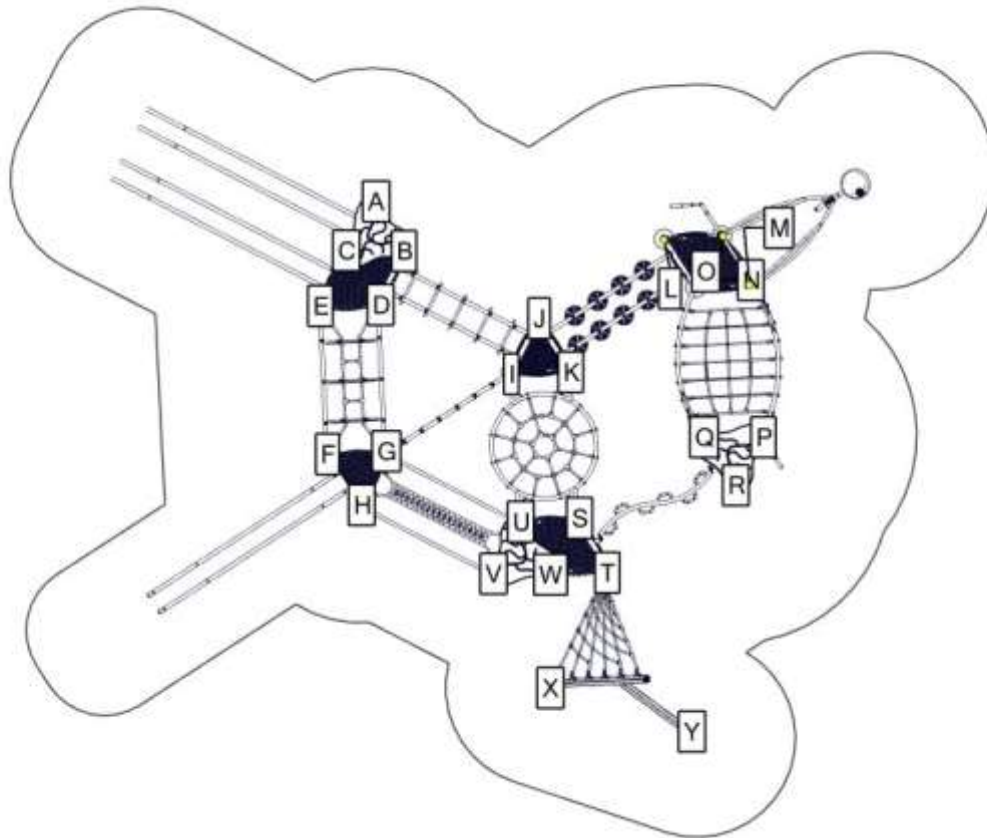

Se separat delmontering for detaljer  
 See separate assembly for details  
 Se separata delmontering för detaljer

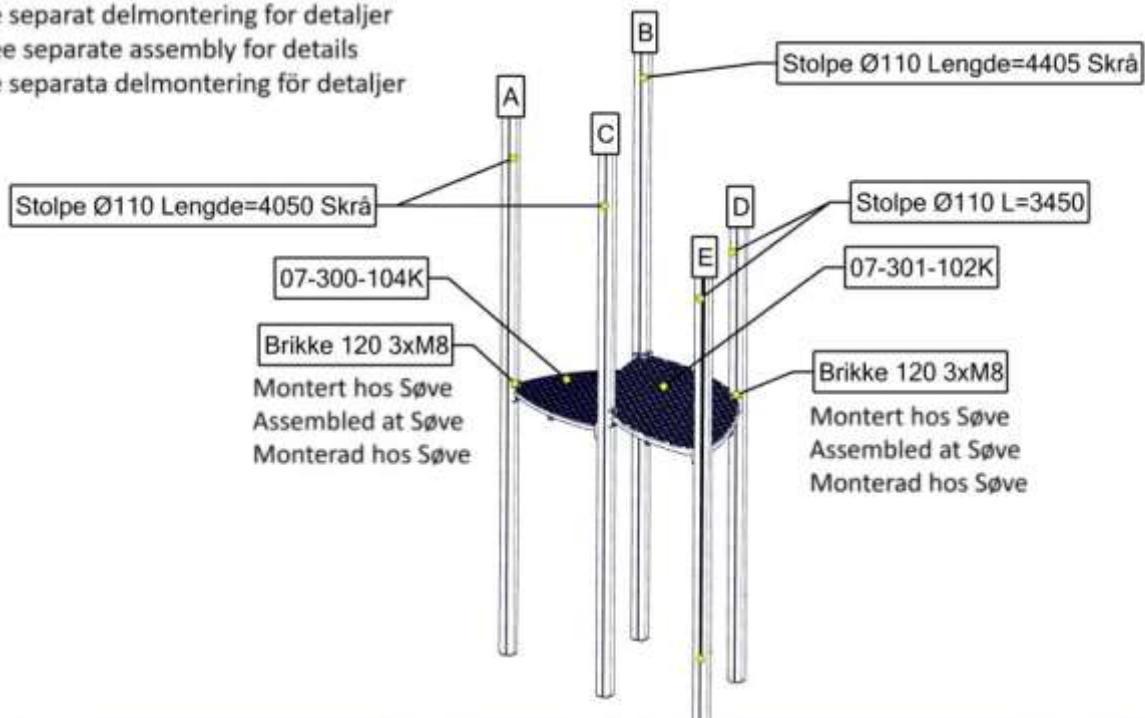

Part Name	Article nr.	Qty
Stolpe Ø110 Lengde=4405 Skrå	07-100-353	1
Stolpe Ø110 Lengde=4050 Skrå	07-100-352	2
Stolpe Ø110 L=3450 (2850-600)	SFA5126/2	2

Part Name	Article nr.	Qty
Gulv 3-kant CC8880 Dobbelt	07-301-102K	1
Gulv 3-kant 880x880 Standard	07-300-104K	1

Se separat delmontering for detaljer  
 See separate assembly for details  
 Se separata delmontering för detaljer

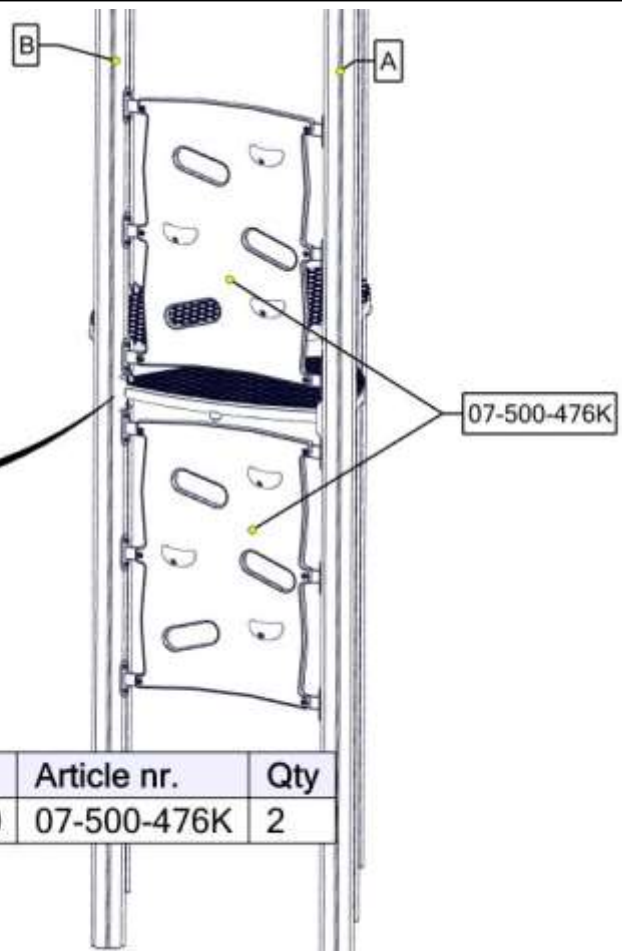
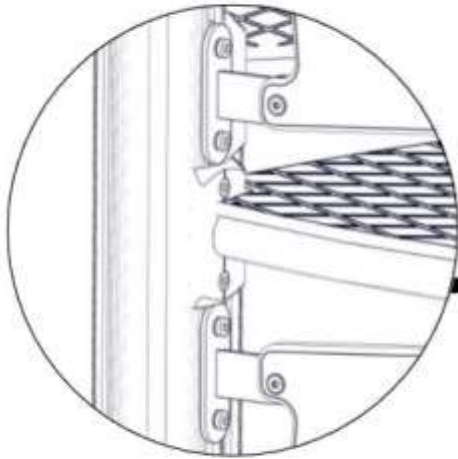

Part Name	Article nr.	Qty
Klatreplate CC880	07-500-476K	2

Se separat delmontering for detaljer  
 See separate assembly for details  
 Se separata delmontering för detaljer

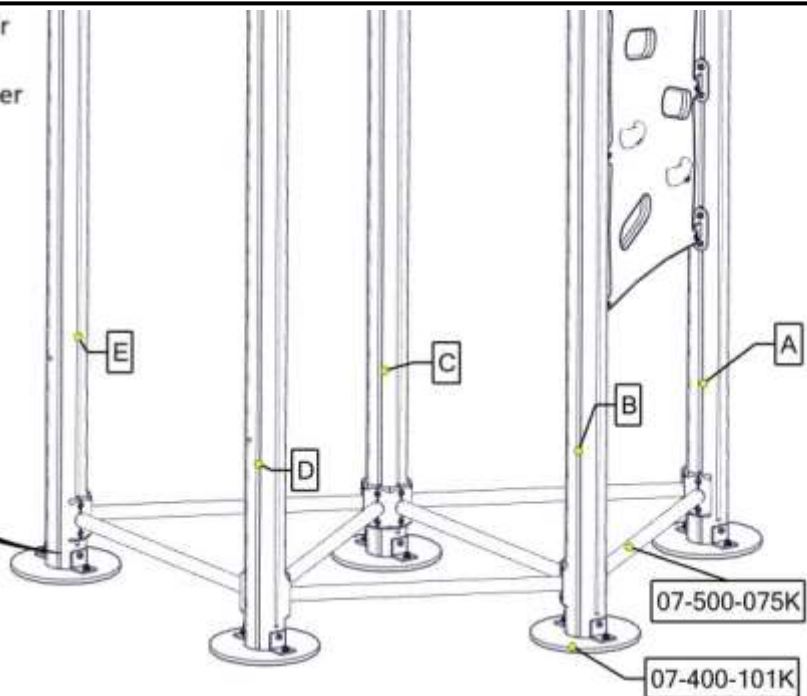
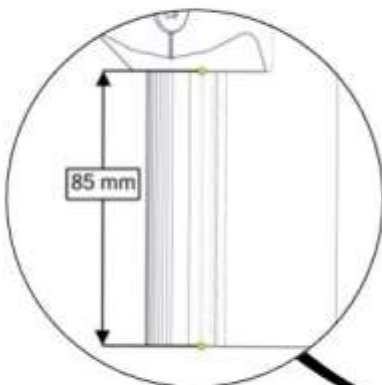

Part Name	Article nr.	Qty
Sperrerør rett L=750 uten hull	07-500-075K	7
Fundamentplate 1x110 stolpe komplett	07-400-101K	5

Se separat delmontering for detaljer  
 See separate assembly for details  
 Se separata delmontering för detaljer

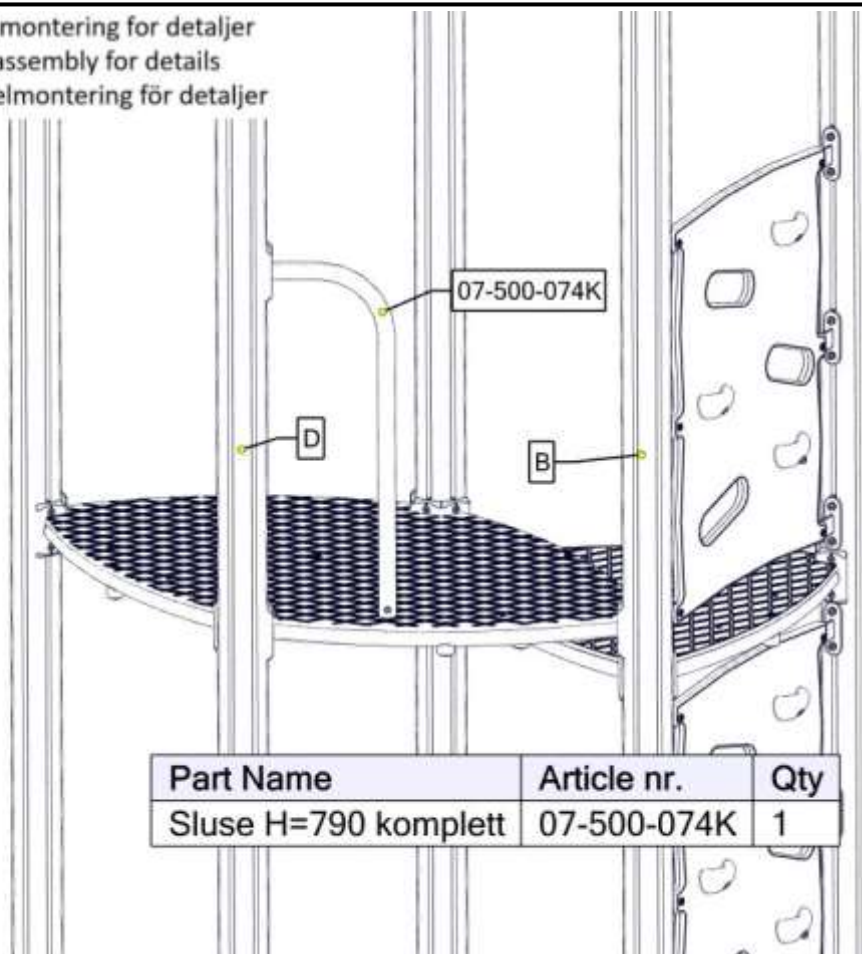

Part Name	Article nr.	Qty
Sluse H=790 komplett	07-500-074K	1

Se separat delmontering for detaljer  
 See separate assembly for details  
 Se separata delmontering för detaljer

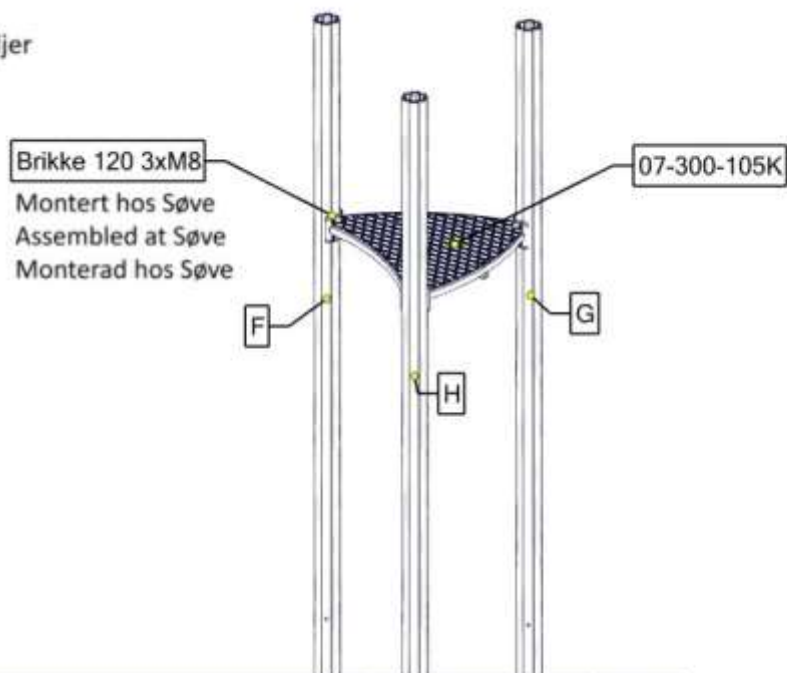

Part Name	Article nr.	Qty
Stolpe Ø110 L=3450 (2850-600)	SFA5126/2	3
Gulv 3-kant 880x880 1Konkav	07-300-105K	1

Se separat delmontering for detaljer  
 See separate assembly for details  
 Se separata delmontering för detaljer

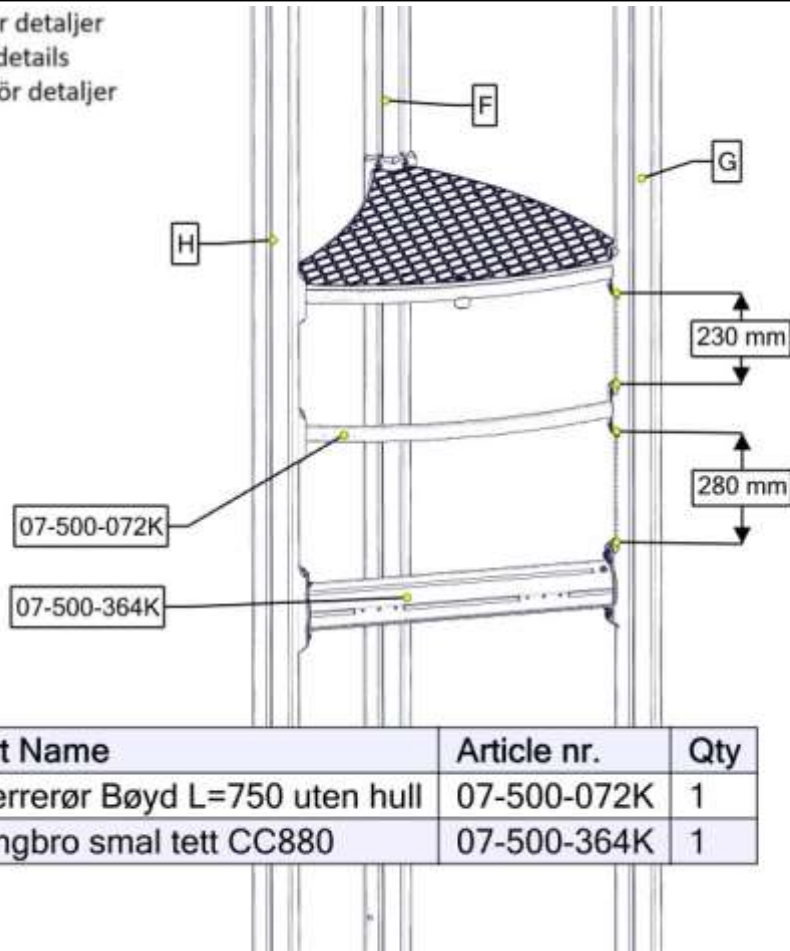

Part Name	Article nr.	Qty
Sperrerør Bøyd L=750 uten hull	07-500-072K	1
Gangbro smal tett CC880	07-500-364K	1

Se separat delmontering for detaljer  
 See separate assembly for details  
 Se separata delmontering för detaljer

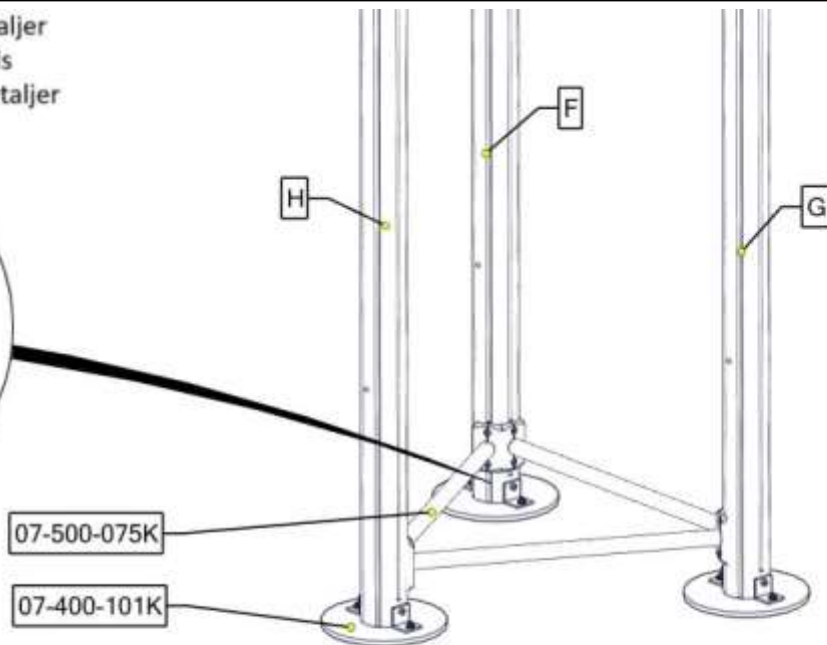
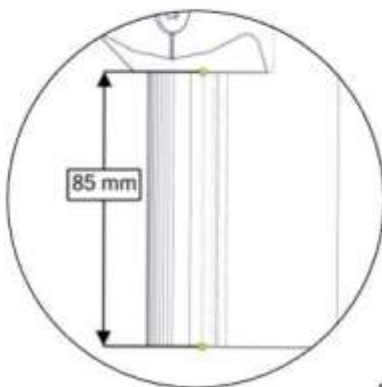

Part Name	Article nr.	Qty
Sperrerør rett L=750 uten hull	07-500-075K	3
Fundamentplate 1x110 stolpe komplett	07-400-101K	3



Se separat delmontering for detaljer  
 See separate assembly for details  
 Se separata delmontering för detaljer

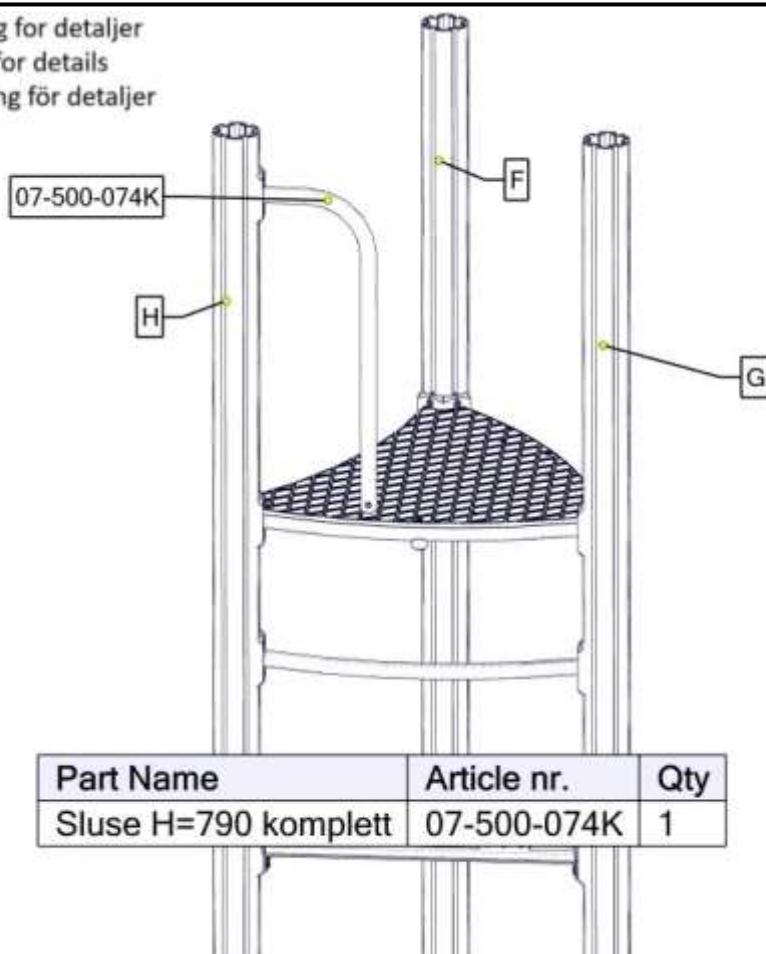

Part Name	Article nr.	Qty
Sluse H=790 komplett	07-500-074K	1

Se separat delmontering for detaljer  
 See separate assembly for details  
 Se separata delmontering för detaljer

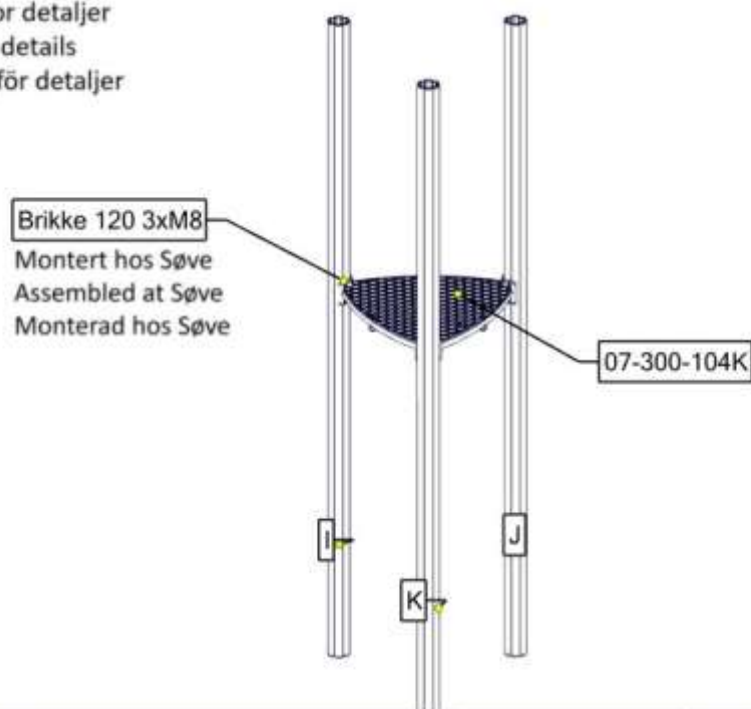

Part Name	Article nr.	Qty
Stolpe Ø110 L=3450 (2850-600)	SFA5126/2	3
Gulv 3-kant 880x880 Standard	07-300-104K	1

Se separat delmontering for detaljer  
 See separate assembly for details  
 Se separata delmontering för detaljer

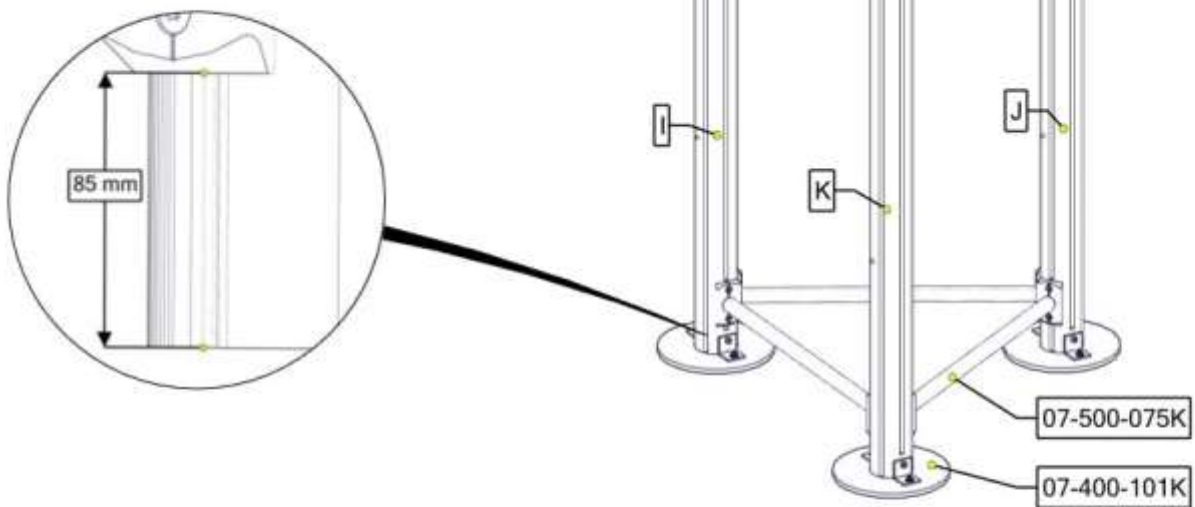

Part Name	Article nr.	Qty
Sperrerør rett L=750 uten hull	07-500-075K	3
Fundamentplate 1x110 stolpe komplett	07-400-101K	3

Se separat delmontering for detaljer  
 See separate assembly for details  
 Se separata delmontering för detaljer

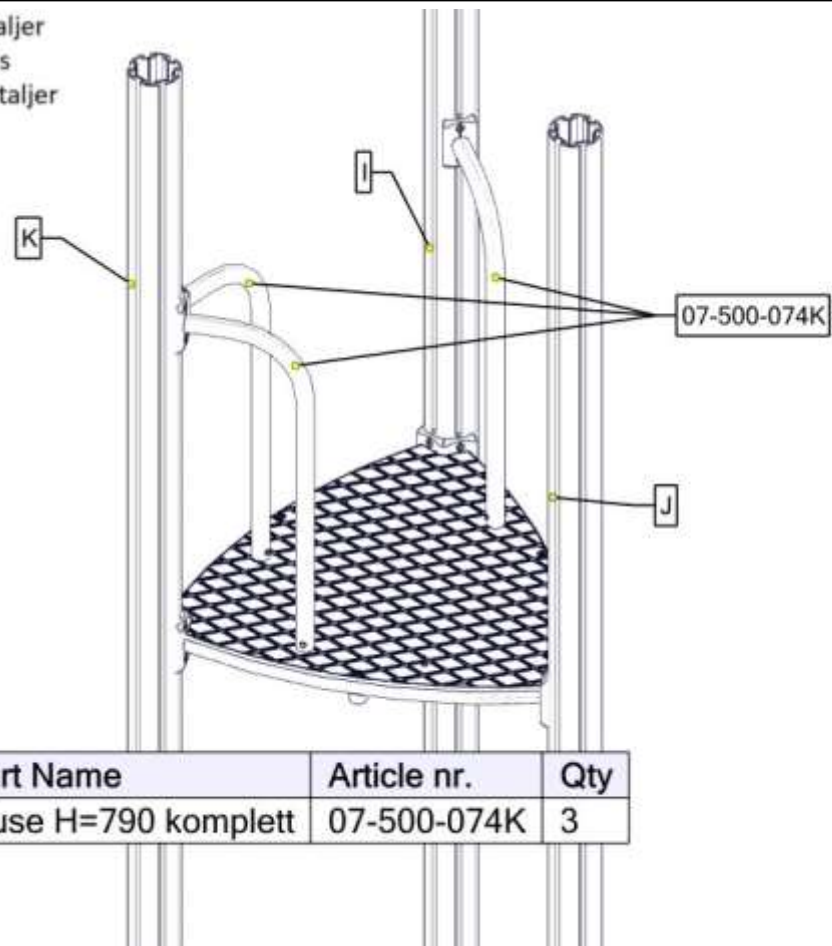

Part Name	Article nr.	Qty
Sluse H=790 komplett	07-500-074K	3

Se separat delmontering for detaljer  
 See separate assembly for details  
 Se separata delmontering för detaljer

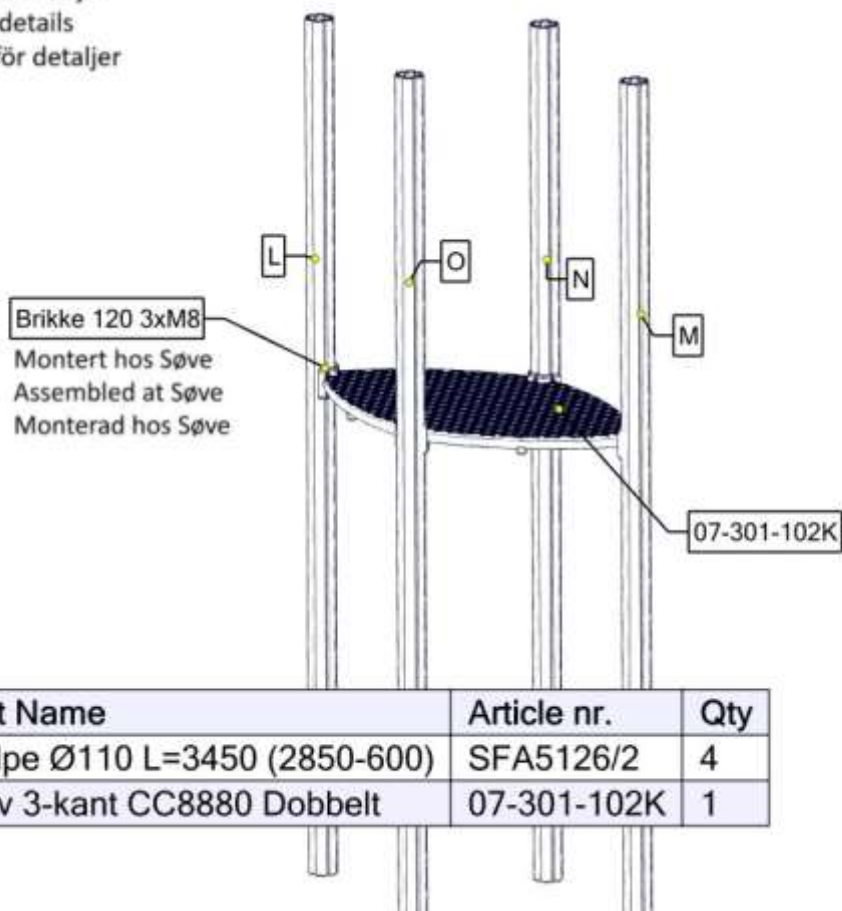

Part Name	Article nr.	Qty
Stolpe Ø110 L=3450 (2850-600)	SFA5126/2	4
Gulv 3-kant CC8880 Dobbelt	07-301-102K	1

Se separat delmontering for detaljer  
 See separate assembly for details  
 Se separata delmontering för detaljer

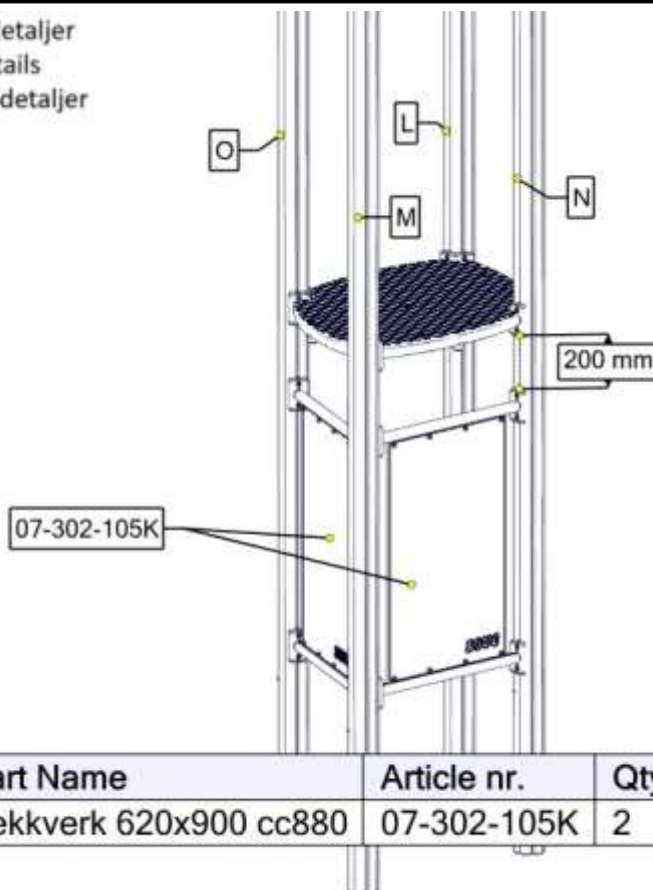

Part Name	Article nr.	Qty
Rekkverk 620x900 cc880	07-302-105K	2

Se separat delmontering for detaljer  
 See separate assembly for details  
 Se separata delmontering för detaljer

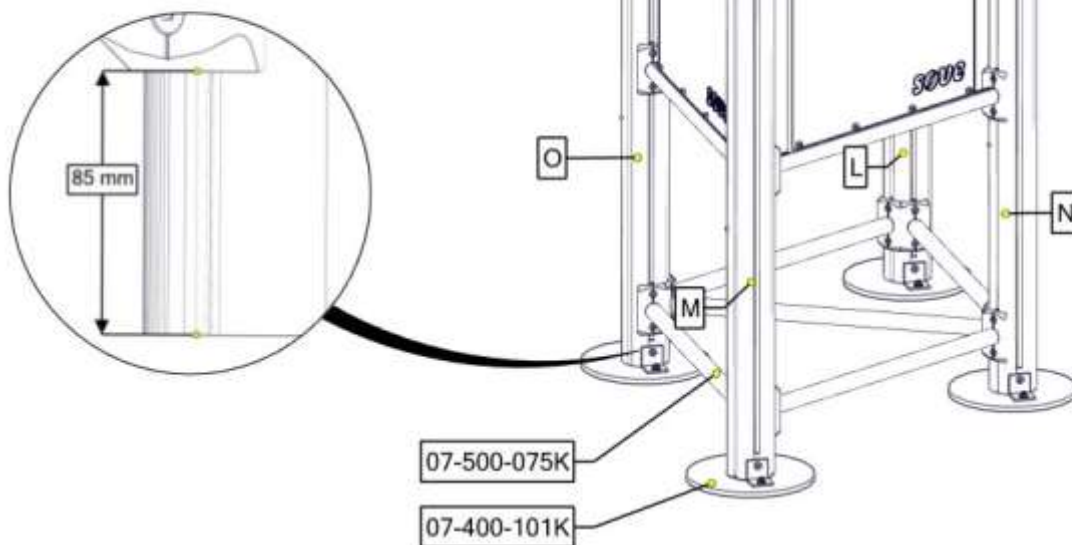

Part Name	Article nr.	Qty
Sperrerør rett L=750 uten hull	07-500-075K	5
Fundamentplate 1x110 stolpe komplett	07-400-101K	4

Se separat delmontering for detaljer  
 See separate assembly for details  
 Se separata delmontering för detaljer

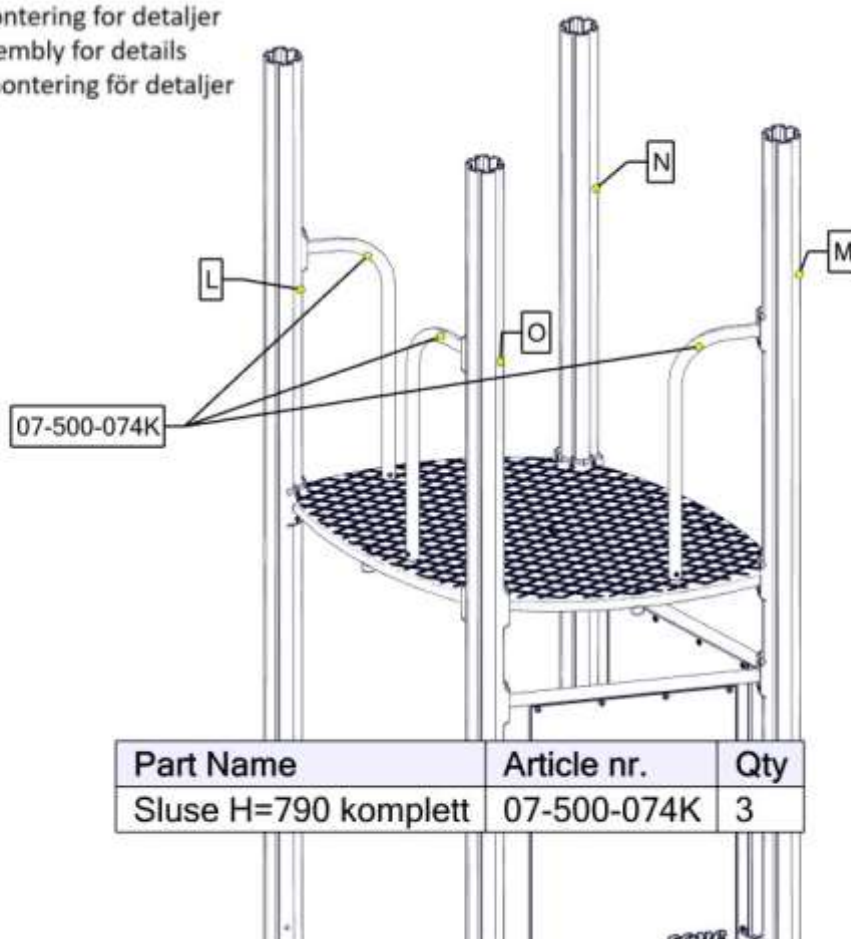

Part Name	Article nr.	Qty
Sluse H=790 komplett	07-500-074K	3

Se separat delmontering for detaljer  
 See separate assembly for details  
 Se separata delmontering för detaljer

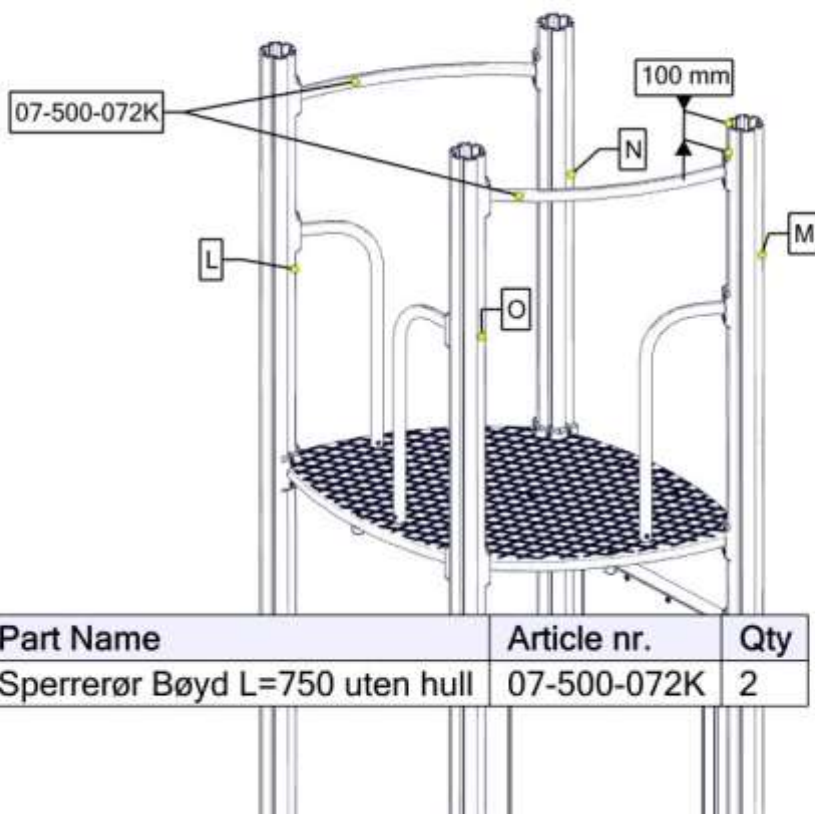

Part Name	Article nr.	Qty
Sperrerør Bøyd L=750 uten hull	07-500-072K	2

Se separat delmontering for detaljer  
 See separate assembly for details  
 Se separata delmontering för detaljer

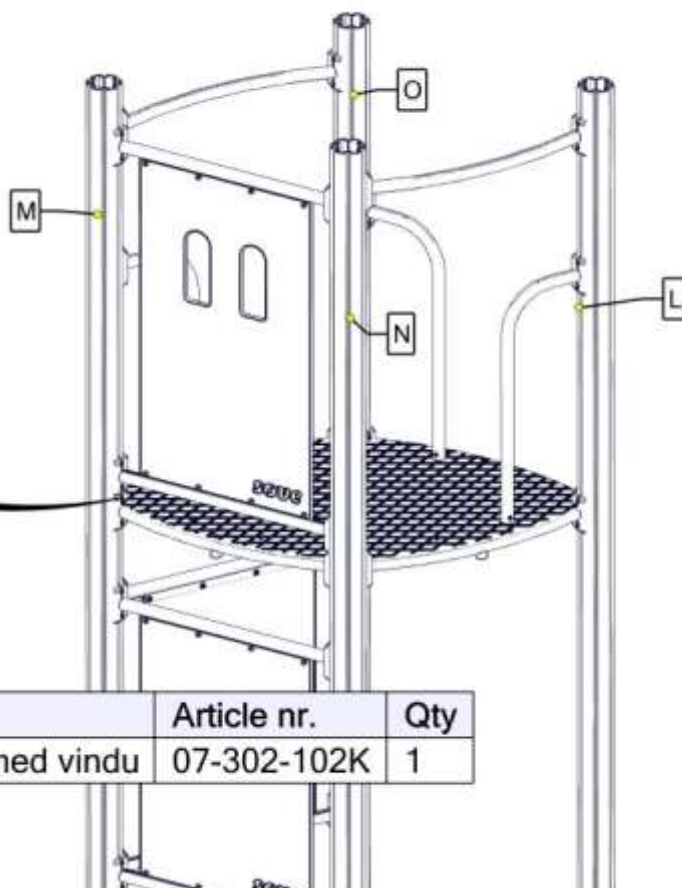
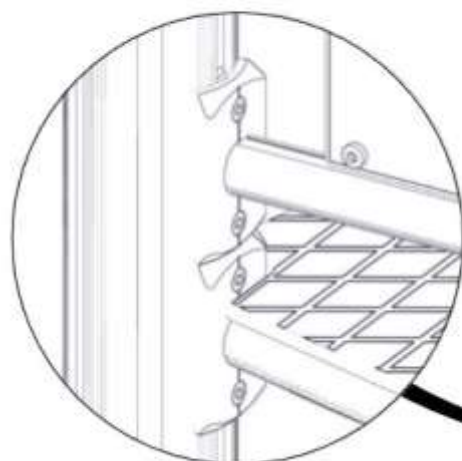

Part Name	Article nr.	Qty
Rekkverk 620 x 1100 med vindu	07-302-102K	1



Se separat delmontering for detaljer  
 See separate assembly for details  
 Se separata delmontering för detaljer

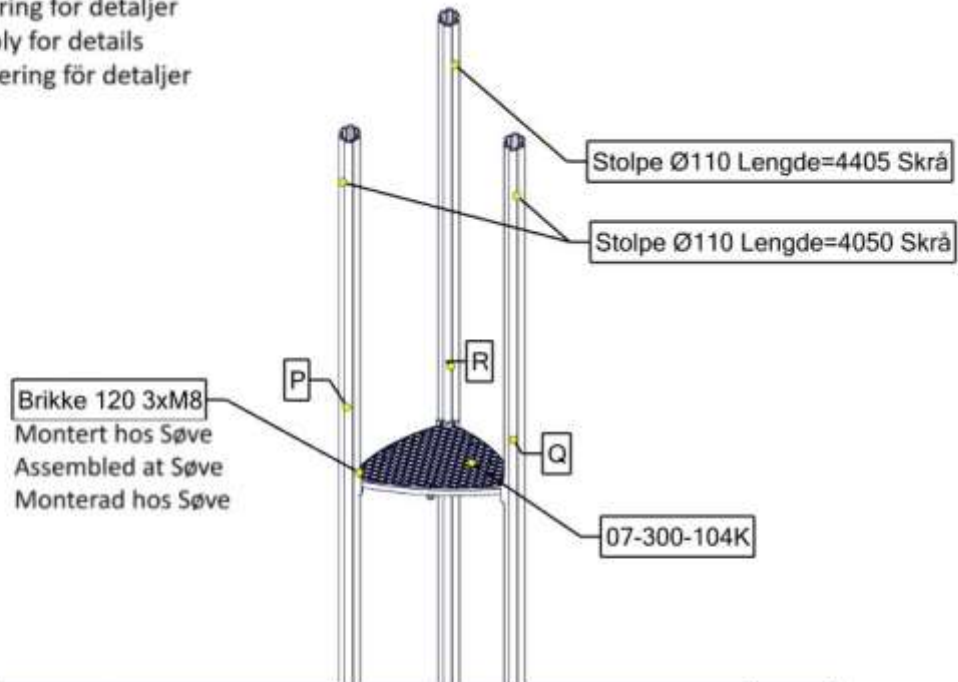

Part Name	Article nr.	Qty
Stolpe Ø110 Lengde=4405 Skrå	07-100-353	1
Stolpe Ø110 Lengde=4050 Skrå	07-100-352	2
Gulv 3-kant 880x880 Standard	07-300-104K	1

Se separat delmontering for detaljer  
 See separate assembly for details  
 Se separata delmontering för detaljer

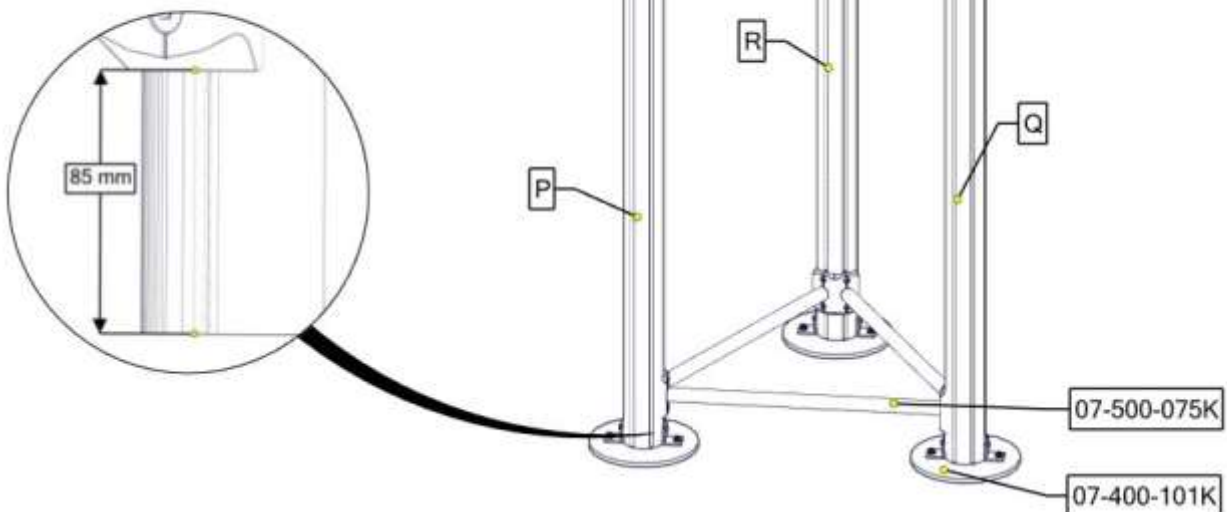

Part Name	Article nr.	Qty
Sperrerør rett L=750 uten hull	07-500-075K	3
Fundamentplate 1x110 stolpe komplett	07-400-101K	3

Se separat delmontering for detaljer  
 See separate assembly for details  
 Se separata delmontering för detaljer

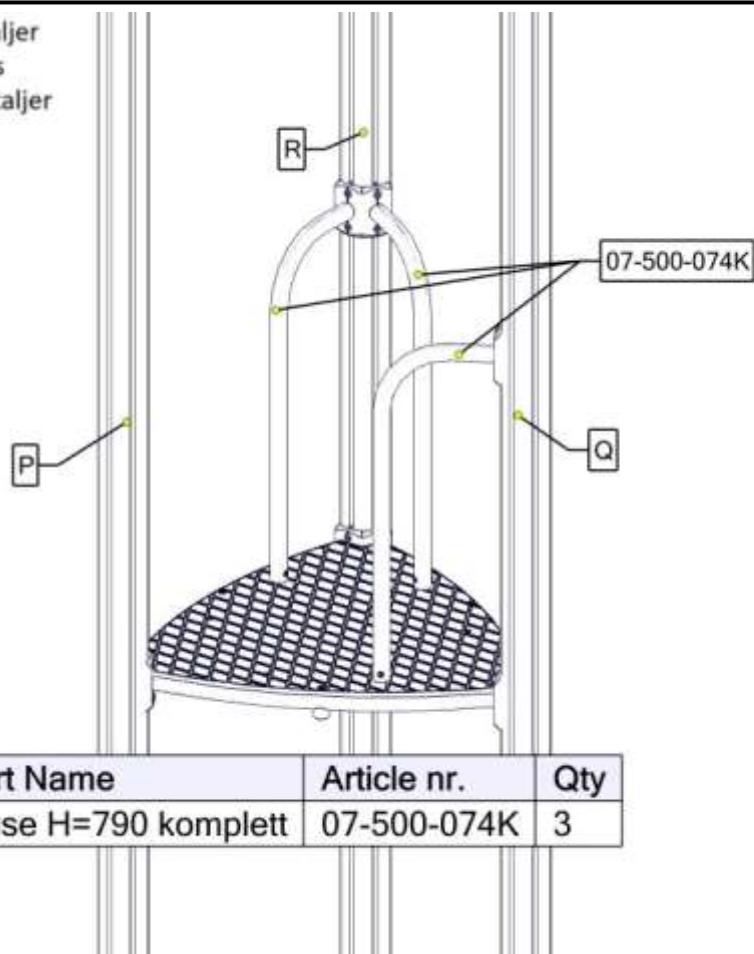

Part Name	Article nr.	Qty
Sluse H=790 komplett	07-500-074K	3

Se separat delmontering for detaljer  
 See separate assembly for details  
 Se separata delmontering för detaljer

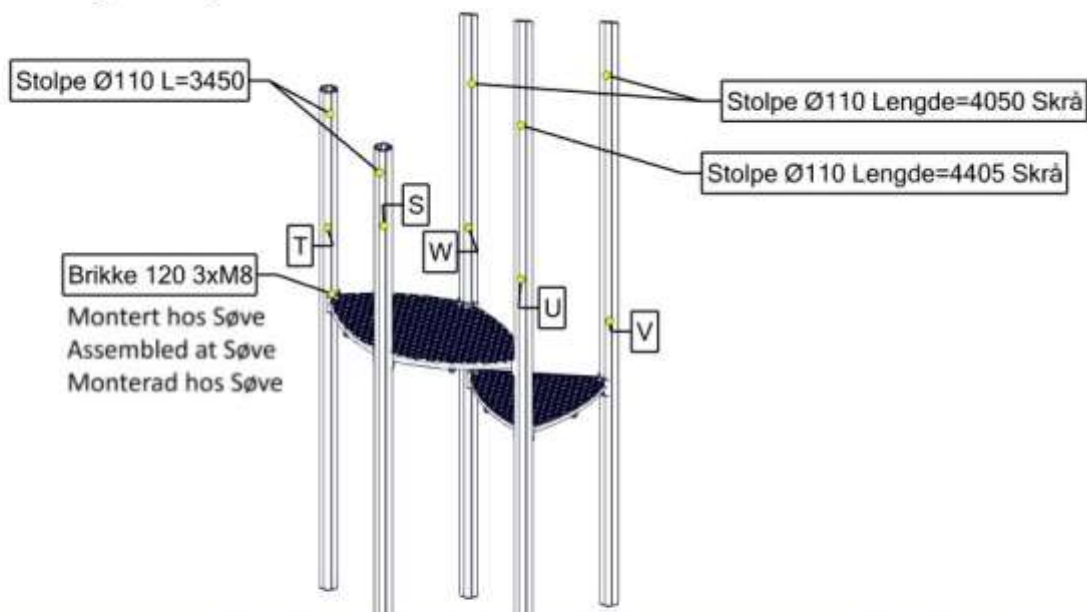

Part Name	Article nr.	Qty	Part Name	Article nr.	Qty
Stolpe Ø110 Lengde=4405 Skrå	07-100-353	1	Gulv 3-kant CC8880 Dobbelt	07-301-102K	1
Stolpe Ø110 Lengde=4050 Skrå	07-100-352	2	Gulv 3-kant 880x880 1Rett	07-300-106K	1
Stolpe Ø110 L=3450 (2850-600)	SFA5126/2	2			

Se separat delmontering for detaljer  
 See separate assembly for details  
 Se separata delmontering för detaljer



07-511-021K

V

W

Part Name	Article nr.	Qty
Rekkverk Labirint/Maze grønn CC880	07-511-021K	1

Se separat delmontering for detaljer  
 See separate assembly for details  
 Se separata delmontering för detaljer

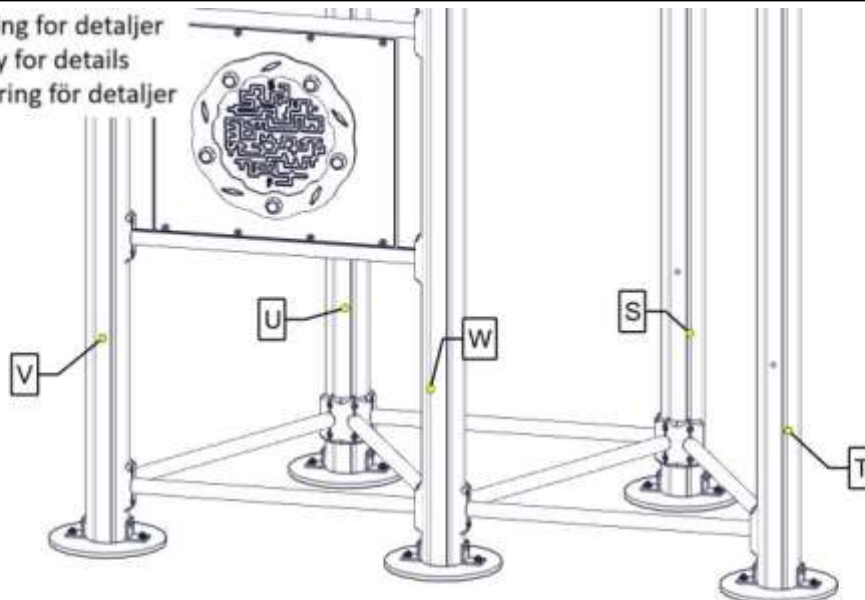

Part Name	Article nr.	Qty
Sperrerør rett L=750 uten hull	07-500-075K	7
Fundamentplate 1x110 stolpe komplett	07-400-101K	5

Se separat delmontering for detaljer  
 See separate assembly for details  
 Se separata delmontering för detaljer

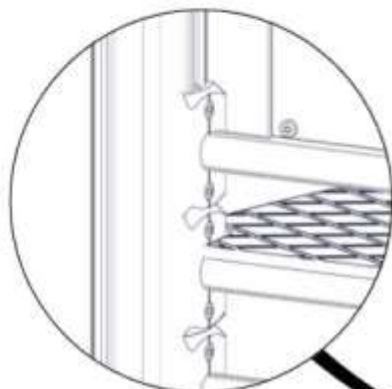

07-302-102K

V

W

Søve

Part Name	Article nr.	Qty
Rekkverk 620 x 1100 med vindu	07-302-102K	1

S

T

Se separat delmontering for detaljer  
 See separate assembly for details  
 Se separata delmontering för detaljer

U

07-500-364K

V

Part Name	Article nr.	Qty
Gangbro smal tett CC880	07-500-364K	1



Se separat delmontering for detaljer  
 See separate assembly for details  
 Se separata delmontering för detaljer

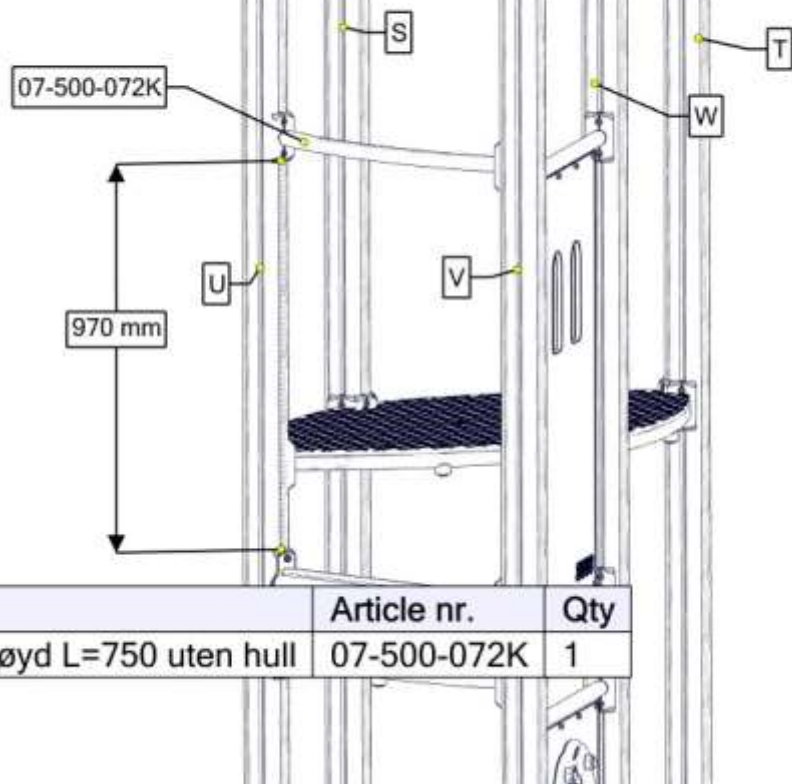

Part Name	Article nr.	Qty
Sperrerør Bøyd L=750 uten hull	07-500-072K	1

Se separat delmontering for detaljer  
 See separate assembly for details  
 Se separata delmontering för detaljer

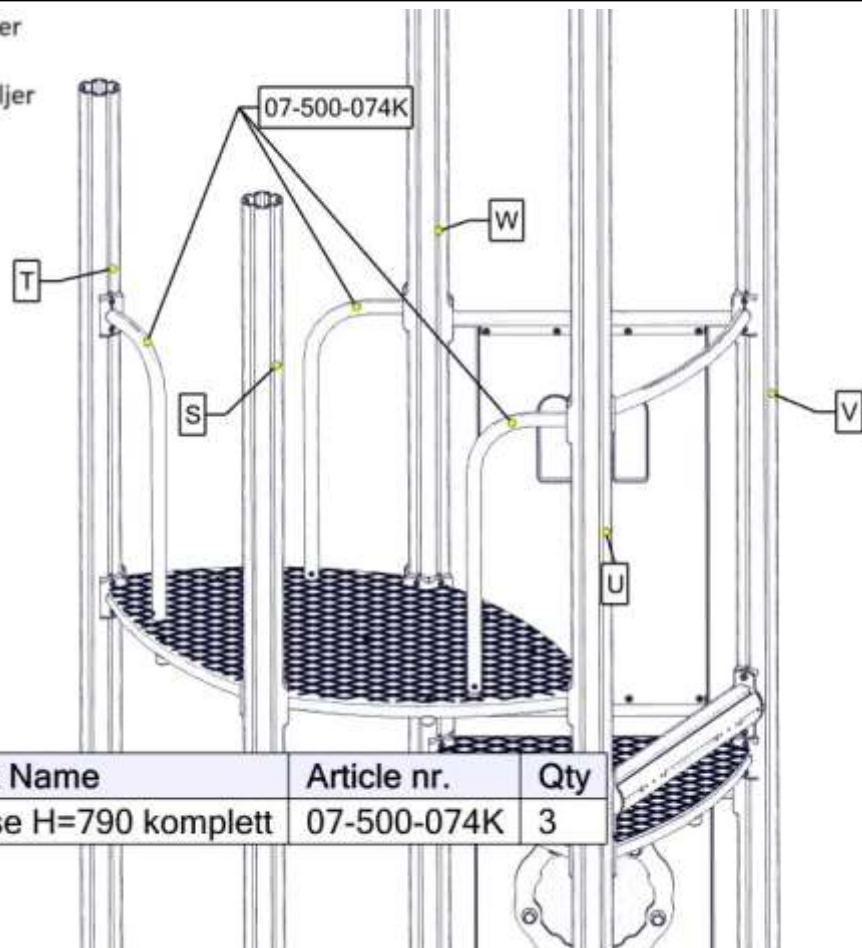

Part Name	Article nr.	Qty
Sluse H=790 komplett	07-500-074K	3



Se separat delmontering for detaljer  
 See separate assembly for details  
 Se separata delmontering för detaljer

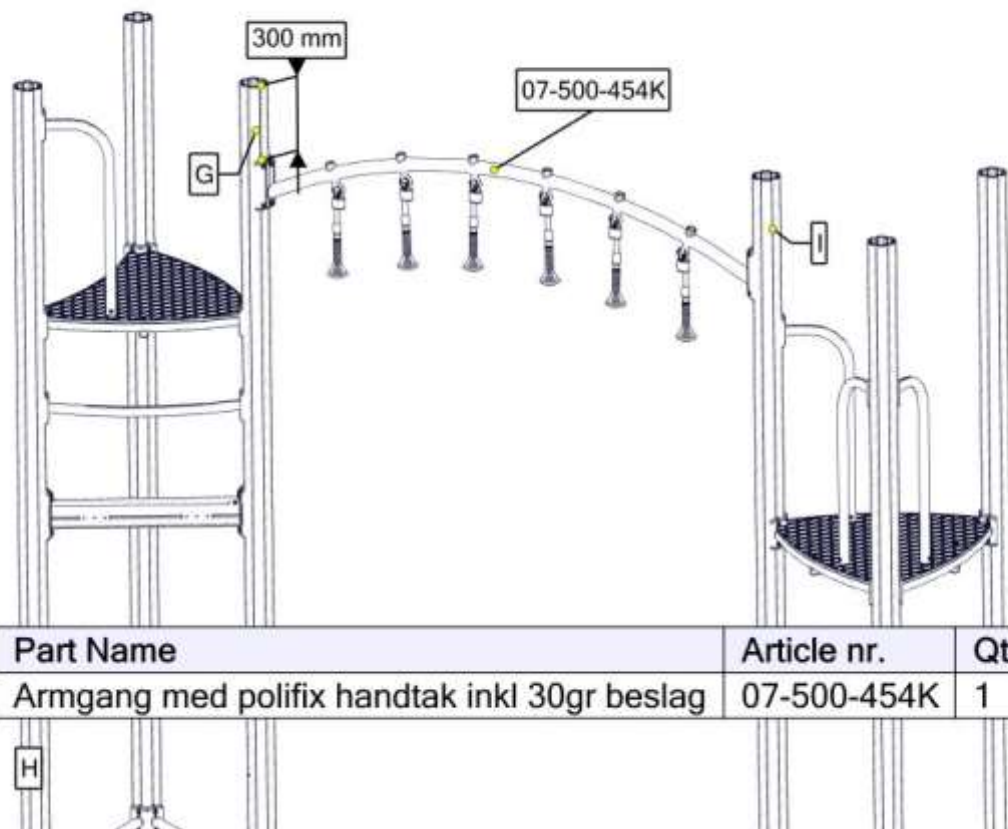

Part Name	Article nr.	Qty
Armgang med polifix handtak inkl 30gr beslag	07-500-454K	1

Se separat delmontering for detaljer  
 See separate assembly for details  
 Se separata delmontering för detaljer

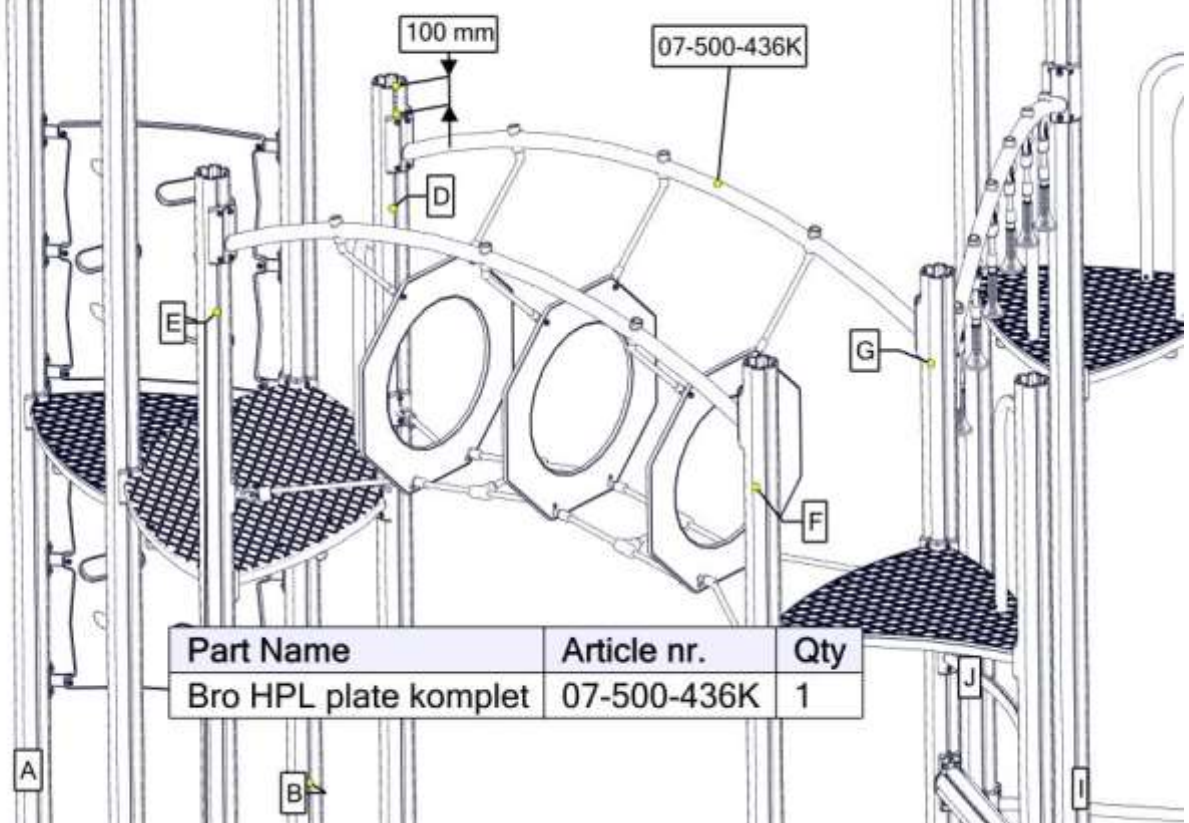

Part Name	Article nr.	Qty
Bro HPL plate komplet	07-500-436K	1

Se separat delmontering for detaljer  
 See separate assembly for details  
 Se separata delmontering för detaljer

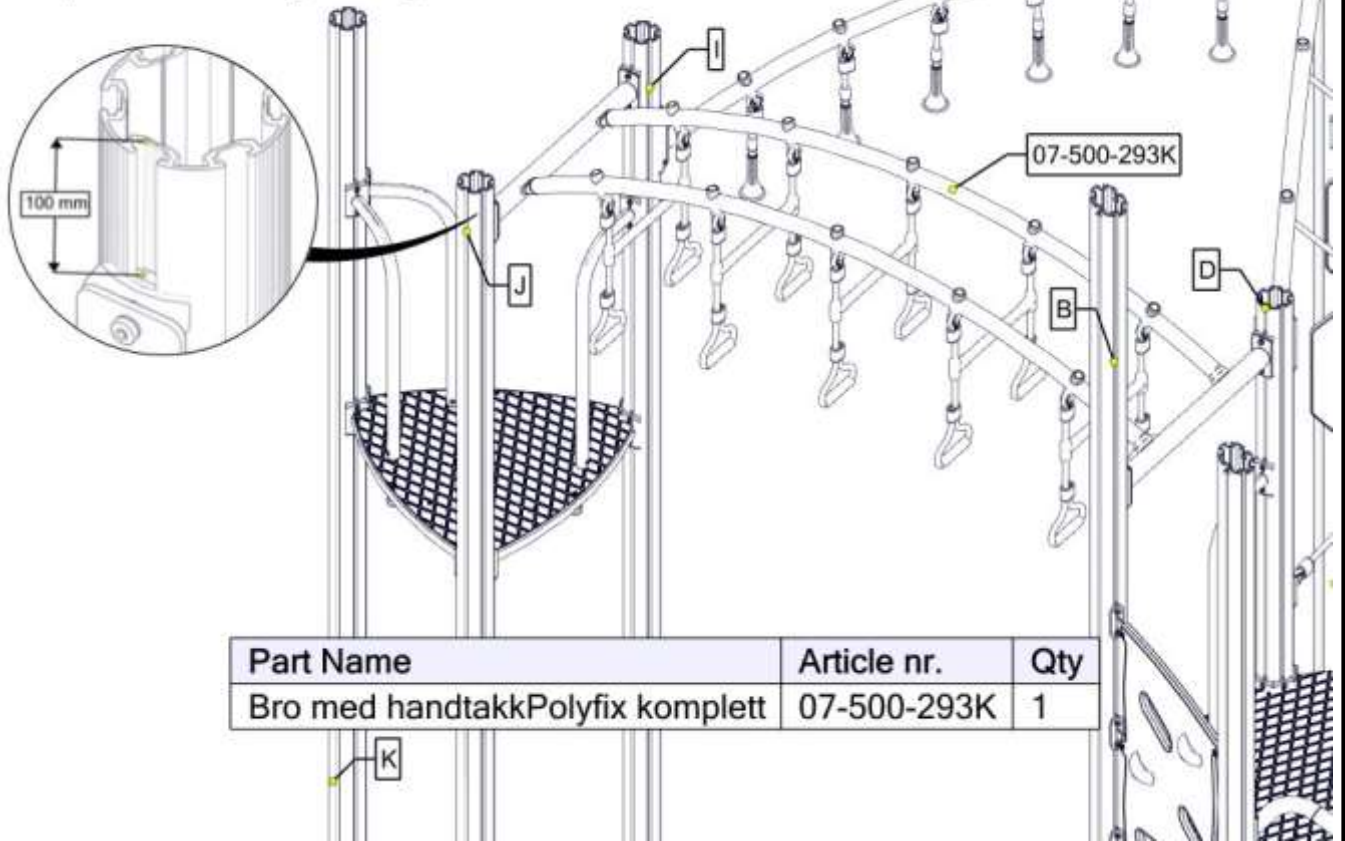

Se separat delmontering for detaljer  
 See separate assembly for details  
 Se separata delmontering för detaljer

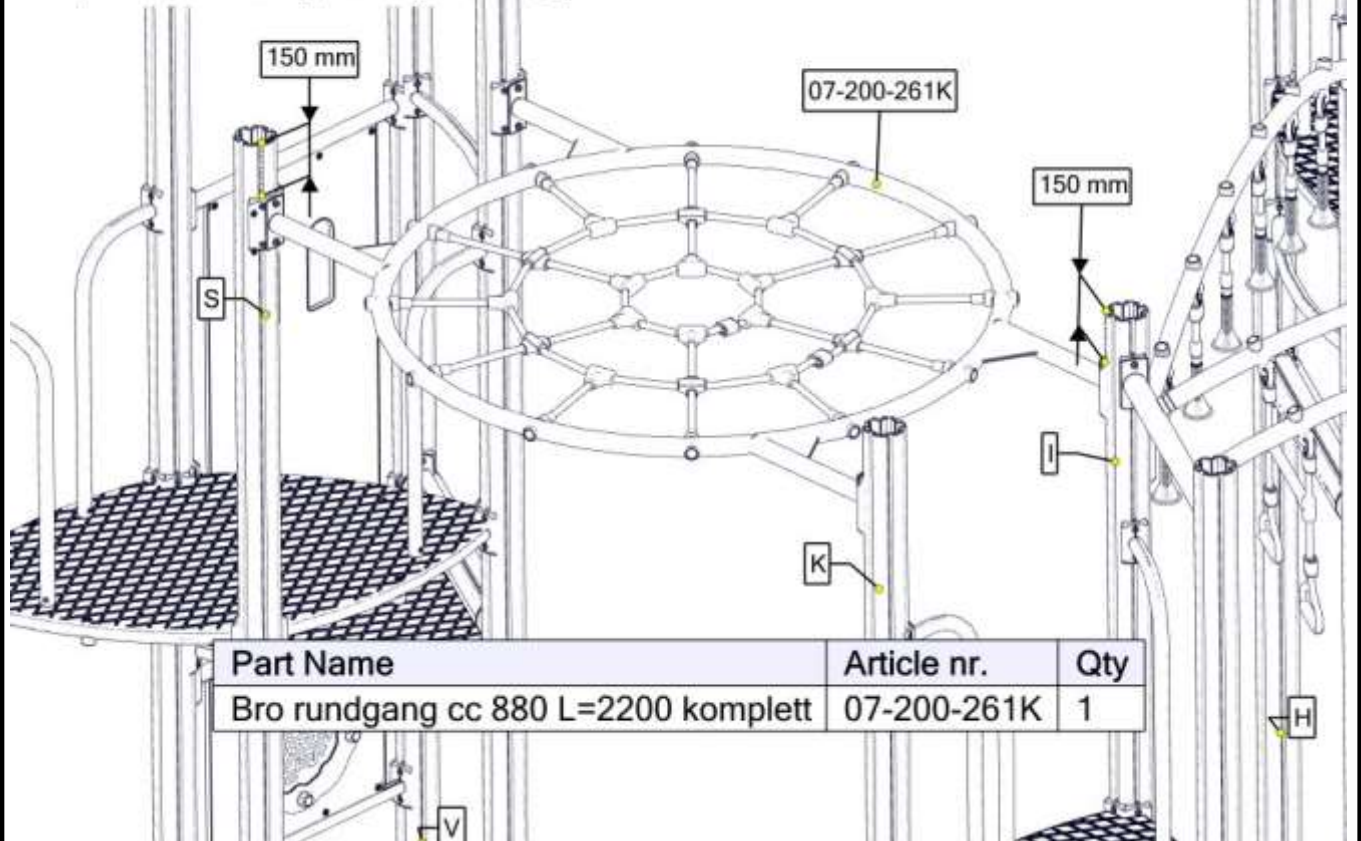



Se separat delmontering for detaljer  
 See separate assembly for details  
 Se separata delmontering för detaljer

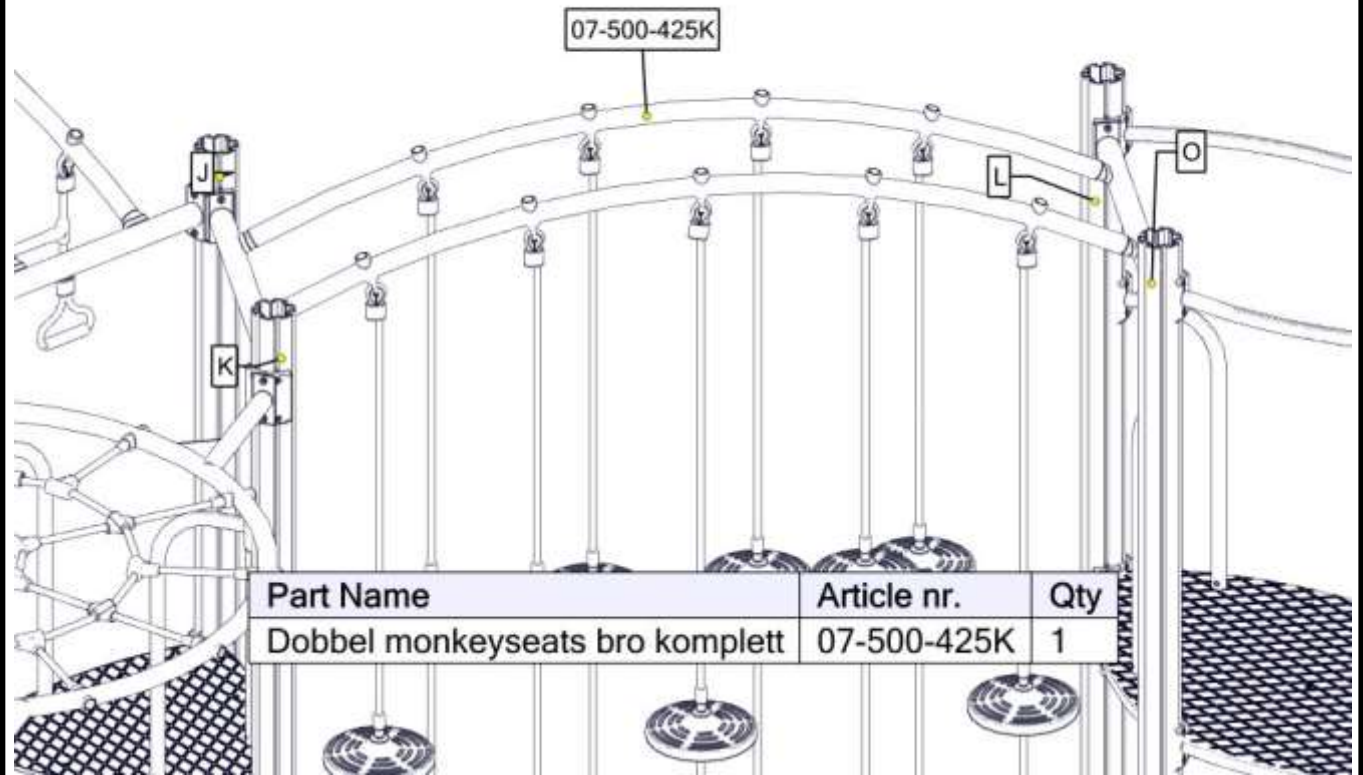

Part Name	Article nr.	Qty
Dobbel monkeyseats bro komplett	07-500-425K	1

Se separat delmontering for detaljer  
 See separate assembly for details  
 Se separata delmontering för detaljer

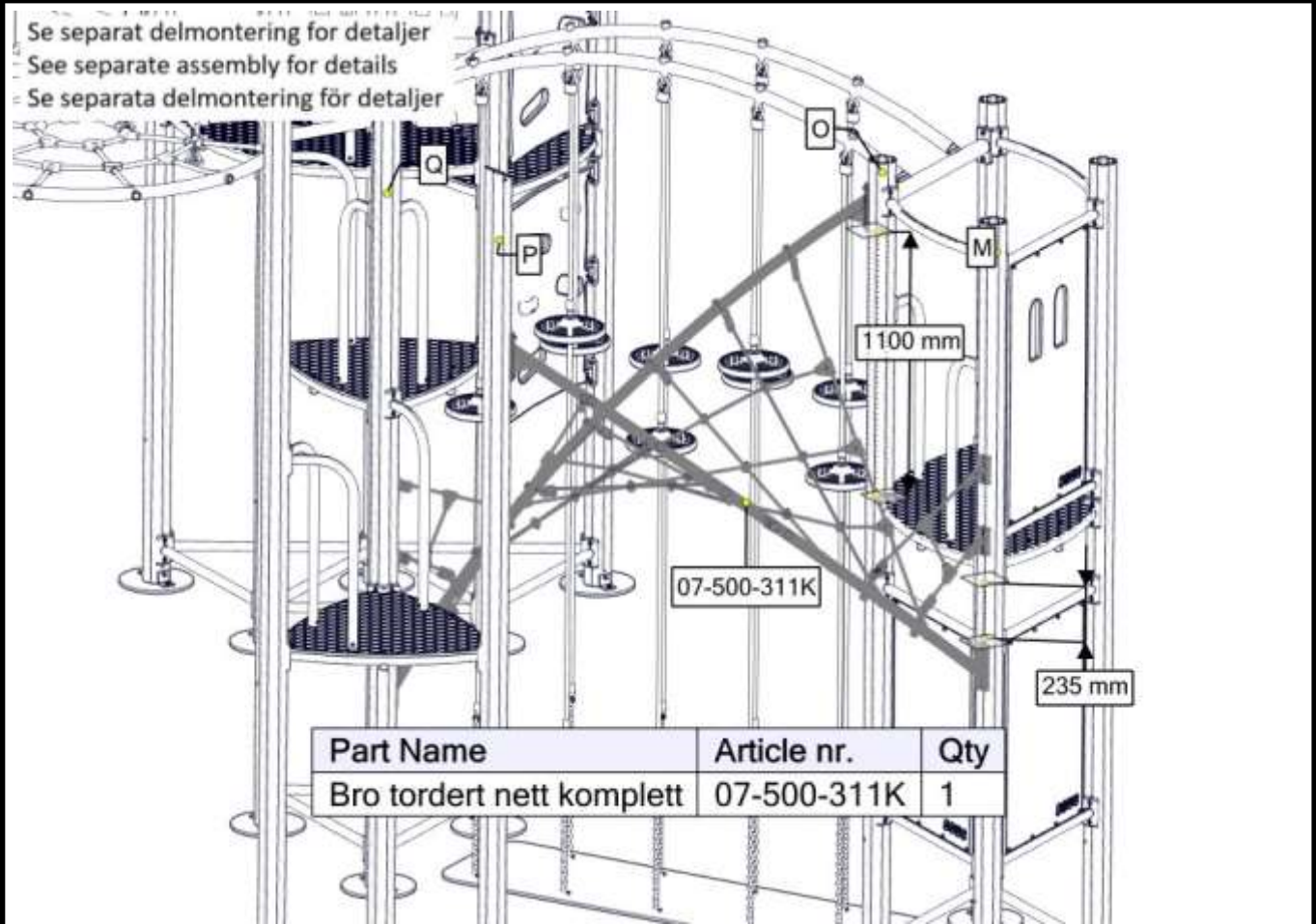

Part Name	Article nr.	Qty
Bro tordert nett komplett	07-500-311K	1

Se separat delmontering for detaljer  
 See separate assembly for details  
 Se separata delmontering för detaljer

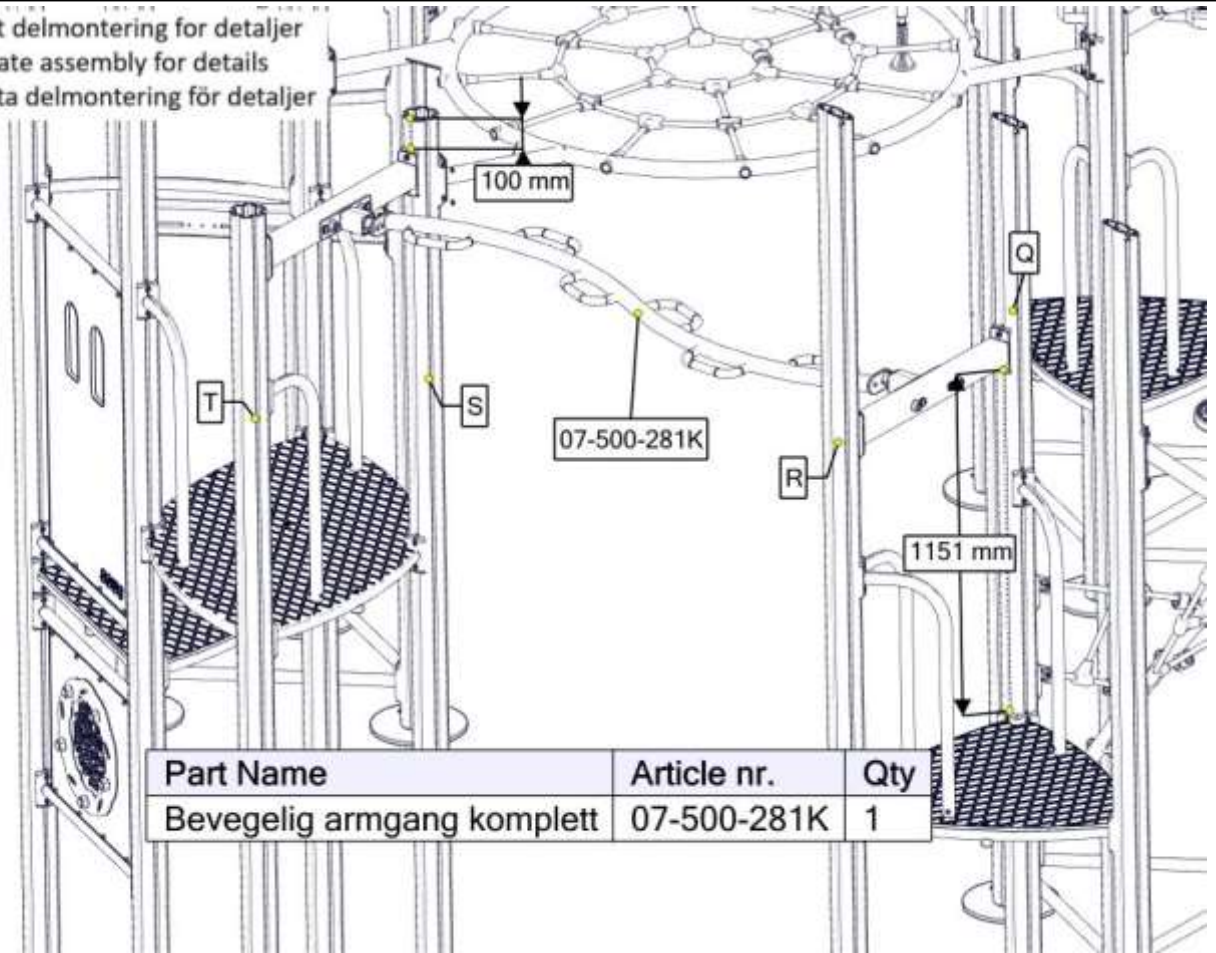

Part Name	Article nr.	Qty
Bevegelig armgang komplett	07-500-281K	1

Se separat delmontering for detaljer  
 See separate assembly for details  
 Se separata delmontering för detaljer

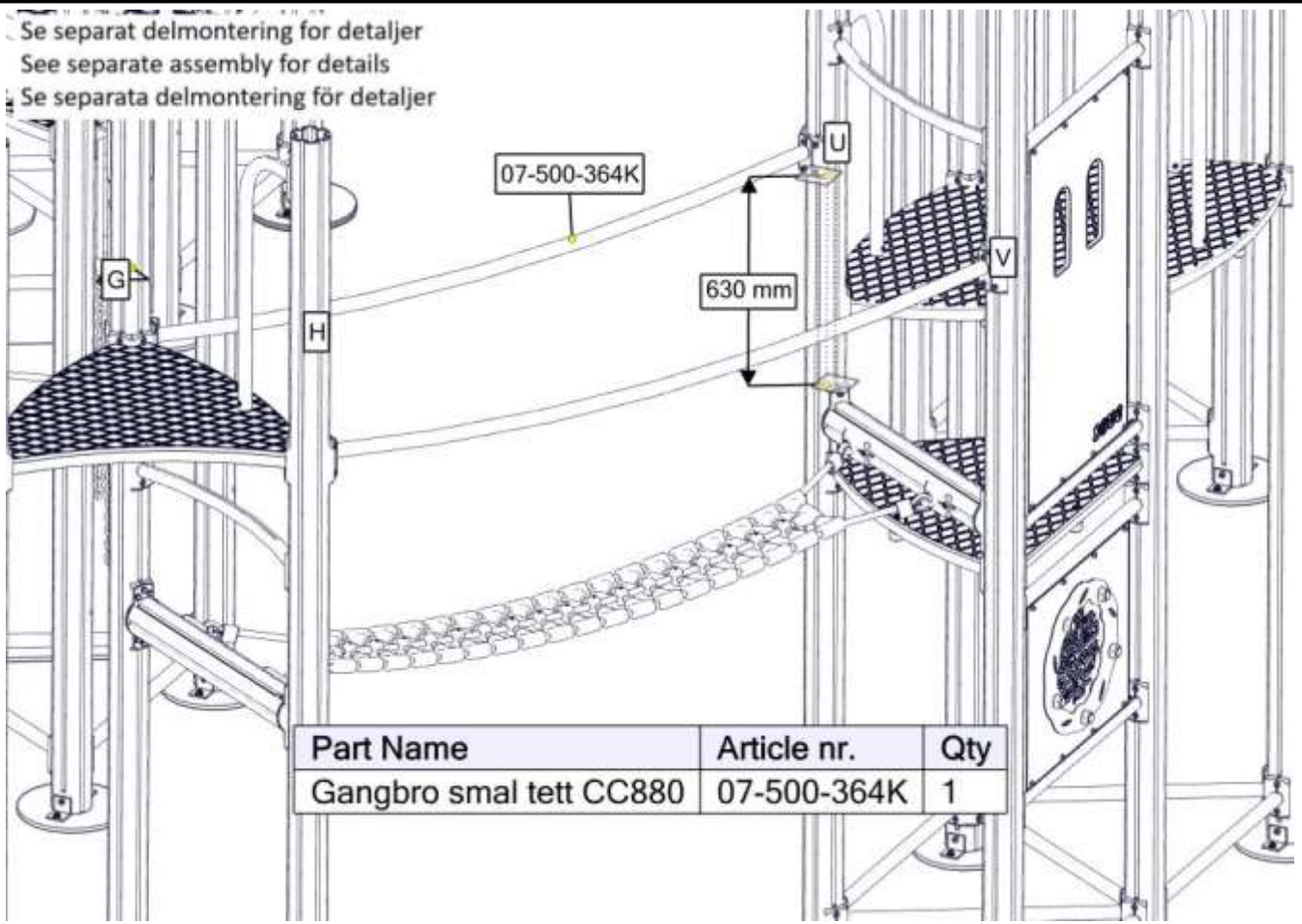

Part Name	Article nr.	Qty
Gangbro smal tett CC880	07-500-364K	1



Se separat delmontering for detaljer  
 See separate assembly for details  
 Se separata delmontering för detaljer

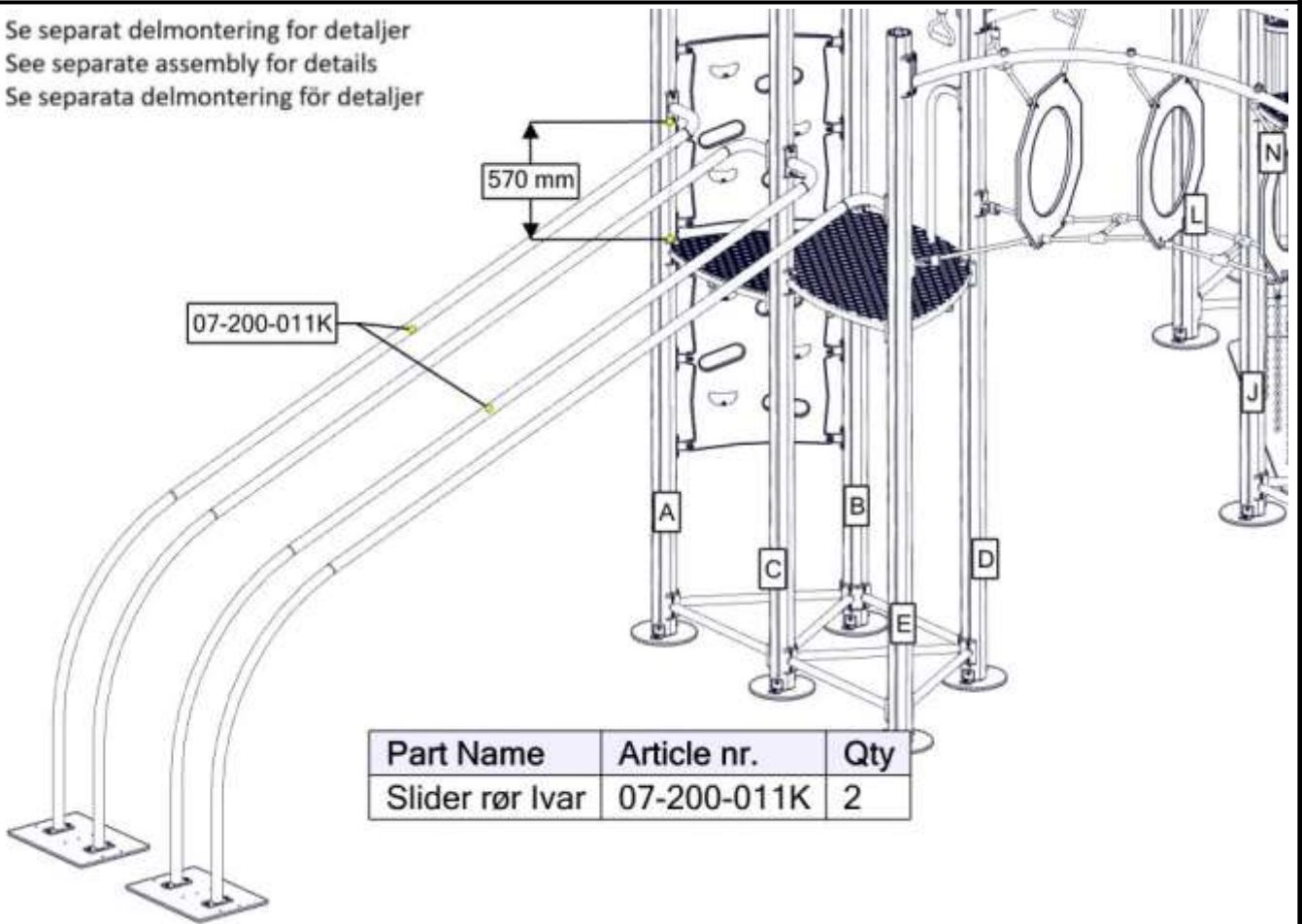

Part Name	Article nr.	Qty
Slider rør Ivar	07-200-011K	2

Se separat delmontering for detaljer  
 See separate assembly for details  
 Se separata delmontering för detaljer

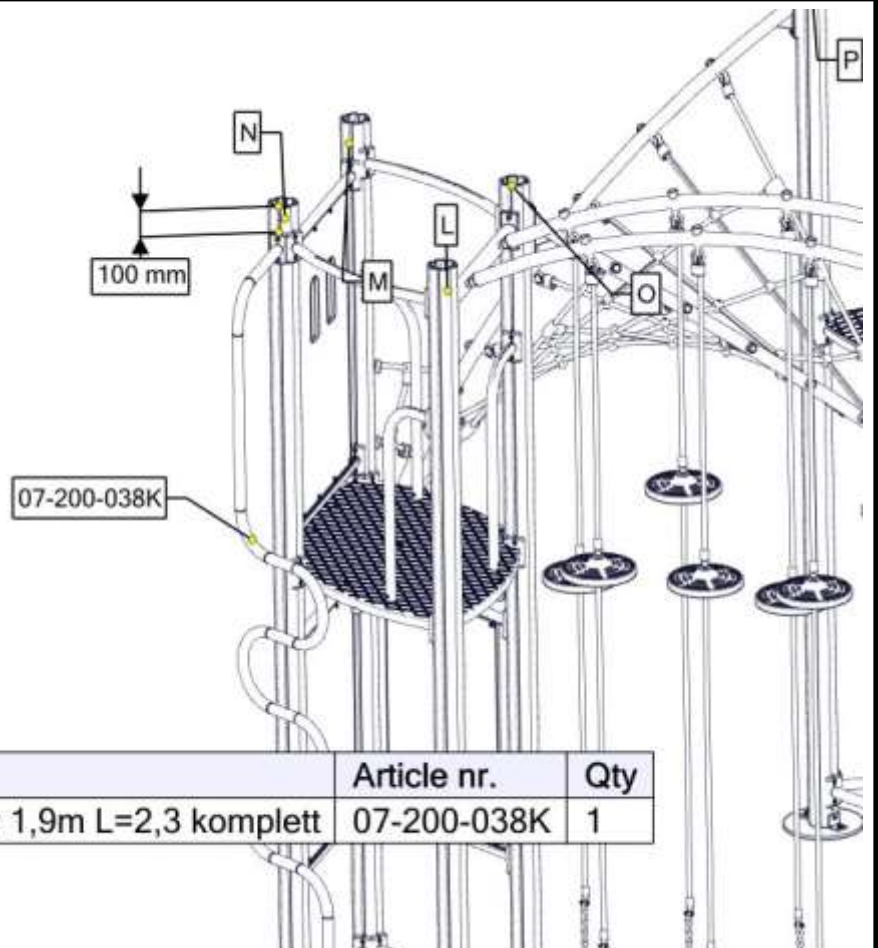

Part Name	Article nr.	Qty
Klatrestang gulv 1,9m L=2,3 komplett	07-200-038K	1

Se separat delmontering for detaljer  
 See separate assembly for details  
 Se separata delmontering för detaljer

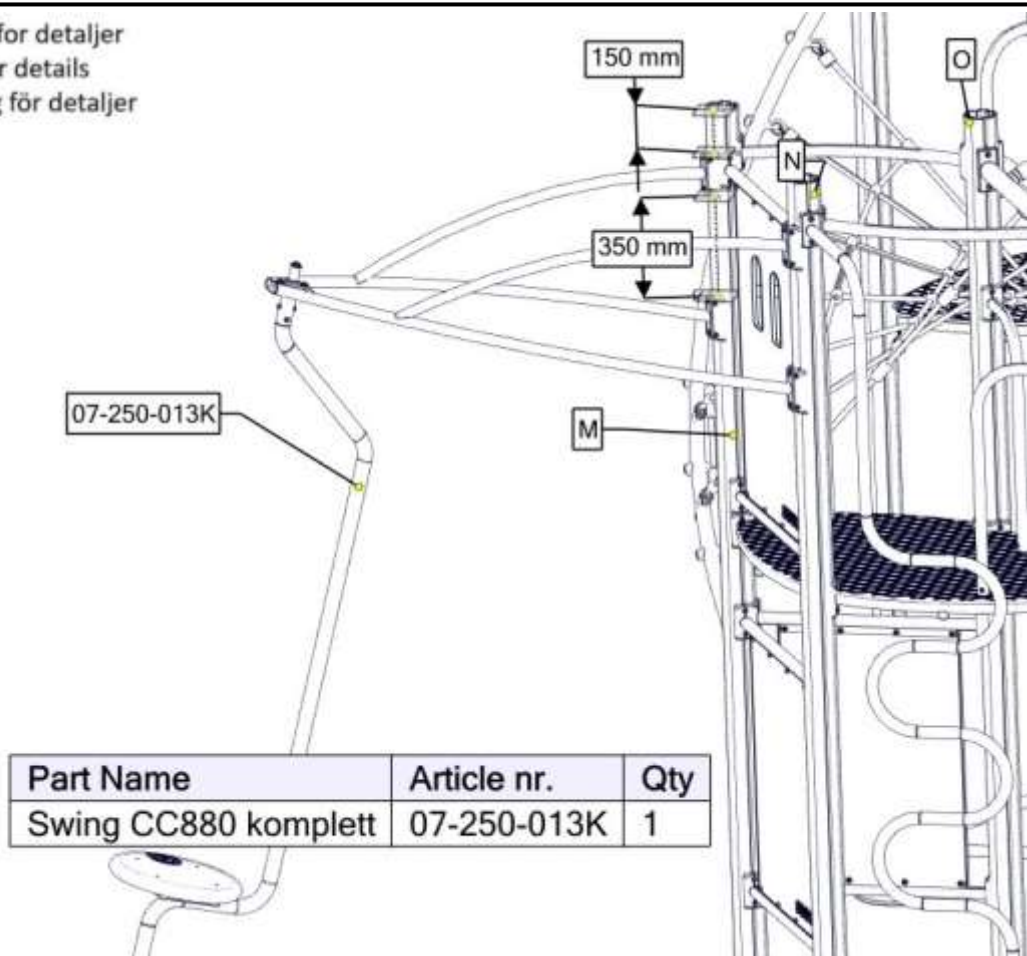

Se separat delmontering for detaljer  
 See separate assembly for details  
 Se separata delmontering för detaljer

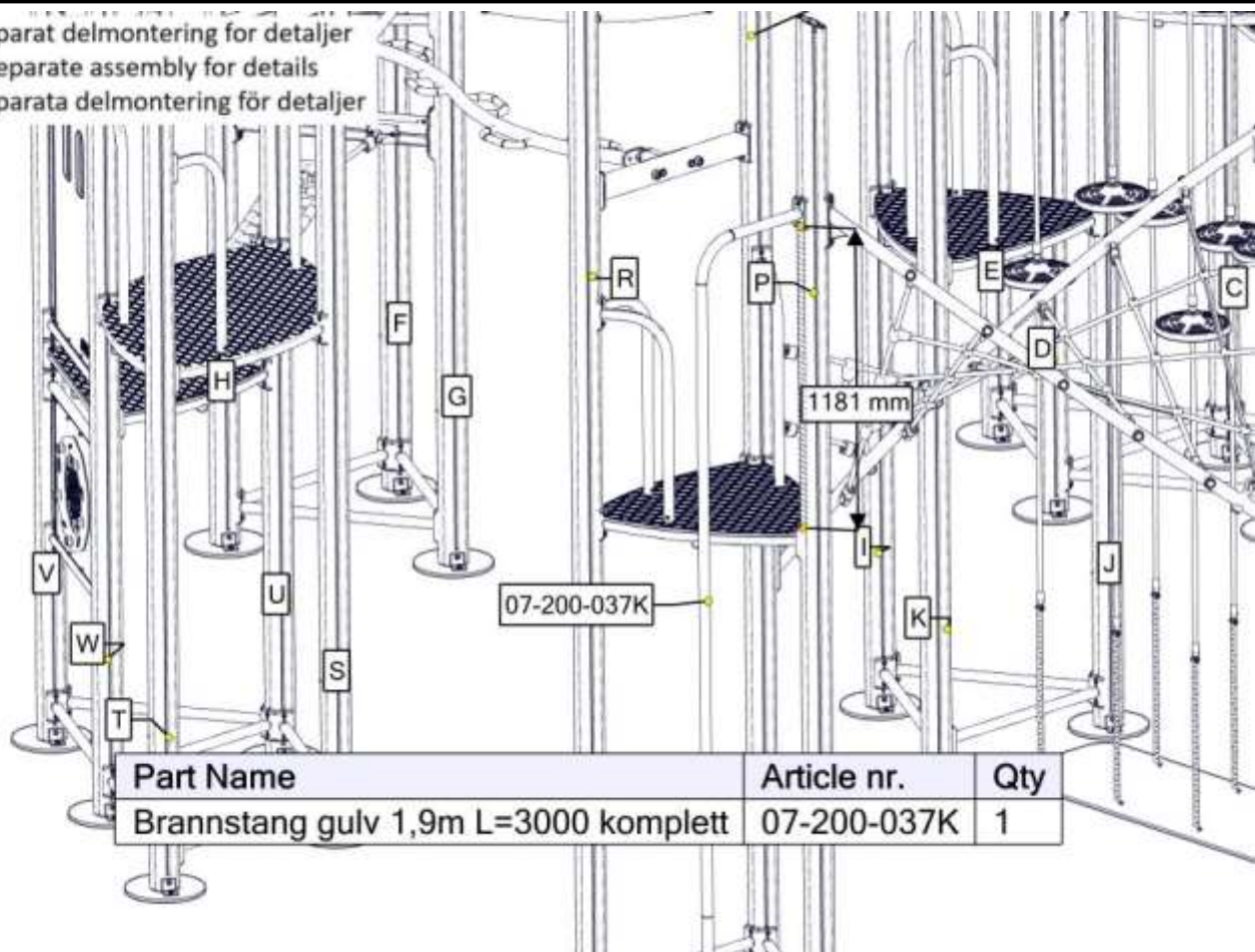



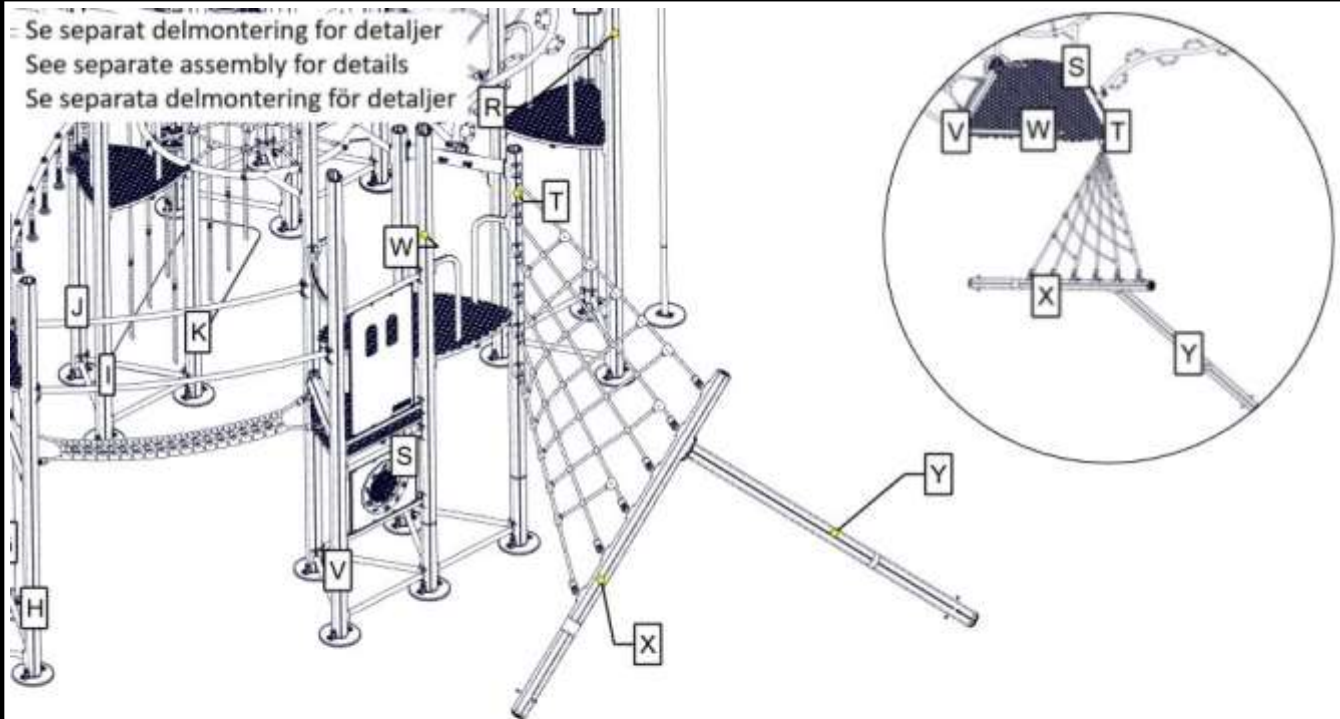

Part Name	Article nr.	Qty
Twistnett inkl besla og stolper	07-500-440K	1

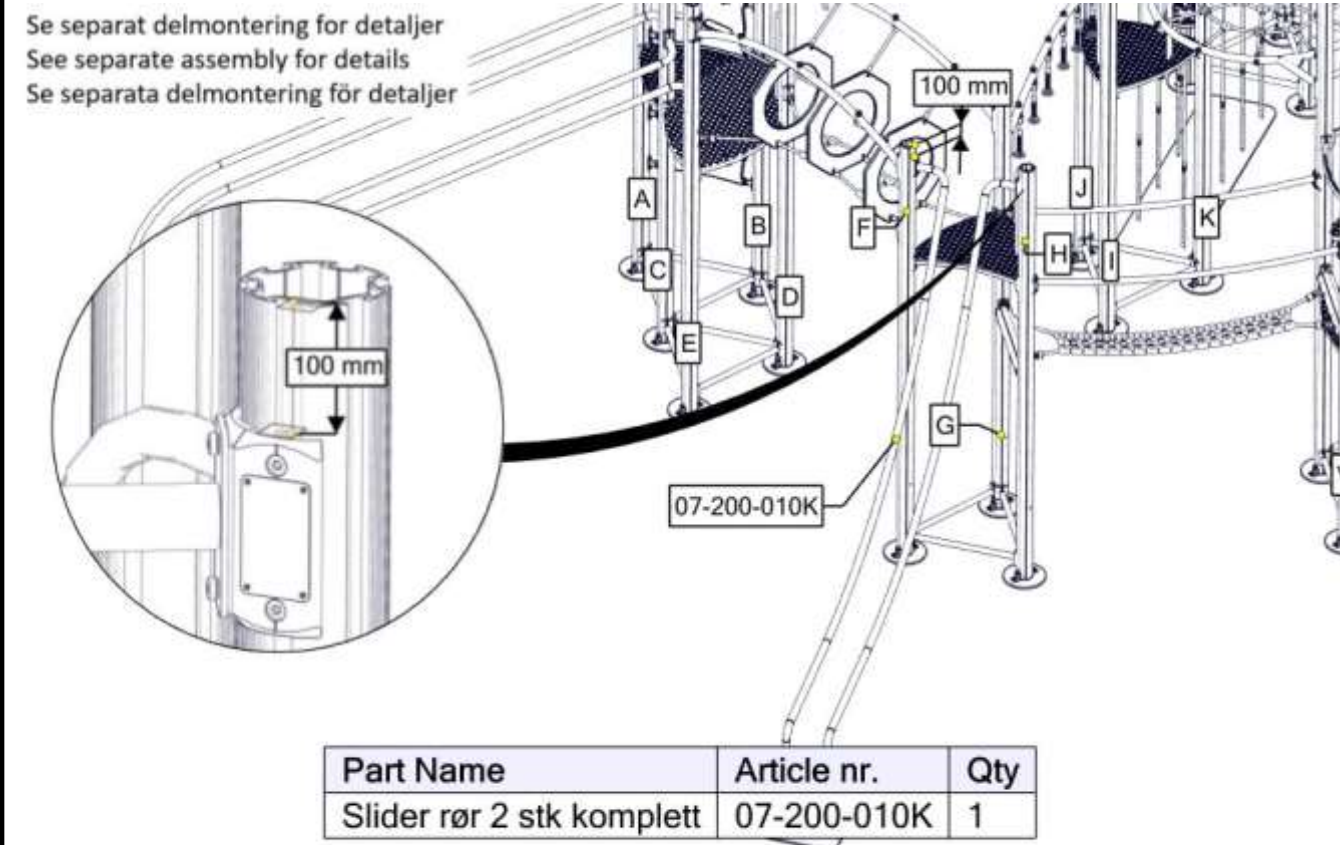

Part Name	Article nr.	Qty
Slider rør 2 stk komplett	07-200-010K	1

Se separat delmontering for detaljer  
 See separate assembly for details  
 Se separata delmontering för detaljer

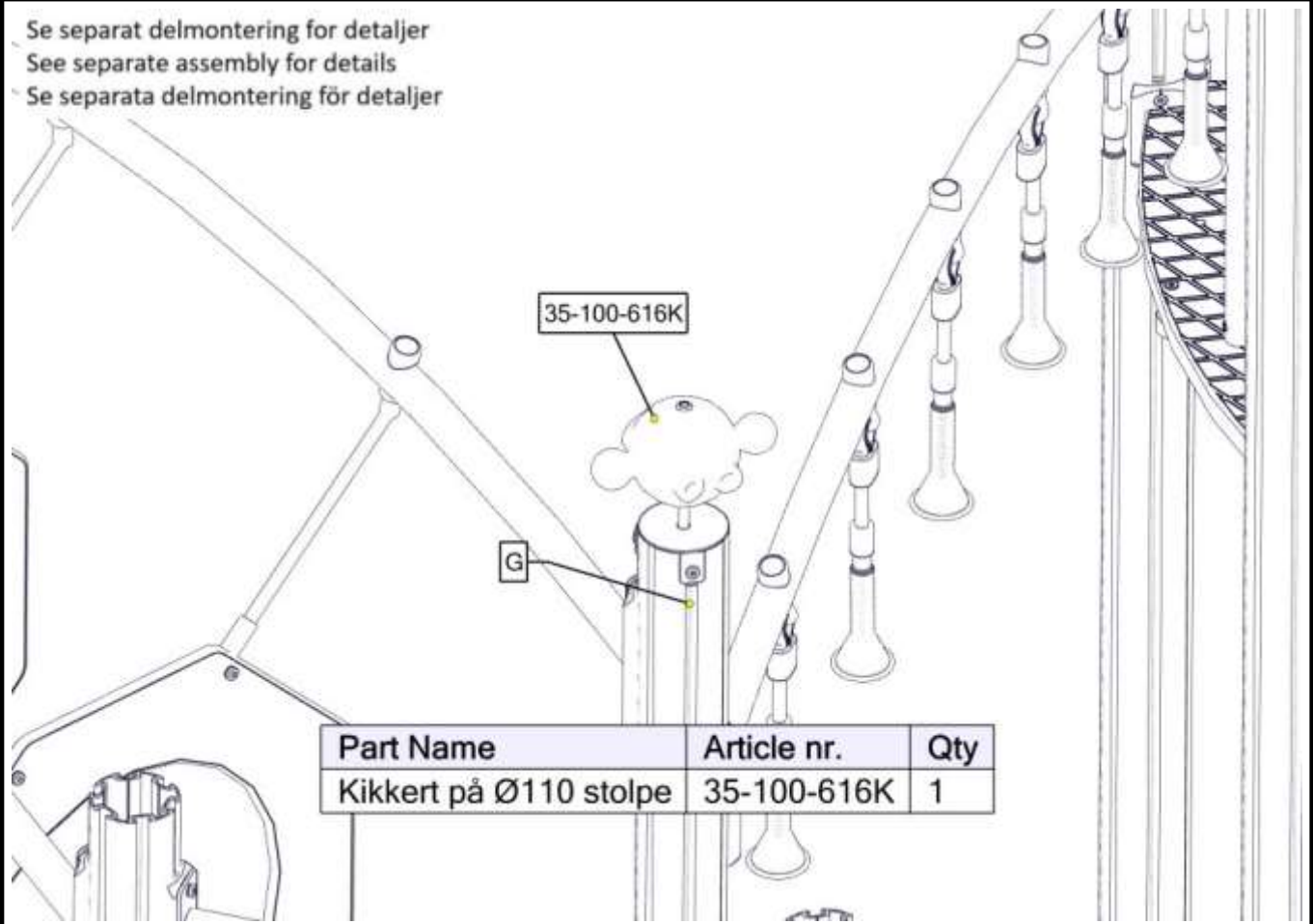

Se separat delmontering for detaljer  
 See separate assembly for details  
 Se separata delmontering för detaljer

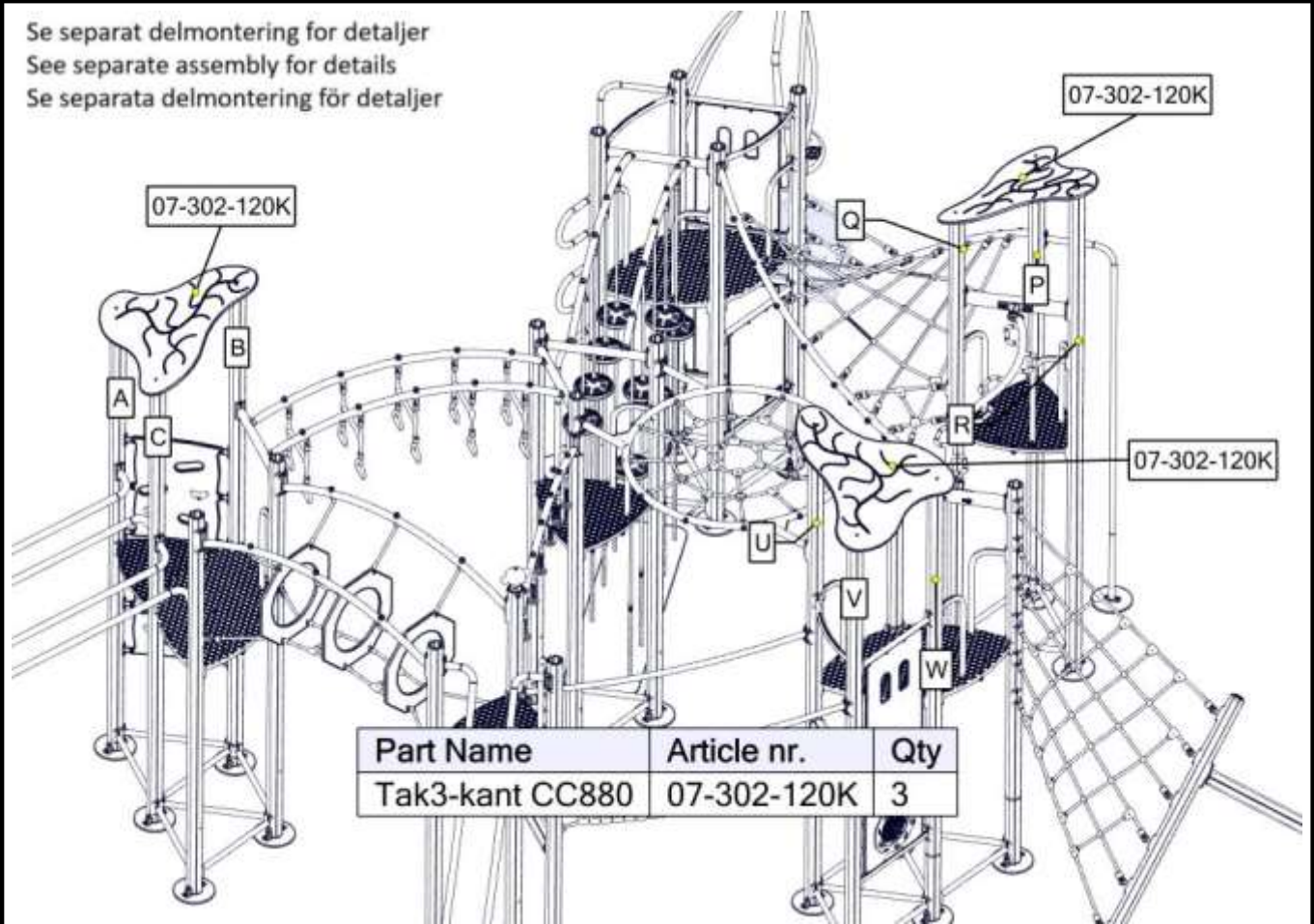



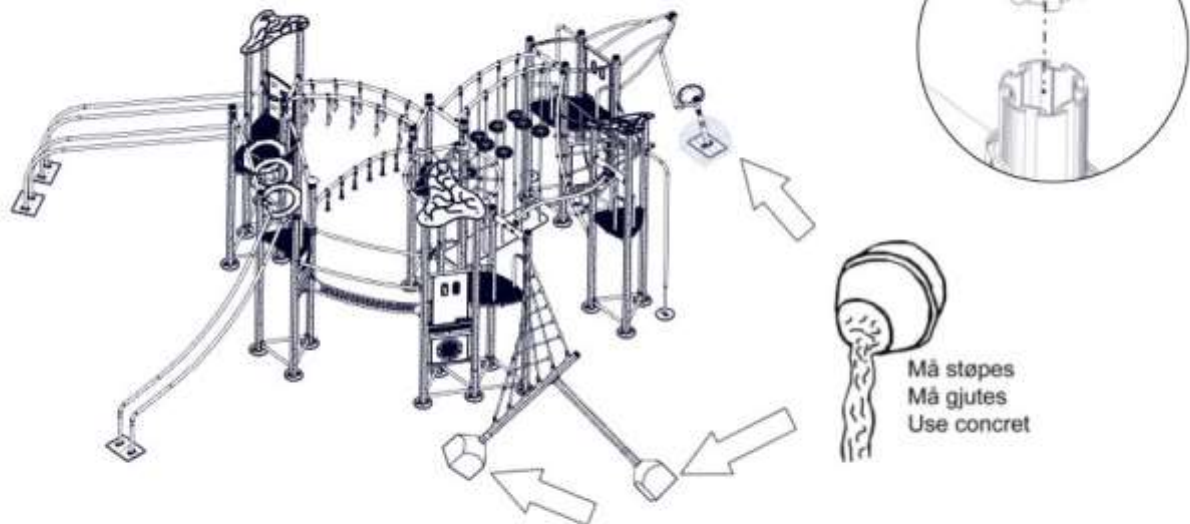



Se separat delmontering for detaljer  
See separate assembly for details  
Se separata delmontering för detaljer



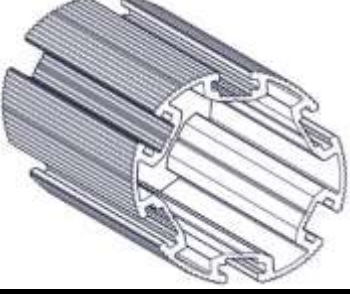



Part Name	Article nr.	Qty
Endelokk 110	00-400-995	13





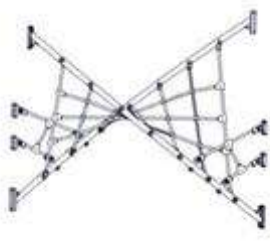





<b>Før utstyret tas i bruk / Before play begins / Innan lekredskapet tas i bruk</b>	
<b>N</b>	<ul style="list-style-type: none"> <li>● Påse at fallunderlag er utlagt i henhold til gjeldende regler eller vår anbefaling</li> <li>● Fjern alle monteringshjelpemidler ( rester av betong, planker, paller, plast, og lignende)</li> <li>● Før utstyret tas i bruk, burde man sjekke at det ikke er fare for at anorakksnorer og lignende som kan hekte seg fast noen steder på lekeapparatet. (Vedlagte snor med dobbe (kneledd) kan brukes til å sjekke at dette er i orden. Se vedlagte veiledning for bruk av denne. Dette gjøres for å oppdage eventuelle feilmonteringer.?)</li> <li>● NB! Bør stå i 2-3 dager før bruk</li> </ul>
<b>EN</b>	<ul style="list-style-type: none"> <li>● Make sure the area and depth of safer surfacing are according to the current standard, or to the manufacturer's recommendation</li> <li>● Make sure all tools and surplus materials are removed before play begins</li> <li>● PS! When complete, allow 2-3 days for the concrete to set before use</li> </ul>
<b>S</b>	<ul style="list-style-type: none"> <li>● Kontrollera att fallunderlag är utlagt enligt gällande regler eller vårt rekommendation</li> <li>● Ta bort alla monteringshjälpmedel (rester av betong, plankor, pallar, plast och liknande)</li> <li>● Innan lekredskapet används, kontrollera att anoracksnoddar eller kläder/delar av kläder eller liknande inte kan fastna i några delar på redskapet. (Den bipackade "knävringen" kan man med fördel användas för denna kontroll.</li> <li>● Detta görs för att upptäcka eventuella felmonteringar.)</li> </ul>



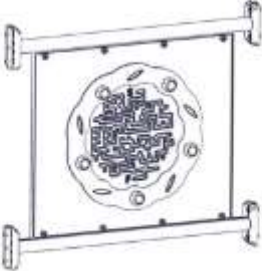

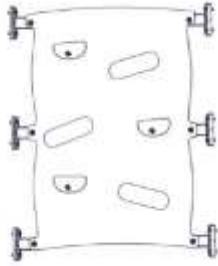
<b>Boltepakker for / Boltpackage for / Bultpaket för</b>		Sign. _____		
<b>Prekestolen 30-801-070</b>	<b>Navn</b>	<b>Artnr/ dimensjon</b>	<b>Ant</b>	<b>Lev</b>
	Stolpe Ø110 L=3450 Grå	SFA5126/2	14	
	Stolpe Ø110 L= 4050 Grå Skrå	07-100-352	6	
	Stolpe Ø110 L=4405 Grå Skrå	07-100-353	3	
	Gulv 3-kant CC880 Standard Grå	07-300-104K (se egen delmontering)	3	
	Gulv 3-kant CC880 1 Konkav Grå	07-300-105K (se egen delmontering)	1	
	Gulv 3-kant CC880 1 Rett Grå	07-300-106K (se egen delmontering)	1	
	Gulv 3-kant CC880 Dobbel Grå	07-301-102K (se egen delmontering)	3	
	Bevegelig Armgang CC880 Grønn	07-500-281K (se egen delmontering)	1	

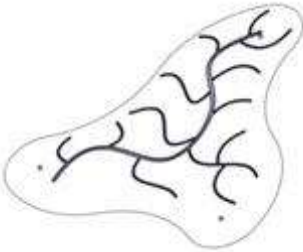



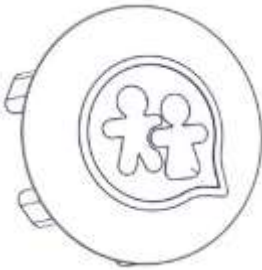

<b>Boltepakker for / Boltpackage for / Bultpaket för</b>		Sign. _____.		
<b>Prekestolen 30-801-070</b>	<b>Navn</b>	<b>Artnr/ dimensjon</b>	<b>Ant</b>	<b>Lev</b>
	Sluse H=790 Grønn	07-500-074K (se egen delmontering)	13	
	Bro tordert nett CC880 Grønn	07-500-311K (se egen delmontering)	1	
	Dobbel monkeyseat CC880 Grønn	07-500-425K (se egen delmontering)	1	
	Twistnett Grønn	07-500-440K (se egen delmontering)	1	
	HPL Bro CC880 Grønn	07-500-436K (se egen delmontering)	1	
	Bro med ringer CC880 Grønn	07-500-293K (se egen delmontering)	1	

<b>Boltepakker for / Boltpackage for / Bultpaket för</b>		Sign. _____		
<b>Prekestolen 30-801-070</b>	<b>Navn</b>	<b>Artnr/ dimensjon</b>	<b>Ant</b>	<b>Lev</b>
	Slider CC880	07-200-010K (se egen delmontering)	1	
	Brannstang Grå	07-200-037K (se egen delmontering)	1	
	Klatrestang Grå	07-200-038K (se egen delmontering)	1	
	Sperrerør bøyd CC880 Uten hull Grønn	07-500-072K (se egen delmontering)	4	
	Kikkert Beslag til Ø110 stolpe Rød	35-100-616K (se egen delmontering)	1	
	Labyrint / Maze CC880 Grønn plate	07-511-021K (se egen delmontering)	1	

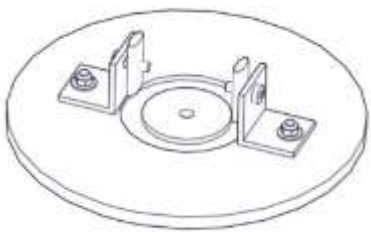
<b>Boltepakker for / Boltpackage for / Bultpaket för</b>		Sign. _____.		
<b>Prekestolen 30-801-070</b>	<b>Navn</b>	<b>Artnr/ dimensjon</b>	<b>Ant</b>	<b>Lev</b>
	Klatreplate CC880 Grønn	07-500-476K (se egen delmontering)	2	
	Slider CC880 Grå	07-200-011K (se egen delmontering)	2	
	Produktmerke Med beslag til Ø110 stolpe	07-500-500 (se egen delmontering)	1	
	Tak 3-kant CC880 Grå	07-302-120K (se egen delmontering)	3	
	Rekkverk med vindu 620 x 1100 CC880 Grønn	07-302-102K (se egen delmontering)	2	
	Rekkverk 620 x 900 CC880 Grønn	07-302-105K (se egen delmontering)	2	

<b>Boltepakker for / Boltpackage for / Bultpaket för</b>		Sign. _____.		
<b>Prekestolen 30-801-070</b>	<b>Navn</b>	<b>Artnr/ dimensjon</b>	<b>Ant</b>	<b>Lev</b>
	Gangbro smal tett CC880 Grønn	07-500-364K (se egen delmontering)	1	
	Armgang med håndtak 30gr beslag Grønn	07-500-454K (se egen delmontering)	1	
	Stolpelokk Ø110	00-400-995	13	
	Swing CC880 Grønn	07-250-013K (se egen delmontering)	1	
	Bro rundgang CC880 Grønn	07-200-261K (se egen delmontering)	1	

<b>Boltepakker for / Boltpackage for / Bultpaket för</b>		Sign. _____		
<b>Prekestolen 30-801-070</b>	<b>Navn</b>	<b>Artnr/ dimensjon</b>	<b>Ant</b>	<b>Lev</b>
	<b>Fundament nedgraving</b>			
	Fundamentplate 1 x Ø110 stolpe	07-400-101K (se egen delmontering)	23	
	Sperrerør rett L=750mm Uten hull Sort	07-500-075K (Se egen delmontering)	28	
	<b>Fundament Støp</b>			
	Støpefundament Stolpe Ø110	00-003-111K (Se egen delmontering)	23	
	Sperrerør rett L=750mm Uten hull Sort	07-500-075K (Se egen delmontering)	28	



24-11-2021 SV  
Endret sikkerhetszone pga slider